

BOULEVARD 1 PANELS**Features:**

- Desk height power and data management
- Patented "Knuckle-Loc", rigid connection, prevents light and sound transmission
- Built-in acoustical/tackable properties
- Sectional multi-accent design options
- Fabric surfaces are able to be replaced on-site
- Frame incorporates 1" centred slots for component adjustability
- Requires no additional top caps, end caps, trim caps, hinges, kick plates or clips
- Simple to specify
- Reduced installation time
- Easy to reconfigure
- High-tech look/stackable grid appearance
- Rigid, no sway, straight panel sight line
- Self levelers reduce assembly time, ensure even height
- Over panels extend to 10 feet to enclose an office in fabric and glazed options
- Patented Raceway cover easily removed
- Raceway panels top and bottom portion semi tackable

Construction:

- Rigid extruded aluminum, finished frame, self-leveling 2 5/8" thick panel
- 1 1/8" sound absorbent Mineral Wool each side of hardboard septum Sizes:
- 8 Heights: 29", 37", 42", 50", 54", 58", 66" 74" and 82"
- 9 Widths: 6", 18" to 60" in 6" increments, 72" wide in selected panel configurations.

Adjustability:

- 3" glide stem permits 2 1/2" height adjustment
- Slotted at 1" increments
- Over panels, 8", 16", 24", 37" and 42" for enclosed offices (Non-slotted) Acoustic Rating
- .80NRC/26STC

Door:

- 2 door panel widths, glazed/unglazed, lockable, reversible
- 2 sliding door widths, non-lockable

Flexibility:

- Universal connector

Panel Finishes:

- 2 grades of fabric, air flow grill, glaze, tempered glass, laminate & COM

Electrical:

- Desk height 8 wire/4 circuit - 1 dedicated

Communication:

- Desk height data channel
- Raceway cover easily removed
- Fabric covered raceways available

SYSTEM 3 PANELS**Features:**

- Base power and data lay-in
- Desk height power and data feed thru
- Top data lay-in
- Patented "Knuckle-Loc", rigid connection, prevents light and sound transmission
- Removable multi-functional tile design options
- Fabric surfaces are able to be replaced on-site
- Reduced installation time
- Easy to reconfigure
- High-tech look/stackable grid appearance
- Rigid, no sway, straight panel sight line
- Self levelers reduce assembly time, ensure even height
- Over panels extend height to enclose an office in fabric, glazed or laminate options
- Raceway cover easily removed

Construction:

- Rigid extruded aluminum

Sizes:

- 5 Heights: 34", 42", 50", 54", 66"
- 8 Widths: 18" to 60"

Adjustability:

- 3" glide stem permits 2 1/2" height adjustment
- Slotted at 1" centres
- Over panels, 8" and 16" (Non-slotted)

Door:

- 2 widths, glazed/solid, lockable, reversible
- 2 sliding door widths, non-lockable

Flexibility:

- Universal connector

Panel Finishes:

- Fabric, air flow accessory, tempered glass, laminate, whiteboard, corkboard (at base only)

ELECTRICAL FOR BOULEVARD 1 PANELS**Features:**

- Customized power capabilities in each panel
- State-of-the-art snap-in electrical
- 8 wire with 3 regular 15 AMP circuits and 1 isolated 15 AMP circuit.
- 3N and 8K electrical available upon request.
- Snap-in installation - harnesses, junction boxes, duplexes
- Accessibility makes changing circuits easy
- Flexibility in choice of duplexes within panel: choice of circuits for each duplex; choice of quantity of duplexes (1 or 2 duplexes per panel)

- Electrical cords are concealed
- Separate large channel for data
- Change electrical without moving pedestals
- Lower installation/reconfiguration costs
- Data terminals snap into cable holder
- Floor or ceiling feed
- Duplexes accessible from both sides

ELECTRICAL FOR SYSTEM 3 PANELS**Features:**

- Customized power capabilities in each panel
- State-of-the-art snap-in duplex receptacles
- 8 wire with 3 regular 15 AMP circuits and 1 isolated 15 AMP circuit
- Snap-in installation - harnesses, junction boxes, duplexes

- Accessibility makes changing circuits easy
- Flexibility in choice of duplexes within panel
- Data terminals snap into base raceway cover and mid panel electrical tile
- Floor or ceiling feed
- Duplexes accessible from both sides

WORKSURFACES / HARDWARE**Features:**

- One universal cantilever support
- Pedestal eliminates need for end panel/cantilever
- Grommets are not needed
- Continuous cable accessibility across back
- Adjustable to any height, in 1" increments
- Flush abutment side edge minimize seam crevice
- Metal-to-metal connections (Metal Inserts)
- Additional cable manager under worksurface

Construction:

- Medium-density particle board 1 1/16" thick

Sizes:

- 3 Depths: 18", 24" and 30"
- 12 Widths: 18" to 84" in 6" increments

Finishes:

- Tops: High Pressure Laminate, Low Pressure Laminate or Wood
- Edges: Edge banded PVC or Wood

Types:

- Transaction, keyboard, rectangular worksurface, corner, curved, D-top, P-top, Arc-top and freestanding

OVERHEAD STORAGE**Features:**

- Steel and all laminate based options
- Panel mount and up-mount options
- Completely enclosed unit for 16" overheads
- Style dependent- ship fully assembled or knocked down
- 13.5" inside height for oversized binders
- Metal-to-metal connection
- Lock secures into bottom shelf
- Doors operate smoothly
- Flipper door retrofittable on site
- Safety bracket used for extra support
- Reinforcement built in for larger unit
- Can be removed and reconfigured without disassembly

Fronts:

- Open or closed fronts
- AODA compliant options available

Sizes:

- Overheads - 7 widths in 6" increments
- Shelves - 7 widths in 6" increments
- 13.5" deep welded overheads
- 14.2" deep AODA overheads
- 16.5" deep welded overheads for EDP, ring binder, letter/legal

Paint:

- Dry epoxy powder coating

PEDESTALS**Features:**

- Premium quality steel reinforced welded construction
- Double wall construction on all drawer fronts
- Fully progressive suspension system
- Centre pull
- Worksurface supporting option
- Full extension roller bearing glides on all file drawers
- Rubber bumpers for quietness
- Movable drawer divider in box drawers
 - Pencil Tray
 - Each file drawer includes a hanging file bar (22" and 28" depth only)
- 3 depths with varying filing capacity
- Random or specific keying instructions available

Construction:

- Double wall drawer fronts
- 18-20 gauge steel case components

Sizes:

- (Prime) 18", 22", 28" depth
- (9300) 19", 23", 29" depth

Types:

- Worksurface Supporting, Mobile, Freestanding

Paint:

- Dry epoxy powder coating

HOW BOULEVARD 1 CAN REDUCE YOUR COSTS**Finished Panel:**

- No inventory costs for connectors, trim caps, top caps, kick plates and clips.
- Less time required to install, or to disassemble, move and re-install.

Fewer Parts:

- Only 1 universal cantilever and 3 brackets are needed to build most workstations.
- Easy to attach and remove components from panels.
- Universal post for 2-way, 3-way and 4-way applications.

Desk Height Electric:

- Ease of initial electrical installation lowers energy management costs.
- Snap-in electrical components reduce reconfiguration costs.
- Can customize power in each panel, pay only for what is required.

Simplified Specifications:

- Fewer parts and components make specifying, ordering, and verifying less work.
- Product fits a 6" planning module.

Replaceable Panels:

- Panels can be re-upholstered on site.
- Communications/Data Channel:
 - Desk height data channel reduces time to install and change cables.

Floor to Ceiling Enclosed Office:

- Re-usable enclosed offices with doors eliminate future costs for drywall demolition, new construction, mess and extensive cash flow.
- Depreciation expense indirectly increases cash flow.

Warranty:

- Limited Lifetime Warranty on materials and workmanship.

Product:

- Priced less than most other "A" Grade panel systems.

HOW BOULEVARD SYSTEM 3 REDUCES YOUR COSTS**Finished Panel:**

- No inventory costs for connectors, top caps, kick plates and clips.
- Less time required to install, or to disassemble, move and re-install.

Fewer Parts:

- Only 1 universal cantilever and 3 brackets are needed to build most workstations.
- Easy to attach and remove components from panels.
- Universal post for 2-way, 3-way and 4-way applications.

Base Panel Electric System:

- Ease of initial electrical installation lowers energy management costs.
- Snap-in electrical components reduce reconfigurations costs.
- Can customize power in each panel, pay only for what is required.

Simplified Specifications:

- Fewer parts and components make specifying, ordering, and verifying less work.
- Product fits a 6" planning module.

Replaceable Panel Tiles:

- Over Panels and face tiles can be added and interchanged as needs change.
- Communications/Data Channel:
 - Base and top lay-in communications channel reduces time to install and change cables.

Warranty:

- Limited Lifetime Warranty on materials and workmanship.

Product:

- Priced less than most other "A" Grade panel systems.

Value-Added Benefits

On the following pages, we selected a grouping of Boulevard 1, System 3 configurations, some with electrical components and task lights, to give you a better understanding of our product's specifications as they relate to workstations. Our objective is to not only illustrate applications using panels and components, but also to have this serve as a pricing exercise.

All of the value-added benefits of the Boulevard 1 are standard as follows:

- Desk height power and data capabilities.
- Finished panel including top, corner and end caps.
- Sectional panel with multiple fabric options.
- Ease of installation and reconfigurations.
- Removable fabric for on-site refurbishing.
- Exceptional storage capacity in pedestals, overheads, lateral files, storage cabinets and towers.
- Simplified specifications.

All of the value-added benefits of the Boulevard System 3 are standard as follows:

- Base power and data capabilities.
- Finished panel including top and corner.
- Monolithic or Pass-Thru panels with multiple fabric options.

- Ease of installation and reconfiguration.
- Removable fabric tiles in Pass-Thru Panels for on-site refurbishing.
- Exceptional storage capacity in pedestals, overheads, lateral files, storage cabinets and towers.
- Simplified specifications.

All of the value-added benefits of the Diet System are standard as follows:

- Finished panel including top, corner and end caps.
- Sectional panels with multiple fabric options.
- Ease of installation and reconfigurations.
- Removable fabric for on-site refurbishing.
- Exceptional storage capacity in pedestals, overheads, lateral files, storage cabinets and towers.
- Simplified specifications.

When specifying Boulevard 1, Boulevard System 3 or Diet, you benefit from the ability to:

- Customize the energy management.
- Minimize the number of necessary parts.
- Offer a competitive list price.

NOTE: If Key Alike Instructions are not submitted to GLOBAL CONTRACT with the Customer's Purchase Order, all components will be keyed randomly.

WOOD GRAIN (WG) LAMINATE DIRECTION



* Panel general direction will default to vertical if monolithic panel is 54" high and if raceway panels are on same order.

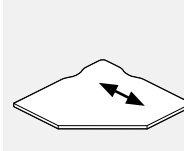
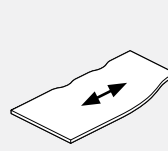
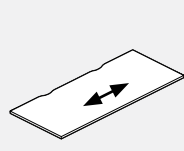
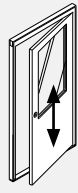

All Panels
With Exception of 66" or higher panels, the grain is vertical.

BPD
Doors.

BWS
Worksurfaces.

BWSC
Worksurfaces.

BWCF
Corner Worksurfaces.

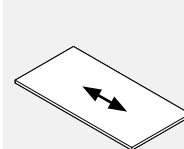
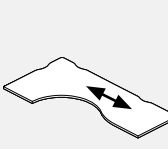
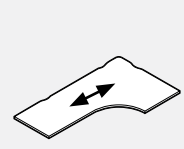
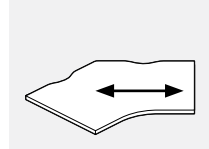
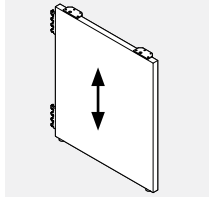
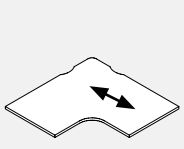

BWCL
Corner Worksurfaces.

BHFG
Full Gable.

BWAC Angled Corner
Worksurfaces

BWCE
Extended Worksurfaces.

BWCEC
Extended Worksurfaces.

BK
Desking Worksurfaces.

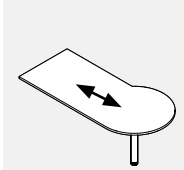
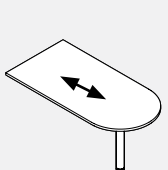
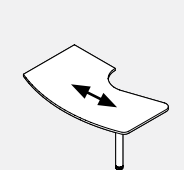
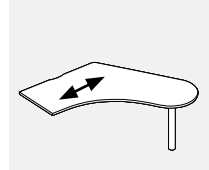
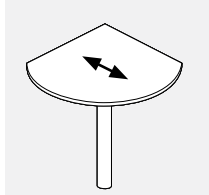
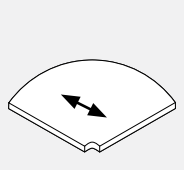

BWR
Radius Worksurfaces.

BWRTD
Teardrop Worksurfaces.

BWC
Extended "D"
Worksurfaces.

BWSL
Curvilinear Work-
surfaces.

BWD
Worksurfaces.

BWP
Worksurfaces.

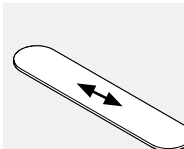
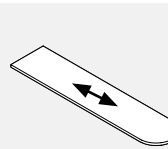
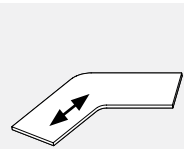
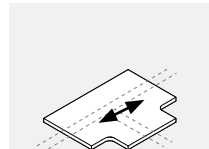
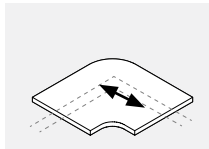
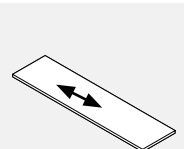

BWT
Transaction Worksurfaces.

BWTC
Corner Transaction
Worksurfaces.

BWTT
Transaction Work-
surfaces.

BWTAC
Transaction Worksur-
faces.

BWTD "D"
Transaction Worksurfaces.

BWTD "D"
Transaction Worksurfaces.

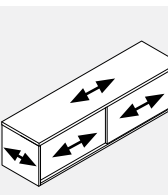
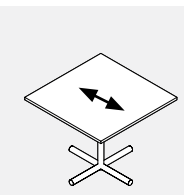
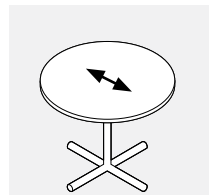
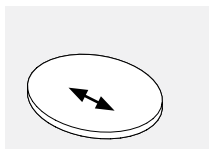
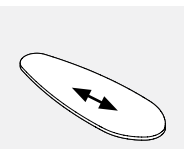

BWTE
Ellipse Transaction
Worksurfaces

BWTP
Round Transaction
Worksurfaces.

BWCD
Round Tables.

BWSQ
Square Tables.

BSP
Laminate Divider Storage

Boulevard 1 Panel System

The Boulevard philosophy is based on simplicity. A product that is simple to install... simple to reconfigure... and simple to specify, without sacrificing delivery time or quality.

Technically superb and exceptionally precise aluminum extrusion and die-cast fittings achieve exact levels of consistency, panel after panel; everything fits, aligns, and assembles, first time, every time. Most of all it requires very few of the "small parts" associated with most systems. This cross-market integration is celebrated in Boulevard.

Truly a system of broad application, whether installed in a high-tech environment, factory application or executive office, Boulevard will perform! We invite you to share with us a product designed, built and marketed for a global economy.

Our Mission

Our mission is to continue to develop and offer innovative, quality office furniture to value-oriented customers, through a dealer network that provides consistent, high quality service. Our approach in the contract furniture industry is to focus on customer concerns and needs to develop products that minimize your costs of ownership. It represents the culmination of creativity, industry expertise, specialists, and integrity to help you achieve

cost-effective solutions to problems. Our vision is to create a company-wide environment that supports constant improvement and promotes customer satisfaction. We believe that as good as we are today, we must be better tomorrow. Thus, our desire to improve is both continuous and tireless.

Environmental Commitment

At Global Contract, protecting the next generations' environment is of paramount concern. Global Contract believes that it is our responsibility to help protect the environment for future generations. We continue to operate with the environment in mind, making wise business decisions that help protect the earth and its precious natural resources. Our manufacturing procedure incorporates the latest technology for painting products, using a dry epoxy powder or gel paint. This process produces no toxic residue, and therefore is environmentally safe, while other manufacturers still use the wet paint process. Our packaging, veneer selections, and reduction in waste programs all contribute to a better environment. In addition, our concern for the reduction of finishing emissions and wood dust has resulted in a healthier work environment in many ways, including this price book, printed on recycled paper.

Technical Information

Panels

- All panels are 2 5/8" thick.
- Lightweight aluminum box frame construction creates superior panel rigidity.
- Panel frame finish is durable epoxy powder coated.
- Hang-on capabilities at 1" increments.
- Patented "Knuckle-Loc" design provides solid panel-to-panel connection for fast installation and reconfiguration.
- Knuckle lock feature ensures even panel heights throughout installation.
- 3" glide stem permits 2 1/2" height adjustment.
- Panel sizes are actual, eliminating creepage.
- Panels come complete, eliminating need for separate top, corner end trim and clips.
- Fabric is replaceable on site.
- All panels include 2 "Capture Strip" panel connectors.
- Fabric retainer is clear.
- Panels are UL listed and CSA approved and have a Class "A" fire rating except when Customer's Own Material (COM) is used.
- Centre septum above raceway overlaid on either side with tackable, 1 1/8" "Sound Absorbent Mineral Board".
- For glazing - Smoke developed index 500.
- For tempered glass, add "TG" to the end of the product code and add 20% to the price regardless of fabric grade.
- Solid metal sheet is an OPT option and price accordingly, however, the sheets are 48" wide and cannot be specified on 48" and wider unless they are railroaded. Contact your Customer Service Representative for more information.

Panel Options

- Laminate, whiteboard, or corkboard may be substituted for fabric on panels only, not raceways, see "OPT" column.
- Laminate and whiteboard are held in place with a PVC retainer matching the frame colour and can be retrofitted on site.
- Laminate and whiteboard options reduce the acoustical value of the panel.

Raceway Options

- Raceways are standard in PVC matching the panel frame finish.
- Fabric Covered Raceway (FRC) available. Aluminum raceway available.
- Wood veneer raceway available.
- Face mount electrical raceway available.
- Face mount openings are 1.5x2.85 for electrical and 1.37x2.755 for data.
- Cable capacity in raceways is 83 - 0.220" dia. cables (cat.6).

Desk Height Management

- Desk height electrical and communication raceway system.
- State-of-the-art engineering.
- Snap-in modularity of all electrical components including harnesses, junction boxes, duplexes and circuit designations.
- All power and data outlets are easily accessible from both sides of panel.
- 8 wire system with 4, 15 amp circuits (including 1 dedicated circuit).
- Optional facemount electrical with 2 duplexes per panel side.
- Outlet and circuit changes accomplished without disruption to workstation.
- Large raceway cavity permits storage of excess cables and equipment cords.
- Total flexibility for 8 wire system: choice of 1, 2 or 4 duplexes per panel; choice of circuitry in each duplex.
- Unique design of fire retardant PVC raceway cover permits access to raceway without disruption to equipment on worksurfaces.
- Clip-on communication management channel (BECC01 and BPH001) included with each raceway panel.
- Communication management channel accepts modular Data/Comm terminals (not supplied by Global Contract Inc.).

Posts

- Enables connection for multiple panel runs such as 90°, 45° or 60° angles and 2 way, 3 way or 4 way.
- Provides route for base, ceiling, and worksurface cable entry to a panel.
- Self levelling feature maintains even height of all connected panels.
- Solid lightweight aluminum extrusion fits together through a unique "Knuckle-Loc" design providing rigid post-to-panel connection.
- Includes all required panel connectors and caps.
- Posts add 2 5/8" to a panel run.
- Posts are 1/8" oversized to allow for "panel wrap around" of freestanding desks.
- For all panel runs with multiple posts, this 1/8" must be allotted for.

PANELS - GUIDELINES FOR ORDERING PRODUCT**Codes**

The product guide uses a numbering system with meaningful alphanumeric characters to create a simple-to-understand product number. This makes specifying the product much easier and more accurate.

Example of Panel: **BPRA6636 CHR CHR**

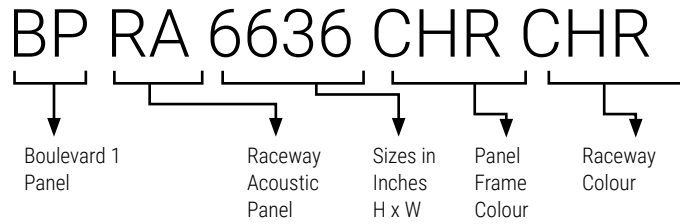

AN50

Inside Lower Fabric

AN50

Inside Upper Fabric

BE21

Outside Lower Fabric

BE21

Outside Upper Fabric

How to Specify

- Specify Boulevard 1 panel type and size by code.
- Specify panel frame finish - ie. CHR (Charcoal).
- Specify PVC raceway finish - ie. CHR (Charcoal). If PVC raceway colour not specified at time of order, default will be the panel frame colour.
- Specify all four panel fabric options if necessary.
- Some fabrics have directional pattern and cannot be applied horizontally or vertically. Panels wider than 60" will have fabrics applied horizontally (railroad). Please specify if you want adjacent panels and the rest of the installation upholstered the same way.

Example of Post: **BHP066 CHR**

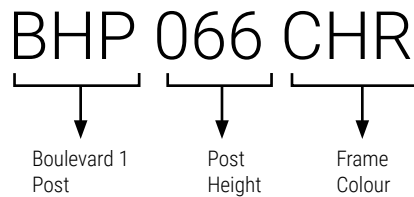
**How to Specify**

- Specify Boulevard 1 post by code.
- Specify frame colour - ie. CHR (Charcoal).

Raceways**PVC:**

- Standard, at time of order, includes 2 covers.
- Standard, when ordering individuals: RCSxxCOL.
- Facemount raceways: RCWxxD.

Fabric:

- Standard, at time of order: RCWxxFAB, panel mounted.
- Standard, when ordering individuals: 1006FRCxx, shipped separately.
- Facemount raceways: FCRxxD.

Aluminum:

- Standard, when ordering individuals: BARCxx,
- Facemount raceways: RCAxxD.

ORDERS

Each Order Must Include

- Purchase Order
- Layout showing where the image(s) appear in the run of panels.
- A completed Price Chart, showing the location of the image(s) on each appropriate panel.

Artwork must be submitted in accordance with the following artwork specifications.

NOTE: Final artwork specification approval must be given before order can be processed.

Transfer Devices

- E-mail up to 10MB to your Global Contract Customer Service Representative.
- Courier CD/DVD/USB stick to your Global Contract Customer Service Representative.

Artwork Specifications

- Non-Photographic artwork should be vector art, saved in Adobe Illustrator (.ai) or as an SVG or EPS (.eps)
- All bitmap or photographic artwork has to be at a minimum of 100 dpi at the full size of the panel to be printed.
- We accept Adobe CS5 files.
- Any linked files must be included or imbedded.
- Leave any PSD files unflattened
- All fonts must be converted to outlines.
- Do not convert to CMYK, leave all images as RGB if possible
- No Word, Powerpoint, Publisher or other Microsoft files can be used.
- Include a PDF or .jpg for reference when sending native Photoshop or Illustrator format files.

Colour Matching

- A Pantone colour reference must be supplied or we cannot accept responsibility for correct colour.
- When it is not possible to refer to Pantone colours, we will do our best to meet your requirements.

Image Clarity

- We will advise should the selected image not lend itself to the element size requested.

NOTE:

We reserve the right to put an order on hold when the files are found to be incomplete or when documents have been either incorrectly saved. Fonts not converted to curves or the

job appears not to be commercially acceptable.

Image Bleed:

To facilitate placement on the panel. Extension of the image past the finished visible area of the panel (bleed) is required

- Boulevard Panels need a 5" Bleed on all sides.

Example Of Image resolution:

The resolution required for a 36 wide x 24 high Boulevard panel at 100 dpi (minimum resolution)

The resolution required for a 36 wide x 24 high Boulevard panel at 300 dpi (higher quality)

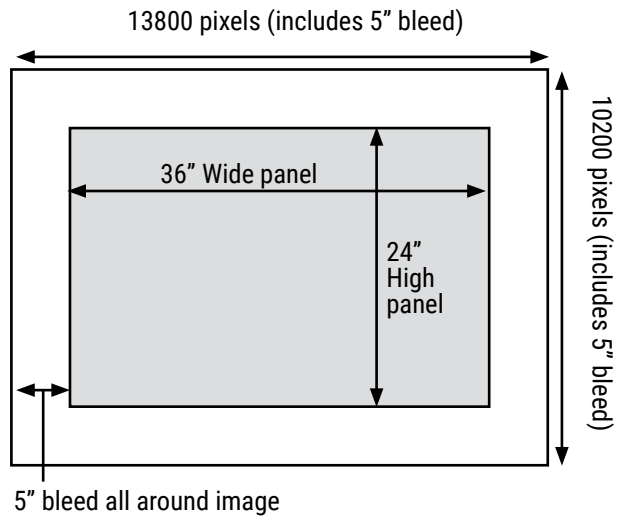
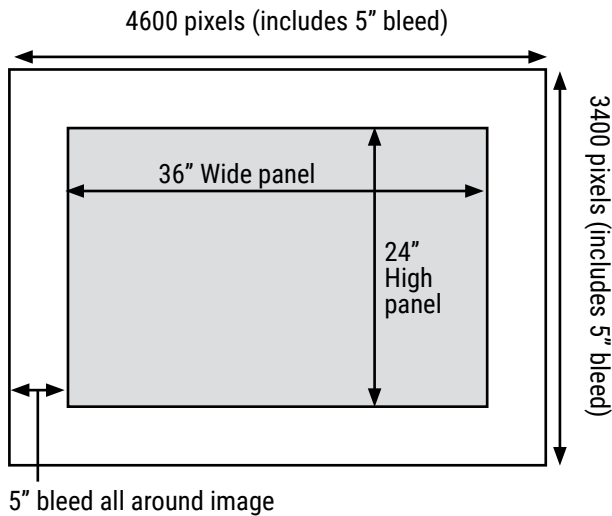

Pricing, Initial Set-Up Charge per Order:\$264 net

Boulevard 1 Panels • Below Raceway Only

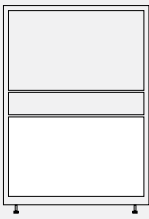

- This List applies to the following panels:
- BPRG
- BPRP
- BPAR

| PANEL HEIGHT | PANEL WIDTH | LIST PRICE |
|--------------|-------------|------------|
| 29" | 24" | 309 |
| 29" | 30" | 364 |
| 29" | 36" | 421 |
| 29" | 42" | 476 |
| 29" | 48" | 537 |
| 29" | 54" | 589 |
| 29" | 60" | 641 |
| 29" | 66" | 693 |
| 29" | 72" | 747 |

Boulevard 1 • Above Raceway Only

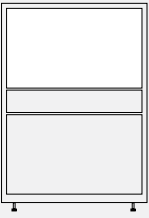

- This List applies to the following panels:
- BPRG
- BPRP

| PANEL WIDTH | HEIGHT | LIST PRICE | | | | | | |
|-------------|--------|------------|-----|-----|-----|-----|-----|-----|
| | | 42" | 50" | 54" | 58" | 66" | 74" | 82" |
| 24" | N/A | 183 | 217 | 248 | 317 | 384 | 446 | |
| 30" | N/A | 218 | 259 | 295 | 377 | 452 | 527 | |
| 36" | N/A | 259 | 299 | 340 | 431 | 520 | 610 | |
| 42" | N/A | 286 | 340 | 392 | 488 | 589 | 693 | |
| 48" | N/A | 324 | 382 | 438 | 550 | 661 | 791 | |
| 54" | N/A | 353 | 415 | 476 | 604 | 731 | 852 | |
| 60" | N/A | 384 | 452 | 520 | 661 | 800 | 935 | |
| 66" | N/A | 415 | | | | | | |
| 72" | N/A | 452 | | | | | | |

Boulevard Fabric Acoustic Panels

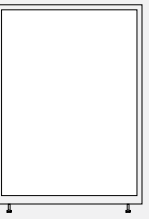

- This List applies to the following panels:
- BPF A

| PANEL WIDTH | HEIGHT | LIST PRICE | | | | | |
|-------------|--------|------------|------|------|------|------|------|
| | | 50" | 54" | 58" | 66" | 74" | 82" |
| 24" | 408 | 476 | 510 | 543 | 604 | 671 | 740 |
| 30" | 483 | 557 | 602 | 641 | 717 | 791 | 867 |
| 36" | 557 | 649 | 693 | 740 | 829 | 913 | 1001 |
| 42" | 633 | 731 | 784 | 837 | 935 | 1040 | 1139 |
| 48" | 711 | 823 | 880 | 935 | 1050 | 1160 | 1273 |
| 54" | 784 | 905 | 970 | 1033 | 1154 | 1283 | 1409 |
| 60" | 852 | 996 | 1063 | 1131 | 1266 | 1404 | 1539 |
| 66" | 920 | 1063 | | | | | |
| 72" | 996 | 1154 | | | | | |

Boulevard 1 Over Panels



- This List applies to the following Panels:
- BPOF

| PANEL WIDTH | HEIGHT | LIST PRICE | | | |
|-------------|--------|------------|-----|-----|------|
| | 8" | 16" | 24" | 37" | 42" |
| 24" | 144 | 211 | 271 | 377 | 421 |
| 30" | 171 | 248 | 324 | 446 | 499 |
| 36" | 197 | 286 | 370 | 513 | 574 |
| 42" | 227 | 324 | 421 | 589 | 649 |
| 48" | 248 | 364 | 469 | 649 | 723 |
| 54" | 279 | 408 | 520 | 723 | 800 |
| 60" | 303 | 446 | 567 | 942 | 874 |
| 66" | 324 | 476 | 610 | 852 | 942 |
| 72" | 353 | 513 | 656 | 920 | 1018 |

Note: Prices shown are an upcharge to the panel price, please add to the list price of panel which you are specifying the graphic for.

BPRA • Acoustical Raceway Panel

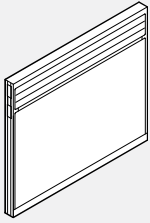

37" High

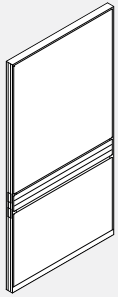

72" Wide

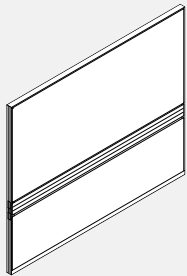

- Fabric above the raceway provides visual and acoustic privacy.
- Centre septum above and below raceway overlaid on either side with tackable, 1 1/8" "Sound absorbent mineral board".
- Centre septum below raceway overlaid on either side with 1 1/8" Mineral board.
- Acoustic rating of .80 NRC and 26 STC.
- OPT* = Laminate or Whiteboard.

| PRODUCT CODE | PRICE | | | SIZE / INCHES | | | WEIGHT VOL | |
|--------------|-------|------|------|---------------|----|------|------------|-----------------|
| | GR 1 | GR 2 | OPT* | H | W | D | LBS | FT ³ |
| BPRA3718 | 528 | 543 | 557 | 37 | 18 | 2.61 | 18 | 1.58 |
| BPRA3724 | 590 | 604 | 619 | 37 | 24 | 2.61 | 21 | 2.054 |
| BPRA3730 | 652 | 661 | 680 | 37 | 30 | 2.61 | 25 | 2.528 |
| BPRA3736 | 705 | 754 | 806 | 37 | 36 | 2.61 | 28 | 3.002 |
| BPRA3742 | 763 | 814 | 867 | 37 | 42 | 2.61 | 32 | 3.476 |
| BPRA3748 | 823 | 870 | 925 | 37 | 48 | 2.61 | 35 | 3.950 |
| BPRA3754 | 883 | 931 | 985 | 37 | 54 | 2.61 | 39 | 4.424 |
| BPRA3760 | 938 | 988 | 1041 | 37 | 60 | 2.61 | 44 | 4.898 |
| BPRA3766 | 999 | 1060 | 1123 | 37 | 66 | 2.61 | 50 | 5.499 |
| BPRA3772 | 1060 | 1118 | 1181 | 37 | 72 | 2.61 | 56 | 6.000 |
| BPRA4218 | 565 | 592 | 623 | 42 | 18 | 2.61 | 22 | 1.782 |
| BPRA4224 | 625 | 654 | 683 | 42 | 24 | 2.61 | 28 | 2.317 |
| BPRA4230 | 686 | 714 | 745 | 42 | 30 | 2.61 | 32 | 2.852 |
| BPRA4236 | 737 | 794 | 854 | 42 | 36 | 2.61 | 36 | 3.387 |
| BPRA4242 | 800 | 856 | 917 | 42 | 42 | 2.61 | 40 | 3.921 |
| BPRA4248 | 856 | 915 | 973 | 42 | 48 | 2.61 | 44 | 4.456 |
| BPRA4254 | 917 | 973 | 1034 | 42 | 54 | 2.61 | 48 | 4.991 |
| BPRA4260 | 973 | 1030 | 1091 | 42 | 60 | 2.61 | 52 | 5.525 |
| BPRA4266 | 1087 | 1204 | 1330 | 42 | 66 | 2.61 | 62 | 6.148 |
| BPRA4272 | 1197 | 1315 | 1441 | 42 | 72 | 2.61 | 72 | 6.770 |
| BPRA5018 | 603 | 630 | 659 | 50 | 18 | 2.61 | 25 | 2.106 |
| BPRA5024 | 661 | 707 | 751 | 50 | 24 | 2.61 | 30 | 2.738 |
| BPRA5030 | 726 | 773 | 816 | 50 | 30 | 2.61 | 35 | 3.370 |
| BPRA5036 | 792 | 864 | 938 | 50 | 36 | 2.61 | 40 | 4.002 |
| BPRA5042 | 852 | 922 | 998 | 50 | 42 | 2.61 | 45 | 4.634 |
| BPRA5048 | 917 | 987 | 1063 | 50 | 48 | 2.61 | 50 | 5.266 |
| BPRA5054 | 976 | 1050 | 1123 | 50 | 54 | 2.61 | 55 | 5.898 |
| BPRA5060 | 1040 | 1112 | 1187 | 50 | 60 | 2.61 | 60 | 6.530 |
| BPRA5066 | 1137 | 1258 | 1382 | 50 | 66 | 2.61 | 70 | 7.300 |
| BPRA5072 | 1233 | 1351 | 1476 | 50 | 72 | 2.61 | 80 | 8.000 |
| BPRA5418 | 629 | 657 | 688 | 54 | 18 | 2.61 | 27 | 2.250 |
| BPRA5424 | 692 | 734 | 780 | 54 | 24 | 2.61 | 32 | 2.960 |
| BPRA5430 | 754 | 796 | 842 | 54 | 30 | 2.61 | 37 | 3.689 |
| BPRA5436 | 820 | 905 | 997 | 54 | 36 | 2.61 | 42 | 4.318 |
| BPRA5442 | 883 | 966 | 1060 | 54 | 42 | 2.61 | 47 | 4.934 |
| BPRA5448 | 948 | 1030 | 1123 | 54 | 48 | 2.61 | 52 | 5.666 |
| BPRA5454 | 1007 | 1092 | 1186 | 54 | 54 | 2.61 | 59 | 6.398 |
| BPRA5460 | 1073 | 1157 | 1250 | 54 | 60 | 2.61 | 62 | 7.035 |

BPRA • Acoustical Raceway Panel ...Cont

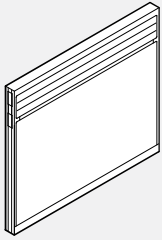

37" High

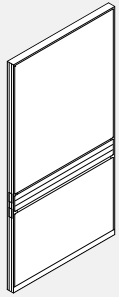

72" Wide

- Fabric above the raceway provides visual and acoustic privacy.
- Centre septum above and below raceway overlaid on either side with tackable, 1 1/8" "Sound absorbent mineral board".
- Centre septum below raceway overlaid on either side with 1 1/8" Mineral board.
- Acoustic rating of .80 NRC and 26 STC.
- OPT* = Laminate or Whiteboard.

| PRODUCT CODE | PRICE | | | SIZE/INCHES | | | WEIGHT LBS | VOL FT ³ |
|--------------|-------|------|------|-------------|----|------|------------|---------------------|
| | GR 1 | GR 2 | OPT* | H | W | D | | |
| BPRA5818 | 655 | 683 | 714 | 58 | 18 | 2.61 | 28 | 2.431 |
| BPRA5824 | 721 | 762 | 809 | 58 | 24 | 2.61 | 33 | 3.160 |
| BPRA5830 | 780 | 823 | 867 | 58 | 30 | 2.61 | 38 | 3.889 |
| BPRA5836 | 846 | 930 | 1023 | 58 | 36 | 2.61 | 43 | 4.618 |
| BPRA5842 | 913 | 997 | 1089 | 58 | 42 | 2.61 | 48 | 5.347 |
| BPRA5848 | 975 | 1061 | 1153 | 58 | 48 | 2.61 | 53 | 6.076 |
| BPRA5854 | 1040 | 1125 | 1216 | 58 | 54 | 2.61 | 58 | 6.806 |
| BPRA5860 | 1106 | 1189 | 1283 | 58 | 60 | 2.61 | 63 | 7.535 |
| BPRA6618 | 699 | 745 | 788 | 66 | 18 | 2.61 | 32 | 2.755 |
| BPRA6624 | 770 | 826 | 886 | 66 | 24 | 2.61 | 37 | 3.581 |
| BPRA6630 | 837 | 894 | 955 | 66 | 30 | 2.61 | 42 | 4.407 |
| BPRA6636 | 903 | 1001 | 1108 | 66 | 36 | 2.61 | 48 | 5.234 |
| BPRA6642 | 970 | 1067 | 1174 | 66 | 42 | 2.61 | 53 | 6.060 |
| BPRA6648 | 1037 | 1137 | 1241 | 66 | 48 | 2.61 | 58 | 6.887 |
| BPRA6654 | 1103 | 1203 | 1309 | 66 | 54 | 2.61 | 63 | 7.713 |
| BPRA6660 | 1170 | 1269 | 1375 | 66 | 60 | 2.61 | 68 | 8.539 |
| BPRA7418 | 759 | 802 | 849 | 74 | 18 | 2.61 | 34 | 3.079 |
| BPRA7424 | 826 | 884 | 943 | 74 | 24 | 2.61 | 39 | 4.002 |
| BPRA7430 | 894 | 952 | 1012 | 74 | 30 | 2.61 | 45 | 4.926 |
| BPRA7436 | 963 | 1078 | 1198 | 74 | 36 | 2.61 | 50 | 5.850 |
| BPRA7442 | 1034 | 1147 | 1267 | 74 | 42 | 2.61 | 55 | 6.773 |
| BPRA7448 | 1102 | 1214 | 1336 | 74 | 48 | 2.61 | 60 | 7.697 |
| BPRA7454 | 1170 | 1284 | 1405 | 74 | 54 | 2.61 | 65 | 8.620 |
| BPRA7460 | 1238 | 1352 | 1473 | 74 | 60 | 2.61 | 70 | 9.544 |
| BPRA8218 | 823 | 864 | 909 | 82 | 18 | 2.61 | 36 | 3.403 |
| BPRA8224 | 893 | 963 | 1038 | 82 | 24 | 2.61 | 42 | 4.424 |
| BPRA8230 | 963 | 1034 | 1109 | 82 | 30 | 2.61 | 48 | 5.444 |
| BPRA8236 | 1035 | 1165 | 1300 | 82 | 36 | 2.61 | 54 | 6.465 |
| BPRA8242 | 1106 | 1233 | 1369 | 82 | 42 | 2.61 | 60 | 7.486 |
| BPRA8248 | 1175 | 1302 | 1440 | 82 | 48 | 2.61 | 66 | 8.507 |
| BPRA8254 | 1245 | 1374 | 1511 | 82 | 54 | 2.61 | 72 | 9.528 |
| BPRA8260 | 1320 | 1445 | 1583 | 82 | 60 | 2.61 | 78 | 10.549 |

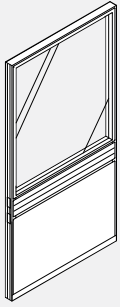
BPRG • Partly Glazed Raceway Panel

- Glazing above the raceway provides visual accessibility.
- Centre septum below raceway overlaid on either side with 1 1/8" "Sound absorbent mineral board".
- Glazing replaceable on site.
- Standard glaze is acrylic.
- For tempered glass, add "TG" to the end of the product code and add 20% to the price regardless of fabric grade or finish.
- OPT* = Laminate or Whiteboard.

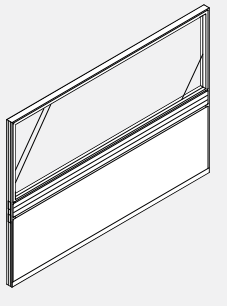

72" Wide

| PRODUCT CODE | PRICE | | | SIZE / INCHES | | | WEIGHT LBS | VOL FT ³ |
|--------------|-------|------|------|---------------|----|------|------------|---------------------|
| | GR 1 | GR 2 | OPT* | H | W | D | | |
| BPRG4218 | 712 | 723 | 740 | 42 | 18 | 2.61 | 22 | 1.782 |
| BPRG4224 | 778 | 805 | 835 | 42 | 24 | 2.61 | 28 | 2.317 |
| BPRG4230 | 845 | 872 | 903 | 42 | 30 | 2.61 | 32 | 2.852 |
| BPRG4236 | 913 | 970 | 1029 | 42 | 36 | 2.61 | 36 | 3.387 |
| BPRG4242 | 976 | 1034 | 1094 | 42 | 42 | 2.61 | 40 | 3.921 |
| BPRG4248 | 1045 | 1102 | 1165 | 42 | 48 | 2.61 | 44 | 4.456 |
| BPRG4254 | 1112 | 1169 | 1231 | 42 | 54 | 2.61 | 48 | 4.991 |
| BPRG4260 | 1177 | 1235 | 1296 | 42 | 60 | 2.61 | 52 | 5.525 |
| BPRG4266 | 1244 | 1303 | 1369 | 42 | 66 | 2.61 | 62 | 6.148 |
| BPRG4272 | 1312 | 1370 | 1436 | 42 | 72 | 2.61 | 72 | 6.770 |
| BPRG5018 | 791 | 805 | 820 | 50 | 18 | 2.61 | 24 | 2.106 |
| BPRG5024 | 856 | 885 | 916 | 50 | 24 | 2.61 | 29 | 2.738 |
| BPRG5030 | 926 | 955 | 985 | 50 | 30 | 2.61 | 34 | 3.370 |
| BPRG5036 | 996 | 1053 | 1113 | 50 | 36 | 2.61 | 39 | 4.002 |
| BPRG5042 | 1063 | 1121 | 1180 | 50 | 42 | 2.61 | 44 | 4.634 |
| BPRG5048 | 1131 | 1188 | 1246 | 50 | 48 | 2.61 | 48 | 5.266 |
| BPRG5054 | 1200 | 1259 | 1318 | 50 | 54 | 2.61 | 54 | 5.898 |
| BPRG5060 | 1267 | 1326 | 1385 | 50 | 60 | 2.61 | 59 | 6.530 |
| BPRG5066 | 1309 | 1368 | 1434 | 50 | 66 | 2.61 | 70 | 7.300 |
| BPRG5072 | 1348 | 1407 | 1441 | 50 | 72 | 2.61 | 78 | 8.000 |
| BPRG5418 | 831 | 846 | 862 | 54 | 18 | 2.61 | 27 | 2.250 |
| BPRG5424 | 897 | 928 | 958 | 54 | 24 | 2.61 | 30 | 2.960 |
| BPRG5430 | 970 | 998 | 1028 | 54 | 30 | 2.61 | 35 | 3.689 |
| BPRG5436 | 1040 | 1096 | 1157 | 54 | 36 | 2.61 | 40 | 4.318 |
| BPRG5442 | 1109 | 1168 | 1227 | 54 | 42 | 2.61 | 45 | 4.934 |
| BPRG5448 | 1177 | 1235 | 1296 | 54 | 48 | 2.61 | 49 | 5.666 |
| BPRG5454 | 1246 | 1304 | 1367 | 54 | 54 | 2.61 | 55 | 6.398 |
| BPRG5460 | 1318 | 1375 | 1436 | 54 | 60 | 2.61 | 60 | 7.035 |
| BPRG5818 | 872 | 886 | 901 | 58 | 18 | 2.61 | 26 | 2.431 |
| BPRG5824 | 941 | 970 | 999 | 58 | 24 | 2.61 | 31 | 3.160 |
| BPRG5830 | 1012 | 1040 | 1069 | 58 | 30 | 2.61 | 36 | 3.889 |
| BPRG5836 | 1086 | 1142 | 1201 | 58 | 36 | 2.61 | 41 | 4.618 |
| BPRG5842 | 1156 | 1212 | 1273 | 58 | 42 | 2.61 | 46 | 5.347 |
| BPRG5848 | 1225 | 1283 | 1343 | 58 | 48 | 2.61 | 51 | 6.076 |
| BPRG5854 | 1296 | 1352 | 1412 | 58 | 54 | 2.61 | 56 | 6.806 |
| BPRG5860 | 1367 | 1424 | 1483 | 58 | 60 | 2.61 | 61 | 7.535 |
| BPRG6618 | 949 | 962 | 976 | 66 | 18 | 2.61 | 29 | 2.755 |
| BPRG6624 | 1023 | 1052 | 1083 | 66 | 24 | 2.61 | 34 | 3.581 |
| BPRG6630 | 1096 | 1126 | 1156 | 66 | 30 | 2.61 | 39 | 4.407 |
| BPRG6636 | 1171 | 1231 | 1290 | 66 | 36 | 2.61 | 45 | 5.234 |
| BPRG6642 | 1245 | 1303 | 1366 | 66 | 42 | 2.61 | 50 | 6.060 |
| BPRG6648 | 1324 | 1379 | 1440 | 66 | 48 | 2.61 | 55 | 6.887 |
| BPRG6654 | 1396 | 1454 | 1514 | 66 | 54 | 2.61 | 60 | 7.713 |
| BPRG6660 | 1475 | 1534 | 1594 | 66 | 60 | 2.61 | 65 | 8.539 |
| BPRG7418 | 1024 | 1037 | 1053 | 74 | 18 | 2.61 | 30 | 3.079 |
| BPRG7424 | 1103 | 1132 | 1165 | 74 | 24 | 2.61 | 35 | 4.002 |
| BPRG7430 | 1181 | 1238 | 1300 | 74 | 30 | 2.61 | 41 | 4.926 |
| BPRG7436 | 1261 | 1318 | 1378 | 74 | 36 | 2.61 | 46 | 5.850 |
| BPRG7442 | 1339 | 1396 | 1457 | 74 | 42 | 2.61 | 51 | 6.773 |
| BPRG7448 | 1419 | 1476 | 1539 | 74 | 48 | 2.61 | 56 | 7.697 |
| BPRG7454 | 1498 | 1554 | 1615 | 74 | 54 | 2.61 | 61 | 8.620 |
| BPRG7460 | 1590 | 1647 | 1710 | 74 | 60 | 2.61 | 66 | 9.544 |
| BPRG8218 | 1079 | 1091 | 1107 | 82 | 18 | 2.61 | 31 | 3.403 |
| BPRG8224 | 1168 | 1197 | 1226 | 82 | 24 | 2.61 | 36 | 4.424 |
| BPRG8230 | 1259 | 1288 | 1317 | 82 | 30 | 2.61 | 43 | 5.444 |
| BPRG8236 | 1348 | 1406 | 1466 | 82 | 36 | 2.61 | 49 | 6.465 |
| BPRG8242 | 1435 | 1491 | 1550 | 82 | 42 | 2.61 | 55 | 7.486 |
| BPRG8248 | 1526 | 1583 | 1644 | 82 | 48 | 2.61 | 61 | 8.507 |
| BPRG8254 | 1613 | 1670 | 1731 | 82 | 54 | 2.61 | 67 | 9.528 |
| BPRG8260 | 1714 | 1774 | 1832 | 82 | 60 | 2.61 | 73 | 10.549 |

BPRF • Air Flow Panel

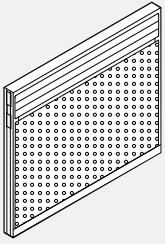

37" High

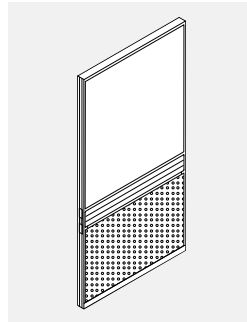

72" Wide

- Double wall of perforated metal below the raceway allows air to flow freely through the bottom of the panel.
- Centre septum above raceway overlaid on either side with tackable, 1 1/8" "Sound absorbent mineral board".
- For air flow option above the raceway, add 20% to the Grade 1 price and tag each item with "air flow above raceway". For example: BPRF4218 TAG:*air flow above raceway.
- OPT* = Laminate or Whiteboard.

| PRODUCT CODE | PRICE | | | SIZE/INCHES | | | WEIGHT VOL | |
|--------------|-------|------|------|-------------|----|------|------------|-----------------|
| | GR 1 | GR 2 | OPT* | H | W | D | LBS | FT ³ |
| BPRF3718 | 592 | - | - | 37 | 18 | 2.61 | 18 | 1.58 |
| BPRF3724 | 670 | - | - | 37 | 24 | 2.61 | 21 | 2.054 |
| BPRF3730 | 755 | - | - | 37 | 30 | 2.61 | 25 | 2.528 |
| BPRF3736 | 833 | - | - | 37 | 36 | 2.61 | 28 | 3.002 |
| BPRF3742 | 916 | - | - | 37 | 42 | 2.61 | 32 | 3.476 |
| BPRF3748 | 996 | - | - | 37 | 48 | 2.61 | 35 | 3.950 |
| BPRF3754 | 1074 | - | - | 37 | 54 | 2.61 | 39 | 4.424 |
| BPRF3760 | 1156 | - | - | 37 | 60 | 2.61 | 44 | 4.898 |
| BPRF3766 | 1243 | - | - | 37 | 66 | 2.61 | 50 | 5.449 |
| BPRF3772 | 1330 | - | - | 37 | 72 | 2.61 | 56 | 6.000 |
| BPRF4218 | 612 | 621 | 627 | 42 | 18 | 2.61 | 22 | 1.782 |
| BPRF4224 | 694 | 701 | 712 | 42 | 24 | 2.61 | 28 | 2.317 |
| BPRF4230 | 778 | 784 | 791 | 42 | 30 | 2.61 | 32 | 2.852 |
| BPRF4236 | 860 | 872 | 888 | 42 | 36 | 2.61 | 36 | 3.387 |
| BPRF4242 | 943 | 958 | 972 | 42 | 42 | 2.61 | 40 | 3.921 |
| BPRF4248 | 1026 | 1038 | 1055 | 42 | 48 | 2.61 | 44 | 4.456 |
| BPRF4254 | 1108 | 1122 | 1137 | 42 | 54 | 2.61 | 48 | 4.991 |
| BPRF4260 | 1196 | 1208 | 1224 | 42 | 60 | 2.61 | 52 | 5.525 |
| BPRF4266 | 1333 | 1394 | 1458 | 42 | 66 | 2.61 | 62 | 6.270 |
| BPRF4272 | 1473 | 1533 | 1599 | 42 | 72 | 2.61 | 72 | 6.770 |
| BPRF5018 | 688 | 699 | 717 | 50 | 18 | 2.61 | 25 | 2.106 |
| BPRF5024 | 773 | 784 | 800 | 50 | 24 | 2.61 | 30 | 2.738 |
| BPRF5030 | 857 | 870 | 886 | 50 | 30 | 2.61 | 35 | 3.370 |
| BPRF5036 | 947 | 973 | 1003 | 50 | 36 | 2.61 | 40 | 4.002 |
| BPRF5042 | 1034 | 1063 | 1092 | 50 | 42 | 2.61 | 45 | 4.634 |
| BPRF5048 | 1121 | 1148 | 1178 | 50 | 48 | 2.61 | 50 | 5.266 |
| BPRF5054 | 1205 | 1235 | 1265 | 50 | 54 | 2.61 | 55 | 5.898 |
| BPRF5060 | 1294 | 1324 | 1352 | 50 | 60 | 2.61 | 60 | 6.530 |
| BPRF5066 | 1424 | 1482 | 1547 | 50 | 66 | 2.61 | 70 | 7.300 |
| BPRF5072 | 1550 | 1609 | 1675 | 50 | 72 | 2.61 | 80 | 8.000 |
| BPRF5418 | 713 | 733 | 755 | 54 | 18 | 2.61 | 27 | 2.250 |
| BPRF5424 | 797 | 819 | 842 | 54 | 24 | 2.61 | 32 | 2.960 |
| BPRF5430 | 886 | 908 | 930 | 54 | 30 | 2.61 | 37 | 3.689 |
| BPRF5436 | 973 | 1017 | 1062 | 54 | 36 | 2.61 | 42 | 4.318 |
| BPRF5442 | 1063 | 1106 | 1152 | 54 | 42 | 2.61 | 47 | 4.934 |
| BPRF5448 | 1152 | 1194 | 1237 | 54 | 48 | 2.61 | 52 | 5.666 |
| BPRF5454 | 1237 | 1279 | 1326 | 54 | 54 | 2.61 | 57 | 6.398 |
| BPRF5460 | 1327 | 1369 | 1414 | 54 | 60 | 2.61 | 62 | 7.035 |

BPRF • Air Flow Panel ...Cont

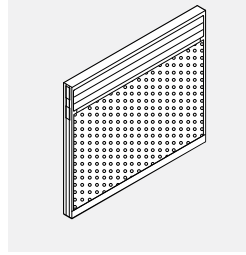

37" High

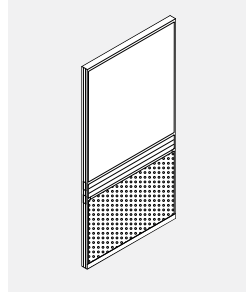

72" Wide

- Double wall of perforated metal below the raceway allows air to flow freely through the bottom of the panel.
- Centre septum above raceway overlaid on either side with tackable, 1 1/8" "Sound absorbent mineral board".
- For air flow option above the raceway, add 20% to the Grade 1 price and tag each item with "air flow above raceway". For example: BPRF4218 TAG:*air flow above raceway.
- OPT* = Laminate or Whiteboard.

| PRODUCT CODE | PRICE | | | SIZE/INCHES | | | WEIGHT LBS | VOL FT ³ |
|--------------|-------|------|------|-------------|----|------|------------|---------------------|
| | GR 1 | GR 2 | OPT* | H | W | D | | |
| BPRF5818 | 734 | 755 | 779 | 58 | 18 | 2.61 | 28 | 2.431 |
| BPRF5824 | 824 | 845 | 867 | 58 | 24 | 2.61 | 33 | 3.160 |
| BPRF5830 | 916 | 936 | 959 | 58 | 30 | 2.61 | 38 | 3.889 |
| BPRF5836 | 1001 | 1045 | 1090 | 58 | 36 | 2.61 | 43 | 4.618 |
| BPRF5842 | 1090 | 1132 | 1177 | 58 | 42 | 2.61 | 48 | 5.347 |
| BPRF5848 | 1180 | 1224 | 1267 | 58 | 48 | 2.61 | 53 | 6.076 |
| BPRF5854 | 1267 | 1310 | 1355 | 58 | 54 | 2.61 | 58 | 6.806 |
| BPRF5860 | 1358 | 1401 | 1445 | 58 | 60 | 2.61 | 63 | 7.535 |
| BPRF6618 | 784 | 813 | 843 | 66 | 18 | 2.61 | 32 | 2.755 |
| BPRF6624 | 879 | 907 | 936 | 66 | 24 | 2.61 | 37 | 3.581 |
| BPRF6630 | 969 | 997 | 1027 | 66 | 30 | 2.61 | 42 | 4.407 |
| BPRF6636 | 1060 | 1108 | 1160 | 66 | 36 | 2.61 | 48 | 5.234 |
| BPRF6642 | 1212 | 1264 | 1317 | 66 | 42 | 2.61 | 53 | 6.060 |
| BPRF6648 | 1288 | 1336 | 1389 | 66 | 48 | 2.61 | 58 | 6.887 |
| BPRF6654 | 1395 | 1443 | 1498 | 66 | 54 | 2.61 | 63 | 7.713 |
| BPRF6660 | 1435 | 1483 | 1538 | 66 | 60 | 2.61 | 68 | 8.539 |
| BPRF7418 | 842 | 869 | 898 | 74 | 18 | 2.61 | 34 | 3.079 |
| BPRF7424 | 931 | 960 | 992 | 74 | 24 | 2.61 | 39 | 4.002 |
| BPRF7430 | 1026 | 1055 | 1086 | 74 | 30 | 2.61 | 45 | 4.926 |
| BPRF7436 | 1121 | 1193 | 1266 | 74 | 36 | 2.61 | 50 | 5.850 |
| BPRF7442 | 1294 | 1366 | 1440 | 74 | 42 | 2.61 | 55 | 6.773 |
| BPRF7448 | 1332 | 1405 | 1480 | 74 | 48 | 2.61 | 60 | 7.697 |
| BPRF7454 | 1397 | 1470 | 1543 | 74 | 54 | 2.61 | 65 | 8.620 |
| BPRF7460 | 1491 | 1563 | 1638 | 74 | 60 | 2.61 | 70 | 9.544 |
| BPRF8218 | 907 | 949 | 995 | 82 | 18 | 2.61 | 36 | 3.403 |
| BPRF8224 | 1000 | 1043 | 1089 | 82 | 24 | 2.61 | 42 | 4.424 |
| BPRF8230 | 1094 | 1137 | 1181 | 82 | 30 | 2.61 | 48 | 5.444 |
| BPRF8236 | 1201 | 1279 | 1363 | 82 | 36 | 2.61 | 54 | 6.465 |
| BPRF8242 | 1332 | 1411 | 1496 | 82 | 42 | 2.61 | 60 | 7.486 |
| BPRF8248 | 1395 | 1473 | 1556 | 82 | 48 | 2.61 | 66 | 8.507 |
| BPRF8254 | 1543 | 1622 | 1706 | 82 | 54 | 2.61 | 72 | 9.528 |
| BPRF8260 | 1575 | 1654 | 1738 | 82 | 60 | 2.61 | 78 | 10.549 |

BPRAE • Raceway Panel Electrical

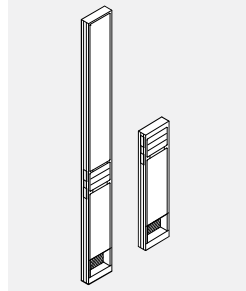

- A 6" raceway panel allows power and communication/data entry along a straight run of panels where a standard post entry cannot be utilized.
- Sections above and below the raceway are upholstered in fabric.
- Inner lower raceway area allows for single or double power feed entry and provides 1.3" x 2.9" opening for communication/data cables.
- All 6" panels must be used in conjunction with a second panel to form a standard panel width. For example: BPRAE6606 + BPRA6618 is equivalent to BPRA6624.
- 6" panels are not to be used as a stability panel in a panel run.

| PRODUCT CODE | PRICE | | | SIZE/ INCHES | | | WEIGHT LBS | VOL FT ³ |
|--------------|-------|------|------|--------------|---|------|------------|---------------------|
| | GR 1 | GR 2 | OPT* | H | W | D | | |
| BPRAE3706 | 590 | 605 | 621 | 37 | 6 | 2.61 | 24 | 0.6 |
| BPRAE4206 | 590 | 619 | 652 | 42 | 6 | 2.61 | 26 | 0.7 |
| BPRAE5006 | 661 | 709 | 752 | 50 | 6 | 2.61 | 29 | 0.8 |
| BPRAE5406 | 692 | 736 | 781 | 54 | 6 | 2.61 | 31 | 0.9 |
| BPRAE5806 | 721 | 763 | 811 | 58 | 6 | 2.61 | 32 | 0.9 |
| BPRAE6606 | 770 | 826 | 888 | 66 | 6 | 2.61 | 35 | 1.0 |
| BPRAE7406 | 826 | 884 | 947 | 74 | 6 | 2.61 | 37 | 1.1 |
| BPRAE8206 | 893 | 963 | 1040 | 82 | 6 | 2.61 | 41 | 1.2 |

BPRA • Raceway Panel Filler

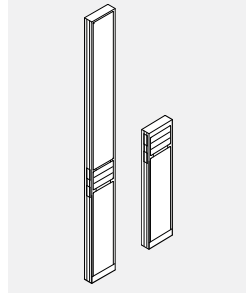

- A 6" (BPRA) raceway panel for use as a filler panel.
- Sections above and below the raceway are upholstered in fabric.
- All 6" panels must be used in conjunction with a second panel to form a standard panel width. For example: BPRA6606 + BPRA6618 is equivalent to BPRA6624.
- 6" panels are not to be used as a stability panel in a panel run.

| PRODUCT CODE | PRICE | | | SIZE/INCHES | | | WEIGHT LBS | VOL FT ³ |
|--------------|-------|------|------|-------------|---|------|------------|---------------------|
| | GR 1 | GR 2 | OPT* | H | W | D | | |
| BPRA3706 | 590 | 604 | 619 | 37 | 6 | 2.61 | 24 | 0.6 |
| BPRA4206 | 590 | 619 | 649 | 42 | 6 | 2.61 | 26 | 0.7 |
| BPRA5006 | 661 | 707 | 751 | 50 | 6 | 2.61 | 29 | 0.8 |
| BPRA5406 | 692 | 734 | 780 | 54 | 6 | 2.61 | 31 | 0.9 |
| BPRA5806 | 721 | 762 | 809 | 58 | 6 | 2.61 | 32 | 0.9 |
| BPRA6606 | 770 | 826 | 886 | 66 | 6 | 2.61 | 35 | 1.0 |
| BPRA7406 | 826 | 884 | 943 | 74 | 6 | 2.61 | 37 | 1.1 |
| BPRA8206 | 893 | 963 | 1038 | 82 | 6 | 2.61 | 41 | 1.2 |

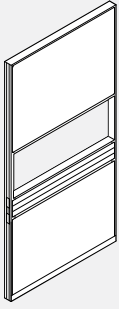
BPRP • Pass-Thru Raceway Panel

- **10.5" Open cavity allows accessibility between workstations.**
- Center septum above 10.5" opening overlaid on either side with tackable, 1 1/8" mineral board.
- Center septum below raceway overlaid on either side with tackable, 1 1/8" mineral board.
- Pass-thru opening is 10.5" high starting above the raceway.
- Panel height to top of opening is fixed.

| PRODUCT CODE | PRICE | | | SIZE/INCHES | | | WEIGHT LBS | VOL FT ³ |
|--------------|-------|------|------|-------------|----|------|------------|---------------------|
| | GR 1 | GR 2 | OPT* | H | W | D | | |
| BPRP6618 | 949 | 962 | 976 | 66 | 18 | 2.61 | 32 | 2.755 |
| BPRP6624 | 1023 | 1052 | 1083 | 66 | 24 | 2.61 | 33 | 3.581 |
| BPRP6630 | 1096 | 1126 | 1156 | 66 | 30 | 2.61 | 38 | 4.407 |
| BPRP6636 | 1171 | 1231 | 1290 | 66 | 36 | 2.61 | 44 | 5.234 |
| BPRP6642 | 1245 | 1303 | 1366 | 66 | 42 | 2.61 | 49 | 6.060 |
| BPRP6648 | 1324 | 1379 | 1440 | 66 | 48 | 2.61 | 54 | 6.887 |
| BPRP6654 | 1396 | 1454 | 1514 | 66 | 54 | 2.61 | 59 | 7.713 |
| BPRP6660 | 1475 | 1534 | 1594 | 66 | 60 | 2.61 | 64 | 8.539 |
| BPRP7418 | 1024 | 1060 | 1094 | 74 | 18 | 2.61 | 31 | 3.079 |
| BPRP7424 | 1103 | 1160 | 1223 | 74 | 24 | 2.61 | 36 | 4.002 |
| BPRP7430 | 1181 | 1238 | 1300 | 74 | 30 | 2.61 | 42 | 4.926 |
| BPRP7436 | 1261 | 1329 | 1405 | 74 | 36 | 2.61 | 47 | 5.850 |
| BPRP7442 | 1339 | 1396 | 1457 | 74 | 42 | 2.61 | 52 | 6.773 |
| BPRP7448 | 1419 | 1514 | 1613 | 74 | 48 | 2.61 | 57 | 7.697 |
| BPRP7454 | 1498 | 1590 | 1690 | 74 | 54 | 2.61 | 62 | 8.620 |
| BPRP7460 | 1590 | 1647 | 1710 | 74 | 60 | 2.61 | 67 | 9.544 |
| BPRP8218 | 1079 | 1119 | 1165 | 82 | 18 | 2.61 | 34 | 3.403 |
| BPRP8224 | 1168 | 1223 | 1279 | 82 | 24 | 2.61 | 40 | 4.424 |
| BPRP8230 | 1259 | 1312 | 1370 | 82 | 30 | 2.61 | 46 | 5.444 |
| BPRP8236 | 1348 | 1447 | 1552 | 82 | 36 | 2.61 | 52 | 6.465 |
| BPRP8242 | 1435 | 1547 | 1668 | 82 | 42 | 2.61 | 58 | 7.486 |
| BPRP8248 | 1526 | 1639 | 1758 | 82 | 48 | 2.61 | 64 | 8.507 |
| BPRP8254 | 1613 | 1724 | 1846 | 82 | 54 | 2.61 | 70 | 9.528 |
| BPRP8260 | 1714 | 1827 | 1949 | 82 | 60 | 2.61 | 76 | 10.549 |

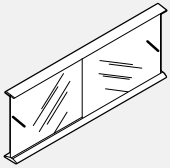
BPRPSD • Pass-Thru Sliding Door Kit

- **To close the opening in a Boulevard 1 Pass-Thru Panel.**
- Sliding frosted tempered glass doors.

| PRODUCT CODE | PRICE | SIZE/INCHES | | | WEIGHT LBS | VOL FT ³ |
|--------------|-------|-------------|----|------|------------|---------------------|
| | | H | W | D | | |
| BPRPSD36 | 385 | 10 | 36 | 2.61 | 13 | 1.2 |
| BPRPSD42 | 433 | 10 | 42 | 2.61 | 16 | 1.4 |
| BPRPSD48 | 483 | 10 | 48 | 2.61 | 18 | 1.5 |
| BPRPSD54 | 528 | 10 | 54 | 2.61 | 20 | 1.7 |
| BPRPSD60 | 578 | 10 | 60 | 2.61 | 22 | 2.0 |

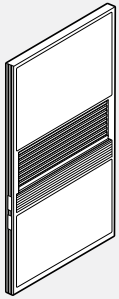
BPAR • Accessory Rail Panel

- **12" Accessory rail covers the standard pass-thru opening and allows users to hang accessories.**
- Centre septum above 12" opening overlaid on either side with tackable, 1 1/8" "Sound absorbent mineral board".
- Centre septum below raceway overlaid on either side with 1 1/8" mineral board.
- Accessory rail is 12" high starting above the raceway. Panel height to top of opening is fixed.
- OPT* = Laminate or Whiteboard.

| PRODUCT CODE | PRICE | | | SIZE/INCHES | | | WEIGHT LBS | VOL FT ³ |
|--------------|-------|------|------|-------------|----|------|------------|---------------------|
| | GR 1 | GR 2 | OPT* | H | W | D | | |
| BPAR6618 | 1107 | 1121 | 1135 | 66 | 18 | 2.61 | 35 | 2.755 |
| BPAR6624 | 1201 | 1232 | 1261 | 66 | 24 | 2.61 | 42 | 3.581 |
| BPAR6630 | 1320 | 1348 | 1378 | 66 | 30 | 2.61 | 49 | 4.407 |
| BPAR6636 | 1442 | 1500 | 1561 | 66 | 36 | 2.61 | 57 | 5.234 |
| BPAR6642 | 1595 | 1653 | 1713 | 66 | 42 | 2.61 | 65 | 6.060 |
| BPAR6648 | 1714 | 1774 | 1832 | 66 | 48 | 2.61 | 72 | 6.887 |
| BPAR6654 | 1838 | 1893 | 1955 | 66 | 54 | 2.61 | 79 | 7.713 |
| BPAR6660 | 1953 | 2012 | 2071 | 66 | 60 | 2.61 | 86 | 8.539 |
| BPAR7418 | 1186 | 1220 | 1258 | 74 | 18 | 2.61 | 38 | 3.079 |
| BPAR7424 | 1279 | 1338 | 1397 | 74 | 24 | 2.61 | 45 | 4.002 |
| BPAR7430 | 1397 | 1456 | 1515 | 74 | 30 | 2.61 | 53 | 4.926 |
| BPAR7436 | 1529 | 1600 | 1672 | 74 | 36 | 2.61 | 60 | 5.850 |
| BPAR7442 | 1683 | 1741 | 1801 | 74 | 42 | 2.61 | 68 | 6.773 |
| BPAR7448 | 1805 | 1903 | 2007 | 74 | 48 | 2.61 | 75 | 7.697 |
| BPAR7454 | 1930 | 1987 | 2049 | 74 | 54 | 2.61 | 82 | 8.620 |
| BPAR7460 | 2060 | 2117 | 2177 | 74 | 60 | 2.61 | 89 | 9.544 |
| BPAR8218 | 1234 | 1273 | 1318 | 82 | 18 | 2.61 | 41 | 3.403 |
| BPAR8224 | 1340 | 1395 | 1454 | 82 | 24 | 2.61 | 49 | 4.424 |
| BPAR8230 | 1470 | 1525 | 1581 | 82 | 30 | 2.61 | 57 | 5.444 |
| BPAR8236 | 1608 | 1710 | 1813 | 82 | 36 | 2.61 | 65 | 6.465 |
| BPAR8242 | 1775 | 1888 | 2007 | 82 | 42 | 2.61 | 74 | 7.486 |
| BPAR8248 | 1906 | 2019 | 2141 | 82 | 48 | 2.61 | 82 | 8.507 |
| BPAR8254 | 2042 | 2156 | 2277 | 82 | 54 | 2.61 | 90 | 9.528 |
| BPAR8260 | 2174 | 2288 | 2408 | 82 | 60 | 2.61 | 98 | 10.549 |

BPFA • Acoustical Fabric Panel

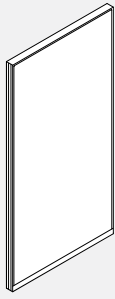

- Complete fabric panel without raceway.
- Acoustical rating of .80 NRC and 26 STC.
- Centre septum overlaid on either side with 1/8" Mineral board, non tackable.
- OPT* = Laminate or Whiteboard.

| PRODUCT CODE | PRICE | | | SIZE / INCHES | | | WEIGHT LBS | VOL FT ³ |
|-----------------|-------|------|------|---------------|----|------|---------------|------------------------|
| | GR 1 | GR 2 | OPT* | H | W | D | | |
| BPFA2918 | 364 | 391 | 420 | 29 | 18 | 2.61 | 15 | 1.256 |
| BPFA2924 | 392 | 422 | 456 | 29 | 24 | 2.61 | 17 | 1.633 |
| BPFA2930 | 419 | 449 | 478 | 29 | 30 | 2.61 | 19 | 2.009 |
| BPFA2936 | 450 | 508 | 568 | 29 | 36 | 2.61 | 21 | 2.386 |
| BPFA2942 | 477 | 536 | 593 | 29 | 42 | 2.61 | 23 | 2.763 |
| BPFA2948 | 508 | 565 | 625 | 29 | 48 | 2.61 | 25 | 3.139 |
| BPFA2954 | 536 | 591 | 653 | 29 | 54 | 2.61 | 27 | 3.513 |
| BPFA2960 | 563 | 621 | 681 | 29 | 60 | 2.61 | 29 | 3.893 |
| BPFA2966 | 582 | 643 | 709 | 29 | 66 | 2.61 | 36 | 4.332 |
| BPFA2972 | 604 | 660 | - | 29 | 72 | 2.61 | 42 | 4.770 |
| BPFA4218 | 477 | 507 | 537 | 42 | 18 | 2.61 | 18 | 1.782 |
| BPFA4224 | 509 | 567 | 626 | 42 | 24 | 2.61 | 21 | 2.317 |
| BPFA4230 | 539 | 593 | 655 | 42 | 30 | 2.61 | 24 | 2.852 |
| BPFA4236 | 569 | 639 | 715 | 42 | 36 | 2.61 | 27 | 3.387 |
| BPFA4242 | 600 | 670 | 746 | 42 | 42 | 2.61 | 30 | 3.921 |
| BPFA4248 | 629 | 698 | 777 | 42 | 48 | 2.61 | 33 | 4.456 |
| BPFA4254 | 658 | 727 | 805 | 42 | 54 | 2.61 | 36 | 4.991 |
| BPFA4260 | 691 | 761 | 837 | 42 | 60 | 2.61 | 39 | 5.525 |
| BPFA4266 | 779 | 896 | 1024 | 42 | 66 | 2.61 | 47 | 6.148 |
| BPFA4272 | 865 | 985 | - | 42 | 72 | 2.61 | 54 | 6.770 |
| BPFA5018 | 540 | 568 | 596 | 50 | 18 | 2.61 | 22 | 2.106 |
| BPFA5024 | 573 | 613 | 658 | 50 | 24 | 2.61 | 25 | 2.738 |
| BPFA5030 | 605 | 647 | 692 | 50 | 30 | 2.61 | 28 | 3.370 |
| BPFA5036 | 636 | 722 | 813 | 50 | 36 | 2.61 | 31 | 4.002 |
| BPFA5042 | 668 | 752 | 845 | 50 | 42 | 2.61 | 34 | 4.634 |
| BPFA5048 | 698 | 784 | 877 | 50 | 48 | 2.61 | 38 | 5.266 |
| BPFA5054 | 733 | 817 | 909 | 50 | 54 | 2.61 | 41 | 5.898 |
| BPFA5060 | 765 | 851 | 942 | 50 | 60 | 2.61 | 43 | 6.530 |
| BPFA5066 | 843 | 962 | 1089 | 50 | 66 | 2.61 | 53 | 7.300 |
| BPFA5072 | 920 | 1038 | - | 50 | 72 | 2.61 | 62 | 8.000 |
| BPFA5418 | 570 | 600 | 629 | 54 | 18 | 2.61 | 23 | 2.250 |
| BPFA5424 | 604 | 645 | 691 | 54 | 24 | 2.61 | 26 | 2.960 |
| BPFA5430 | 636 | 680 | 723 | 54 | 30 | 2.61 | 30 | 3.689 |
| BPFA5436 | 670 | 754 | 846 | 54 | 36 | 2.61 | 34 | 4.318 |
| BPFA5442 | 701 | 786 | 880 | 54 | 42 | 2.61 | 38 | 4.934 |
| BPFA5448 | 736 | 820 | 913 | 54 | 48 | 2.61 | 41 | 5.666 |
| BPFA5454 | 770 | 853 | 947 | 54 | 54 | 2.61 | 43 | 6.398 |
| BPFA5460 | 805 | 891 | 983 | 54 | 60 | 2.61 | 46 | 7.035 |

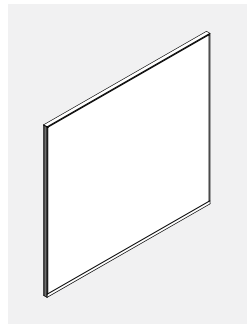

72" Wide

BPFA • Acoustical Fabric Panel ...Cont

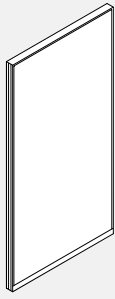

- Complete fabric panel without raceway.
- Acoustical rating of .80 NRC and 26 STC.
- Centre septum overlaid on either side with 1 1/8" Mineral board, non tackable.
- OPT* = Laminate or Whiteboard.

| PRODUCT CODE | PRICE | | | SIZE/INCHES | | | WEIGHT LBS | VOL FT ³ |
|--------------|-------|------|------|-------------|----|------|------------|---------------------|
| | GR 1 | GR 2 | OPT* | H | W | D | | |
| BPFA5818 | 602 | 643 | 688 | 58 | 18 | 2.61 | 24 | 2.431 |
| BPFA5824 | 634 | 692 | 752 | 58 | 24 | 2.61 | 27 | 3.160 |
| BPFA5830 | 668 | 724 | 785 | 58 | 30 | 2.61 | 31 | 3.889 |
| BPFA5836 | 699 | 801 | 907 | 58 | 36 | 2.61 | 35 | 4.618 |
| BPFA5842 | 736 | 835 | 941 | 58 | 42 | 2.61 | 39 | 5.347 |
| BPFA5848 | 773 | 869 | 975 | 58 | 48 | 2.61 | 42 | 6.076 |
| BPFA5854 | 805 | 905 | 1011 | 58 | 54 | 2.61 | 46 | 6.806 |
| BPFA5860 | 843 | 942 | 1050 | 58 | 60 | 2.61 | 50 | 7.535 |
| BPFA6618 | 656 | 697 | 745 | 66 | 18 | 2.61 | 26 | 2.755 |
| BPFA6624 | 693 | 751 | 812 | 66 | 24 | 2.61 | 29 | 3.581 |
| BPFA6630 | 731 | 788 | 850 | 66 | 30 | 2.61 | 34 | 4.407 |
| BPFA6636 | 770 | 883 | 1001 | 66 | 36 | 2.61 | 39 | 5.234 |
| BPFA6642 | 809 | 921 | 1041 | 66 | 42 | 2.61 | 43 | 6.060 |
| BPFA6648 | 846 | 959 | 1080 | 66 | 48 | 2.61 | 47 | 6.887 |
| BPFA6654 | 885 | 998 | 1119 | 66 | 54 | 2.61 | 51 | 7.713 |
| BPFA6660 | 921 | 1034 | 1155 | 66 | 60 | 2.61 | 55 | 8.539 |
| BPFA7418 | 720 | 761 | 806 | 74 | 18 | 2.61 | 28 | 3.079 |
| BPFA7424 | 758 | 829 | 905 | 74 | 24 | 2.61 | 32 | 4.002 |
| BPFA7430 | 797 | 868 | 943 | 74 | 30 | 2.61 | 37 | 4.926 |
| BPFA7436 | 837 | 963 | 1101 | 74 | 36 | 2.61 | 42 | 5.850 |
| BPFA7442 | 879 | 1003 | 1142 | 74 | 42 | 2.61 | 47 | 6.773 |
| BPFA7448 | 918 | 1045 | 1181 | 74 | 48 | 2.61 | 51 | 7.697 |
| BPFA7454 | 958 | 1086 | 1223 | 74 | 54 | 2.61 | 55 | 8.620 |
| BPFA7460 | 999 | 1126 | 1264 | 74 | 60 | 2.61 | 60 | 9.544 |
| BPFA8218 | 778 | 833 | 894 | 82 | 18 | 2.61 | 30 | 3.403 |
| BPFA8224 | 819 | 891 | 964 | 82 | 24 | 2.61 | 35 | 4.424 |
| BPFA8230 | 863 | 933 | 1007 | 82 | 30 | 2.61 | 40 | 5.444 |
| BPFA8236 | 907 | 1050 | 1199 | 82 | 36 | 2.61 | 45 | 6.465 |
| BPFA8242 | 949 | 1090 | 1239 | 82 | 42 | 2.61 | 50 | 7.486 |
| BPFA8248 | 994 | 1134 | 1286 | 82 | 48 | 2.61 | 55 | 8.507 |
| BPFA8254 | 1037 | 1178 | 1329 | 82 | 54 | 2.61 | 60 | 9.528 |
| BPFA8260 | 1084 | 1225 | 1375 | 82 | 60 | 2.61 | 65 | 10.549 |

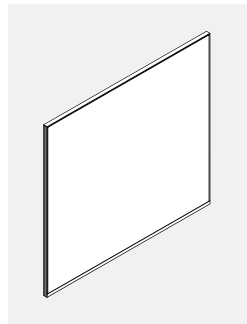

72" Wide

BPFG • Glazed Panel

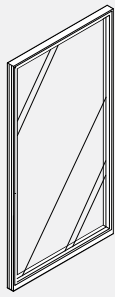

- Full-height glazing provides visual accessibility.
- Glazing is replaceable on site.
- For tempered glass, add "TG" to the end of the product code and 20% to the list price regardless of finish.

| PRODUCT CODE | PRICE | SIZE/ INCHES | | | WEIGHT LBS | VOL FT ³ |
|--------------|-------|--------------|----|------|------------|---------------------|
| | | H | W | D | | |
| BPFG5824 | 833 | 58 | 24 | 2.61 | 21 | 3.160 |
| BPFG5830 | 918 | 58 | 30 | 2.61 | 24 | 3.889 |
| BPFG5836 | 1000 | 58 | 36 | 2.61 | 27 | 4.618 |
| BPFG5842 | 1086 | 58 | 42 | 2.61 | 30 | 5.347 |
| BPFG5848 | 1167 | 58 | 48 | 2.61 | 33 | 6.076 |
| BPFG6624 | 1004 | 66 | 24 | 2.61 | 25 | 3.581 |
| BPFG6630 | 1090 | 66 | 30 | 2.61 | 28 | 4.407 |
| BPFG6636 | 1177 | 66 | 36 | 2.61 | 31 | 5.234 |
| BPFG6642 | 1264 | 66 | 42 | 2.61 | 34 | 6.060 |
| BPFG6648 | 1352 | 66 | 48 | 2.61 | 37 | 6.887 |
| BPFG7424 | 1053 | 74 | 24 | 2.61 | 28 | 4.002 |
| BPFG7430 | 1143 | 74 | 30 | 2.61 | 31 | 4.926 |
| BPFG7436 | 1235 | 74 | 36 | 2.61 | 34 | 5.850 |
| BPFG7442 | 1327 | 74 | 42 | 2.61 | 37 | 6.773 |
| BPFG7448 | 1416 | 74 | 48 | 2.61 | 40 | 7.697 |
| BPFG8224 | 1148 | 82 | 24 | 2.61 | 31 | 4.424 |
| BPFG8230 | 1255 | 82 | 30 | 2.61 | 34 | 5.444 |
| BPFG8236 | 1352 | 82 | 36 | 2.61 | 37 | 6.465 |
| BPFG8242 | 1454 | 82 | 42 | 2.61 | 40 | 7.486 |
| BPFG8248 | 1554 | 82 | 48 | 2.61 | 43 | 8.507 |

BPOF • Fabric Over Panel

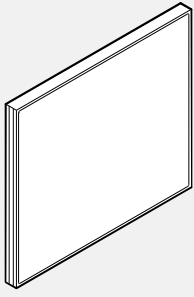

- **Attaches to top of a panel to create floor-to-ceiling wall.**

- Centre septum overlaid on either side with 1 1/8" Mineral board.
- Non-slotted.
- Factory installed PVC strip attaches and aligns over panel to top of base panel.
- PVC strip runs entire width eliminating light seepage.
- For custom heights and widths, please order size required and price as next size up. Example: 26" high, 35" wide, order BPOF2635 at \$473 Grade 1.
- Custom heights over 42" must be quoted separately.
- Overpanels can be stacked on any panel. Example: BPOF2418 stacked on BPRA4218 to give an overall height of 66".
- When stacking on 29" or 37" high B1 panels, custom height required, please contact customer service.
- Exact height should be specified when ordering, with allowance of at least 1" of free space between over panel and ceiling to accommodate height variations in ceiling and floor. Runs of over panels should be captured at either end with full height posts, wall adapters, taller panels, and/or vertical trims.
- Minimum height of 6".
- OPT* = Laminate or Whiteboard.

| PRODUCT CODE | PRICE | | | SIZE / INCHES | | | WEIGHT LBS | VOL FT ³ |
|--------------|-------|------|------|---------------|----|------|------------|---------------------|
| | GR 1 | GR 2 | OPT* | H | W | D | | |
| BPOF0818 | 182 | 199 | 212 | 8 | 18 | 2.61 | 6 | 0.351 |
| BPOF0824 | 212 | 240 | 271 | 8 | 24 | 2.61 | 6 | 0.468 |
| BPOF0830 | 252 | 281 | 312 | 8 | 30 | 2.61 | 8 | 0.730 |
| BPOF0836 | 293 | 320 | 351 | 8 | 36 | 2.61 | 10 | 0.912 |
| BPOF0842 | 323 | 351 | 382 | 8 | 42 | 2.61 | 10 | 0.912 |
| BPOF0848 | 364 | 391 | 420 | 8 | 48 | 2.61 | 12 | 1.094 |
| BPOF0854 | 406 | 434 | 464 | 8 | 54 | 2.61 | 12 | 1.094 |
| BPOF0860 | 434 | 462 | 491 | 8 | 60 | 2.61 | 14 | 1.277 |
| BPOF0866 | 473 | 534 | 595 | 8 | 66 | 2.61 | 17 | 1.549 |
| BPOF0872 | 509 | 568 | 631 | 08 | 72 | 2.61 | 20 | 1.820 |
| BPOF1618 | 241 | 259 | 271 | 16 | 18 | 2.61 | 8 | 0.730 |
| BPOF1624 | 274 | 303 | 332 | 16 | 24 | 2.61 | 8 | 0.730 |
| BPOF1630 | 313 | 342 | 372 | 16 | 30 | 2.61 | 10 | 0.912 |
| BPOF1636 | 353 | 383 | 412 | 16 | 36 | 2.61 | 12 | 1.094 |
| BPOF1642 | 385 | 415 | 446 | 16 | 42 | 2.61 | 12 | 1.094 |
| BPOF1648 | 425 | 454 | 484 | 16 | 48 | 2.61 | 14 | 1.277 |
| BPOF1654 | 465 | 494 | 523 | 16 | 54 | 2.61 | 14 | 1.277 |
| BPOF1660 | 495 | 523 | 553 | 16 | 60 | 2.61 | 15 | 1.368 |
| BPOF1666 | 521 | 580 | 645 | 16 | 66 | 2.61 | 20 | 1.774 |
| BPOF1672 | 574 | 631 | 695 | 16 | 72 | 2.61 | 24 | 2.180 |
| BPOF2418 | 333 | 347 | 364 | 24 | 18 | 2.61 | 12 | 1.094 |
| BPOF2424 | 361 | 388 | 418 | 24 | 24 | 2.61 | 14 | 1.422 |
| BPOF2430 | 389 | 418 | 449 | 24 | 30 | 2.61 | 17 | 1.750 |
| BPOF2436 | 417 | 457 | 505 | 24 | 36 | 2.61 | 18 | 2.078 |
| BPOF2442 | 446 | 486 | 535 | 24 | 42 | 2.61 | 21 | 2.406 |
| BPOF2448 | 475 | 516 | 562 | 24 | 48 | 2.61 | 22 | 2.734 |
| BPOF2454 | 501 | 528 | 561 | 24 | 54 | 2.61 | 24 | 3.063 |
| BPOF2460 | 528 | 573 | 615 | 24 | 60 | 2.61 | 27 | 3.391 |
| BPOF2466 | 569 | 627 | 692 | 24 | 66 | 2.61 | 32 | 3.766 |
| BPOF2472 | 607 | 665 | 727 | 24 | 72 | 2.61 | 36 | 4.140 |
| BPOF3718 | 378 | 408 | 438 | 37 | 18 | 2.61 | 17 | 1.580 |
| BPOF3724 | 410 | 439 | 471 | 37 | 24 | 2.61 | 19 | 2.054 |
| BPOF3730 | 441 | 483 | 527 | 37 | 30 | 2.61 | 22 | 2.528 |
| BPOF3736 | 473 | 543 | 619 | 37 | 36 | 2.61 | 24 | 3.006 |
| BPOF3742 | 501 | 573 | 647 | 37 | 42 | 2.61 | 28 | 3.476 |
| BPOF3748 | 535 | 604 | 680 | 37 | 48 | 2.61 | 30 | 3.950 |
| BPOF3754 | 563 | 633 | 711 | 37 | 54 | 2.61 | 32 | 4.424 |
| BPOF3760 | 592 | 661 | 740 | 37 | 60 | 2.61 | 34 | 4.898 |
| BPOF3766 | 661 | 783 | 909 | 37 | 66 | 2.61 | 41 | 5.449 |
| BPOF3772 | 733 | 852 | - | 37 | 72 | 2.61 | 48 | 6.000 |
| BPOF4218 | 477 | 507 | 537 | 42 | 18 | 2.61 | 18 | 1.780 |
| BPOF4224 | 509 | 567 | 626 | 42 | 24 | 2.61 | 21 | 2.310 |
| BPOF4230 | 539 | 593 | 655 | 42 | 30 | 2.61 | 24 | 2.850 |
| BPOF4236 | 569 | 639 | 715 | 42 | 36 | 2.61 | 27 | 3.390 |
| BPOF4242 | 600 | 670 | 746 | 42 | 42 | 2.61 | 30 | 3.920 |
| BPOF4248 | 630 | 699 | 778 | 42 | 48 | 2.61 | 33 | 4.460 |
| BPOF4254 | 658 | 727 | 805 | 42 | 54 | 2.61 | 36 | 4.990 |
| BPOF4260 | 691 | 761 | 837 | 42 | 60 | 2.61 | 39 | 5.250 |
| BPOF4266 | 774 | 892 | 1018 | 42 | 66 | 2.61 | 47 | 6.015 |
| BPOF4272 | 853 | 972 | - | 42 | 72 | 2.61 | 54 | 6.780 |

BPOG • Glazed Over Panel

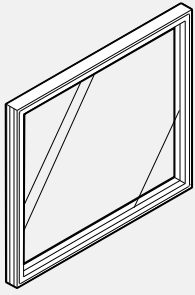

- **Attaches to top of a panel to create floor-to-ceiling wall.**
- Non-slotted.
- Factory installed PVC strip attaches and aligns over panel to top of base panel.
- PVC strip runs entire width eliminating light seepage.
- For custom heights and widths, order size required and price as next size up. Example: 26" high, 35" wide, order BPOG2635 at \$639 in acrylic.
- Custom heights over 42" must be quoted separately.
- Over panels can be stacked on any panel. Example: BPOG2418 stacked on BPRA4218 to give an overall height of 66".
- When stacking on 29" or 37" high B1 panels, custom height required, please contact customer service.
- Exact height should be specified when ordering, with allowance of at least 1" of free space between over panel and ceiling to accommodate height variations in ceiling and floor. Runs of over panels should be captured at either end with full height posts, wall adapters, taller panels, and/or vertical trims.
- Minimum height of 6".
- For tempered glass option, add "TG" to the end of the product code and 20% to the list price.

| PRODUCT CODE | PRICE | SIZE/ INCHES | | | WEIGHT LBS | VOL FT ³ |
|--------------|-------|--------------|----|------|------------|---------------------|
| | | H | W | D | | |
| BPOG0818 | 122 | 8 | 18 | 2.61 | 6 | 0.351 |
| BPOG0824 | 151 | 8 | 24 | 2.61 | 6 | 0.468 |
| BPOG0830 | 182 | 8 | 30 | 2.61 | 8 | 0.730 |
| BPOG0836 | 211 | 8 | 36 | 2.61 | 10 | 0.912 |
| BPOG0842 | 241 | 8 | 42 | 2.61 | 10 | 0.912 |
| BPOG0848 | 275 | 8 | 48 | 2.61 | 12 | 1.094 |
| BPOG0854 | 305 | 8 | 54 | 2.61 | 12 | 1.094 |
| BPOG0860 | 336 | 8 | 60 | 2.61 | 14 | 1.277 |
| BPOG0866 | 354 | 8 | 66 | 2.61 | 17 | 1.549 |
| BPOG0872 | 375 | 8 | 72 | 2.61 | 20 | 1.820 |
| BPOG1618 | 194 | 16 | 18 | 2.61 | 8 | 0.730 |
| BPOG1624 | 234 | 16 | 24 | 2.61 | 8 | 0.730 |
| BPOG1630 | 275 | 16 | 30 | 2.61 | 10 | 0.912 |
| BPOG1636 | 323 | 16 | 36 | 2.61 | 12 | 1.094 |
| BPOG1642 | 353 | 16 | 42 | 2.61 | 12 | 1.094 |
| BPOG1648 | 394 | 16 | 48 | 2.61 | 14 | 1.277 |
| BPOG1654 | 434 | 16 | 54 | 2.61 | 14 | 1.277 |
| BPOG1660 | 476 | 16 | 60 | 2.61 | 15 | 1.368 |
| BPOG1666 | 495 | 16 | 66 | 2.61 | 20 | 1.774 |
| BPOG1672 | 516 | 16 | 72 | 2.61 | 24 | 2.180 |
| BPOG2418 | 344 | 24 | 18 | 2.61 | 12 | 1.094 |
| BPOG2424 | 389 | 24 | 24 | 2.61 | 14 | 1.422 |
| BPOG2430 | 432 | 24 | 30 | 2.61 | 17 | 1.750 |
| BPOG2436 | 475 | 24 | 36 | 2.61 | 18 | 2.078 |
| BPOG2442 | 516 | 24 | 42 | 2.61 | 21 | 2.406 |
| BPOG2448 | 561 | 24 | 48 | 2.61 | 22 | 2.734 |
| BPOG2454 | 602 | 24 | 54 | 2.61 | 24 | 3.063 |
| BPOG2460 | 641 | 24 | 60 | 2.61 | 27 | 3.391 |
| BPOG2466 | 699 | 24 | 66 | 2.61 | 32 | 3.766 |
| BPOG2472 | 761 | 24 | 72 | 2.61 | 36 | 4.140 |
| BPOG3718 | 494 | 37 | 18 | 2.61 | 17 | 1.580 |
| BPOG3724 | 543 | 37 | 24 | 2.61 | 19 | 2.054 |
| BPOG3730 | 593 | 37 | 30 | 2.61 | 22 | 2.528 |
| BPOG3736 | 639 | 37 | 36 | 2.61 | 24 | 3.006 |
| BPOG3742 | 691 | 37 | 42 | 2.61 | 28 | 3.476 |
| BPOG3748 | 736 | 37 | 48 | 2.61 | 30 | 3.950 |
| BPOG3754 | 786 | 37 | 54 | 2.61 | 32 | 4.424 |
| BPOG3760 | 833 | 37 | 60 | 2.61 | 34 | 4.898 |
| BPOG3766 | 872 | 37 | 66 | 2.61 | 41 | 5.449 |
| BPOG3772 | 913 | 37 | 72 | 2.61 | 48 | 6.000 |
| BPOG4218 | 523 | 42 | 18 | 2.61 | 18 | 1.780 |
| BPOG4224 | 577 | 42 | 24 | 2.61 | 21 | 2.310 |
| BPOG4230 | 630 | 42 | 30 | 2.61 | 24 | 2.850 |
| BPOG4236 | 678 | 42 | 36 | 2.61 | 27 | 3.390 |
| BPOG4242 | 736 | 42 | 42 | 2.61 | 30 | 3.920 |
| BPOG4248 | 786 | 42 | 48 | 2.61 | 33 | 4.460 |
| BPOG4254 | 833 | 42 | 54 | 2.61 | 36 | 4.990 |
| BPOG4260 | 886 | 42 | 60 | 2.61 | 39 | 5.250 |
| BPOG4266 | 931 | 42 | 66 | 2.61 | 47 | 6.015 |
| BPOG4272 | 976 | 42 | 72 | 2.61 | 54 | 6.780 |

BAPAS • Glass Over Panel with Round Pucks for Boulevard 1

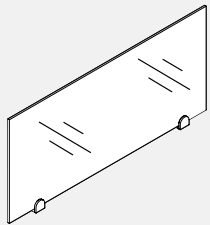

- **Glass Over Panel creates division.**
- Glass Over Panel with no frame sits on top of a Boulevard 1 Panel with clamps that are secured to the top of the panel.
- Tempered glass is 16" high.
- Custom sizes available, contact your Customer Service Representative.
- For application where the over panel is sandwiched between two taller panels, please request a special as the glass will not fit due to trims.

| PRODUCT CODE | PRICE CLR | FRST | SIZE/INCHES | | | WEIGHT LBS | VOL FT ³ |
|--------------|-----------|------|-------------|----|-----|------------|---------------------|
| | | | H | W | D | | |
| BAPAS0824 | 204 | 235 | 8 | 24 | 1.3 | 4 | 0.22 |
| BAPAS0830 | 229 | 262 | 8 | 30 | 1.3 | 5 | 0.30 |
| BAPAS0836 | 241 | 283 | 8 | 36 | 1.3 | 6 | 0.37 |
| BAPAS0842 | 262 | 306 | 8 | 42 | 1.3 | 7 | 0.43 |
| BAPAS0848 | 281 | 323 | 8 | 48 | 1.3 | 8 | 0.48 |
| BAPAS1624 | 218 | 248 | 16 | 24 | 1.3 | 8 | 0.44 |
| BAPAS1630 | 241 | 276 | 16 | 30 | 1.3 | 10 | 0.59 |
| BAPAS1636 | 260 | 299 | 16 | 36 | 1.3 | 12 | 0.73 |
| BAPAS1642 | 276 | 320 | 16 | 42 | 1.3 | 14 | 0.85 |
| BAPAS1648 | 281 | 339 | 16 | 48 | 1.3 | 16 | 0.96 |

BAPASS • Glass Over Panel with Square Pucks for Boulevard 1

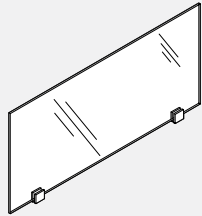

- **Glass Over Panel creates division.**
- Glass Over Panel with no frame sits on top of a Boulevard 1 Panel with clamps that are secured to the top of the panel.
- Tempered glass is 16" high.
- Custom sizes available, contact your Customer Service Representative.
- For application where the over panel is sandwiched between two taller panels, please request a special as the glass will not fit due to trims.

| PRODUCT CODE | PRICE | | SIZE/INCHES | | | WEIGHT VOL | |
|--------------|-------|------|-------------|----|-----|------------|-----------------|
| | CLR | FRST | H | W | D | LBS | FT ³ |
| BAPASS0824 | 218 | 248 | 8 | 24 | 1.3 | 4 | 0.22 |
| BAPASS0830 | 241 | 276 | 8 | 30 | 1.3 | 5 | 0.30 |
| BAPASS0836 | 262 | 299 | 8 | 36 | 1.3 | 6 | 0.37 |
| BAPASS0842 | 276 | 320 | 8 | 42 | 1.3 | 7 | 0.43 |
| BAPASS0848 | 298 | 339 | 8 | 48 | 1.3 | 8 | 0.48 |
| BAPASS1624 | 235 | 264 | 16 | 24 | 1.3 | 8 | 0.44 |
| BAPASS1630 | 260 | 291 | 16 | 30 | 1.3 | 10 | 0.59 |
| BAPASS1636 | 274 | 313 | 16 | 36 | 1.3 | 12 | 0.73 |
| BAPASS1642 | 291 | 338 | 16 | 42 | 1.3 | 14 | 0.85 |
| BAPASS1648 | 299 | 352 | 16 | 48 | 1.3 | 16 | 0.96 |

BAPAST • Felt Over Panel with Round Pucks for Boulevard 1

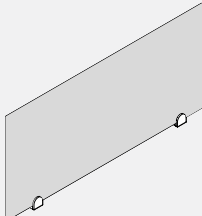

- **Felt Over Panel creates division.**
- Felt Over Panel with no frame sits on top of a Boulevard 1 panel with round clamps that are secured to the top of the panel.
- Felt panel is 8" and 16" high.
- Felt is 9mm thick, please choose from our standard 18 finishes.
- For application where the over panel is sandwiched between two taller panels, please request a special as the glass will not fit due to trims.

| PRODUCT CODE | PRICE | SIZE/INCHES | | | WEIGHT VOL | |
|--------------|-------|-------------|------|------|------------|-----------------|
| | | H | W | D | LBS | FT ³ |
| BAPAST0824 | 103 | 8 | 22.7 | 1.13 | 1.0 | 0.11 |
| BAPAST0830 | 110 | 8 | 28.7 | 1.13 | 1.1 | 0.14 |
| BAPAST0836 | 117 | 8 | 34.7 | 1.13 | 1.2 | 0.17 |
| BAPAST0842 | 129 | 8 | 40.7 | 1.13 | 1.3 | 0.20 |
| BAPAST0848 | 139 | 8 | 46.7 | 1.13 | 1.4 | 0.23 |
| BAPAST1624 | 132 | 16 | 22.7 | 1.13 | 1.4 | 0.23 |
| BAPAST1630 | 148 | 16 | 28.7 | 1.13 | 1.5 | 0.29 |
| BAPAST1636 | 170 | 16 | 34.7 | 1.13 | 1.7 | 0.35 |
| BAPAST1642 | 183 | 16 | 40.7 | 1.13 | 1.9 | 0.42 |
| BAPAST1648 | 197 | 16 | 46.7 | 1.13 | 2.0 | 0.48 |

BAPASST • Felt Over Panel with Square Pucks for Boulevard 1

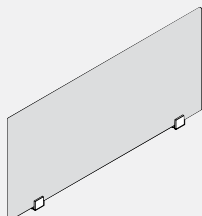

- **Felt Over Panel creates division.**
- Felt Over Panel with no frame sits on top of a Boulevard 1 panel with round clamps that are secured to the top of the panel.
- Felt panel is 8" and 16" high.
- Felt is 9mm thick, please choose from our standard 18 finishes.
- For application where the over panel is sandwiched between two taller panels, please request a special as the glass will not fit due to trims.

| PRODUCT CODE | PRICE | SIZE/INCHES | | | WEIGHT VOL | |
|--------------|-------|-------------|------|------|------------|-----------------|
| | | H | W | D | LBS | FT ³ |
| BAPASST0824 | 103 | 8 | 22.7 | 1.13 | 1.0 | 0.11 |
| BAPASST0830 | 110 | 8 | 28.7 | 1.13 | 1.1 | 0.14 |
| BAPASST0836 | 117 | 8 | 34.7 | 1.13 | 1.2 | 0.17 |
| BAPASST0842 | 129 | 8 | 40.7 | 1.13 | 1.3 | 0.20 |
| BAPASST0848 | 139 | 8 | 46.7 | 1.13 | 1.4 | 0.23 |
| BAPASST1624 | 132 | 16 | 22.7 | 1.13 | 1.4 | 0.23 |
| BAPASST1630 | 148 | 16 | 28.7 | 1.13 | 1.5 | 0.29 |
| BAPASST1636 | 170 | 16 | 34.7 | 1.13 | 1.7 | 0.35 |
| BAPASST1642 | 183 | 16 | 40.7 | 1.13 | 1.9 | 0.42 |
| BAPASST1648 | 197 | 16 | 46.7 | 1.13 | 2.0 | 0.48 |

BPDS • Solid Door Panel

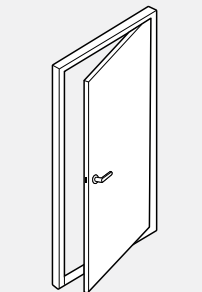

- **Aluminum frame with high pressure laminate.**
- 1 3/8" thick hollow core door.
- Actual door size:
80" x 32 1/2" in 82" x 36" frame
80" x 38 1/2" in 82" x 42" frame
- 42" wide Door Panel permits wheelchair accessibility.
- No hang-on capabilities.
- Non slotted frame.
- 180 degree swing.
- Specify Door Knob (DL01) or Door Lever (DL02).
- Lock standard.
- Handedness can be changed on site.
- Please specify Right hand (R) or Left hand (L) hung.

| PRODUCT CODE | PRICE HP | SIZE/INCHES | | | WEIGHT VOL | |
|--------------|----------|-------------|----|------|------------|-----------------|
| | | H | W | D | LBS | FT ³ |
| BPDS8236R | 2331 | 82 | 36 | 2.61 | 61 | 6.465 |
| BPDS8242R | 2539 | 82 | 42 | 2.61 | 68 | 7.486 |
| BPDS8236L | 2331 | 82 | 36 | 2.61 | 61 | 6.465 |
| BPDS8242L | 2539 | 82 | 42 | 2.61 | 68 | 7.486 |

Door Hanging Directions

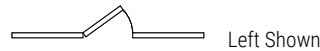

Door Handle Option

Door Knob - DL01
• Lock Standard



Door Lever - DL02(Default)

• Lock Standard
• Lever complies with all accessibility standards



BPDH • Half Glazed Door Panel

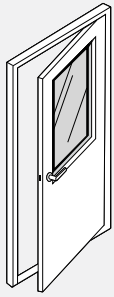

- **Aluminum frame with high pressure laminate door and window.**
- 1 3/8" thick hollow core door.
- Actual door size:
80" x 32 1/2" in 82" x 36" frame
80"x381/2" in 82"x42" frame
- 42" wide Door Panel permits wheelchair accessibility.
- No hang-on capabilities.
- 180 degree swing.
- Specify Door Knob (DL01) or Door Lever (DL02).
- Lock standard.
- Handedness can be changed on site.
- Please specify Right hand (R) or Left hand (L) hung.
- For tempered glass option, add "TG" at the end of the product code and add an upcharge of \$149 for 36" wide doors and \$179 for 42" wide doors.

| PRODUCT CODE | PRICE HP | SIZE/INCHES | | | WEIGHT VOL | |
|--------------|----------|-------------|----|------|------------|-----------------|
| | | H | W | D | LBS | FT ³ |
| BPDH8236R | 2891 | 82 | 36 | 2.61 | 53 | 6.465 |
| BPDH8242R | 3160 | 82 | 42 | 2.61 | 59 | 7.486 |
| BPDH8236L | 2891 | 82 | 36 | 2.61 | 53 | 6.465 |
| BPDH8242L | 3160 | 82 | 42 | 2.61 | 59 | 7.486 |

Door Hanging Directions

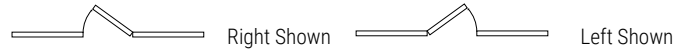

Door Handle Option

- Door Knob - DL01
- Lock Standard
- Door Lever - DL02(Default)
- Lock Standard
- Lever complies with all accessibility standards



BPDG • Solid Glazed Door Panel

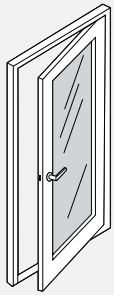

- **Aluminum frame with either high pressure laminate door and window.**
- 1 3/8" thick hollow core door.
- Actual door size:
80" x 32 1/2" in 82" x 36" frame
80"x381/2" in 82"x42" frame
- 42" wide Door Panel permits wheelchair accessibility.
- No hang-on capabilities.
- 180 degree swing.
- Specify Door Knob (DL01) or Door Lever (DL02).
- Lock standard.
- Handedness can be changed on site.
- Please specify Right hand (R) or Left hand (L) hung.
- For tempered glass option, add "TG" at the end of the product code and add an upcharge of \$302 for 36" wide doors and \$376 for 42" wide doors.
- Laminate frame is 5" thick on sides and 4" at top and bottom.

| PRODUCT CODE | PRICE HP | SIZE/INCHES | | | WEIGHT VOL | |
|--------------|----------|-------------|----|------|------------|-----------------|
| | | H | W | D | LBS | FT ³ |
| BPDG8236R | 3324 | 82 | 36 | 2.61 | 53 | 6.465 |
| BPDG8242R | 3637 | 82 | 42 | 2.61 | 59 | 7.486 |
| BPDG8236L | 3324 | 82 | 36 | 2.61 | 53 | 6.465 |
| BPDG8242L | 3637 | 82 | 42 | 2.61 | 59 | 7.486 |

Door Hanging Directions

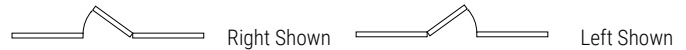

Door Handle Option

- Door Knob - DL01
- Lock Standard
- Door Lever - DL02(Default)
- Lock Standard
- Lever complies with all accessibility standards

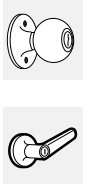

BPDSL • Privacy Screen

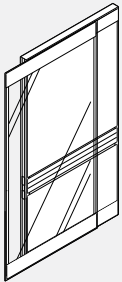

- **Provides territorial privacy in an open plan environment.**
- Lightweight, panel mounted sliding partition.
- Consists of translucent textured polycarbonate.
- Must be mounted to a straight panel of the same size.
- The face of the Privacy Screen sits 3" away from the face of the panel to which it is attached.
- Cable lay-in modules, wood trim and non-load bearing panels may be applied to the top of a panel to which the screen is attached, but not the screen itself.
- When open, the screen may interfere with access doors that open on the outside of an adjacent panel.
- Must specify left or right for the direction in which the door will slide once installed.
- Caps located on the end of the frame default to the panel frame colour.
- All hardware included.
- Can be mounted on Boulevard 1 or Boulevard System 3 panels of the same width as the Privacy Screen.
- Note: Specify left or right for the direction in which the door will slide as per examples above.

| PRODUCT CODE | PRICE | SIZE/ INCHES | | | WEIGHT VOL | |
|--------------|-------|--------------|----|------|------------|-----------------|
| | | H | W | D | LBS | FT ³ |
| BPDSL6636R | 1981 | 66 | 36 | 2.61 | 35 | 5.98 |
| BPDSL6642R | 2132 | 66 | 42 | 2.61 | 42 | 6.93 |
| BPDSL8136R | 2377 | 81 | 36 | 2.61 | 43 | 7.30 |
| BPDSL8142R | 2551 | 81 | 42 | 2.61 | 50 | 8.45 |
| BPDSL6636L | 1981 | 66 | 36 | 2.61 | 35 | 5.98 |
| BPDSL6642L | 2132 | 66 | 42 | 2.61 | 42 | 6.93 |
| BPDSL8136L | 2377 | 81 | 36 | 2.61 | 43 | 7.30 |
| BPDSL8142L | 2551 | 81 | 42 | 2.61 | 50 | 8.45 |

Left Hang Option

Right Hang Hung

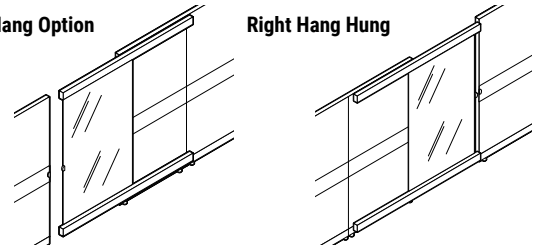

BPDSLLOCK • Privacy Screen Lock

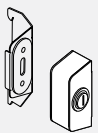

Left Hand Shown

- Lock bracket attaches to Privacy Screen with screws
- Includes strike plate bracket which attaches to slots in connector.
- Lock included.
- Available in tungsten only.
- Requires on site installation, drilling into the Privacy Screen aluminum frame.

| PRODUCT CODE | PRICE | SIZE/ INCHES | | | WEIGHT LBS | VOL FT ³ |
|--------------|-------|--------------|-----|-----|------------|---------------------|
| | | H | W | D | | |
| BPDSLLOCKR | 240 | 2.65 | 1.2 | 0.9 | 1 | 0.2 |
| BPDSLLOCKL | 240 | 2.65 | 1.2 | 0.9 | 1 | 0.2 |

BPXCF • Ceiling Filler

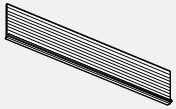

- Durable PVC designed to seal a gap between ceiling and over panel.
- Available in lengths of 124" to be pressed into over panel's horizontal wing profile.
- Can be applied during installation or retrofitted later.
- For use only with Boulevard 1 panels.

| PRODUCT CODE | PRICE | SIZE/INCHES | | | WEIGHT VOL | |
|--------------|-------|-------------|-----|-------|------------|-----|
| | | H | W | D | LBS | FT³ |
| BPXCF124 | 65 | 3.25 | 124 | 0.125 | 1 | 1.2 |

BHP • 90 Degree Post

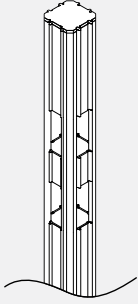

- Enables connection for multiple panel runs such as 90 degree, 3 way and 4 way.
- Includes 2 "Capture Strip" panel connectors, 4 end strips, 4 pairs of raceway end caps, and 1 post cap.
- Posts are designed to accept the following:
 - 75 cables 5.6mm (0.220") diameter with 1 powerfeed
 - 60 cables 5.6mm (0.220") diameter with 2 powerfeeds
 - 45 cables 5.6mm (0.220") diameter with 2 powerfeeds

| PRODUCT CODE | PRICE | SIZE/INCHES | | | WEIGHT VOL | |
|--------------|-------|-------------|------|------|------------|-------|
| | | H | W | D | LBS | FT³ |
| BHP029 | 81 | 29 | 2.61 | 2.61 | 4 | 0.154 |
| BHP037 | 132 | 37 | 2.61 | 2.61 | 5 | 0.195 |
| BHP042 | 145 | 42 | 2.61 | 2.61 | 5 | 0.221 |
| BHP050 | 162 | 50 | 2.61 | 2.61 | 6 | 0.263 |
| BHP054 | 170 | 54 | 2.61 | 2.61 | 6 | 0.284 |
| BHP058 | 178 | 58 | 2.61 | 2.61 | 7 | 0.305 |
| BHP066 | 195 | 66 | 2.61 | 2.61 | 8 | 0.346 |
| BHP074 | 211 | 74 | 2.61 | 2.61 | 9 | 0.388 |
| BHP082 | 228 | 82 | 2.61 | 2.61 | 9 | 0.430 |
| BHP106 | 272 | 106 | 2.61 | 2.61 | 12 | 0.560 |
| BHP119 | 291 | 119 | 2.61 | 2.61 | 13 | 0.622 |

BHP45 • 45 Degree Post

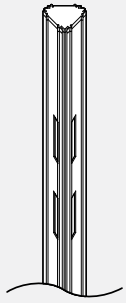

- Enables connection for two panels at 45 degrees.
- Includes 2 "Capture Strip" panel connectors, 4 end strips, 2 pairs of raceway end caps, and 1 post cap.
- 45 degree post does not accept PVC or Wood End Trim.
- No power infeed/post extension capabilities.
- Posts are designed to accept 30 cables 5.6mm (0.220") diameter

| PRODUCT CODE | PRICE | SIZE/INCHES | | | WEIGHT VOL | |
|--------------|-------|-------------|------|------|------------|-------|
| | | H | W | D | LBS | FT³ |
| BHP4529 | 81 | 29 | 2.61 | 2.61 | 4 | 0.154 |
| BHP4537 | 132 | 37 | 2.61 | 2.61 | 5 | 0.195 |
| BHP4542 | 145 | 42 | 2.61 | 2.61 | 5 | 0.221 |
| BHP4550 | 162 | 50 | 2.61 | 2.61 | 6 | 0.263 |
| BHP4554 | 170 | 54 | 2.61 | 2.61 | 6 | 0.284 |
| BHP4558 | 178 | 58 | 2.61 | 2.61 | 7 | 0.305 |
| BHP4566 | 195 | 66 | 2.61 | 2.61 | 8 | 0.346 |
| BHP4574 | 211 | 74 | 2.61 | 2.61 | 9 | 0.388 |
| BHP4582 | 228 | 82 | 2.61 | 2.61 | 9 | 0.430 |
| BHP45106 | 272 | 106 | 2.61 | 2.61 | 12 | 0.560 |
| BHP45119 | 291 | 119 | 2.61 | 2.61 | 13 | 0.622 |

BHP60 • 60 Degree Post

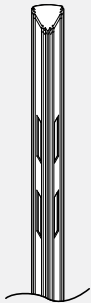

- Enables connection for multiple panel runs such as 120 degrees and 3 way.
- Includes 2 "Capture Strip" panel connectors, 4 end strips, 3 pair of raceway end caps, and 1 post cap.
- No power infeed/post extension capabilities.

| PRODUCT CODE | PRICE | SIZE/INCHES | | | WEIGHT VOL | |
|--------------|-------|-------------|------|------|------------|-------|
| | | H | W | D | LBS | FT³ |
| BHP6029 | 81 | 29 | 2.61 | 2.61 | 4 | 0.154 |
| BHP6037 | 132 | 37 | 2.61 | 2.61 | 5 | 0.195 |
| BHP6042 | 145 | 42 | 2.61 | 2.61 | 5 | 0.221 |
| BHP6050 | 162 | 50 | 2.61 | 2.61 | 6 | 0.263 |
| BHP6054 | 170 | 54 | 2.61 | 2.61 | 6 | 0.284 |
| BHP6058 | 178 | 58 | 2.61 | 2.61 | 7 | 0.305 |
| BHP6066 | 195 | 66 | 2.61 | 2.61 | 8 | 0.346 |
| BHP6074 | 211 | 74 | 2.61 | 2.61 | 9 | 0.388 |
| BHP6082 | 228 | 82 | 2.61 | 2.61 | 9 | 0.430 |
| BHP60106 | 272 | 106 | 2.61 | 2.61 | 12 | 0.560 |
| BHP60119 | 291 | 119 | 2.61 | 2.61 | 13 | 0.622 |

BHWA • Wall Adapter

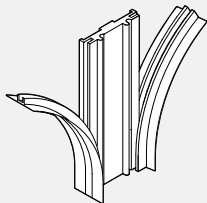

- Starts a run of panels off an existing wall.
- Includes 2 "Capture Strip" panel connectors and 1 pair of raceway end caps.
- Mounting hardware not included. The mounting hardware selected must be based on the wall or wall stud material.
- Wall adapter adds 5/16" to a panel run.

| PRODUCT CODE | PRICE | SIZE/INCHES | | | WEIGHT VOL | |
|--------------|-------|-------------|------|-------|------------|-------|
| | | H | W | D | LBS | FT³ |
| BHWA029 | 57 | 29 | 2.61 | 0.375 | 4 | 0.01 |
| BHWA037 | 60 | 37 | 2.61 | 0.375 | 5 | 0.013 |
| BHWA042 | 64 | 42 | 2.61 | 0.375 | 5 | 0.015 |
| BHWA050 | 68 | 50 | 2.61 | 0.375 | 6 | 0.018 |
| BHWA054 | 72 | 54 | 2.61 | 0.375 | 6 | 0.020 |
| BHWA058 | 74 | 58 | 2.61 | 0.375 | 7 | 0.021 |
| BHWA066 | 80 | 66 | 2.61 | 0.375 | 8 | 0.024 |
| BHWA074 | 90 | 74 | 2.61 | 0.375 | 9 | 0.027 |
| BHWA082 | 93 | 82 | 2.61 | 0.375 | 9 | 0.030 |
| BHWA106 | 119 | 106 | 2.61 | 0.375 | 12 | 0.039 |
| BHWA119 | 137 | 119 | 2.61 | 0.375 | 13 | 0.043 |

BHWASL • Adapter Sleeve

- **Wall Adapter Sleeve is attached to the building to provide flexible support to a panel run.**
- As opposed to the BHWA wall adapter, which connects to the panels securely to a wall, B1 and B3 Boulevard panels rest inside the vertical "U" channel, providing up to 3.5" of flexible adjustment.
- For panel runs taller than 66" order two Wall Adapter Sleeve and either have them cut short on site below the ceiling, or cut a rectangular hole in the ceiling tile. Rectangular slots in the Channels correspond to 66", 58", 50" and 42" high B1 and B3 panels.
- Powder coated steel; specify metal finish.
- Note: the Wall Adapter Sleeve provides flexible, connection, blocks vertical 1" increment clots and cannot, therefore, be used to support overheads and worksurfaces, they must be supported by perpendicular panels, c-legs or gables.
- Note: No fasteners are provided with the Wall Adapter Sleeve. Select the appropriate fasteners according to a structurally wall type.
- Cannot be used to support a door or panel and cannot be used with laminate, airflow or metal skin panels.

| PRODUCT CODE | PRICE | SIZE/ INCHES | | | WEIGHT VOL | |
|--------------|-------|--------------|---|---|------------|-----------------|
| | | H | W | D | LBS | FT ³ |
| BHWASL42 | 149 | 34.7 | 4 | 2 | 2.5 | 0.161 |
| BHWASL50 | 162 | 42.7 | 4 | 2 | 3.6 | 0.198 |
| BHWASL54 | 170 | 46.7 | 4 | 2 | 4.2 | 0.220 |
| BHWASL58 | 174 | 50.7 | 4 | 2 | 5.1 | 0.244 |
| BHWASL66 | 187 | 58.7 | 4 | 2 | 6.0 | 0.272 |

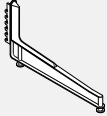
BHHF • High Profile Foot

- **Provides added support to panel under load.**
- Adjustable glides included.
- Made of cast aluminum and cold rolled steel.
- Cannot be used with System 3 Panels

| PRODUCT CODE | PRICE | SIZE/INCHES | | | WEIGHT VOL | |
|--------------|-------|-------------|---|--------|------------|-----------------|
| | | H | W | D | LBS | FT ³ |
| BHHF01 | 229 | 9 | 1 | 18.375 | 4 | 0.130 |

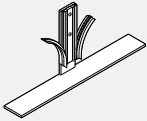
BHLF • Low Profile Foot

- **Stabilizes a run of panels.**
- Attaches with supplied connectors to an end of a panel.
- Made of cold rolled steel.
- Cannot be used with System 3 Panels

| PRODUCT CODE | PRICE | SIZE/ INCHES | | | WEIGHT VOL | |
|--------------|-------|--------------|---|-----|------------|-----------------|
| | | H | W | D | LBS | FT ³ |
| BHLF01 | 54 | 6 | 9 | 2.5 | 7 | 0.230 |

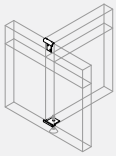
BHPA • Panel to Panel Adapter

- **Enables mid panel, off-module connection.**
- Slim profile.
- Formed steel construction.
- Permanent clamps fit around base channel and fits to top rail.
- Priced as a complete kit.
- Designed for use with Boulevard 1 panels of the same height only.
- Not to be used on the panel seam, with over panels or laminate and metal faced panels.

| PRODUCT CODE | PRICE | SIZE/ INCHES | | | WEIGHT VOL | |
|--------------|-------|--------------|-----|------|------------|-----------------|
| | | H | W | D | LBS | FT ³ |
| BHPA02 | 54 | 2 | 2.5 | 00.0 | 0.25 | 0.120 |

BHCS • Capture Strip Slot Cover

- **An extruded PVC channel to adjoin two panels or a panel to a post. Runs the full length of the panel on both sides providing a positive connection of the "Knuckle-Loc" design.**
- Priced per pair.
- Pliable side membranes cover panel slots.
- Included with panel components.
- Only to be ordered separately if required.

| PRODUCT CODE | PRICE | SIZE/ INCHES | | | WEIGHT VOL | |
|--------------|-------|--------------|--------|--|------------|-----------------|
| | | H | INCHES | | LBS | FT ³ |
| BHCS29 | 12 | 29 | | | 0.21 | 0.09 |
| BHCS37 | 13 | 37 | | | 0.24 | 0.11 |
| BHCS42 | 13 | 42 | | | 0.28 | 0.13 |
| BHCS50 | 14 | 50 | | | 0.33 | 0.15 |
| BHCS54 | 14 | 54 | | | 0.31 | 0.17 |
| BHCS58 | 16 | 58 | | | 0.63 | 0.19 |
| BHCS66 | 21 | 66 | | | 0.40 | 0.19 |
| BHCS74 | 22 | 74 | | | 0.43 | 0.20 |
| BHCS82 | 24 | 82 | | | 0.47 | 0.20 |

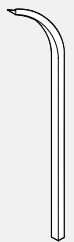
BHCE • End Strip Slot Cover

- **End strips with pliable side membrane covers panel slots at end of run.**
- Priced per pair.
- Included with panel components.
- Only to be ordered separately if required.

| PRODUCT CODE | PRICE | SIZE/ INCHES | | | WEIGHT VOL | |
|--------------|-------|--------------|--------|--|------------|-----------------|
| | | H | INCHES | | LBS | FT ³ |
| BHCE29 | 11 | 29 | | | 0.10 | 0.04 |
| BHCE37 | 12 | 37 | | | 0.12 | 0.05 |
| BHCE42 | 12 | 42 | | | 0.14 | 0.06 |
| BHCE50 | 13 | 50 | | | 0.16 | 0.07 |
| BHCE54 | 13 | 54 | | | 0.31 | 0.08 |
| BHCE58 | 13 | 58 | | | 0.18 | 0.08 |
| BHCE66 | 14 | 66 | | | 0.20 | 0.09 |
| BHCE74 | 16 | 74 | | | 0.22 | 0.10 |
| BHCE82 | 21 | 82 | | | 0.23 | 0.11 |

BHRC • Raceway End Cap

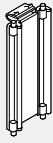

- Provides clean detail at the end of a panel run or post. End caps fit flush into communication and power channel entry.
- Priced per pair.
- Made of injection molded ABS.
- Included with panel components. Only to be ordered separately if required.

| PRODUCT CODE | PRICE | SIZE/ INCHES | | | WEIGHT VOL | |
|--------------|-------|--------------|------|-----|------------|-----------------|
| | | H | W | D | LBS | FT ³ |
| BHRC02 | 10 | 3 | 2.61 | 0.5 | 0.04 | 0.02 |

BVTE • Vertical End PVC Trim



- Provides a rounded finished detail to the end of the panel run, or a post.
- Includes 2 "Capture Strip" panel connectors and 1 injection molded top cap.
- The PVC end trim is designed to snap at the end of the panel or post.
- Site installed.

| PRODUCT CODE | PRICE | SIZE/ INCHES | | | WEIGHT VOL | |
|--------------|-------|--------------|------|------|------------|-----------------|
| | | H | W | D | LBS | FT ³ |
| BVTE37 | 42 | 37 | 2.61 | 0.25 | 0.41 | 0.065 |
| BVTE42 | 49 | 42 | 2.61 | 0.25 | 0.48 | 0.074 |
| BVTE50 | 56 | 50 | 2.61 | 0.25 | 0.57 | 0.088 |
| BVTE54 | 70 | 54 | 2.61 | 0.25 | 0.62 | 0.095 |
| BVTE58 | 77 | 58 | 2.61 | 0.25 | 0.66 | 0.102 |
| BVTE66 | 80 | 66 | 2.61 | 0.25 | 0.75 | 0.115 |
| BVTE74 | 85 | 74 | 2.61 | 0.25 | 0.84 | 0.013 |
| BVTE82 | 92 | 82 | 2.61 | 0.25 | 0.93 | 0.143 |

BVTS • Vertical Step Down PVC Trim



- Provides a rounded finished detail to the end of the panel run where two different height panels are specified.
- Includes 2 "Capture Strip" panel connectors and 1 injection molded top cap.
- The PVC end trim is designed to snap at the end of the panel or post.
- Site installed.
- Please specify panels to be used when ordering a 29" step (BVTS29).

| PRODUCT CODE | PRICE | SIZE/ INCHES | | | WEIGHT VOL | |
|--------------|-------|--------------|------|------|------------|-----------------|
| | | H | W | D | LBS | FT ³ |
| BVTS04 | 12 | 4 | 2.61 | 0.25 | 0.05 | 0.010 |
| BVTS08 | 14 | 8 | 2.61 | 0.25 | 0.09 | 0.015 |
| BVTS12 | 21 | 12 | 2.61 | 0.25 | 0.12 | 0.021 |
| BVTS16 | 29 | 16 | 2.61 | 0.25 | 0.18 | 0.029 |
| BVTS20 | 31 | 20 | 2.61 | 0.25 | 0.20 | 0.035 |
| BVTS24 | 34 | 24 | 2.61 | 0.25 | 0.27 | 0.043 |
| BVTS32 | 38 | 32 | 2.61 | 0.25 | 0.36 | 0.056 |
| BVTS38 | 45 | 38 | 2.61 | 0.25 | 0.45 | 0.067 |
| BVTS40 | 47 | 40 | 2.61 | 0.25 | 0.45 | 0.070 |
| BVTS48 | 55 | 48 | 2.61 | 0.25 | 0.54 | 0.084 |
| BVTS56 | 65 | 56 | 2.61 | 0.25 | 0.63 | 0.098 |

BVTS • Vertical Step Down PVC Trim for 37" High Panels



- Provides a finished detail to the end of the panel run that sits next to a 37" high panel. This PVC trim will bridge the distance between the 37" and higher panel.
- Includes 2 "Capture Strip" panel connectors and 1 injection molded top cap.
- The PVC end trim is designed to snap at the end of the panel or post.
- Site installed.
- Please specify panels to be used when ordering a 29" step (BVTS29).

| PRODUCT CODE | PRICE | SIZE/ INCHES | | | WEIGHT VOL | |
|--------------|-------|--------------|------|------|------------|-----------------|
| | | H | W | D | LBS | FT ³ |
| BVTS05 | 12 | 5 | 2.61 | 0.25 | 0.06 | 0.015 |
| BVTS13 | 21 | 13 | 2.61 | 0.25 | 0.15 | 0.029 |
| BVTS17 | 30 | 17 | 2.61 | 0.25 | 0.15 | 0.035 |
| BVTS21 | 32 | 21 | 2.61 | 0.25 | 0.24 | 0.043 |
| BVTS29 | 35 | 29 | 2.61 | 0.25 | 0.33 | 0.051 |
| BVTS37 | 44 | 37 | 2.61 | 0.25 | 0.41 | 0.067 |
| BVTS45 | 48 | 45 | 2.61 | 0.25 | 0.51 | 0.084 |

BAVTE • Aluminum Vertical End Round Trim

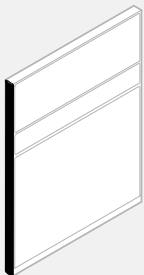

- Provides a finished detail to the end of a panel run.
- Aluminum radiused front section and injection molded top cap.
- Includes 2 "Capture Strip" panel connectors and 1 injection molded top cap.
- The Aluminum End Trim is designed to snap at the end of the panel or post.
- Site installed.
- BAVTE119 cannot ship via courier and must be combined with other product.

| PRODUCT CODE | PRICE | SIZE/ INCHES | | | WEIGHT VOL | |
|--------------|-------|--------------|------|-------|------------|-----------------|
| | | H | W | D | LBS | FT ³ |
| BAVTE37 | 44 | 37 | 2.61 | 0.125 | 1.2 | 0.03 |
| BAVTE42 | 49 | 42 | 2.61 | 0.125 | 1.4 | 0.03 |
| BAVTE50 | 56 | 50 | 2.61 | 0.125 | 1.7 | 0.04 |
| BAVTE54 | 70 | 54 | 2.61 | 0.125 | 1.8 | 0.04 |
| BAVTE58 | 77 | 58 | 2.61 | 0.125 | 1.9 | 0.04 |
| BAVTE66 | 80 | 66 | 2.61 | 0.125 | 2.2 | 0.05 |
| BAVTE74 | 85 | 74 | 2.61 | 0.125 | 2.4 | 0.05 |
| BAVTE82 | 92 | 82 | 2.61 | 0.125 | 2.7 | 0.06 |
| BAVTE119 | 137 | 119 | 2.61 | 0.125 | 3.9 | 0.08 |

BAVTS • Aluminum Vertical End Round Trim - Standard Step Down

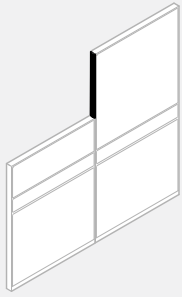

- Provides a finished detail to the end of a panel run where two different height panels are specified.
- Aluminum radiused front section and injection molded top cap.
- Includes 2 "Capture Strip" panel connectors and 1 injection molded top cap.
- The Aluminum End Trim is designed to snap at the end of the panel or post.
- Site installed.
- Specify panels to be used when ordering a 29" step.

| PRODUCT CODE | PRICE | SIZE/ INCHES | | | WEIGHT VOL | |
|--------------|-------|--------------|------|-------|------------|-----------------|
| | | H | W | D | LBS | FT ³ |
| BAVTS04 | 12 | 4 | 2.61 | 0.125 | 0.2 | 0.01 |
| BAVTS08 | 14 | 8 | 2.61 | 0.125 | 0.3 | 0.02 |
| BAVTS12 | 21 | 12 | 2.61 | 0.125 | 0.4 | 0.02 |
| BAVTS16 | 29 | 16 | 2.61 | 0.125 | 0.5 | 0.03 |
| BAVTS20 | 31 | 20 | 2.61 | 0.125 | 0.7 | 0.04 |
| BAVTS24 | 34 | 24 | 2.61 | 0.125 | 0.8 | 0.04 |
| BAVTS32 | 38 | 32 | 2.61 | 0.125 | 1.1 | 0.06 |
| BAVTS38 | 45 | 38 | 2.61 | 0.125 | 1.3 | 0.07 |
| BAVTS40 | 46 | 40 | 2.61 | 0.125 | 1.3 | 0.07 |
| BAVTS48 | 55 | 48 | 2.61 | 0.125 | 1.6 | 0.08 |
| BAVTS56 | 65 | 56 | 2.61 | 0.125 | 1.8 | 0.10 |

BAVTSF • Aluminum Vertical End Round Trim - Step Down for 37" High Panels

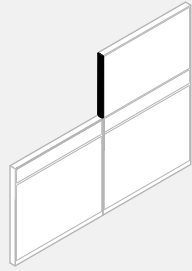

- Provides a finished detail to the end of a panel run adjacent to a 37" high panel.
- Aluminum radiused front section and injection molded top cap.
- Includes 2 "Capture Strip" panel connectors and 1 injection molded top cap.
- The Aluminum End Trim is designed to snap at the end of the panel or post.
- Site installed.

| PRODUCT CODE | PRICE | SIZE/ INCHES | | | WEIGHT VOL | |
|--------------|-------|--------------|------|-------|------------|-----------------|
| | | H | W | D | LBS | FT ³ |
| BAVTSF05 | 13 | 5 | 2.61 | 0.125 | 0.2 | 0.02 |
| BAVTSF13 | 22 | 13 | 2.61 | 0.125 | 0.4 | 0.03 |
| BAVTSF17 | 30 | 17 | 2.61 | 0.125 | 0.6 | 0.04 |
| BAVTSF21 | 32 | 21 | 2.61 | 0.125 | 0.7 | 0.04 |
| BAVTSF29 | 35 | 29 | 2.61 | 0.125 | 1.0 | 0.05 |
| BAVTSF37 | 44 | 37 | 2.61 | 0.125 | 1.2 | 0.07 |
| BAVTSF45 | 53 | 45 | 2.61 | 0.125 | 1.5 | 0.08 |

BARC • Aluminum Raceway Cover

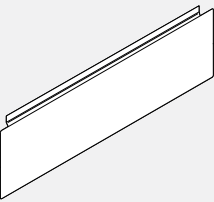

- Offers an alternative to the existing raceway options.
- Cover hinges upward for easy access to power and data/communication terminals.
- Cover may be removed for installation and reconfiguration.
- May not be used with Boulevard System 3 panels.
- Sold as singles.

| PRODUCT CODE | PRICE | SIZE/ INCHES | | | WEIGHT VOL | |
|--------------|-------|--------------|----|-------|------------|-----------------|
| | | H | W | D | LBS | FT ³ |
| BARC06 | 25 | 00.0 | 5 | 0.125 | 0.3 | 0.001 |
| BARC18 | 27 | 00.0 | 17 | 0.125 | 1.1 | 0.001 |
| BARC24 | 32 | 00.0 | 23 | 0.125 | 1.4 | 0.001 |
| BARC30 | 35 | 00.0 | 29 | 0.125 | 1.8 | 0.002 |
| BARC36 | 37 | 00.0 | 35 | 0.125 | 2.2 | 0.002 |
| BARC42 | 40 | 00.0 | 41 | 0.125 | 2.5 | 0.002 |
| BARC48 | 42 | 00.0 | 47 | 0.125 | 2.9 | 0.003 |
| BARC54 | 48 | 00.0 | 53 | 0.125 | 3.2 | 0.003 |
| BARC60 | 58 | 00.0 | 59 | 0.125 | 3.7 | 0.003 |
| BARC66 | 63 | 00.0 | 65 | 0.125 | 4.1 | 0.004 |
| BARC72 | 67 | 00.0 | 72 | 0.125 | 4.4 | 0.004 |

Boulevard 1 • Flat Aluminum Trims

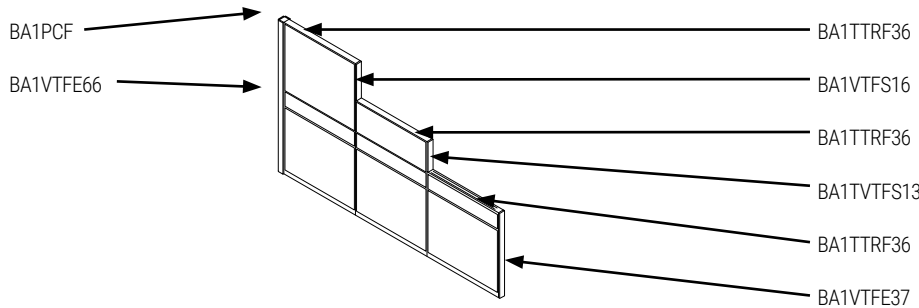

- Flat Aluminum Trims For Boulevard 1: Designed to use top and vertical trims together on the panel. Specifying vertical trims only will make them too long and will not fit correctly.
- You must specify vertical trims as a special if you are NOT using top trims.
- Post caps BA1PCF must be specified separately when using trims, .

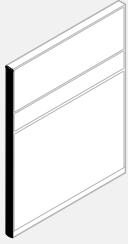
BA1VTFE • Aluminum Vertical Flat End Trim

- Provides a finish detail to the end of a panel run.
- Aluminum flat profile with injection molded top cap.
- Included: 2 "capture strip" panel connectors and 1 injection molded top cap.
- The Aluminum End Trim is designed to snap at the end of the panel or post.
- Site installed.
- For use with Aluminum Top Caps.

| PRODUCT CODE | PRICE | SIZE/ INCHES | | | WEIGHT VOL | |
|--------------|-------|--------------|------|-------|------------|-----------------|
| | | H | W | D | LBS | FT ³ |
| BA1VTFE29 | 36 | 29 | 2.61 | 0.125 | 0.7 | 0.01 |
| BA1VTFE37 | 44 | 37 | 2.61 | 0.125 | 1.0 | 0.02 |
| BA1VTFE42 | 49 | 42 | 2.61 | 0.125 | 1.2 | 0.03 |
| BA1VTFE50 | 56 | 50 | 2.61 | 0.125 | 1.5 | 0.04 |
| BA1VTFE54 | 70 | 54 | 2.61 | 0.125 | 1.6 | 0.04 |
| BA1VTFE58 | 77 | 58 | 2.61 | 0.125 | 1.7 | 0.04 |
| BA1VTFE66 | 80 | 66 | 2.61 | 0.125 | 2.0 | 0.05 |
| BA1VTFE74 | 85 | 74 | 2.61 | 0.125 | 2.2 | 0.05 |
| BA1VTFE82 | 92 | 82 | 2.61 | 0.125 | 2.4 | 0.06 |

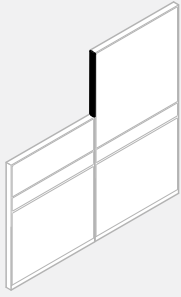
BA1VTFS • Aluminum Vertical Flat End Trim - Standard Step Down

- Provides a finish detail to the end of a panel run where 2 different height panels are specified.
- Aluminum flat profile with injection molded top cap.
- Included: 2 "capture strip" panel connectors and 1 injection molded top cap.
- The aluminum end trim is designed to snap at the end of the panel or post.
- Site installed.
- For use with Aluminum Top Caps.

| PRODUCT CODE | PRICE | SIZE/ INCHES | | | WEIGHT VOL | |
|--------------|-------|--------------|------|-------|------------|-----------------|
| | | H | W | D | LBS | FT ³ |
| BA1VTFS04 | 12 | 4 | 2.61 | 0.125 | 0.1 | 0.01 |
| BA1VTFS08 | 14 | 8 | 2.61 | 0.125 | 0.2 | 0.01 |
| BA1VTFS12 | 21 | 12 | 2.61 | 0.125 | 0.4 | 0.02 |
| BA1VTFS16 | 29 | 16 | 2.61 | 0.125 | 0.6 | 0.02 |
| BA1VTFS20 | 31 | 20 | 2.61 | 0.125 | 0.6 | 0.03 |
| BA1VTFS24 | 34 | 24 | 2.61 | 0.125 | 0.7 | 0.03 |
| BA1VTFS32 | 38 | 32 | 2.61 | 0.125 | 0.9 | 0.03 |
| BA1VTFS38 | 45 | 38 | 2.61 | 0.125 | 1.1 | 0.03 |
| BA1VTFS40 | 47 | 40 | 2.61 | 0.125 | 1.1 | 0.03 |
| BA1VTFS48 | 56 | 48 | 2.61 | 0.125 | 1.3 | 0.04 |
| BA1VTFS56 | 65 | 56 | 2.61 | 0.125 | 1.6 | 0.05 |

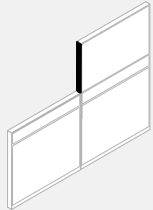
BA1VTFS • Aluminum Vertical Flat End Trim - Standard Step Down 37" High Panels

- Provides a finish detail to the end of a panel run adjacent to a 37" high panel.
- Aluminum flat profile with injection molded top cap
- Included 2 "capture strip" panel connectors and 1 injection molded top cap
- The aluminum end trim is designed to snap at the end of the panel or post
- Site installed
- Specify panels to be used when ordering a 29" step down trim.
- For use with Aluminum Top Caps.

| PRODUCT CODE | PRICE | SIZE/ INCHES | | | WEIGHT VOL | |
|--------------|-------|--------------|------|-------|------------|-----------------|
| | | H | W | D | LBS | FT ³ |
| BA1VTFS05 | 13 | 5 | 2.61 | 0.125 | 0.2 | 0.01 |
| BA1VTFS13 | 22 | 13 | 2.61 | 0.125 | 0.4 | 0.01 |
| BA1VTFS17 | 30 | 17 | 2.61 | 0.125 | 0.4 | 0.01 |
| BA1VTFS21 | 32 | 21 | 2.61 | 0.125 | 0.6 | 0.02 |
| BA1VTFS29 | 35 | 19 | 2.61 | 0.125 | 0.7 | 0.03 |
| BA1VTFS37 | 44 | 37 | 2.61 | 0.125 | 1.1 | 0.03 |
| BA1VTFS45 | 53 | 45 | 2.61 | 0.125 | 1.3 | 0.04 |

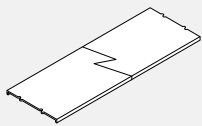
BA1TTRF • Aluminum Top Cap

- Provides a finish detail to the top of a Boulevard 1 panel.
- Designed to snap to the top of a panel rail.
- Must be used on panels of corresponding width.
- Site installed.
- For applications using transaction tops and top mounted storage, please use BHBT02FT bracket
- To be used with Flat Vertical Trim.

| PRODUCT CODE | PRICE | SIZE/ INCHES | | | WEIGHT VOL | |
|--------------|-------|--------------|----|------|------------|-----------------|
| | | H | W | D | LBS | FT ³ |
| BA1TTRF06 | 13 | 0.125 | 6 | 2.61 | 0.2 | 0.01 |
| BA1TTRF18 | 30 | 0.125 | 18 | 2.61 | 0.6 | 0.02 |
| BA1TTRF24 | 34 | 0.125 | 24 | 2.61 | 0.7 | 0.03 |
| BA1TTRF30 | 36 | 0.125 | 30 | 2.61 | 0.9 | 0.04 |
| BA1TTRF36 | 43 | 0.125 | 36 | 2.61 | 1.1 | 0.05 |
| BA1TTRF42 | 49 | 0.125 | 42 | 2.61 | 1.3 | 0.06 |
| BA1TTRF48 | 57 | 0.125 | 48 | 2.61 | 1.5 | 0.06 |
| BA1TTRF54 | 70 | 0.125 | 54 | 2.61 | 1.6 | 0.07 |
| BA1TTRF60 | 77 | 0.125 | 60 | 2.61 | 1.8 | 0.08 |
| BA1TTRF66 | 80 | 0.125 | 66 | 2.61 | 2.0 | 0.09 |
| BA1TTRF72 | 85 | 0.125 | 72 | 2.61 | 2.2 | 0.10 |

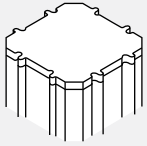
BA1PCF • Post Cap

- Bridges the height difference when using Boulevard 1 panels only with Aluminum Horizontal Top Trims.
- Injection molded post cap to fit on top of 90 degree corner post.
- Extends post's overall height to the level corresponding with the height of aluminum horizontal top trim installed on standard Boulevard panel.
- Site installed.
- Used for Boulevard 1 panels when top aluminum horizontal trim is used.

| PRODUCT CODE | PRICE | SIZE/ INCHES | | | WEIGHT VOL | |
|--------------|-------|--------------|------|------|------------|-----------------|
| | | H | W | D | LBS | FT ³ |
| BA1PCF | 10 | 0.25 | 2.61 | 2.61 | 0.02 | 0.01 |

BHBT37FT • Transaction Bracket for 37" Panels with Flat Trim

- Provides a secure attachment of a transaction worksurface for a 37" high panel with top trim.
- Includes a left and right bracket and bracket retainer clips.

| PRODUCT CODE | PRICE | SIZE/ INCHES | | | WEIGHT VOL | |
|--------------|-------|--------------|-----|-----|------------|-----------------|
| | | H | W | D | LBS | FT ³ |
| BHBT37FT | 26 | 3.3 | 1.5 | 2.3 | 2.0 | 0.010 |

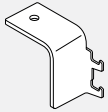
BHBT02FT • Transaction Bracket for 42" Panels with Flat Trim

- Provides a secure attachment of a transaction worksurface for a 42" high Boulevard panels with flat trim.
- Includes a left and right bracket and bracket retainer clips.

| PRODUCT CODE | PRICE | SIZE/ INCHES | | | WEIGHT VOL | |
|--------------|-------|--------------|---|---|------------|-----------------|
| | | H | W | D | LBS | FT ³ |
| BHBT02FT | 31 | 4 | 1 | 3 | 0.5 | 0.007 |

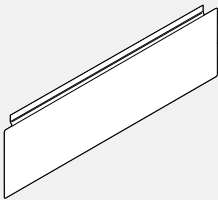
FRC • Fabric Raceway Cover

- Offers an alternative to the existing raceway options.
- Cover hinges upward for easy access to power and data/communication terminals.
- Cover may be removed for installation and reconfiguration.
- May not be used with Boulevard System 3 panels.
- Sold as singles.

| PRODUCT CODE | PRICE | SIZE/ INCHES | | | WEIGHT VOL | |
|--------------|-------|--------------|----|-------|------------|-----------------|
| | | H | W | D | LBS | FT ³ |
| FRC24 | 29 | 7 | 23 | 0.125 | 1.4 | 0.001 |
| FRC30 | 35 | 7 | 29 | 0.125 | 1.8 | 0.002 |
| FRC36 | 37 | 7 | 35 | 0.125 | 2.2 | 0.002 |
| FRC42 | 40 | 7 | 41 | 0.125 | 2.5 | 0.002 |
| FRC48 | 42 | 7 | 47 | 0.125 | 2.9 | 0.003 |
| FRC54 | 52 | 7 | 53 | 0.125 | 3.2 | 0.003 |
| FRC60 | 55 | 7 | 59 | 0.125 | 3.7 | 0.003 |
| FRC66 | 58 | 7 | 65 | 0.125 | 4.1 | 0.004 |
| FRC72 | 60 | 7 | 72 | 0.125 | 4.4 | 0.004 |

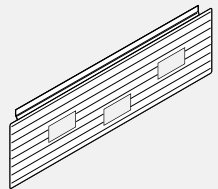
RCW-D • PVC Facemount Raceway Cover

- PVC raceway cover is punched out to align with the Face Mount Power Distribution Housing and Duplexes.
- Data punch-out accepts industry standard terminal faceplates (not supplied by Global Contract Inc.) Size of opening is 1.37" x 2.755".
- Electrical cut-outs have black PVC trim. Size of opening is 1.5" x 2.85".
- May not be used with Boulevard System 3 Panels.
- Cover hinges upward for easy access to power and data/communication terminals.

| PRODUCT CODE | PRICE | SIZE/ INCHES | | | WEIGHT VOL | |
|--------------|-------|--------------|----|-------|------------|-----------------|
| | | H | W | D | LBS | FT ³ |
| RCW24D | 36 | 7 | 24 | 0.125 | 3 | 0.05 |
| RCW30D | 38 | 7 | 30 | 0.125 | 3 | 0.06 |
| RCW36D | 43 | 7 | 36 | 0.125 | 4 | 0.07 |
| RCW42D | 53 | 7 | 42 | 0.125 | 5 | 0.08 |
| RCW48D | 57 | 7 | 48 | 0.125 | 5 | 0.09 |
| RCW54D | 60 | 7 | 54 | 0.125 | 6 | 0.10 |
| RCW60D | 64 | 7 | 60 | 0.125 | 7 | 0.11 |
| RCW66D | 67 | 7 | 66 | 0.125 | 7 | 0.12 |
| RCW72D | 72 | 7 | 72 | 0.125 | 8 | 0.12 |

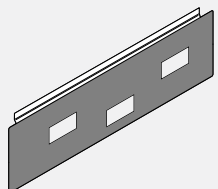
FCR-D • Fabric Covered Facemount Raceway

- Fabric raceway cover is punched out to align with the Face Mount Power Distribution Housing and Duplexes.
- Data punch-out accepts industry standard terminal faceplates (not supplied by Global Contract Inc.) Size of opening is 1.37" x 2.755".
- Electrical cut-outs have black PVC trim. Size of opening is 1.5" x 2.85".
- May not be used with Boulevard System 3 Panels.
- Cover hinges upward for easy access to power and data/communication terminals.

| PRODUCT CODE | PRICE | SIZE/ INCHES | | | WEIGHT VOL | |
|--------------|-------|--------------|----|-------|------------|-----------------|
| | | H | W | D | LBS | FT ³ |
| FCR24D | 82 | 7 | 24 | 0.125 | 3 | 0.05 |
| FCR30D | 89 | 7 | 30 | 0.125 | 3 | 0.06 |
| FCR36D | 92 | 7 | 36 | 0.125 | 4 | 0.07 |
| FCR42D | 97 | 7 | 42 | 0.125 | 5 | 0.08 |
| FCR48D | 103 | 7 | 48 | 0.125 | 5 | 0.09 |
| FCR54D | 106 | 7 | 54 | 0.125 | 6 | 0.10 |
| FCR60D | 112 | 7 | 60 | 0.125 | 7 | 0.11 |
| FCR66D | 116 | 7 | 66 | 0.125 | 7 | 0.12 |
| FCR72D | 124 | 7 | 72 | 0.125 | 8 | 0.12 |

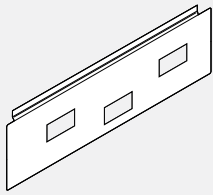
RCA-D • Aluminum Raceway Cover for Face Mounted

- Aluminum raceway cover is punched out to align with the Face Mount Power Distribution Housing and Duplexes.
- Data punch-out accepts industry standard terminal faceplates (not supplied by Global Contract Inc.) Size of opening is 1.37" x 2.755".
- Electrical cut-outs have black PVC trim. Size of opening is 1.5" x 2.85".
- May not be used with Boulevard System 3 Panels.
- Cover hinges upward for easy access to power and data/communication terminals.

| PRODUCT CODE | PRICE | SIZE/ INCHES | | | WEIGHT VOL | |
|--------------|-------|--------------|----|-------|------------|-----------------|
| | | H | W | D | LBS | FT ³ |
| RCA24D | 63 | 7 | 24 | 0.125 | 2.0 | 0.06 |
| RCA30D | 66 | 7 | 30 | 0.125 | 2.1 | 0.06 |
| RCA36D | 72 | 7 | 36 | 0.125 | 2.2 | 0.07 |
| RCA42D | 78 | 7 | 42 | 0.125 | 2.5 | 0.08 |
| RCA48D | 80 | 7 | 48 | 0.125 | 2.9 | 0.09 |
| RCA54D | 88 | 7 | 54 | 0.125 | 3.2 | 0.10 |
| RCA60D | 91 | 7 | 60 | 0.125 | 3.7 | 0.11 |
| RCA66D | 95 | 7 | 66 | 0.125 | 3.9 | 0.12 |
| RCA72D | 102 | 7 | 72 | 0.125 | 4.1 | 0.12 |

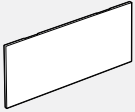
BPMB • Raceway Cover Caps

- To provide clean detail for the punch-outs of a raceway cover when the punch-outs are not in use. Order only when required.
- Made of injection molded ABS.
- B = Black
- W = White
- G = Grey

| PRODUCT CODE | PRICE | SIZE/ INCHES | | | WEIGHT VOL | |
|--------------|-------|--------------|---|-------|------------|-----------------|
| | | H | W | D | LBS | FT ³ |
| BPMB020104B | 10 | 1.5 | 3 | 0.125 | 0.04 | 0.02 |
| BPMB020104G | 10 | 1.5 | 3 | 0.125 | 0.04 | 0.02 |
| BPMB020104W | 10 | 1.5 | 3 | 0.125 | 0.04 | 0.02 |

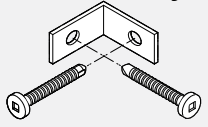
BHSL • Safety Lock

- Provides customers a higher degree of privacy.
- Safety Lock is a set of two ready made brackets and
- It is installed from the inside of a panel adjacent to a opening the door through the raceway.
- To be used for PVC raceways only.

| PRODUCT CODE | PRICE |
|--------------|-------|
| BHSL02 | 31 |

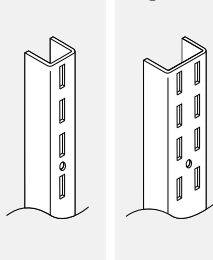
BHV • Component Wall Adapter - Single and Double

- Used to attach system components to fixed wall.
- Panel frame finish.
- The vertical wall adapter is a "U" shaped channel with a vertical row of slots with 1" centers.
- The double Component Wall Adapter has a double row of slots with 1" centers.
- Comes in 60" length only.
- Care should be taken to mount adapters only to wall studs using correct fasteners.
- Does not include mounting hardware. Mounting hardware selection to be based on wall material.
- Sold in pairs.
- Failure to do this may result in collapse of the unit and subsequent possible personal injury.

| PRODUCT CODE | PRICE | SIZE/ INCHES | | | WEIGHT VOL | |
|--------------|-------|--------------|------|-----|------------|-----------------|
| | | H | W | D | LBS | FT ³ |
| BHV01 | 102 | 60 | 0.75 | 0.5 | 4 | 0.009 |
| BHV02 | 117 | 60 | 1.50 | 0.5 | 5 | 0.026 |

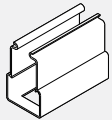
BECC01 • Cable Terminal Channel

- Houses various combinations of voice and data cables.
- 1 included with every Raceway Panel.
- Accommodates assorted snap-in modular voice and data terminals (not supplied by Global Contract Inc).
- Black only.

| PRODUCT CODE | PRICE | SIZE/ INCHES | | | WEIGHT VOL | |
|--------------|-------|--------------|-----|-----|------------|-----------------|
| | | H | W | D | LBS | FT ³ |
| BECC01 | 31 | 6 | 4.5 | 2.5 | .20 | 0.21 |

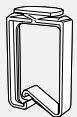
BPHC01 • Cable Terminal Channel

- Houses various combinations of voice and data cables.
- 2 included with every Raceway Panel.
- Black only.
- For use with Boulevard 1 Panels only.

| PRODUCT CODE | PRICE | SIZE/ INCHES | | | WEIGHT VOL | |
|--------------|-------|--------------|---|---|------------|-----------------|
| | | H | W | D | LBS | FT ³ |
| BPHC01 | 9 | 2.5 | 1 | 2 | 0.1 | 0.003 |

BOULEVARD SYSTEM 3

Boulevard System 3 Panel System

Boulevard System 3... The next generation of BOULEVARD offers the freedom to plan the office environment 'your way', while keeping an eye on the bottom line. Boulevard System 3 boasts a rich toolbox featuring stack-on panels, complete data/communication lay-in at the top, comprehensive power and data/communication at both the base and at desk height, a selection of interchangeable tiles, monolithic panels, up-mounted storage, new ergonomic worksurface shapes & a revised colour pallet featuring recycled fabrics... all wrapped up in a sophisticated design statement. Enjoy planning it your way and having the tools to really do it. Boulevard System 3 offers the building blocks to create the framework that perfectly suits your office environment. Combinations of fabric, glazed, open and slat wall panel surface tiles effectively support the creation of various work settings, whether open (to encourage interaction and teamwork) or traditional, with enclosed functional task organizers. Boulevard System 3 lets you plan more effectively and with more versatility than ever before.

It is simple to comprehend, specify, install, maintain and reconfigure. Offering multifunctional furnishing solutions, Boulevard System 3 can be specified on its own or used as a power/data and privacy provider, bridging freestanding/mobile furniture and panels and task related options such as worksurface shapes that help you work better. By utilizing up-mount storage, lower panel heights can be maintained without sacrificing overhead storage where and when needed. Another value-oriented tool... Consider 'Spine' planning to create a power wall that feeds data/communication to a string of perpendicular offices. Incorporate monolithic panels which offer the best cost/performance advantages for value sensitive environments with base panel raceway power/data cable distribution, while adding visual interest...and of course, reconfiguration is a breeze. Now you can have an endless visual pallet and array of practical solutions for today's ever changing and demanding workplace. When you add it all up, Boulevard System 3 gives you more value than ever before.

Technical Information

Panels

- All panels are 2 5/8" thick.
- Lightweight aluminum box frame construction creates superior panel rigidity.
- Panel frame finish is durable epoxy powder coated.
- Hang-on capabilities at 1" increments.
- Patented "Knuckle-Loc" design provides solid panel-to-panel connection for fast installation and reconfiguration.
- Knuckle lock feature ensures even panel heights throughout installation.
- 3" glide stem permits 2 1/2" height adjustment.
- Panel sizes are actual, eliminating creepage.
- Vertical end trims must be specified to give the panel a finished appearance.
- Horizontal top trims are included with all panels.
- All panels include 2 "Capture Strip" panel connectors.
- Panels are UL listed and CSA approved and have a Class "A" fire rating except when Customer's Own Material (COM) is used.
- All panels accept Over Panels (see page D.7).

Panel Options

- Laminate, whiteboard, or corkboard may be substituted for fabric on panels only, see "OPT" column.
- Laminate and whiteboard are held in place with a PVC retainer matching the frame colour and can be retrofitted on site.
- Laminate and whiteboard options reduce the acoustical value of the panel.

Monolithic Panels

- Fabric on Monolithic Panels can be re-upholstered on site.

Pass Thru Panels

- Fabric at base of Pass-Thru Panels can be re-upholstered on site.
- Tiles cannot be re-upholstered on site.

Bottom Lay-in Raceway

- Bottom raceway snaps to the bottom of the panel and can be completely removed for unobstructed cable lay-in installation.
- Bottom lay-in raceway is 60 mm (2.380") wide x 141 mm (5.560") high.
- Maximum capacity: 70 cables 5 mm (0.200) diameter, 2 parallel 8 wire, 4 circuit power distribution.
- State-of-the-art engineering.
- Snap-in modularity of all electrical components including harnesses, distribution housings, duplexes and circuit designations.
- All power and data outlets are easily accessible from both sides of panel.
- 8 wire system with 4, 15 amp circuits (including 1 dedicated circuit).
- Facemount electrical with 2 duplex per panel side.
- Included is 1 data/communication terminal bracket per side.

- Raceway cover openings of 2.71" x 1.38" can accommodate a single modular Data/Comm terminal plate per side (not supplied by Global Contract Inc).
- Opening complies with the ANSI/TIA/EIA standard furniture openings.
- Outlet and circuit changes accomplished without disruption to work station.
- Large raceway cavity permits storage of excess cables and equipment cords.
- Total flexibility for 8 wire system: choice of up to 4 duplexes per panel; choice of circuitry in each duplex .
- Unique design of fire retardant metal raceway cover permits access to raceway without disruption to equipment.

Horizontal Lay-in Channel (Excluding all panels with Embedded Glass)

- Integrated horizontal lay-in channel 33.5 m (1.320") wide and 38 mm (1.500") high at the top of panels and on top of the door frame.
- Maximum capacity: 36 cables 5 mm (0.200") in diameter.
- Maximum cable bending radius between two perpendicular panels: 141.2 mm (5.560") [5 mm (0.200") in diameter cables].

Vertical Wire Channel

- Where applicable, the vertical wire channel connects horizontal channel above desk height with floor level raceway.
- Opening in horizontal channel allows for vertical cable passage from top lay-in channel to base raceway.
- Integrated vertical channel 76 mm (2.990") x 27 mm (1.060").
- Maximum capacity: 60 cables 5 mm (0.200") in diameter.
- Maximum cable bending radius: 141.2 mm (5.560").

Posts

- Enables connection for multiple panel runs such as 90°, 45° or 60° angle and 2 way, 3 way or 4 way.
- Starts at the top of the bottom lay-in raceway.
- 90 degree post provides route for ceiling power and data entry to a panel raceway.
- Knuckle lock feature maintains even height of all connected panels.
- Solid lightweight aluminum extrusion fits together through a unique "Knuckle-Loc" design providing rigid post-to-panel connection.
- Post has punch-outs at the top to allow for unobstructed horizontal cable passage between adjacent panels.
- Includes all required panel connectors and caps.
- Posts add 2 5/8" to a panel run.
- Posts are 1/8" oversized to allow for "panel wrap around" of freestanding desks.
- For all panel runs with multiple posts, this 1/8" must be allotted for.
- Maximum capacity:
 - 80 cables 5mm(0.200") diameter
 - 65 cables 5mm(0.200") diameter with 1 power feed
 - 50 cables 5mm (0.200") diameter with 2 power feeds

PANELS - GUIDELINES FOR ORDERING PRODUCT**Codes**

The product guide uses a numbering system with meaningful alphanumeric characters to create a simple-to-understand product number. This makes specifying the product much easier and more accurate.

Example of Panel: **BPX3MA6636 CHR CHR P1**

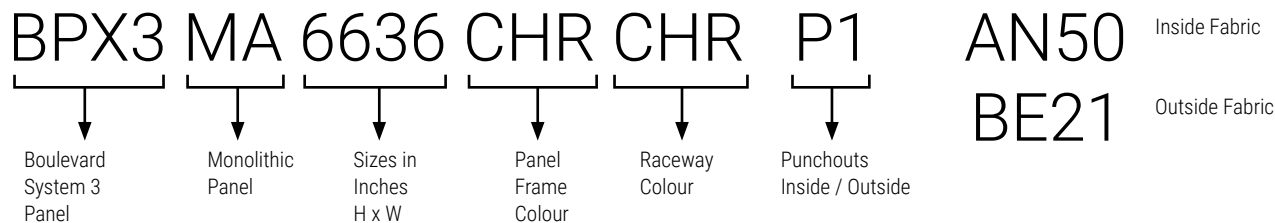
**How to Specify**

- Specify Boulevard System 3 panel type and size by code.
- Specify panel frame finish - ie. CHR (Charcoal).
- Specify PVC raceway finish - ie. CHR (Charcoal). If raceway colour not specified at time of order, default will be the panel frame colour.
- Specify all two panel fabric options if necessary.
- Some fabrics have directional pattern and cannot be applied horizontally or vertically. Panels wider than 60" will have fabrics applied horizontally (railroad). Please specify if you want adjacent panels and the rest of the installation upholstered the same way.
- Specify whether punchouts are required inside and outside of raceway or if no knockouts are required.
 - P2 - Punchouts on both sides.
 - P1 - Punchouts on one side.
 - NP - No punchouts.
- For special width panels, a special must be processed and additional costs apply. Please contact your customer service representative.

Example of Post: **BH3PS066 CHR**

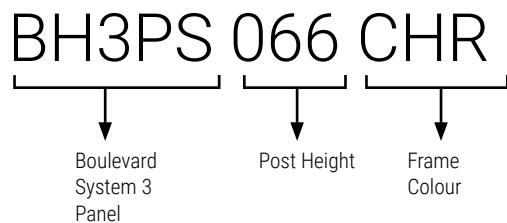
**How to Specify**

- Specify Boulevard System 3 post by code.
- Specify frame colour - ie. CHR (Charcoal).

ORDERS

Each Order Must Include

- Purchase Order
- Layout showing where the image(s) appear in the run of panels.
- A completed Price Chart, showing the location of the image(s) on each appropriate panel.

Transfer Devices

- E-mail up to 10MB to your Global Contract Customer Service Representative.
- Courier CD/DVD/USB stick to your Global Contract Customer Service Representative.

Artwork Specifications

- Non-Photographic artwork should be vector art, saved in Adobe Illustrator (.ai), SVG or an EPS (.eps)
- All bitmap or photographic artwork has to be at a minimum of 100 dpi at the full size of the panel to be printed.
- We accept Adobe CS5 files.
- Any linked files must be included or imbedded.
- Leave any PSD files unflattened
- All fonts must be converted to outlines.
- Do not convert to CMYK, leave all images as RGB if possible
- No Word, Powerpoint, Publisher or other Microsoft files can be used.
- Include a PDF or .jpg for reference when sending native Photoshop or Illustrator format files.

Colour Matching

- A Pantone colour reference must be supplied or we cannot accept responsibility for correct colour.
- When it is not possible to refer to Pantone colours, we will do our best to meet your requirements.

Image Clarity

- We will advise should the selected image not lend itself to the element size requested.

NOTE:

We reserve the right to put an order on hold when the files are found to be incomplete or when documents have been either incorrectly saved. Fonts not converted to curves or the job appears not to be commercially acceptable.

Image Bleed:

To facilitate placement on the panel. Extension of the image past the finished visible area of the panel (bleed) is required

- Boulevard Panels need a 5" Bleed on all sides.

Example Of Image resolution:

The resolution required for a 36 wide x 24 high Boulevard panel at 100dpi (minimum resolution)

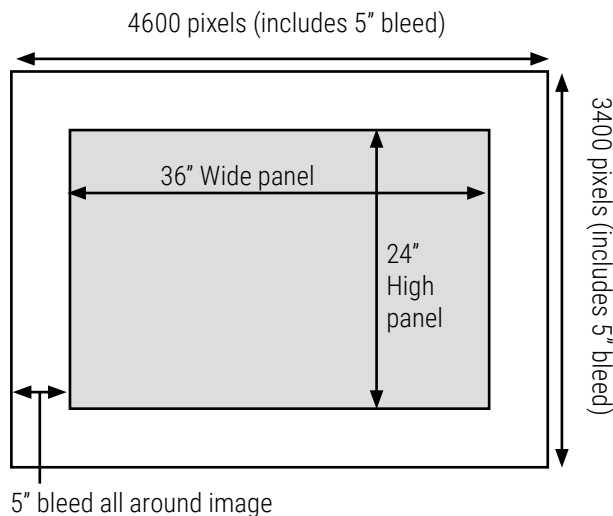

The resolution required for a 36 wide x 24 high Boulevard panel at 300dpi (higher quality)

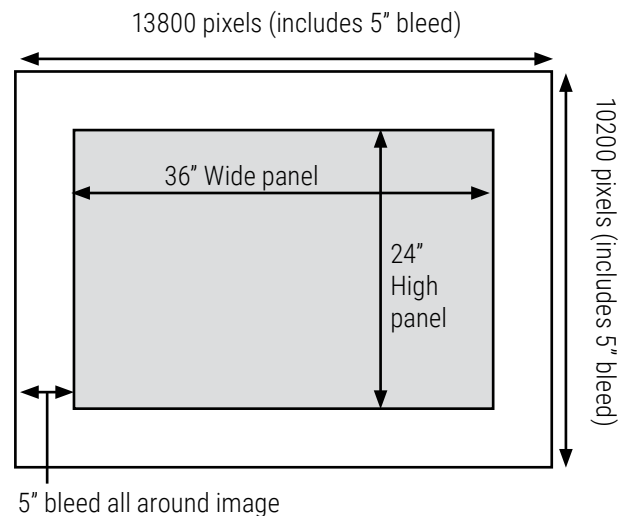

Pricing, Initial Set-Up Charge per Image:\$264 net

Boulevard System 3 Tiles



- This List applies to the following panels:
- BP3FT
- BP3ET

| PANEL WIDTH | HEIGHT 8" | LIST PRICE 16" |
|-------------|-----------|----------------|
| 24" | 144 | 211 |
| 30" | 173 | 248 |
| 36" | 197 | 286 |
| 42" | 227 | 324 |
| 48" | 248 | 364 |
| 54" | 279 | 408 |
| 60" | 303 | 446 |
| 66" | 324 | 476 |
| 72" | 353 | 513 |

Boulevard System 3 Bottom Section of Pass-Through Panel

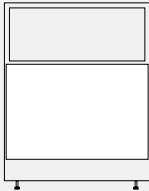

- This List applies to the following panels:
- BPX3PT
- BPX3PV

| PANEL WIDTH | LIST PRICE 28" |
|-------------|----------------|
| 24" | 303 |
| 30" | 353 |
| 36" | 408 |
| 42" | 469 |
| 48" | 520 |
| 54" | 574 |
| 60" | 626 |
| 66" | 680 |
| 72" | 731 |

Boulevard System 3 Monolithic Panels

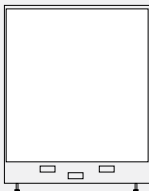

- This List applies to the following panels:
- BPX3MA
- BPX3MV

| PANEL WIDTH | HEIGHT 34" | LIST PRICE 42" | 50" | 66" |
|-------------|------------|----------------|-----|------|
| 24" | 303 | 370 | 431 | 567 |
| 30" | 353 | 431 | 513 | 661 |
| 36" | 408 | 499 | 589 | 770 |
| 42" | 469 | 567 | 656 | 874 |
| 48" | 520 | 633 | 754 | 972 |
| 54" | 574 | 699 | 823 | 1079 |
| 60" | 626 | 770 | 905 | 1175 |
| 66" | 680 | | | |
| 72" | 731 | | | |

Note: Prices shown are an upcharge to the panel price, please add to the list price of panel which you are specifying the graphic for.

BPX3MA • Monolithic Acoustical Panel

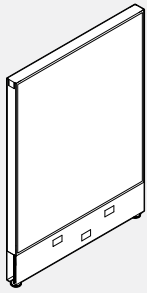

- Provides visual and acoustic privacy.
- Centre septum above raceway overlaid on either side with 1 1/8" "Sound absorbent mineral board".
- Acoustic rating of .70 NRC and 25 STC.
- OPT* = Laminate or Whiteboard
- "No Knockouts" option for raceways available at no additional charge. Please choose option for interior and/or exterior raceways.

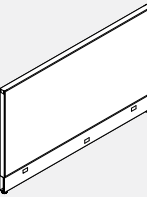

72" Wide

| PRODUCT CODE | PRICE | | | SIZE/ INCHES | | | WEIGHT LBS | VOL FT ³ |
|--------------|-------|------|------|--------------|----|------|------------|---------------------|
| | GR 1 | GR 2 | OPT* | H | W | D | | |
| BPX3MA3418 | 371 | 392 | 415 | 34 | 18 | 2.61 | 11 | 1.337 |
| BPX3MA3424 | 411 | 433 | 455 | 34 | 24 | 2.61 | 12 | 1.738 |
| BPX3MA3430 | 452 | 475 | 495 | 34 | 30 | 2.61 | 13 | 2.139 |
| BPX3MA3436 | 491 | 537 | 580 | 34 | 36 | 2.61 | 15 | 2.540 |
| BPX3MA3442 | 537 | 578 | 623 | 34 | 42 | 2.61 | 16 | 2.941 |
| BPX3MA3448 | 577 | 619 | 661 | 34 | 48 | 2.61 | 18 | 3.342 |
| BPX3MA3454 | 621 | 660 | 709 | 34 | 54 | 2.61 | 20 | 3.743 |
| BPX3MA3460 | 658 | 699 | 747 | 34 | 60 | 2.61 | 22 | 4.144 |
| BPX3MA3466 | 697 | 757 | 823 | 34 | 66 | 2.61 | 26 | 4.612 |
| BPX3MA3472 | 737 | 796 | - | 34 | 72 | 2.61 | 30 | 5.080 |
| BPX3MA4218 | 398 | 426 | 456 | 42 | 18 | 2.61 | 12 | 1.782 |
| BPX3MA4224 | 442 | 472 | 501 | 42 | 24 | 2.61 | 13 | 2.317 |
| BPX3MA4230 | 485 | 514 | 544 | 42 | 30 | 2.61 | 15 | 2.852 |
| BPX3MA4236 | 527 | 584 | 645 | 42 | 36 | 2.61 | 17 | 3.387 |
| BPX3MA4242 | 574 | 630 | 691 | 42 | 42 | 2.61 | 19 | 3.921 |
| BPX3MA4248 | 619 | 676 | 736 | 42 | 48 | 2.61 | 21 | 4.456 |
| BPX3MA4254 | 660 | 720 | 780 | 42 | 54 | 2.61 | 23 | 4.991 |
| BPX3MA4260 | 701 | 759 | 820 | 42 | 60 | 2.61 | 25 | 5.525 |
| BPX3MA4266 | 774 | 888 | 1012 | 42 | 66 | 2.61 | 29 | 6.148 |
| BPX3MA4272 | 840 | 956 | - | 42 | 72 | 2.61 | 34 | 6.770 |
| BPX3MA5018 | 512 | 552 | 600 | 50 | 18 | 2.61 | 13 | 2.106 |
| BPX3MA5024 | 565 | 607 | 653 | 50 | 24 | 2.61 | 15 | 2.738 |
| BPX3MA5030 | 621 | 660 | 709 | 50 | 30 | 2.61 | 17 | 3.370 |
| BPX3MA5036 | 671 | 755 | 849 | 50 | 36 | 2.61 | 20 | 4.002 |
| BPX3MA5042 | 724 | 811 | 901 | 50 | 42 | 2.61 | 23 | 4.634 |
| BPX3MA5048 | 779 | 863 | 955 | 50 | 48 | 2.61 | 24 | 5.266 |
| BPX3MA5054 | 830 | 916 | 1006 | 50 | 54 | 2.61 | 25 | 5.898 |
| BPX3MA5060 | 885 | 970 | 1062 | 50 | 60 | 2.61 | 27 | 6.530 |
| BPX3MA5066 | 958 | 1073 | 1198 | 50 | 66 | 2.61 | 33 | 7.265 |
| BPX3MA5072 | 1029 | 1146 | - | 50 | 72 | 2.61 | 40 | 8.000 |
| BPX3MA5418 | 535 | 575 | 621 | 54 | 18 | 2.61 | 14 | 2.406 |
| BPX3MA5424 | 586 | 629 | 673 | 54 | 24 | 2.61 | 16 | 3.181 |
| BPX3MA5430 | 643 | 686 | 727 | 54 | 30 | 2.61 | 19 | 3.907 |
| BPX3MA5436 | 694 | 780 | 870 | 54 | 36 | 2.61 | 22 | 4.602 |
| BPX3MA5442 | 751 | 835 | 928 | 54 | 42 | 2.61 | 25 | 5.306 |
| BPX3MA5448 | 804 | 888 | 982 | 54 | 48 | 2.61 | 26 | 5.966 |
| BPX3MA5454 | 857 | 942 | 1034 | 54 | 54 | 2.61 | 27 | 7.287 |
| BPX3MA5460 | 913 | 997 | 1089 | 54 | 60 | 2.61 | 30 | 7.539 |
| BPX3MA6618 | 596 | 668 | 745 | 66 | 18 | 2.61 | 14 | 2.755 |
| BPX3MA6624 | 656 | 725 | 802 | 66 | 24 | 2.61 | 17 | 3.581 |
| BPX3MA6630 | 711 | 780 | 854 | 66 | 30 | 2.61 | 20 | 4.407 |
| BPX3MA6636 | 766 | 882 | 1000 | 66 | 36 | 2.61 | 24 | 5.234 |
| BPX3MA6642 | 826 | 938 | 1061 | 66 | 42 | 2.61 | 26 | 6.060 |
| BPX3MA6648 | 883 | 996 | 1117 | 66 | 48 | 2.61 | 28 | 6.887 |
| BPX3MA6654 | 937 | 1052 | 1171 | 66 | 54 | 2.61 | 30 | 7.713 |
| BPX3MA6660 | 996 | 1108 | 1231 | 66 | 60 | 2.61 | 32 | 8.539 |

BPX3MAH • Monolithic Acoustical Hallway Panel

- Provides visual and acoustic privacy.
- Centre septum above raceway overlaid on either side with 1 1/8" "Sound absorbent mineral board".
- One side is with raceway at base, other side has full fabric.
- Acoustic rating of .70 NRC and 25 STC.
- Must specify a BE8JM19 Mesh Jumper at 90 degree corners.
- OPT* = Laminate or Whiteboard
- No Knockouts" option for raceways available at no additional charge. Please choose option for interior and/or exterior raceways.

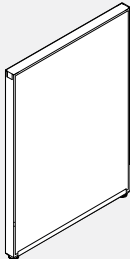
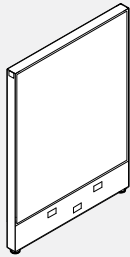

Outside

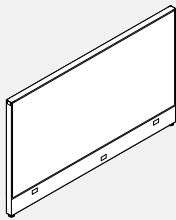

72" Wide

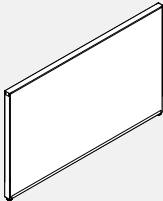

72" Wide Outside

| PRODUCT CODE | PRICE | | | SIZE/ INCHES | | | WEIGHT LBS | VOL FT³ |
|--------------|-------|------|------|--------------|----|------|------------|---------|
| | GR 1 | GR 2 | OPT* | H | W | D | | |
| BPX3MAH3418 | 371 | 392 | 415 | 34 | 18 | 2.61 | 11 | 1.34 |
| BPX3MAH3424 | 411 | 433 | 455 | 34 | 24 | 2.61 | 12 | 1.74 |
| BPX3MAH3430 | 452 | 475 | 495 | 34 | 30 | 2.61 | 13 | 2.14 |
| BPX3MAH3436 | 491 | 537 | 580 | 34 | 36 | 2.61 | 15 | 2.54 |
| BPX3MAH3442 | 537 | 578 | 623 | 34 | 42 | 2.61 | 16 | 2.94 |
| BPX3MAH3448 | 577 | 619 | 661 | 34 | 48 | 2.61 | 18 | 3.34 |
| BPX3MAH3454 | 621 | 660 | 709 | 34 | 54 | 2.61 | 20 | 3.74 |
| BPX3MAH3460 | 658 | 699 | 747 | 34 | 60 | 2.61 | 22 | 4.14 |
| BPX3MAH3466 | 697 | 757 | 823 | 34 | 66 | 2.61 | 26 | 4.61 |
| BPX3MAH3472 | 737 | 796 | - | 34 | 72 | 2.61 | 30 | 5.08 |
| BPX3MAH4218 | 398 | 426 | 456 | 42 | 18 | 2.61 | 12 | 1.78 |
| BPX3MAH4224 | 442 | 472 | 501 | 42 | 24 | 2.61 | 13 | 2.32 |
| BPX3MAH4230 | 485 | 514 | 544 | 42 | 30 | 2.61 | 15 | 2.85 |
| BPX3MAH4236 | 527 | 584 | 645 | 42 | 36 | 2.61 | 17 | 3.39 |
| BPX3MAH4242 | 574 | 630 | 691 | 42 | 42 | 2.61 | 19 | 3.92 |
| BPX3MAH4248 | 619 | 676 | 736 | 42 | 48 | 2.61 | 21 | 4.46 |
| BPX3MAH4254 | 660 | 720 | 780 | 42 | 54 | 2.61 | 23 | 4.99 |
| BPX3MAH4260 | 701 | 759 | 820 | 42 | 60 | 2.61 | 25 | 5.53 |
| BPX3MAH4266 | 774 | 888 | 1012 | 42 | 66 | 2.61 | 29 | 6.15 |
| BPX3MAH4272 | 840 | 956 | - | 42 | 72 | 2.61 | 34 | 6.77 |
| BPX3MAH5018 | 512 | 552 | 600 | 50 | 18 | 2.61 | 13 | 2.11 |
| BPX3MAH5024 | 565 | 607 | 653 | 50 | 24 | 2.61 | 15 | 2.74 |
| BPX3MAH5030 | 621 | 660 | 709 | 50 | 30 | 2.61 | 17 | 3.37 |
| BPX3MAH5036 | 671 | 755 | 849 | 50 | 36 | 2.61 | 20 | 4.00 |
| BPX3MAH5042 | 724 | 811 | 901 | 50 | 42 | 2.61 | 23 | 4.63 |
| BPX3MAH5048 | 779 | 863 | 955 | 50 | 48 | 2.61 | 24 | 5.27 |
| BPX3MAH5054 | 830 | 916 | 1006 | 50 | 54 | 2.61 | 25 | 5.90 |
| BPX3MAH5060 | 885 | 970 | 1062 | 50 | 60 | 2.61 | 27 | 6.53 |
| BPX3MAH5066 | 958 | 1073 | 1198 | 50 | 66 | 2.61 | 33 | 7.27 |
| BPX3MAH5072 | 1029 | 1146 | - | 50 | 72 | 2.61 | 40 | 8.00 |
| BPX3MAH5418 | 535 | 575 | 621 | 54 | 18 | 2.61 | 14 | 2.41 |
| BPX3MAH5424 | 586 | 629 | 673 | 54 | 24 | 2.61 | 16 | 3.18 |
| BPX3MAH5430 | 643 | 686 | 727 | 54 | 30 | 2.61 | 19 | 3.91 |
| BPX3MAH5436 | 694 | 780 | 870 | 54 | 36 | 2.61 | 22 | 4.60 |
| BPX3MAH5442 | 751 | 835 | 928 | 54 | 42 | 2.61 | 25 | 5.31 |
| BPX3MAH5448 | 804 | 888 | 982 | 54 | 48 | 2.61 | 26 | 5.97 |
| BPX3MAH5454 | 857 | 942 | 1034 | 54 | 54 | 2.61 | 27 | 7.29 |
| BPX3MAH5460 | 913 | 997 | 1089 | 54 | 60 | 2.61 | 30 | 7.54 |
| BPX3MAH6618 | 596 | 668 | 745 | 66 | 18 | 2.61 | 14 | 2.76 |
| BPX3MAH6624 | 656 | 725 | 802 | 66 | 24 | 2.61 | 17 | 3.58 |
| BPX3MAH6630 | 711 | 780 | 854 | 66 | 30 | 2.61 | 20 | 4.41 |
| BPX3MAH6636 | 766 | 882 | 1000 | 66 | 36 | 2.61 | 24 | 5.23 |
| BPX3MAH6642 | 826 | 938 | 1061 | 66 | 42 | 2.61 | 26 | 6.06 |
| BPX3MAH6648 | 883 | 996 | 1117 | 66 | 48 | 2.61 | 28 | 6.89 |
| BPX3MAH6654 | 937 | 1052 | 1171 | 66 | 54 | 2.61 | 30 | 7.71 |
| BPX3MAH6660 | 996 | 1108 | 1231 | 66 | 60 | 2.61 | 32 | 8.54 |

BPX3MV • Monolithic Acoustical Panel with Vertical Wire Channel

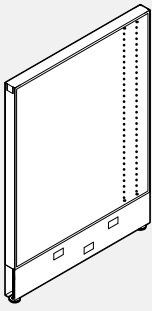

- Provides visual and acoustic privacy and allows for vertical cable passage from top lay-in channel to bottom raceway within panel.
- Centre septum above raceway overlaid on either side with 1 1/8" "Sound absorbent mineral board".
- Acoustic rating of .70 NRC and 25 STC. Includes integrated vertical wire channel.
- OPT* = Laminate or Whiteboard
- "No Knockouts" option for raceways available at no additional charge. Please choose option for interior and/or exterior raceways.

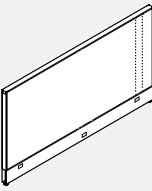

72" Wide

| PRODUCT CODE | PRICE | | | SIZE/ INCHES | | | WEIGHT LBS | VOL FT ³ |
|--------------|-------|------|------|--------------|----|------|------------|---------------------|
| | GR 1 | GR 2 | OPT* | H | W | D | | |
| BPX3MV3430 | 486 | 509 | 534 | 34 | 30 | 2.61 | 15 | 2.139 |
| BPX3MV3436 | 527 | 570 | 614 | 34 | 36 | 2.61 | 17 | 2.540 |
| BPX3MV3442 | 569 | 610 | 656 | 34 | 42 | 2.61 | 18 | 2.941 |
| BPX3MV3448 | 610 | 654 | 697 | 34 | 48 | 2.61 | 20 | 3.342 |
| BPX3MV3454 | 654 | 694 | 741 | 34 | 54 | 2.61 | 22 | 3.743 |
| BPX3MV3460 | 692 | 734 | 780 | 34 | 60 | 2.61 | 24 | 4.144 |
| BPX3MV3466 | 783 | 842 | 907 | 34 | 66 | 2.61 | 29 | 4.612 |
| BPX3MV3472 | 785 | 845 | - | 34 | 72 | 2.61 | 34 | 5.080 |
| BPX3MV4230 | 535 | 562 | 591 | 42 | 30 | 2.61 | 17 | 2.852 |
| BPX3MV4236 | 574 | 630 | 691 | 42 | 36 | 2.61 | 19 | 3.387 |
| BPX3MV4242 | 622 | 680 | 740 | 42 | 42 | 2.61 | 21 | 3.921 |
| BPX3MV4248 | 660 | 720 | 780 | 42 | 48 | 2.61 | 23 | 4.456 |
| BPX3MV4254 | 707 | 762 | 824 | 42 | 54 | 2.61 | 25 | 4.991 |
| BPX3MV4260 | 749 | 806 | 867 | 42 | 60 | 2.61 | 27 | 5.525 |
| BPX3MV4266 | 827 | 943 | 1066 | 42 | 66 | 2.61 | 32 | 6.148 |
| BPX3MV4272 | 898 | 1017 | - | 42 | 72 | 2.61 | 38 | 6.770 |
| BPX3MV5030 | 672 | 715 | 759 | 50 | 30 | 2.61 | 19 | 3.370 |
| BPX3MV5036 | 727 | 814 | 907 | 50 | 36 | 2.61 | 22 | 4.002 |
| BPX3MV5042 | 780 | 864 | 956 | 50 | 42 | 2.61 | 25 | 4.634 |
| BPX3MV5048 | 835 | 920 | 1012 | 50 | 48 | 2.61 | 26 | 5.266 |
| BPX3MV5054 | 886 | 971 | 1063 | 50 | 54 | 2.61 | 27 | 5.898 |
| BPX3MV5060 | 942 | 1027 | 1119 | 50 | 60 | 2.61 | 29 | 6.530 |
| BPX3MV5066 | 1026 | 1142 | 1265 | 50 | 66 | 2.61 | 35 | 7.265 |
| BPX3MV5072 | 1108 | 1225 | - | 50 | 72 | 2.61 | 40 | 8.000 |
| BPX3MV5430 | 701 | 746 | 790 | 54 | 30 | 2.61 | 19 | 3.907 |
| BPX3MV5436 | 758 | 843 | 935 | 54 | 36 | 2.61 | 22 | 4.602 |
| BPX3MV5442 | 812 | 895 | 987 | 54 | 42 | 2.61 | 25 | 5.306 |
| BPX3MV5448 | 867 | 952 | 1043 | 54 | 48 | 2.61 | 26 | 5.966 |
| BPX3MV5454 | 920 | 1003 | 1095 | 54 | 54 | 2.61 | 27 | 7.287 |
| BPX3MV5460 | 975 | 1061 | 1153 | 54 | 60 | 2.61 | 30 | 7.539 |
| BPX3MV6630 | 791 | 863 | 937 | 66 | 30 | 2.61 | 22 | 4.407 |
| BPX3MV6636 | 845 | 958 | 1079 | 66 | 36 | 2.61 | 26 | 5.234 |
| BPX3MV6642 | 905 | 1018 | 1139 | 66 | 42 | 2.61 | 28 | 6.060 |
| BPX3MV6648 | 960 | 1073 | 1196 | 66 | 48 | 2.61 | 30 | 6.887 |
| BPX3MV6654 | 1017 | 1129 | 1250 | 66 | 54 | 2.61 | 32 | 7.713 |
| BPX3MV6660 | 1073 | 1187 | 1306 | 66 | 60 | 2.61 | 34 | 8.539 |

BPX3MG • Monolithic Glazed Panel

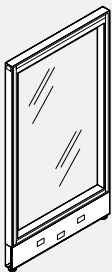

- Full-height glazing provides visual accessibility.
- Glazing is replaceable on site. Tempered clear glass standard.
- Glazing is standard on one side.
- "No Knockouts" option for raceways available at no additional charge. Please choose option for interior and/or exterior raceways.

| PRODUCT CODE | PRICE | | SIZE/ INCHES | | | WEIGHT LBS | VOL FT ³ |
|--------------|-------|------|--------------|----|------|------------|---------------------|
| | CLR | FRST | H | W | D | | |
| BPX3MG5024 | 898 | 1080 | 50 | 24 | 2.61 | 25 | 2.738 |
| BPX3MG5030 | 1142 | 1369 | 50 | 30 | 2.61 | 29 | 3.370 |
| BPX3MG5036 | 1209 | 1450 | 50 | 36 | 2.61 | 33 | 4.002 |
| BPX3MG5042 | 1276 | 1533 | 50 | 42 | 2.61 | 36 | 4.634 |
| BPX3MG5048 | 1344 | 1611 | 50 | 48 | 2.61 | 41 | 5.266 |
| BPX3MG5424 | 958 | 1148 | 54 | 24 | 2.61 | 29 | 3.138 |
| BPX3MG5430 | 1160 | 1394 | 54 | 30 | 2.61 | 34 | 3.807 |
| BPX3MG5436 | 1236 | 1483 | 54 | 36 | 2.61 | 38 | 4.602 |
| BPX3MG5442 | 1310 | 1573 | 54 | 42 | 2.61 | 43 | 5.334 |
| BPX3MG5448 | 1383 | 1661 | 54 | 48 | 2.61 | 48 | 6.066 |
| BPX3MG6624 | 1121 | 1345 | 66 | 24 | 2.61 | 33 | 3.581 |
| BPX3MG6630 | 1216 | 1460 | 66 | 30 | 2.61 | 39 | 4.407 |
| BPX3MG6636 | 1318 | 1581 | 66 | 36 | 2.61 | 44 | 5.234 |
| BPX3MG6642 | 1411 | 1694 | 66 | 42 | 2.61 | 49 | 6.060 |
| BPX3MG6648 | 1506 | 1809 | 66 | 48 | 2.61 | 54 | 6.887 |

BPX3PT • Pass-Thru Panel - Fabric Base

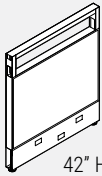

42" High

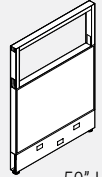

50" High

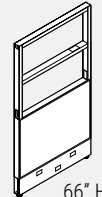

66" High

- Opening allows choice of tile above desk height.
- Solid fabric base up to 34".
- Single 8" opening above 34" for 42" high panels.
- Single 16" opening above 34" for 50" high panels.
- Two individual 16" openings above 34" for 66" high panels.
- Horizontal cable management at 34" height.
- OPT* = Laminate or Whiteboard.
- "No Knockouts" option for raceways available at no additional charge. Please choose option for interior and/or exterior raceways.

| PRODUCT CODE | PRICE | | | SIZE/ H | INCHES | | | WEIGHT LBS | VOL FT ³ |
|--------------|-------|------|------|---------|--------|------|----|------------|---------------------|
| | GR 1 | GR 2 | OPT* | | W | D | | | |
| BPX3PT4218 | 380 | 409 | 441 | 42 | 18 | 2.61 | 14 | 1.689 | |
| BPX3PT4224 | 431 | 457 | 488 | 42 | 24 | 2.61 | 16 | 2.233 | |
| BPX3PT4230 | 476 | 505 | 537 | 42 | 30 | 2.61 | 17 | 2.792 | |
| BPX3PT4236 | 520 | 548 | 580 | 42 | 36 | 2.61 | 19 | 3.351 | |
| BPX3PT4242 | 567 | 593 | 626 | 42 | 42 | 2.61 | 21 | 3.908 | |
| BPX3PT4248 | 614 | 644 | 676 | 42 | 48 | 2.61 | 23 | 4.466 | |
| BPX3PT4254 | 659 | 689 | 721 | 42 | 54 | 2.61 | 26 | 5.025 | |
| BPX3PT4260 | 705 | 733 | 763 | 42 | 60 | 2.61 | 27 | 5.592 | |
| BPX3PT4266 | 752 | 812 | 877 | 42 | 66 | 2.61 | 32 | 6.148 | |
| BPX3PT4272 | 801 | 860 | - | 42 | 72 | 2.61 | 38 | 6.700 | |
| BPX3PT5018 | 380 | 409 | 441 | 50 | 18 | 2.61 | 15 | 2.106 | |
| BPX3PT5024 | 431 | 457 | 488 | 50 | 24 | 2.61 | 17 | 2.738 | |
| BPX3PT5030 | 476 | 505 | 537 | 50 | 30 | 2.61 | 18 | 3.370 | |
| BPX3PT5036 | 520 | 548 | 580 | 50 | 36 | 2.61 | 20 | 4.002 | |
| BPX3PT5042 | 567 | 593 | 626 | 50 | 42 | 2.61 | 22 | 4.634 | |
| BPX3PT5048 | 614 | 644 | 676 | 50 | 48 | 2.61 | 24 | 5.266 | |
| BPX3PT5054 | 659 | 689 | 721 | 50 | 54 | 2.61 | 27 | 5.898 | |
| BPX3PT5060 | 705 | 733 | 763 | 50 | 60 | 2.61 | 29 | 6.530 | |
| BPX3PT5066 | 752 | 812 | 877 | 50 | 66 | 2.61 | 34 | 7.265 | |
| BPX3PT5072 | 801 | 860 | - | 50 | 72 | 2.61 | 40 | 8.000 | |
| BPX3PT6618 | 475 | 505 | 536 | 66 | 18 | 2.61 | 19 | 2.755 | |
| BPX3PT6624 | 527 | 557 | 589 | 66 | 24 | 2.61 | 21 | 3.581 | |
| BPX3PT6630 | 586 | 615 | 647 | 66 | 30 | 2.61 | 23 | 4.407 | |
| BPX3PT6636 | 638 | 668 | 697 | 66 | 36 | 2.61 | 25 | 5.234 | |
| BPX3PT6642 | 694 | 724 | 755 | 66 | 42 | 2.61 | 27 | 6.060 | |
| BPX3PT6648 | 754 | 784 | 814 | 66 | 48 | 2.61 | 30 | 6.887 | |
| BPX3PT6654 | 805 | 835 | 865 | 66 | 54 | 2.61 | 33 | 7.713 | |
| BPX3PT6660 | 863 | 893 | 922 | 66 | 60 | 2.61 | 36 | 8.539 | |

BPX3PTH • Pass-Thru Hallway Panel - Fabric Base

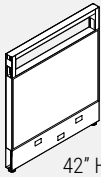

42" High

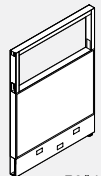
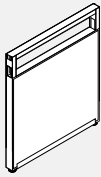

50" High

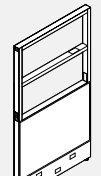
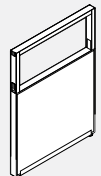

66" High

- Opening allows choice of tile above desk height.
- Solid fabric base up to 34".
- Single 8" opening above 34" for 42" high panels.
- Single 16" opening above 34" for 50" high panels.
- Two individual 16" openings above 34" for 66" high panels.
- One side is with raceway at base, other side has full fabric.
- Horizontal cable management at 34" height.
- Must specify a BE8JM19 Mesh Jumper at 90 degree corners.
- OPT* = Laminate or Whiteboard
- "No Knockouts" option for raceways available at no additional charge. Please choose option for interior and/or exterior raceways.

| PRODUCT CODE | PRICE | | | SIZE/ H | INCHES | | | WEIGHT LBS | VOL FT ³ |
|--------------|-------|------|------|---------|--------|------|----|------------|---------------------|
| | GR 1 | GR 2 | OPT* | | W | D | | | |
| BPX3PTH4218 | 380 | 409 | 441 | 42 | 18 | 2.61 | 14 | 1.69 | |
| BPX3PTH4224 | 431 | 457 | 488 | 42 | 24 | 2.61 | 16 | 2.23 | |
| BPX3PTH4230 | 476 | 505 | 537 | 42 | 30 | 2.61 | 17 | 2.79 | |
| BPX3PTH4236 | 520 | 548 | 580 | 42 | 36 | 2.61 | 19 | 3.35 | |
| BPX3PTH4242 | 567 | 593 | 626 | 42 | 42 | 2.61 | 21 | 3.91 | |
| BPX3PTH4248 | 614 | 644 | 676 | 42 | 48 | 2.61 | 23 | 4.47 | |
| BPX3PTH4254 | 659 | 689 | 721 | 42 | 54 | 2.61 | 26 | 5.03 | |
| BPX3PTH4260 | 705 | 733 | 763 | 42 | 60 | 2.61 | 27 | 5.59 | |
| BPX3PTH4266 | 752 | 812 | 877 | 42 | 66 | 2.61 | 32 | 6.15 | |
| BPX3PTH4272 | 801 | 860 | - | 42 | 72 | 2.61 | 38 | 6.70 | |
| BPX3PTH5018 | 380 | 409 | 441 | 50 | 18 | 2.61 | 15 | 2.11 | |
| BPX3PTH5024 | 431 | 457 | 488 | 50 | 24 | 2.61 | 17 | 2.74 | |
| BPX3PTH5030 | 476 | 505 | 537 | 50 | 30 | 2.61 | 18 | 3.37 | |
| BPX3PTH5036 | 520 | 548 | 580 | 50 | 36 | 2.61 | 20 | 4.00 | |
| BPX3PTH5042 | 567 | 593 | 626 | 50 | 42 | 2.61 | 22 | 4.63 | |
| BPX3PTH5048 | 614 | 644 | 676 | 50 | 48 | 2.61 | 24 | 5.27 | |
| BPX3PTH5054 | 659 | 689 | 721 | 50 | 54 | 2.61 | 27 | 5.90 | |
| BPX3PTH5060 | 705 | 733 | 763 | 50 | 60 | 2.61 | 29 | 6.53 | |
| BPX3PTH5066 | 752 | 812 | 877 | 50 | 66 | 2.61 | 34 | 7.27 | |
| BPX3PTH5072 | 801 | 860 | - | 50 | 72 | 2.61 | 40 | 8.00 | |
| BPX3PTH6618 | 475 | 505 | 536 | 66 | 18 | 2.61 | 19 | 2.76 | |
| BPX3PTH6624 | 527 | 557 | 589 | 66 | 24 | 2.61 | 21 | 3.58 | |
| BPX3PTH6630 | 586 | 615 | 647 | 66 | 30 | 2.61 | 23 | 4.41 | |
| BPX3PTH6636 | 638 | 668 | 697 | 66 | 36 | 2.61 | 25 | 5.23 | |
| BPX3PTH6642 | 694 | 724 | 755 | 66 | 42 | 2.61 | 27 | 6.06 | |
| BPX3PTH6648 | 754 | 784 | 814 | 66 | 48 | 2.61 | 30 | 6.89 | |
| BPX3PTH6654 | 805 | 835 | 865 | 66 | 54 | 2.61 | 33 | 7.71 | |
| BPX3PTH6660 | 863 | 893 | 922 | 66 | 60 | 2.61 | 36 | 8.54 | |

BPX3PV • Pass-Thru Panel with Vertical Wire Channel

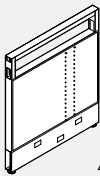

42" High

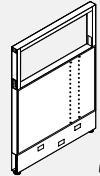

50" High

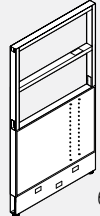

66" High

- Opening allows choice of tile above desk height. Vertical wire channel allows passage of cables from top lay-in channel to bottom raceway within panel.
- Solid fabric base up to 34".
- Single 8" opening above 34" for 42" high panels.
- Single 16" opening above 34" for 50" high panels.
- Two individual 16" openings above 34" for 66" high panels.
- Includes integrated vertical wire channel.
- Horizontal cable management at 34" height.
- OPT* = Laminate or Whiteboard.
- "No Knockouts" option for raceways available at no additional charge. Please choose option for interior and or exterior raceways.

| PRODUCT CODE | PRICE | | | SIZE/ INCHES | | | WEIGHT LBS | VOL FT ³ |
|--------------|-------|------|------|--------------|----|------|------------|---------------------|
| | GR 1 | GR 2 | OPT* | H | W | D | | |
| BPX3PV4230 | 520 | 548 | 580 | 42 | 30 | 2.61 | 19 | 2.792 |
| BPX3PV4236 | 567 | 593 | 626 | 42 | 36 | 2.61 | 21 | 3.351 |
| BPX3PV4242 | 614 | 644 | 676 | 42 | 42 | 2.61 | 23 | 3.908 |
| BPX3PV4248 | 659 | 689 | 721 | 42 | 48 | 2.61 | 23 | 4.466 |
| BPX3PV4254 | 705 | 733 | 763 | 42 | 54 | 2.61 | 28 | 5.025 |
| BPX3PV4260 | 755 | 784 | 816 | 42 | 60 | 2.61 | 30 | 5.592 |
| BPX3PV4266 | 792 | 852 | 917 | 42 | 66 | 2.61 | 36 | 6.148 |
| BPX3PV4272 | 830 | 891 | - | 42 | 72 | 2.61 | 42 | 6.700 |
| BPX3PV5030 | 520 | 548 | 580 | 50 | 30 | 2.61 | 20 | 3.370 |
| BPX3PV5036 | 567 | 593 | 626 | 50 | 36 | 2.61 | 22 | 4.002 |
| BPX3PV5042 | 614 | 644 | 676 | 50 | 42 | 2.61 | 24 | 4.634 |
| BPX3PV5048 | 659 | 689 | 721 | 50 | 48 | 2.61 | 26 | 5.266 |
| BPX3PV5054 | 705 | 733 | 763 | 50 | 54 | 2.61 | 29 | 5.898 |
| BPX3PV5060 | 755 | 784 | 816 | 50 | 60 | 2.61 | 31 | 6.530 |
| BPX3PV5066 | 792 | 852 | 917 | 50 | 66 | 2.61 | 37 | 7.265 |
| BPX3PV5072 | 830 | 891 | - | 50 | 72 | 2.61 | 44 | 8.000 |
| BPX3PV6630 | 630 | 659 | 691 | 66 | 30 | 2.61 | 25 | 4.407 |
| BPX3PV6636 | 688 | 718 | 748 | 66 | 36 | 2.61 | 27 | 5.234 |
| BPX3PV6642 | 741 | 773 | 801 | 66 | 42 | 2.61 | 29 | 6.060 |
| BPX3PV6648 | 797 | 827 | 857 | 66 | 48 | 2.61 | 32 | 6.887 |
| BPX3PV6654 | 852 | 883 | 913 | 66 | 54 | 2.61 | 35 | 7.713 |
| BPX3PV6660 | 908 | 937 | 969 | 66 | 60 | 2.61 | 38 | 8.539 |

BPX3PF • Pass-Thru Panel - Air Flow Base

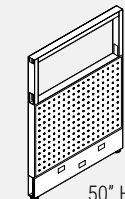

50" High

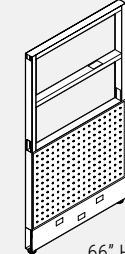

66" High

- Allows air to flow freely through the bottom of the panel.
- Double wall perforated metal base up to 34".
- Single 16" opening above 34" for 50" high panels.
- Two individual 16" openings above 34" for 66" high panels.
- Horizontal cable management at 34" height.
- "No Knockouts" option for raceways available at no additional charge. Please choose option for interior and/or exterior raceways.

| PRODUCT CODE | PRICE | SIZE/ INCHES | | | WEIGHT LBS | VOL FT ³ |
|--------------|-------|--------------|----|------|------------|---------------------|
| | | H | W | D | | |
| BPX3PF5018 | 536 | 50 | 18 | 2.61 | 17 | 2.106 |
| BPX3PF5024 | 605 | 50 | 24 | 2.61 | 18 | 2.738 |
| BPX3PF5030 | 673 | 50 | 30 | 2.61 | 20 | 3.370 |
| BPX3PF5036 | 749 | 50 | 36 | 2.61 | 22 | 4.002 |
| BPX3PF5042 | 824 | 50 | 42 | 2.61 | 23 | 4.634 |
| BPX3PF5048 | 895 | 50 | 48 | 2.61 | 26 | 5.266 |
| BPX3PF5054 | 969 | 50 | 54 | 2.61 | 28 | 5.898 |
| BPX3PF5060 | 1038 | 50 | 60 | 2.61 | 31 | 6.530 |
| BPX3PF6618 | 625 | 66 | 18 | 2.61 | 21 | 2.755 |
| BPX3PF6624 | 705 | 66 | 24 | 2.61 | 23 | 3.581 |
| BPX3PF6630 | 791 | 66 | 30 | 2.61 | 25 | 4.407 |
| BPX3PF6636 | 874 | 66 | 36 | 2.61 | 27 | 5.234 |
| BPX3PF6642 | 960 | 66 | 42 | 2.61 | 29 | 6.060 |
| BPX3PF6648 | 1045 | 66 | 48 | 2.61 | 32 | 6.887 |
| BPX3PF6654 | 1129 | 66 | 54 | 2.61 | 35 | 7.713 |
| BPX3PF6660 | 1212 | 66 | 60 | 2.61 | 37 | 8.539 |

BPX3OP • Over Panel Frame

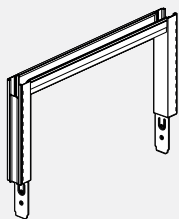

- Attaches to the top of any Boulevard System 3 panel to create a floor-to-ceiling wall.
- Any tile can be attached to either side to enclose the frame.
- Two slotted uprights at either end slide into vertical extrusions on the base panel.
- Shipped without horizontal and vertical trim; the horizontal trim from the base panel will be used.
- Openings in horizontal channels allow for vertical cable passage from top lay-in channel and behind the cover tiles
- Over Panel Frames 18" and 24" wide are not punched for vertical wire channel.
- Boulevard System 3 Over Panel is not compatible with Boulevard 1 panels.
- Hang-on capabilities not to exceed 66" high or in conjunction with glass tiles.

| PRODUCT CODE | PRICE | SIZE/ INCHES | | | WEIGHT LBS | VOL FT ³ |
|--------------|-------|--------------|----|------|------------|---------------------|
| | | H | W | D | | |
| BPX3OP0818 | 93 | 8 | 18 | 2.61 | 3 | 0.383 |
| BPX3OP0824 | 102 | 8 | 24 | 2.61 | 4 | 0.438 |
| BPX3OP0830 | 109 | 8 | 30 | 2.61 | 4 | 0.656 |
| BPX3OP0836 | 117 | 8 | 36 | 2.61 | 4 | 0.712 |
| BPX3OP0842 | 131 | 8 | 42 | 2.61 | 5 | 0.875 |
| BPX3OP0848 | 138 | 8 | 48 | 2.61 | 5 | 0.930 |
| BPX3OP0854 | 146 | 8 | 54 | 2.61 | 6 | 1.040 |
| BPX3OP0860 | 156 | 8 | 60 | 2.61 | 6 | 1.204 |
| BPX3OP0866 | 173 | 8 | 66 | 2.61 | 7 | 1.310 |
| BPX3OP0872 | 192 | 8 | 72 | 2.61 | 8 | 1.420 |
| BPX3OP1618 | 93 | 16 | 18 | 2.61 | 4 | 0.638 |
| BPX3OP1624 | 102 | 16 | 24 | 2.61 | 5 | 0.730 |
| BPX3OP1630 | 109 | 16 | 30 | 2.61 | 5 | 1.094 |
| BPX3OP1636 | 117 | 16 | 36 | 2.61 | 5 | 1.186 |
| BPX3OP1642 | 131 | 16 | 42 | 2.61 | 6 | 1.459 |
| BPX3OP1648 | 138 | 16 | 48 | 2.61 | 6 | 1.550 |
| BPX3OP1654 | 146 | 16 | 54 | 2.61 | 7 | 1.733 |
| BPX3OP1660 | 156 | 16 | 60 | 2.61 | 7 | 2.006 |
| BPX3OP1666 | 173 | 16 | 66 | 2.61 | 9 | 2.165 |
| BPX3OP1672 | 192 | 16 | 72 | 2.61 | 10 | 2.370 |

BP3PBEG • Embedded Glass and Top Trim Kit

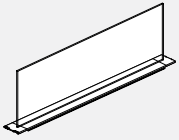

- **Embedded Glass and Top Trim Kit attaches on top of panels to add privacy or divide space.**
- Embedded Glass Top Trim Kit consist of the extruded aluminum channel, die-cast channel end covers, glass partition, gasket and hardware required to secure the trim to the panel's horizontal channel.
- Specify standard metal paint finish.
- Clear tempered glass is standard.
- NOTE: When specifying an application where two panels are side by side at different heights, a special is required to ensure proper fit.

| PRODUCT CODE | PRICE | | SIZE/INCHES | | | WEIGHT LBS | VOL FT ³ |
|--------------|-------|------|-------------|----|------|------------|---------------------|
| | CLR | FRST | H | W | D | | |
| BP3PBEG0824 | 129 | 213 | 8 | 24 | 2.61 | 9.42 | 0.29 |
| BP3PBEG0830 | 137 | 220 | 8 | 30 | 2.61 | 11.79 | 0.36 |
| BP3PBEG0836 | 144 | 229 | 8 | 36 | 2.61 | 14.15 | 0.44 |
| BP3PBEG0842 | 152 | 237 | 8 | 42 | 2.61 | 16.52 | 0.51 |
| BP3PBEG0848 | 168 | 262 | 8 | 48 | 2.61 | 18.88 | 0.58 |
| BP3PBEG0854 | 186 | 291 | 8 | 54 | 2.61 | 19.52 | 0.65 |
| BP3PBEG0860 | 204 | 320 | 8 | 60 | 2.61 | 20.58 | 0.73 |
| BP3PBEG0866 | 221 | 350 | 8 | 66 | 2.61 | 21.55 | 0.80 |
| BP3PBEG0872 | 245 | 385 | 8 | 72 | 2.61 | 23.62 | 0.87 |
| BP3PBEG1624 | 134 | 218 | 16 | 24 | 2.61 | 9.89 | 0.58 |
| BP3PBEG1630 | 165 | 264 | 16 | 30 | 2.61 | 12.38 | 0.73 |
| BP3PBEG1636 | 184 | 311 | 16 | 36 | 2.61 | 14.86 | 0.87 |
| BP3PBEG1642 | 210 | 357 | 16 | 42 | 2.61 | 17.35 | 1.02 |
| BP3PBEG1648 | 236 | 404 | 16 | 48 | 2.61 | 19.82 | 1.16 |
| BP3PBEG1654 | 261 | 425 | 16 | 54 | 2.61 | 21.25 | 1.31 |
| BP3PBEG1660 | 286 | 496 | 16 | 60 | 2.61 | 23.62 | 1.45 |
| BP3PBEG1666 | 312 | 543 | 16 | 66 | 2.61 | 25.98 | 1.60 |
| BP3PBEG1672 | 343 | 595 | 16 | 72 | 2.61 | 28.35 | 1.74 |

BP3PBEF • Embedded PET Felt and Top Trim Kit

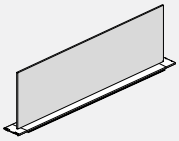

- **Embedded PET Felt and Top Trim Kit attaches on top of panels to add privacy or divide space.**
- Embedded PET Felt Top Trim Kit consist of the extruded aluminum channel, die-cast channel end covers, PET felt partition and hardware required to secure the trim to the panels horizontal channel.
- Specify standard metal paint finish.
- 9mm PET felt material is tackable and comes in 18 different colours. Please specify colour.
- NOTE: When specifying an application where two panels are side by side at different heights, a special is required to ensure proper fit.

| PRODUCT CODE | PRICE | | SIZE/INCHES | | | WEIGHT LBS | VOL FT ³ |
|--------------|-------|----|-------------|------|-----------------|------------|---------------------|
| | H | W | D | LBS | FT ³ | | |
| BP3PBEF0824 | 63 | 8 | 24 | 2.61 | 1.32 | 0.29 | |
| BP3PBEF0830 | 66 | 8 | 30 | 2.61 | 1.65 | 0.36 | |
| BP3PBEF0836 | 88 | 8 | 36 | 2.61 | 1.99 | 0.44 | |
| BP3PBEF0842 | 92 | 8 | 42 | 2.61 | 2.32 | 0.51 | |
| BP3PBEF0848 | 165 | 8 | 48 | 2.61 | 2.65 | 0.58 | |
| BP3PBEF0854 | 169 | 8 | 54 | 2.61 | 2.98 | 0.65 | |
| BP3PBEF0860 | 172 | 8 | 60 | 2.61 | 3.32 | 0.73 | |
| BP3PBEF0866 | 176 | 8 | 66 | 2.61 | 3.65 | 0.80 | |
| BP3PBEF0872 | 185 | 8 | 72 | 2.61 | 3.98 | 0.87 | |
| BP3PBEF1624 | 63 | 16 | 24 | 2.61 | 1.83 | 0.58 | |
| BP3PBEF1630 | 66 | 16 | 30 | 2.61 | 2.30 | 0.73 | |
| BP3PBEF1636 | 88 | 16 | 36 | 2.61 | 2.76 | 0.87 | |
| BP3PBEF1642 | 92 | 16 | 42 | 2.61 | 3.22 | 1.02 | |
| BP3PBEF1648 | 165 | 16 | 48 | 2.61 | 3.68 | 1.16 | |
| BP3PBEF1654 | 169 | 16 | 54 | 2.61 | 4.14 | 1.31 | |
| BP3PBEF1660 | 172 | 16 | 60 | 2.61 | 4.61 | 1.45 | |
| BP3PBEF1666 | 176 | 16 | 66 | 2.61 | 5.07 | 1.60 | |
| BP3PBEF1672 | 185 | 16 | 72 | 2.61 | 5.53 | 1.74 | |

BP3PBEFP • Embedded Perforated PET Felt and Top Trim Kit

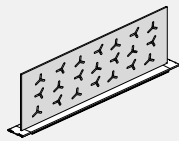

- **Embedded PET Felt and Top Trim Kit attaches on top of panels to add privacy or divide space.**
- Embedded PET Felt Top Trim Kit consist of the extruded aluminum channel, die-cast channel end covers, PET felt partition and hardware required to secure the trim to the panels horizontal channel.
- Specify standard metal paint finish.
- 9mm PET felt material is tackable and comes in 18 different colours. Please specify colour.
- NOTE: When specifying an application where two panels are side by side at different heights, a special is required to ensure proper fit.

| PRODUCT CODE | PRICE | | SIZE/INCHES | | | WEIGHT LBS | VOL FT ³ |
|--------------|-------|----|-------------|------|-----------------|------------|---------------------|
| | H | W | D | LBS | FT ³ | | |
| BP3PBEFP0824 | 126 | 8 | 24 | 2.61 | 1.32 | 0.29 | |
| BP3PBEFP0830 | 133 | 8 | 30 | 2.61 | 1.65 | 0.36 | |
| BP3PBEFP0836 | 175 | 8 | 36 | 2.61 | 1.99 | 0.44 | |
| BP3PBEFP0842 | 182 | 8 | 42 | 2.61 | 2.32 | 0.51 | |
| BP3PBEFP0848 | 330 | 8 | 48 | 2.61 | 2.65 | 0.58 | |
| BP3PBEFP0854 | 337 | 8 | 54 | 2.61 | 2.98 | 0.65 | |
| BP3PBEFP0860 | 345 | 8 | 60 | 2.61 | 3.32 | 0.73 | |
| BP3PBEFP0866 | 352 | 8 | 66 | 2.61 | 3.65 | 0.80 | |
| BP3PBEFP0872 | 371 | 8 | 72 | 2.61 | 3.98 | 0.87 | |
| BP3PBEFP1624 | 126 | 16 | 24 | 2.61 | 1.83 | 0.58 | |
| BP3PBEFP1630 | 133 | 16 | 30 | 2.61 | 2.30 | 0.73 | |
| BP3PBEFP1636 | 175 | 16 | 36 | 2.61 | 2.76 | 0.87 | |
| BP3PBEFP1642 | 182 | 16 | 42 | 2.61 | 3.22 | 1.02 | |
| BP3PBEFP1648 | 330 | 16 | 48 | 2.61 | 3.68 | 1.16 | |
| BP3PBEFP1654 | 337 | 16 | 54 | 2.61 | 4.14 | 1.31 | |
| BP3PBEFP1660 | 345 | 16 | 60 | 2.61 | 4.61 | 1.45 | |
| BP3PBEFP1666 | 352 | 16 | 66 | 2.61 | 5.07 | 1.60 | |
| BP3PBEFP1672 | 371 | 16 | 72 | 2.61 | 5.53 | 1.74 | |

BP3DS • Solid Door Panel

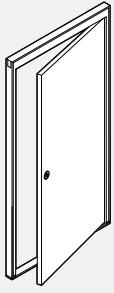

- **Aluminum frame with either high pressure laminate door.**
- 1 3/8" thick hollow core door.
- Actual door size:
79.9" x 32 1/2" in 82" x 36" frame
79.9" x 38 1/2" in 82" x 42" frame
- 42" wide Door Panel permits wheelchair accessibility.
- No hang-on capabilities.
- 180 degree swing.
- Specify Door Knob (DL01) or Door Lever (DL02).
- Lock standard.
- Handedness can be changed on site.
- Please specify Right hand (R) or Left hand (L) hung.
- Includes a Horizontal Lay-in Channel.

| PRODUCT CODE | PRICE HP | SIZE/ H | INCHES | | | WEIGHT VOL | |
|--------------|----------|---------|--------|------|-----|-----------------|--|
| | | | W | D | LBS | FT ³ | |
| BP3DS8236R | 2331 | 82 | 36 | 2.61 | 61 | 6.465 | |
| BP3DS8242R | 2539 | 82 | 42 | 2.61 | 68 | 7.486 | |
| BP3DS8236L | 2331 | 82 | 36 | 2.61 | 61 | 6.465 | |
| BP3DS8242L | 2539 | 82 | 42 | 2.61 | 68 | 7.486 | |

Door Hanging Directions

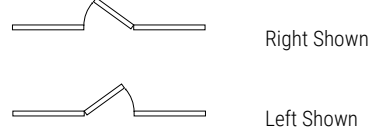

Door Handle Option

- Door Knob - DL01
- Lock Standard
- Door Lever - DL02 (Default)
- Lock Standard
- Lever complies with all accessibility standards



BP3DH • Half Glazed Door Panel

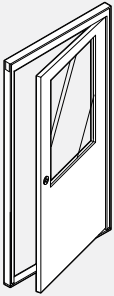

- **Aluminum frame with either high pressure laminate door and window.**
- 1 3/8" thick hollow core door.
- Actual door size:
79.9" x 32 1/2" in 82" x 36" frame
79.9" x 38 1/2" in 82" x 42" frame
- 42" wide Door Panel permits wheelchair accessibility.
- No hang-on capabilities.
- 180 degree swing.
- Specify Door Knob (DL01) or Door Lever (DL02).
- Lock standard.
- Handedness can be changed on site.
- Please specify Right hand (R) or Left hand (L) hung.
- For tempered glass option, add "TG" at the end of the product code and add an upcharge of \$149 for 36" wide doors and \$189 for 42" wide doors.
- Includes a Horizontal Lay-in Channel.

| PRODUCT CODE | PRICE HP | SIZE/ H | INCHES | | | WEIGHT VOL | |
|--------------|----------|---------|--------|------|-----|-----------------|--|
| | | | W | D | LBS | FT ³ | |
| BP3DH8236R | 2891 | 82 | 36 | 2.61 | 53 | 6.465 | |
| BP3DH8242R | 3160 | 82 | 42 | 2.61 | 59 | 7.486 | |
| BP3DH8236L | 2891 | 82 | 36 | 2.61 | 53 | 6.465 | |
| BP3DH8242L | 3160 | 82 | 42 | 2.61 | 59 | 7.486 | |

Door Hanging Directions

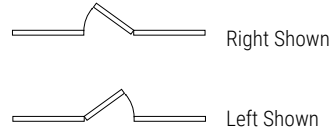

Door Handle Option

- Door Knob - DL01
- Lock Standard
- Door Lever - DL02 (Default)
- Lock Standard
- Lever complies with all accessibility standards



BP3DG • Full Glazed Door Panel

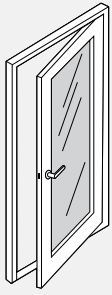

- Aluminum frame with either high pressure laminate door and window.
- 1 3/8" thick hollow core door.
- Actual door size:
79.9" x 32 1/2" in 82" x 36" frame
79.9" x 38 1/2" in 82" x 42" frame
- 42" wide Door Panel permits wheelchair accessibility.
- No hang-on capabilities.
- 180 degree swing.
- Specify Door Knob (DL01) or Door Lever (DL02).
- Lock standard.
- Handedness can be changed on site.
- Please specify Right hand (R) or Left hand (L) hung.
- For tempered glass option, add "TG" at the end of the product code and add an upcharge of \$302 for 36" wide doors and \$376 for 42" wide doors.
- Includes a Horizontal Lay-in Channel.
- Laminate frame is 5" thick at the sides and 4" at the top and bottom.

| PRODUCT CODE | PRICE | | SIZE/ INCHES | | | WEIGHT VOL | |
|--------------|-------|--|--------------|----|------|------------|-----------------|
| | HP | | H | W | D | LBS | FT ³ |
| BP3DG8236R | 3324 | | 82 | 36 | 2.61 | 53 | 6.465 |
| BP3DG8242R | 3637 | | 82 | 42 | 2.61 | 59 | 7.486 |
| BP3DG8236L | 3324 | | 82 | 36 | 2.61 | 53 | 6.465 |
| BP3DG8242L | 3637 | | 82 | 42 | 2.61 | 59 | 7.486 |

Door Hanging Directions



Right Shown

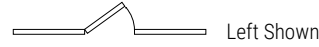

Left Shown

Door Handle Option

Door Knob - DL01

- Lock Standard

Door Lever - DL02 (Default)

- Lock Standard

- Lever complies with all accessibility standards



BPX3NET • Removable Face Tile - Electrical Tile Kit

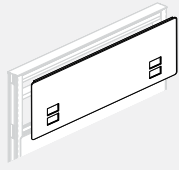
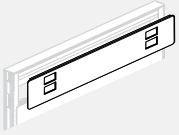

- Attaches to an 8" or 16" opening in a Pass-Thru Panel.
- Fabric covered tile with knock-out for power and data. (Data/Comm blank covers not included).
- 24" wide tiles have one duplex and one data/comm opening. 30" and wider tiles have two duplex and two data/comm openings.
- Easily interchangeable on site.
- Provides access to electrical and data at a required location.
- Specify Tile Electrical Kit separately.
- Duplexes and covers must be specified separately.
- For power outlets on both sides of the panel, specify two Electrical Tiles per panel. For power outlets on one side only, specify one Electrical Tile and a Fabric Tile for the opposite side.
- OPT* = Laminate or Whiteboard.
- For use on panels manufactured after November 1, 2014

| PRODUCT CODE | PRICE | | | SIZE/ INCHES | | | WEIGHT VOL | |
|--------------|-------|------|------|--------------|----|-------|------------|-----------------|
| | GR 1 | GR 2 | OPT* | H | W | D | LBS | FT ³ |
| BPX3NET0824 | 197 | 210 | 225 | 8 | 24 | 0.125 | 2.0 | 0.170 |
| BPX3NET0830 | 221 | 236 | 249 | 8 | 30 | 0.125 | 2.5 | 0.200 |
| BPX3NET0836 | 247 | 262 | 276 | 8 | 36 | 0.125 | 2.5 | 0.250 |
| BPX3NET0842 | 259 | 270 | 284 | 8 | 42 | 0.125 | 2.5 | 0.292 |
| BPX3NET0848 | 263 | 276 | 291 | 8 | 48 | 0.125 | 3.0 | 0.333 |
| BPX3NET0854 | 274 | 286 | 303 | 8 | 54 | 0.125 | 3.0 | 0.375 |
| BPX3NET0860 | 280 | 295 | 309 | 8 | 60 | 0.125 | 4.5 | 0.417 |
| BPX3NET0866 | 312 | 371 | 435 | 8 | 66 | 0.125 | 4.7 | 0.475 |
| BPX3NET0872 | 343 | 405 | - | 8 | 72 | 0.125 | 5.0 | 0.500 |
| BPX3NET1624 | 197 | 210 | 225 | 16 | 24 | 0.125 | 2.5 | 3.400 |
| BPX3NET1630 | 221 | 236 | 249 | 16 | 30 | 0.125 | 3.0 | 0.416 |
| BPX3NET1636 | 247 | 262 | 276 | 16 | 36 | 0.125 | 3.0 | 0.500 |
| BPX3NET1642 | 259 | 270 | 284 | 16 | 42 | 0.125 | 3.0 | 0.583 |
| BPX3NET1648 | 263 | 276 | 291 | 16 | 48 | 0.125 | 4.0 | 0.666 |
| BPX3NET1654 | 274 | 286 | 303 | 16 | 54 | 0.125 | 4.0 | 0.750 |
| BPX3NET1660 | 280 | 295 | 309 | 16 | 60 | 0.125 | 5.0 | 0.833 |
| BPX3NET1666 | 312 | 371 | 435 | 16 | 66 | 0.125 | 5.5 | 0.911 |
| BPX3NET1672 | 343 | 405 | - | 16 | 72 | 0.125 | 6.0 | 1.000 |

BP3GT • Removable Face Tile - Glazed

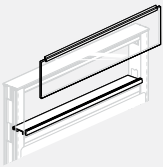

- Attaches to any opening in a Pass-Thru Panel.
- 8" or 16" high glazing provides visual accessibility and light transfer.
- Easily interchangeable on site.
- Specify one Glazed Tile for panel opening of corresponding width.
- Clear tempered glass standard.

| PRODUCT CODE | PRICE | | SIZE/ INCHES | | | WEIGHT VOL | |
|--------------|-------|------|--------------|----|------|------------|-----------------|
| | CLR | FRST | H | W | D | LBS | FT ³ |
| BP3GT0818 | 103 | 124 | 8 | 18 | 2.61 | 2.3 | 0.146 |
| BP3GT0824 | 115 | 138 | 8 | 24 | 2.61 | 3.1 | 0.165 |
| BP3GT0830 | 127 | 151 | 8 | 30 | 2.61 | 3.9 | 0.200 |
| BP3GT0836 | 148 | 178 | 8 | 36 | 2.61 | 4.7 | 0.250 |
| BP3GT0842 | 173 | 208 | 8 | 42 | 2.61 | 5.5 | 0.292 |
| BP3GT0848 | 200 | 238 | 8 | 48 | 2.61 | 6.3 | 0.333 |
| BP3GT0854 | 225 | 270 | 8 | 54 | 2.61 | 7.1 | 0.375 |
| BP3GT0860 | 249 | 301 | 8 | 60 | 2.61 | 7.8 | 0.417 |
| BP3GT0866 | 276 | 331 | 8 | 66 | 2.61 | 8.6 | 0.460 |
| BP3GT0872 | 301 | 363 | 8 | 72 | 2.61 | 9.4 | 0.500 |
| BP3GT1618 | 109 | 131 | 16 | 18 | 2.61 | 4.3 | 0.292 |
| BP3GT1624 | 125 | 149 | 16 | 24 | 2.61 | 5.8 | 0.333 |
| BP3GT1630 | 144 | 172 | 16 | 30 | 2.61 | 7.2 | 0.416 |
| BP3GT1636 | 174 | 210 | 16 | 36 | 2.61 | 8.7 | 0.500 |
| BP3GT1642 | 204 | 245 | 16 | 42 | 2.61 | 10.2 | 0.583 |
| BP3GT1648 | 235 | 280 | 16 | 48 | 2.61 | 11.6 | 0.666 |
| BP3GT1654 | 264 | 317 | 16 | 54 | 2.61 | 13.1 | 0.750 |
| BP3GT1660 | 295 | 352 | 16 | 60 | 2.61 | 14.6 | 0.833 |
| BP3GT1666 | 324 | 372 | 16 | 66 | 2.61 | 16.0 | 0.911 |
| BP3GT1672 | 352 | 406 | 16 | 72 | 2.61 | 17.5 | 1.000 |

BP3DGT • Removable Face Tile - Double Glazed

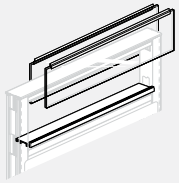

- Attaches to any opening in a Pass-Thru Panel.
- 8" or 16" high glazing provides visual accessibility and light transfer.
- Easily interchangeable on site.
- Specify one Double Glazed Tile for panel opening of corresponding width.
- Clear tempered glass standard.

| PRODUCT CODE | PRICE CLR | FRST | SIZE/ INCHES | | | WEIGHT LBS | VOL FT ³ |
|--------------|-----------|------|--------------|----|------|------------|---------------------|
| | | | H | W | D | | |
| BP3DGT0818 | 191 | 227 | 8 | 18 | 2.61 | 6.0 | 0.292 |
| BP3DGT0824 | 210 | 249 | 8 | 24 | 2.61 | 8.2 | 0.330 |
| BP3DGT0830 | 234 | 276 | 8 | 30 | 2.61 | 10.4 | 0.400 |
| BP3DGT0836 | 284 | 340 | 8 | 36 | 2.61 | 12.6 | 0.500 |
| BP3DGT0842 | 331 | 397 | 8 | 42 | 2.61 | 14.7 | 0.584 |
| BP3DGT0848 | 378 | 456 | 8 | 48 | 2.61 | 16.9 | 0.666 |
| BP3DGT0854 | 430 | 514 | 8 | 54 | 2.61 | 19.0 | 0.750 |
| BP3DGT0860 | 477 | 573 | 8 | 60 | 2.61 | 21.3 | 0.834 |
| BP3DGT0866 | 524 | 629 | 8 | 66 | 2.61 | 23.4 | 0.920 |
| BP3DGT0872 | 573 | 687 | 8 | 72 | 2.61 | 25.6 | 1.000 |
| BP3DGT1618 | 202 | 240 | 16 | 18 | 2.61 | 10.0 | 0.584 |
| BP3DGT1624 | 215 | 260 | 16 | 24 | 2.61 | 13.6 | 0.666 |
| BP3DGT1630 | 274 | 328 | 16 | 30 | 2.61 | 17.1 | 0.832 |
| BP3DGT1636 | 333 | 399 | 16 | 36 | 2.61 | 20.6 | 1.000 |
| BP3DGT1642 | 388 | 465 | 16 | 42 | 2.61 | 24.1 | 1.166 |
| BP3DGT1648 | 446 | 536 | 16 | 48 | 2.61 | 27.7 | 1.322 |
| BP3DGT1654 | 503 | 604 | 16 | 54 | 2.61 | 31.2 | 1.500 |
| BP3DGT1660 | 561 | 672 | 16 | 60 | 2.61 | 34.7 | 1.666 |
| BP3DGT1666 | 618 | 711 | 16 | 66 | 2.61 | 38.2 | 1.822 |
| BP3DGT1672 | 672 | 774 | 16 | 72 | 2.61 | 41.7 | 2.000 |

BP30T • Removable Face Tile - Open Pass-Thru Kit

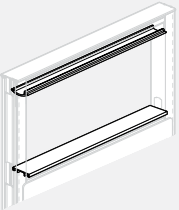

- Attaches to any opening in a Pass-Thru Panel.
- Trims and internal corners included to create an opening.
- Easily interchangeable on site.
- Specify one Pass-Thru Kit for panel opening of corresponding width.
- Kit works for 8" & 16" openings.
- Please specify panel frame colour.

| PRODUCT CODE | PRICE | SIZE/ INCHES | | | WEIGHT LBS | VOL FT ³ |
|--------------|-------|--------------|----|------|------------|---------------------|
| | | H | W | D | | |
| BP30T1618 | 19 | 16 | 18 | 2.61 | 0.4 | 0.292 |
| BP30T1624 | 22 | 16 | 24 | 2.61 | 0.6 | 0.333 |
| BP30T1630 | 27 | 16 | 30 | 2.61 | 0.8 | 0.416 |
| BP30T1636 | 31 | 16 | 36 | 2.61 | 1.0 | 0.500 |
| BP30T1642 | 35 | 16 | 42 | 2.61 | 1.1 | 0.583 |
| BP30T1648 | 41 | 16 | 48 | 2.61 | 1.3 | 0.666 |
| BP30T1654 | 45 | 16 | 54 | 2.61 | 1.5 | 0.750 |
| BP30T1660 | 48 | 16 | 60 | 2.61 | 1.7 | 0.833 |
| BP30T1666 | 54 | 16 | 66 | 2.61 | 1.9 | 0.911 |
| BP30T1672 | 56 | 16 | 72 | 2.61 | 2.0 | 1.000 |

BP3AT • Removable Face Tile - Accessory

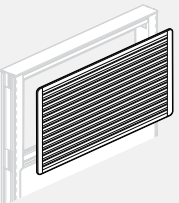

- Attaches to any opening in a Pass-Thru Panel.
- Provides support for accessories.
- Easily interchangeable on site.
- Two tile clips included.
- Specify two tiles per panel opening of corresponding width. Tiles can be combined. For example, Fabric Tile on one side and Accessory Tile on the opposite side of the same panel.
- Accessory Tile cannot be installed opposite an electrical tile.

| PRODUCT CODE | PRICE | SIZE/ INCHES | | | WEIGHT LBS | VOL FT ³ |
|--------------|-------|--------------|----|------|------------|---------------------|
| | | H | W | D | | |
| BP3AT0818 | 97 | 08 | 18 | 0.25 | 1.7 | 0.146 |
| BP3AT0824 | 115 | 08 | 24 | 0.25 | 2.3 | 0.167 |
| BP3AT0830 | 127 | 08 | 30 | 0.25 | 2.9 | 0.208 |
| BP3AT0836 | 149 | 08 | 36 | 0.25 | 3.5 | 0.250 |
| BP3AT0842 | 180 | 08 | 42 | 0.25 | 4.1 | 0.292 |
| BP3AT0848 | 211 | 08 | 48 | 0.25 | 4.7 | 0.333 |
| BP3AT0854 | 227 | 08 | 54 | 0.25 | 5.3 | 0.375 |
| BP3AT0860 | 259 | 08 | 60 | 0.25 | 5.9 | 0.417 |
| BP3AT0866 | 279 | 08 | 66 | 0.25 | 6.5 | 0.459 |
| BP3AT0872 | 303 | 08 | 72 | 0.25 | 7.0 | 0.500 |
| BP3AT1618 | 114 | 16 | 18 | 0.25 | 3.5 | 0.292 |
| BP3AT1624 | 138 | 16 | 24 | 0.25 | 4.7 | 0.333 |
| BP3AT1630 | 147 | 16 | 30 | 0.25 | 5.7 | 0.416 |
| BP3AT1636 | 178 | 16 | 36 | 0.25 | 7.0 | 0.500 |
| BP3AT1642 | 211 | 16 | 42 | 0.25 | 8.2 | 0.583 |
| BP3AT1648 | 245 | 16 | 48 | 0.25 | 9.4 | 0.666 |
| BP3AT1654 | 265 | 16 | 54 | 0.25 | 10.6 | 0.750 |
| BP3AT1660 | 304 | 16 | 60 | 0.25 | 11.9 | 0.833 |
| BP3AT1666 | 336 | 16 | 66 | 0.25 | 13.0 | 0.916 |
| BP3AT1672 | 366 | 16 | 72 | 0.25 | 14.0 | 1.000 |

BP3FT • Removable Face Tile - Fabric

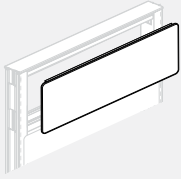

- Attaches to any opening in a Pass-Thru Panel.
- Tile clips included.
- Easily interchangeable on site.
- Specify two tiles per panel opening of corresponding width. Tiles can be combined. For example, Fabric Tile on one side and Accessory Tile on the opposite side of the same panel.
- OPT* = Laminate or Whiteboard.

| PRODUCT CODE | PRICE | | | SIZE/ INCHES | | | WEIGHT VOL | |
|--------------|-------|-----|------|--------------|----|------|------------|-----------------|
| | GR1 | GR2 | OPT* | H | W | D | LBS | FT ³ |
| BP3FT0818 | 92 | 100 | 108 | 8 | 18 | 0.25 | 1 | 0.146 |
| BP3FT0824 | 97 | 106 | 113 | 8 | 24 | 0.25 | 1 | 0.165 |
| BP3FT0830 | 106 | 117 | 134 | 8 | 30 | 0.25 | 2 | 0.200 |
| BP3FT0836 | 131 | 144 | 159 | 8 | 36 | 0.25 | 2 | 0.250 |
| BP3FT0842 | 139 | 151 | 169 | 8 | 42 | 0.25 | 2 | 0.292 |
| BP3FT0848 | 145 | 159 | 173 | 8 | 48 | 0.25 | 3 | 0.333 |
| BP3FT0854 | 153 | 169 | 181 | 8 | 54 | 0.25 | 3 | 0.375 |
| BP3FT0860 | 159 | 172 | 187 | 8 | 60 | 0.25 | 4 | 0.417 |
| BP3FT0866 | 180 | 239 | 305 | 8 | 66 | 0.25 | 4 | 0.460 |
| BP3FT0872 | 233 | 307 | - | 8 | 72 | 0.25 | 4 | 0.500 |
| BP3FT1618 | 103 | 110 | 116 | 16 | 18 | 0.25 | 2 | 0.292 |
| BP3FT1624 | 109 | 115 | 124 | 16 | 24 | 0.25 | 2 | 0.333 |
| BP3FT1630 | 116 | 132 | 146 | 16 | 30 | 0.25 | 3 | 0.416 |
| BP3FT1636 | 144 | 157 | 172 | 16 | 36 | 0.25 | 3 | 0.500 |
| BP3FT1642 | 153 | 169 | 181 | 16 | 42 | 0.25 | 3 | 0.583 |
| BP3FT1648 | 161 | 174 | 192 | 16 | 48 | 0.25 | 4 | 0.666 |
| BP3FT1654 | 170 | 181 | 199 | 16 | 54 | 0.25 | 4 | 0.750 |
| BP3FT1660 | 187 | 247 | 205 | 16 | 60 | 0.25 | 5 | 0.833 |
| BP3FT1666 | 205 | 264 | 329 | 16 | 66 | 0.25 | 5 | 0.920 |
| BP3FT1672 | 253 | 336 | - | 16 | 72 | 0.25 | 6 | 1.000 |

BP3OPFA • Fabric Over Panel

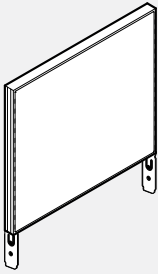

- Attaches to top of a panel to create floor-to-ceiling wall.
- Centre septum overlaid on either side with 1 1/8" "Sound absorbent mineral board".
- Exact height should be specified when ordering, with allowance of at least 1" of free space between over panel and ceiling to accommodate height variations in ceiling and floor. Can be any height from 4.4" minimum to 15.9" maximum. Please tag exact height required.
- Runs of over panels must be captured at either end with full height posts, wall adapters, taller panels, and/or vertical trims.
- OPT* = Laminate or Whiteboard.

| PRODUCT CODE | PRICE | | | SIZE/ INCHES | | | WEIGHT VOL | |
|--------------|-------|-----|------|--------------|----|------|------------|-----------------|
| | GR1 | GR2 | OPT* | H | W | D | LBS | FT ³ |
| BP3OPFA18 | 241 | 259 | 271 | 16 | 18 | 2.61 | 8 | 0.730 |
| BP3OPFA24 | 274 | 286 | 303 | 16 | 24 | 2.61 | 8 | 0.730 |
| BP3OPFA30 | 313 | 328 | 342 | 16 | 30 | 2.61 | 10 | 0.912 |
| BP3OPFA36 | 353 | 369 | 383 | 16 | 36 | 2.61 | 12 | 1.094 |
| BP3OPFA42 | 385 | 399 | 415 | 16 | 42 | 2.61 | 12 | 1.094 |
| BP3OPFA48 | 425 | 439 | 454 | 16 | 48 | 2.61 | 14 | 1.277 |
| BP3OPFA54 | 465 | 480 | 494 | 16 | 54 | 2.61 | 14 | 1.277 |
| BP3OPFA60 | 495 | 510 | 523 | 16 | 60 | 2.61 | 15 | 1.368 |

BP3OPFV • Fabric Over Panel with Vertical Wire Channel

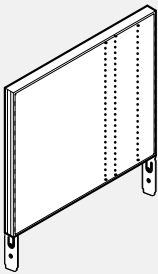

- Attaches to top of a panel to create floor-to-ceiling wall.
- Centre septum overlaid on either side with 1" sound absorbent mineral board.
- Exact height should be specified when ordering, with allowance of at least 1" of free space between over panel and ceiling to accommodate height variations in ceiling and floor. Can be any height from 4.4" minimum to 15.9" maximum. Please tag exact height required.
- Runs of over panels must be captured at either end with full height posts, wall adapters, taller panels, and/or vertical trims.
- OPT* = Laminate or Whiteboard.

| PRODUCT CODE | PRICE | | | SIZE/ INCHES | | | WEIGHT VOL | |
|--------------|-------|-----|------|--------------|----|------|------------|-----------------|
| | GR1 | GR2 | OPT* | H | W | D | LBS | FT ³ |
| BP3OPFV18 | 286 | 301 | 314 | 16 | 18 | 2.61 | 8 | 0.73 |
| BP3OPFV24 | 317 | 331 | 344 | 16 | 24 | 2.61 | 8 | 0.73 |
| BP3OPFV30 | 355 | 371 | 385 | 16 | 30 | 2.61 | 10 | 0.912 |
| BP3OPFV36 | 398 | 411 | 426 | 16 | 36 | 2.61 | 12 | 1.094 |
| BP3OPFV42 | 431 | 443 | 457 | 16 | 42 | 2.61 | 12 | 1.094 |
| BP3OPFV48 | 471 | 483 | 499 | 16 | 48 | 2.61 | 14 | 1.277 |
| BP3OPFV54 | 510 | 522 | 540 | 16 | 54 | 2.61 | 14 | 1.277 |
| BP3OPFV60 | 540 | 551 | 568 | 16 | 60 | 2.61 | 15 | 1.368 |

BA3PAS • Glass Over Panel with Round Pucks for System 3

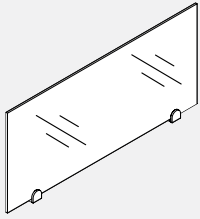

- **Glass Over Panel creates division.**
- Glass Over Panel with no frame sits on top of a System 3 Panel with clamps that are secured to the top of the panel.
- Tempered glass is 16" high.
- Custom sizes available, contact your Customer Service Representative.
- For application where the over panel is sandwiched between two taller panels, please request a special as the glass will not fit due to trims.

| PRODUCT CODE | PRICE CLR | FRST | SIZE/ INCHES | | | WEIGHT VOL | |
|--------------|-----------|------|--------------|----|-----|------------|-----------------|
| | | | H | W | D | LBS | FT ³ |
| BA3PAS0824 | 204 | 235 | 8 | 24 | 1.3 | 4 | 0.22 |
| BA3PAS0830 | 229 | 262 | 8 | 30 | 1.3 | 5 | 0.30 |
| BA3PAS0836 | 241 | 283 | 8 | 36 | 1.3 | 6 | 0.37 |
| BA3PAS0842 | 262 | 306 | 8 | 42 | 1.3 | 7 | 0.43 |
| BA3PAS0848 | 281 | 323 | 8 | 48 | 1.3 | 8 | 0.48 |
| BA3PAS1624 | 218 | 248 | 16 | 24 | 1.3 | 8 | 0.44 |
| BA3PAS1630 | 241 | 276 | 16 | 30 | 1.3 | 10 | 0.59 |
| BA3PAS1636 | 260 | 299 | 16 | 36 | 1.3 | 12 | 0.73 |
| BA3PAS1642 | 276 | 320 | 16 | 42 | 1.3 | 14 | 0.85 |
| BA3PAS1648 | 281 | 339 | 16 | 48 | 1.3 | 16 | 0.96 |

BA3PASS • Glass Over Panel with Square Pucks for System 3

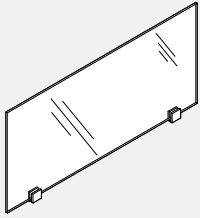

- **Glass Over Panel creates division.**
- Glass Over Panel with no frame sits on top of a System 3 Panel with clamps that are secured to the top of the panel.
- Tempered glass is 16" high.
- Custom sizes available, contact your Customer Service Representative.
- For application where the over panel is sandwiched between two taller panels, please request a special as the glass will not fit due to trims.

| PRODUCT CODE | PRICE CLR | FRST | SIZE/ INCHES | | | WEIGHT VOL | |
|--------------|-----------|------|--------------|----|-----|------------|-----------------|
| | | | H | W | D | LBS | FT ³ |
| BA3PASS0824 | 218 | 248 | 8 | 24 | 1.3 | 4 | 0.22 |
| BA3PASS0830 | 241 | 276 | 8 | 30 | 1.3 | 5 | 0.30 |
| BA3PASS0836 | 262 | 299 | 8 | 36 | 1.3 | 6 | 0.37 |
| BA3PASS0842 | 276 | 320 | 8 | 42 | 1.3 | 7 | 0.43 |
| BA3PASS0848 | 298 | 339 | 8 | 48 | 1.3 | 8 | 0.48 |
| BA3PASS1624 | 235 | 264 | 16 | 24 | 1.3 | 8 | 0.44 |
| BA3PASS1630 | 260 | 291 | 16 | 30 | 1.3 | 10 | 0.59 |
| BA3PASS1636 | 274 | 313 | 16 | 36 | 1.3 | 12 | 0.73 |
| BA3PASS1642 | 291 | 338 | 16 | 42 | 1.3 | 14 | 0.85 |
| BA3PASS1648 | 299 | 352 | 16 | 48 | 1.3 | 16 | 0.96 |

BPMB • Raceway Cover Caps



- **To provide clean detail for the punch-outs of a raceway cover when the punch-outs are not in use. Order only when required.**
- Made of injection molded ABS.
- B = Black
- G = Grey
- W = White

| PRODUCT CODE | PRICE | SIZE/ INCHES | | | WEIGHT VOL | |
|--------------|-------|--------------|---|-------|------------|-----------------|
| | | H | W | D | LBS | FT ³ |
| BPMB020104B | 10 | 1.5 | 3 | 0.125 | 0.04 | 0.02 |
| BPMB020104G | 10 | 1.5 | 3 | 0.125 | 0.04 | 0.02 |
| BPMB020104W | 10 | 1.5 | 3 | 0.125 | 0.04 | 0.02 |

BH3PS • 90 Degree Post



- **Enables connection for multiple panel runs such as 90°, 3 way and 4 way.**
- Includes 2 "Capture Strip" panel connectors, 4 end strips, 2 pairs of raceway end caps, and 1 post cap.
- Posts are designed to accept the following:
 - 75 cables 5.6mm (0.220") diameter
 - 60 ccables 5.6mm (0.220") diameter with 1 power feed
 - 45 cables 5.6mm (0.220") diameter with 2 power feeds

| PRODUCT CODE | PRICE | SIZE/ INCHES | | | WEIGHT VOL | |
|--------------|-------|--------------|------|------|------------|-----------------|
| | | H | W | D | LBS | FT ³ |
| BH3PS034 | 126 | 27 | 2.61 | 2.61 | 4 | 0.14 |
| BH3PS042 | 138 | 35 | 2.61 | 2.61 | 5 | 0.18 |
| BH3PS050 | 156 | 43 | 2.61 | 2.61 | 7 | 0.22 |
| BH3PS054 | 174 | 47 | 2.61 | 2.61 | 7 | 0.27 |
| BH3PS058 | 179 | 51 | 2.61 | 2.61 | 8 | 0.29 |
| BH3PS066 | 187 | 59 | 2.61 | 2.61 | 8 | 0.31 |

BH3PS45 • 45 Degree Post



- **Enables connection for two panels at 45°.**
- Includes 2 "Capture Strip" panel connectors and 1 post cap.
- 45 degree post does not accept End Trim.
- No power infeed capabilities.
- Posts are designed to accept the following:
 - 30 cables 5.6mm (0.220") diameter

| PRODUCT CODE | PRICE | SIZE/ INCHES | | | WEIGHT VOL | |
|--------------|-------|--------------|------|------|------------|-----------------|
| | | H | W | D | LBS | FT ³ |
| BH3PS45034 | 126 | 27 | 2.61 | 2.61 | 4 | 0.14 |
| BH3PS45042 | 138 | 35 | 2.61 | 2.61 | 5 | 0.18 |
| BH3PS45050 | 156 | 43 | 2.61 | 2.61 | 7 | 0.22 |
| BH3PS45054 | 174 | 47 | 2.61 | 2.61 | 7 | 0.27 |
| BH3PS45058 | 179 | 51 | 2.61 | 2.61 | 8 | 0.29 |
| BH3PS45066 | 187 | 59 | 2.61 | 2.61 | 8 | 0.31 |

BH3PS60 • 60 Degree Post



- **Enables connection for multiple panel runs such as 120° and 3 way.**
- Includes 2 "Capture Strip" panel connectors and 1 post cap.
- No power infeed capabilities.
- Posts are designed to accept the following:
 - 35 cables 5.6mm (0.220") diameter

| PRODUCT CODE | PRICE | SIZE/ INCHES | | | WEIGHT VOL | |
|--------------|-------|--------------|------|------|------------|-----------------|
| | | H | W | D | LBS | FT ³ |
| BH3PS60034 | 126 | 27 | 2.61 | 2.61 | 4 | 0.14 |
| BH3PS60042 | 138 | 35 | 2.61 | 2.61 | 5 | 0.18 |
| BH3PS60050 | 156 | 43 | 2.61 | 2.61 | 7 | 0.22 |
| BH3PS60054 | 174 | 47 | 2.61 | 2.61 | 7 | 0.27 |
| BH3PS60058 | 179 | 51 | 2.61 | 2.61 | 8 | 0.29 |
| BH3PS60066 | 187 | 59 | 2.61 | 2.61 | 8 | 0.31 |

BH3PE • Post Extension for Over Panels

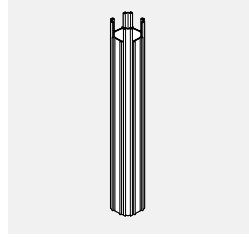

- Provides route for ceiling data or electrical cables through the post to the panel.
- Includes 2 "Capture Strip" panel connectors.

| PRODUCT CODE | PRICE | SIZE/ INCHES | | | WEIGHT VOL | |
|--------------|-------|--------------|------|------|------------|-----------------|
| | | H | W | D | LBS | FT ³ |
| BH3PE008 | 30 | 8 | 2.61 | 2.61 | 1 | 0.03 |
| BH3PE016 | 54 | 16 | 2.61 | 2.61 | 2 | 0.07 |
| BH3PE032 | 78 | 32 | 2.61 | 2.61 | 4 | 0.14 |
| BH3PE45016 | 54 | 16 | 2.61 | 2.61 | 2 | 0.07 |
| BH3PE45032 | 78 | 32 | 2.61 | 2.61 | 4 | 0.14 |
| BH3PE60016 | 54 | 16 | 2.61 | 2.61 | 2 | 0.07 |
| BH3PE60032 | 78 | 32 | 2.61 | 2.61 | 4 | 0.14 |

BH3PA • Off-Module Connector (Panel to Panel Adapter)

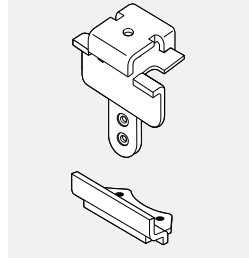

- Connects Boulevard System 3 panel to another perpendicular Boulevard System 3 Monolithic Panel off-module.
- Top and bottom brackets bolt to panel vertical of one panel and engage to top and bottom "fabric" edges of adjacent, perpendicular Monolithic Panel of even height.
- While connecting tile panel to Monolithic Panel is possible, never attempt to secure Off-Module Connectors to a tile panel.
- Once an off-module panel is secure to Monolithic Panel spine with Off-Module Connecting Kit, the raceway on the spine panel cannot be accessed and can only be opened from the opposite side.
- Special top trim required, provide application to your Customer Service Representative.
- This connector is not a load-bearing connection.
- Not to be used on the panel seam, with over panels or laminate and metal faced panels.

| PRODUCT CODE | PRICE | SIZE/ H | INCHES | | WEIGHT VOL | |
|--------------|-------|---------|--------|---|------------|-----------------|
| | | | W | D | LBS | FT ³ |
| BH3PA02 | 93 | 3.5 | | | 0.5 | 0.035 |

RCX3WMP2 • Raceway Cover with Punchouts Both Sides

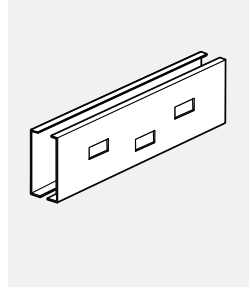

- Metal raceway organizes cables at the base.
- Snaps directly into the base of the panel.
- When opened, cover's side rests on the floor, providing unobstructed access to data/power installation.
- 18" Raceway Covers do not have power and data/communication punch-outs.
- 24" Raceway covers have electrical and one data opening.
- Data opening sizing is as follows: 1.38" x 2.71".
- Comes standard with all System 3 panels.
- "No Knockouts" option for raceways available at no additional charge. Please choose option for interior and/or exterior raceways.

| PRODUCT CODE | PRICE | SIZE/ INCHES | | | WEIGHT VOL | |
|--------------|-------|--------------|----|------|------------|-----------------|
| | | H | W | D | LBS | FT ³ |
| RCX3WM24P2 | 63 | 5.62 | 24 | 2.61 | 3.3 | 0.21 |
| RCX3WM30P2 | 68 | 5.62 | 30 | 2.61 | 4.1 | 0.26 |
| RCX3WM36P2 | 78 | 5.62 | 36 | 2.61 | 4.9 | 0.31 |
| RCX3WM42P2 | 90 | 5.62 | 42 | 2.61 | 5.7 | 0.36 |
| RCX3WM48P2 | 95 | 5.62 | 48 | 2.61 | 6.6 | 0.42 |
| RCX3WM54P2 | 104 | 5.62 | 54 | 2.61 | 7.4 | 0.47 |
| RCX3WM60P2 | 113 | 5.62 | 60 | 2.61 | 8.3 | 0.52 |
| RCX3WM66P2 | 117 | 5.62 | 66 | 2.61 | 9.1 | 0.57 |
| RCX3WM72P2 | 127 | 5.62 | 72 | 2.61 | 9.8 | 0.62 |

RCX3WMP1 • Raceway Cover with Punchouts One Side, None Other Side

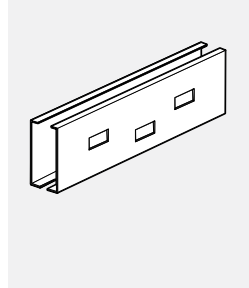

- Metal raceway organizes cables at the base.
- Snaps directly into the base of the panel.
- When opened, cover's side rests on the floor, providing unobstructed access to data/power installation.
- 18" Raceway Covers do not have power and data/communication punch-outs.
- 24" Raceway covers have electrical and one data opening.
- Data opening sizing is as follows: 1.38" x 2.71".
- Comes standard with all System 3 panels.
- "No Knockouts" option for raceways available at no additional charge. Please choose option for interior and/or exterior raceways.

| PRODUCT CODE | PRICE | SIZE/ INCHES | | | WEIGHT VOL | |
|--------------|-------|--------------|----|------|------------|-----------------|
| | | H | W | D | LBS | FT ³ |
| RCX3WM24P1 | 63 | 5.62 | 24 | 2.61 | 3.3 | 0.21 |
| RCX3WM30P1 | 68 | 5.62 | 30 | 2.61 | 4.1 | 0.26 |
| RCX3WM36P1 | 78 | 5.62 | 36 | 2.61 | 4.9 | 0.31 |
| RCX3WM42P1 | 90 | 5.62 | 42 | 2.61 | 5.7 | 0.36 |
| RCX3WM48P1 | 95 | 5.62 | 48 | 2.61 | 6.6 | 0.42 |
| RCX3WM54P1 | 104 | 5.62 | 54 | 2.61 | 7.4 | 0.47 |
| RCX3WM60P1 | 113 | 5.62 | 60 | 2.61 | 8.3 | 0.52 |
| RCX3WM66P1 | 117 | 5.62 | 66 | 2.61 | 9.1 | 0.57 |
| RCX3WM72P1 | 127 | 5.62 | 72 | 2.61 | 9.8 | 0.62 |

RCX3WMNP • Raceway Cover with No Punchouts Both Sides

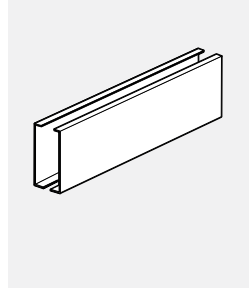

- Metal raceway organizes cables at the base.
- Snaps directly into the base of the panel.
- When opened, cover's side rests on the floor, providing unobstructed access to data/power installation.
- Specified separately for reconfiguration purposes.

| PRODUCT CODE | PRICE | SIZE/ INCHES | | | WEIGHT VOL | |
|--------------|-------|--------------|----|------|------------|-----------------|
| | | H | W | D | LBS | FT ³ |
| RCX3WM18NP | 56 | 5.62 | 18 | 2.61 | 2.4 | 0.16 |
| RCX3WM24NP | 63 | 5.62 | 24 | 2.61 | 3.3 | 0.21 |
| RCX3WM30NP | 68 | 5.62 | 30 | 2.61 | 4.1 | 0.26 |
| RCX3WM36NP | 78 | 5.62 | 36 | 2.61 | 4.9 | 0.31 |
| RCX3WM42NP | 90 | 5.62 | 42 | 2.61 | 5.7 | 0.36 |
| RCX3WM48NP | 95 | 5.62 | 48 | 2.61 | 6.6 | 0.42 |
| RCX3WM54NP | 104 | 5.62 | 54 | 2.61 | 7.4 | 0.47 |
| RCX3WM60NP | 113 | 5.62 | 60 | 2.61 | 8.3 | 0.52 |
| RCX3WM66NP | 117 | 5.62 | 66 | 2.61 | 9.1 | 0.57 |
| RCX3WM72NP | 127 | 5.62 | 72 | 2.61 | 9.8 | 0.62 |

B3HWA • Wall Adapter

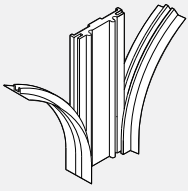

- Starts a run of panels off an existing wall.
- Includes 2 "Capture Strip" panel connectors and 1 pair of raceway end caps.
- Mounting hardware not included.
- Mounting hardware selection should be based on wall or wall stud material.
- Wall Adapter adds 5/16" to a panels run.

| PRODUCT CODE | PRICE | SIZE/ INCHES | | | WEIGHT VOL | |
|--------------|-------|--------------|------|-------|------------|-----------------|
| | | H | W | D | LBS | FT ³ |
| B3HWA034 | 61 | 34 | 2.61 | 0.375 | 2 | 0.011 |
| B3HWA042 | 64 | 42 | 2.61 | 0.375 | 3 | 0.015 |
| B3HWA050 | 68 | 50 | 2.61 | 0.375 | 3 | 0.018 |
| B3HWA054 | 74 | 54 | 2.61 | 0.375 | 3 | 0.020 |
| B3HWA058 | 78 | 58 | 2.61 | 0.375 | 4 | 0.021 |
| B3HWA066 | 80 | 66 | 2.61 | 0.375 | 4 | 0.021 |

BHWASL • Adapter Sleeve



- Wall Adapter Sleeve is attached to the building to provide flexible support to a panel run.
- As opposed to the BHW wall adapter, which connects to the panels rigidly to a wall, B1 and B3 Boulevard panels rest inside of the vertical "U" channel, providing up to 3.5" of flexible adjustment.
- For panel runs taller than 66" order two Wall Adapter Sleeves and either have it cut short on the site below ceiling, or cut a rectangular hole in the ceiling tile. Rectangular slots in the Channels correspond to 66", 58", 54", 50" and 42" high B1 and B3 panels.
- Powder coated steel; specify metal finish.

| PRODUCT CODE | PRICE | SIZE/ INCHES | | | WEIGHT VOL | |
|--------------|-------|--------------|---|---|------------|-----------------|
| | | H | W | D | LBS | FT ³ |
| BHWASL42 | 149 | 34.7 | 4 | 2 | 2.5 | 0.161 |
| BHWASL50 | 162 | 42.7 | 4 | 2 | 3.6 | 0.148 |
| BHWASL54 | 170 | 46.7 | 4 | 2 | 4.2 | 0.216 |
| BHWASL58 | 174 | 52.7 | 4 | 2 | 5.1 | 0.244 |
| BHWASL66 | 187 | 58.7 | 4 | 2 | 6.0 | 0.272 |

- Note: the Wall Adapter Sleeve provides flexible, non-structural connection, blocks vertical 1" increment clots and cannot, therefore, be used to support overheads and work surfaces, they must be supported by perpendicular panels, c-legs or gables.
- Note: no fasteners are provided with the Wall Adapter Sleeve. Select the appropriate fasteners according to a structurally sound connection.
- Cannot be used to support a door or panel and cannot be used with laminate, airflow or metal skin panels.

BH3CS • Capture Strip Slot Cover

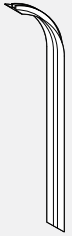

- An extruded PVC channel to adjoin two panels or a panel to a post. Runs the full length of the panel on both sides providing a positive connection of the "Knuckle-Loc" design.
- Priced per pair.
- Pliable side membranes cover panel slots.
- Included with panel components.
- Only to be ordered separately if required.

| PRODUCT CODE | PRICE | SIZE/ INCHES | | WEIGHT VOL | |
|--------------|-------|--------------|--|------------|-----------------|
| | | H | | LBS | FT ³ |
| BH3CS34 | 12 | 37 | | 0.24 | 0.11 |
| BH3CS42 | 12 | 42 | | 0.28 | 0.13 |
| BH3CS50 | 13 | 50 | | 0.33 | 0.15 |
| BH3CS54 | 13 | 54 | | 0.31 | 0.17 |
| BH3CS66 | 21 | 66 | | 0.4 | 0.19 |

BH3CE • End Strip Slot Cover



- End strips with pliable side membrane covers panel slots at end of run.
- Priced per pair.
- Included with panel components.
- Only to be ordered separately if required.

| PRODUCT CODE | PRICE | SIZE/ INCHES | | WEIGHT VOL | |
|--------------|-------|--------------|--|------------|-----------------|
| | | H | | LBS | FT ³ |
| BH3CE34 | 12 | 37 | | 0.12 | 0.05 |
| BH3CE42 | 12 | 42 | | 0.14 | 0.06 |
| BH3CE50 | 13 | 50 | | 0.16 | 0.07 |
| BH3CE54 | 13 | 54 | | 0.31 | 0.08 |
| BH3CE66 | 14 | 66 | | 0.20 | 0.09 |

BA3VTR • Vertical Aluminum End Trim



- Finishes the vertical edges of panels and posts (90 and 60 degree).
- In the case of the panel, the trim runs from the top of the panel to the bottom of the raceway, enclosing the horizontal channel openings and the raceway opening.
- In the case of the Over Panel, the trim runs from the top of the Over Panel to the bottom of the Over Panel, enclosing the horizontal channel openings.

| PRODUCT CODE | PRICE | TYPE | SIZE/ INCHES | | | WEIGHT VOL | |
|--------------|-------|---------------|--------------|------|------|------------|-----------------|
| | | | H | W | D | LBS | FT ³ |
| BA3VTR34 | 38 | REGULAR PANEL | 34 | 2.61 | 0.25 | 1.1 | 0.03 |
| BA3VTR42 | 46 | | 42 | 2.61 | 0.25 | 1.4 | 0.03 |
| BA3VTR50 | 56 | | 50 | 2.61 | 0.25 | 1.7 | 0.04 |
| BA3VTR54 | 64 | | 54 | 2.61 | 0.25 | 1.9 | 0.04 |
| BA3VTR58 | 67 | | 58 | 2.61 | 0.25 | 2.1 | 0.05 |
| BA3VTR66 | 75 | | 66 | 2.61 | 0.25 | 2.2 | 0.05 |
| BA3VTE16 | 24 | OVER PANEL | 16 | 2.61 | 0.25 | 0.5 | 0.03 |
| BA3VTE32 | 38 | | 32 | 2.61 | 0.25 | 1.1 | 0.06 |

BA3VTS • Vertical Aluminum End Trim Standard Step Down



- Finishes the vertical edges of panels and posts (90 and 60 degree).
- Trims run from the top of one panel to the top of lower panel enclosing the horizontal channel opening.

| PRODUCT CODE | PRICE | SIZE/ INCHES | | | WEIGHT VOL | |
|--------------|-------|--------------|------|------|------------|-----------------|
| | | H | W | D | LBS | FT ³ |
| BA3VTS04 | 12 | 4 | 2.61 | 0.25 | 0.2 | 0.010 |
| BA3VTS08 | 14 | 8 | 2.61 | 0.25 | 0.3 | 0.015 |
| BA3VTS12 | 21 | 12 | 2.61 | 0.25 | 0.4 | 0.022 |
| BA3VTS16 | 24 | 16 | 2.61 | 0.25 | 0.5 | 0.030 |
| BA3VTS20 | 29 | 20 | 2.61 | 0.25 | 0.7 | 0.039 |
| BA3VTS24 | 31 | 24 | 2.61 | 0.25 | 0.9 | 0.045 |
| BA3VTS32 | 38 | 32 | 2.61 | 0.25 | 1.1 | 0.060 |

BV3VTR • Vertical PVC End Trim



- Finishes the vertical edges of panels and posts (90 and 60 degree).
- In the case of the panel, the trim runs from the top of the panel to the bottom of the raceway, enclosing the horizontal channel openings and the raceway opening.
- In the case of the over panel, the trim runs from the top of the over panel to the bottom of the over panel, enclosing the horizontal channel openings.

| PRODUCT CODE | PRICE | TYPE | SIZE/ INCHES | | | WEIGHT VOL | |
|--------------|-------|---------------|--------------|------|------|------------|-----------------|
| | | | H | W | D | LBS | FT ³ |
| BV3VTR34 | 29 | REGULAR PANEL | 34 | 2.61 | 0.25 | 0.6 | 0.030 |
| BV3VTR42 | 30 | | 42 | 2.61 | 0.25 | 0.7 | 0.030 |
| BV3VTR50 | 35 | | 50 | 2.61 | 0.25 | 0.9 | 0.040 |
| BV3VTR54 | 37 | | 54 | 2.61 | 0.25 | 1.0 | 0.045 |
| BV3VTR58 | 40 | | 58 | 2.61 | 0.25 | 1.0 | 0.047 |
| BV3VTR66 | 43 | | 66 | 2.61 | 0.25 | 1.1 | 0.050 |
| BV3VTE16 | 22 | OVER PANEL | 16 | 2.61 | 0.25 | 0.3 | 0.030 |
| BV3VTE32 | 29 | | 32 | 2.61 | 0.25 | 0.6 | 0.060 |

BV3VTS • Vertical PVC End Trim Standard Step Down



- Finishes the vertical edges of panels and posts (90 and 60 degree).
- Trims run from the top of one panel to the top of lower panel enclosing the horizontal channel opening.

| PRODUCT CODE | PRICE | SIZE/ INCHES | | | WEIGHT VOL | |
|--------------|-------|--------------|------|------|------------|-----------------|
| | | H | W | D | LBS | FT ³ |
| BV3VTS04 | 12 | 3.75 | 2.61 | 0.25 | 0.1 | 0.010 |
| BV3VTS08 | 14 | 7.75 | 2.61 | 0.25 | 0.1 | 0.015 |
| BV3VTS12 | 21 | 11.75 | 2.61 | 0.25 | 0.2 | 0.020 |
| BV3VTS16 | 23 | 15.75 | 2.61 | 0.25 | 0.3 | 0.030 |
| BV3VTS20 | 30 | 19.75 | 2.61 | 0.25 | 0.3 | 0.035 |
| BV3VTS24 | 25 | 23.75 | 2.61 | 0.25 | 0.4 | 0.045 |
| BV3VTS32 | 29 | 31.75 | 2.61 | 0.25 | 0.6 | 0.060 |

BA3VTRF • Vertical Aluminum Flat End Trim

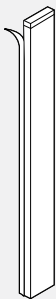

- Finishes the vertical edges of panels and posts (90 and 60 degree).
- In the case of the panel, the trim runs from the top of the panel to the bottom of the raceway, enclosing the horizontal channel openings and the raceway opening.
- In the case of the over panel, the trim runs from the top of the over panel to the bottom of the over panel, enclosing the horizontal channel openings.
- BABVTRF119 cannot ship via courier and must be combined with other product.

| PRODUCT CODE | PRICE | TYPE | SIZE/ INCHES | | | WEIGHT VOL | |
|--------------|-------|---------------|--------------|------|-------|------------|-----------------|
| | | | H | W | D | LBS | FT ³ |
| BA3VTRF34 | 38 | REGULAR PANEL | 34 | 2.61 | 0.125 | 1.1 | 0.03 |
| BA3VTRF42 | 46 | | 42 | 2.61 | 0.125 | 1.4 | 0.03 |
| BA3VTRF50 | 56 | | 50 | 2.61 | 0.125 | 1.7 | 0.04 |
| BA3VTRF54 | 64 | | 54 | 2.61 | 0.125 | 1.9 | 0.04 |
| BA3VTRF58 | 67 | | 58 | 2.61 | 0.125 | 1.9 | 0.04 |
| BA3VTRF66 | 69 | | 66 | 2.61 | 0.125 | 2.2 | 0.05 |
| BA3VTRF119 | 134 | | 119 | 2.61 | 0.125 | 3.6 | 0.08 |
| BA3VTEF8 | 11 | OVER PANEL | 8 | 2.61 | 0.125 | 0.2 | 0.01 |
| BA3VTEF16 | 24 | | 16 | 2.61 | 0.125 | 0.5 | 0.03 |
| BA3VTEF32 | 38 | | 32 | 2.61 | 0.125 | 1.1 | 0.06 |

BA3VTSF • Vertical Aluminum Flat End Trim Standard Step Down

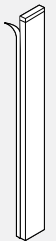

- Finishes the vertical edges of panels and posts (90 and 60 degree).
- Trims run from the top of one panel to the top of lower panel enclosing the horizontal channel opening.

| PRODUCT CODE | PRICE | SIZE/ INCHES | | | WEIGHT VOL | |
|--------------|-------|--------------|------|-------|------------|-----------------|
| | | H | W | D | LBS | FT ³ |
| BA3VTSF04 | 12 | 3.75 | 2.61 | 0.125 | 0.1 | 0.010 |
| BA3VTSF08 | 14 | 7.75 | 2.61 | 0.125 | 0.3 | 0.015 |
| BA3VTSF12 | 21 | 11.75 | 2.61 | 0.125 | 0.4 | 0.020 |
| BA3VTSF16 | 24 | 15.75 | 2.61 | 0.125 | 0.5 | 0.030 |
| BA3VTSF20 | 29 | 19.75 | 2.61 | 0.125 | 0.8 | 0.035 |
| BA3VTSF24 | 31 | 23.75 | 2.61 | 0.125 | 0.9 | 0.045 |
| BA3VTSF32 | 38 | 31.75 | 2.61 | 0.125 | 1.1 | 0.060 |

B3LEP-NC • End of Run Gallery Panel in a T configuration, No Connectors for Additional Gallery Panels

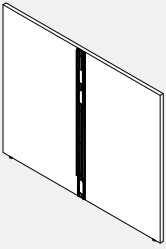

- Provides floor standing support while enclosing the end of a panel run on two sides.
- Attaches to the end of a Boulevard 1 or System 3 Panel with capture strips to form a T configuration.
- Connection is on the interior face center.
- Includes all attachment hardware and glides.
- Total height is inclusive of panel glides extended to their full height.
- 51" wide gallery panel accommodates two 24" deep surfaces while the 63" wide accommodates two 30" deep surfaces and 75" wide two 36" deep surfaces.
- Please specify LP laminate finish and PVC edge finish.
- If a wood grain laminate is chosen, grain direction run horizontally.
- Edged in PVC on three exposed edges and self edged on bottom.

| PRODUCT CODE | PRICE LP | SIZE /INCHES | | | WEIGHT LBS | VOL FT³ |
|--------------|----------|--------------|------|---|------------|---------|
| | | H | W | D | | |
| B3LEP4227NC | 416 | 42 | 26.5 | 1 | 29.49 | 0.64 |
| B3LEP4251NC | 653 | 42 | 51 | 1 | 55.17 | 1.24 |
| B3LEP4263NC | 731 | 42 | 63 | 1 | 68.01 | 1.53 |
| B3LEP4275NC | 814 | 42 | 75 | 1 | 80.86 | 1.82 |
| B3LEP5027NC | 485 | 50 | 26.5 | 1 | 35.25 | 0.77 |
| B3LEP5051NC | 758 | 50 | 51 | 1 | 65.92 | 1.48 |
| B3LEP5063NC | 854 | 50 | 63 | 1 | 81.27 | 1.82 |
| B3LEP5075NC | 964 | 50 | 75 | 1 | 96.62 | 2.17 |
| B3LEP5427NC | 485 | 54 | 26.5 | 1 | 38.12 | 0.83 |
| B3LEP5451NC | 781 | 54 | 51 | 1 | 71.3 | 1.59 |
| B3LEP5463NC | 880 | 54 | 63 | 1 | 87.9 | 1.97 |
| B3LEP5475NC | 994 | 54 | 75 | 1 | 104.49 | 2.34 |

B3LSEPL-NC • Left End of Run Single Gallery Panel in L Configuration, No Connectors for Additional Gallery Panels



- Provides floor standing support while enclosing the end of a panel run on one side.
- Attaches to the end of a Boulevard 1 or System 3 Panel with capture strips to form an L configuration.
- Connection is on interior face near it's right end.
- Includes all attachment hardware and glides.
- Total height is inclusive of panel glides extended to their full height.
- 27" wide gallery panel accommodates a 24" deep surface while the 33" wide accommodates a 30" deep surface and 39" wide a 36" deep surface.
- Please specify LP laminate finish and PVC edge finish.
- If a wood grain laminate is chosen, grain direction run horizontally.
- Edged in PVC on three exposed edges and self edged on bottom.

| PRODUCT CODE | PRICE LP | SIZE /INCHES | | | WEIGHT LBS | VOL FT³ |
|---------------|----------|--------------|-------|---|------------|---------|
| | | H | W | D | | |
| B3LSEPL4215NC | 342 | 42 | 14.25 | 1 | 16.64 | 0.35 |
| B3LSEPL4227NC | 497 | 42 | 27 | 1 | 29.47 | 0.66 |
| B3LSEPL4233NC | 537 | 42 | 33 | 1 | 35.89 | 0.80 |
| B3LSEPL4239NC | 564 | 42 | 39 | 1 | 42.32 | 0.95 |
| B3LSEPL5015NC | 389 | 50 | 14.25 | 1 | 19.9 | 0.41 |
| B3LSEPL5027NC | 565 | 50 | 27 | 1 | 35.23 | 0.78 |
| B3LSEPL5033NC | 613 | 50 | 33 | 1 | 42.9 | 0.95 |
| B3LSEPL5039NC | 656 | 50 | 39 | 1 | 50.57 | 1.13 |
| B3LSEPL5415NC | 389 | 54 | 14.25 | 1 | 21.52 | 0.45 |
| B3LSEPL5427NC | 582 | 54 | 27 | 1 | 38.1 | 0.84 |
| B3LSEPL5433NC | 632 | 54 | 33 | 1 | 46.4 | 1.03 |
| B3LSEPL5439NC | 677 | 54 | 39 | 1 | 54.7 | 1.22 |

B3LSEPR-NC • Right End of Run Single Gallery Panel in L Configuration, No Connectors for Additional Gallery Panels



- Provides floor standing support while enclosing the end of a panel run on one side.
- Attaches to the end of a Boulevard 1 or System 3 Panel with capture strips to form an L configuration.
- Connection is on interior face near it's right end.
- Includes all attachment hardware and glides.
- Total height is inclusive of panel glides extended to their full height.
- 27" wide gallery panel accommodates a 24" deep surface while the 33" wide accommodates a 30" deep surface and 39" wide a 36" deep surface.
- Please specify LP laminate finish and PVC edge finish.
- If a wood grain laminate is chosen, grain direction run horizontally.
- Edged in PVC on three exposed edges and self edged on bottom.

| PRODUCT CODE | PRICE LP | SIZE /INCHES | | | WEIGHT LBS | VOL FT³ |
|---------------|----------|--------------|-------|---|------------|---------|
| | | H | W | D | | |
| B3LSEPR4215NC | 342 | 42 | 14.25 | 1 | 16.64 | 0.35 |
| B3LSEPR4227NC | 497 | 42 | 27 | 1 | 29.47 | 0.66 |
| B3LSEPR4233NC | 537 | 42 | 33 | 1 | 35.89 | 0.80 |
| B3LSEPR4239NC | 564 | 42 | 39 | 1 | 42.32 | 0.95 |
| B3LSEPR5015NC | 389 | 50 | 14.25 | 1 | 19.9 | 0.41 |
| B3LSEPR5027NC | 565 | 50 | 27 | 1 | 35.23 | 0.78 |
| B3LSEPR5033NC | 613 | 50 | 33 | 1 | 42.9 | 0.95 |
| B3LSEPR5039NC | 656 | 50 | 39 | 1 | 50.57 | 1.13 |
| B3LSEPR5415NC | 389 | 54 | 14.25 | 1 | 21.52 | 0.45 |
| B3LSEPR5427NC | 582 | 54 | 27 | 1 | 38.1 | 0.84 |
| B3LSEPR5433NC | 632 | 54 | 33 | 1 | 46.4 | 1.03 |
| B3LSEPR5439NC | 677 | 54 | 39 | 1 | 54.7 | 1.22 |

B3LMP-NC • Middle of Run Single Gallery Panel in X Configuration, No Connectors for Additional Gallery Panels

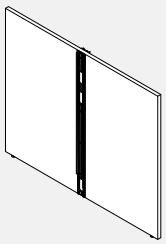

- Provides floor standing support in the middle of a panel run.
- Attaches between panels in a straight Boulevard 1 or System 3 Panel run with capture strips to form an X configuration.
- Connections are at the center of the interior and exterior faces.
- Includes all attachment hardware and glides.
- Total height is inclusive of panel glides extended to their full height.
- 51" wide gallery panel accommodates two 24" deep surfaces while the 63" wide accommodates two 30" deep surfaces and 75" wide two 36" deep surfaces.
- Please specify LP laminate finish and PVC edge finish.
- If a wood grain laminate is chosen, grain direction run horizontally.
- Edged in PVC on three exposed edges and self edged on bottom.

| PRODUCT CODE | PRICE LP | SIZE /INCHES | | | WEIGHT LBS | VOL FT³ |
|--------------|----------|--------------|----|---|------------|---------|
| | | H | W | D | | |
| B3LMP4251NC | 865 | 42 | 51 | 1 | 55.98 | 1.24 |
| B3LMP4263NC | 942 | 42 | 63 | 1 | 68.83 | 1.53 |
| B3LMP4275NC | 1028 | 42 | 75 | 1 | 81.68 | 1.85 |
| B3LMP5051NC | 981 | 50 | 51 | 1 | 66.97 | 1.48 |
| B3LMP5063NC | 1077 | 50 | 63 | 1 | 82.32 | 1.82 |
| B3LMP5075NC | 1188 | 50 | 75 | 1 | 97.67 | 2.17 |
| B3LMP5451NC | 1009 | 54 | 51 | 1 | 72.46 | 1.59 |
| B3LMP5463NC | 1109 | 54 | 63 | 1 | 89.06 | 1.97 |
| B3LMP5475NC | 1223 | 54 | 75 | 1 | 105.66 | 2.34 |

B3LSMP-NC • Middle of Run Single Gallery Panel in T Configuration, No Connectors for Additional Gallery Panels



- Provides floor standing support at the middle of a panel run.
- Attaches in the middle of a straight Boulevard 1 or System 3 panel run with capture strips to form a T configuration.
- Connections are on the interior and exterior faces of one end.
- Includes all attachment hardware and glides.
- Total height is inclusive of panel glides extended to their full height.
- 27" wide gallery panel accommodates a 24" deep surface while the 33" wide accommodates a 30" deep surface and 39" wide a 36" deep surface.
- Please specify LP laminate finish and PVC edge finish.
- If a wood grain laminate is chosen, grain direction run horizontally.
- Edged in PVC on three exposed edges and self edged on bottom.

| PRODUCT CODE | PRICE LP | SIZE /INCHES | | | WEIGHT LBS | VOL FT³ |
|--------------|----------|--------------|----|---|------------|---------|
| | | H | W | D | | |
| B3LSMP4227NC | 712 | 42 | 27 | 1 | 30.28 | 0.66 |
| B3LSMP4233NC | 749 | 42 | 33 | 1 | 36.71 | 0.80 |
| B3LSMP4239NC | 778 | 42 | 39 | 1 | 43.13 | 0.95 |
| B3LSMP5027NC | 788 | 50 | 27 | 1 | 36.28 | 0.78 |
| B3LSMP5033NC | 835 | 50 | 33 | 1 | 43.95 | 0.95 |
| B3LSMP5039NC | 879 | 50 | 39 | 1 | 51.63 | 1.13 |
| B3LSMP5427NC | 812 | 54 | 27 | 1 | 39.26 | 0.84 |
| B3LSMP5433NC | 861 | 54 | 33 | 1 | 47.56 | 1.03 |
| B3LSMP5439NC | 905 | 54 | 39 | 1 | 55.86 | 1.22 |

B3LEP • End of Run Gallery Panel in a T configuration, with Connectors for Additional Gallery Panels

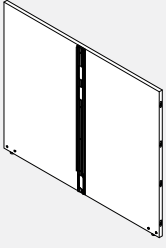

- Provides floor standing support while enclosing the end of a panel run.
- Attaches to the end of a Boulevard 1 or System 3 panel with capture strips to form a T configuration.
- Connections at both ends as well as on the middle of interior face.
- The end connections are to connect other Gallery Panels.
- The side right is compatible with right hand Gallery Panels (B3LXPRxxxx and B3LX-PRxxxxNC, B3L2PRxxxx and B3L3PRxxxx) only.
- The left side is compatible with left hand Gallery Panels (B3LXPLxxxx and B3LX-PLxxxxNC, B3L2PLxxxx and B3L3PLxxxx) only.
- The middle interior face connections are for Boulevard panels.
- Includes all attachment hardware and glides.
- Total height is inclusive of panel glides extended to their full height.
- 51" wide gallery panel accommodates two 24" deep surface while the 63" wide accommodates two 30" deep surfaces and 75" wide two 36" deep surfaces.
- Please specify LP laminate finish and PVC edge finish.
- If a wood grain laminate is chosen, grain direction run horizontally.
- Gallery panel is edged in PVC on exposed top edge only and self edged on the three other edges.

| PRODUCT CODE | PRICE LP | SIZE /INCHES | | | WEIGHT LBS | VOL FT³ |
|--------------|----------|--------------|----|---|------------|---------|
| | | H | W | D | | |
| B3LEP4251 | 667 | 42 | 51 | 1 | 55.25 | 1.24 |
| B3LEP4263 | 745 | 42 | 63 | 1 | 68.1 | 1.53 |
| B3LEP4275 | 828 | 42 | 75 | 1 | 80.95 | 1.82 |
| B3LEP5051 | 773 | 50 | 51 | 1 | 66.01 | 1.48 |
| B3LEP5063 | 868 | 50 | 63 | 1 | 81.36 | 1.82 |
| B3LEP5075 | 979 | 50 | 75 | 1 | 96.71 | 2.17 |
| B3LEP5451 | 795 | 54 | 51 | 1 | 71.38 | 1.59 |
| B3LEP5463 | 894 | 54 | 63 | 1 | 87.98 | 1.97 |
| B3LEP5475 | 1008 | 54 | 75 | 1 | 104.58 | 2.34 |

B3LSEPL • Left End of Run Single Gallery Panel in L Configuration, with Connectors for Additional Gallery Panels

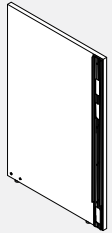

- Provides floor standing support while enclosing the end of a panel run.
- Attaches at the end of a Boulevard 1 or System 3 panel with capture strips to form an L configuration.
- Connection to the Boulevard panel is on interior face near it's right end.
- Connections for a Gallery Panel are on the left edge.
- Compatible with left hand Gallery Panels (B3LXPLxxxx and B3LXPLxxxxNC, B3L2PLxxxx and B3L3PLxxxx) only.
- Includes all attachment hardware and glides.
- Total height is inclusive of panel glides extended to their full height.
- 27" wide gallery panel accommodates a 24" deep surface while the 33" wide accommodates a 30" deep surface and 39" wide a 36" deep surface.
- Please specify LP laminate finish and PVC edge finish.
- If a wood grain laminate is chosen, grain direction run horizontally.
- Edged in PVC on two exposed edges, self edged on connecting to gallery panel edge and the bottom.

| PRODUCT CODE | PRICE LP | SIZE /INCHES | | | WEIGHT LBS | VOL FT³ |
|--------------|----------|--------------|----|---|------------|---------|
| | | H | W | D | | |
| B3LSEPL4227 | 505 | 42 | 27 | 1 | 29.51 | 0.66 |
| B3LSEPL4233 | 544 | 42 | 33 | 1 | 35.94 | 0.80 |
| B3LSEPL4239 | 571 | 42 | 39 | 1 | 42.36 | 0.95 |
| B3LSEPL5027 | 573 | 50 | 27 | 1 | 35.27 | 0.78 |
| B3LSEPL5033 | 621 | 50 | 33 | 1 | 42.94 | 0.95 |
| B3LSEPL5039 | 664 | 50 | 39 | 1 | 50.62 | 1.13 |
| B3LSEPL5427 | 589 | 54 | 27 | 1 | 38.14 | 0.84 |
| B3LSEPL5433 | 639 | 54 | 33 | 1 | 46.44 | 1.03 |
| B3LSEPL5439 | 683 | 54 | 39 | 1 | 54.74 | 1.22 |

B3LSEPR • Right End of Run Single Gallery Panel in L Configuration, with Connectors for additional Gallery Panels



- Provides floor standing support while enclosing the end of a panel run.
- Attaches at the end of a Boulevard 1 or System 3 panel with capture strips to form an L configuration.
- Connection to the Boulevard panel is on interior face near it's left end.
- Connections for a Gallery Panel are on the right edge.
- Compatible with right hand Gallery Panels (B3LXPRxxxx and B3LXPRxxxxNC, B3L2PRxxxx and B3L3PRxxxx) only.
- Includes all attachment hardware and glides.
- Total height is inclusive of panel glides extended to their full height.
- 27" wide gallery panel accommodates a 24" deep surface while the 33" wide accommodates a 30" deep surface and 39" wide a 36" deep surface.
- Please specify LP laminate finish and PVC edge finish.
- If a wood grain laminate is chosen, grain direction run horizontally.
- Edged in PVC on two exposed edges, self edged on connecting to gallery panel edge and the bottom.

| PRODUCT CODE | PRICE LP | SIZE /INCHES | | | WEIGHT LBS | VOL FT³ |
|--------------|----------|--------------|----|---|------------|---------|
| | | H | W | D | | |
| B3LSEPR4227 | 505 | 42 | 27 | 1 | 29.51 | 0.66 |
| B3LSEPR4233 | 544 | 42 | 33 | 1 | 35.94 | 0.80 |
| B3LSEPR4239 | 571 | 42 | 39 | 1 | 42.36 | 0.95 |
| B3LSEPR5027 | 573 | 50 | 27 | 1 | 35.27 | 0.78 |
| B3LSEPR5033 | 621 | 50 | 33 | 1 | 42.94 | 0.95 |
| B3LSEPR5039 | 664 | 50 | 39 | 1 | 50.62 | 1.13 |
| B3LSEPR5427 | 589 | 54 | 27 | 1 | 38.14 | 0.84 |
| B3LSEPR5433 | 639 | 54 | 33 | 1 | 46.44 | 1.03 |
| B3LSEPR5439 | 683 | 54 | 39 | 1 | 54.74 | 1.22 |

B3LMP • Middle of Run Single Gallery Panel in X Configuration, with Connectors for Additional Gallery Panels

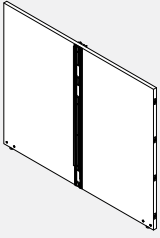

- Provides floor standing support in the middle of a panel run.
- Attached in the middle of a straight Boulevard 1 or System 3 panel run with capture strips to form an X configuration.
- Connections at both ends (for Gallery Panels) as well as on the middle of the interior and exterior faces (for Boulevard Panels).
- The right side is compatible with right hand Gallery Panels (B3LXPRxxxx and B3LX-PRxxxxNC, B3L2PRxxxx and B3L3PRxxxx) only.
- The left side is compatible with left hand Gallery Panels (B3LXPLxxxx and B3LX-PLxxxxNC, B3L2PLxxxx and B3L3PLxxxx) only.
- Includes all attachment hardware and glides.
- Total height is inclusive of panel glides extended to their full height.
- 51" wide gallery panel accommodates two 24" deep surface while the 63" wide accommodates two 30" deep surfaces and 75" wide two 36" deep surfaces.
- Please specify LP laminate finish and PVC edge finish.
- If a wood grain laminate is chosen, grain direction run horizontally.
- Edged in PVC on exposed top edge only and self edged on the three other.

| PRODUCT CODE | PRICE LP | SIZE /INCHES | | | WEIGHT LBS | VOL FT ³ |
|--------------|----------|--------------|----|---|------------|---------------------|
| | | H | W | D | | |
| B3LMP4251 | 880 | 42 | 51 | 1 | 56.07 | 1.24 |
| B3LMP4263 | 958 | 42 | 63 | 1 | 68.91 | 1.53 |
| B3LMP4275 | 1041 | 42 | 75 | 1 | 81.76 | 1.82 |
| B3LMP5051 | 995 | 50 | 51 | 1 | 67.06 | 1.48 |
| B3LMP5063 | 1090 | 50 | 63 | 1 | 82.41 | 1.82 |
| B3LMP5075 | 1201 | 50 | 75 | 1 | 97.76 | 2.17 |
| B3LMP5451 | 1024 | 54 | 51 | 1 | 72.55 | 1.59 |
| B3LMP5463 | 1123 | 54 | 63 | 1 | 89.15 | 1.97 |
| B3LMP5475 | 1237 | 54 | 75 | 1 | 105.74 | 2.34 |

B3LSMP - Middle of Run Single Gallery Panel in T Configuration, with Connectors for Additional Gallery Panels

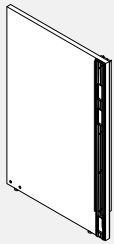

- Provides floor standing support at the middle of a panel run.
- Attached in the middle of a straight Boulevard 1 or System 3 panel run with capture strips to form a T configuration.
- Connections are on the exposed edge (for Gallery Panel) and near the opposite end on both interior and exterior faces (for Boulevard Panels).
- Compatible with left hand gallery panels (B3LXPLxxxx and B3LXPLxxxxNC, B3L2PLxxxx and B3L3PLxxxx) only.
- Includes all attachment hardware and glides.
- Total height is inclusive of panel glides extended to their full height.
- 27" wide gallery panel accommodates a 24" deep surface while the 33" wide accommodates a 30" deep surface and 39" wide a 36" deep surface.
- Please specify LP laminate finish and PVC edge finish.
- If a wood grain laminate is chosen, grain direction run horizontally.
- Edged in PVC on two exposed edges, self edged on connecting to gallery panel edge and the bottom.

| PRODUCT CODE | PRICE LP | SIZE /INCHES | | | WEIGHT LBS | VOL FT ³ |
|--------------|----------|--------------|----|---|------------|---------------------|
| | | H | W | D | | |
| B3LSMP4227 | 717 | 42 | 27 | 1 | 30.33 | 0.66 |
| B3LSMP4233 | 757 | 42 | 33 | 1 | 36.75 | 0.80 |
| B3LSMP4239 | 784 | 42 | 39 | 1 | 43.17 | 0.95 |
| B3LSMP5027 | 795 | 50 | 27 | 1 | 36.32 | 0.78 |
| B3LSMP5033 | 843 | 50 | 33 | 1 | 43.99 | 0.95 |
| B3LSMP5039 | 886 | 50 | 39 | 1 | 51.67 | 1.13 |
| B3LSMP5427 | 819 | 54 | 27 | 1 | 39.31 | 0.84 |
| B3LSMP5433 | 868 | 54 | 33 | 1 | 47.61 | 1.03 |
| B3LSMP5439 | 913 | 54 | 39 | 1 | 55.91 | 1.22 |

B3LXPL • Left Gallery Panel Extension, with Connectors for Additional Gallery Panels

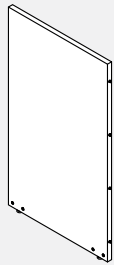

- Provides floor standing support while extending the Gallery Panels run.
- Attaches to the left edge of a Gallery Panel by the pin connectors to allow for additional Gallery Panels to be added on the left side.
- Pin connectors on the right edge and modular connectors on the left edge of the interior face.
- The right side is compatible with Gallery Panels (B3LEPxxx, B3LSEPL, B3LMPxxx, B3LSMP and B3LXPLxxx) only.
- The left side is compatible with left hand Gallery Panels (B3LXPLxxxx and B3LX-PLxxxxNC, B3L2PLxxxx and B3L3PLxxxx) only.
- Includes all attachment hardware and glides.
- Total height is inclusive of panel glides extended to their full height.
- Please specify LP laminate finish and PVC edge finish.
- If a wood grain laminate is chosen, grain direction run horizontally.
- Edged in PVC on exposed top edge only and self edges on the three other.
- Edged in PVC on two exposed edges, self edged on connecting to gallery panel edge and the bottom.

| PRODUCT CODE | PRICE LP | SIZE /INCHES | | | WEIGHT LBS | VOL FT ³ |
|--------------|----------|--------------|----|---|------------|---------------------|
| | | H | W | D | | |
| B3LXPL4224 | 260 | 42 | 24 | 1 | 25.83 | 0.58 |
| B3LXPL4230 | 299 | 42 | 30 | 1 | 32.26 | 0.73 |
| B3LXPL4236 | 338 | 42 | 36 | 1 | 38.68 | 0.88 |
| B3LXPL4242 | 376 | 42 | 42 | 1 | 45.11 | 1.02 |
| B3LXPL4248 | 415 | 42 | 48 | 1 | 51.53 | 1.17 |
| B3LXPL5024 | 309 | 50 | 24 | 1 | 30.83 | 0.69 |
| B3LXPL5030 | 357 | 50 | 30 | 1 | 38.51 | 0.87 |
| B3LXPL5036 | 406 | 50 | 36 | 1 | 46.18 | 1.04 |
| B3LXPL5042 | 453 | 50 | 42 | 1 | 53.86 | 1.22 |
| B3LXPL5048 | 502 | 50 | 48 | 1 | 61.53 | 1.39 |
| B3LXPL5424 | 319 | 54 | 24 | 1 | 33.34 | 0.75 |
| B3LXPL5430 | 369 | 54 | 30 | 1 | 41.64 | 0.94 |
| B3LXPL5436 | 417 | 54 | 36 | 1 | 49.94 | 1.13 |
| B3LXPL5442 | 466 | 54 | 42 | 1 | 58.24 | 1.31 |
| B3LXPL5448 | 518 | 54 | 48 | 1 | 66.54 | 1.50 |

B3LXPR • Right Gallery Panel Extension, with Connectors for Additional Gallery Panels



- Provides floor standing support while extending the Gallery Panels run.
- Attaches to the right edge of a Gallery Panel by the pin connectors to allow for additional Gallery Panels to be added on the right side.
- Pin connectors on the right edge and modular connectors on the left edge of the interior face.
- The right side is compatible with right hand Gallery Panels (B3LXPRxxxx and B3LXPRxxxxNC, B3L2PRxxxx and B3L3PRxxxx) only.
- The left side is compatible with Gallery Panels (B3LEPxxx, B3LSEPRxxx, B3LMPxxx and B3LXPRxxx) only.
- Includes all attachment hardware and glides.
- Total height is inclusive of panel glides extended to their full height.
- Please specify LP laminate finish and PVC edge finish.
- If a wood grain laminate is chosen, grain direction run horizontally.
- Edged in PVC on exposed top edge only and self edges on the three other.

| PRODUCT CODE | PRICE LP | SIZE /INCHES | | | WEIGHT LBS | VOL FT ³ |
|--------------|----------|--------------|----|---|------------|---------------------|
| | | H | W | D | | |
| B3LXPR4224 | 260 | 42 | 24 | 1 | 25.83 | 0.58 |
| B3LXPR4230 | 299 | 42 | 30 | 1 | 32.26 | 0.73 |
| B3LXPR4236 | 338 | 42 | 36 | 1 | 38.68 | 0.88 |
| B3LXPR4242 | 376 | 42 | 42 | 1 | 45.11 | 1.02 |
| B3LXPR4248 | 415 | 42 | 48 | 1 | 51.53 | 1.17 |
| B3LXPR5024 | 309 | 50 | 24 | 1 | 30.83 | 0.69 |
| B3LXPR5030 | 357 | 50 | 30 | 1 | 38.51 | 0.87 |
| B3LXPR5036 | 406 | 50 | 36 | 1 | 46.18 | 1.04 |
| B3LXPR5042 | 453 | 50 | 42 | 1 | 53.86 | 1.22 |
| B3LXPR5048 | 502 | 50 | 48 | 1 | 61.53 | 1.39 |
| B3LXPR5424 | 319 | 54 | 24 | 1 | 33.34 | 0.75 |
| B3LXPR5430 | 369 | 54 | 30 | 1 | 41.64 | 0.94 |
| B3LXPR5436 | 417 | 54 | 36 | 1 | 49.94 | 1.13 |
| B3LXPR5442 | 466 | 54 | 42 | 1 | 58.24 | 1.31 |
| B3LXPR5448 | 518 | 54 | 48 | 1 | 66.54 | 1.50 |

B3LXPL-NC • Left Gallery Panel Extension, No Connectors for Additional Gallery Panels

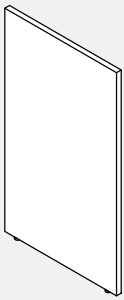

- Provides floor standing support while enclosing the end of a Gallery Panel left run.
- Attached to the left edge of a Gallery Panel by the pin connectors to finish the run.
- Pin connectors are on the right edge of the interior face.
- Compatible with gallery panels (B3LEPxxxx, B3LSEPLxxxx, B3LMPxxxx, B3LMPxxxx and B3LXPLxxxx) only.
- Includes all attachment hardware and glides.
- Total height is inclusive of panel glides extended to their full height.
- Please specify LP laminate finish and PVC edge finish.
- If a wood grain laminate is chosen, grain direction run horizontally.
- Edged in PVC on two exposed edges, self edged on connecting to gallery panel edge and the bottom.

| PRODUCT CODE | PRICE LP | SIZE /INCHES | | | WEIGHT LBS | VOL FT ³ |
|--------------|----------|--------------|----|---|------------|---------------------|
| | | H | W | D | | |
| B3LXPL4212NC | 142 | 42 | 12 | 1 | 12.95 | 0.29 |
| B3LXPL4224NC | 252 | 42 | 24 | 1 | 25.8 | 0.58 |
| B3LXPL4230NC | 291 | 42 | 30 | 1 | 32.22 | 0.73 |
| B3LXPL4236NC | 330 | 42 | 36 | 1 | 38.65 | 0.88 |
| B3LXPL4242NC | 370 | 42 | 42 | 1 | 45.07 | 1.02 |
| B3LXPL4248NC | 408 | 42 | 48 | 1 | 51.5 | 1.17 |
| B3LXPL5012NC | 177 | 50 | 12 | 1 | 15.45 | 0.35 |
| B3LXPL5024NC | 303 | 50 | 24 | 1 | 30.8 | 0.69 |
| B3LXPL5030NC | 350 | 50 | 30 | 1 | 38.47 | 0.87 |
| B3LXPL5036NC | 398 | 50 | 36 | 1 | 46.15 | 1.04 |
| B3LXPL5042NC | 448 | 50 | 42 | 1 | 53.82 | 1.22 |
| B3LXPL5048NC | 495 | 50 | 48 | 1 | 61.5 | 1.39 |
| B3LXPL5412NC | 177 | 54 | 12 | 1 | 16.7 | 0.38 |
| B3LXPL5424NC | 312 | 54 | 24 | 1 | 33.3 | 0.75 |
| B3LXPL5430NC | 362 | 54 | 30 | 1 | 41.6 | 0.94 |
| B3LXPL5436NC | 410 | 54 | 36 | 1 | 49.9 | 1.13 |
| B3LXPL5442NC | 460 | 54 | 42 | 1 | 58.2 | 1.31 |
| B3LXPL5448NC | 509 | 54 | 48 | 1 | 66.5 | 1.50 |

B3LXPR-NC • Right Gallery Panel Extension, No Connectors for Additional Gallery Panels

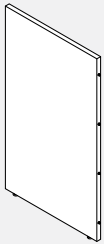

- Provides floor standing support while enclosing the end of a Gallery Panel right run.
- Attached to the right edge of a Gallery Panel by the pin connectors to finish the run.
- Pin connectors are on the left edge of the interior face.
- Compatible with gallery panels (B3LEPxxxx, B3LSEPRxxxx, B3LMPxxxx and B3LXPRxxxx) only.
- Includes all attachment hardware and glides.
- Total height is inclusive of panel glides extended to their full height.
- Please specify LP laminate finish and PVC edge finish.
- If a wood grain laminate is chosen, grain direction run horizontally.
- Edged in PVC on two exposed edges, self edged on connecting to gallery panel edge and the bottom.

| PRODUCT CODE | PRICE LP | SIZE /INCHES | | | WEIGHT LBS | VOL FT ³ |
|--------------|----------|--------------|----|---|------------|---------------------|
| | | H | W | D | | |
| B3LXPR4212NC | 142 | 42 | 12 | 1 | 12.95 | 0.29 |
| B3LXPR4224NC | 252 | 42 | 24 | 1 | 25.8 | 0.58 |
| B3LXPR4230NC | 291 | 42 | 30 | 1 | 32.22 | 0.73 |
| B3LXPR4236NC | 330 | 42 | 36 | 1 | 38.65 | 0.88 |
| B3LXPR4242NC | 370 | 42 | 42 | 1 | 45.07 | 1.02 |
| B3LXPR4248NC | 408 | 42 | 48 | 1 | 51.5 | 1.17 |
| B3LXPR5012NC | 177 | 50 | 12 | 1 | 15.45 | 0.35 |
| B3LXPR5024NC | 303 | 50 | 24 | 1 | 30.8 | 0.69 |
| B3LXPR5030NC | 350 | 50 | 30 | 1 | 38.47 | 0.87 |
| B3LXPR5036NC | 398 | 50 | 36 | 1 | 46.15 | 1.04 |
| B3LXPR5042NC | 448 | 50 | 42 | 1 | 53.82 | 1.22 |
| B3LXPR5048NC | 495 | 50 | 48 | 1 | 61.5 | 1.39 |
| B3LXPR5412NC | 177 | 54 | 12 | 1 | 16.7 | 0.38 |
| B3LXPR5424NC | 312 | 54 | 24 | 1 | 33.3 | 0.75 |
| B3LXPR5430NC | 362 | 54 | 30 | 1 | 41.6 | 0.94 |
| B3LXPR5436NC | 410 | 54 | 36 | 1 | 49.9 | 1.13 |
| B3LXPR5442NC | 460 | 54 | 42 | 1 | 58.2 | 1.31 |
| B3LXPR5448NC | 509 | 54 | 48 | 1 | 66.5 | 1.50 |

B3L2PR • Right Gallery Panel End of Run Return

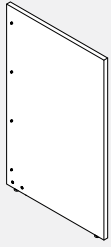

- Provides floor standing support while enclosing the end of a Gallery Panel run.
- Attaches at the Gallery Panel right edge with connectors to form an L configuration.
- Connections to Gallery Panel are on the interior face near it's left end.
- Compatible with Gallery Panels (B3LEPxxxx, B3LSEPRxxxx, B3LMPxxxx and B3LX-PRxxxx) only.
- Includes all attachment hardware and glides.
- Total height is inclusive of panel glides extended to their full height.
- 25" wide gallery panel accomodates a 24" deep surface while the 31" wide accomo- dates a 30" deep surface and 37" wide a 36" deep surface.
- Please specify LP laminate finish and PVC edge finish.
- If a wood grain laminate is chosen, grain direction run horizontally.
- Edged in PVC on three exposed edges and self edged on the bottom edge.

| PRODUCT CODE | PRICE LP | SIZE /INCHES | | | WEIGHT LBS | VOL FT³ |
|--------------|----------|--------------|----|---|------------|---------|
| | | H | W | D | | |
| B3L2PR4213 | 153 | 42 | 13 | 1 | 14.02 | 0.32 |
| B3L2PR4225 | 291 | 42 | 25 | 1 | 26.87 | 0.61 |
| B3L2PR4231 | 330 | 42 | 31 | 1 | 33.29 | 0.75 |
| B3L2PR4237 | 357 | 42 | 37 | 1 | 39.72 | 0.90 |
| B3L2PR5013 | 192 | 50 | 13 | 1 | 16.73 | 0.38 |
| B3L2PR5025 | 350 | 50 | 25 | 1 | 32.08 | 0.72 |
| B3L2PR5031 | 398 | 50 | 31 | 1 | 39.75 | 0.90 |
| B3L2PR5037 | 441 | 50 | 37 | 1 | 47.43 | 1.07 |
| B3L2PR5413 | 192 | 54 | 13 | 1 | 18.08 | 0.41 |
| B3L2PR5425 | 362 | 54 | 25 | 1 | 34.68 | 0.78 |
| B3L2PR5431 | 410 | 54 | 31 | 1 | 42.98 | 0.97 |
| B3L2PR5437 | 454 | 54 | 37 | 1 | 51.28 | 1.16 |

B3L2PL • Left Gallery Panel End of Run Return

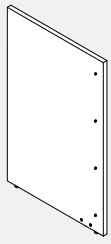

- Provides floor standing support while enclosing the end of a gallery panel run.
- Attaches at the Gallery Panel left edge with connectors to form an L configuration.
- Connections to Gallery Panel are on the interior face near it's right end .
- Compatible with Gallery Panels (B3LEPxxxx, B3LSEPLxxxx, B3LMPxxxx, B3LS- MPxxxx and B3LXPLxxxx) only.
- Includes all attachment hardware and glides.
- Total height is inclusive of panel glides extended to their full height.
- 25" wide gallery panel accomodates a 24" deep surface while the 31" wide accomo- dates a 30" deep surface and 37" wide a 36" deep surface.
- Please specify LP laminate finish and PVC edge finish.
- If a wood grain laminate is chosen, grain direction run horizontally.
- Edged in PVC on three exposed edges and self edged on the bottom edge.

| PRODUCT CODE | PRICE LP | SIZE /INCHES | | | WEIGHT LBS | VOL FT³ |
|--------------|----------|--------------|----|---|------------|---------|
| | | H | W | D | | |
| B3L2PL4213 | 153 | 42 | 13 | 1 | 14.02 | 0.32 |
| B3L2PL4225 | 291 | 42 | 25 | 1 | 26.87 | 0.61 |
| B3L2PL4231 | 330 | 42 | 31 | 1 | 33.29 | 0.75 |
| B3L2PL4237 | 357 | 42 | 37 | 1 | 39.72 | 0.90 |
| B3L2PL5013 | 192 | 50 | 13 | 1 | 16.73 | 0.38 |
| B3L2PL5025 | 350 | 50 | 25 | 1 | 32.08 | 0.72 |
| B3L2PL5031 | 398 | 50 | 31 | 1 | 39.75 | 0.90 |
| B3L2PL5037 | 441 | 50 | 37 | 1 | 47.43 | 1.07 |
| B3L2PL5413 | 192 | 54 | 13 | 1 | 18.08 | 0.41 |
| B3L2PL5425 | 362 | 54 | 25 | 1 | 34.68 | 0.78 |
| B3L2PL5431 | 410 | 54 | 31 | 1 | 42.98 | 0.97 |
| B3L2PL5437 | 454 | 54 | 37 | 1 | 51.28 | 1.16 |

B3L3PL • Left Gallery Panel End of Run 3-Way Return

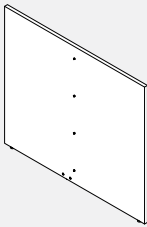

- Provides floor standing support while enclosing the end of a Gallery Panel run.
- Attaches to the Gallery Panel left edge with connectors to form an T configuration.
- Connections to Gallery Panel are on the interior face in the middle.
- Compatible with Gallery Panels (B3LEPxxxx, B3LSEPLxxxx, B3LMPxxxx, B3LS- MPxxxx and B3LXPLxxxx) only.
- Includes all attachment hardware and glides.
- Total height is inclusive of panel glides extended to their full height.
- 49" wide gallery panel accomodates two 24" deep surfaces while the 61" wide accomodates two 30" deep surface and 73" wide two 36" deep surface.
- Please specify LP laminate finish and PVC edge finish.
- If a wood grain laminate is chosen, grain direction run horizontally.
- Edged in PVC on three exposed edges and self edged on the bottom edge.

| PRODUCT CODE | PRICE LP | SIZE /INCHES | | | WEIGHT LBS | VOL FT³ |
|--------------|----------|--------------|----|---|------------|---------|
| | | H | W | D | | |
| B3L3PL4225 | 229 | 42 | 25 | 1 | 26.87 | 0.61 |
| B3L3PL4249 | 396 | 42 | 49 | 1 | 52.57 | 1.19 |
| B3L3PL4261 | 524 | 42 | 61 | 1 | 65.41 | 1.48 |
| B3L3PL4273 | 609 | 42 | 73 | 1 | 78.26 | 1.77 |
| B3L3PL5025 | 286 | 50 | 25 | 1 | 32.08 | 0.72 |
| B3L3PL5049 | 543 | 50 | 49 | 1 | 62.77 | 1.42 |
| B3L3PL5061 | 639 | 50 | 61 | 1 | 78.12 | 1.77 |
| B3L3PL5073 | 749 | 50 | 73 | 1 | 93.47 | 2.11 |
| B3L3PL5425 | 286 | 54 | 25 | 1 | 34.68 | 0.78 |
| B3L3PL5449 | 559 | 54 | 49 | 1 | 67.88 | 1.53 |
| B3L3PL5461 | 658 | 54 | 61 | 1 | 84.48 | 1.91 |
| B3L3PL5473 | 773 | 54 | 73 | 1 | 101.08 | 2.28 |

B3L3PR • Right Gallery Panel End of Run 3-Way Return

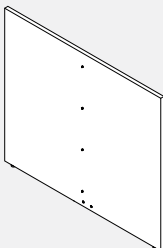

- Provides floor standing support while enclosing the end of a Gallery Panel run.
- Attaches to the Gallery Panel right edge with connectors to form an T configuration.
- Connections to Gallery Panel are on the interior face in the middle.
- Compatible with gallery panels (B3LEPxxxx, B3LSEPRxxxx, B3LMPxxxx and B3LXPRxxxx) only.
- Includes all attachment hardware and glides.
- Total height is inclusive of panel glides extended to their full height.
- 49" wide gallery panel accomodates two 24" deep surfaces while the 61" wide accomodates two 30" deep surface and 73" wide two 36" deep surface.
- Please specify LP laminate finish and PVC edge finish.
- If a wood grain laminate is chosen, grain direction run horizontally.
- Edged in PVC on three exposed edges and self edged on the bottom edge.

| PRODUCT CODE | PRICE LP | SIZE /INCHES | | | WEIGHT LBS | VOL FT³ |
|--------------|----------|--------------|----|---|------------|---------|
| | | H | W | D | | |
| B3L3PR4225 | 229 | 42 | 25 | 1 | 26.87 | 0.61 |
| B3L3PR4249 | 396 | 42 | 49 | 1 | 52.57 | 1.19 |
| B3L3PR4261 | 524 | 42 | 61 | 1 | 65.41 | 1.48 |
| B3L3PR4273 | 609 | 42 | 73 | 1 | 78.26 | 1.77 |
| B3L3PR5025 | 286 | 50 | 25 | 1 | 32.08 | 0.72 |
| B3L3PR5049 | 543 | 50 | 49 | 1 | 62.77 | 1.42 |
| B3L3PR5061 | 639 | 50 | 61 | 1 | 78.12 | 1.77 |
| B3L3PR5073 | 749 | 50 | 73 | 1 | 93.47 | 2.11 |
| B3L3PR5425 | 286 | 54 | 25 | 1 | 34.68 | 0.78 |
| B3L3PR5449 | 559 | 54 | 49 | 1 | 67.88 | 1.53 |
| B3L3PR5461 | 658 | 54 | 61 | 1 | 84.48 | 1.91 |
| B3L3PR5473 | 773 | 54 | 73 | 1 | 101.08 | 2.28 |

B3HLPBB01 • Gallery Panel Bottom Inline Bracket

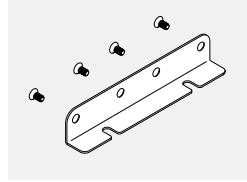

- Gallery Panel Bottom Inline Bracket connects two Gallery Panels at the bottom with screws.
- Available in standard paint colors.

| PRODUCT CODE | PRICE | SIZE /INCHES | | | WEIGHT LBS | VOL FT ³ |
|--------------|-------|--------------|-----|---|------------|---------------------|
| | | H | W | D | | |
| B3HLPBB01 | 35 | 7 | 1.5 | 8 | 1 | 0.5 |

B3HLPCB01 • Gallery Panel Corner Bracket

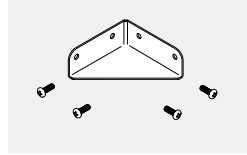

- Gallery Panel Corner Bottom bracket connects two Gallery Panels at 90 degrees.
- Available in standard paint colors.

| PRODUCT CODE | PRICE | SIZE /INCHES | | | WEIGHT LBS | VOL FT ³ |
|--------------|-------|--------------|-----|---|------------|---------------------|
| | | H | W | D | | |
| B3HLPCB01 | 34 | 7 | 1.5 | 4 | 4 | 0.5 |

B3PMP-GI-W • Privacy Glass for 1" Laminate Panels

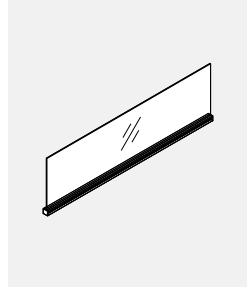

- Privacy glass integrated with aluminum top trim.
- Attaches on top of gallery panels to add privacy or divide space.
- Includes aluminum trim with channel, end caps and glass tile.
- Top rail may also be used to hang accessories.
- Glass and attachment hardware ship separately.
- Please specify standard paint finish for the channel.
- Standard in clear (CLR) or frosted (FRST).

| PRODUCT CODE | PRICE | | SIZE /INCHES | | | WEIGHT LBS | VOL FT ³ |
|--------------|-------|------|--------------|----|---|------------|---------------------|
| | CLR | FRST | H | W | D | | |
| B3PMP24GI8W | 201 | 251 | 8 | 24 | 1 | 4.84 | 0.11 |
| B3PMP30GI8W | 219 | 276 | 8 | 30 | 1 | 6.06 | 0.14 |
| B3PMP36GI8W | 235 | 291 | 8 | 36 | 1 | 7.28 | 0.17 |
| B3PMP42GI8W | 251 | 313 | 8 | 42 | 1 | 8.5 | 0.19 |
| B3PMP48GI8W | 262 | 327 | 8 | 48 | 1 | 9.72 | 0.22 |
| B3PMP24GI16W | 201 | 251 | 16 | 24 | 1 | 8.92 | 0.22 |
| B3PMP30GI16W | 219 | 276 | 16 | 30 | 1 | 11.17 | 0.28 |
| B3PMP36GI16W | 235 | 291 | 16 | 36 | 1 | 13.43 | 0.33 |
| B3PMP42GI16W | 251 | 313 | 16 | 42 | 1 | 15.68 | 0.39 |
| B3PMP48GI16W | 262 | 327 | 16 | 48 | 1 | 17.92 | 0.44 |

B3PFD-W • Felt divider for 1" Laminate Panels

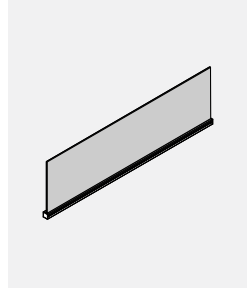

- Privacy felt integrated with aluminum top trim.
- Attaches on top of gallery panels to add privacy or divide space.
- Includes aluminum trim with channel, end caps and felt tile.
- Top rail may also be used to hang accessories.
- Felt and attachment hardware ship separately.
- Please specify standard paint finish for the channel.
- Please specify standard felt finish.

| PRODUCT CODE | PRICE | | SIZE /INCHES | | | WEIGHT LBS | VOL FT ³ |
|--------------|-------|---|--------------|----|---|------------|---------------------|
| | H | W | D | | | | |
| B3PFD0824W | 72 | | 8 | 24 | 1 | 1.32 | 0.11 |
| B3PFD0830W | 88 | | 8 | 30 | 1 | 1.65 | 0.14 |
| B3PFD0836W | 102 | | 8 | 36 | 1 | 1.99 | 0.17 |
| B3PFD0842W | 114 | | 8 | 42 | 1 | 2.32 | 0.19 |
| B3PFD0848W | 170 | | 8 | 48 | 1 | 2.65 | 0.22 |
| B3PFD0854W | 183 | | 8 | 54 | 1 | 2.98 | 0.25 |
| B3PFD0860W | 199 | | 8 | 60 | 1 | 3.32 | 0.28 |
| B3PFD0866W | 210 | | 8 | 66 | 1 | 3.65 | 0.31 |
| B3PFD0872W | 238 | | 8 | 72 | 1 | 3.98 | 0.33 |
| B3PFD1624W | 83 | | 16 | 24 | 1 | 1.83 | 0.22 |
| B3PFD1630W | 98 | | 16 | 30 | 1 | 2.3 | 0.28 |
| B3PFD1636W | 116 | | 16 | 36 | 1 | 2.76 | 0.33 |
| B3PFD1642W | 130 | | 16 | 42 | 1 | 3.22 | 0.39 |
| B3PFD1648W | 193 | | 16 | 48 | 1 | 3.68 | 0.44 |
| B3PFD1654W | 210 | | 16 | 54 | 1 | 4.14 | 0.50 |
| B3PFD1660W | 226 | | 16 | 60 | 1 | 4.61 | 0.56 |
| B3PFD1666W | 238 | | 16 | 66 | 1 | 5.07 | 0.61 |
| B3PFD1672W | 271 | | 16 | 72 | 1 | 5.53 | 0.67 |

Electrical

Affordability and widespread availability of wireless networking is gradually diminishing the need for extensive cable capacity housing. However, as our desk top equipment still requires electricity, providing access to power from within a work station is an integral part of any work place design.

The Global Contract family of power components has been assembled to address a variety of common requirements as well as to satisfy specific customer needs and budgets.

Global Contract can now offer the option of 3 duplex per panel, please contact your Customer Service Representative.

Direct Access:

When office equipment plugs directly into a wall or raised floor power source, cable troughs, as well the Boulevard panel internal cavity serve the purpose of organizing cables.

Extensions:

Keeping minimal installation costs in mind, the next natural step is the employment of fused and surge protected power bars, worksurface-clamped receptacles or floor standing power towers.

Four circuit power systems:

In the absence of a raised floor, or when office equipment is to be installed further away from wall outlets, the Boulevard panel or Bridges unit the building power supply - office equipment gap by distributing power at either floor or desk height level, or both.

While Boulevard panels are capable of surrounding a given work station with power and data outlets at multiple levels, it is important to remember that the most economical way of providing four-circuit power distribution is if the harness, junction box and receptacle system remained within the central spine structure. The cost savings here come from a number and lengths of individual connecting power harnesses.

Should there be a need to branch power from Boulevard or central spine onto adjacent, perpendicular work surfaces, the employment of fused and surge protected power bars will assist in keeping the cost under control.

However, the very same, 4-circuit system is capable of delivering a considerable amount of power as there can be up to six, 8 wire-4 circuit systems accommodated within System3 pass-thru panel. For instance: three systems at the floor level and two systems at the desk height.

Various ceiling or floor level power entry feeds are available. See the following pages for individual component description and technical specifications.

Technical Information

Wire Schematic

4-2-2 Wiring Schematic

8-Wire Shared Neutral

"3+1" -3 Utility circuits, 1 dedicated circuit.

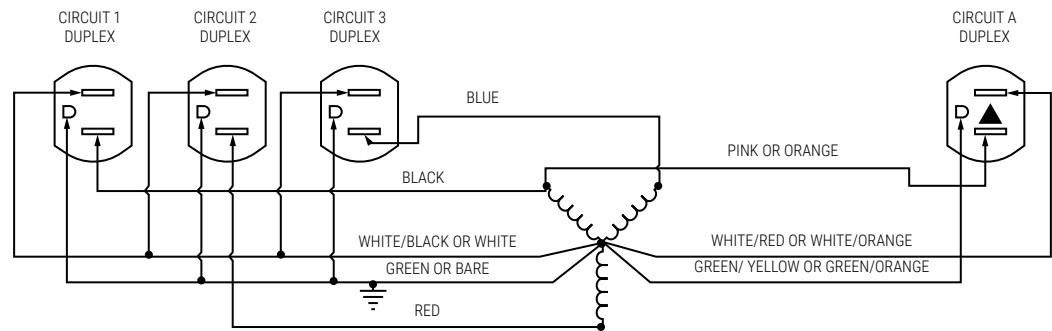

8 Wires

4 Lines (12 ga.)
2 Neutrals (10 ga.)
2 Grounds (12 ga.)

4 Circuits

3 Utility Circuits
1 Dedicated Circuits

Receptacles

Duplex – Up to 6 duplex
receptacles per circuit
(Up to 48 infeed)

Specifications

System rated for connection to a grounded 120/240 V, single phase*, 20A, 60Hz or 120/208 V, 3 phase, 20A, 60Hz branch circuit for U.S. and 15A if product is marked with a C-UL Mark. Outlets rated 15A max.

* When connected to Single Phase. Only
Circuit 1,3 & A are available.

UL Recognised CSA Certified

Warning: It is recommended that installation of the electrical harness be made under the supervision of a licensed electrician in accordance with applicable codes and regulations.

Special Note: Always determine that harness is electrically connected to only one power supply.

STEP-BY-STEP SPECIFICATION - 8 WIRE ELECTRICAL FOR BOULEVARD 1 AND RACEWAY PANELS

STEP 1: Determine the location of the source power entry entering the panel through a post.

- a) From the floor:
 - i) Choose from a selection of single or double Base Feeds (BE81BF721, BE81BF722, BE81BF1441, BE81BF1442) to bring the power from the floor to the raceway channel.
 - ii) Select a post adjacent to the panel (or panels if using a Double Base Feed) to which the end of the Base Feed will be attached. This panel requires a Power Distribution Housing and must be located next to the post through which the Base Feed is entering.

Note: If it is not practical to have a Power Distribution Housing in a panel adjacent to the selected Base Feed Post, use a BE8CPxxHJ Housing-to-Jumper Pass-Thru Cable to transition through the adjacent non-powered panel(s) that are between the Base Feed Post and the first powered panel. The length of the cable will equal the combined width of the non-powered panel(s).

- b) From the Ceiling:
 - i) Choose from a selection of single or double Ceiling Feeds (BE81CF1201, BE81CF120-2, BE81CF1441, BE81CF1442) to bring the power from the ceiling to the raceway.
 - ii) Select a post adjacent to the panel (or panels if using a Double Ceiling Feed) to which the Ceiling Feed will be attached. This panel requires a Power Distribution Housing and must be located next to the post through which the Ceiling Feed is entering.

STEP 2: Determine which panels are to be powered.

- a) Use a BE81D Concealed Desk Height Power Distribution Housing or a BE8U2D Face Mount Desk Height Power Distribution Housing that corresponds with the width of each panel selected to be powered.

Note: Specify Face Mount Raceway Covers for panels that contain BE8U2D Face Mount Desk Height Power Distribution Housings.

STEP 3: Connect power to the panels.

- a) Use a BE8JC16 Jumper between two adjacent powered panels.
- b) Use a BE8JC20 Jumper between two powered panels separated by a post.
- c) **Use a BE8JM19 Shielded Mesh Jumper between two powered panels separated by a post.**
- d) Use a BE8CPxxHJ Housing-to-Jumper Pass-Thru Cable to electrically connect a BE8JM19 Shielded Mesh Jumper and a powered panel when the two are separated by one or more non-powered panels in a straight line application only.
 - i) The length of the BE8CPxxHJ Housing-to-Jumper Pass-Thru Cable will equal the combined width of the non-powered panel(s).
- e) Use a BE8CPxxHH Housing-to-Housing Pass-Thru Cable to electrically connect two powered panel separated by one or more non-powered panels in a straight line application only.
 - i) The length of the Pass-Thru Cable corresponds with the width(s) of the non-powered panels that separate two powered panels plus 16" (the termination blocks of the Power Distribution Housing are 8" in from the edge of the powered panel), plus 4" for each post.
- f) Connect two jumpers or cables together by using the I-Connector BE8CI1. This functions as a female-female adapter and it allows the male ends of jumpers and pass-thru cables to connect together.

STEP 4: Designate which circuit each duplex is to tap into.

- a) Each powered panel has four (4) potential locations for duplex receptacles - 2 per side. (Exception: 24" wide panel has only two (2) potential locations - 1 per side, 18" wide panel has no locations for receptacles).
- b) At each location there is a choice of four (4) circuit options. Select the circuit option for each location.

Circuit Selections : Circuits 1, 2, and 3 are utility circuits, all sharing a ground and a neutral. Circuit A is a dedicated circuit with its own ground and neutral.

SPECIFICATION APPLICATIONS

Boulevard 1 Jumper Applications

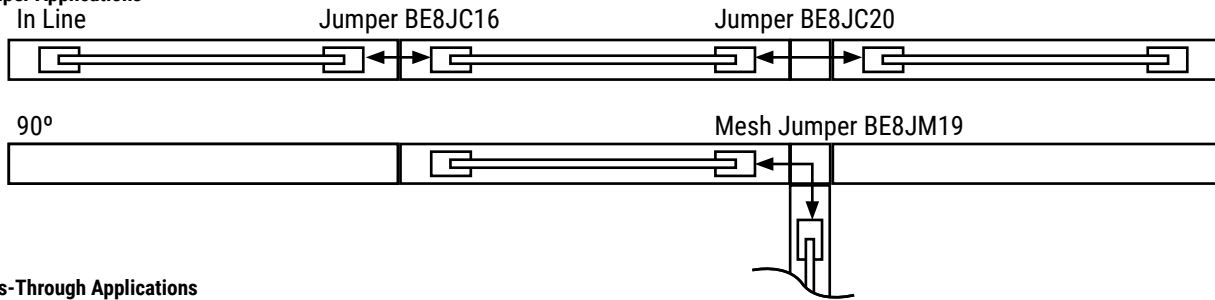

Boulevard 1 Pass-Through Applications

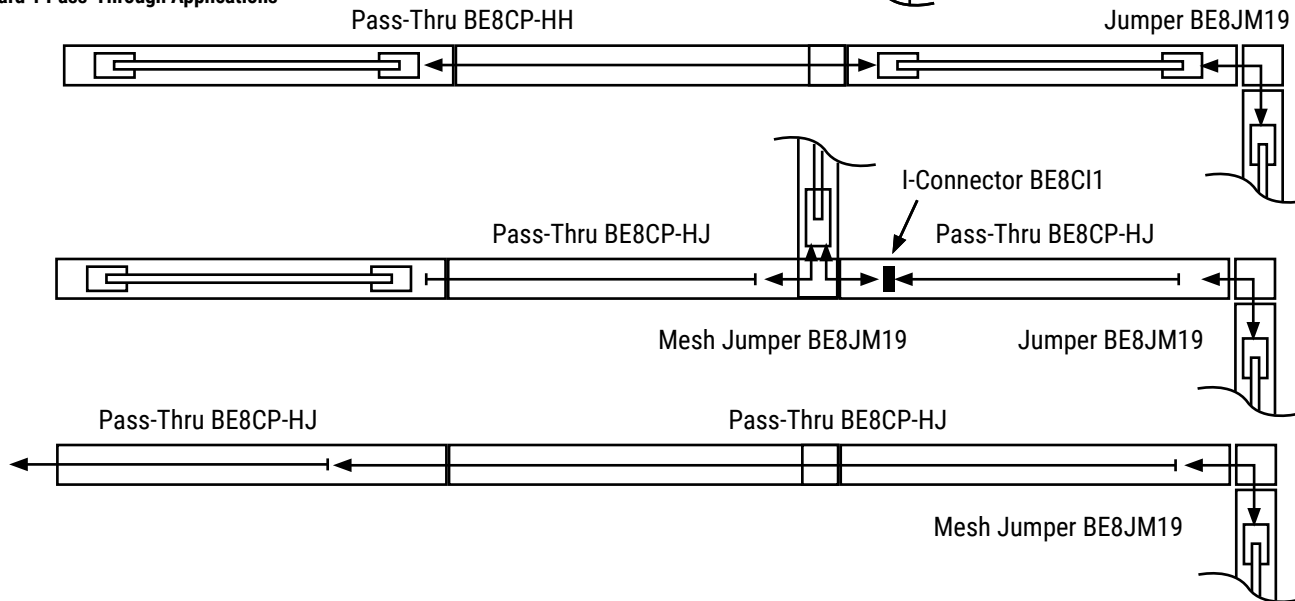

STEP-BY-STEP SPECIFICATION - 8 WIRE ELECTRICAL FOR BOULEVARD SYSTEM 3 BASE RACEWAY

STEP 1: Determine the location of the source power entry entering the panel.

- a. At the base of a panel:
 - i. Use a BE8BFxx Base Feed.
 - ii. Select the panel to which the Base Feed will be attached. This panel requires a BE83D Power Distribution Housing.
 - iii. Select the side of the panel and the receptacle outlet to which the Base Feed is to be attached.
- b. From the ceiling:
 - i. Use a BE8CFxx-1or -2 (single or double).
 - ii. Select the post through which to feed the Ceiling Feed.
 - iii. One panel adjacent to the selected post requires a BE83D Power Distribution Housing. Attach the Ceiling Feed to the nearest end of the Power Distribution Housing.

Note: If it is not practical to have a Power Distribution Housing in a panel adjacent to the selected Ceiling Feed Post, use a BE8CPxxHJ Housing-to-Jumper Pass-Thru Cable to transition through the adjacent non-powered panel(s) that are between the Ceiling Feed Post and the first powered panel. The length of the cable will equal the combined width of the non-powered panel(s).

- c. At the base of an adjoining panel:
 - i. Use a BE83BFR72 Raceway Entry Base Feed
 - ii. Select a non-powered panel adjacent to the panel with a Power Distribution Housing.
 - iii. Choose a duplex opening on either side of the panel to insert and attach the Raceway Entry Base Feed at that point.
 - iv. The Raceway Entry Base Feed will attach to the nearest end of the Power Distribution Housing (similar to the Ceiling Feed attachment).

STEP 2: Determine which panels are to be powered.

- a. Use a BE83D Power Distribution Housing that corresponds with the width of the selected panel.

STEP 3: Connect power to the panels.

- a. Use a BE8JC16 Jumper between two adjacent powered panels.
- b. Use a BE8JC20 Jumper between two powered panels separated by a post.
- c. Use a BE8CPxxHH Housing-to-Housing Pass-Thru Cable to connect two powered panels separated by one or more non-powered panels. i. The length of the Pass-Thru Cable corresponds with the width(s) of the non-powered panels that separate two powered panels plus 16" (the termination blocks of the Power Distribution Housing are 8" in from the edge of the powered panel plus 4" for each post).

STEP 4: Designate which circuit each duplex is to tap into.

- a. Each powered panel has four (4) potential locations for duplex receptacles - 2 per side. (Exception: 24" wide panel has only two (2) potential locations - 1 per side, 18" wide panel has no locations for receptacles).
- b. At each location there is a choice of four (4) circuit options. Select the circuit option for each location.

Circuit Selections : Circuits 1, 2, and 3 are utility circuits, all sharing a ground and a neutral. Circuit A is a dedicated circuit with its own ground and neutral.

SPECIFICATION APPLICATIONS

Boulevard System 3 Jumper Applications

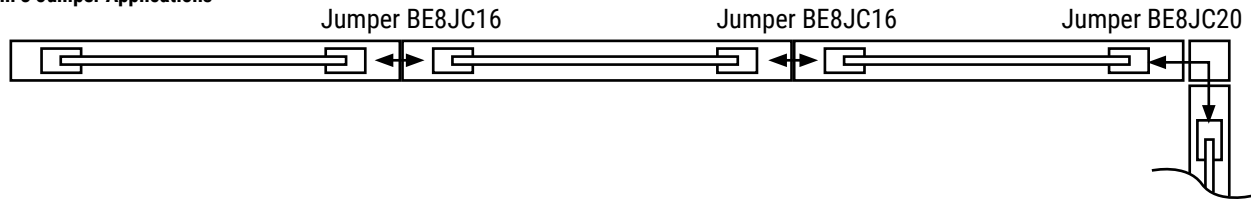

Boulevard System 3 Jumper Applications

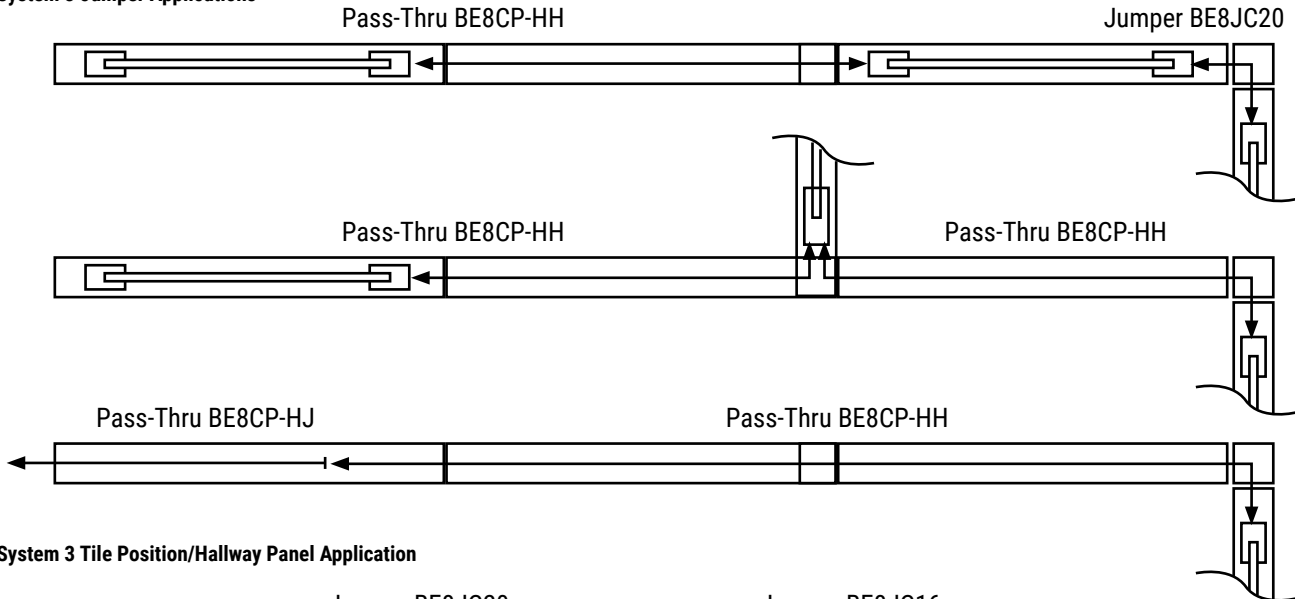

Boulevard System 3 Tile Position/Hallway Panel Application

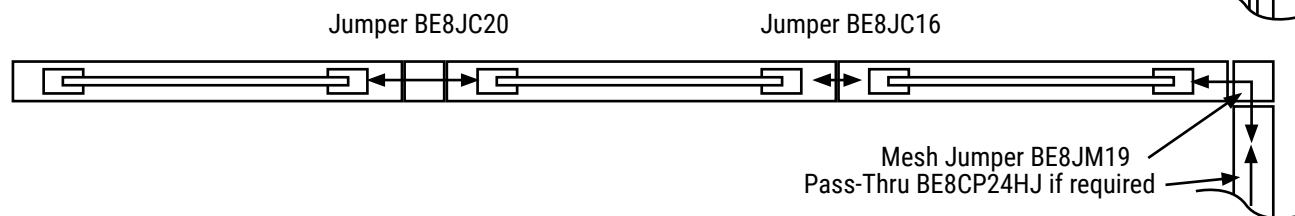

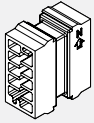
BE8CI-1 • "I" Connector

- Connects two Pass Thru Cables.
- Inline coupler used to connect two BE8CPxxHH Pass-Thru Cables.

| PRODUCT CODE | PRICE | SIZE/ | INCHES | | | WEIGHT VOL | |
|--------------|-------|-------|--------|-------|------|-----------------|--|
| | | H | W | D | LBS | FT ³ | |
| BE8CI1 | 85 | 1.5 | 1.5 | 4.625 | 0.06 | 0.03 | |

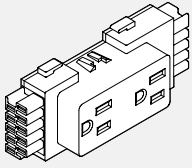
BE8D • Duplex Receptacles

- Snaps into Power Distribution Housing.
- Up to 6 duplex receptacles per circuit.
- BE8D1 = Circuit #1 (utility circuit)
- BE8D2 = Circuit #2 (utility circuit)
- BE8D3 = Circuit #3 (utility circuit)
- BE8DA - Circuit #A (dedicated circuit)

| PRODUCT CODE | PRICE | SIZE/ | INCHES | | | WEIGHT VOL | |
|--------------|-------|-------|--------|------|------|-----------------|--|
| | | H | W | D | LBS | FT ³ | |
| BE8D1 | 35 | 2 | 4.625 | 1.25 | 0.10 | 0.01 | |
| BE8D2 | 35 | 2 | 4.625 | 1.25 | 0.10 | 0.01 | |
| BE8D3 | 35 | 2 | 4.625 | 1.25 | 0.10 | 0.01 | |
| BE8DA | 35 | 2 | 4.625 | 1.25 | 0.10 | 0.01 | |

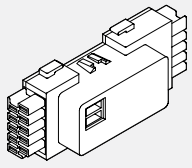
BE8D • USB Receptacles

- Snaps into Power Distribution Housing.
- USB charging module provides convenient charging power access through dual ports on face of receptacles.
- Two USB ports.
- 2 amp output, considered as circuit #1.

| PRODUCT CODE | PRICE | SIZE/ | INCHES | | | WEIGHT VOL | |
|--------------|-------|-------|--------|------|------|-----------------|--|
| | | H | W | D | LBS | FT ³ | |
| BE8DU1-B | 238 | 2 | 4.625 | 1.25 | 0.10 | 0.01 | |
| BE8DU1-W | 238 | 2 | 4.625 | 1.25 | 0.10 | 0.01 | |

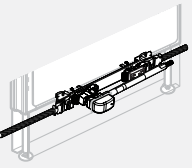
BE83BF • Reversible Base Feed (Boulevard System 3 only)

- Provides single power entry from floor circuit to raceway.
- Takes the place of a duplex receptacle by connecting to the base raceway channel of a Boulevard System 3 panel.
- BE83BF72 includes 72" long liquid-tite conduit, BE83BF144 includes 144" long liquid-tite conduit.
- Must be hard wired to power source by a licensed electrician.

| PRODUCT CODE | PRICE | SIZE/ | INCHES | | | WEIGHT VOL | |
|--------------|-------|-------|--------|---|------|-----------------|--|
| | | H | L | D | LBS | FT ³ | |
| BE83BF72 | 353 | 3 | 72 | 3 | 3.82 | 2 | |
| BE83BF144 | 450 | 3 | 144 | 3 | 6.98 | 2 | |

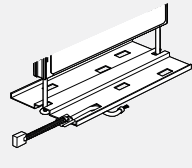
BE83BFR72 • Raceway Entry Base Feed (Boulevard System 3 only)

- Brings power to an adjacent panel by entering a non-powered raceway of a Boulevard System 3 panel through a duplex opening.
- Includes 72" long liquid-tite conduit.
- Must be hard wired to power source by a licensed electrician.

| PRODUCT CODE | PRICE | SIZE/ | INCHES | | | WEIGHT VOL | |
|--------------|-------|-------|--------|---|------|-----------------|--|
| | | H | L | D | LBS | FT ³ | |
| BE83BFR72 | 437 | 3 | 88 | 3 | 4.82 | 2 | |

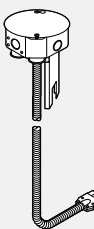
BE8CF-1 • Ceiling Feed - Single

- Provides single power entry from ceiling, through post and into raceway channel.
- Power entry cable penetrates 8" into a panel and plugs into either a Power Distribution Housing or BE8CPxxHJ Pass-Thru Harness.
- Specify Post Extension separately.
- Must be hard wired to power source by a licensed electrician.

| PRODUCT CODE | PRICE | SIZE/ | INCHES | | | WEIGHT VOL | |
|--------------|-------|-------|--------|---|------|-----------------|--|
| | | H | L | D | LBS | FT ³ | |
| BE8CF1201 | 353 | 6 | 120 | 6 | 5.24 | 2 | |
| BE8CF1441 | 479 | 6 | 144 | 6 | 5.96 | 2 | |

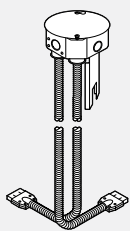
BE8CF-2 • Ceiling Feed - Double

- Provides dual power entry from ceiling, through post and into raceway channel.
- Power entry cable penetrates 8" into a panel and plugs into either a Power Distribution Housing or a BE8CPxxHJ Pass-Thru Harness.
- Use 1) In middle of run to distribute power in two directions.
2) At beginning of run where second Ceiling Feed harness is connected to BE8CPxxHJ and distributes power underneath Power Distribution Housing to pick-up second circuit grouping in long panel run.
- Specify Post Extension separately.
- Must be hard wired to power source by a licensed electrician.

| PRODUCT CODE | PRICE | SIZE/ | INCHES | | | WEIGHT VOL | |
|--------------|-------|-------|--------|---|------|-----------------|--|
| | | H | L | D | LBS | FT ³ | |
| BE8CF1202 | 620 | 6 | 120 | 3 | 5.24 | 2 | |
| BE8CF1442 | 701 | 6 | 144 | 3 | 5.96 | 2 | |

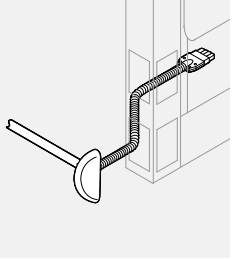
BE81BF-1 • Base Feed - Single (Boulevard 1 only)

- Provides single power entry from floor, through post and into Boulevard 1 raceway channel.
- Power entry cable penetrates 8" into a panel and plugs into either a Power Distribution Housing or a BE8CPxxHJ Pass-Thru Harness.
- Power entry dome available in black only, but "Capture Strip" connector will match the post colour as standard.
- 2 1/2" clearance in depth and 5 1/2" away from any obstructions required from power entry point.
- Comes with 32" harness attached. Liquid-tite whip 72" and 144".
- Must be hard wired to power source by a licensed electrician.

| PRODUCT CODE | PRICE | SIZE/ INCHES | | | WEIGHT VOL | |
|--------------|-------|--------------|-----|---|------------|-----------------|
| | | H | L | D | LBS | FT ³ |
| BE81BF721 | 349 | 6 | 107 | 3 | 3.82 | 2 |
| BE81BF1441 | 466 | 6 | 179 | 3 | 5.96 | 2 |

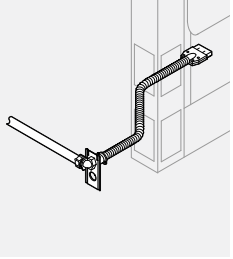
BE81BF-1FL • Base Feed - Single (Boulevard 1 only)

- Provides single power entry from floor, through post and into Boulevard 1 raceway channel.
- Power entry cable penetrates 8" into a panel and plugs into either a Power Distribution Housing or a BE8CPxxHJ Pass-Thru Harness.
- Power entry plate available in black only, but "Capture Strip" connector will match the post colour as standard.
- 2 1/2" clearance in depth and 5 1/2" away from any obstructions required from power entry point.
- Comes with 32" harness attached. Liquid-tite whip 72" and 144".
- Must be hard wired to power source by a licensed electrician.

| PRODUCT CODE | PRICE | SIZE/ INCHES | | | WEIGHT VOL | |
|--------------|-------|--------------|-----|---|------------|-----------------|
| | | H | L | D | LBS | FT ³ |
| BE81BF721FL | 349 | 6 | 107 | 3 | 3.82 | 2 |
| BE81BF1441FL | 466 | 6 | 179 | 3 | 3.82 | 2 |

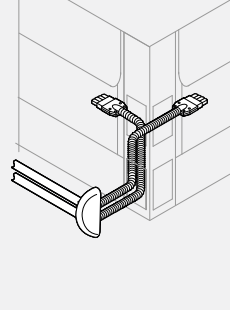
BE81BF-2 • Base Feed - Double (Boulevard 1 only)

- Provides dual power entry from floor, through post and into Boulevard 1 raceway channel.
- Power entry cable penetrates 8" into a panel and plugs into either a Power Distribution Housing or a BE8CPxxHJ Pass-Thru Harness.
- Use 1) In middle of run to distribute power in two directions.
2) At beginning of run where second Base Feed Harness is connected to BE8CPxxHJ and distributes power underneath Power Distribution Housing to pick-up second circuit grouping in long panel run.
- Liquitite whip 72" and 144".
- Power entry box available in black only, but "Capture Strip" connector will match the post colour as standard.
- 2 1/2" clearance in depth and 5 1/2" away from any obstructions required from power entry point.
- Comes with 32" harness attached.
- Must be hard wired to power source by a licensed electrician.

| PRODUCT CODE | PRICE | SIZE/ INCHES | | | WEIGHT VOL | |
|--------------|-------|--------------|-----|---|------------|-----------------|
| | | H | L | D | LBS | FT ³ |
| BE81BF722 | 737 | 6 | 107 | 3 | 6.98 | 2 |
| BE81BF1442 | 983 | 6 | 179 | 3 | 6.98 | 2 |

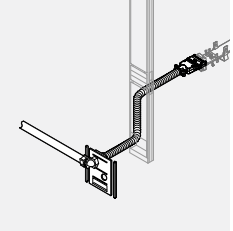
BE81BF601 • Base Feed - Single (Boulevard 1 only)

- Provides single power entry from floor, through 6" panel and into Boulevard 1 raceway panel.
- Power entry cable penetrates 8" into a panel and plugs into either a Power Distribution Housing or a BE8CPxxHJ Pass-Thru Harness.
- For 6" Power/Cable Access Panel only.
- Comes with 32" harness attached.
- Liquitite whip 72".
- Must be hard wired to power source by a licensed electrician.

| PRODUCT CODE | PRICE | SIZE/ INCHES | | | WEIGHT VOL | |
|--------------|-------|--------------|-----|---|------------|-----------------|
| | | H | L | D | LBS | FT ³ |
| BE81BF601 | 380 | 6 | 107 | 3 | 4.90 | 0.062 |

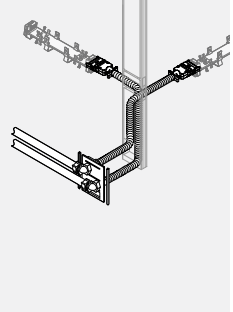
BE81BF602 • Base Feed - Double (Boulevard 1 only)

- Provides dual power entry from floor, through 6" panel and into Boulevard 1 raceway panel.
- Power entry cable penetrates 8" into a panel and plugs into either a Power Distribution Housing or a BE8CPxxHJ Pass-Thru Harness.
- Use 1. In middle of run to distribute power in two directions.
2. At beginning of run where second Base Feed Harness is connected to BE8CPxxHJ and distributes power underneath Power Distribution Housing to pick-up second circuit grouping in long panel run.
- For 6" Power/Cable Access Panel only.
- Comes with 2x32" harness attached.
- Liquitite whip 72".
- Must be hard wired to power source by a licensed electrician.

| PRODUCT CODE | PRICE | SIZE/ INCHES | | | WEIGHT VOL | |
|--------------|-------|--------------|-----|---|------------|-----------------|
| | | H | L | D | LBS | FT ³ |
| BE81BF602 | 761 | 6 | 107 | 3 | 5.30 | 0.071 |

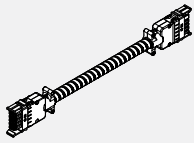
BE8JC • Jumper Cable

- **Electrically connects two Power Distribution Housings.**
- The BE8JC16 electrically connects two powered panels positioned side by side.
- The BE8JC20 electrically connects two powered panels separated by a post.
- Wires are concealed in a flexible metal conduit.
- Cannot go through a Boulevard 1 post in a corner application. (Please use the Jumper Cable Mesh)

| PRODUCT CODE | PRICE | SIZE/ H | INCHES | | | WEIGHT VOL | |
|-----------------|-------|------------|--------|-----|------|-----------------|--|
| | | | L | D | LBS | FT ³ | |
| BE8JC16 | 160 | 2 | 16.75 | 0.5 | 0.66 | 1.17 | |
| BE8JC20 | 162 | 2 | 20.75 | 0.5 | 0.78 | 1.17 | |

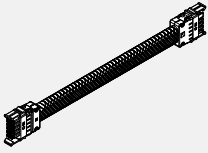
BE8JM19 • Jumper Cable Mesh

- **Electrically connects two Power Distribution Housings in Boulevard 1 panels that are separated by a post in a corner application.**
- BE8JM19 - Wires are covered with a durable nylon mesh.
- BE8JMS19 - Wires are concealed in a flexible metal shroud and covered with a durable nylon mesh.
- Used in System 3 Panels at tile position passing through post at corner application.

| PRODUCT CODE | PRICE | SIZE/ H | INCHES | | | WEIGHT VOL | |
|-----------------|-------|------------|--------|-----|------|-----------------|--|
| | | | L | D | LBS | FT ³ | |
| BE8JM19 | 162 | 2 | 19 | 0.5 | 0.75 | 1.17 | |
| BE8JMS19 | 184 | 2 | 19 | 0.5 | 0.75 | 1.17 | |

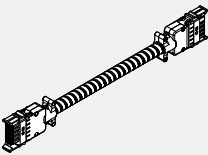
BE83BT • Base-to-Tile Cable

- **Electrically connects a Base Raceway Power Distribution Housing to a Face Mount Tile Power Distribution Housing within a System 3 PV panel.**
- Wires are concealed in a flexible metal conduit.
- BE83BT82 to be used on panels manufactured before November 1st, 2014 and BE83BT40 after.

| PRODUCT CODE | PRICE | SIZE/ H | INCHES | | | WEIGHT VOL | |
|-----------------|-------|------------|--------|-----|------|-----------------|--|
| | | | L | D | LBS | FT ³ | |
| BE83BT82 | 191 | 2 | 82.5 | 0.5 | 3.05 | 1.38 | |
| BE83BT40 | 161 | 2 | 40.5 | 0.5 | 1.44 | 1.17 | |

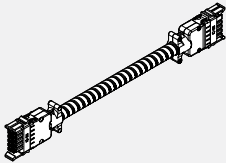
BE8CP-HH • Housing-to-Housing Pass-Thru Cable

- **Electrically connects two Power Distribution Housings in panels separated by one or more non-powered panels.**
- Wires are concealed in a flexible metal conduit.
- **NOTE** : In Boulevard 1 and or System 3 tile position applications, the Housing-to-Housing Pass-Thru Cables can only be used in a straight run.

| PRODUCT CODE | PRICE | SIZE/ H | INCHES | | | WEIGHT VOL | |
|-----------------|-------|------------|--------|-----|------|-----------------|--|
| | | | L | D | LBS | FT ³ | |
| BE8CP40HH | 161 | 2 | 40.5 | 0.5 | 1.44 | 1.17 | |
| BE8CP46HH | 167 | 2 | 46.5 | 0.5 | 1.71 | 1.17 | |
| BE8CP52HH | 177 | 2 | 52.5 | 0.5 | 1.95 | 1.17 | |
| BE8CP58HH | 184 | 2 | 58.5 | 0.5 | 2.21 | 1.17 | |
| BE8CP64HH | 190 | 2 | 64.5 | 0.5 | 2.37 | 1.17 | |
| BE8CP70HH | 196 | 2 | 70.5 | 0.5 | 2.6 | 1.17 | |
| BE8CP76HH | 204 | 2 | 76.5 | 0.5 | 2.81 | 1.17 | |
| BE8CP82HH | 213 | 2 | 82.5 | 0.5 | 3.03 | 1.17 | |
| BE8CP88HH | 221 | 2 | 88.5 | 0.5 | 3.05 | 1.17 | |
| BE8CP94HH | 226 | 2 | 94.5 | 0.5 | 3.30 | 1.17 | |
| BE8CP100HH | 233 | 2 | 100.5 | 0.5 | 3.47 | 1.17 | |
| BE8CP106HH | 242 | 2 | 106.5 | 0.5 | 3.87 | 1.17 | |
| BE8CP118HH | 256 | 2 | 118.5 | 0.5 | 4.08 | 1.17 | |
| BE8CP130HH | 268 | 2 | 130.5 | 0.5 | 4.73 | 1.17 | |
| BE8CP142HH | 282 | 2 | 142.5 | 0.5 | 4.99 | 1.17 | |

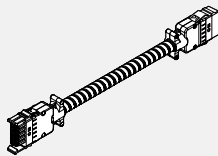
BE8CP-HJ • Housing-to-Jumper Pass-Thru Cable

- **Electrically connects a Power Distribution Housing to a Housing connection of a harness.**
- Wires are concealed in a flexible metal conduit.
- **NOTE** : In both Boulevard 1 and System 3 Tile Position applications, the Housing-to-Jumper Pass-Thru Cables can only be used in a straight run.

| PRODUCT CODE | PRICE | SIZE/ H | INCHES | | | WEIGHT VOL | |
|-----------------|-------|------------|--------|-----|------|-----------------|--|
| | | | L | D | LBS | FT ³ | |
| BE8CP24HJ | 144 | 2 | 24 | 0.5 | 0.9 | 1.17 | |
| BE8CP30HJ | 151 | 2 | 30 | 0.5 | 1.3 | 1.17 | |
| BE8CP36HJ | 156 | 2 | 36 | 0.5 | 1.44 | 1.17 | |
| BE8CP42HJ | 169 | 2 | 42 | 0.5 | 1.71 | 1.17 | |
| BE8CP48HJ | 177 | 2 | 48 | 0.5 | 1.95 | 1.17 | |
| BE8CP54HJ | 188 | 2 | 54 | 0.5 | 2.21 | 1.17 | |
| BE8CP60HJ | 196 | 2 | 60 | 0.5 | 2.37 | 1.17 | |
| BE8CP72HJ | 204 | 2 | 72 | 0.5 | 2.81 | 1.17 | |
| BE8CP84HJ | 220 | 2 | 84 | 0.5 | 3.05 | 1.17 | |
| BE8CP96HJ | 233 | 2 | 96 | 0.5 | 3.3 | 1.17 | |
| BE8CP108HJ | 243 | 2 | 108 | 0.5 | 3.87 | 1.17 | |
| BE8CP120HJ | 257 | 2 | 120 | 0.5 | 4.08 | 1.17 | |
| BE8CP144HJ | 293 | 2 | 144 | 0.5 | 4.59 | 1.17 | |

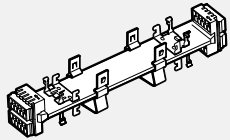
BE81D • Power Distribution Housing Kit - Concealed Desk Height (Boulevard 1 only)

- Provides two duplex receptacles per panel for all panel widths above 24" wide.
- Power Distribution Housing is specified per panel size. eg. BE81D36 is for use with a 36" panel.

| PRODUCT CODE | PRICE | SIZE/ H | INCHES | | WEIGHT VOL | |
|--------------|-------|------------|--------|------|------------|-----------------|
| | | | L | D | LBS | FT ³ |
| BE81D24 | 198 | 2 | 9.25 | 2.61 | 0.83 | 1.17 |
| BE81D30 | 208 | 2 | 15.25 | 2.61 | 1.28 | 1.17 |
| BE81D36 | 220 | 2 | 21.25 | 2.61 | 1.62 | 1.65 |
| BE81D42 | 226 | 2 | 27.25 | 2.61 | 2.00 | 2.00 |
| BE81D48 | 238 | 2 | 33.25 | 2.61 | 2.32 | 2.54 |
| BE81D54 | 242 | 2 | 39.25 | 2.61 | 2.66 | 3.20 |
| BE81D60 | 243 | 2 | 45.25 | 2.61 | 3.04 | 3.20 |
| BE81D66 | 310 | 2 | 51.25 | 2.61 | 3.49 | 3.25 |
| BE81D72 | 341 | 2 | 57.2 | 2.61 | 3.76 | 3.30 |

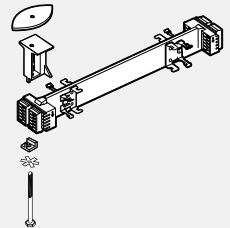
BE8U2D • Power Distribution Housing Kit - Face Mount Desk Height (Boulevard 1 only)

- Provides two duplex receptacles per panel side for all panel widths above 24" wide.
- Power Distribution Housing is specified per panel size. eg. BE8U2D36 is for use with a 36" panel.
- 24" wide panel allows for only one (1) duplex receptacle per panel side.

| PRODUCT CODE | PRICE | SIZE/ H | INCHES | | WEIGHT VOL | |
|--------------|-------|------------|--------|------|------------|-----------------|
| | | | L | D | LBS | FT ³ |
| BE8U2D24 | 198 | 2 | 9.25 | 2.61 | 0.83 | 1.17 |
| BE8U2D30 | 208 | 2 | 15.25 | 2.61 | 1.28 | 1.17 |
| BE8U2D36 | 220 | 2 | 21.25 | 2.61 | 1.62 | 1.65 |
| BE8U2D42 | 226 | 2 | 27.25 | 2.61 | 2.00 | 2.00 |
| BE8U2D48 | 238 | 2 | 33.25 | 2.61 | 2.32 | 2.54 |
| BE8U2D54 | 242 | 2 | 39.25 | 2.61 | 2.66 | 3.20 |
| BE8U2D60 | 243 | 2 | 45.25 | 2.61 | 3.04 | 3.20 |
| BE8U2D66 | 310 | 2 | 51.25 | 2.61 | 3.49 | 3.25 |
| BE8U2D72 | 341 | 2 | 57.25 | 2.61 | 3.76 | 3.30 |

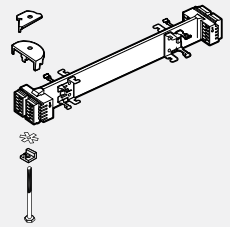
BE83D • Power Distribution Housing Kit - Base Raceway (Boulevard System 3 only)

- Provides two duplex receptacles per panel side for all panel widths above 24" wide.
- Power Distribution Housing is specified per panel size. eg. BE83D36 is for use with a 36" panel.
- 24" wide panel allows for only one (1) duplex receptacle per panel side.

| PRODUCT CODE | PRICE | SIZE/ H | INCHES | | WEIGHT VOL | |
|--------------|-------|------------|--------|------|------------|-----------------|
| | | | L | D | LBS | FT ³ |
| BE83D24 | 198 | 2 | 9.25 | 2.61 | 0.83 | 1.17 |
| BE83D30 | 208 | 2 | 15.25 | 2.61 | 1.28 | 1.17 |
| BE83D36 | 220 | 2 | 21.25 | 2.61 | 1.62 | 1.65 |
| BE83D42 | 226 | 2 | 27.25 | 2.61 | 2.00 | 2.00 |
| BE83D48 | 238 | 2 | 33.25 | 2.61 | 2.32 | 2.54 |
| BE83D54 | 242 | 2 | 39.25 | 2.61 | 2.66 | 3.20 |
| BE83D60 | 243 | 2 | 45.25 | 2.61 | 3.04 | 3.20 |
| BE83D66 | 310 | 2 | 51.25 | 2.61 | 3.49 | 3.25 |
| BE83D72 | 341 | 2 | 57.25 | 2.61 | 3.76 | 3.30 |

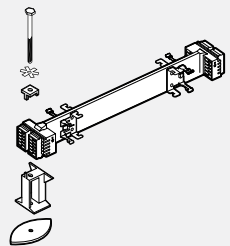
BE8U3FM • Power Distribution Housing Kit - Face Mount Tile (Boulevard System 3 only)

- Provides two duplex receptacles for all tile widths above 24". 24" wide tile allows for one (1) duplex receptacle.
- Housing and mounting hardware included.
- Specify duplexes, cables and tiles separately.
- BE83BT40 Base-to-Tile Cable is used to connect the tile mounted housing to the Power Distribution Housing tile in the base of the same "PV" panel.
- 24" wide tiles have one duplex and one data/comm opening. 30" and wider tiles have two data/comm openings.
- Note: Not compatible with panels built prior November 1st, 2014.

| PRODUCT CODE | PRICE | SIZE/ H | INCHES | | WEIGHT VOL | |
|--------------|-------|------------|--------|------|------------|-----------------|
| | | | L | D | LBS | FT ³ |
| BE8U3FM24 | 198 | 2 | 9.25 | 2.61 | 0.83 | 1.17 |
| BE8U3FM30 | 208 | 2 | 15.25 | 2.61 | 1.28 | 1.17 |
| BE8U3FM36 | 220 | 2 | 21.25 | 2.61 | 1.62 | 1.65 |
| BE8U3FM42 | 226 | 2 | 27.25 | 2.61 | 2.00 | 2.00 |
| BE8U3FM48 | 238 | 2 | 33.25 | 2.61 | 2.32 | 2.54 |
| BE8U3FM54 | 242 | 2 | 39.25 | 2.61 | 2.66 | 3.20 |
| BE8U3FM60 | 243 | 2 | 45.25 | 2.61 | 3.04 | 3.20 |
| BE8U3FM66 | 310 | 2 | 51.25 | 2.61 | 3.49 | 3.25 |
| BE8U3FM72 | 341 | 2 | 57.25 | 2.61 | 3.76 | 3.30 |

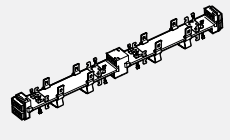
BE81D-CM • Centermount Power Distribution Housing Quad Kit - Concealed Desk Height (B1 only)

- Provides four duplex receptacles per panel for widths 36" and above.
- Centermount Distribution Housing is specified per panel size. ie. BE81D36CM is for 36" panel.
- Not available for panels less than 36" wide.

| PRODUCT CODE | PRICE | SIZE/ H | INCHES | | WEIGHT VOL | |
|--------------|-------|------------|--------|------|------------|-----------------|
| | | | L | D | LBS | FT ³ |
| BE81D36CM | 363 | 2 | 21.99 | 2.61 | 3.24 | 1.65 |
| BE81D42CM | 374 | 2 | 27.99 | 2.61 | 4.00 | 2.00 |
| BE81D48CM | 382 | 2 | 33.99 | 2.61 | 4.64 | 2.54 |
| BE81D54CM | 389 | 2 | 39.99 | 2.61 | 5.32 | 3.20 |
| BE81D60CM | 396 | 2 | 45.99 | 2.61 | 6.04 | 3.20 |
| BE81D66CM | 462 | 2 | 51.99 | 2.61 | 6.98 | 3.25 |
| BE81D72CM | 529 | 2 | 57.99 | 2.61 | 7.52 | 3.30 |

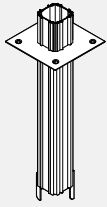
BEPE • Post Extension

- **Lightweight aluminum pole to be used to bring power and/or data/communication cables from ceiling to a panel through a post.**
- Attaches to ceiling and post.
- Includes connectors, ceiling trim plate and screws.
- Post extension will accept:
 - 75 cables 5.6mm (0.220") dia. data cables
 - 60 cables 5.6mm (0.220") dia. data cables with 1 power feed
 - 45 cables 5.6mm (0.220") dia. data cables with 2 power feeds.
- Ceiling bezel is white only.

| PRODUCT CODE | PRICE | SIZE/ | INCHES | | | WEIGHT VOL | |
|--------------|-------|-------|--------|------|------|-----------------|--|
| | | | L | D | LBS | FT ³ | |
| BEPE49 | 124 | 49 | 2.61 | 2.61 | 5.00 | 0.258 | |
| BEPE81 | 188 | 81 | 2.61 | 2.61 | 9.00 | 0.424 | |

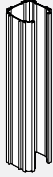
BHPOST • Lay in Post Extension

- **Three sided lightweight aluminum pole to be used to bring power and/or data/communication cables from ceiling to a panel. True lay-in application use**
- Attaches to ceiling and post.
- Includes connectors and ceiling bezel plate and screws.
- Requires vertical end trim to enclose when used in 2 way and 3 way panel run application.
- Trim encloses lay-in cable post extension, sold separately.

| PRODUCT CODE | PRICE | TYPE | SIZE/ | INCHES | | | WEIGHT VOL | |
|--------------|-------|-----------|-------|--------|------|---|------------|-----------------|
| | | | | H | L | D | LBS | FT ³ |
| BHPOST66 | 195 | BASE | 66 | 2.61 | 2.61 | 8 | 0.346 | |
| BHPOSTE30 | 91 | EXTENSION | 30 | 2.61 | 2.61 | 5 | 0.195 | |
| BHPOSTE78 | 237 | EXTENSION | 78 | 2.61 | 2.61 | 9 | 0.430 | |

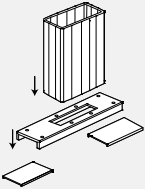
BE2PE • Off-Module Post Extension

- **An alternative to the existing Ceiling Post, allows for an off-module Ceiling Feed location.**
- Attaches to the top of horizontal trim.
- Panel ceiling post consists of two aluminum extrusions for a true lay-in application.
- Includes brackets, hardware and ceiling trim plate and screws.
- Harness length will vary in length depending on post location along the panel.
- Can only be used with Boulevard System 3 "PV" and "MV" Panels.
- Requires on site cutting of top trim for placement along panel.

| PRODUCT CODE | PRICE | SIZE/ | INCHES | | | WEIGHT VOL | |
|--------------|-------|-------|--------|------|---|------------|-----------------|
| | | | H | L | D | LBS | FT ³ |
| BE2PE49 | 281 | 49 | 7.61 | 3.00 | 5 | 0.258 | |
| BE2PE81 | 415 | 81 | 7.61 | 3.00 | 9 | 0.424 | |

Worksurfaces

Global Contract offers a wide variety of worksurfaces and user friendly worksurface shapes to support a variety of tasks, applications and personal preferences.

- 1 1/16" particle board.
- 45 lb. density
- 100% recycled from post consumer industrial material
- "Scoops" for cable management.
- All worksurfaces have threaded inserts for metal-to-metal connection of support hardware.

- High and Low pressure worksurfaces are 3mm edge banded.
- Wood veneer surfaces or solid wood edges available.

Technical Information

Worksurfaces

- All worksurfaces have threaded inserts for metal-to-metal connection of support hardware.
- Back edge features scoop detail.
- Worksurfaces 48" or less have one scoop while those that are 54" or more have a double scoop feature with a 1/2" wire passage trough between the scoops.
- LP and HP worksurfaces are 3mm edge banded.
- LP worksurfaces are 1" thick particle board with laminate finish.
- HP worksurfaces are 1 1/16" thick particle board with laminate finish.
- T worksurfaces are 1 1/16" thick particle board with laminate finish and wood trim.
- W worksurfaces are 1 3/16" thick particle board with wood veneer finish. Edge is solid wood edge banded.
- One universal cantilever supports two abutting worksurfaces.

- 20" deep worksurfaces available at same price as 24" deep worksurfaces.
- Support hardware must be ordered separately.
- Edge banded worksurfaces without scoops available, substitute "NFL" for "SCP" at the end of the code.

Transaction Worksurfaces

- To install transaction worksurfaces to a 42" high panel, use BHBT02 bracket.
- To install transaction worksurfaces to a 37" high panel, use BHBT37 bracket.

WORKSURFACE COMPONENTS - GUIDELINES FOR ORDERING PRODUCT

Codes

The price list uses a numbering system with meaningful alphanumeric characters to create a simple-to-understand product number. This makes specifying the product much easier and more accurate.

Example of Worksurface: **BWS2460PHPMR71TCHR**

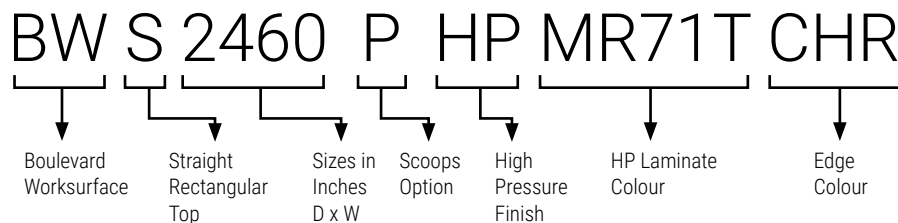

How to Specify

- Specify Boulevard worksurface type and size by code.
- Specify scoops option by adding "P" at end of code.
- Specify type of finish.
- Specify High Pressure Laminate Colour.
- Specify PVC edge colour.

Example of Hardware: **BHC24 CHR**

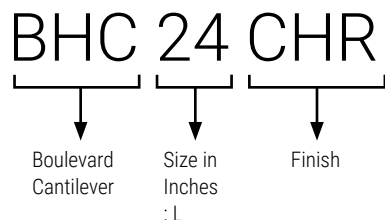

How to Specify

- Specify Boulevard hardware type and size by code.
- Specify type of finish.

BWS • Straight Rectangular Worksurface

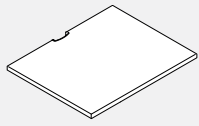

Worksurfaces 54" or Less

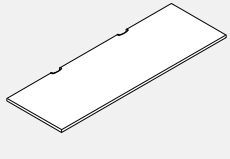

Worksurfaces 60" or Longer

- Straight rectangular worksurfaces are non-handed and can be interchanged on site.
- Please choose from DWT - Designer White, SIL - Silver or BLK - Black for scoop covers.
- Surfaces with wood trim (T) and complete wood (W) will not have the plastic scoop, they will remain with the curve cut scoop.
- To specify wood trim (T) or complete wood (W) surfaces, please remove the last "P" from the code, replace with "SCP" and add either a "T" or "W" and the old scoop style is going to be created.

| PRODUCT CODE | PRICE | | GROUP | | | SIZE / INCHES | | | WEIGHT | VOL |
|--------------|-------|-----|-------|------|---|---------------|----|-----|-----------------|-----|
| | LP* | HP* | T* | W* | H | W | D | LBS | FT ³ | |
| BWS1818P | 127 | 161 | 377 | 494 | 1 | 18 | 18 | 9 | 0.29 | |
| BWS1824P | 131 | 174 | 384 | 584 | 1 | 24 | 18 | 12 | 0.39 | |
| BWS1830P | 138 | 183 | 413 | 683 | 1 | 30 | 18 | 15 | 0.49 | |
| BWS1836P | 159 | 210 | 450 | 780 | 1 | 36 | 18 | 18 | 0.59 | |
| BWS1842P | 208 | 278 | 532 | 913 | 1 | 42 | 18 | 21 | 0.68 | |
| BWS1848P | 249 | 328 | 540 | 952 | 1 | 48 | 18 | 24 | 0.78 | |
| BWS1854P | 293 | 385 | 773 | 1096 | 1 | 54 | 18 | 27 | 0.88 | |
| BWS1860P | 329 | 422 | 780 | 1115 | 1 | 60 | 18 | 30 | 1.00 | |
| BWS1866P | 344 | 452 | 803 | 1145 | 1 | 66 | 18 | 32 | 1.10 | |
| BWS1872P | 363 | 478 | 828 | 1173 | 1 | 72 | 18 | 35 | 1.20 | |
| BWS1878P | 380 | 503 | 999 | 1250 | 1 | 78 | 18 | 38 | 1.30 | |
| BWS1884P | 417 | 546 | 1026 | 1325 | 1 | 84 | 18 | 41 | 1.40 | |
| BWS2418P | 131 | 168 | 410 | 549 | 1 | 18 | 24 | 12 | 0.40 | |
| BWS2424P | 133 | 178 | 419 | 652 | 1 | 24 | 24 | 16 | 0.52 | |
| BWS2430P | 145 | 190 | 448 | 768 | 1 | 30 | 24 | 20 | 0.65 | |
| BWS2436P | 161 | 213 | 483 | 875 | 1 | 36 | 24 | 23 | 0.78 | |
| BWS2442P | 211 | 280 | 565 | 1030 | 1 | 42 | 24 | 28 | 0.90 | |
| BWS2448P | 252 | 339 | 575 | 1129 | 1 | 48 | 24 | 31 | 1.03 | |
| BWS2454P | 299 | 394 | 803 | 1282 | 1 | 54 | 24 | 35 | 1.20 | |
| BWS2460P | 336 | 443 | 809 | 1313 | 1 | 60 | 24 | 39 | 1.30 | |
| BWS2466P | 350 | 462 | 819 | 1352 | 1 | 66 | 24 | 43 | 1.41 | |
| BWS2472P | 366 | 484 | 852 | 1391 | 1 | 72 | 24 | 47 | 1.54 | |
| BWS2478P | 392 | 516 | 922 | 1486 | 1 | 78 | 24 | 51 | 1.70 | |
| BWS2484P | 422 | 553 | 1023 | 1584 | 1 | 84 | 24 | 55 | 1.80 | |
| BWS3018P | 149 | 192 | 442 | 655 | 1 | 18 | 30 | 15 | 0.50 | |
| BWS3024P | 159 | 208 | 450 | 788 | 1 | 24 | 30 | 20 | 0.70 | |
| BWS3030P | 170 | 225 | 518 | 911 | 1 | 30 | 30 | 25 | 0.97 | |
| BWS3036P | 200 | 264 | 563 | 1055 | 1 | 36 | 30 | 30 | 1.06 | |
| BWS3042P | 283 | 373 | 668 | 1101 | 1 | 42 | 30 | 34 | 1.12 | |
| BWS3048P | 299 | 394 | 679 | 1176 | 1 | 48 | 30 | 39 | 1.30 | |
| BWS3054P | 327 | 420 | 873 | 1342 | 1 | 54 | 30 | 44 | 1.44 | |
| BWS3060P | 350 | 462 | 878 | 1381 | 1 | 60 | 30 | 49 | 1.60 | |
| BWS3066P | 364 | 483 | 908 | 1472 | 1 | 66 | 30 | 54 | 1.80 | |
| BWS3072P | 385 | 510 | 957 | 1560 | 1 | 72 | 30 | 59 | 2.00 | |
| BWS3078P | 410 | 540 | 1039 | 1669 | 1 | 78 | 30 | 64 | 2.10 | |
| BWS3084P | 456 | 596 | 1101 | 1780 | 1 | 84 | 30 | 69 | 2.24 | |
| BWS3672P | 544 | 714 | 1158 | 1855 | 1 | 72 | 36 | 71 | 2.30 | |

BWSP • Straight Rectangular Worksurface to span a Post

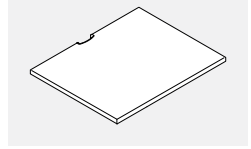

Worksurfaces 57" or Less

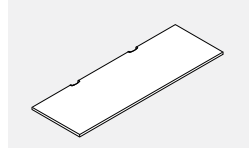

Worksurfaces 63" or Longer

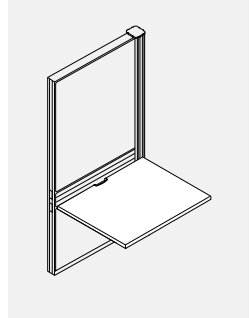

Application of Worksurface

- Straight rectangular worksurfaces are non-handed and can be interchanged on site.
- Worksurface will span the width of a post eliminating a gap between standard sizes.
- Please choose from DWT - Designer White, SIL - Silver or BLK - Black for scoop covers.
- Surfaces with wood trim (T) and complete wood (W) will not have the plastic scoop, they will remain with the curve cut scoop.
- To specify wood trim (T) or complete wood (W) surfaces, please remove the last "P" from the code, replace with "SCP" and add either a "T" or "W" and the old scoop style is going to be created.

| PRODUCT CODE | PRICE LP* | GROUP HP* | T* | W* | SIZE / INCHES | | | WEIGHT LBS | VOL FT ³ |
|--------------|-----------|-----------|------|------|---------------|----|----|------------|---------------------|
| | | | | | H | W | D | | |
| BWSP1821P | 131 | 174 | 384 | 584 | 1 | 21 | 18 | 10 | 0.34 |
| BWSP1827P | 138 | 183 | 413 | 683 | 1 | 27 | 18 | 13 | 0.44 |
| BWSP1833P | 159 | 210 | 450 | 780 | 1 | 33 | 18 | 16 | 0.53 |
| BWSP1839P | 208 | 278 | 532 | 913 | 1 | 39 | 18 | 19 | 0.63 |
| BWSP1845P | 249 | 328 | 540 | 952 | 1 | 45 | 18 | 22 | 0.72 |
| BWSP1851P | 293 | 385 | 647 | 972 | 1 | 51 | 18 | 25 | 0.82 |
| BWSP1857P | 329 | 422 | 780 | 1115 | 1 | 57 | 18 | 28 | 0.92 |
| BWSP1863P | 344 | 452 | 803 | 1145 | 1 | 63 | 18 | 31 | 1.01 |
| BWSP1869P | 363 | 478 | 828 | 1173 | 1 | 69 | 18 | 34 | 1.11 |
| BWSP1875P | 380 | 503 | 897 | 1250 | 1 | 75 | 18 | 37 | 1.21 |
| BWSP1881P | 417 | 546 | 946 | 1325 | 1 | 81 | 18 | 40 | 1.30 |
| BWSP1887P | 448 | 590 | 996 | 1405 | 1 | 87 | 18 | 43 | 1.40 |
| BWSP2421P | 133 | 178 | 419 | 652 | 1 | 21 | 24 | 14 | 0.45 |
| BWSP2427P | 145 | 190 | 448 | 768 | 1 | 27 | 24 | 17 | 0.60 |
| BWSP2433P | 161 | 213 | 483 | 875 | 1 | 33 | 24 | 21 | 0.70 |
| BWSP2439P | 211 | 280 | 565 | 1030 | 1 | 39 | 24 | 25 | 0.83 |
| BWSP2445P | 252 | 339 | 575 | 1129 | 1 | 45 | 24 | 29 | 1.00 |
| BWSP2451P | 299 | 394 | 678 | 1158 | 1 | 51 | 24 | 33 | 1.10 |
| BWSP2457P | 336 | 443 | 809 | 1313 | 1 | 57 | 24 | 37 | 1.22 |
| BWSP2463P | 350 | 462 | 852 | 1352 | 1 | 63 | 24 | 41 | 1.34 |
| BWSP2469P | 366 | 484 | 896 | 1391 | 1 | 69 | 24 | 45 | 1.47 |
| BWSP2475P | 392 | 516 | 922 | 1486 | 1 | 75 | 24 | 49 | 1.60 |
| BWSP2481P | 422 | 553 | 974 | 1584 | 1 | 81 | 24 | 53 | 1.73 |
| BWSP2487P | 456 | 607 | 1025 | 1678 | 1 | 87 | 24 | 57 | 1.90 |
| BWSP3021P | 168 | 208 | 450 | 788 | 1 | 21 | 30 | 17 | 0.56 |
| BWSP3027P | 170 | 225 | 518 | 911 | 1 | 27 | 30 | 22 | 0.72 |
| BWSP3033P | 200 | 264 | 563 | 1055 | 1 | 33 | 30 | 27 | 0.88 |
| BWSP3039P | 283 | 373 | 668 | 1101 | 1 | 39 | 30 | 32 | 1.04 |
| BWSP3045P | 299 | 394 | 679 | 1176 | 1 | 45 | 30 | 37 | 1.20 |
| BWSP3051P | 327 | 420 | 748 | 1217 | 1 | 51 | 30 | 41 | 1.40 |
| BWSP3057P | 350 | 462 | 878 | 1381 | 1 | 57 | 30 | 46 | 1.51 |
| BWSP3063P | 364 | 483 | 908 | 1472 | 1 | 63 | 30 | 51 | 1.67 |
| BWSP3069P | 385 | 510 | 957 | 1560 | 1 | 69 | 30 | 56 | 1.83 |
| BWSP3075P | 410 | 540 | 1039 | 1669 | 1 | 75 | 30 | 61 | 2.00 |
| BWSP3081P | 456 | 596 | 1101 | 1780 | 1 | 81 | 30 | 66 | 2.20 |
| BWSP3087P | 503 | 665 | 1161 | 1887 | 1 | 87 | 30 | 70 | 2.30 |
| BWSP3675P | 557 | 733 | 1158 | 1855 | 1 | 75 | 36 | 73 | 2.40 |

• LP = Thermally Fused Laminate, HP = High Pressure Laminate, T= High Pressure Laminate with Wood Trim, W= Wood Veneer

BWS • Straight Rectangular Worksurface without Flex Lip or Scoops

- Straight rectangular worksurfaces are non-handed and can be interchanged on site.
- Worksurface features no scoop or flex lip.

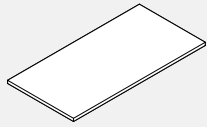

| PRODUCT CODE | PRICE LP* | GROUP HP* | T* | W* | SIZE/INCHES | | | WEIGHT LBS | VOL FT ³ |
|--------------|-----------|-----------|------|------|-------------|----|----|------------|---------------------|
| | | | | | H | W | D | | |
| BWS1818NFL | 127 | 161 | 249 | 367 | 1 | 18 | 18 | 9 | 0.28 |
| BWS1824NFL | 131 | 174 | 259 | 458 | 1 | 24 | 18 | 12 | 0.40 |
| BWS1830NFL | 138 | 183 | 289 | 560 | 1 | 30 | 18 | 15 | 0.50 |
| BWS1836NFL | 159 | 210 | 324 | 655 | 1 | 36 | 18 | 18 | 0.59 |
| BWS1842NFL | 208 | 278 | 407 | 788 | 1 | 42 | 18 | 21 | 0.68 |
| BWS1848NFL | 249 | 328 | 416 | 825 | 1 | 48 | 18 | 24 | 0.78 |
| BWS1854NFL | 293 | 385 | 522 | 847 | 1 | 54 | 18 | 27 | 0.88 |
| BWS1860NFL | 329 | 422 | 530 | 863 | 1 | 60 | 18 | 29 | 0.97 |
| BWS1866NFL | 344 | 452 | 554 | 906 | 1 | 66 | 18 | 32 | 1.10 |
| BWS1872NFL | 363 | 478 | 583 | 922 | 1 | 72 | 18 | 35 | 1.20 |
| BWS1878NFL | 380 | 503 | 647 | 999 | 1 | 78 | 18 | 38 | 1.30 |
| BWS1884NFL | 417 | 546 | 696 | 1077 | 1 | 84 | 18 | 41 | 1.40 |
| BWS2418NFL | 131 | 168 | 285 | 425 | 1 | 18 | 24 | 12 | 0.40 |
| BWS2424NFL | 133 | 178 | 291 | 528 | 1 | 24 | 24 | 16 | 0.52 |
| BWS2430NFL | 145 | 190 | 321 | 645 | 1 | 30 | 24 | 20 | 0.65 |
| BWS2436NFL | 161 | 213 | 357 | 751 | 1 | 36 | 24 | 24 | 0.78 |
| BWS2442NFL | 211 | 280 | 439 | 902 | 1 | 42 | 24 | 28 | 0.90 |
| BWS2448NFL | 252 | 339 | 449 | 1004 | 1 | 48 | 24 | 31 | 1.03 |
| BWS2454NFL | 299 | 394 | 554 | 1033 | 1 | 54 | 24 | 35 | 1.20 |
| BWS2460NFL | 336 | 443 | 561 | 1063 | 1 | 60 | 24 | 39 | 1.30 |
| BWS2466NFL | 350 | 462 | 600 | 1104 | 1 | 66 | 24 | 43 | 1.41 |
| BWS2472NFL | 366 | 484 | 645 | 1142 | 1 | 72 | 24 | 47 | 1.54 |
| BWS2478NFL | 392 | 516 | 670 | 1239 | 1 | 78 | 24 | 51 | 1.70 |
| BWS2484NFL | 422 | 553 | 722 | 1334 | 1 | 84 | 24 | 55 | 1.80 |
| BWS3018NFL | 149 | 192 | 318 | 530 | 1 | 18 | 30 | 15 | 0.50 |
| BWS3024NFL | 159 | 208 | 325 | 662 | 1 | 24 | 30 | 20 | 0.65 |
| BWS3030NFL | 170 | 225 | 392 | 784 | 1 | 30 | 30 | 25 | 0.81 |
| BWS3036NFL | 200 | 264 | 437 | 929 | 1 | 36 | 30 | 29 | 1.00 |
| BWS3042NFL | 283 | 373 | 544 | 975 | 1 | 42 | 30 | 34 | 1.13 |
| BWS3048NFL | 299 | 394 | 555 | 1051 | 1 | 48 | 30 | 39 | 1.30 |
| BWS3054NFL | 327 | 420 | 624 | 1092 | 1 | 54 | 30 | 44 | 1.44 |
| BWS3060NFL | 350 | 462 | 628 | 1132 | 1 | 60 | 30 | 49 | 1.60 |
| BWS3066NFL | 364 | 483 | 658 | 1221 | 1 | 66 | 30 | 54 | 1.76 |
| BWS3072NFL | 385 | 510 | 706 | 1245 | 1 | 72 | 30 | 59 | 1.91 |
| BWS3078NFL | 410 | 540 | 789 | 1420 | 1 | 78 | 30 | 64 | 2.10 |
| BWS3084NFL | 456 | 596 | 851 | 1530 | 1 | 84 | 30 | 69 | 2.24 |
| BWS3672NFL | 544 | 714 | 1158 | 1855 | 1 | 72 | 36 | 71 | 2.30 |

BWSC • Curvelinear Front Edge Worksurface

- Curvelinear front edge worksurface.
- Allows efficient use of a small footprint.
- The curve on the 30" and 36" wide worksurfaces have been modified to allow a pedestal to fit.
- Please choose from DWT - Designer White, SIL - Silver or BLK - Black for scoop covers.
- Surfaces with wood trim (T) and complete wood (W) will not have the plastic scoop, they will remain with the curve cut scoop.
- To specify wood trim (T) or complete wood (W) surfaces, please remove the last "P" from the code, replace with "SCP" and add either a "T" or "W" and the old scoop style is going to be created.
- Surfaces 60" wide will have two scoops, all others have one scoop.

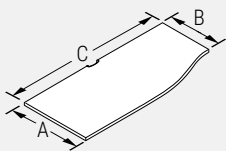

NOTE: BWSC

| | | |
|-------|-------|--------|
| 24 | 18 | 30 |
| A | B | C |
| WIDTH | WIDTH | LENGTH |

| PRODUCT CODE | PRICE LP* | GROUP HP* | T* | W* | SIZE/INCHES | | | WEIGHT LBS | VOL FT ³ |
|--------------|-----------|-----------|------|------|-------------|----|----|------------|---------------------|
| | | | | | H | W | D | | |
| BWSC182430P | 182 | 240 | 614 | 1010 | 1 | 30 | 24 | 18 | 0.65 |
| BWSC182436P | 217 | 289 | 659 | 1156 | 1 | 36 | 24 | 22 | 0.78 |
| BWSC182442P | 252 | 339 | 765 | 1202 | 1 | 42 | 24 | 26 | 0.90 |
| BWSC182448P | 289 | 385 | 775 | 1279 | 1 | 48 | 24 | 30 | 1.03 |
| BWSC182454P | 327 | 433 | 967 | 1445 | 1 | 54 | 24 | 34 | 1.20 |
| BWSC182460P | 354 | 483 | 975 | 1485 | 1 | 60 | 24 | 38 | 1.30 |
| BWSC241830P | 182 | 240 | 614 | 1010 | 1 | 30 | 24 | 18 | 0.65 |
| BWSC241836P | 217 | 289 | 659 | 1156 | 1 | 36 | 24 | 22 | 0.78 |
| BWSC241842P | 252 | 339 | 765 | 1202 | 1 | 42 | 24 | 26 | 0.90 |
| BWSC241848P | 289 | 385 | 775 | 1279 | 1 | 48 | 24 | 30 | 1.03 |
| BWSC241854P | 327 | 433 | 967 | 1445 | 1 | 54 | 24 | 34 | 1.2 |
| BWSC241860P | 354 | 483 | 975 | 1485 | 1 | 60 | 24 | 38 | 1.3 |
| BWSC243030P | 192 | 251 | 760 | 1272 | 1 | 30 | 30 | 23 | 0.81 |
| BWSC243036P | 229 | 289 | 819 | 1378 | 1 | 36 | 30 | 28 | 1 |
| BWSC243042P | 312 | 412 | 958 | 1629 | 1 | 42 | 30 | 33 | 1.13 |
| BWSC243048P | 327 | 433 | 967 | 1648 | 1 | 48 | 30 | 38 | 1.3 |
| BWSC243054P | 364 | 483 | 1184 | 1938 | 1 | 54 | 30 | 42 | 1.44 |
| BWSC243060P | 391 | 528 | 1193 | 1955 | 1 | 60 | 30 | 47 | 1.6 |
| BWSC302430P | 192 | 251 | 760 | 1272 | 1 | 30 | 30 | 23 | 0.81 |
| BWSC302436P | 229 | 289 | 819 | 1378 | 1 | 36 | 30 | 28 | 1 |
| BWSC302442P | 312 | 412 | 958 | 1629 | 1 | 42 | 30 | 33 | 1.13 |
| BWSC302448P | 327 | 433 | 967 | 1648 | 1 | 48 | 30 | 38 | 1.3 |
| BWSC302454P | 364 | 483 | 1184 | 1938 | 1 | 54 | 30 | 42 | 1.44 |
| BWSC302460P | 391 | 528 | 1193 | 1955 | 1 | 60 | 30 | 47 | 1.6 |

• LP = Thermally Fused Laminate, HP = High Pressure Laminate, T= High Pressure Laminate with Wood Trim, W= Wood Veneer

BWCC • Curved Corner Worksurface

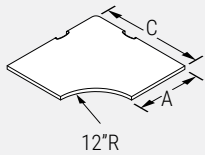

NOTE: BWCC

36 C WIDTH
18 A DEPTH

- Allows efficient use of corner space for computer or printer applications.
- BWCC3624 has a front radius of 12". It is not usable for keyboard support.
- Please choose from DWT - Designer White, SIL - Silver or BLK - Black for scoop covers.
- Surfaces with wood trim (T) and complete wood (W) will not have the plastic scoop, they will remain with the curve cut scoop.
- To specify wood trim (T) or complete wood (W) surfaces, please remove the last "P" from the code, replace with "SCP" and add either a "T" or "W" and the old scoop style is going to be created.

| PRODUCT CODE | PRICE LP* | GROUP | | | SIZE/INCHES | | | WEIGHT LBS | VOL FT ³ |
|--------------|-----------|-------|------|------|-------------|----|----|------------|---------------------|
| | | HP* | T* | W* | H | W | D | | |
| BWCC3618P | 397 | 495 | 875 | 1528 | 1 | 36 | 36 | 29 | 1.20 |
| BWCC3624P | 439 | 548 | 875 | 1528 | 1 | 36 | 36 | 32 | 1.20 |
| BWCC4224P | 591 | 736 | 1111 | 1762 | 1 | 42 | 42 | 41 | 1.60 |
| BWCC4230P | 607 | 759 | 1111 | 1762 | 1 | 42 | 42 | 45 | 1.60 |
| BWCC4824P | 688 | 857 | 1377 | 2243 | 1 | 48 | 48 | 50 | 2.00 |
| BWCC4830P | 688 | 857 | 1377 | 2243 | 1 | 48 | 48 | 56 | 2.00 |

| CODE | RADIUS "R" |
|-----------|------------|
| BWCC3618P | 18" |
| BWCC3624P | 12" |
| BWCC4224P | 18" |
| BWCC4230P | 12" |
| BWCC4824P | 24" |
| BWCC4830P | 18" |

NOTE: 12" radius not recommended for keyboards

BWCF • Five Sided Corner Worksurface

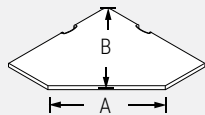

- Creates efficient use of corner space for computer or printer applications.
- Please choose from DWT - Designer White, SIL - Silver or BLK - Black for scoop covers.
- Surfaces with wood trim (T) and complete wood (W) will not have the plastic scoop, they will remain with the curve cut scoop.
- To specify wood trim (T) or complete wood (W) surfaces, please remove the last "P" from the code, replace with "SCP" and add either a "T" or "W" and the old scoop style is going to be created.

| PRODUCT CODE | PRICE LP* | GROUP | | | SIZE/INCHES | | | WEIGHT LBS | VOL FT ³ |
|--------------|-----------|-------|------|------|-------------|----|----|------------|---------------------|
| | | HP* | T* | W* | H | W | D | | |
| BWCF3012P | 259 | 320 | 828 | 1366 | 1 | 30 | 30 | 28 | 1.00 |
| BWCF3612P | 341 | 425 | 944 | 1380 | 1 | 36 | 36 | 30 | 1.03 |
| BWCF3618P | 341 | 425 | 844 | 1380 | 1 | 36 | 36 | 31 | 1.20 |
| BWCF3624P | 354 | 446 | 844 | 1380 | 1 | 36 | 36 | 33 | 1.20 |
| BWCF3630P | 372 | 465 | 844 | 1380 | 1 | 36 | 36 | 35 | 1.20 |
| BWCF4218P | 485 | 607 | 1064 | 1612 | 1 | 42 | 42 | 40 | 1.60 |
| BWCF4224P | 503 | 627 | 1064 | 1612 | 1 | 42 | 42 | 45 | 1.60 |
| BWCF4230P | 517 | 652 | 1064 | 1612 | 1 | 42 | 42 | 47 | 1.60 |
| BWCF4818P | 550 | 689 | 1158 | 1767 | 1 | 48 | 48 | 40 | 1.60 |
| BWCF4824P | 567 | 707 | 1158 | 1767 | 1 | 48 | 48 | 45 | 1.60 |
| BWCF4830P | 596 | 747 | 1158 | 1767 | 1 | 48 | 48 | 47 | 1.60 |

| CODE | PANEL SIZES | ADJOINED WORKSURFACE DEPTH | A | B |
|-----------|-------------|----------------------------|------|------|
| BWCF3012P | 30 | 12 | 25.5 | 29.8 |
| BWCF3612P | 36 | 12 | 34.0 | 34.0 |
| BWCF3618P | 36 | 18 | 25.5 | 37.9 |
| BWCF3624P | 36 | 24 | 17.0 | 42.1 |
| BWCF3630P | 36 | 30 | 8.5 | 46.4 |
| BWCF4218P | 42 | 18 | 33.9 | 42.1 |
| BWCF4224P | 42 | 24 | 25.5 | 46.4 |
| BWCF4230P | 42 | 30 | 17.0 | 50.6 |
| BWCF4818P | 48 | 18 | 42.4 | 46.4 |
| BWCF4824P | 48 | 24 | 33.9 | 50.6 |
| BWCF4830P | 48 | 30 | 25.5 | 54.8 |

BWCL • "L" Corner Worksurface

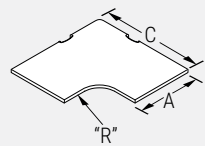

NOTE: BWCL
• 5" radius not recommended for keyboards.

36 C WIDTH
18 A DEPTH

- Creates efficient use of corner space for computer or printer applications.
- Please choose from DWT - Designer White, SIL - Silver or BLK - Black for scoop covers.
- Surfaces with wood trim (T) and complete wood (W) will not have the plastic scoop, they will remain with the curve cut scoop.
- To specify wood trim (T) or complete wood (W) surfaces, please remove the last "P" from the code, replace with "SCP" and add either a "T" or "W" and the old scoop style is going to be created.

| PRODUCT CODE | PRICE LP* | GROUP | | | SIZE/INCHES | | | WEIGHT LBS | VOL FT ³ |
|--------------|-----------|-------|-----|------|-------------|----|----|------------|---------------------|
| | | HP* | T* | W* | H | W | D | | |
| BWCL3018P | 236 | 293 | 463 | 1336 | 1 | 30 | 30 | 20 | 0.80 |
| BWCL3024P | 241 | 305 | 463 | 1336 | 1 | 30 | 30 | 23 | 0.80 |
| BWCL3618P | 354 | 446 | 626 | 1342 | 1 | 36 | 36 | 27 | 1.20 |
| BWCL3624P | 373 | 465 | 626 | 1342 | 1 | 36 | 36 | 31 | 1.20 |
| BWCL3630P | 389 | 485 | 626 | 1342 | 1 | 36 | 36 | 34 | 1.20 |
| BWCL4218P | 518 | 645 | 861 | 1575 | 1 | 42 | 42 | 32 | 1.60 |
| BWCL4224P | 536 | 668 | 861 | 1575 | 1 | 42 | 42 | 39 | 1.60 |
| BWCL4230P | 550 | 689 | 861 | 1575 | 1 | 42 | 42 | 44 | 1.60 |
| BWCL4818P | 567 | 709 | 997 | 1739 | 1 | 48 | 48 | 38 | 2.00 |
| BWCL4824P | 581 | 726 | 997 | 1739 | 1 | 48 | 48 | 47 | 2.00 |
| BWCL4830P | 600 | 749 | 997 | 1739 | 1 | 48 | 48 | 54 | 2.00 |

• LP = Thermally Fused Laminate, HP = High Pressure Laminate, T= High Pressure Laminate with Wood Trim, W= Wood Veneer

BWAC45 • Curved Corner Worksurface for 45 Degree Angle

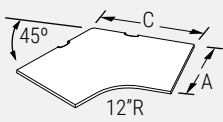

- **Five sided corner unit for 45 degree Corner Posts.**
- Creates efficient use of space for computer or printer application.
- Please choose from DWT - Designer White, SIL - Silver or BLK - Black for scoop covers.
- Surfaces with wood trim (T) and complete wood (W) will not have the plastic scoop, they will remain with the curve cut scoop.
- To specify wood trim (T) or complete wood (W) surfaces, please remove the last "P" from the code, replace with "SCP" and add either a "T" or "W" and the old scoop style is going to be created.

NOTE: BWAC

| | | |
|----------|-------|-------|
| 45° | 24 | 18 |
| | C | A |
| 45° POST | WIDTH | DEPTH |

| PRODUCT CODE | PRICE LP* | GROUP HP* | T* | W* | SIZE/INCHES | | | WEIGHT LBS | VOL FT³ |
|--------------|-----------|-----------|------|------|-------------|----|----|------------|---------|
| | | | | | H | W | D | | |
| BWAC452418P | 397 | 495 | 1077 | 1437 | 1 | 24 | 18 | 38 | 1.14 |
| BWAC452424P | 411 | 516 | 1624 | 2168 | 1 | 24 | 24 | 42 | 1.29 |
| BWAC452430P | 431 | 537 | 2146 | 2864 | 1 | 24 | 30 | 48 | 1.45 |
| BWAC453018P | 512 | 638 | 1309 | 1742 | 1 | 30 | 18 | 53 | 1.61 |
| BWAC453024P | 578 | 723 | 1556 | 2075 | 1 | 30 | 24 | 60 | 1.80 |
| BWAC453030P | 641 | 802 | 1991 | 2655 | 1 | 30 | 30 | 66 | 2.01 |
| BWAC453618P | 720 | 895 | 1515 | 2022 | 1 | 36 | 18 | 66 | 2.01 |
| BWAC453624P | 797 | 998 | 1868 | 2486 | 1 | 36 | 24 | 71 | 2.16 |
| BWAC453630P | 877 | 1094 | 2352 | 3135 | 1 | 36 | 30 | 76 | 2.30 |

BWAC60 • Curved Corner Worksurface for 60 Degree Angle

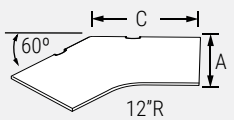

- **Five sided corner unit for 60 degree Corner Posts.**
- Creates efficient use of space for computer or printer application.
- Please choose from DWT - Designer White, SIL - Silver or BLK - Black for scoop covers.
- Surfaces with wood trim (T) and complete wood (W) will not have the plastic scoop, they will remain with the curve cut scoop.
- To specify wood trim (T) or complete wood (W) surfaces, please remove the last "P" from the code, replace with "SCP" and add either a "T" or "W" and the old scoop style is going to be created.

NOTE: BWAC

| | | |
|----------|-------|-------|
| 60° | 24 | 18 |
| | C | A |
| 60° POST | WIDTH | DEPTH |

| PRODUCT CODE | PRICE LP* | GROUP HP* | T* | W* | SIZE/INCHES | | | WEIGHT LBS | VOL FT³ |
|--------------|-----------|-----------|------|------|-------------|----|----|------------|---------|
| | | | | | H | W | D | | |
| BWAC602418P | 341 | 425 | 896 | 1192 | 1 | 24 | 18 | 33 | 0.99 |
| BWAC602424P | 354 | 446 | 1073 | 1427 | 1 | 24 | 24 | 36 | 1.09 |
| BWAC602430P | 372 | 465 | 1137 | 1517 | 1 | 24 | 30 | 39 | 1.19 |
| BWAC603018P | 465 | 581 | 1097 | 1461 | 1 | 30 | 18 | 48 | 1.46 |
| BWAC603024P | 508 | 631 | 1291 | 1725 | 1 | 30 | 24 | 52 | 1.58 |
| BWAC603030P | 544 | 683 | 1407 | 1875 | 1 | 30 | 30 | 56 | 1.71 |
| BWAC603618P | 661 | 829 | 1281 | 1706 | 1 | 36 | 18 | 66 | 2.01 |
| BWAC603624P | 712 | 892 | 1515 | 2022 | 1 | 36 | 24 | 71 | 2.16 |
| BWAC603630P | 762 | 954 | 1649 | 2200 | 1 | 36 | 30 | 76 | 2.31 |

BWCE • Extended Curved Corner Worksurface

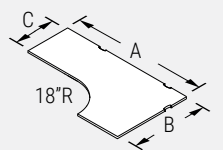

- **Extended curved corner unit with a radius user edge.**
- Creates efficient use of a corner unit.
- Please choose from DWT - Designer White, SIL - Silver or BLK - Black for scoop covers.
- Surfaces with wood trim (T) and complete wood (W) will not have the plastic scoop, they will remain with the curve cut scoop.
- To specify wood trim (T) or complete wood (W) surfaces, please remove the last "P" from the code, replace with "SCP" and add either a "T" or "W" and the old scoop style is going to be created.

NOTE: BWCE

| | | |
|-------|-------|--------|
| 60 | 42 | 24 |
| A | B | C |
| WIDTH | WIDTH | LENGTH |

| PRODUCT CODE | PRICE LP* | GROUP HP* | T* | W* | SIZE/INCHES | | | WEIGHT LBS | VOL FT³ |
|--------------|-----------|-----------|------|------|-------------|----|----|------------|---------|
| | | | | | H | W | D | | |
| BWCE426024P | 688 | 857 | 1316 | 2161 | 1 | 60 | 42 | 57 | 2.2 |
| BWCE426624P | 758 | 947 | 1376 | 2254 | 1 | 66 | 42 | 62 | 2.5 |
| BWCE427224P | 835 | 1045 | 1541 | 2527 | 1 | 72 | 42 | 66 | 2.7 |
| BWCE427824P | 893 | 1117 | 1647 | 2695 | 1 | 78 | 42 | 71 | 2.9 |
| BWCE428424P | 962 | 1201 | 1772 | 2905 | 1 | 84 | 42 | 75 | 3.1 |
| BWCE486024P | 786 | 984 | 1635 | 2682 | 1 | 60 | 48 | 66 | 2.5 |
| BWCE486624P | 874 | 1092 | 1685 | 2826 | 1 | 66 | 48 | 71 | 2.8 |
| BWCE487224P | 956 | 1197 | 1685 | 2826 | 1 | 72 | 48 | 76 | 3.1 |
| BWCE487824P | 1021 | 1273 | 1854 | 3041 | 1 | 78 | 48 | 83 | 3.3 |
| BWCE488424P | 1083 | 1352 | 1854 | 3041 | 1 | 84 | 48 | 93 | 3.6 |
| BWCE486030P | 874 | 1092 | 1635 | 2682 | 1 | 60 | 48 | 68 | 2.5 |
| BWCE486630P | 956 | 1197 | 1721 | 2825 | 1 | 66 | 48 | 74 | 2.8 |
| BWCE487230P | 1021 | 1273 | 1762 | 2887 | 1 | 72 | 48 | 80 | 3.1 |
| BWCE487830P | 1083 | 1352 | 1910 | 3131 | 1 | 78 | 48 | 85 | 3.3 |
| BWCE488430P | 1158 | 1450 | 2058 | 3369 | 1 | 84 | 48 | 96 | 3.6 |
| BWCE604224P | 688 | 857 | 1316 | 2161 | 1 | 42 | 60 | 57 | 2.2 |
| BWCE604824P | 786 | 984 | 1635 | 2682 | 1 | 48 | 60 | 66 | 2.6 |
| BWCE604830P | 874 | 1092 | 1635 | 2682 | 1 | 48 | 60 | 68 | 2.6 |
| BWCE664224P | 758 | 947 | 1376 | 2254 | 1 | 42 | 66 | 62 | 2.5 |
| BWCE664824P | 874 | 1092 | 1685 | 2826 | 1 | 48 | 66 | 71 | 2.8 |
| BWCE664830P | 956 | 1197 | 1721 | 2825 | 1 | 48 | 66 | 74 | 2.8 |
| BWCE724224P | 835 | 1045 | 1541 | 2527 | 1 | 42 | 72 | 66 | 2.7 |
| BWCE724824P | 956 | 1197 | 1685 | 2826 | 1 | 48 | 72 | 76 | 3.1 |
| BWCE724830P | 1021 | 1273 | 1762 | 2887 | 1 | 48 | 72 | 80 | 3.1 |
| BWCE784224P | 893 | 1117 | 1647 | 2695 | 1 | 42 | 78 | 71 | 2.9 |
| BWCE784824P | 1021 | 1273 | 1854 | 3041 | 1 | 48 | 78 | 83 | 3.3 |
| BWCE784830P | 1083 | 1352 | 1910 | 3131 | 1 | 48 | 78 | 85 | 3.3 |
| BWCE844224P | 962 | 1201 | 1772 | 2905 | 1 | 42 | 84 | 75 | 3.1 |
| BWCE844824P | 1083 | 1352 | 1854 | 3043 | 1 | 48 | 84 | 93 | 3.6 |
| BWCE844830P | 1158 | 1450 | 2058 | 3369 | 1 | 48 | 84 | 96 | 3.6 |

• LP = Thermally Fused Laminate, HP = High Pressure Laminate, T= High Pressure Laminate with Wood Trim, W= Wood Veneer

BWCEC • Extended Curvilinear Corner Worksurface

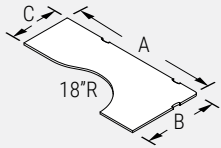

- **Extended curved corner unit with a radius user edge.**
- Creates efficient use of a corner unit.
- Please choose from DWT - Designer White, SIL - Silver or BLK - Black for scoop covers.
- Surfaces with wood trim (T) and complete wood (W) will not have the plastic scoop, they will remain with the curve cut scoop.
- To specify wood trim (T) or complete wood (W) surfaces, please remove the last "P" from the code, replace with "SCP" and add either a "T" or "W" and the old scoop style is going to be created.

NOTE: BWSC

| | | |
|-----------|-----------|-----------|
| 66 | 42 | 24 |
| A | B | C |
| WIDTH | WIDTH | LENGTH |

| PRODUCT CODE | PRICE LP* | GROUP HP* | T* | W* | SIZE/INCHES | | | WEIGHT LBS | VOL FT ³ |
|--------------|-----------|-----------|------|------|-------------|----|----|------------|---------------------|
| | | | | | A | B | C | | |
| BWCEC366024P | 645 | 805 | 1631 | 2172 | 36 | 60 | 24 | 59 | 0.05 |
| BWCEC366624P | 678 | 846 | 1692 | 2254 | 36 | 66 | 24 | 65 | 0.60 |
| BWCEC367224P | 737 | 922 | 1868 | 2486 | 36 | 72 | 24 | 71 | 0.07 |
| BWCEC367824P | 801 | 1000 | 1976 | 2633 | 36 | 78 | 24 | 77 | 0.07 |
| BWCEC368424P | 894 | 1117 | 2174 | 2810 | 36 | 84 | 24 | 83 | 0.08 |
| BWCEC426624P | 780 | 973 | 1972 | 2629 | 42 | 66 | 24 | 76 | 0.07 |
| BWCEC427224P | 863 | 1078 | 2174 | 2900 | 42 | 72 | 24 | 83 | 0.08 |
| BWCEC427824P | 920 | 1152 | 2306 | 3073 | 42 | 78 | 24 | 90 | 0.08 |
| BWCEC428424P | 992 | 1238 | 2461 | 3281 | 42 | 84 | 24 | 96 | 0.09 |
| BWCEC487230P | 1053 | 1317 | 2402 | 3200 | 48 | 72 | 30 | 94 | 0.09 |
| BWCEC487830P | 1132 | 1416 | 2564 | 3415 | 48 | 78 | 30 | 102 | 0.09 |
| BWCEC488430P | 1196 | 1495 | 2726 | 3629 | 48 | 84 | 30 | 110 | 0.10 |
| BWCEC488424P | 1131 | 1416 | 2461 | 3281 | 48 | 84 | 24 | 110 | 0.10 |
| BWCEC603624P | 645 | 805 | 1631 | 2172 | 60 | 36 | 24 | 59 | 0.05 |
| BWCEC663624P | 678 | 846 | 1692 | 2254 | 66 | 36 | 24 | 65 | 0.60 |
| BWCEC664224P | 780 | 973 | 1972 | 2629 | 66 | 42 | 24 | 76 | 0.07 |
| BWCEC723624P | 737 | 922 | 1868 | 2486 | 72 | 36 | 24 | 71 | 0.07 |
| BWCEC724224P | 863 | 1078 | 2174 | 2900 | 72 | 42 | 24 | 83 | 0.08 |
| BWCEC724830P | 1053 | 1317 | 2402 | 3200 | 72 | 48 | 30 | 94 | 0.09 |
| BWCEC783624P | 801 | 1000 | 1976 | 2633 | 78 | 36 | 24 | 77 | 0.07 |
| BWCEC784224P | 920 | 1152 | 2306 | 3073 | 78 | 42 | 24 | 89 | 0.08 |
| BWCEC784830P | 1132 | 1416 | 2564 | 3415 | 78 | 48 | 30 | 102 | 0.09 |
| BWCEC843624P | 894 | 1117 | 2174 | 2810 | 84 | 36 | 24 | 83 | 0.08 |
| BWCEC844224P | 992 | 1238 | 2174 | 2810 | 84 | 42 | 24 | 96 | 0.09 |
| BWCEC844824P | 1131 | 1416 | 2461 | 3281 | 84 | 48 | 24 | 110 | 0.10 |
| BWCEC844830P | 1196 | 1495 | 2726 | 3629 | 84 | 48 | 30 | 110 | 0.10 |

BWSL • Curvilinear Arc Worksurface

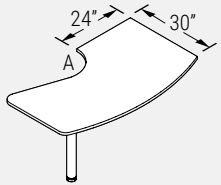

- **Arc shaped worksurface provides an extended conferencing area.**
- 1 BHML03 Monoleg included.
- Not recommended for use with modesty panel due to knee swing interference.
- For chrome finish on leg, please add \$109 list upcharge.

RIGHT HAND SHOWN MONO-LEG MOUNTED ON THE RIGHT USER SIDE.

| PRODUCT CODE | PRICE LP* | GROUP HP* | T* | W* | SIZE/INCHES | | | WEIGHT LBS | VOL FT ³ |
|--------------|-----------|-----------|------|------|-------------|----|----|------------|---------------------|
| | | | | | H | W | D | | |
| BWSL3060L | 893 | 1062 | 1214 | 2063 | 29 | 60 | 30 | 48 | 1.69 |
| BWSL3066L | 935 | 1112 | 1349 | 2311 | 29 | 66 | 30 | 53 | 1.85 |
| BWSL3072L | 972 | 1165 | 1485 | 2564 | 29 | 72 | 30 | 58 | 2.01 |
| BWSL3060R | 893 | 1062 | 1214 | 2063 | 29 | 60 | 30 | 48 | 1.69 |
| BWSL3066R | 935 | 1112 | 1349 | 2311 | 29 | 66 | 30 | 53 | 1.85 |
| BWSL3072R | 972 | 1165 | 1485 | 2564 | 29 | 72 | 30 | 58 | 2.01 |

- A = 27" for 60", 66" worksurfaces
- A = 26.5" for 72" worksurfaces

BWSL • Curvilinear Arc Worksurface

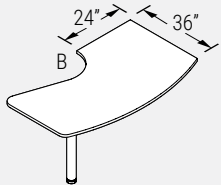

- **Arc shaped worksurface provides an extended conferencing area.**
- 1 BHML03 Monoleg included.
- For chrome finish on leg, please add \$109 list upcharge.

RIGHT HAND SHOWN MONO-LEG MOUNTED ON THE RIGHT USER SIDE.

| PRODUCT CODE | PRICE LP* | GROUP HP* | T* | W* | SIZE/INCHES | | | WEIGHT LBS | VOL FT ³ |
|--------------|-----------|-----------|------|------|-------------|----|----|------------|---------------------|
| | | | | | H | W | D | | |
| BWSL3660L | 1012 | 1212 | 1380 | 2375 | 29 | 60 | 36 | 57 | 2.07 |
| BWSL3666L | 1095 | 1317 | 1541 | 2663 | 29 | 66 | 36 | 64 | 2.26 |
| BWSL3672L | 1174 | 1416 | 1698 | 2955 | 29 | 72 | 36 | 71 | 2.45 |
| BWSL3660R | 1012 | 1212 | 1380 | 2375 | 29 | 60 | 36 | 57 | 2.07 |
| BWSL3666R | 1095 | 1317 | 1541 | 2663 | 29 | 66 | 36 | 64 | 2.26 |
| BWSL3672R | 1174 | 1416 | 1698 | 2955 | 29 | 72 | 36 | 71 | 2.45 |

- B = 33" for 60", 66" worksurfaces
- B = 32.5" for 72" worksurfaces

• LP = Thermally Fused Laminate, HP = High Pressure Laminate, T= High Pressure Laminate with Wood Trim, W= Wood Veneer

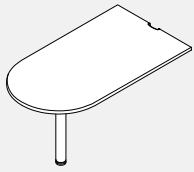
BWD • "D" Worksurface

- **Rounded worksurface for conferencing.**
- Supported by Monoleg at one end and panel at the opposite end.
- 1 BHML03 Monoleg included.
- Modesty panel available, see BWMP (not included).
- For chrome finish on leg, please add \$109 list upcharge.
- Please choose from DWT - Designer White, SIL - Silver or BLK - Black for scoop covers.
- Surfaces with wood trim (T) and complete wood (W) will not have the plastic scoop, they will remain with the curve cut scoop.
- To specify wood trim (T) or complete wood (W) surfaces, please remove the last "P" from the code, replace with "SCP" and add either a "T" or "W" and the old scoop style is going to be created.

| PRODUCT CODE | PRICE LP* | GROUP | | | SIZE/INCHES | | | WEIGHT LBS | VOL FT ³ |
|--------------|-----------|-------|------|------|-------------|----|----|------------|---------------------|
| | | HP* | T* | W* | H | W | D | | |
| BWD2442P | 569 | 659 | 722 | 1243 | 1 | 42 | 24 | 27 | 0.97 |
| BWD2448P | 593 | 693 | 754 | 1285 | 1 | 48 | 24 | 31 | 1.11 |
| BWD2454P | 610 | 712 | 832 | 1530 | 1 | 54 | 24 | 35 | 1.24 |
| BWD2460P | 623 | 725 | 870 | 1774 | 1 | 60 | 24 | 39 | 1.36 |
| BWD2466P | 641 | 754 | 908 | 1840 | 1 | 66 | 24 | 43 | 1.52 |
| BWD2472P | 661 | 779 | 946 | 1933 | 1 | 72 | 24 | 47 | 1.66 |
| BWD3048P | 596 | 695 | 863 | 1766 | 1 | 48 | 30 | 38 | 1.38 |
| BWD3054P | 627 | 733 | 897 | 1826 | 1 | 54 | 30 | 43 | 1.56 |
| BWD3060P | 665 | 780 | 941 | 1941 | 1 | 60 | 30 | 48 | 1.69 |
| BWD3066P | 694 | 817 | 1010 | 2036 | 1 | 66 | 30 | 53 | 1.82 |
| BWD3072P | 731 | 864 | 1034 | 2135 | 1 | 72 | 30 | 58 | 2.01 |
| BWD3078P | 774 | 917 | 1103 | 2295 | 1 | 78 | 30 | 63 | 2.25 |
| BWD3084P | 840 | 999 | 1173 | 2457 | 1 | 84 | 30 | 68 | 2.42 |

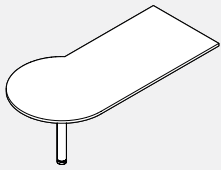
BWP • "P" Worksurface

- **Rounded worksurface provides an extended conferencing area.**
- **36" diameter end.**
- Supported by monoleg at one end and panel at the opposite end.
- 1 BHML03 Monoleg included.
- Modesty panel available, see BWMP (not included).
- For chrome finish on leg, please add \$109 list upcharge.

| PRODUCT CODE | PRICE LP* | GROUP | | | SIZE/INCHES | | | WEIGHT LBS | VOL FT ³ |
|--------------|-----------|-------|------|------|-------------|----|----|------------|---------------------|
| | | HP* | T* | W* | H | W | D | | |
| BWPL3054 | 877 | 1038 | 1203 | 2567 | 1 | 54 | 36 | 51 | 1.87 |
| BWPL3060 | 916 | 1088 | 1214 | 2593 | 1 | 60 | 36 | 58 | 2.03 |
| BWPL3066 | 992 | 1182 | 1245 | 2915 | 1 | 66 | 36 | 65 | 2.24 |
| BWPL3072 | 1034 | 1236 | 1370 | 3239 | 1 | 72 | 36 | 70 | 2.41 |
| BWPL3084 | 1143 | 1374 | 1731 | 3821 | 1 | 84 | 36 | 81 | 2.79 |
| BWPR3054 | 877 | 1038 | 1203 | 2567 | 1 | 54 | 36 | 51 | 1.87 |
| BWPR3060 | 916 | 1088 | 1214 | 2593 | 1 | 60 | 36 | 58 | 2.03 |
| BWPR3066 | 992 | 1182 | 1245 | 2915 | 1 | 66 | 36 | 65 | 2.24 |
| BWPR3072 | 1034 | 1236 | 1370 | 3239 | 1 | 72 | 36 | 70 | 2.41 |
| BWPR3084 | 1143 | 1374 | 1731 | 3821 | 1 | 84 | 36 | 81 | 2.79 |

LEFT HAND SHOWN

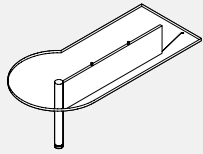
BWMP • "D" and "P" Worksurface Modesty Panel

- **Made of cold rolled steel, fastens to the worksurface and Monoleg for additional privacy.**

| PRODUCT CODE | PRICE | SIZE/INCHES | | | WEIGHT LBS | VOL FT ³ |
|--------------|-------|-------------|----|----|------------|---------------------|
| | | H | W | D | | |
| BWMP1248 | 126 | 1 | 32 | 12 | 12 | 0.4 |
| BWMP1254 | 149 | 1 | 38 | 12 | 15 | 0.47 |
| BWMP1260 | 174 | 1 | 44 | 12 | 17 | 0.53 |
| BWMP1266 | 200 | 1 | 50 | 12 | 20 | 0.61 |
| BWMP1272 | 225 | 1 | 56 | 12 | 22 | 0.66 |
| BWMP1278 | 240 | 1 | 62 | 12 | 25 | 0.71 |
| BWMP1284 | 260 | 1 | 68 | 12 | 27 | 0.79 |

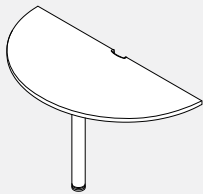
BWR • Radius Worksurface

- **Rounded worksurface for conferencing provides a radius corner.**
- 18" and 24" come with 1 BHML03 Monoleg and 30" comes with 2.
- Radius cut out on the straight edge allows space for aluminum trims.

- For chrome finish on leg, please add \$109 list upcharge for each leg.
- Please choose from DWT - Designer White, SIL - Silver or BLK - Black for scoop covers.
- Surfaces with wood trim (T) and complete wood (W) will not have the plastic scoop, they will remain with the curve cut scoop.
- To specify wood trim (T) or complete wood (W) surfaces, please remove the last "P" from the code and add either a "T" or "W" and the old scoop style is going to be created.

| PRODUCT CODE | PRICE LP* | GROUP | | | SIZE/INCHES | | | WEIGHT LBS | VOL FT ³ |
|--------------|-----------|-------|------|------|-------------|------|----|------------|---------------------|
| | | HP* | T* | W* | H | W | D | | |
| BWR18P | 503 | 578 | 819 | 1379 | 1 | 38.5 | 18 | 27 | 1.70 |
| BWR24P | 577 | 668 | 896 | 1631 | 1 | 50.5 | 24 | 41 | 2.20 |
| BWR30P | 969 | 1108 | 1339 | 2466 | 1 | 62.5 | 30 | 59 | 2.70 |

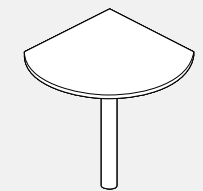
BWRTD • Teardrop Worksurface

- **Rounded worksurface for conferencing provides a radius corner from a worksurface to worksurface.**
- 1 BHML03 Monoleg included.
- For chrome finish on leg, please add \$109 list upcharge.

| PRODUCT CODE | PRICE LP* | GROUP | | | SIZE/INCHES | | | WEIGHT LBS | VOL FT ³ |
|--------------|-----------|-------|-----|------|-------------|----|----|------------|---------------------|
| | | HP* | T* | W* | H | W | D | | |
| BWRTD18 | 324 | 369 | 677 | 831 | 1 | 18 | 18 | 24 | 1.60 |
| BWRTD24 | 391 | 443 | 804 | 1004 | 1 | 24 | 24 | 33 | 1.90 |
| BWRTD30 | 469 | 569 | 973 | 1235 | 1 | 30 | 30 | 43 | 2.20 |

• LP = Thermally Fused Laminate, HP = High Pressure Laminate, T = High Pressure Laminate with Wood Trim, W = Wood Veneer

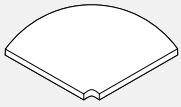
BWRP • Corner Radius Worksurface with Cutout

- **Corner Radius Worksurface with Cut-Out allows worksurface to be used around a post.**
- Cut out fits snug to the post, if trim is attached to the post, the worksurface or PVC trim may need to be cut on site to fit.

| PRODUCT CODE | PRICE LP* | GROUP | | | SIZE/INCHES | | | WEIGHT LBS | VOL FT ³ |
|--------------|-----------|-------|-----|-----|-------------|----|----|------------|---------------------|
| | | HP* | T* | W* | H | W | D | | |
| BWRP1818 | 162 | 202 | 400 | 554 | 1 | 21 | 21 | 12 | 0.40 |
| BWRP2424 | 235 | 293 | 533 | 815 | 1 | 27 | 27 | 19 | 0.64 |
| BWRP3030 | 289 | 364 | 666 | 919 | 1 | 33 | 33 | 29 | 1.00 |

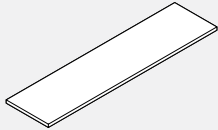
BWT • Transaction Worksurface

- **Attaches to the top of a 37" or 42" high panel to form a transaction worksurface.**
- To attach a Boulevard 1 37" high panel please specify BHBT37, all other heights specify BHBT02.
- To attach a Boulevard 1 panel with flat trim, please specify BHBT37FT or BHBT02FT.

| PRODUCT CODE | PRICE LP* | GROUP | | | SIZE/INCHES | | | WEIGHT LBS | VOL FT ³ |
|--------------|-----------|-------|-----|------|-------------|----|----|------------|---------------------|
| | | HP* | T* | W* | H | W | D | | |
| BWT1512 | 60 | 77 | 162 | 235 | 1 | 12 | 15 | 5 | 0.22 |
| BWT1518 | 74 | 102 | 202 | 269 | 1 | 18 | 15 | 7 | 0.30 |
| BWT1524 | 93 | 124 | 245 | 355 | 1 | 24 | 15 | 10 | 0.38 |
| BWT1530 | 112 | 146 | 287 | 422 | 1 | 30 | 15 | 12 | 0.46 |
| BWT1536 | 128 | 170 | 330 | 459 | 1 | 36 | 15 | 14 | 0.54 |
| BWT1542 | 146 | 194 | 380 | 532 | 1 | 42 | 15 | 17 | 0.62 |
| BWT1548 | 166 | 217 | 403 | 575 | 1 | 48 | 15 | 19 | 0.70 |
| BWT1554 | 178 | 239 | 455 | 601 | 1 | 54 | 15 | 22 | 0.78 |
| BWT1560 | 199 | 263 | 472 | 630 | 1 | 60 | 15 | 24 | 0.86 |
| BWT1566 | 213 | 284 | 515 | 692 | 1 | 66 | 15 | 28 | 0.94 |
| BWT1572 | 234 | 307 | 556 | 727 | 1 | 72 | 15 | 29 | 1.02 |
| BWT1578 | 249 | 333 | 600 | 938 | 1 | 78 | 15 | 31 | 1.10 |
| BWT1584 | 267 | 353 | 714 | 1021 | 1 | 84 | 15 | 34 | 1.18 |

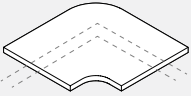
BWTC • Transaction Corner Worksurface

- **Attaches to the top of a 37" or 42" high panel to form a corner transaction worksurface.**
- Covers 12" of a panel.
- To attach a 37" high panel please specify BHBT37, all other heights specify BHBT02.
- To attach a Boulevard 1 panel with flat trim, please specify BHBT37FT or BHBT02FT.

| PRODUCT CODE | PRICE LP* | GROUP | | | SIZE/INCHES | | | WEIGHT LBS | VOL FT ³ |
|--------------|-----------|-------|-----|-----|-------------|------|------|------------|---------------------|
| | | HP* | T* | W* | H | W | D | | |
| BWTC90 | 159 | 199 | 332 | 714 | 1 | 20.7 | 20.7 | 11 | 0.49 |
| BWTC45 | 195 | 241 | 387 | 742 | 1 | 21.5 | 21.5 | 12 | 0.53 |
| BWTC60 | 204 | 241 | 387 | 742 | 1 | 22.5 | 22.5 | 14 | 0.60 |

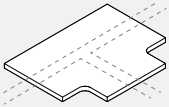
BWTT • Transaction "T" Worksurface

- **Attaches to the top of a 37" or 42" high panel to form a "T" corner transaction worksurface**
- Covers 12" of a panel.
- To attach a 37" high panel please specify BHBT37, all other heights specify BHBT02.

| PRODUCT CODE | PRICE LP* | GROUP | | | SIZE/INCHES | | | WEIGHT LBS | VOL FT ³ |
|--------------|-----------|-------|-----|-----|-------------|------|------|------------|---------------------|
| | | HP* | T* | W* | H | W | D | | |
| BWTT2721 | 171 | 212 | 349 | 893 | 1 | 21.5 | 26.5 | 15 | 0.6 |

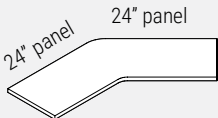
BWTAC • Transaction Worksurface for 45 Degree Corner Worksurface

- **Attaches to the top of 37" or 42" high panel to form a 45 degree corner transaction worksurface.**
- To attach a 37" high panel please specify BHBT37, all other heights specify BHBT02.

| PRODUCT CODE | PRICE LP* | GROUP | | | SIZE/INCHES | | | WEIGHT LBS | VOL FT ³ |
|--------------|-----------|-------|-----|------|-------------|----|----|------------|---------------------|
| | | HP* | T* | W* | H | W | D | | |
| BWTAC452415 | 707 | 885 | 948 | 1294 | 1 | 47 | 15 | 39 | 1.38 |

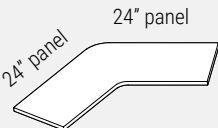
BWTAC • Transaction Worksurface for 60 Degree Corner Worksurface

- **Attaches to the top of 42" high panel to form a 60 degree corner transaction worksurface.**
- To attach a 37" high panel please specify BHBT37, all other heights specify BHBT02.

| PRODUCT CODE | PRICE LP* | GROUP | | | SIZE/INCHES | | | WEIGHT LBS | VOL FT ³ |
|--------------|-----------|-------|------|------|-------------|----|----|------------|---------------------|
| | | HP* | T* | W* | H | W | D | | |
| BWTAC602415 | 765 | 958 | 1010 | 1348 | 1 | 44 | 15 | 38 | 1.32 |

BWTD • Transaction “D” Worksurface

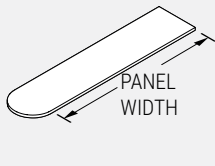

- Attaches to the top of a 37” or 42” high panel to form a transaction work surface with a radiused end.
- Surface overhangs the panel by 7 1/2” on one side.
- To attach a 37” high panel please specify BHBT37, all other heights specify BHBT02.

| PRODUCT CODE | PRICE LP* | GROUP HP* | T* | W* | SIZE/INCHES | | | WEIGHT LBS | VOL FT ³ |
|--------------|-----------|-----------|-----|------|-------------|------|----|------------|---------------------|
| | | | | | H | W | D | | |
| BWTD1530 | 145 | 190 | 365 | 590 | 1 | 37.5 | 15 | 17 | 0.65 |
| BWTD1536 | 153 | 204 | 386 | 626 | 1 | 43.5 | 15 | 19 | 0.69 |
| BWTD1542 | 171 | 229 | 427 | 691 | 1 | 49.5 | 15 | 22 | 0.74 |
| BWTD1548 | 192 | 251 | 448 | 748 | 1 | 55.5 | 15 | 25 | 0.77 |
| BWTD1554 | 207 | 274 | 465 | 775 | 1 | 61.5 | 15 | 27 | 0.85 |
| BWTD1560 | 229 | 303 | 478 | 796 | 1 | 67.5 | 15 | 30 | 0.94 |
| BWTD1566 | 245 | 323 | 548 | 913 | 1 | 73.5 | 15 | 33 | 1.02 |
| BWTD1572 | 265 | 351 | 615 | 1025 | 1 | 79.5 | 15 | 35 | 1.10 |

BWTDD • Transaction Double “D” Worksurface

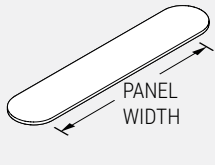

- Attaches to the top of a 37” or 42” high panel to form a transaction work surface with 2 radius ends.
- Surface overhangs the panel by 7 1/2” on each end.
- To attach a 37” high panel please specify BHBT37, all other heights specify BHBT02.

| PRODUCT CODE | PRICE LP* | GROUP HP* | T* | W* | SIZE/ INCHES | | | WEIGHT LBS | VOL FT ³ |
|--------------|-----------|-----------|-----|------|--------------|----|----|------------|---------------------|
| | | | | | H | W | D | | |
| BWTDD1548 | 213 | 284 | 548 | 913 | 1 | 63 | 15 | 28 | 1.00 |
| BWTDD1554 | 234 | 307 | 564 | 941 | 1 | 69 | 15 | 31 | 1.01 |
| BWTDD1560 | 249 | 333 | 579 | 965 | 1 | 75 | 15 | 33 | 1.04 |
| BWTDD1566 | 271 | 355 | 649 | 1077 | 1 | 81 | 15 | 35 | 1.13 |
| BWTDD1572 | 289 | 385 | 716 | 1192 | 1 | 87 | 15 | 38 | 1.21 |

BWTE • Elliptical Transaction Worksurface

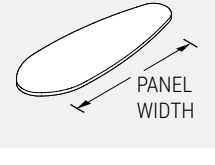

- Attaches to the top of a 37” or 42” high panel to form a transaction work surface.
- To attach a 37” high panel please specify BHBT37, all other heights specify BHBT02.
- Depth different than standard tops.

| PRODUCT CODE | PRICE LP* | GROUP HP* | T* | W* | SIZE/ INCHES | | | WEIGHT LBS | VOL FT ³ |
|--------------|-----------|-----------|------|------|--------------|----|----|------------|---------------------|
| | | | | | H | W | D | | |
| BWTE36 | 341 | 425 | 1060 | 1556 | 1 | 52 | 18 | 22 | 0.78 |
| BWTE42 | 389 | 485 | 1060 | 1556 | 1 | 58 | 19 | 24 | 0.81 |

BWTP • Oval Transaction Worksurface

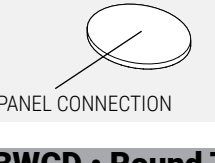

- Attaches to the top of a 37” or 42” high panel to form a transaction work surface.
- To attach a 37” high panel please specify BHBT37, all other heights specify BHBT02.
- Must be specified at post condition or panel joint.

| PRODUCT CODE | PRICE LP* | GROUP HP* | T* | W* | SIZE/ INCHES | | | WEIGHT LBS | VOL FT ³ |
|--------------|-----------|-----------|-----|-----|--------------|----|----|------------|---------------------|
| | | | | | H | W | D | | |
| BWTP1518 | 245 | 305 | 442 | 638 | 1 | 15 | 18 | 10 | 0.35 |

BWCD • Round Table



- Freestanding round meeting table with 4 prong tubular base.
- For chrome base please upcharge \$109 list.

| PRODUCT CODE | PRICE LP* | GROUP HP* | T* | W* | SIZE/ INCHES | | | WEIGHT LBS | VOL FT ³ |
|--------------|-----------|-----------|------|------|--------------|--------|--------|------------|---------------------|
| | | | | | H | W | D | | |
| BWCD30 | 505 | 557 | 885 | 1150 | 29 | 30 dia | 30 dia | 35 | 10.0 |
| BWCD36 | 573 | 641 | 1004 | 1321 | 29 | 36 dia | 36 dia | 42 | 10.0 |
| BWCD42 | 701 | 805 | 1326 | 1788 | 29 | 42 dia | 42 dia | 52 | 11.0 |

BWSQ • Square Table

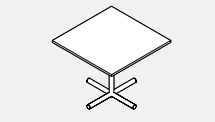

- Freestanding square meeting table with 4 prong tubular base.
- For chrome base please upcharge \$109 list.

| PRODUCT CODE | PRICE LP* | GROUP HP* | T* | W* | SIZE/ INCHES | | | WEIGHT LBS | VOL FT ³ |
|--------------|-----------|-----------|------|------|--------------|----|----|------------|---------------------|
| | | | | | H | W | D | | |
| BWSQ24 | 483 | 528 | 626 | 819 | 29 | 24 | 24 | 34 | 10.0 |
| BWSQ30 | 505 | 557 | 766 | 1079 | 29 | 30 | 30 | 38 | 10.0 |
| BWSQ36 | 573 | 641 | 893 | 1310 | 29 | 36 | 36 | 46 | 11.0 |
| BWSQ42 | 701 | 805 | 1026 | 1708 | 29 | 42 | 42 | 57 | 11.0 |

• LP = Thermally Fused Laminate, HP = High Pressure Laminate, T= High Pressure Laminate with Wood Trim, W= Wood Veneer

BHCL • "C" Leg

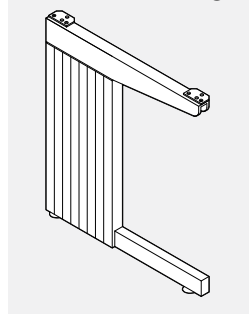

• **Attaches to panel support worksurface or to provide freestanding table support.**

- Steel structure, PVC cover.
- Universal non-handed.
- For a single rectangular freestanding worksurface application, specify two "C" Legs and one Modesty Panel of corresponding width.
- May be used as a shared leg between two adjoining worksurfaces. Specify one "C" Leg, one Modesty Panel of corresponding width, plus one Modesty Panel Extension Bracket.
- For corner worksurfaces, specify two "C" Legs, one Corner Leg and two Modesty Panels 6" shorter than rear sides of the corner worksurface.
- Can be used as a floor support in a panel attached application (similar to a cantilever).
- Includes worksurface mounting brackets with screws, Bracket Retainer Clip and panel bracket.
- Accommodates 15" knee space.
- Intended for use with flexlip worksurfaces. When used on other worksurfaces, modesty panel must be installed upside down.

| PRODUCT CODE | PRICE | SIZE/ INCHES | | | WEIGHT VOL | |
|--------------|-------|--------------|---|----|------------|-----------------|
| | | H | W | D | LBS | FT ³ |
| BHCL2618 | 227 | 25 | 1 | 18 | 7 | 0.27 |
| BHCL2624 | 235 | 25 | 1 | 24 | 8 | 0.36 |
| BHCL2918 | 245 | 28 | 1 | 18 | 8 | 0.30 |
| BHCL2924 | 253 | 28 | 1 | 24 | 9 | 0.40 |

BKC • Corner Leg

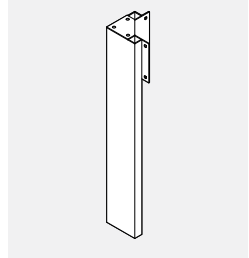

• **Five sided worksurface support.**

- Steel construction.
- Non handed.
- Includes bolts for modesty panel attachment.
- For corner worksurfaces, specify two "C" Legs, one Corner Leg and two Modesty Panels 6" shorter than rear sides of the corner worksurface.

| PRODUCT CODE | PRICE | SIZE/ INCHES | | | WEIGHT VOL | |
|--------------|-------|--------------|---|---|------------|-----------------|
| | | H | W | D | LBS | FT ³ |
| BKC26 | 144 | 25 | 7 | 7 | 3.0 | 0.02 |
| BKC29 | 162 | 28 | 7 | 7 | 3.2 | 0.02 |

BKMP • Modesty Panel

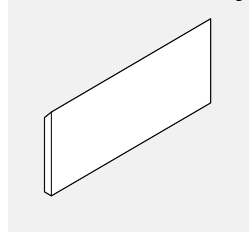

• **For rectangular worksurfaces, specify Modesty Panel of corresponding width. For corner worksurfaces, specify two Modesty Panels 6" shorter than rear side of corner worksurface.**

- Attaches between two "C" Legs, or between one "C" Leg and a Corner Leg, or a shared "C" Leg and "C" Leg at the end of a run.
- Includes brackets and screws to attach Modesty Panel to worksurface.
- For use with flex lip worksurfaces only.
- To install on "SCP" or "NFL" worksurface, modesty panel must be inverted.

| PRODUCT CODE | PRICE | SIZE/ INCHES | | | WEIGHT VOL | |
|--------------|-------|--------------|----|------|------------|-----------------|
| | | H | W | D | LBS | FT ³ |
| BKMP1224 | 170 | 11 | 24 | 0.25 | 2.75 | 0.17 |
| BKMP1230 | 179 | 11 | 30 | 0.25 | 2.75 | 0.21 |
| BKMP1236 | 194 | 11 | 36 | 0.25 | 3.00 | 0.25 |
| BKMP1242 | 201 | 11 | 42 | 0.25 | 4.00 | 0.29 |
| BKMP1248 | 212 | 11 | 48 | 0.25 | 4.50 | 0.33 |
| BKMP1254 | 221 | 11 | 54 | 0.25 | 5.00 | 0.38 |
| BKMP1260 | 235 | 11 | 60 | 0.25 | 5.50 | 0.42 |

BHMEB • Modesty Panel Extension Bracket

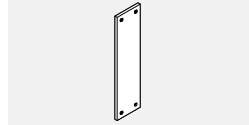

• **Modesty Panel Extension Bracket made of cold rolled steel.**

- Attaches the Modesty Panel of an adjoining worksurface to a shared "C" Leg.
- Includes all attachment hardware.

| PRODUCT CODE | PRICE | SIZE/ INCHES | | | WEIGHT VOL | |
|--------------|-------|--------------|-----|-------|------------|-----------------|
| | | H | W | D | LBS | FT ³ |
| BHMEB01 | 23 | 10 | 1.5 | 0.125 | 0.5 | 0.01 |

BHFG • Full Gable - Self Edged

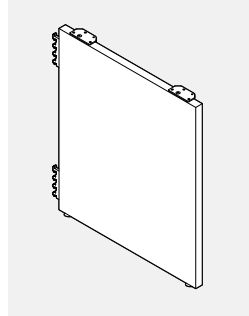

• **Provides floor standing support while enclosing an end of a run of worksurfaces.**

- Includes attachment hardware, Bracket Retainer Clip and levelling glides.
- Non-handed.
- May be used as a shared gable between two adjoining worksurfaces.

| PRODUCT CODE | PRICE LP* | GROUP HP* | SIZE/ INCHES | | | WEIGHT VOL | |
|--------------|-----------|-----------|--------------|---|----|------------|-----------------|
| | | | H | W | D | LBS | FT ³ |
| BHFG2608 | 156 | 192 | 25 | 1 | 8 | 7 | 0.14 |
| BHFG2612 | 187 | 234 | 25 | 1 | 12 | 13 | 0.21 |
| BHFG2618 | 229 | 284 | 25 | 1 | 18 | 13 | 0.27 |
| BHFG2624 | 251 | 313 | 25 | 1 | 24 | 19 | 0.36 |
| BHFG2630 | 339 | 420 | 25 | 1 | 30 | 23 | 0.45 |
| BHFG2636 | 422 | 528 | 25 | 1 | 36 | 24 | 0.57 |
| BHFG2908 | 156 | 192 | 28 | 1 | 8 | 7 | 0.16 |
| BHFG2912 | 187 | 234 | 28 | 1 | 12 | 14 | 0.30 |
| BHFG2918 | 229 | 284 | 28 | 1 | 18 | 14 | 0.30 |
| BHFG2924 | 251 | 313 | 28 | 1 | 24 | 17 | 0.40 |
| BHFG2930 | 339 | 420 | 28 | 1 | 30 | 21 | 0.50 |
| BHFG2936 | 422 | 528 | 28 | 1 | 36 | 26 | 0.65 |

• LP = Thermally Fused Laminate, HP = High Pressure Laminate, T= High Pressure Laminate with Wood Trim, W= Wood Veneer

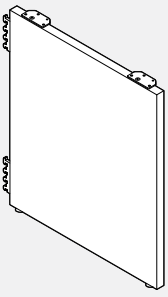
BHFGP • Full Gable - 3mm PVC Edged

- Provides floor standing support while enclosing an end of a run of worksurfaces.
- Includes attachment hardware, Bracket Retainer Clip and levelling glides.
- Provides consistent edging matching the worksurface trim.
- Handed once installed.
- May be used as a shared gable between two adjoining worksurfaces.

| PRODUCT CODE | PRICE LP* | GROUP HP* | SIZE/ INCHES | | | WEIGHT VOL | |
|--------------|-----------|-----------|--------------|---|----|------------|-----------------|
| | | | H | W | D | LBS | FT ³ |
| BHFGP2608 | 146 | 182 | 25 | 1 | 8 | 7 | 0.14 |
| BHFGP2612 | 187 | 234 | 25 | 1 | 12 | 13 | 0.21 |
| BHFGP2618 | 229 | 284 | 25 | 1 | 18 | 13 | 0.27 |
| BHFGP2624 | 251 | 313 | 25 | 1 | 24 | 19 | 0.36 |
| BHFGP2630 | 339 | 420 | 25 | 1 | 30 | 23 | 0.45 |
| BHFGP2636 | 422 | 528 | 25 | 1 | 36 | 24 | 0.57 |
| BHFGP2908 | 146 | 182 | 28 | 1 | 8 | 7 | 0.16 |
| BHFGP2912 | 187 | 234 | 28 | 1 | 12 | 14 | 0.30 |
| BHFGP2918 | 229 | 284 | 28 | 1 | 18 | 14 | 0.30 |
| BHFGP2924 | 251 | 313 | 28 | 1 | 24 | 17 | 0.40 |
| BHFGP2930 | 339 | 420 | 28 | 1 | 30 | 21 | 0.50 |
| BHFGP2936 | 422 | 528 | 28 | 1 | 36 | 26 | 0.65 |

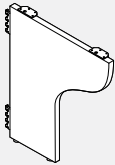
BHPG • "P" Shaped Full Gable - 3mm PVC Edged

- Provides floor standing support while enclosing an end of a run of worksurfaces.
- Includes attachment hardware, Bracket Retainer Clip and levelling glides.
- Handed due to hardware attachment and PVC edge.

| PRODUCT CODE | PRICE LP* | GROUP HP* | SIZE/ INCHES | | | WEIGHT VOL | |
|--------------|-----------|-----------|--------------|---|----|------------|-----------------|
| | | | H | W | D | LBS | FT ³ |
| BHPG2624L | 251 | 313 | 25 | 1 | 24 | 19 | 0.36 |
| BHPG2924L | 251 | 313 | 28 | 1 | 24 | 17 | 0.40 |
| BHPG2624R | 251 | 313 | 25 | 1 | 24 | 19 | 0.36 |
| BHPG2924R | 251 | 313 | 28 | 1 | 24 | 17 | 0.40 |

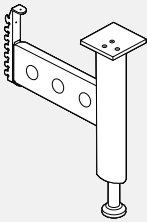
BHLEG • Gable Leg

- Support the worksurface and enhances the stability of connected panels.
- Universal leg plate bolts to the underside of the worksurface.
- Can be configured on-site for left, right or shared worksurface support application on front edge
- Back edge does not have shared support.
- Tubular leg section adjusts in 1" increments, the leveller can be used for fine adjustment.
- 1" increment leg adjustment and 1" increment panel slots allow the leg of installed worksurface to be supported from 26" to 32". (Leg must be removed from panel to manually adjust.)
- Side plate is secured to the slots in the vertical of the Boulevard 1 or System 3 panels and the leg plate bolts to underside of the worksurface.
- Made of extruded aluminum and steel.
- Includes all mounting hardware to connect to panel and worksurface.

| PRODUCT CODE | PRICE | GROUP | SIZE/ INCHES | | | WEIGHT VOL | |
|--------------|-------|-------|--------------|---|----|------------|-----------------|
| | | | H | W | D | LBS | FT ³ |
| BHLEG | 211 | | 28 | 6 | 23 | 8 | 0.15 |

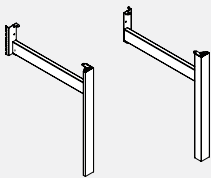
BRTBLEG • Boulevard Leg Assembly

- Boulevard Leg Assembly attaches to a Boulevard panel for applications which require functionality of Boulevard panels with an open environment of Bridges tables.
- One leg with horizontal member connecting to 1" increment slots in panel's vertical frame member. Provides support to panel and panel-connected worksurface at the end of a run; design coordinated with Bridges freestanding tables.
- Supports 24" and 30" deep worksurfaces. By adding 2 BHBF01 flat brackets and 1 BHBC02 corner bracket, a single leg can then support the adjoining worksurface. Leveling glide is standard. No worksurface supporting beams, use panel cantilevers and storage for worksurface support. One aluminum leg with steel structure - specify Left or Right and 24" or 30" deep for corresponding worksurface depths. Panel bracket, dislodgment clip and worksurface hardware included.
- Anodized aluminum leg upcharge \$31.
- Please specify paint finish for support.

| PRODUCT CODE | PRICE | GROUP | SIZE/ INCHES | | | WEIGHT VOL | |
|--------------|-------|-------|--------------|-----|----|------------|-----------------|
| | | | H | W | D | LBS | FT ³ |
| BRTBLEG24LL | 317 | | 28 | 2.5 | 24 | 9 | 1.25 |
| BRTBLEG24RL | 317 | | 28 | 2.5 | 24 | 9 | 1.25 |
| BRTBLEG30LL | 333 | | 28 | 2.5 | 30 | 11 | 1.45 |
| BRTBLEG30RL | 333 | | 28 | 2.5 | 30 | 11 | 1.45 |

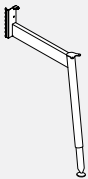
BRTBL • Boulevard Leg Assembly

- Boulevard Leg Assembly attaches to a Boulevard panel for applications which require functionality of Boulevard panels with an open environment of Bridge 2 tables.
- Panel bracket secures the leg to the panel in 1" increments, within a 24" to 32" height range.
- Panel mounting bracket is reversible for non-handed applications.
- Supports 24" and 30" deep worksurfaces. By adding 2 BHBF01 flat brackets and 1 BHBC02 corner bracket, a single leg can then support the adjoining worksurface. Leveling glide is standard. No worksurface supporting beams, use panel cantilevers and storage for worksurface support. Panel bracket, dislodgment clip and worksurface hardware included.
- Leveling glide is standard.

| PRODUCT CODE | PRICE | GROUP | SIZE/ INCHES | | | WEIGHT VOL | |
|--------------|-------|-------|--------------|---|----|------------|-----------------|
| | | | H | W | D | LBS | FT ³ |
| BRTBL | 338 | | 28 | 3 | 24 | 12 | 1.25 |

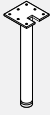
BHML • Monoleg

- **3" diameter Monoleg provides support for worksurfaces.**
- Top plate welded to leg.
- 8" x 8" plated attached to worksurface with #10 3/4" wood screws, included.
- 1" height adjustment range.
- For chrome finish on leg, please add \$109 list upcharge.

| PRODUCT CODE | PRICE | SIZE/ INCHES | | | WEIGHT VOL | |
|--------------|-------|--------------|---|---|------------|-----------------|
| | | H | W | D | LBS | FT ³ |
| BHML03 | 207 | 28 | 3 | 3 | 8 | 0.15 |

LATBL • Tapered Leg

- **Tapered leg provides support for worksurfaces.**
- Top plate welded to leg.
- 8" x 8" plated attached to worksurface with #10 3/4" wood screws, included.
- 1" height adjustment range.
- For chrome finish on leg, please add \$109 list upcharge.

| PRODUCT CODE | PRICE | SIZE/ INCHES | | | WEIGHT VOL | |
|--------------|-------|--------------|---|---|------------|-----------------|
| | | H | W | D | LBS | FT ³ |
| LATBL28 | 195 | 28 | 3 | 3 | 8 | 0.15 |

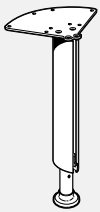
VVLEGLV • Leg with Leveler

- **The Viceversa leg features a push button height adjustment mechanism. This mechanism allows the user to easily set the height of a table. The universal mounting plate can be used to gang 2 tables without metal skirt simply by rotating 45 degrees to span both tops.**
- The Viceversa Leg has a wire management channel that neatly organizes electrical and communication cables running from the worksurface to the floor.
- Legs have a height range of 25" to 32" in 1" increments (includes 1" top).
- The wire channel is covered by a clear PVC snap-on cover.
- Levelers have a 1/2" height range.
- Levelers come in charcoal only.
- Includes mounting hardware.

| PRODUCT CODE | PRICE | SIZE/ INCHES | | | WEIGHT VOL | |
|--------------|-------|--------------|---|----|------------|-----------------|
| | | H | D | W | LBS | FT ³ |
| VVLEGLV | 182 | 25-32 | 8 | 10 | 8 | 1.5 |

VVLEGLC • Leg with Caster

- **The Viceversa leg features a push button height adjustment mechanism. This mechanism allows the user to easily set the height of a table. The universal mounting plate can be used to gang 2 tables without metal skirt simply by rotating 45 degrees to span both tops.**
- The Viceversa Leg has a wire management channel that neatly organizes electrical and communication cables running from the worksurface to the floor.
- Legs have a height range of 26" to 33" in 1" increments.
- The wire channel is covered by a clear PVC snap-on cover.
- Casters come in grey with black only.
- Includes mounting hardware.

| PRODUCT CODE | PRICE | SIZE/ INCHES | | | WEIGHT VOL | |
|--------------|-------|--------------|---|----|------------|-----------------|
| | | H | D | W | LBS | FT ³ |
| VVLEGLC | 182 | 26-33 | 8 | 10 | 8 | 1.5 |

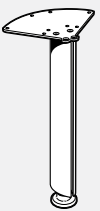
VVLEGF • Fixed Height Leg

- **The Viceversa fixed height leg with leveler supports the worksurface at a fixed height of 29".**
- The Viceversa leg has a wire management channel that neatly organizes electrical and communication cables running from the worksurface to the floor.
- Leg can be installed for each corner of the worksurface or can be shared at adjoining surfaces.
- The wire channel is covered by a clear PVC snap-on cover.
- Levelers have a 1/2" height range.
- Levelers come in charcoal only.
- Includes mounting hardware.

| PRODUCT CODE | PRICE | SIZE/ INCHES | | | WEIGHT VOL | |
|--------------|-------|--------------|---|----|------------|-----------------|
| | | H | D | W | LBS | FT ³ |
| VVLEGF | 145 | 28 | 8 | 10 | 8 | 1.5 |

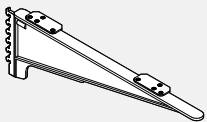
BHC • Cantilever

- **Universal cantilever with steel attachment bracket constructed of cast aluminum to provide support for worksurfaces.**
- Attaches a worksurface to a panel.
- May be used for shared worksurface support.
- Interchangeable in the field for left or right positioning.
- Includes Bracket Retainer Clip.

| PRODUCT CODE | PRICE | SIZE/ INCHES | | | WEIGHT VOL | |
|--------------|-------|--------------|----|-----|------------|-----------------|
| | | H | W | D | LBS | FT ³ |
| BHC18 | 104 | 7 | 17 | 2.5 | 17 | 0.04 |
| BHC24 | 122 | 7 | 23 | 2.5 | 23 | 0.05 |

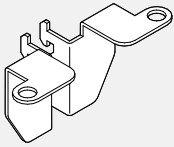
BHBC • Corner End Bracket

- Formed steel bracket for a corner worksurface or a straight worksurface.
- Attaches a corner of any worksurface to a panel through the panel vertical slots.
- Priced one left and one right per package.
- Includes Bracket Retainer Clip.

| PRODUCT CODE | PRICE | SIZE/ INCHES | | | WEIGHT VOL | |
|--------------|-------|--------------|-----|-----|------------|-----------------|
| | | H | W | D | LBS | FT ³ |
| BHBC02 | 26 | 3.3 | 1.5 | 2.3 | 2 | 0.007 |

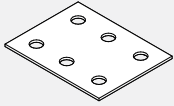
BHBF • Flat Bracket

- Flat Bracket made of cold rolled steel.
- May be used to ensure alignment of neighboring worksurfaces.

| PRODUCT CODE | PRICE | SIZE/ INCHES | | | WEIGHT VOL | |
|--------------|-------|--------------|---|---|------------|-----------------|
| | | H | W | D | LBS | FT ³ |
| BHBF01 | 13 | 0.1 | 3 | 4 | 0.5 | 0.007 |

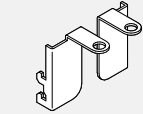
BHBT • Transaction Bracket

- For use on 34", 42", 50", 58", 66", 74" and 82" high Boulevard panels.
- Transaction Bracket made of cold rolled steel.
- To provide a secure attachment of a transaction worksurface.
- Priced one left and one right per package.
- Includes Bracket Retainer Clip.

| PRODUCT CODE | PRICE | SIZE/ INCHES | | | WEIGHT VOL | |
|--------------|-------|--------------|-----|-----|------------|-----------------|
| | | H | W | D | LBS | FT ³ |
| BHBT02 | 26 | 3.3 | 1.5 | 2.3 | 2 | 0.001 |

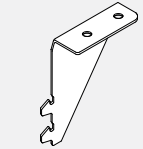
BHBT • Transaction Bracket for 37" High Boulevard 1 Panels

- Transaction Bracket made of cold rolled steel.
- To provide a secure attachment of a transaction worksurface for a 37" high Boulevard 1 panel only. Transaction Bracket engages with the top slots in the 37" high panel to supported for the transaction worksurface.
- Priced one left and one right per package.
- Includes Bracket Retainer Clip.

| PRODUCT CODE | PRICE | SIZE/ INCHES | | | WEIGHT VOL | |
|--------------|-------|--------------|---|---|------------|-----------------|
| | | H | W | D | LBS | FT ³ |
| BHBT37 | 31 | 4 | 1 | 3 | 0.5 | 0.007 |

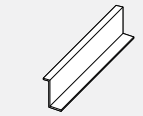
BHBZ • "Z" Bracket

- Attaches two different heights of worksurfaces.
- To be used in conjunction with a cantilever.

| PRODUCT CODE | PRICE | SIZE/ INCHES | | | WEIGHT VOL | |
|--------------|-------|--------------|----|---|------------|-----------------|
| | | H | W | D | LBS | FT ³ |
| BHBZ03 | 81 | 4 | 21 | 4 | 2 | 0.190 |

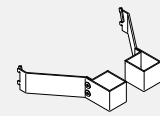
FTATB • Boulevard Connector Kit

- FreeFit to Boulevard kit secures FreeFit height adjustable freestanding tables to parallel Boulevard panels.
- It provides panel/table alignment, preventing moving parts from rubbing against panel vertical surfaces and maintains 1" clearance around table surface perimeter.
- Standard metal finishes.
- All hardware included.
- Sold as a pair.

| PRODUCT CODE | PRICE | SIZE/ INCHES | | | WEIGHT VOL | |
|--------------|-------|--------------|-----|----|------------|-----------------|
| | | H | W | D | LBS | FT ³ |
| FTATB | 144 | 10 | 6.5 | 10 | 7.00 | 0.50 |

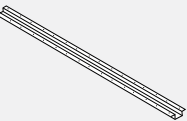
LHC • HAT Channel

| PRODUCT CODE | PRICE | SIZE/ INCHES | | | WEIGHT VOL | |
|--------------|-------|--------------|----|---|------------|-----------------|
| | | H | W | D | LBS | FT ³ |
| LHC40 | 58 | 1.4 | 40 | 5 | 4 | 0.20 |
| LHC46 | 64 | 1.4 | 46 | 5 | 6 | 0.22 |
| LHC52 | 68 | 1.4 | 52 | 5 | 7 | 0.25 |
| LHC58 | 78 | 1.4 | 58 | 5 | 8 | 0.28 |
| LHC64 | 88 | 1.4 | 64 | 5 | 9 | 0.31 |
| LHC70 | 94 | 1.4 | 70 | 5 | 10 | 0.33 |

Technical Information for 9300 Series Pedestals

General Information:

9300 Series Pedestals feature center pull handles (models ending in "C") and full pull handles (models ending in "P"). Freestanding, mobile, and worksurface supporting options available. Quality steel construction. File drawers hold letter or A4 front to back and legal side to side configurations. Products are finished in a highly durable dry epoxy powder coating and drawer body interiors are finished with 100% recycled paint. Counterweights are included in freestanding and mobile pedestals to meet applicable ANSI/BIFMA X5.9.

Features:

- Cold rolled steel construction consisting of 16 ga front and back base with 22 ga case
- Reinforced welded construction
- Inset drawer fronts and flush base
- Double wall construction on all drawer fronts
- Full extension ball bearing slides on file drawers and $\frac{3}{4}$ extension on box drawers
- Rubber bumpers on slides for quietness
- Worksurface supporting option available (includes mounting holes at top of unit)
- 1 pencil tray and 1 drawer divider are included with each unit containing a box drawer
- Each file drawer includes a hanging file bar
- Levelers provide 1" height adjustment
- Counterweights included for freestanding and mobile pedestals
- Includes lock with 2 keys
- Lock is located at the top right of the case above the top drawer
- Keyed alike option available and can be keyed alike to other storage components

Technical Information for Prime Series

General Information:

Prime premium filing and storage products pre-configured to suit your needs; featuring fixed front or receding doors with center pull handles and fully welded seamless tops to deliver strength and clean aesthetics. Premium quality steel construction. File drawers accommodate legal, letter or A4 sizes in back-to-front and side-to-side configurations. Products are finished in a highly durable dry epoxy powder coating and drawer body interiors are finished with 100% recycled paint.

Counterweights are recommended for use in all laterals, pedestals and freestanding files of all widths and heights to meet applicable ANSI/BIFMA X5.9. (Counterweights are offered as an option on all products where required to meet applicable ANSI/BIFMA standard)

Features

- Premium steel construction, 18-22 gauge steel components
- Full welded and reinforced case construction
- Interlock system allows only one drawer to open at a time for safety
- Most products feature full overlay fronts, with some exceptions such as units with receding doors where the front is inset in the case
- Double wall construction on all drawer and door fronts
- Full extension roller bearing glides on all drawers
- Anti-bounce-back safety feature prevents drawers from sliding open
- Receding doors slide into the cabinet and allow the shelf to be pulled out
- All pedestals are equipped with four levelling glides, providing 1.5" of height adjustment
- All other units equipped with four levelling glides providing 1" height adjustment and can be accessed from the interior of the cabinets for ease of adjustment
- On units with drawers and hinged doors, locks are located at the center of the case above the top opening
- Lock position on towers with wardrobes is below the handle when center pull is selected
- Each lock includes 2 keys; locks are standard with removable cores
- Key assignment is random or can be specified for specific key number for key alike applications

Overhead Storage:

- Overhead cabinets - 7 widths in 6" increments
- 14 5/8" high cases with interior clear height of 12"
- 13" deep units have interior clear dimension of 12.7"
- 16" deep units have interior clear dimension of 15.7"
- Open shelves - 7 widths in 6" increments
- Shelves are 12 1/2" deep with 7 1/2" high side gables

Sizes:

- 15" width
- 19", 23", 29" depths
- Interior drawer depths:

19" Deep pedestals
17 1/4" deep box drawers
16 1/16" deep file drawers

23" deep pedestals
20 3/16" deep box drawers
19 7/16" deep file drawers

29" deep pedestals
26 5/16" deep box drawers
26 1/16" deep file drawers

Drawer Heights:

Box drawer fronts are 6"H with 5" interior height
File drawer fronts are 12"H with 10 9/16" interior height

Pedestals:

- Freestanding and worksurface supporting options available
- Worksurface supporting includes mounting holes at top of unit
- 1 pencil tray and 1 drawer divider are included with each unit containing a box drawer
- File drawers hold legal, letter or A4 sizes in back-to-front and side-to-side configurations
- Each file drawer includes a hanging file bar and conversion rails
- Freestanding units BSPF can be specified with optional non-locking casters to convert to a mobile unit
- 15" width x 18", 22", 28" depths

Interior drawer depth is as follows:

- 15" deep drawers for 18" deep pedestals
- 19" deep drawers for 22" deep pedestals
- 25" deep drawers for 28" deep pedestals

File drawer capacity:

- 14 3/8" filing capacity for file drawers in 18" pedestal
- 18 3/8" filing capacity for file drawers in 22" pedestal
- 24 3/8" filing capacity for file drawers in 28" pedestal

Laterals:

- 18" depth with interior depth of 16"
- 30", 36", 42" widths
- Available in 2 to 6 drawer high (28"h - 77.6"h)

File Drawer Capacity:

- 30" wide units
- Letter & legal side-to-side = 26 5/8"
 - Letter front-to-back = 30 1/2"
 - Legal front-to-back = 15 1/4" + 10" side space
- 36" wide units
- Letter & legal side-to-side = 32 5/8"
 - Letter front-to-back = 30 1/2" + 6 1/2" side space
 - Legal front-to-back = 30 1/2"
- 42" wide units
- Letter & legal side-to-side = 58 5/8"
 - Letter front-to-back = 45 3/4"
 - Legal front-to-back = 30 1/2" + 6 1/2" side space

Technical Information for Prime Series

Storage Cabinets:

- 18" depth
- 30", 36", 42" widths
- Available in 2 to 5 high configurations (28"h – 65.6"h)

Towers:

- Include coat rod and shelf to accommodate personal items
- The top of the storage compartment is perforated for ventilation

- Includes locks with 2 keys each
 - Closed storage comes with 3 locks – one of the drawers, one for the cupboard, and one for the wardrobe
 - Side open storage comes with 2 locks – one of the drawers and one for the wardrobe
- 24" width
- 50", 54", and 66" nominal heights available to coordinate with Global's panel systems

STORAGE COMPONENTS - GUIDELINES FOR ORDERING PRODUCT

Codes

The price list uses a numbering system with meaningful alphanumeric characters to create a simple-to-understand product number. This makes specifying the product much easier and more accurate.

How to Specify

- Specify storage pedestal type and size by code, including depth.
- Specify metal color (eg. BLK for Black)
- Specify key random, key list provided, or key number (eg. 401)
- Specify worksurface supporting (1 = Yes, 2 = No)
- Specify counterweight if pedestal is not worksurface supporting (NN = No Counterweight)

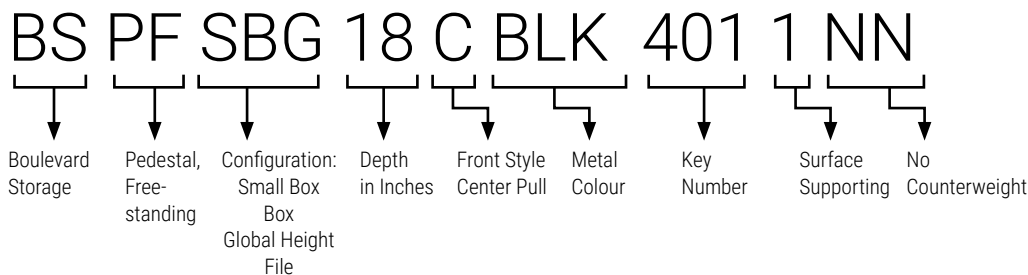

BSKSS • Panel Mount Shelf

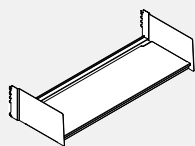

- 14" deep panel mounted storage shelf with backlip.
- Mounting brackets are included.

| PRODUCT CODE | PRICE | SIZE/INCHES | | | WEIGHT LBS | VOL FT ³ |
|--------------|-------|-------------|-------|-------|------------|---------------------|
| | | H | W | D | | |
| BSKSS24 | 220 | 7.45 | 23.44 | 14.73 | 12.8 | 1.5 |
| BSKSS30 | 229 | 7.45 | 29.44 | 14.73 | 14.8 | 1.9 |
| BSKSS36 | 244 | 7.45 | 35.44 | 14.73 | 16.8 | 2.3 |
| BSKSS42 | 254 | 7.45 | 41.44 | 14.73 | 18.8 | 2.6 |
| BSKSS48 | 259 | 7.45 | 47.44 | 14.73 | 20.8 | 3.0 |
| BSKSS54 | 293 | 7.45 | 53.44 | 14.73 | 22.8 | 3.4 |
| BSKSS60 | 322 | 7.45 | 59.44 | 14.73 | 24.8 | 3.8 |

BSLSF • Flush Front Overhead Cabinet

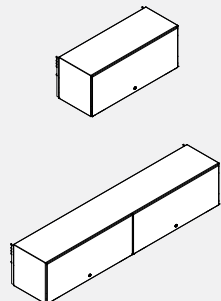

- Flush Front Overhead Cabinet is panel mounted lockable storage unit.
- The door retracts inside/within the overhead cabinet.
- Locks can be keyed alike to match other lockable storage components or keyed random to provide a dedicated lock.
- Available in 13" and 16" depths, 24" to 60" widths at 6" increments.
- Cabinets 54" and 60" wide come with two doors.
- Includes mounting hardware as specified, lock and keys.
- Lock secures into bottom shelf.
- Can be mounted at any height, however 66"h panels are recommended.
- Shipped assembled.

Cabinets 54" and 60" wide come with two doors

| PRODUCT CODE | PRICE | SIZE/INCHES | | | WEIGHT LBS | VOL FT ³ |
|--------------|-------|-------------|-------|------|------------|---------------------|
| | | H | W | D | | |
| BSLSF1324MN | 869 | 14.62 | 23.87 | 13.5 | 39.3 | 2.7 |
| BSLSF1330MN | 947 | 14.62 | 29.87 | 13.5 | 44.3 | 3.4 |
| BSLSF1336MN | 1044 | 14.62 | 35.87 | 13.5 | 49.3 | 4.1 |
| BSLSF1342MN | 1147 | 14.62 | 41.87 | 13.5 | 54.3 | 4.8 |
| BSLSF1348MN | 1244 | 14.62 | 47.87 | 13.5 | 59.3 | 5.5 |
| BSLSF1354MN | 1324 | 14.62 | 53.87 | 13.5 | 64.3 | 6.2 |
| BSLSF1360MN | 1449 | 14.62 | 59.87 | 13.5 | 69.3 | 6.8 |
| BSLSF1624MN | 966 | 14.62 | 23.87 | 16.5 | 38.6 | 3.4 |
| BSLSF1630MN | 1044 | 14.62 | 29.87 | 16.5 | 43.9 | 4.2 |
| BSLSF1636MN | 1147 | 14.62 | 35.87 | 16.5 | 49.2 | 5.0 |
| BSLSF1642MN | 1244 | 14.62 | 41.87 | 16.5 | 54.5 | 5.8 |
| BSLSF1648MN | 1342 | 14.62 | 47.87 | 16.5 | 59.8 | 6.7 |
| BSLSF1654MN | 1449 | 14.62 | 53.87 | 16.5 | 65.1 | 7.5 |
| BSLSF1660MN | 1547 | 14.62 | 59.87 | 16.5 | 70.4 | 8.4 |

BSADA-PM • Panel Mounted Overhead Storage Unit - AODA Compliant

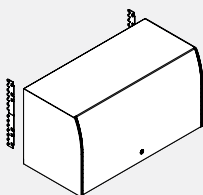

- Panel mounted metal overhead storage with opaque acrylic door. The mechanism lifts the door up and stores it out of the way, above the storage unit.
- Meets CSA B651 Barrier Free Design & AODA (Accessibility for Ontarians with Disabilities Act).
- 16" high units accept standard and A4 binders.
- All shelves are reinforced for proper weight distribution.
- Inside dimensions: 14.25" high x 13.4" deep.
- Unit includes attachment hardware, lock and mounting brackets. Back not included.
- Not recommended for use with wall rails.
- Unit can be converted to Up-Mount Overhead Storage Unit in the field by adding BSADAxKIT.
- Shipped partially assembled.

| PRODUCT CODE | PRICE | SIZE/INCHES | | | WEIGHT LBS | VOL FT ³ |
|--------------|-------|-------------|----|------|------------|---------------------|
| | | H | W | D | | |
| BSADA24PM | 780 | 16 | 24 | 14.2 | 22 | 4.3 |
| BSADA30PM | 839 | 16 | 30 | 14.2 | 27 | 5.3 |
| BSADA36PM | 906 | 16 | 36 | 14.2 | 32 | 6.3 |
| BSADA42PM | 970 | 16 | 42 | 14.2 | 37 | 7.3 |
| BSADA48PM | 1037 | 16 | 48 | 14.2 | 42 | 8.3 |
| BSADA54PM | 1101 | 16 | 54 | 14.2 | 47 | 9.3 |
| BSADA60PM | 1167 | 16 | 60 | 14.2 | 53 | 10.3 |

BSADA-UM • Up-Mount Overhead Storage Unit - AODA Compliant

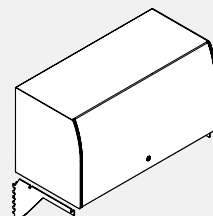

- Up mounted storage can reduce furniture costs by reducing the height of all panels to 50". Complete 50" panel installations simplify cable routing at one level, within the top lay-in channel. Up-mounted cantilevers maintain accessibility and functionality of the panels' top lay-in channel.
- Meets CSA B651 Barrier Free Design & AODA (Accessibility for Ontarians with Disabilities Act).
- 16" high units accept standard and A4 binders.
- All shelves are reinforced for proper weight distribution.
- Inside dimensions: 14.25" high x 13.4" deep.
- Unit includes attachment hardware, lock, mounting cantilevers and has a finished back.
- Unit can be converted to a Panel Mounted Overhead Storage Unit in the field by adding BSADAPMxxKIT.
- Shipped partially assembled.

| PRODUCT CODE | PRICE | SIZE/INCHES | | | WEIGHT LBS | VOL FT ³ |
|--------------|-------|-------------|----|------|------------|---------------------|
| | | H | W | D | | |
| BSADA24UM | 956 | 16 | 24 | 14.2 | 25 | 4.3 |
| BSADA30UM | 999 | 16 | 30 | 14.2 | 33 | 5.3 |
| BSADA36UM | 1046 | 16 | 36 | 14.2 | 40 | 6.3 |
| BSADA42UM | 1105 | 16 | 42 | 14.2 | 46 | 7.3 |
| BSADA48UM | 1166 | 16 | 48 | 14.2 | 53 | 8.3 |
| BSADA54UM | 1222 | 16 | 54 | 14.2 | 59 | 9.3 |
| BSADA60UM | 1293 | 16 | 60 | 14.2 | 66 | 10.3 |

BSADA-KIT • Up-Mount Conversion Kit

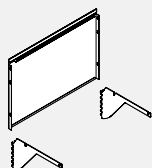

- Converts an existing Panel Mounted Overhead Storage Unit BSADA-PM to an Up-Mounted Overhead Storage unit BSADA-UM.
- When used on a 50" high panel, the top of the overhead will match the height of 66" high panels.
- Kit includes a back panel for the Overhead and Up-Mount Cantilevers.

| PRODUCT CODE | PRICE | SIZE/INCHES | | | WEIGHT LBS | VOL FT ³ |
|--------------|-------|-------------|----|---|------------|---------------------|
| | | H | W | D | | |
| BSADA24KIT | 194 | 16 | 24 | 2 | 6 | 0.6 |
| BSADA30KIT | 201 | 16 | 30 | 2 | 8 | 0.6 |
| BSADA36KIT | 210 | 16 | 36 | 2 | 10 | 0.7 |
| BSADA42KIT | 225 | 16 | 42 | 2 | 11 | 0.8 |
| BSADA48KIT | 235 | 16 | 48 | 2 | 13 | 0.9 |
| BSADA54KIT | 247 | 16 | 54 | 2 | 14 | 1.0 |
| BSADA60KIT | 261 | 16 | 60 | 2 | 15 | 1.1 |

BSADA-OMKIT • Off-Module Conversion Kit

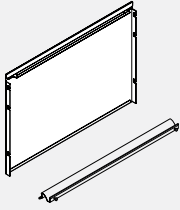

- Converts an existing Panel Mounted Storage Unit BSADA-PM to Off-Module Overhead Storage unit BSADA-OMKIT.
- Kit includes a back panel with integrated hanging bracket and an extruded bottom bracket.
- **IMPORTANT:** BSADA Overhead with Off-Module Conversion kit can only be installed on B3 fabric tile. Tiles below the overhead can be fabric, laminate and accessory tile. However, the tile the overhead is hanging on must be fabric.
- BSADA Overhead with Off-Module Conversion Kit can be suspended off of a single fabric tile, or can span two fabric tiles on two adjacent, directly interconnected panels.
- BSADA Overhead with Off-Module Conversion Kit **CANNOT** be suspended off of two panels separated by a post.

| PRODUCT CODE | PRICE | SIZE/INCHES | | | WEIGHT VOL | |
|--------------|-------|-------------|----|---|------------|-----------------|
| | | H | W | D | LBS | FT ³ |
| BSADA240MKIT | 194 | 16 | 24 | 2 | 6 | 0.5 |
| BSADA300MKIT | 201 | 16 | 30 | 2 | 8 | 0.6 |
| BSADA360MKIT | 210 | 16 | 36 | 2 | 10 | 0.7 |
| BSADA420MKIT | 225 | 16 | 42 | 2 | 11 | 0.8 |
| BSADA480MKIT | 235 | 16 | 48 | 2 | 13 | 0.9 |
| BSADA540MKIT | 247 | 16 | 54 | 2 | 14 | 1.0 |
| BSADA600MKIT | 261 | 16 | 60 | 2 | 15 | 1.1 |

BSADA-KIT • Panel Mount Conversion Kit



- Converts an existing Up-Mount Overhead Storage Unit BSADA-UM to a Panel Mounted Overhead Storage Unit BSADA-PM.
- Kit includes panel mounting brackets.

| PRODUCT CODE | PRICE | SIZE/INCHES | | | WEIGHT VOL | |
|--------------|-------|-------------|-----|---|------------|-----------------|
| | | H | W | D | LBS | FT ³ |
| BSADAPMKIT | 40 | 16 | 0.5 | 2 | 2 | 0.009 |

BSP1DO • Overhead Divider Storage for Boulevard 1 - Open Double Sided

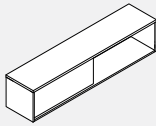

- Panel top mount allows access on both sides.
- Storage compartment internal height: 14".
- Overhead available in standard GC laminate finishes.
- Top mount on panels.
- Connecting hardware included.

| PRODUCT CODE | PRICE | | SIZE/INCHES | | | WEIGHT VOL | |
|--------------|-------|-----|-------------|----|----|------------|-----------------|
| | LP | HP | H | W | D | LBS | FT ³ |
| BSP1DO36 | 655 | 737 | 16 | 36 | 16 | 81 | 7 |
| BSP1DO42 | 675 | 766 | 16 | 42 | 16 | 96 | 8 |
| BSP1DO48 | 700 | 808 | 16 | 48 | 16 | 100 | 9 |

BSP1LDS • Overhead Divider Storage for Boulevard 1 - Open Double Sided with Sliding Laminate Door

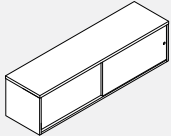

- Panel top mount allows access on both sides.
- Storage compartment internal height: 14".
- Overhead available in standard GC laminate finishes.
- Top mount on panels.
- Connecting hardware included.
- Sliding laminate doors are not locking.

| PRODUCT CODE | PRICE | | SIZE/INCHES | | | WEIGHT VOL | |
|--------------|-------|------|-------------|----|----|------------|-----------------|
| | LP | HP | H | W | D | LBS | FT ³ |
| BSP1LDS36 | 2057 | 2136 | 16 | 36 | 16 | 87 | 7 |
| BSP1LDS42 | 2103 | 2199 | 16 | 42 | 16 | 103 | 8 |
| BSP1LDS48 | 2131 | 2240 | 16 | 48 | 16 | 108 | 9 |

BSP1GDS • Overhead Divider Storage for Boulevard 1 - Open Double Sided with Sliding Glass Door

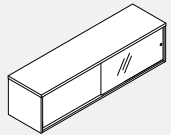

- Panel top mount allows access on both sides.
- Storage compartment internal height: 14".
- Overhead available in standard GC laminate finishes.
- Top mount on panels.
- Connecting hardware included.
- Sliding glass doors are not locking.

| PRODUCT CODE | PRICE | | SIZE/INCHES | | | WEIGHT VOL | |
|--------------|-------|------|-------------|----|----|------------|-----------------|
| | LP | HP | H | W | D | LBS | FT ³ |
| BSP1GDS36 | 2129 | 2210 | 16 | 36 | 16 | 92 | 7 |
| BSP1GDS42 | 2165 | 2261 | 16 | 42 | 16 | 108 | 8 |
| BSP1GDS48 | 2196 | 2304 | 16 | 48 | 16 | 113 | 9 |

BSP3DO • Overhead Divider Storage for Boulevard System 3 - Open Double Sided

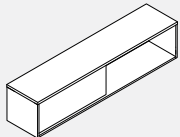

- Panel top mount allows access on both sides.
- Storage compartment internal height: 14".
- Overhead available in standard GC laminate finishes.
- Top mount on panels.
- Connecting hardware included.

| PRODUCT CODE | PRICE | | SIZE/INCHES | | | WEIGHT VOL | |
|--------------|-------|-----|-------------|----|----|------------|-----------------|
| | LP | HP | H | W | D | LBS | FT ³ |
| BSP3DO36 | 633 | 716 | 16 | 36 | 16 | 81 | 9 |
| BSP3DO42 | 660 | 756 | 16 | 42 | 16 | 96 | 10.5 |
| BSP3DO48 | 689 | 796 | 16 | 48 | 16 | 100 | 12 |

BSP3LDS • Overhead Divider Storage for Boulevard System 3 - Open Double Sided with Sliding Laminate Door

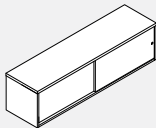

- Panel top mount allows access on both sides.
- Storage compartment internal height: 14".
- Overhead available in standard GC laminate finishes.
- Top mount on panels.
- Connecting hardware included.
- Sliding laminate doors are not locking.

| PRODUCT CODE | PRICE | | SIZE/INCHES | | | WEIGHT VOL | |
|--------------|-------|------|-------------|----|----|------------|-----------------|
| | LP | HP | H | W | D | LBS | FT ³ |
| BSP3LDS36 | 2036 | 2117 | 16 | 36 | 16 | 106 | 7 |
| BSP3LDS42 | 2086 | 2178 | 16 | 42 | 16 | 126 | 8 |
| BSP3LDS48 | 2110 | 2221 | 16 | 48 | 16 | 134 | 9 |

BSP3GDS • Overhead Divider Storage for Boulevard System 3 - Open Double Sided with Sliding Glass Door

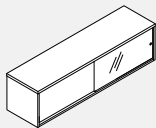

- Panel top mount allows access on both sides.
- Storage compartment internal height: 14".
- Overhead available in standard GC laminate finishes.
- Top mount on panels.
- Connecting hardware included.
- Sliding glass doors are not locking.

| PRODUCT CODE | PRICE | | SIZE/INCHES | | | WEIGHT VOL | |
|--------------|-------|------|-------------|----|----|------------|-----------------|
| | LP | HP | H | W | D | LBS | FT ³ |
| BSP3GDS36 | 2108 | 2190 | 16 | 36 | 16 | 87 | 6 |
| BSP3GDS42 | 2143 | 2240 | 16 | 42 | 16 | 103 | 7 |
| BSP3GDS48 | 2174 | 2284 | 16 | 48 | 16 | 107 | 9 |

BS93FPxxBFC • 9300 Series Freestanding Box File Pedestal

- One box and one file drawer pedestal.
- Freestanding, counterweight included.
- All drawers are locking.
- Box drawer includes pencil tray.

| PRODUCT CODE | PRICE | SIZE/INCHES | | | WEIGHT LBS | VOL FT ³ |
|--------------|-------|-------------|----|----|------------|---------------------|
| | | H | W | D | | |
| BS93FP19BFC | 559 | 21.31 | 15 | 19 | 50 | 5.1 |
| BS93FP23BFC | 566 | 21.31 | 15 | 23 | 55 | 6.0 |
| BS93FP29BFC | 678 | 21.31 | 15 | 29 | 64 | 7.5 |

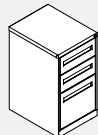
BS93FPxxBBFC • 9300 Series Freestanding Box Box File Pedestal

- Two box and one file drawer pedestal.
- Freestanding, counterweight included.
- All drawers are locking.
- Top box drawer includes pencil tray.

| PRODUCT CODE | PRICE | SIZE/INCHES | | | WEIGHT LBS | VOL FT ³ |
|--------------|-------|-------------|----|----|------------|---------------------|
| | | H | W | D | | |
| BS93FP19BBFC | 617 | 27.87 | 15 | 19 | 55 | 6.5 |
| BS93FP23BBFC | 628 | 27.87 | 15 | 23 | 68 | 7.7 |
| BS93FP29BBFC | 741 | 27.87 | 15 | 29 | 78 | 9.6 |

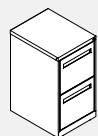
BS93FPxxFFC • 9300 Series Freestanding File File Pedestal

- Two file drawer pedestal.
- Freestanding, counterweight included.
- All drawers are locking.

| PRODUCT CODE | PRICE | SIZE/INCHES | | | WEIGHT LBS | VOL FT ³ |
|--------------|-------|-------------|----|----|------------|---------------------|
| | | H | W | D | | |
| BS93FP19FFC | 589 | 27.87 | 15 | 19 | 53 | 6.5 |
| BS93FP23FFC | 597 | 27.87 | 15 | 23 | 60 | 7.7 |
| BS93FP29FFC | 699 | 27.87 | 15 | 29 | 70 | 9.6 |

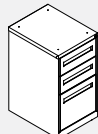
BS93WPxxBBFC • 9300 Series Worksurface Supporting Box Box File Pedestal

- Two box and one file drawer pedestal.
- Worksurface supporting, includes mounting holes in the top.
- All drawers are locking.
- Top box drawer includes pencil tray.
- Note: Specify bracket and filler kit separately, BSPWSB93.

| PRODUCT CODE | PRICE | SIZE/INCHES | | | WEIGHT LBS | VOL FT ³ |
|--------------|-------|-------------|----|----|------------|---------------------|
| | | H | W | D | | |
| BS93WP19BBFC | 613 | 27.87 | 15 | 19 | 55 | 6.5 |
| BS93WP23BBFC | 621 | 27.87 | 15 | 23 | 68 | 7.7 |
| BS93WP29BBFC | 711 | 27.87 | 15 | 29 | 78 | 9.6 |

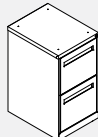
BS93WPxxFFC • 9300 Series Worksurface Supporting File File Pedestal

- Two file drawer pedestal.
- Worksurface supporting, includes mounting holes in the top.
- All drawers are locking.
- Note: Specify bracket and filler kit separately, BSPWSB93.

| PRODUCT CODE | PRICE | SIZE/INCHES | | | WEIGHT LBS | VOL FT ³ |
|--------------|-------|-------------|----|----|------------|---------------------|
| | | H | W | D | | |
| BS93WP19FFC | 582 | 27.87 | 15 | 19 | 53 | 6.5 |
| BS93WP23FFC | 587 | 27.87 | 15 | 23 | 60 | 7.7 |
| BS93WP29FFC | 700 | 27.87 | 15 | 29 | 70 | 9.6 |

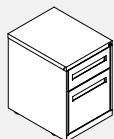
BS93MPxxBFC • 9300 Series Mobile Box File Pedestal

- One box and one file drawer mobile pedestal.
- Casters preinstalled, casters non-locking.
- Counterweight included.
- All drawers locking.
- Box drawer includes pencil tray.
- NOTE: Cannot be used as guest seating.

| PRODUCT CODE | PRICE | SIZE/INCHES | | | WEIGHT LBS | VOL FT ³ |
|--------------|-------|-------------|----|----|------------|---------------------|
| | | H | W | D | | |
| BS93MP19BFC | 659 | 21.87 | 15 | 19 | 66 | 5.2 |
| BS93MP23BFC | 681 | 21.87 | 15 | 23 | 72 | 6.2 |
| BS93MP29BFC | 730 | 21.87 | 15 | 29 | 92 | 7.6 |

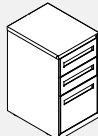
BS93MPxxBBFC • 9300 Series Mobile Box Box File Pedestal

- Two box and one file drawer mobile pedestal.
- Casters preinstalled, casters non-locking.
- Counterweight included.
- All drawers locking.
- Top box drawer includes pencil tray.
- NOTE: Cannot be used as guest seating.

| PRODUCT CODE | PRICE | SIZE/INCHES | | | WEIGHT LBS | VOL FT ³ |
|--------------|-------|-------------|----|----|------------|---------------------|
| | | H | W | D | | |
| BS93MP19BBFC | 695 | 27.93 | 15 | 19 | 76 | 6.5 |
| BS93MP23BBFC | 702 | 27.93 | 15 | 23 | 85 | 7.7 |
| BS93MP29BBFC | 757 | 27.93 | 15 | 29 | 94 | 9.6 |

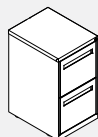
BS93MPxxFFC • 9300 Series Mobile File File Pedestal

- Two file drawer pedestal.
- Casters preinstalled, casters non-locking.
- Counterweight included.
- All drawers locking.
- NOTE: Cannot be used as guest seating.

| PRODUCT CODE | PRICE | SIZE/INCHES | | | WEIGHT LBS | VOL FT ³ |
|--------------|-------|-------------|----|----|------------|---------------------|
| | | H | W | D | | |
| BS93MP19FFC | 654 | 27.93 | 15 | 19 | 73 | 6.5 |
| BS93MP23FFC | 681 | 27.93 | 15 | 23 | 81 | 7.7 |
| BS93MP29FFC | 748 | 27.93 | 15 | 29 | 90 | 9.6 |

BSPF0BFxxC • Prime Freestanding Box File Pedestal



- One box and one file drawer pedestal.
- All drawers are locking.
- Box drawer includes pencil tray.
- For freestanding, to add counterweight (W2 option), add \$49 list.
- For mobile to add casters and counterweight (W1 option), add \$73 list. Adds 0.5" to height.
- NOTE: Cannot be used as guest seating.

| PRODUCT CODE | PRICE | SIZE/INCHES | | | WEIGHT LBS | VOL FT ³ |
|--------------|-------|-------------|----|----|------------|---------------------|
| | | H | W | D | | |
| BSPF0BF18C | 722 | 20.8 | 15 | 18 | 52.4 | 4.2 |
| BSPF0BF22C | 756 | 20.8 | 15 | 22 | 58.8 | 5.0 |
| BSPF0BF28C | 791 | 20.8 | 15 | 28 | 68.7 | 6.3 |

BSPFSBGxxC • Prime Box Box File Pedestal



- Two box and one file drawer pedestal.
- All drawers are locking.
- Top box drawer includes pencil tray.
- For freestanding, to add counterweight (W2 option), add \$49 list.
- For mobile to add casters and counterweight (W1 option), add \$73 list. Adds 0.5" to height.
- Top box drawer 4.8"h; middle box drawer 6.4"h; bottom file drawer 13.6"h (interior 12.5"h).
- Note: Specify bracket and filler kit separately, BSPWSBPM18 for 18" deep and BSPWSBPM22 for 22 and 28" deep.

| PRODUCT CODE | PRICE | SIZE/INCHES | | | WEIGHT LBS | VOL FT ³ |
|--------------|-------|-------------|----|----|------------|---------------------|
| | | H | W | D | | |
| BSPFSBG18C | 834 | 28 | 15 | 18 | 67.5 | 5.5 |
| BSPFSBG22C | 874 | 28 | 15 | 22 | 75.0 | 6.6 |
| BSPFSBG28C | 913 | 28 | 15 | 28 | 86.8 | 8.3 |

BSPF0FGxxC • Prime File File Pedestal



- Two file drawer pedestal.
- All drawers are locking.
- For freestanding, to add counterweight (W2 option), add \$49 list.
- For mobile to add casters and counterweight (W1 option), add \$73 list. Adds 0.5" to height.
- Top file drawer 11.2"h (interior 10.6"h); bottom file drawer 13.6"h (interior 12.5"h).
- Note: Specify bracket and filler kit separately, BSPWSBPM18 for 18" deep and BSPWSBPM22 for 22 and 28" deep.

| PRODUCT CODE | PRICE | SIZE/INCHES | | | WEIGHT LBS | VOL FT ³ |
|--------------|-------|-------------|----|----|------------|---------------------|
| | | H | W | D | | |
| BSPF0FG18C | 761 | 28 | 15 | 18 | 67.5 | 5.5 |
| BSPF0FG22C | 791 | 28 | 15 | 22 | 75.0 | 6.6 |
| BSPF0FG28C | 825 | 28 | 15 | 28 | 86.8 | 8.3 |

BSPW0BFxxC • Prime Mobile Box File Pedestal



- Mobile one box and one file drawer pedestal.
- All drawers are locking.
- 60mm casters.
- Front casters are locking.

| PRODUCT CODE | PRICE | SIZE/INCHES | | | WEIGHT LBS | VOL FT ³ |
|--------------|-------|-------------|----|----|------------|---------------------|
| | | H | W | D | | |
| BSPW0BF18C | 888 | 23.3 | 15 | 18 | 73.5 | 4.6 |
| BSPW0BF22C | 917 | 23.3 | 15 | 22 | 79.1 | 5.6 |
| BSPW0BF28C | 947 | 23.3 | 15 | 28 | 87.7 | 7.0 |

BSPWSB93 • Boulevard Worksurface Supporting Bracket for 9300 Series Pedestals



- Kit includes filler and bracket.

| PRODUCT CODE | PRICE | SIZE/ | INCHES | | WEIGHT LBS | VOL FT ³ |
|--------------|-------|-------|--------|---|------------|---------------------|
| | | H | W | D | | |
| BSPWSB93 | 45 | 27.6 | 0.85 | 1 | 1.78 | 0.014 |

BSPWSBPM18 • Boulevard Worksurface Supporting Bracket for Prime Series 18" deep Pedestals



- Kit includes bracket.

| PRODUCT CODE | PRICE | SIZE/ | INCHES | | WEIGHT LBS | VOL FT ³ |
|--------------|-------|-------|--------|---|------------|---------------------|
| | | H | W | D | | |
| BSPWSBPM18 | 19 | 10.7 | 0.85 | 1 | 0.45 | 0.005 |

BSPWSBPM22 • Boulevard Worksurface Supporting Bracket for Prime Series 22 and 28" deep Pedestals



- Kit includes filler and bracket.

| PRODUCT CODE | PRICE | SIZE/ | INCHES | | WEIGHT LBS | VOL FT ³ |
|--------------|-------|-------|--------|---|------------|---------------------|
| | | H | W | D | | |
| BSPWSBPM22 | 51 | 28 | 1.85 | 1 | 2.45 | 0.299 |

BSTC • Pedestal/Lateral Seat Cushion

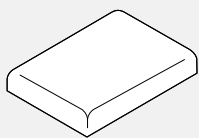

| PRODUCT CODE | YRDS | SIZE/ INCHES | | | WEIGHT VOL | |
|--------------|------|--------------|----|----|------------|-----------------|
| | | H | W | D | LBS | FT ³ |
| BSTCP1518 | 0.75 | 2 | 15 | 18 | 5.00 | 0.41 |
| BSTCP1522 | 0.75 | 2 | 15 | 22 | 5.25 | 0.45 |
| BSTCP1528 | 1.00 | 2 | 15 | 28 | 5.5 | 0.55 |
| BSTCL1830 | 1.00 | 2 | 18 | 30 | 6.0 | 0.55 |
| BSTCL1836 | 1.25 | 2 | 18 | 36 | 6.5 | 0.65 |

| PRODUCT CODE | PRICE | | | | | | | | | | | | | | | | | | | |
|--------------|-------|-----|-----|-----|-----|-----|-----|-----|-----|------|------|------|------|------|------|------|------|------|------|------|
| | GR1 | GR2 | GR3 | GR4 | GR5 | GR6 | GR7 | GR8 | GR9 | GR10 | GR11 | GR12 | GR13 | GR14 | GR15 | GR16 | GR17 | GR18 | GR19 | GR20 |
| BSTCP1518 | 202 | 233 | 252 | 280 | 323 | 364 | 401 | 435 | 477 | 518 | 574 | 652 | 724 | 802 | 972 | 1142 | 1312 | 1482 | 1652 | 1839 |
| BSTCP1522 | 212 | 240 | 264 | 291 | 333 | 372 | 411 | 448 | 486 | 528 | 582 | 659 | 736 | 813 | 984 | 1153 | 1324 | 1495 | 1661 | 1848 |
| BSTCP1528 | 267 | 305 | 336 | 371 | 426 | 480 | 534 | 579 | 631 | 688 | 759 | 864 | 964 | 1065 | 1294 | 1517 | 1747 | 1973 | 2198 | 2448 |
| BSTCL1830 | 289 | 328 | 355 | 394 | 450 | 503 | 552 | 603 | 655 | 712 | 783 | 886 | 987 | 1089 | 1317 | 1541 | 1772 | 1996 | 2221 | 2471 |
| BSTCL1836 | 343 | 391 | 430 | 475 | 543 | 608 | 673 | 733 | 801 | 869 | 960 | 1089 | 1214 | 1343 | 1628 | 1908 | 2194 | 2474 | 2757 | 3070 |

BSLPS0BF18xxC • Prime Box File Lateral

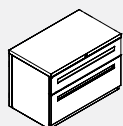

- One and a half height lateral filing cabinet.
- Fixed front drawers, top box drawer front 4.8" bottom file drawer front 13.6" (interior 12.5").
- Locking.
- Side to side hanging bars included.
- To add counterweight (W2 option), add \$400 list.

| PRODUCT CODE | PRICE | SIZE/INCHES | | | WEIGHT LBS | VOL FT ³ |
|---------------|-------|-------------|----|-------|------------|---------------------|
| | | H | W | D | | |
| BSLPS0BF1830C | 1191 | 20.98 | 30 | 18.06 | 119.96 | 8.0 |
| BSLPS0BF1836C | 1283 | 20.98 | 36 | 18.06 | 129.86 | 9.5 |
| BSLPS0BF1842C | 1371 | 20.98 | 42 | 18.06 | 165.45 | 11.1 |

BSLF20G18xxC • Prime 2 High Lateral File

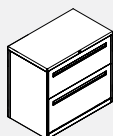

- Two high lateral filing cabinet.
- Fixed front file drawers, top drawer front 11.2" (interior 10.6") bottom drawer front 13.6" (interior 12.5").
- Locking.
- Side to side hanging bars included.
- To add counterweight (W2 option), add \$195 list.

| PRODUCT CODE | PRICE | SIZE/INCHES | | | WEIGHT LBS | VOL FT ³ |
|--------------|-------|-------------|----|----|------------|---------------------|
| | | H | W | D | | |
| BSLF20G1830C | 1279 | 28 | 30 | 18 | 98.7 | 10.5 |
| BSLF20G1836C | 1366 | 28 | 36 | 18 | 114.4 | 12.5 |
| BSLF20G1842C | 1454 | 28 | 42 | 18 | 129.4 | 14.5 |

BSLF30G18xxC • Prime 3 High Lateral File

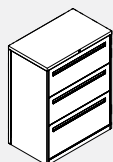

- Three high lateral filing cabinet.
- Fixed front file drawers, top & middle drawer front 11.2" (interior 10.6") bottom drawer front 13.6" (interior 12.5").
- Locking.
- Side to side hanging bars included.
- Will not line up with 42" high panels.
- To add counterweight (W2 option), add \$195 list.

| PRODUCT CODE | PRICE | SIZE/INCHES | | | WEIGHT LBS | VOL FT ³ |
|--------------|-------|-------------|----|----|------------|---------------------|
| | | H | W | D | | |
| BSLF30G1830C | 1747 | 39.2 | 30 | 18 | 127.9 | 14.5 |
| BSLF30G1836C | 1869 | 39.2 | 36 | 18 | 147.6 | 17.2 |
| BSLF30G1842C | 1994 | 39.2 | 42 | 18 | 167.5 | 20.0 |

BSLF40G18xxC • Prime 4 High FFFF Lateral File

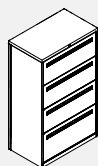

- Four high fixed front lateral filing cabinet.
- Fixed front file drawers, top drawer front 10.4" (interior 9.8") , second and third drawers 11.2" (interior 10.6") bottom drawer front 13.6" (interior 12.5").
- Locking.
- Side to side hanging bars included.
- To add counterweight (W2 option), add \$195 list.

| PRODUCT CODE | PRICE | SIZE/INCHES | | | WEIGHT LBS | VOL FT ³ |
|--------------|-------|-------------|----|----|------------|---------------------|
| | | H | W | D | | |
| BSLF40G1830C | 2103 | 49.6 | 30 | 18 | 159.1 | 18.2 |
| BSLF40G1836C | 2255 | 49.6 | 36 | 18 | 183.4 | 21.6 |
| BSLF40G1842C | 2406 | 49.6 | 42 | 18 | 208.5 | 25.1 |

BSLF40H18xxC • Prime 4 High RFFF Lateral File

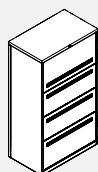

- Four high receding top door and remaining fixed front lateral filing cabinet.
- Top opening receding door + roll-out shelf 14.4" front, accepts binder height; fixed front drawers second and third drawers 11.2" (interior 10.6") bottom drawer front 13.6" (interior 12.5").
- Locking.
- Side to side hanging bars included.
- To add counterweight (W2 option), add \$195 list.

| PRODUCT CODE | PRICE | SIZE/INCHES | | | WEIGHT LBS | VOL FT ³ |
|--------------|-------|-------------|----|----|------------|---------------------|
| | | H | W | D | | |
| BSLF40H1830C | 2323 | 53.6 | 30 | 18 | 171.9 | 19.6 |
| BSLF40H1836C | 2474 | 53.6 | 36 | 18 | 198.2 | 23.3 |
| BSLF40H1842C | 2630 | 53.6 | 42 | 18 | 225.3 | 27.0 |

BSLF50P18xxC • Prime 5 High RFFFF Lateral File

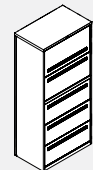

- Five high receding top door and remaining fixed front lateral filing cabinet.
- Locking.
- Side to side hanging bars included.
- Top opening receding door + roll-out shelf 14.4" front, accepts binder height; fixed front drawers below - second and third 11.2" (interior 10.6") bottom drawer front 13.6" (interior 12.5").
- To add counterweight (W2 option), add \$195 list.

| PRODUCT CODE | PRICE | SIZE/INCHES | | | WEIGHT LBS | VOL FT ³ |
|--------------|-------|-------------|----|----|------------|---------------------|
| | | H | W | D | | |
| BSLF50P1830C | 2860 | 65.6 | 30 | 18 | 208.9 | 23.9 |
| BSLF50P1836C | 3035 | 65.6 | 36 | 18 | 239.9 | 28.4 |
| BSLF50P1842C | 3221 | 65.6 | 42 | 18 | 272.7 | 32.9 |

BSSC21G18xxC • Prime 2 High Storage Cabinet

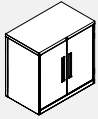

- Two high storage cabinet.
- One adjustable shelf + fixed bottom shelf.
- Locking.

| PRODUCT CODE | PRICE | SIZE/INCHES | | | WEIGHT LBS | VOL FT ³ |
|--------------|-------|-------------|----|----|------------|---------------------|
| | | H | W | D | | |
| BSSC21G1830C | 1005 | 28 | 30 | 18 | 75.08 | 10.5 |
| BSSC21G1836C | 1074 | 28 | 36 | 18 | 86.48 | 12.5 |
| BSSC21G1842C | 1142 | 28 | 42 | 18 | 95.78 | 14.5 |

BSSC31G18xxC • Prime 3 High Storage Cabinet

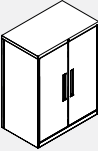

- Three high storage cabinet.
- Two adjustable shelves + fixed bottom shelf.
- Will not line up to 42" high panels.
- Locking.

| PRODUCT CODE | PRICE | SIZE/INCHES | | | WEIGHT LBS | VOL FT ³ |
|--------------|-------|-------------|----|----|------------|---------------------|
| | | H | W | D | | |
| BSSC31G1830C | 1401 | 39.2 | 30 | 18 | 96.69 | 14.5 |
| BSSC31G1836C | 1493 | 39.2 | 36 | 18 | 111.59 | 17.2 |
| BSSC31G1842C | 1571 | 39.2 | 42 | 18 | 124.49 | 20.0 |

BSSC41G18xxC • Prime 4 High Storage Cabinet

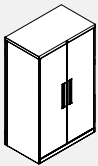

- Three high storage cabinet to line up to 50" high panels.
- Three adjustable shelves + fixed bottom shelf.
- Locking.

| PRODUCT CODE | PRICE | SIZE/INCHES | | | WEIGHT LBS | VOL FT ³ |
|--------------|-------|-------------|----|----|------------|---------------------|
| | | H | W | D | | |
| BSSC41G1830C | 1645 | 49.6 | 30 | 18 | 111.22 | 18.2 |
| BSSC41G1836C | 1752 | 49.6 | 36 | 18 | 129.32 | 21.6 |
| BSSC41G1842C | 1840 | 49.6 | 42 | 18 | 145.42 | 25.1 |

BSSC41H18xxC • Prime 4 High Storage Cabinet

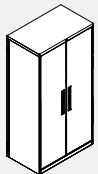

- Four high storage cabinet.
- Three adjustable shelves + fixed bottom shelf.
- Locking.

| PRODUCT CODE | PRICE | SIZE/INCHES | | | WEIGHT LBS | VOL FT ³ |
|--------------|-------|-------------|----|----|------------|---------------------|
| | | H | W | D | | |
| BSSC41H1830C | 1713 | 53.6 | 30 | 18 | 120.17 | 19.6 |
| BSSC41H1836C | 1825 | 53.6 | 36 | 18 | 138.27 | 23.3 |
| BSSC41H1842C | 1913 | 53.6 | 42 | 18 | 154.37 | 27.0 |

BSSC51C18xxC • Prime 5 High Storage Cabinet

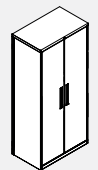

- Five high storage cabinet.
- Four adjustable shelves + fixed bottom shelf.
- Locking.

| PRODUCT CODE | PRICE | SIZE/INCHES | | | WEIGHT LBS | VOL FT ³ |
|--------------|-------|-------------|----|----|------------|---------------------|
| | | H | W | D | | |
| BSSC51C1830C | 1947 | 65.6 | 30 | 18 | 138.5 | 23.9 |
| BSSC51C1836C | 2069 | 65.6 | 36 | 18 | 160.4 | 28.4 |
| BSSC51C1842C | 2162 | 65.6 | 42 | 18 | 180.4 | 32.9 |

BSSLFxx24BCCL • Prime Tower, Left Wardrobe, Half Height Door, Box Box File Drawers

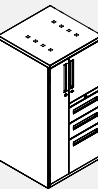

- Left wardrobe tower with half height door and box box file drawers.
- Wardrobe section includes top shelf and coat bar.
- Hinged door compartment of 50"h and 54"h includes one adjustable shelf; 66"h includes two adjustable open shelves.
- Wardrobe section includes top perforations for ventilation.
- Three locks included - wardrobe door, hinged door shelving compartment and drawers.
- To add counterweight (W2 option), add \$102 list.

| PRODUCT CODE | PRICE | SIZE/INCHES | | | WEIGHT LBS | VOL FT ³ |
|---------------|-------|-------------|----|----|------------|---------------------|
| | | H | W | D | | |
| BSSLF4G24BCCL | 3348 | 49.6 | 24 | 24 | 176.71 | 19.2 |
| BSSLF4H24BCCL | 3348 | 53.6 | 24 | 24 | 181.63 | 19.8 |
| BSSLF5024BCCL | 3514 | 65.6 | 24 | 24 | 204.52 | 25.2 |

"4G" Tower Shown

BSSLFxx24BCCR • Prime Tower, Right Wardrobe, Half Height Door, Box Box File Drawers

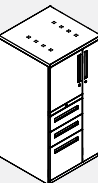

- Right wardrobe tower with half height door and box box file drawers.
- Wardrobe section includes top shelf and coat bar.
- Hinged door compartment of 50"h and 54"h includes one adjustable shelf; 66"h includes two adjustable open shelves.
- Wardrobe section includes top perforations for ventilation.
- Three locks included - wardrobe door, hinged door shelving compartment and drawers.
- To add counterweight (W2 option), add \$102 list.

| PRODUCT CODE | PRICE | SIZE/INCHES | | | WEIGHT LBS | VOL FT ³ |
|---------------|-------|-------------|----|----|------------|---------------------|
| | | H | W | D | | |
| BSSLF4G24BCCR | 3348 | 49.6 | 24 | 24 | 176.71 | 19.2 |
| BSSLF4H24BCCR | 3348 | 53.6 | 24 | 24 | 181.63 | 19.8 |
| BSSLF5024BCCR | 3514 | 65.6 | 24 | 24 | 204.52 | 25.2 |

"4G" Tower Shown

BSSLFxx24FCCL • Prime Tower, Left Wardrobe, Half Height Door, File File Drawers

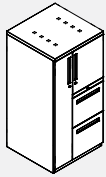

"4G" Tower Shown

- Left wardrobe tower with half height door and file file drawers.
- Wardrobe section includes top shelf and coat bar.
- Hinged door compartment of 50"h and 54"h includes one adjustable shelf; 66"h includes two adjustable open shelves.
- Wardrobe section includes top perforations for ventilation.
- Three locks included - wardrobe door, hinged door shelving compartment and drawers.
- To add counterweight (W2 option), add \$102 list.

| PRODUCT CODE | PRICE | SIZE/INCHES | | | WEIGHT LBS | VOL FT ³ |
|---------------|-------|-------------|----|----|------------|---------------------|
| | | H | W | D | | |
| BSSLF4G24FCCL | 3260 | 49.6 | 24 | 24 | 181.05 | 19.2 |
| BSSLF4H24FCCL | 3260 | 53.6 | 24 | 24 | 186.43 | 19.8 |
| BSSLF5024FCCL | 3431 | 65.6 | 24 | 24 | 231.53 | 25.2 |

BSSLFxx24FCCR • Prime Tower, Right Wardrobe, Half Height Door, File File Drawers

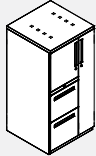

"4G" Tower Shown

- Right wardrobe tower with half height door and file file drawers.
- Wardrobe section includes top shelf and coat bar.
- Hinged door compartment of 50"h and 54"h includes one adjustable shelf; 66"h includes two adjustable open shelves.
- Wardrobe section includes top perforations for ventilation.
- Three locks included - wardrobe door, hinged door shelving compartment and drawers.
- To add counterweight (W2 option), add \$102 list.

| PRODUCT CODE | PRICE | SIZE/INCHES | | | WEIGHT LBS | VOL FT ³ |
|---------------|-------|-------------|----|----|------------|---------------------|
| | | H | W | D | | |
| BSSLF4G24FCCR | 3260 | 49.6 | 24 | 24 | 181.05 | 19.2 |
| BSSLF4H24FCCR | 3260 | 53.6 | 24 | 24 | 186.43 | 19.8 |
| BSSLF5024FCCR | 3431 | 65.6 | 24 | 24 | 231.53 | 25.2 |

BSSLSxx2424BOCL • Prime Tower, Left Wardrobe, Side Open Shelf, Box Box File Drawers

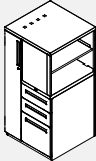

"4G" Tower Shown

- Left wardrobe tower with side open shelving and box box file drawers.
- Wardrobe section includes top shelf and coat bar.
- 50"h and 54"h include open side shelf with one adjustable shelf; 66"h includes open side shelf with two adjustable shelves.
- Wardrobe section includes top perforations for ventilation.
- Two locks included - wardrobe door and drawers.

| PRODUCT CODE | PRICE | SIZE/INCHES | | | WEIGHT LBS | VOL FT ³ |
|-----------------|-------|-------------|----|----|------------|---------------------|
| | | H | W | D | | |
| BSSLS4G2424BOCL | 3475 | 49.6 | 24 | 24 | 186.18 | 19.2 |
| BSSLS4H2424BOCL | 3475 | 53.6 | 24 | 24 | 186.91 | 19.8 |
| BSSLS502424BOCL | 3684 | 65.6 | 24 | 24 | 236.34 | 25.2 |

BSSLSxx2424BOCR • Prime Tower, Right Wardrobe, Side Open Shelf, Box Box File Drawers

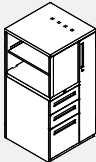

"4G" Tower Shown

- Right wardrobe tower with side open shelving and box box file drawers.
- Wardrobe section includes top shelf and coat bar.
- 50"h and 54"h include open side shelf with one adjustable shelf; 66"h includes open side shelf with two adjustable shelves.
- Wardrobe section includes top perforations for ventilation.
- Two locks included - wardrobe door and drawers.

| PRODUCT CODE | PRICE | SIZE/INCHES | | | WEIGHT LBS | VOL FT ³ |
|-----------------|-------|-------------|----|----|------------|---------------------|
| | | H | W | D | | |
| BSSLS4G2424BOCR | 3392 | 49.6 | 24 | 24 | 186.18 | 19.2 |
| BSSLS4H2424BOCR | 3392 | 53.6 | 24 | 24 | 186.91 | 19.8 |
| BSSLS502424BOCR | 3601 | 65.6 | 24 | 24 | 236.34 | 25.2 |

BSSLSxx2424FOCL • Prime Tower, Left Wardrobe, Side Open Shelf, File File Drawers

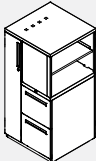

"4G" Tower Shown

- Left wardrobe tower with side open shelving and file file drawers.
- Wardrobe section includes top shelf and coat bar.
- 50"h and 54"h include open side shelf with one adjustable shelf; 66"h includes open side shelf with two adjustable shelves.
- Wardrobe section includes top perforations for ventilation.
- Two locks included - wardrobe door and drawers.

| PRODUCT CODE | PRICE | SIZE/INCHES | | | WEIGHT LBS | VOL FT ³ |
|-----------------|-------|-------------|----|----|------------|---------------------|
| | | H | W | D | | |
| BSSLS4G2424FOCL | 3392 | 49.6 | 24 | 24 | 179.54 | 19.2 |
| BSSLS4H2424FOCL | 3392 | 53.6 | 24 | 24 | 180.26 | 19.8 |
| BSSLS502424FOCL | 3601 | 65.6 | 24 | 24 | 232.55 | 25.2 |

BSSLSxx2424FOCR • Prime Tower, Right Wardrobe, Side Open Shelf, File File Drawers

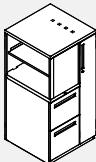

"4G" Tower Shown

- Right wardrobe tower with side open shelving and file file drawers.
- Wardrobe section includes top shelf and coat bar.
- 50"h and 54"h include open side shelf with one adjustable shelf; 66"h includes open side shelf with two adjustable shelves.
- Wardrobe section includes top perforations for ventilation.
- Two locks included - wardrobe door and drawers.

| PRODUCT CODE | PRICE | SIZE/INCHES | | | WEIGHT LBS | VOL FT ³ |
|-----------------|-------|-------------|----|----|------------|---------------------|
| | | H | W | D | | |
| BSSLS4G2424FOCR | 3392 | 49.6 | 24 | 24 | 179.54 | 19.2 |
| BSSLS4H2424FOCR | 3392 | 53.6 | 24 | 24 | 180.26 | 19.8 |
| BSSLS502424FOCR | 3601 | 65.6 | 24 | 24 | 232.55 | 25.2 |

BSWC51C18xxC • Prime Wardrobe

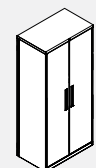

"4G" Tower Shown

- Wardrobe cabinet.
- 30"w includes full width shelf and side to side coat rod.
- 36" and 42"W are split with shelving on left side, wardrobe on the other.
- Locking.

| PRODUCT CODE | PRICE | SIZE/INCHES | | | WEIGHT LBS | VOL FT ³ |
|--------------|-------|-------------|----|----|------------|---------------------|
| | | H | W | D | | |
| BSWC51C1830C | 1874 | 65.6 | 30 | 18 | 125.26 | 23.8 |
| BSWC51C1836C | 2294 | 65.6 | 36 | 18 | 164.97 | 28.4 |
| BSWC51C1842C | 2499 | 65.6 | 42 | 18 | 180.59 | 32.9 |

BSCC31G18xxC • Prime Three High Combination Cabinet

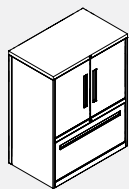

- Multi stor cabinet including hinged door upper section with one adjustable shelf; one fixed front file drawers below.
- Will not line up to 42" high panels.
- Locking.

| PRODUCT CODE | PRICE | SIZE/INCHES | | | WEIGHT LBS | VOL FT ³ |
|--------------|-------|-------------|----|----|------------|---------------------|
| | | H | W | D | | |
| BSCC31G1830C | 1664 | 39.2 | 30 | 18 | 117.3 | 14.5 |
| BSCC31G1836C | 1767 | 39.2 | 36 | 18 | 135.5 | 17.2 |
| BSCC31G1842C | 1869 | 39.2 | 42 | 18 | 152.5 | 20.0 |

BSCC41G18xxC • Prime Four High Combination Cabinet

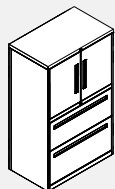

- Multi stor cabinet including hinged door upper section with one adjustable shelf; two fixed front file drawers below, lines up to 50" high panels.
- Locking.
- To add counterweight (W2 option), add \$195 list.

| PRODUCT CODE | PRICE | SIZE/INCHES | | | WEIGHT LBS | VOL FT ³ |
|--------------|-------|-------------|----|----|------------|---------------------|
| | | H | W | D | | |
| BSCC41G1830C | 2064 | 49.6 | 30 | 18 | 149.96 | 18.2 |
| BSCC41G1836C | 2201 | 49.6 | 36 | 18 | 172.96 | 21.6 |
| BSCC41G1842C | 2333 | 49.6 | 42 | 18 | 195.36 | 25.1 |

BSCC41H18xxC • Prime Four High Combination Cabinet

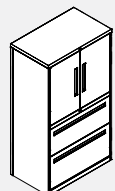

- Multi stor cabinet including hinged door upper section with one adjustable shelf; two fixed front file drawers below, lines up to 54" high panels.
- Locking.
- To add counterweight (W2 option), add \$195 list.

| PRODUCT CODE | PRICE | SIZE/INCHES | | | WEIGHT LBS | VOL FT ³ |
|--------------|-------|-------------|----|----|------------|---------------------|
| | | H | W | D | | |
| BSCC41H1830C | 2133 | 53.6 | 30 | 18 | 154.54 | 19.6 |
| BSCC41H1836C | 2264 | 53.6 | 36 | 18 | 178.54 | 23.3 |
| BSCC41H1842C | 2396 | 53.6 | 42 | 18 | 202.04 | 27.0 |

BSCC31C18xxC • Prime Five High Combination Cabinet

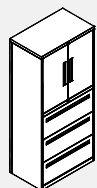

- Multi stor cabinet including hinged door upper section with one adjustable shelf; three fixed front file drawers below.
- Locking.
- To add counterweight (W2 option), add \$195 list.

| PRODUCT CODE | PRICE | SIZE/INCHES | | | WEIGHT LBS | VOL FT ³ |
|--------------|-------|-------------|----|----|------------|---------------------|
| | | H | W | D | | |
| BSCC51C1830C | 2518 | 65.6 | 30 | 18 | 188.5 | 23.9 |
| BSCC51C1836C | 2679 | 65.6 | 36 | 18 | 216.9 | 28.4 |
| BSCC51C1842C | 2840 | 65.6 | 42 | 18 | 245.5 | 32.9 |

BSLFA0718 • Prime Front to Back File Bars

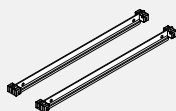

- Package of two, grey finish.

| PRODUCT CODE | PRICE | SIZE/INCHES | | | WEIGHT LBS | VOL FT ³ |
|--------------|-------|-------------|------|---|------------|---------------------|
| | | H | W | D | | |
| BSLFA0718 | 45 | 1 | 17.3 | 1 | 1 | 0.04 |

BSLFS • Prime Hanging File Bars

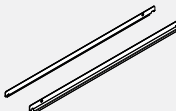

- Package of two, grey finish.

| PRODUCT CODE | PRICE | SIZE/INCHES | | | WEIGHT LBS | VOL FT ³ |
|--------------|-------|-------------|------|-----|------------|---------------------|
| | | H | W | D | | |
| BSLFA01 | 48 | 1.3 | 27.5 | 0.5 | 2 | 0.03 |
| BSLFA02 | 48 | 1.3 | 33.5 | 0.5 | 2.4 | 0.04 |
| BSLFA03 | 48 | 1.3 | 39.5 | 0.5 | 2.8 | 0.05 |

BSLFA1018 • Prime Plate Dividers

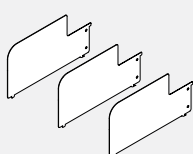

- Package of three, grey finish.

| PRODUCT CODE | PRICE | SIZE/INCHES | | | WEIGHT LBS | VOL FT ³ |
|--------------|-------|-------------|------|-----|------------|---------------------|
| | | H | W | D | | |
| BSLFA1018 | 49 | 7.25 | 13.5 | 0.2 | 4 | 0.07 |

BSLFA2418 • Prime Half Height Plate Dividers

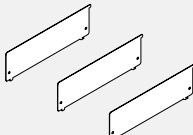

- Package of three, grey finish.

| PRODUCT CODE | PRICE | SIZE/INCHES | | | WEIGHT LBS | VOL FT ³ |
|--------------|-------|-------------|------|-----|------------|---------------------|
| | | H | W | D | | |
| BSLFA2418 | 49 | 3.95 | 13.5 | 0.2 | 2.2 | 0.04 |

BSLFA2018 • Prime EDP Adapters

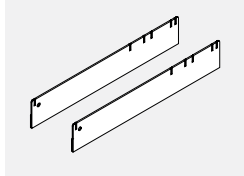

| PRODUCT CODE | PRICE | SIZE/INCHES | | | WEIGHT LBS | VOL FT ³ |
|-----------------|-------|-------------|------|------|---------------|------------------------|
| | | H | W | D | | |
| BSLFA2018 | 49 | 2.6 | 16.5 | 0.15 | 2.5 | 0.02 |

BSEK93 / BSCK093 • Keys and Replacement Lock Core (Profile 9300 Series)

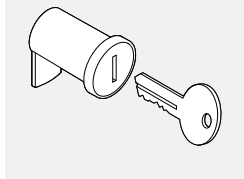

- BSEK93 - Set of two extra keys for existing 9300 Series storage. Specify core #. Key range W401-W550.
- BSCK093 - Includes one lock core and a set of two keys for 9300 Series storage. Specify core #. Key range W401-W550.

| PRODUCT CODE | PRICE | SIZE/INCHES | | | WEIGHT LBS | VOL FT ³ |
|-------------------------|-------|-------------|------|-----|---------------|------------------------|
| | | H | W | D | | |
| BSEK93 EXTRA KEY | 19 | 1.75 | 0.75 | 0.2 | 0.2 | 0.01 |
| BSCK093 LOCK CORE & KEY | 31 | 2 | 1 | 0.5 | 0.4 | 0.01 |

BSKY / BSKC • Keys and Replacement Lock Core (Fileco Prime Series)

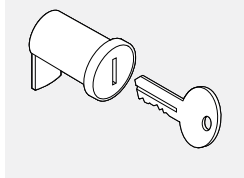

- BSKY - Set of two extra keys for existing Prime storage. Specify core #. Key range W401-W550.
- BSKC - Includes one lock core and a set of two keys for Prime storage. Specify core #. Key range W401-W550.

| PRODUCT CODE | PRICE | SIZE/INCHES | | | WEIGHT LBS | VOL FT ³ |
|----------------------|-------|-------------|------|-----|---------------|------------------------|
| | | H | W | D | | |
| BSKY EXTRA KEY | 13 | 1.75 | 0.75 | 0.2 | 0.2 | 0.01 |
| BSKC LOCK CORE & KEY | 30 | 2 | 1 | 0.5 | 0.4 | 0.01 |

BSSA • Prime Extra Cabinet Shelves

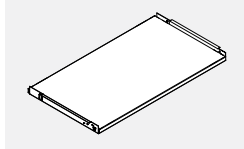

- Shelf, non-slotted.

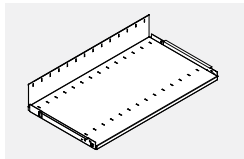

- Shelf, slotted.

| PRODUCT CODE | PRICE | SIZE/INCHES | | | WEIGHT LBS | VOL FT ³ |
|---------------------|-------|-------------|------|----|---------------|------------------------|
| | | H | W | D | | |
| Shelf, non-slotted. | | | | | | |
| BSSA011830 | 83 | 0.8 | 28.4 | 16 | 7.2 | 1.8 |
| BSSA011836 | 93 | 0.8 | 34.4 | 16 | 8.4 | 2.2 |
| BSSA011842 | 98 | 0.8 | 40.4 | 16 | 9.5 | 2.6 |
| Shelf, slotted. | | | | | | |
| BSSA021830 | 98 | 5.25 | 28.4 | 16 | 8.2 | 1.8 |
| BSSA021836 | 114 | 5.25 | 34.4 | 16 | 9.6 | 2.2 |
| BSSA021842 | 120 | 5.25 | 40.4 | 16 | 10.8 | 2.6 |

Diet Panel System

Diet represents an innovative tool for creating an economical, efficient work space, accommodating various tasks. From 42" high panels which provide an open office feel to 50" and 54" high panels, for seated privacy and 66" high panels for standing privacy, Diet effectively supports the creation of various work environments. Diet is simple, easy to comprehend, easy to specify and install, with a minimum of add-on and dedicated/handed components to maximize reconfiguration flexibility. All Diet panels ship with a set of self-leveling connectors that accommodate any angle, but also straight, 90°, three-way T and 120° configurations, as well as four-way "X". Truly universal connectors support the above panel configurations regardless of panel heights. Such a configuration and height independent connecting method eliminates the need to order additional components during future office reconfigurations. Diet is an economical, "soft wire" system with simple means of optional power and data/communication cable management trough that snaps to the bottom of the panel.

With the exception of panels with open area below the mid rail, all Diet panels are built with 6" clearance opening between the floor and the bottom rail. This feature not only serves as a simple passage for cables between back-to-back stations and an interface for a snap on cable trough, but it mainly provides ultimate flexibility of panel station placement even if one panel needs to be located right above a floor monument. Diet's slim appearance, sophisticated industrial design, detailing and advanced engineering communicate high perceived value, exceeding expectations usually related to budget products. Diet can be specified on its own, with integrated worksurface, storage and accessory support, privacy and space organization in free standing office environments. Whether combined with Boulevard system, or raised floors, Diet, as a tool, bridges mobile or stationary freestanding furniture with power/data delivery solutions, that are hard wired to a building power supply.

Technical Information

Panels

- Panels are 1.3" thick.
- Width ranges from 24" to 60" at 6" increments.
- Heights include 42", 50", 54" and 66" (nominal).
- Extruded aluminum frame surrounds a fabric wrapped interior with a 7/8" particle board frame, sandwiched between 2 pieces of 1/8" masonite.
- Panel frame finish is durable epoxy powder coated.
- Finished panel includes top, corner and end caps.
- For glazing - Smoke development index 500.
- For tempered glass, add "TG" to the end of the product code and add 20% to the price regardless of fabric grade.
- Top rail accepts Global Contract accessories, monitor arm supports, off-module shelves, and task light brackets.
- Top rail on Glazed Top Panels is not intended for use with panel mounted shelves and panel mounted overhead.
- Middle rail accepts bracket for off-module worksurface support, Global Contract accessories, off-module shelves and power bar.
- Bottom rail accepts brackets for off-module worksurface support, Global Contract accessories, off-module shelves and optional cable manager and power bar.

- Optional PVC cable manager friction fits into bottom rail.
- Two leveler are included with a 1.75" leveling range.
- Vertical frame members have integrated grooves for additional components.
- Charcoal covers are provided at front of vertical members where connectors attach.
- Panels include 3 sets of hinge connectors, 1 set of spacers and 6 pins.
- Connecting method is simple, accommodating typical configuration, as well as connection of panels at any angle, regardless of height.

Panel Options

- Laminate or whiteboard may be substituted for fabric on panels only, see "OPT" column.
 - Tackboard panels available, please add 25% upcharge.
 - Steel facing available, contact your customer service representative.
- Note:
- 42" High Diet panels do not match Boulevard 42"
 - 50" High Diet panels match Boulevard 50"
 - 54" High Diet panels do not match standard Boulevard 54"
 - 66" High Diet panels matches Boulevard 66"
 - To order 42" and 54" high Diet panels to match Boulevard, please order "BDPFF" and "BDPOF".

HOW DIET REDUCES YOUR COSTS

Finished Panel:

- No inventory costs for connectors, top caps, kick plates and clips.
- Less time required to install, or to disassemble, move and re-install.
- Open bottom panels can reduce cost and improve circulation within the office.

Fewer Parts:

- Only 1 universal cantilever and 3 brackets are needed to build most workstations.
- Easy to attach and remove components from panels.

Simplified Specifications:

- Fewer parts and components make specifying, ordering, and verifying less work.
- Product fits a 6" planning module.

Communications Channel:

- Base communication channel reduces time to install and change cables.

Warranty:

- Limited Lifetime Warranty on materials and workmanship.

DIET PANELS - GUIDELINES FOR ORDERING PRODUCT

Codes

The product guide uses a numbering system with meaningful alphanumeric characters to create a simple-to-understand product number. This makes specifying the product much easier and more accurate.

Example of Panel: **DPFRF6636 CHR**

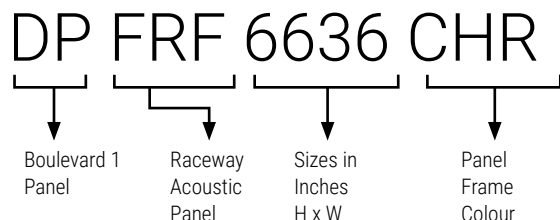

How to Specify

- Specify Diet Panel type and size by code.
- Specify panel frame finish - ie. CHR (Charcoal).
- Specify all six panel fabric options if necessary.

| | |
|------|-----------------------|
| AN50 | Inside Lower Fabric |
| AN50 | Inside Middle Fabric |
| AN50 | Inside Upper Fabric |
| BE21 | Outside Lower Fabric |
| BE21 | Outside Middle Fabric |
| BE21 | Outside Upper Fabric |

DPFF • Fabric Bottom and Fabric Top Panel

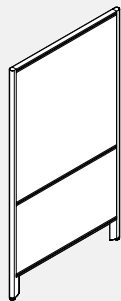

- Fabric above and below the middle rail provides visual privacy.
- Full panel with top, middle and bottom rail.
- OPT* = Laminate or Whiteboard.
- DPFF Panels do not match standard Boulevard heights of 42" and 54".
- DPFF Panels of 50" and 66" height will match standard Boulevard panel heights.

| PRODUCT CODE | PRICE | | | SIZE/ H | INCHES | | | WEIGHT VOL | |
|--------------|-------|-----|------|---------|--------|-----|-----|-----------------|--|
| | GR1 | GR2 | OPT* | | W | D | LBS | FT ³ | |
| DPFF4224 | 388 | 434 | 485 | 42 | 24 | 1.3 | 16 | 1.32 | |
| DPFF4230 | 409 | 455 | 508 | 42 | 30 | 1.3 | 19 | 1.62 | |
| DPFF4236 | 433 | 517 | 609 | 42 | 36 | 1.3 | 23 | 1.94 | |
| DPFF4242 | 455 | 541 | 631 | 42 | 42 | 1.3 | 27 | 2.24 | |
| DPFF4248 | 480 | 565 | 656 | 42 | 48 | 1.3 | 31 | 2.55 | |
| DPFF4254 | 503 | 586 | 680 | 42 | 54 | 1.3 | 35 | 2.85 | |
| DPFF4260 | 523 | 609 | 699 | 42 | 60 | 1.3 | 39 | 3.16 | |
| DPFF5024 | 484 | 534 | 581 | 50 | 24 | 1.3 | 16 | 1.62 | |
| DPFF5030 | 510 | 555 | 608 | 50 | 30 | 1.3 | 21 | 2.08 | |
| DPFF5036 | 537 | 649 | 770 | 50 | 36 | 1.3 | 25 | 2.47 | |
| DPFF5042 | 562 | 673 | 794 | 50 | 42 | 1.3 | 30 | 2.85 | |
| DPFF5048 | 590 | 701 | 824 | 50 | 48 | 1.3 | 35 | 3.25 | |
| DPFF5054 | 614 | 726 | 850 | 50 | 54 | 1.3 | 40 | 3.63 | |
| DPFF5060 | 641 | 754 | 874 | 50 | 60 | 1.3 | 45 | 4.02 | |
| DPFF5424 | 484 | 534 | 581 | 54 | 24 | 1.3 | 18 | 1.62 | |
| DPFF5430 | 510 | 555 | 608 | 54 | 30 | 1.3 | 23 | 2.08 | |
| DPFF5436 | 537 | 649 | 770 | 54 | 36 | 1.3 | 27 | 2.47 | |
| DPFF5442 | 562 | 673 | 794 | 54 | 42 | 1.3 | 32 | 2.85 | |
| DPFF5448 | 590 | 701 | 824 | 54 | 48 | 1.3 | 37 | 3.25 | |
| DPFF5454 | 614 | 726 | 850 | 54 | 54 | 1.3 | 42 | 3.63 | |
| DPFF5460 | 641 | 754 | 874 | 54 | 60 | 1.3 | 47 | 4.02 | |
| DPFF6624 | 527 | 604 | 683 | 66 | 24 | 1.3 | 23 | 2.04 | |
| DPFF6630 | 557 | 633 | 714 | 66 | 30 | 1.3 | 29 | 2.52 | |
| DPFF6636 | 589 | 699 | 823 | 66 | 36 | 1.3 | 35 | 3.00 | |
| DPFF6642 | 619 | 731 | 852 | 66 | 42 | 1.3 | 41 | 3.46 | |
| DPFF6648 | 645 | 758 | 880 | 66 | 48 | 1.3 | 47 | 3.93 | |
| DPFF6654 | 672 | 785 | 907 | 66 | 54 | 1.3 | 53 | 4.40 | |
| DPFF6660 | 699 | 814 | 935 | 66 | 60 | 1.3 | 59 | 4.90 | |

BDPFF • Fabric Bottom and Fabric Top Panel to Match Boulevard Panels

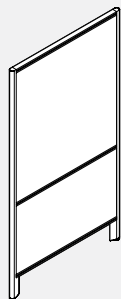

- Fabric above and below the middle rail provides visual privacy.
- Full panel with top, middle and bottom rail.
- OPT* = Laminate or Whiteboard
- Panels will match corresponding Boulevard Panel heights.

| PRODUCT CODE | PRICE | | | SIZE/ H | INCHES | | | WEIGHT VOL | |
|--------------|-------|-----|------|---------|--------|-----|-----|-----------------|--|
| | GR1 | GR2 | OPT* | | W | D | LBS | FT ³ | |
| BDPFF4224 | 388 | 434 | 485 | 42 | 24 | 1.3 | 16 | 1.32 | |
| BDPFF4230 | 409 | 455 | 508 | 42 | 30 | 1.3 | 19 | 1.62 | |
| BDPFF4236 | 433 | 517 | 609 | 42 | 36 | 1.3 | 23 | 1.94 | |
| BDPFF4242 | 455 | 541 | 631 | 42 | 42 | 1.3 | 27 | 2.24 | |
| BDPFF4248 | 480 | 565 | 656 | 42 | 48 | 1.3 | 31 | 2.55 | |
| BDPFF4254 | 503 | 586 | 680 | 42 | 54 | 1.3 | 35 | 2.85 | |
| BDPFF4260 | 523 | 609 | 699 | 42 | 60 | 1.3 | 39 | 3.16 | |
| BDPFF5424 | 484 | 534 | 581 | 54 | 24 | 1.3 | 18 | 1.62 | |
| BDPFF5430 | 510 | 555 | 608 | 54 | 30 | 1.3 | 23 | 2.08 | |
| BDPFF5436 | 537 | 649 | 770 | 54 | 36 | 1.3 | 27 | 2.47 | |
| BDPFF5442 | 562 | 673 | 794 | 54 | 42 | 1.3 | 32 | 2.85 | |
| BDPFF5448 | 590 | 701 | 824 | 54 | 48 | 1.3 | 37 | 3.25 | |
| BDPFF5454 | 614 | 726 | 850 | 54 | 54 | 1.3 | 42 | 3.63 | |
| BDPFF5460 | 641 | 754 | 874 | 54 | 60 | 1.3 | 47 | 4.02 | |

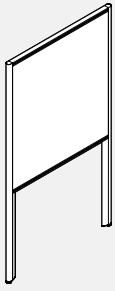
DPOF • Open Bottom and Fabric Top Panel

- Fabric above the middle rail provides visual privacy.
- Panel with top and middle rail only.
- Open bottom reduces cost and improves air circulation within the office.
- OPT* = Laminate or Whiteboard.
- DPOF Panels do not match standard Boulevard heights of 42" and 54".
- DPOF Panels of 50" and 66" height will match standard Boulevard panel heights.

| PRODUCT CODE | PRICE | | | SIZE/ H | INCHES | | | WEIGHT VOL | |
|-----------------|-------|-----|------|------------|--------|-----|-----|-----------------|--|
| | GR1 | GR2 | OPT* | | W | D | LBS | FT ³ | |
| DPOF4224 | 253 | 268 | 283 | 42 | 24 | 1.3 | 9 | 1.32 | |
| DPOF4230 | 271 | 284 | 301 | 42 | 30 | 1.3 | 12 | 1.62 | |
| DPOF4236 | 313 | 342 | 372 | 42 | 36 | 1.3 | 15 | 1.94 | |
| DPOF4242 | 328 | 354 | 385 | 42 | 42 | 1.3 | 17 | 2.24 | |
| DPOF4248 | 343 | 372 | 404 | 42 | 48 | 1.3 | 19 | 2.55 | |
| DPOF4254 | 361 | 388 | 418 | 42 | 54 | 1.3 | 22 | 2.85 | |
| DPOF4260 | 373 | 404 | 433 | 42 | 60 | 1.3 | 24 | 3.16 | |
| DPOF5024 | 319 | 349 | 378 | 50 | 24 | 1.3 | 10 | 1.62 | |
| DPOF5030 | 340 | 369 | 398 | 50 | 30 | 1.3 | 13 | 2.08 | |
| DPOF5036 | 406 | 462 | 522 | 50 | 36 | 1.3 | 16 | 2.47 | |
| DPOF5042 | 425 | 483 | 543 | 50 | 42 | 1.3 | 19 | 2.85 | |
| DPOF5048 | 446 | 503 | 563 | 50 | 48 | 1.3 | 21 | 3.25 | |
| DPOF5054 | 464 | 521 | 581 | 50 | 54 | 1.3 | 25 | 3.63 | |
| DPOF5060 | 484 | 542 | 603 | 50 | 60 | 1.3 | 28 | 4.02 | |
| DPOF5424 | 319 | 349 | 378 | 54 | 24 | 1.3 | 12 | 1.62 | |
| DPOF5430 | 340 | 369 | 398 | 54 | 30 | 1.3 | 15 | 2.08 | |
| DPOF5436 | 406 | 462 | 522 | 54 | 36 | 1.3 | 18 | 2.47 | |
| DPOF5442 | 425 | 483 | 543 | 54 | 42 | 1.3 | 21 | 2.85 | |
| DPOF5448 | 446 | 503 | 563 | 54 | 48 | 1.3 | 24 | 3.25 | |
| DPOF5454 | 464 | 521 | 581 | 54 | 54 | 1.3 | 27 | 3.63 | |
| DPOF5460 | 484 | 542 | 603 | 54 | 60 | 1.3 | 30 | 4.02 | |
| DPOF6624 | 389 | 448 | 508 | 66 | 24 | 1.3 | 17 | 2.04 | |
| DPOF6630 | 412 | 472 | 534 | 66 | 30 | 1.3 | 21 | 2.52 | |
| DPOF6636 | 485 | 543 | 604 | 66 | 36 | 1.3 | 25 | 3.00 | |
| DPOF6642 | 536 | 591 | 653 | 66 | 42 | 1.3 | 29 | 3.46 | |
| DPOF6648 | 561 | 615 | 678 | 66 | 48 | 1.3 | 33 | 3.93 | |
| DPOF6654 | 582 | 641 | 699 | 66 | 54 | 1.3 | 37 | 4.40 | |
| DPOF6660 | 607 | 661 | 723 | 66 | 60 | 1.3 | 41 | 4.90 | |

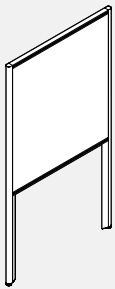
BDPOF • Open Bottom and Fabric Top Panel to Match Boulevard Panels

- Fabric above the middle rail provides visual privacy.
- Panel with top and middle rail only.
- Open bottom reduces cost and improves air circulation within the office.
- OPT* = Laminate or Whiteboard
- Panels will match corresponding Boulevard Panel heights.

| PRODUCT CODE | PRICE | | | SIZE/ H | INCHES | | | WEIGHT VOL | |
|-----------------|-------|-----|------|------------|--------|-----|-----|-----------------|--|
| | GR1 | GR2 | OPT* | | W | D | LBS | FT ³ | |
| BDPOF4224 | 253 | 268 | 283 | 42 | 24 | 1.3 | 9 | 1.32 | |
| BDPOF4230 | 271 | 284 | 301 | 42 | 30 | 1.3 | 12 | 1.62 | |
| BDPOF4236 | 313 | 342 | 372 | 42 | 36 | 1.3 | 15 | 1.94 | |
| BDPOF4242 | 328 | 354 | 385 | 42 | 42 | 1.3 | 17 | 2.24 | |
| BDPOF4248 | 343 | 372 | 404 | 42 | 48 | 1.3 | 19 | 2.55 | |
| BDPOF4254 | 361 | 388 | 418 | 42 | 54 | 1.3 | 22 | 2.85 | |
| BDPOF4260 | 373 | 404 | 433 | 42 | 60 | 1.3 | 24 | 3.16 | |
| BDPOF5424 | 319 | 349 | 378 | 54 | 24 | 1.3 | 12 | 1.62 | |
| BDPOF5430 | 340 | 369 | 398 | 54 | 30 | 1.3 | 15 | 2.08 | |
| BDPOF5436 | 406 | 462 | 522 | 54 | 36 | 1.3 | 18 | 2.47 | |
| BDPOF5442 | 425 | 483 | 543 | 54 | 42 | 1.3 | 21 | 2.85 | |
| BDPOF5448 | 446 | 503 | 563 | 54 | 48 | 1.3 | 24 | 3.25 | |
| BDPOF5454 | 464 | 521 | 581 | 54 | 54 | 1.3 | 27 | 3.63 | |
| BDPOF5460 | 484 | 542 | 603 | 54 | 60 | 1.3 | 30 | 4.02 | |

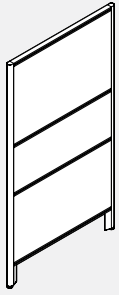
DPFRF • Fabric Bottom, Middle and Top Panel

- Fabric above, below and between the middle rails provides visual privacy.
- Full panel with additional rail at 42" high.
- Upper middle rail accepts Global Contract Accessories, Monitor Arm Support and Off-Module Shelves.
- OPT* = Laminate or Whiteboard

| PRODUCT CODE | PRICE | | | SIZE/ H | INCHES | | | WEIGHT VOL | |
|--------------|-------|-----|------|---------|--------|-----|-----|-----------------|--|
| | GR1 | GR2 | OPT* | | W | D | LBS | FT ³ | |
| DPFRF5024 | 509 | 553 | 607 | 50 | 24 | 1.3 | 16 | 1.62 | |
| DPFRF5030 | 537 | 569 | 604 | 50 | 30 | 1.3 | 21 | 2.08 | |
| DPFRF5036 | 563 | 621 | 681 | 50 | 36 | 1.3 | 25 | 2.47 | |
| DPFRF5042 | 591 | 658 | 731 | 50 | 42 | 1.3 | 30 | 2.85 | |
| DPFRF5048 | 621 | 705 | 796 | 50 | 48 | 1.3 | 35 | 3.25 | |
| DPFRF5054 | 645 | 727 | 823 | 50 | 54 | 1.3 | 40 | 3.63 | |
| DPFRF5060 | 672 | 774 | 879 | 50 | 60 | 1.3 | 45 | 4.02 | |
| DPFRF5424 | 509 | 553 | 607 | 54 | 24 | 1.3 | 18 | 1.62 | |
| DPFRF5430 | 537 | 569 | 604 | 54 | 30 | 1.3 | 23 | 2.08 | |
| DPFRF5436 | 563 | 621 | 681 | 54 | 36 | 1.3 | 27 | 2.47 | |
| DPFRF5442 | 591 | 658 | 731 | 54 | 42 | 1.3 | 32 | 2.85 | |
| DPFRF5448 | 621 | 705 | 796 | 54 | 48 | 1.3 | 37 | 3.25 | |
| DPFRF5454 | 645 | 727 | 823 | 54 | 54 | 1.3 | 42 | 3.63 | |
| DPFRF5460 | 672 | 757 | 850 | 54 | 60 | 1.3 | 47 | 4.02 | |
| DPFRF6624 | 553 | 607 | 659 | 66 | 24 | 1.3 | 23 | 2.04 | |
| DPFRF6630 | 586 | 638 | 692 | 66 | 30 | 1.3 | 29 | 2.52 | |
| DPFRF6636 | 619 | 701 | 794 | 66 | 36 | 1.3 | 35 | 3.00 | |
| DPFRF6642 | 652 | 747 | 850 | 66 | 42 | 1.3 | 41 | 3.46 | |
| DPFRF6648 | 678 | 775 | 877 | 66 | 48 | 1.3 | 47 | 3.93 | |
| DPFRF6654 | 707 | 809 | 917 | 66 | 54 | 1.3 | 53 | 4.40 | |
| DPFRF6660 | 736 | 879 | 1028 | 66 | 60 | 1.3 | 59 | 4.90 | |

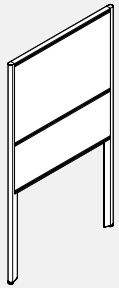
DPORF • Open Bottom Fabric Middle and Top Panel

- Fabric above the middle rail provides visual privacy.
- Open bottom panel with additional rail at 42" high.
- Upper middle rail accepts Global Contract Accessories, Monitor Arm Support and Off-Module Shelves.
- Open bottom reduces cost and improves air circulation within the office.
- OPT* = Laminate or Whiteboard

| PRODUCT CODE | PRICE | | | SIZE/ H | INCHES | | | WEIGHT VOL | |
|--------------|-------|-----|------|---------|--------|-----|-----|-----------------|--|
| | GR1 | GR2 | OPT* | | W | D | LBS | FT ³ | |
| DPORF5024 | 336 | 369 | 404 | 50 | 24 | 1.3 | 10 | 1.62 | |
| DPORF5030 | 354 | 389 | 422 | 50 | 30 | 1.3 | 13 | 2.08 | |
| DPORF5036 | 425 | 459 | 495 | 50 | 36 | 1.3 | 16 | 2.47 | |
| DPORF5042 | 446 | 488 | 540 | 50 | 42 | 1.3 | 19 | 2.85 | |
| DPORF5048 | 469 | 513 | 562 | 50 | 48 | 1.3 | 21 | 3.25 | |
| DPORF5054 | 486 | 535 | 580 | 50 | 54 | 1.3 | 25 | 3.63 | |
| DPORF5060 | 509 | 561 | 613 | 50 | 60 | 1.3 | 28 | 4.02 | |
| DPORF5424 | 336 | 369 | 404 | 54 | 24 | 1.3 | 12 | 1.62 | |
| DPORF5430 | 354 | 389 | 422 | 54 | 30 | 1.3 | 15 | 2.08 | |
| DPORF5436 | 425 | 459 | 495 | 54 | 36 | 1.3 | 18 | 2.47 | |
| DPORF5442 | 446 | 488 | 540 | 54 | 42 | 1.3 | 21 | 2.85 | |
| DPORF5448 | 469 | 513 | 562 | 54 | 48 | 1.3 | 24 | 3.25 | |
| DPORF5454 | 486 | 540 | 592 | 54 | 54 | 1.3 | 27 | 3.63 | |
| DPORF5460 | 509 | 561 | 613 | 54 | 60 | 1.3 | 30 | 4.02 | |
| DPORF6624 | 409 | 454 | 503 | 66 | 24 | 1.3 | 17 | 2.04 | |
| DPORF6630 | 434 | 480 | 527 | 66 | 30 | 1.3 | 21 | 2.52 | |
| DPORF6636 | 512 | 584 | 661 | 66 | 36 | 1.3 | 25 | 3.00 | |
| DPORF6642 | 562 | 641 | 724 | 66 | 42 | 1.3 | 29 | 3.46 | |
| DPORF6648 | 589 | 660 | 741 | 66 | 48 | 1.3 | 33 | 3.93 | |
| DPORF6654 | 612 | 692 | 778 | 66 | 54 | 1.3 | 37 | 4.40 | |
| DPORF6660 | 636 | 712 | 788 | 66 | 60 | 1.3 | 41 | 4.90 | |

DPFFG • Fabric Bottom, Middle and Glazed Top Panel

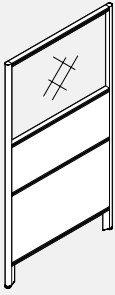

- Fabric below and between the middle rails provides visual privacy.
- Fabric bottom panel with additional rail at 28" high.
- Upper middle rail accepts Global Contract Accessories, Monitor Arm Support and Off-Module Shelves.
- Extruded aluminum frame surrounds acrylic glazing at top.
- PVC Extrusion is only Charcoal.
- For tempered glass, add "TG" to the end of the product code and add 20% to the price regardless of fabric grade.
- OPT* = Laminate or Whiteboard

| PRODUCT CODE | PRICE | | | SIZE/ H | INCHES | | | WEIGHT VOL | |
|--------------|-------|------|------|---------|--------|-----|-----|-----------------|--|
| | GR1 | GR2 | OPT* | | W | D | LBS | FT ³ | |
| DPFFG5024 | 513 | 546 | 580 | 50 | 24 | 1.3 | 12 | 1.62 | |
| DPFFG5030 | 562 | 593 | 629 | 50 | 30 | 1.3 | 15 | 2.08 | |
| DPFFG5036 | 610 | 682 | 757 | 50 | 36 | 1.3 | 18 | 2.47 | |
| DPFFG5042 | 659 | 731 | 806 | 50 | 42 | 1.3 | 21 | 2.85 | |
| DPFFG5048 | 709 | 779 | 853 | 50 | 48 | 1.3 | 24 | 3.25 | |
| DPFFG5054 | 759 | 830 | 907 | 50 | 54 | 1.3 | 27 | 3.63 | |
| DPFFG5060 | 824 | 892 | 963 | 50 | 60 | 1.3 | 30 | 4.02 | |
| DPFFG5424 | 513 | 546 | 580 | 54 | 24 | 1.3 | 17 | 1.62 | |
| DPFFG5430 | 562 | 593 | 629 | 54 | 30 | 1.3 | 21 | 2.08 | |
| DPFFG5436 | 610 | 682 | 757 | 54 | 36 | 1.3 | 25 | 2.47 | |
| DPFFG5442 | 659 | 731 | 806 | 54 | 42 | 1.3 | 29 | 2.85 | |
| DPFFG5448 | 709 | 779 | 853 | 54 | 48 | 1.3 | 33 | 3.25 | |
| DPFFG5454 | 759 | 830 | 907 | 54 | 54 | 1.3 | 37 | 3.63 | |
| DPFFG5460 | 824 | 894 | 970 | 54 | 60 | 1.3 | 41 | 4.02 | |
| DPFFG6624 | 608 | 665 | 724 | 66 | 24 | 1.3 | 20 | 2.04 | |
| DPFFG6630 | 673 | 731 | 791 | 66 | 30 | 1.3 | 25 | 2.52 | |
| DPFFG6636 | 741 | 814 | 893 | 66 | 36 | 1.3 | 30 | 3.00 | |
| DPFFG6642 | 809 | 883 | 960 | 66 | 42 | 1.3 | 35 | 3.46 | |
| DPFFG6648 | 877 | 951 | 1028 | 66 | 48 | 1.3 | 40 | 3.93 | |
| DPFFG6654 | 942 | 1017 | 1094 | 66 | 54 | 1.3 | 45 | 4.40 | |
| DPFFG6660 | 1024 | 1108 | 1200 | 66 | 60 | 1.3 | 50 | 4.90 | |

DPOFG • Open Bottom, Middle Fabric and Glazed Top Panel

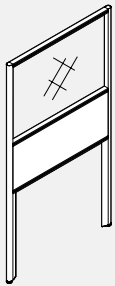

- Fabric between the middle rails.
- Open bottom panel with additional rail at 42" high.
- Upper middle rail accepts Global Contract Accessories, Monitor Arm Support and Off-Module Shelves.
- Extruded aluminum frame surrounds acrylic glazing at top.
- PVC Extrusion is only Charcoal.
- For tempered glass, add "TG" to the end of the product code and add 20% to the price regardless of fabric grade.
- OPT* = Laminate or Whiteboard

| PRODUCT CODE | PRICE | | | SIZE/ H | INCHES | | | WEIGHT VOL | |
|--------------|-------|-----|------|---------|--------|-----|-----|-----------------|--|
| | GR1 | GR2 | OPT* | | W | D | LBS | FT ³ | |
| DPOFG5024 | 405 | 418 | 433 | 50 | 24 | 1.3 | 14 | 1.62 | |
| DPOFG5030 | 442 | 455 | 472 | 50 | 30 | 1.3 | 17 | 2.08 | |
| DPOFG5036 | 478 | 490 | 508 | 50 | 36 | 1.3 | 20 | 2.47 | |
| DPOFG5042 | 517 | 534 | 546 | 50 | 42 | 1.3 | 24 | 2.85 | |
| DPOFG5048 | 553 | 569 | 582 | 50 | 48 | 1.3 | 27 | 3.25 | |
| DPOFG5054 | 592 | 622 | 653 | 50 | 54 | 1.3 | 30 | 3.63 | |
| DPOFG5060 | 636 | 665 | 694 | 50 | 60 | 1.3 | 34 | 4.02 | |
| DPOFG5424 | 405 | 418 | 433 | 54 | 24 | 1.3 | 14 | 1.62 | |
| DPOFG5430 | 442 | 455 | 472 | 54 | 30 | 1.3 | 17 | 2.08 | |
| DPOFG5436 | 478 | 490 | 508 | 54 | 36 | 1.3 | 20 | 2.47 | |
| DPOFG5442 | 517 | 534 | 546 | 54 | 42 | 1.3 | 24 | 2.85 | |
| DPOFG5448 | 553 | 569 | 582 | 54 | 48 | 1.3 | 27 | 3.25 | |
| DPOFG5454 | 592 | 622 | 653 | 54 | 54 | 1.3 | 30 | 3.63 | |
| DPOFG5460 | 636 | 665 | 694 | 54 | 60 | 1.3 | 34 | 4.02 | |
| DPOFG6624 | 505 | 517 | 535 | 66 | 24 | 1.3 | 17 | 2.04 | |
| DPOFG6630 | 561 | 574 | 589 | 66 | 30 | 1.3 | 21 | 2.52 | |
| DPOFG6636 | 619 | 647 | 678 | 66 | 36 | 1.3 | 25 | 3.00 | |
| DPOFG6642 | 659 | 689 | 720 | 66 | 42 | 1.3 | 29 | 3.46 | |
| DPOFG6648 | 718 | 747 | 778 | 66 | 48 | 1.3 | 33 | 3.93 | |
| DPOFG6654 | 773 | 800 | 829 | 66 | 54 | 1.3 | 37 | 4.40 | |
| DPOFG6660 | 833 | 863 | 893 | 66 | 60 | 1.3 | 41 | 4.90 | |

DPFG • Fabric Bottom and Glazed Top Panel

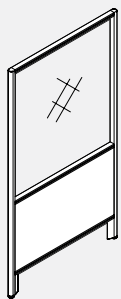

- **Fabric between the middle rails.**
- Open bottom panel with additional rail at 42" high.
- Upper middle rail accepts Global Contract Accessories, Monitor Arm Support and Off-Module Shelves.
- Open bottom reduces cost and improves air circulation within the office.
- Extruded aluminum frame surrounds acrylic glazing at top.
- PVC Extrusion is only Charcoal.
- For tempered glass, add "TG" to the end of the product code and add 20% to the price regardless of fabric grade.
- OPT* = Laminate or Whiteboard

| PRODUCT CODE | PRICE | | | SIZE/ INCHES | | | WEIGHT VOL | |
|--------------|-------|------|------|--------------|----|-----|------------|------|
| | GR1 | GR2 | OPT* | H | W | D | LBS | FT³ |
| DPFG4224 | 555 | 575 | 595 | 42 | 24 | 1.3 | 11 | 1.32 |
| DPFG4230 | 603 | 621 | 641 | 42 | 30 | 1.3 | 14 | 1.62 |
| DPFG4236 | 655 | 672 | 693 | 42 | 36 | 1.3 | 16 | 1.94 |
| DPFG4242 | 697 | 755 | 816 | 42 | 42 | 1.3 | 18 | 2.24 |
| DPFG4248 | 746 | 802 | 863 | 42 | 48 | 1.3 | 21 | 2.55 |
| DPFG4254 | 796 | 853 | 915 | 42 | 54 | 1.3 | 23 | 2.85 |
| DPFG4260 | 842 | 897 | 959 | 42 | 60 | 1.3 | 26 | 3.16 |
| DPFG5024 | 671 | 689 | 712 | 50 | 24 | 1.3 | 12 | 1.62 |
| DPFG5030 | 724 | 745 | 763 | 50 | 30 | 1.3 | 15 | 2.08 |
| DPFG5036 | 774 | 790 | 812 | 50 | 36 | 1.3 | 18 | 2.47 |
| DPFG5042 | 826 | 884 | 943 | 50 | 42 | 1.3 | 21 | 2.85 |
| DPFG5048 | 874 | 931 | 994 | 50 | 48 | 1.3 | 24 | 3.25 |
| DPFG5054 | 926 | 984 | 1043 | 50 | 54 | 1.3 | 27 | 3.63 |
| DPFG5060 | 976 | 1034 | 1094 | 50 | 60 | 1.3 | 29 | 4.02 |
| DPFG5424 | 671 | 689 | 712 | 54 | 24 | 1.3 | 13 | 1.62 |
| DPFG5430 | 724 | 745 | 763 | 54 | 30 | 1.3 | 16 | 2.08 |
| DPFG5436 | 774 | 790 | 812 | 54 | 36 | 1.3 | 20 | 2.47 |
| DPFG5442 | 826 | 884 | 943 | 54 | 42 | 1.3 | 23 | 2.85 |
| DPFG5448 | 874 | 931 | 994 | 54 | 48 | 1.3 | 26 | 3.25 |
| DPFG5454 | 926 | 984 | 1043 | 54 | 54 | 1.3 | 29 | 3.63 |
| DPFG5460 | 976 | 1034 | 1094 | 54 | 60 | 1.3 | 32 | 4.02 |
| DPFG6624 | 727 | 748 | 770 | 66 | 24 | 1.3 | 17 | 2.04 |
| DPFG6630 | 784 | 802 | 824 | 66 | 30 | 1.3 | 21 | 2.52 |
| DPFG6636 | 837 | 894 | 955 | 66 | 36 | 1.3 | 24 | 3.00 |
| DPFG6642 | 892 | 949 | 1007 | 66 | 42 | 1.3 | 28 | 3.46 |
| DPFG6648 | 943 | 1000 | 1062 | 66 | 48 | 1.3 | 32 | 3.93 |
| DPFG6654 | 999 | 1057 | 1118 | 66 | 54 | 1.3 | 36 | 4.40 |
| DPFG6660 | 1056 | 1113 | 1173 | 66 | 60 | 1.3 | 40 | 4.90 |

DPFS • Fabric Bottom Slat Top Panel

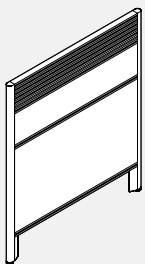

- **Integrated 6" slat rail provides flexibility of use.**
- Panel integrated slat rail accepts Global Contract Accessories, Monitor Arm Support, Off-Module Shelves, Task Light Bracket and Power Bar.
- OPT* = Laminate or Whiteboard

| PRODUCT CODE | PRICE | | | SIZE/ INCHES | | | WEIGHT VOL | |
|--------------|-------|-----|------|--------------|----|-----|------------|------|
| | GR1 | GR2 | OPT* | H | W | D | LBS | FT³ |
| DPFS4224 | 397 | 421 | 450 | 42 | 24 | 1.3 | 19 | 1.32 |
| DPFS4230 | 484 | 510 | 539 | 42 | 30 | 1.3 | 23 | 1.62 |
| DPFS4236 | 540 | 609 | 686 | 42 | 36 | 1.3 | 28 | 1.94 |
| DPFS4242 | 589 | 658 | 734 | 42 | 42 | 1.3 | 33 | 2.24 |
| DPFS4248 | 634 | 707 | 781 | 42 | 48 | 1.3 | 37 | 2.55 |
| DPFS4254 | 687 | 757 | 831 | 42 | 54 | 1.3 | 42 | 2.85 |
| DPFS4260 | 733 | 804 | 880 | 42 | 60 | 1.3 | 47 | 3.16 |

DPFSF • Fabric Bottom, Slat Middle and Fabric Top Panel

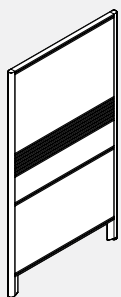

- **Integrated 6" slat rail between the middle rails provides flexibility of use. Fabric at the top provides visual privacy.**
- Panel integrated slat rail accepts Global Contract Accessories, Monitor Arm Support, Off-Module Shelves, Task Light Bracket and Power Bar.
- OPT* = Laminate or Whiteboard

| PRODUCT CODE | PRICE | | | SIZE/ INCHES | | | WEIGHT VOL | |
|--------------|-------|------|------|--------------|----|-----|------------|------|
| | GR1 | GR2 | OPT* | H | W | D | LBS | FT³ |
| DPFSF5024 | 551 | 578 | 605 | 50 | 24 | 1.3 | 21 | 1.62 |
| DPFSF5030 | 610 | 636 | 661 | 50 | 30 | 1.3 | 28 | 2.08 |
| DPFSF5036 | 671 | 744 | 817 | 50 | 36 | 1.3 | 34 | 2.47 |
| DPFSF5042 | 727 | 801 | 877 | 50 | 42 | 1.3 | 40 | 2.85 |
| DPFSF5048 | 790 | 862 | 936 | 50 | 48 | 1.3 | 46 | 3.25 |
| DPFSF5054 | 845 | 916 | 992 | 50 | 54 | 1.3 | 52 | 3.63 |
| DPFSF5060 | 903 | 973 | 1051 | 50 | 60 | 1.3 | 58 | 4.02 |
| DPFSF5424 | 551 | 578 | 605 | 54 | 24 | 1.3 | 23 | 1.62 |
| DPFSF5430 | 610 | 636 | 661 | 54 | 30 | 1.3 | 30 | 2.08 |
| DPFSF5436 | 671 | 744 | 817 | 54 | 36 | 1.3 | 36 | 2.47 |
| DPFSF5442 | 727 | 801 | 877 | 54 | 42 | 1.3 | 42 | 2.85 |
| DPFSF5448 | 790 | 862 | 936 | 54 | 48 | 1.3 | 48 | 3.25 |
| DPFSF5454 | 845 | 916 | 992 | 54 | 54 | 1.3 | 54 | 3.63 |
| DPFSF5460 | 903 | 973 | 1051 | 54 | 60 | 1.3 | 60 | 4.02 |
| DPFSF6624 | 633 | 681 | 731 | 66 | 24 | 1.3 | 28 | 2.04 |
| DPFSF6630 | 695 | 745 | 794 | 66 | 30 | 1.3 | 35 | 2.52 |
| DPFSF6636 | 763 | 879 | 998 | 66 | 36 | 1.3 | 42 | 3.00 |
| DPFSF6642 | 826 | 938 | 1061 | 66 | 42 | 1.3 | 49 | 3.46 |
| DPFSF6648 | 888 | 1000 | 1122 | 66 | 48 | 1.3 | 56 | 3.93 |
| DPFSF6654 | 951 | 1063 | 1182 | 66 | 54 | 1.3 | 63 | 4.40 |
| DPFSF6660 | 1011 | 1123 | 1243 | 66 | 60 | 1.3 | 70 | 4.90 |

DPOSF • Open Bottom, Slat Middle Panel

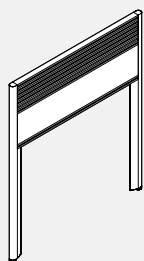

- Integrated 6" slat rail between the middle rails provides flexibility of use.
- Panel integrated slat rail accepts Global Contract Accessories, Monitor Arm Support, Off-Module Shelves, Task Light Bracket and Power Bar.
- OPT* = Laminate or Whiteboard

| PRODUCT CODE | PRICE | | | SIZE/ INCHES | | | WEIGHT VOL | |
|--------------|-------|-----|------|--------------|----|-----|------------|-----------------|
| | GR1 | GR2 | OPT* | H | W | D | LBS | FT ³ |
| DPOSF4224 | 355 | 366 | 371 | 42 | 24 | 1.3 | 12 | 1.32 |
| DPOSF4230 | 398 | 406 | 411 | 42 | 30 | 1.3 | 17 | 1.62 |
| DPOSF4236 | 441 | 454 | 471 | 42 | 36 | 1.3 | 24 | 1.94 |
| DPOSF4242 | 480 | 491 | 509 | 42 | 42 | 1.3 | 28 | 2.24 |
| DPOSF4248 | 522 | 539 | 551 | 42 | 48 | 1.3 | 36 | 2.55 |
| DPOSF4254 | 563 | 577 | 591 | 42 | 54 | 1.3 | 40 | 2.85 |
| DPOSF4260 | 603 | 614 | 630 | 42 | 60 | 1.3 | 44 | 3.16 |

DPOSF • Open Bottom, Slat Middle and Fabric Top Panel

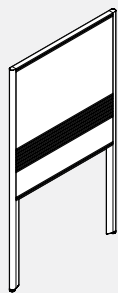

- Integrated 6" slat rail between the middle rails provides flexibility of use. Fabric above middle rail provides privacy.
- Panel integrated slat rail accepts Global Contract Accessories, Monitor Arm Support, Off-Module Shelves, Task Light Bracket and Power Bar.
- Open bottom reduces cost and improves air circulation within the office.
- OPT* = Laminate or Whiteboard

| PRODUCT CODE | PRICE | | | SIZE/ INCHES | | | WEIGHT VOL | |
|--------------|-------|-----|------|--------------|----|-----|------------|-----------------|
| | GR1 | GR2 | OPT* | H | W | D | LBS | FT ³ |
| DPOSF5024 | 475 | 494 | 517 | 50 | 24 | 1.3 | 13 | 1.62 |
| DPOSF5030 | 523 | 546 | 569 | 50 | 30 | 1.3 | 14 | 2.08 |
| DPOSF5036 | 574 | 614 | 659 | 50 | 36 | 1.3 | 21 | 2.47 |
| DPOSF5042 | 625 | 666 | 713 | 50 | 42 | 1.3 | 25 | 2.85 |
| DPOSF5048 | 672 | 715 | 759 | 50 | 48 | 1.3 | 29 | 3.25 |
| DPOSF5054 | 724 | 766 | 813 | 50 | 54 | 1.3 | 31 | 3.63 |
| DPOSF5060 | 774 | 814 | 860 | 50 | 60 | 1.3 | 35 | 4.02 |
| DPOSF5424 | 475 | 494 | 517 | 54 | 24 | 1.3 | 15 | 1.62 |
| DPOSF5430 | 523 | 546 | 569 | 54 | 30 | 1.3 | 19 | 2.08 |
| DPOSF5436 | 574 | 614 | 659 | 54 | 36 | 1.3 | 23 | 2.47 |
| DPOSF5442 | 625 | 666 | 713 | 54 | 42 | 1.3 | 27 | 2.85 |
| DPOSF5448 | 672 | 715 | 759 | 54 | 48 | 1.3 | 31 | 3.25 |
| DPOSF5454 | 724 | 766 | 813 | 54 | 54 | 1.3 | 34 | 3.63 |
| DPOSF5460 | 774 | 814 | 860 | 54 | 60 | 1.3 | 38 | 4.02 |
| DPOSF6624 | 557 | 592 | 630 | 66 | 24 | 1.3 | 18 | 2.04 |
| DPOSF6630 | 612 | 647 | 686 | 66 | 30 | 1.3 | 23 | 2.52 |
| DPOSF6636 | 665 | 736 | 812 | 66 | 36 | 1.3 | 28 | 3.00 |
| DPOSF6642 | 721 | 791 | 867 | 66 | 42 | 1.3 | 33 | 3.46 |
| DPOSF6648 | 775 | 857 | 951 | 66 | 48 | 1.3 | 38 | 3.93 |
| DPOSF6654 | 829 | 915 | 1004 | 66 | 54 | 1.3 | 43 | 4.40 |
| DPOSF6660 | 883 | 966 | 1060 | 66 | 60 | 1.3 | 47 | 4.90 |

DPOSG • Open Bottom, Slat Middle and Glazed Top Panel

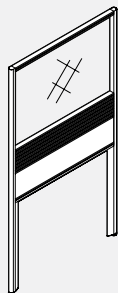

- Integrated 6" slat rail between the middle rails provides flexibility of use.
- Panel integrated slat rail accepts Global Contract Accessories, Monitor Arm Support, Off-Module Shelves, Task Light Bracket and Power Bar.
- Open bottom reduces cost and improves air circulation within the office.
- Extruded aluminum frame surrounds acrylic glazing at top.
- PVC Extrusion is only Charcoal.
- For tempered glass, add "TG" to the end of the product code and add 20% to the price regardless of fabric grade.
- OPT* = Laminate or Whiteboard

| PRODUCT CODE | PRICE | | | SIZE/ INCHES | | | WEIGHT VOL | |
|--------------|-------|------|------|--------------|----|-----|------------|-----------------|
| | GR1 | GR2 | OPT* | H | W | D | LBS | FT ³ |
| DPOSG5024 | 705 | 713 | 718 | 50 | 24 | 1.3 | 12 | 1.62 |
| DPOSG5030 | 759 | 766 | 775 | 50 | 30 | 1.3 | 15 | 2.08 |
| DPOSG5036 | 812 | 825 | 840 | 50 | 36 | 1.3 | 18 | 2.47 |
| DPOSG5042 | 867 | 882 | 895 | 50 | 42 | 1.3 | 22 | 2.85 |
| DPOSG5048 | 918 | 931 | 948 | 50 | 48 | 1.3 | 25 | 3.25 |
| DPOSG5054 | 972 | 986 | 1000 | 50 | 54 | 1.3 | 28 | 3.63 |
| DPOSG5060 | 1024 | 1037 | 1053 | 50 | 60 | 1.3 | 32 | 4.02 |
| DPOSG5424 | 705 | 713 | 718 | 54 | 24 | 1.3 | 14 | 1.62 |
| DPOSG5430 | 759 | 766 | 775 | 54 | 30 | 1.3 | 17 | 2.08 |
| DPOSG5436 | 812 | 825 | 840 | 54 | 36 | 1.3 | 20 | 2.47 |
| DPOSG5442 | 867 | 882 | 895 | 54 | 42 | 1.3 | 24 | 2.85 |
| DPOSG5448 | 918 | 931 | 948 | 54 | 48 | 1.3 | 27 | 3.25 |
| DPOSG5454 | 972 | 986 | 1000 | 54 | 54 | 1.3 | 30 | 3.63 |
| DPOSG5460 | 1024 | 1037 | 1053 | 54 | 60 | 1.3 | 34 | 4.02 |
| DPOSG6624 | 765 | 775 | 780 | 66 | 24 | 1.3 | 17 | 2.04 |
| DPOSG6630 | 824 | 830 | 837 | 66 | 30 | 1.3 | 21 | 2.52 |
| DPOSG6636 | 880 | 893 | 908 | 66 | 36 | 1.3 | 25 | 3.00 |
| DPOSG6642 | 936 | 951 | 964 | 66 | 42 | 1.3 | 29 | 3.46 |
| DPOSG6648 | 992 | 1003 | 1021 | 66 | 48 | 1.3 | 33 | 3.93 |
| DPOSG6654 | 1051 | 1063 | 1079 | 66 | 54 | 1.3 | 37 | 4.40 |
| DPOSG6660 | 1108 | 1122 | 1137 | 66 | 60 | 1.3 | 41 | 4.90 |

DPFSG • Fabric Bottom, Slat Middle and Glazed Top Panel

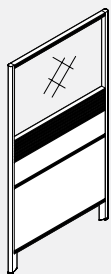

- **Integrated 6" slat rail provides flexibility of use.**
- Panel integrated slat rail accepts Global Contract Accessories, Monitor Arm Support, Off-Module Shelves, Task Light Bracket and Power Bar.
- Extruded aluminum frame surrounds acrylic glazing at top.
- PVC Extrusion is only Charcoal.
- For tempered glass, add "TG" to the end of the product code and add 20% to the price regardless of fabric grade.
- OPT* = Laminate or Whiteboard

| PRODUCT CODE | PRICE | | | SIZE/ INCHES | | | WEIGHT VOL | |
|--------------|-------|------|------|--------------|----|-----|------------|-----------------|
| | GR1 | GR2 | OPT* | H | W | D | LBS | FT ³ |
| DPFSG5024 | 774 | 797 | 825 | 50 | 24 | 1.3 | 15 | 1.62 |
| DPFSG5030 | 831 | 857 | 885 | 50 | 30 | 1.3 | 19 | 2.08 |
| DPFSG5036 | 892 | 962 | 1037 | 50 | 36 | 1.3 | 23 | 2.47 |
| DPFSG5042 | 951 | 1022 | 1095 | 50 | 42 | 1.3 | 27 | 2.85 |
| DPFSG5048 | 1004 | 1078 | 1153 | 50 | 48 | 1.3 | 31 | 3.25 |
| DPFSG5054 | 1063 | 1134 | 1209 | 50 | 54 | 1.3 | 35 | 3.63 |
| DPFSG5060 | 1122 | 1194 | 1267 | 50 | 60 | 1.3 | 39 | 4.02 |
| DPFSG5424 | 774 | 797 | 825 | 54 | 24 | 1.3 | 17 | 1.62 |
| DPFSG5430 | 831 | 857 | 885 | 54 | 30 | 1.3 | 21 | 2.08 |
| DPFSG5436 | 892 | 962 | 1037 | 54 | 36 | 1.3 | 25 | 2.47 |
| DPFSG5442 | 951 | 1022 | 1095 | 54 | 42 | 1.3 | 29 | 2.85 |
| DPFSG5448 | 1004 | 1078 | 1153 | 54 | 48 | 1.3 | 33 | 3.25 |
| DPFSG5454 | 1063 | 1134 | 1209 | 54 | 54 | 1.3 | 37 | 3.63 |
| DPFSG5460 | 1122 | 1194 | 1267 | 54 | 60 | 1.3 | 41 | 4.02 |
| DPFSG6624 | 840 | 865 | 893 | 66 | 24 | 1.3 | 20 | 2.04 |
| DPFSG6630 | 903 | 929 | 956 | 66 | 30 | 1.3 | 25 | 2.52 |
| DPFSG6636 | 962 | 1033 | 1108 | 66 | 36 | 1.3 | 30 | 3.00 |
| DPFSG6642 | 1024 | 1094 | 1170 | 66 | 42 | 1.3 | 35 | 3.46 |
| DPFSG6648 | 1088 | 1157 | 1234 | 66 | 48 | 1.3 | 40 | 3.93 |
| DPFSG6654 | 1147 | 1218 | 1294 | 66 | 54 | 1.3 | 45 | 4.40 |
| DPFSG6660 | 1212 | 1286 | 1360 | 66 | 60 | 1.3 | 50 | 4.90 |

DPOPF • Diet Over Panel

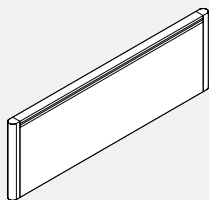

- **Over Panels attach to regular Diet Panels to provide additional visual privacy.**
- Over Panel is secured to regular Diet Panels with 4 brackets and set screws.
- Accessory loading capabilities only.
- Not for use with overhead storage.
- OPT* = Laminate or Whiteboard

| PRODUCT CODE | PRICE | | | SIZE/ INCHES | | | WEIGHT VOL | |
|--------------|-------|-----|------|--------------|----|-----|------------|-----------------|
| | GR1 | GR2 | OPT* | H | W | D | LBS | FT ³ |
| DPOPF1224 | 210 | 224 | 238 | 12 | 24 | 1.3 | 5 | 0.30 |
| DPOPF1230 | 239 | 252 | 268 | 12 | 30 | 1.3 | 7 | 0.60 |
| DPOPF1236 | 270 | 299 | 329 | 12 | 36 | 1.3 | 8 | 0.75 |
| DPOPF1242 | 293 | 320 | 351 | 12 | 42 | 1.3 | 9 | 0.88 |
| DPOPF1248 | 324 | 352 | 383 | 12 | 48 | 1.3 | 11 | 1.00 |
| DPOPF1254 | 354 | 384 | 415 | 12 | 54 | 1.3 | 12 | 1.13 |
| DPOPF1260 | 377 | 406 | 435 | 12 | 60 | 1.3 | 13 | 1.25 |
| DPOPF2424 | 291 | 319 | 350 | 24 | 24 | 1.3 | 10 | 1.00 |
| DPOPF2430 | 317 | 344 | 375 | 24 | 30 | 1.3 | 14 | 1.25 |
| DPOPF2436 | 339 | 380 | 425 | 24 | 36 | 1.3 | 16 | 1.45 |
| DPOPF2442 | 361 | 401 | 448 | 24 | 42 | 1.3 | 18 | 1.75 |
| DPOPF2448 | 383 | 425 | 472 | 24 | 48 | 1.3 | 22 | 2.00 |
| DPOPF2454 | 406 | 449 | 491 | 24 | 54 | 1.3 | 24 | 2.25 |
| DPOPF2460 | 431 | 473 | 517 | 24 | 60 | 1.3 | 26 | 2.50 |

DTMPP • Table Mounted Diet Panels

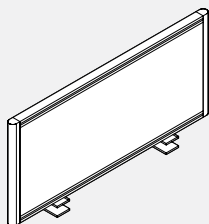

- **Creates privacy and flexibility at the end of work-surfaces.**
- Side Panels for sides of Viceversa® Tables or sides of work-surfaces available 24", and 36" widths (nominal width).
- Back Panels for sides of Viceversa® Tables available 48", 54" and 60" widths.
- Attaches with similar clamp to other clamp on accessories.
- Non tackable, non load-bearing, no hang on capabilities and not for use with transaction tops.
- Not for use with Licence product due to interference of gables and flush modesties.
- OPT* = Laminate or Whiteboard

| PRODUCT CODE | PRICE | | | SIZE/ INCHES | | | WEIGHT VOL | |
|--------------------|-------|-----|------|--------------|----|-----|------------|-----------------|
| | GR1 | GR2 | OPT* | H | W | D | LBS | FT ³ |
| SIDE PANELS | | | | | | | | |
| DTMPP24 | 231 | 241 | 260 | 16.5 | 21 | 1.3 | 7 | 0.75 |
| DTMPP30 | 247 | 262 | 276 | 16.5 | 27 | 1.3 | 8 | 0.94 |
| DTMPP36 | 265 | 295 | 324 | 16.5 | 33 | 1.3 | 10 | 1.13 |
| BACK PANELS | | | | | | | | |
| DTMPP48 | 293 | 320 | 351 | 16.5 | 48 | 1.3 | 15 | 1.53 |
| DTMPP54 | 320 | 350 | 380 | 16.5 | 54 | 1.3 | 17 | 1.72 |
| DTMPP60 | 350 | 378 | 409 | 16.5 | 60 | 1.3 | 18 | 1.91 |

DPCBM • Panel Cable Manager

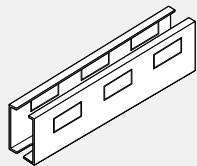

- Provides wire management for the Diet Panels.
- Extruded, dual durometer "U" channel organizes cables below panels.
- Snaps into bottom rail and into mid rail on open bottom panels.
- One data partial knock-out (2.67" wide x 1.36" high) provided on either side of the Raceway Cover accommodates terminal plates from various vendors.
- Panel Cable Manager comes in charcoal only.

| PRODUCT CODE | PRICE | SIZE/ INCHES | | | WEIGHT VOL | |
|--------------|-------|--------------|----|-----|------------|-----------------|
| | | H | W | D | LBS | FT ³ |
| DPCBM24 | 16 | 4 | 18 | 1.3 | 1.3 | 0.07 |
| DPCBM30 | 24 | 4 | 24 | 1.3 | 1.4 | 0.08 |
| DPCBM36 | 26 | 4 | 30 | 1.3 | 1.5 | 0.10 |
| DPCBM42 | 29 | 4 | 36 | 1.3 | 1.6 | 0.13 |
| DPCBM48 | 31 | 4 | 42 | 1.3 | 1.7 | 0.15 |
| DPCBM54 | 35 | 4 | 48 | 1.3 | 1.8 | 0.16 |
| DPCBM60 | 37 | 4 | 54 | 1.3 | 1.9 | 0.19 |

DPOFM • Off Module Panel Connector

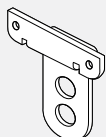

- Connects two perpendicular Diet Panels Off-Module.
- Top and bottom brackets bolt to Diet Panel verticals and engage to top and bottom rails of adjacent, perpendicular panel of even or lower height.
- Connectors can also be used to connect a panel in the middle of perpendicular DPFRR, DPORF, DPFFG, DPFSG ad DPFSF at their 42" height secondary middle rail.
- Top and bottom brackets fit in place of standard hinge connectors.
- All fasteners included.

| PRODUCT CODE | PRICE | SIZE/ INCHES | | | WEIGHT VOL | |
|--------------|-------|--------------|---|---|------------|-----------------|
| | | H | W | D | LBS | FT ³ |
| DPOFM | 60 | 4 | 3 | 2 | 1 | 0.08 |

DPPWA • Wall Adapter

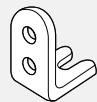
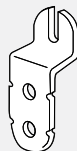

- Connects Diet Panels to walls.
- Bolts to Diet Panel vertical in place of the standard hinge connectors.
- Keyhole openings in Diet adapter slide over fasteners pre-installed to the wall.
- All fasteners included, however, the mounting hardware to affix adapter to wall not included, they will be based on type of wall material.

| PRODUCT CODE | PRICE | SIZE/ INCHES | | | WEIGHT VOL | |
|--------------|-------|--------------|-----|---|------------|-----------------|
| | | H | W | D | LBS | FT ³ |
| DPPWA | 43 | 40 | 2.5 | | 1 | 0.08 |

DPCSTR • Casters

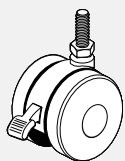

- Changes a freestanding Diet Panel to mobile.
- Must be used on two panels or more.
- Order 1 caster more than the number of panels. (Using only 1 caster where panels connect.) For example, 3 panels, 4 casters or 2 panels, 3 casters.
- Casters raise Diet Panels by a height of 1.1".

| PRODUCT CODE | PRICE | SIZE/ INCHES | | | WEIGHT VOL | |
|--------------|-------|--------------|-----|-----|------------|-----------------|
| | | H | W | D | LBS | FT ³ |
| DPCSTR | 12 | 1.5 | 1.5 | 1.5 | .25 | 1.02 |

DPLTSBKIT • Telescopic Sliding Kit

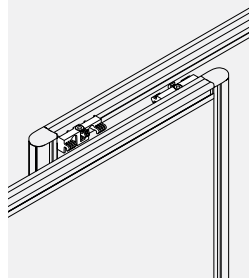

- Diet Telescopic Sliding Kit flexibly connects two standard parallel Diet panels and forms a length-adjustable partition.
- Kit consists of two top and two bottom sliding box assemblies and all the necessary connecting hardware.
- Made of black injection molded resin.
- The panels must be of the same height and equipped with top and bottom standard Diet extrusions.
- The kit can be installed as right or left on site, determining the direction of nesting/sliding.
- The kit offsets the parallel panel and the resulting gap is 12.5mm (½")
- Up to three standard Diet panels can be connected to form the length-adjustable partition.
- The kit is not intended to be used in place of a sliding door.
- The kit cannot be used with Diet overpanels or Diet Linking Panels.

| PRODUCT CODE | PRICE | SIZE/ INCHES | | | WEIGHT VOL | |
|--------------|-------|--------------|---|-----|------------|-----------------|
| | | H | W | D | LBS | FT ³ |
| DPLTSBKIT | 78 | 0.75 | 3 | 0.5 | 0.04 | 0.15 |

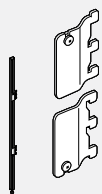
DBSCB • Diet to Boulevard Slot Connector

- Connects a Diet Panel to a Boulevard Panel via slots eliminating the need for the Boulevard Post and reducing the overall length and cost of a panel run.
- Connector can be installed in left or right configuration.
- Comes as a pair (Upper and lower brackets).
- Worksurfaces should be ordered based on application keeping in mind that this connector will align to the left or right of the end of the Boulevard Panel.
- Application drawings and layout must be provided for specials.

| PRODUCT CODE | PRICE | SIZE/ INCHES | | | WEIGHT VOL | |
|--------------|-------|--------------|-----|------|------------|-----------------|
| | | H | W | D | LBS | FT ³ |
| DBSCB02 | 58 | 3 | 0.5 | 00.0 | 1 | 0.05 |

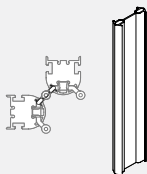
DAPPF • Diet Gap Filler

- Closes the gap between panels.
- Must be used on two or more panels.
- Order 1 DAPPF36 for a 42" high panel, 1 DAPPF36 and 1 DAPPF12 for a 54" high panel, or 1 DAPPF36 and 2 DAPPF12 for 66" high panel.

| PRODUCT CODE | PRICE | SIZE/ INCHES | | | WEIGHT VOL | |
|--------------|-------|--------------|---|---|------------|-----------------|
| | | H | W | D | LBS | FT ³ |
| DAPPF12 | 10 | 11.5 | | | | |
| DAPPF36 | 23 | 36.33 | | | | |

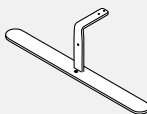
DHFFA • Single Flat Foot

- Used to create a freestanding panel
- Foot is flat to the floor with no adjustable glides
- No load capabilities on freestanding panel
- Only for use with Fabric Bottom panels
- Can be used to retro fit existing Diet panels on site
- Not for use with Diet Linking Panels
- Specify standard panel frame paint finishes

| PRODUCT CODE | PRICE | SIZE/ INCHES | | | WEIGHT VOL | |
|--------------|-------|--------------|----|---|------------|-----------------|
| | | H | W | D | LBS | FT ³ |
| DHFFA | 100 | 6 | 20 | 2 | 3.48 | 0.15 |

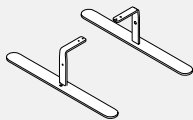
DHFFA02 • Flat Foot Kit

- Used to create a freestanding panel
- Feet are flat to the floor with no adjustable glides
- No load capabilities on freestanding panel
- Cannot be used with open bottom panels or Linking Panels.
- Can be used to retro fit existing Diet panels on site
- Not for use with Diet Linking Panels
- Specify standard panel frame paint finishes

| PRODUCT CODE | PRICE | SIZE/ INCHES | | | WEIGHT VOL | |
|--------------|-------|--------------|----|---|------------|-----------------|
| | | H | W | D | LBS | FT ³ |
| DHFFA02 | 197 | 6 | 20 | 2 | 7 | 0.3 |

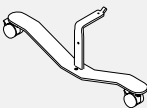
DHCFAN • Single Caster Foot

- Used to create a mobile panel
- Casters are locking
- No load capabilities on mobile panel
- Only for use with Fabric Bottom panels
- Can be used to retro fit existing Diet panels on site
- Not for use with Diet Linking Panels
- Specify standard panel frame paint finishes

| PRODUCT CODE | PRICE | SIZE/ INCHES | | | WEIGHT VOL | |
|--------------|-------|--------------|----|---|------------|-----------------|
| | | H | W | D | LBS | FT ³ |
| DHCFAN | 131 | 6 | 20 | 2 | 3.87 | 0.15 |

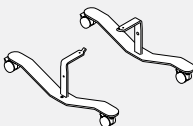
DHCFAN02 • Caster Foot Kit

- Used to create a mobile panel
- Casters are locking
- No load capabilities on mobile panel
- Only for use with Fabric Bottom panels
- Can be used to retro fit existing Diet panels on site
- Not for use with Diet Linking Panels
- Specify standard panel frame paint finishes

| PRODUCT CODE | PRICE | SIZE/ INCHES | | | WEIGHT VOL | |
|--------------|-------|--------------|----|---|------------|-----------------|
| | | H | W | D | LBS | FT ³ |
| DHCFAN02 | 261 | 6 | 20 | 2 | 7.7 | 0.3 |

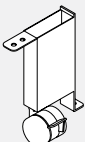
DHCFAL01 • Diet Caster Assembly Kit

- To be used on one side to create a mobile panel with DHCFAN on the other side.
- Caster is locking.
- No load capabilities on mobile panel
- Only for use with Fabric Bottom panels.
- Can be used to retrofit existing Diet panels on site.
- Not for use with Diet Linking Panels.
- Specigy standard panel frame paint finishes.

| PRODUCT CODE | PRICE | SIZE/ INCHES | | | WEIGHT VOL | |
|--------------|-------|--------------|---|-----|------------|-----------------|
| | | H | W | D | LBS | FT ³ |
| DHCFAL01 | 63 | 6 | 1 | 4.8 | 1 | 0.02 |

DB-P-X • Diet to Boulevard Slim Connector in "X" Configuration

- Creates a perpendicular connection between Diet Panel and Boulevard Panel that eliminates the need for special sized worksurfaces.
- Note: For use with new BDPFF & BDPOF panels.

Diet to Boulevard 1 "X" Configuration

| PRODUCT CODE | PRICE | B1 HEIGHT | DIET PANEL HEIGHT | SIZE/ H | INCHES W | D | WEIGHT LBS | VOL FT ³ |
|--------------|-------|-----------|-------------------|---------|----------|-----|------------|---------------------|
| BDB1P4242X | 132 | 42" | 42" | 42 | 1.3 | 2.6 | 4 | 0.207 |
| BDB1P4250X | 147 | 50" | 42" | 50 | 1.3 | 2.6 | 5 | 0.245 |
| BDB1P4254X | 156 | 54" | 42" | 54 | 1.3 | 2.6 | 5 | 0.264 |
| BDB1P4258X | 162 | 58" | 42" | 58 | 1.3 | 2.6 | 6 | 0.283 |
| BDB1P4266X | 178 | 66" | 42" | 66 | 1.3 | 2.6 | 7 | 0.322 |
| BDB1P4274X | 194 | 74" | 42" | 74 | 1.3 | 2.6 | 8 | 0.360 |
| BDB1P4282X | 208 | 82" | 42" | 82 | 1.3 | 2.6 | 9 | 0.399 |
| BDB1P5050X | 178 | 50" | 50" | 50 | 1.3 | 2.6 | 5 | 0.245 |
| BDB1P5054X | 178 | 54" | 50" | 54 | 1.3 | 2.6 | 5 | 0.264 |
| BDB1P5058X | 178 | 58" | 50" | 58 | 1.3 | 2.6 | 6 | 0.283 |
| BDB1P5066X | 178 | 66" | 50" | 66 | 1.3 | 2.6 | 7 | 0.322 |
| BDB1P5074X | 194 | 74" | 50" | 74 | 1.3 | 2.6 | 8 | 0.360 |
| BDB1P5082X | 208 | 82" | 50" | 82 | 1.3 | 2.6 | 9 | 0.399 |
| BDB1P5454X | 149 | 54" | 54" | 54 | 1.3 | 2.6 | 5 | 0.264 |
| BDB1P5458X | 162 | 58" | 54" | 58 | 1.3 | 2.6 | 6 | 0.283 |
| BDB1P5466X | 178 | 66" | 54" | 66 | 1.3 | 2.6 | 7 | 0.322 |
| BDB1P5474X | 194 | 74" | 54" | 74 | 1.3 | 2.6 | 8 | 0.360 |
| BDB1P5482X | 208 | 82" | 54" | 82 | 1.3 | 2.6 | 9 | 0.399 |
| BDB1P6666X | 178 | 66" | 66" | 66 | 1.3 | 2.6 | 7 | 0.322 |
| BDB1P6674X | 194 | 74" | 66" | 74 | 1.3 | 2.6 | 8 | 0.360 |
| BDB1P6682X | 208 | 82" | 66" | 82 | 1.3 | 2.6 | 9 | 0.399 |

Diet to System 3 "X" Configuration

| PRODUCT CODE | PRICE | SYSTEM 3 HEIGHT | DIET PANEL HEIGHT | SIZE/ H | INCHES W | D | WEIGHT LBS | VOL FT ³ |
|--------------|-------|-----------------|-------------------|---------|----------|-----|------------|---------------------|
| BDB3P4242X | 132 | 42" | 42" | 42 | 1.3 | 2.6 | 4 | 0.207 |
| BDB3P4250X | 147 | 50" | 42" | 50 | 1.3 | 2.6 | 5 | 0.245 |
| BDB3P4254X | 149 | 54" | 42" | 54 | 1.3 | 2.6 | 6 | 0.260 |
| BDB3P4266X | 178 | 66" | 42" | 66 | 1.3 | 2.6 | 7 | 0.322 |
| BDB3P5050X | 178 | 50" | 50" | 50 | 1.3 | 2.6 | 5 | 0.245 |
| BDB3P5054X | 149 | 54" | 50" | 54 | 1.3 | 2.6 | 6 | 0.260 |
| BDB3P5066X | 178 | 66" | 50" | 66 | 1.3 | 2.6 | 7 | 0.322 |
| BDB3P5454X | 149 | 54" | 54" | 54 | 1.3 | 2.6 | 6 | 0.260 |
| BDB3P5466X | 178 | 66" | 54" | 66 | 1.3 | 2.6 | 7 | 0.322 |
| BDB3P6666X | 178 | 66" | 66" | 66 | 1.3 | 2.6 | 7 | 0.322 |

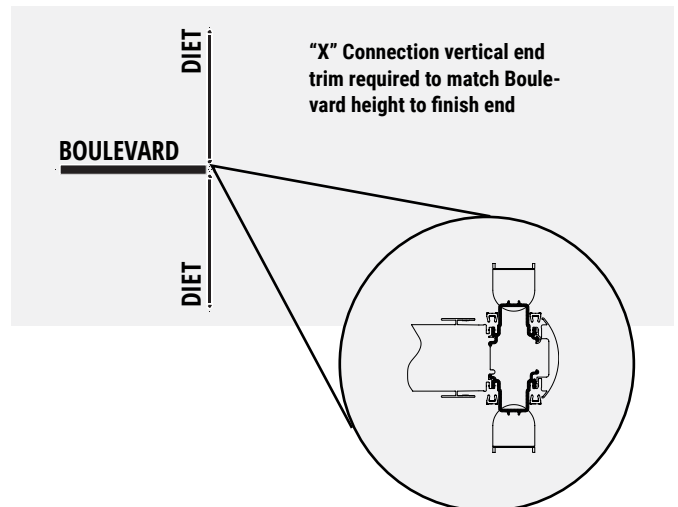
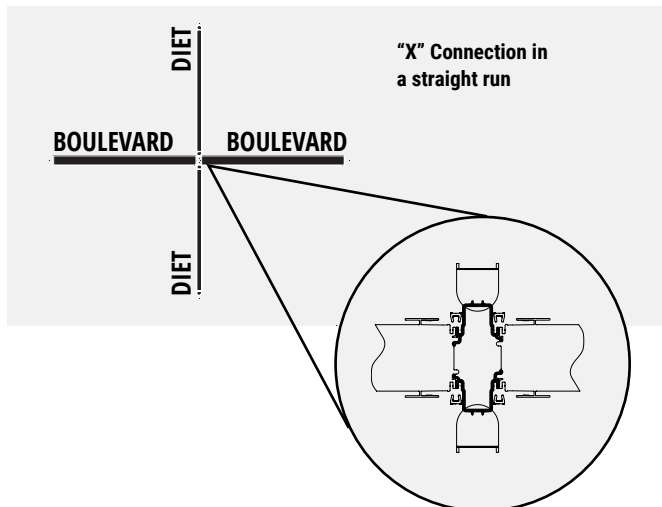

* Please specify separate end trim (round or flat) to close end.

DBXP-T • Diet to Boulevard Slim Connector in "T" Configuration

- Creates a perpendicular connection between Diet Panel and Boulevard Panel that eliminates the need for special sized worksurfaces.
- Note: For use with new BDPFF & BDPOF panels.

Diet to Boulevard 1 "T" Configuration

| PRODUCT CODE | PRICE | B1 HEIGHT | DIET PANEL HEIGHT | SIZE/ H | INCHES W | D | WEIGHT LBS | VOL FT ³ |
|--------------|-------|-----------|-------------------|---------|----------|-----|------------|---------------------|
| BDB1P4242T | 132 | 42" | 42" | 42 | 1.3 | 2.6 | 4 | 0.207 |
| BDB1P4250T | 147 | 50" | 42" | 50 | 1.3 | 2.6 | 5 | 0.245 |
| BDB1P4254T | 156 | 54" | 42" | 54 | 1.3 | 2.6 | 5 | 0.264 |
| BDB1P4258T | 162 | 58" | 42" | 58 | 1.3 | 2.6 | 6 | 0.283 |
| BDB1P4266T | 178 | 66" | 42" | 66 | 1.6 | 2.6 | 7 | 0.322 |
| BDB1P4274T | 194 | 74" | 42" | 74 | 1.3 | 2.6 | 8 | 0.360 |
| BDB1P4282T | 208 | 82" | 42" | 82 | 1.3 | 2.6 | 9 | 0.399 |
| BDB1P5050T | 178 | 50" | 50" | 50 | 1.3 | 2.6 | 5 | 0.245 |
| BDB1P5054T | 178 | 54" | 50" | 54 | 1.3 | 2.6 | 5 | 0.264 |
| BDB1P5058T | 178 | 58" | 50" | 58 | 1.3 | 2.6 | 6 | 0.283 |
| BDB1P5066T | 178 | 66" | 50" | 66 | 1.3 | 2.6 | 7 | 0.322 |
| BDB1P5074T | 194 | 74" | 50" | 74 | 1.3 | 2.6 | 8 | 0.360 |
| BDB1P5082T | 208 | 82" | 50" | 82 | 1.3 | 2.6 | 9 | 0.399 |
| BDB1P5454T | 149 | 54" | 54" | 54 | 1.3 | 2.6 | 6 | 0.245 |
| BDB1P5458T | 162 | 58" | 54" | 58 | 1.3 | 2.6 | 6 | 0.283 |
| BDB1P5466T | 178 | 66" | 54" | 66 | 1.3 | 2.6 | 7 | 0.322 |
| BDB1P5474T | 194 | 74" | 54" | 74 | 1.3 | 2.6 | 8 | 0.360 |
| BDB1P5482T | 208 | 82" | 54" | 82 | 1.3 | 2.6 | 9 | 0.399 |
| BDB1P6666T | 178 | 66" | 66" | 66 | 1.3 | 2.6 | 7 | 0.322 |
| BDB1P6674T | 194 | 74" | 66" | 74 | 1.3 | 2.6 | 8 | 0.360 |
| BDB1P6682T | 208 | 82" | 66" | 82 | 1.3 | 2.6 | 9 | 0.399 |

Diet to System 3 "T" Configuration

| PRODUCT CODE | PRICE | SYSTEM 3 HEIGHT | DIET PANEL HEIGHT | SIZE/ H | INCHES W | D | WEIGHT LBS | VOL FT ³ |
|--------------|-------|-----------------|-------------------|---------|----------|-----|------------|---------------------|
| BDB3P4242T | 132 | 42" | 42" | 42 | 1.3 | 2.6 | 4 | 0.207 |
| BDB3P4250T | 147 | 50" | 42" | 50 | 1.3 | 2.6 | 5 | 0.245 |
| BDB3P4254T | 149 | 54" | 42" | 54 | 1.3 | 2.6 | 6 | 0.245 |
| BDB3P4266T | 178 | 66" | 42" | 66 | 1.3 | 2.6 | 7 | 0.322 |
| BDB3P5050T | 178 | 50" | 50" | 50 | 1.3 | 2.6 | 5 | 0.245 |
| BDB3P5054T | 149 | 54" | 50" | 54 | 1.3 | 2.6 | 6 | 0.245 |
| BDB3P5066T | 178 | 66" | 50" | 66 | 1.3 | 2.6 | 7 | 0.322 |
| BDB3P5454T | 149 | 54" | 54" | 54 | 1.3 | 2.6 | 6 | 0.245 |
| BDB3P5466T | 178 | 66" | 54" | 66 | 1.3 | 2.6 | 7 | 0.322 |
| BDB3P6666T | 178 | 66" | 66" | 66 | 1.3 | 2.6 | 7 | 0.322 |

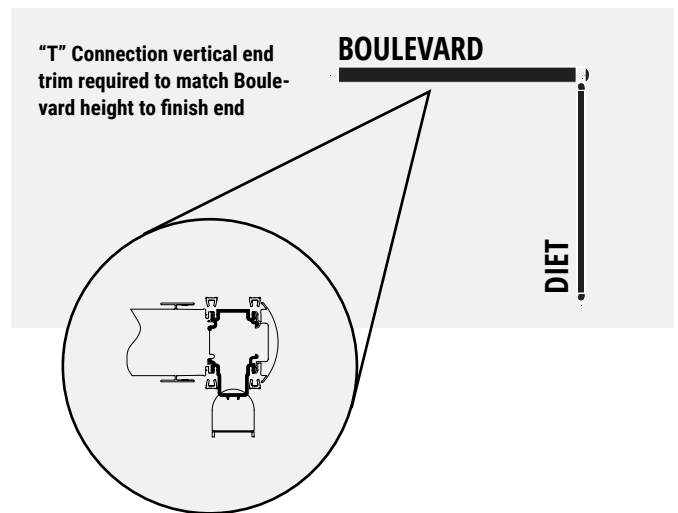
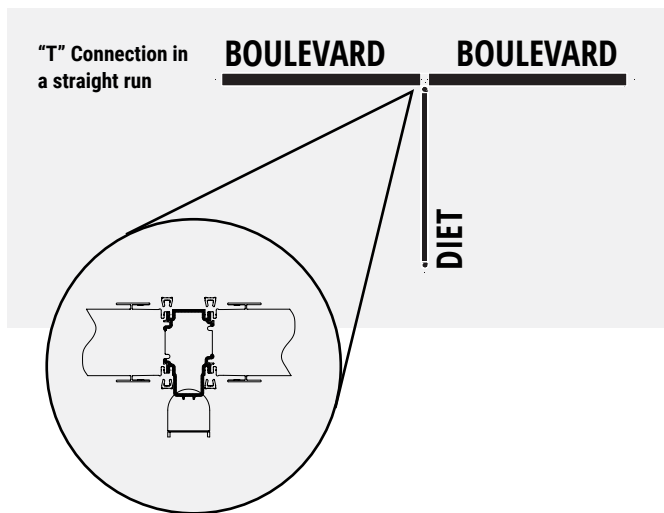

* Please specify separate end trim (round or flat) to close end.

DB-P-X • Diet to Boulevard Slim Connector in "X" Configuration

- Creates a perpendicular connection between Diet Panel and Boulevard Panel that eliminates the need for special sized worksurfaces.
- Note: For use with regular DP panels.

Diet to Boulevard 1 "X" Configuration

| PRODUCT CODE | PRICE | B1 HEIGHT | DIET PANEL HEIGHT | SIZE/ H | INCHES W | D | WEIGHT LBS | VOL FT ³ |
|--------------|-------|-----------|-------------------|---------|----------|-----|------------|---------------------|
| DB1P4242X | 132 | 42" | 42" | 42 | 1.3 | 2.6 | 4 | 0.207 |
| DB1P4250X | 147 | 50" | 42" | 50 | 1.3 | 2.6 | 5 | 0.245 |
| DB1P4254X | 159 | 54" | 42" | 54 | 1.3 | 2.6 | 6 | 0.266 |
| DB1P4266X | 178 | 66" | 42" | 66 | 1.3 | 2.6 | 7 | 0.322 |
| DB1P4274X | 194 | 74" | 42" | 74 | 1.3 | 2.6 | 8 | 0.360 |
| DB1P4282X | 208 | 82" | 42" | 82 | 1.3 | 2.6 | 9 | 0.399 |
| DB1P5050X | 178 | 50" | 50" | 50 | 1.3 | 2.6 | 5 | 0.245 |
| DB1P5054X | 178 | 54" | 50" | 54 | 1.3 | 2.6 | 6 | 0.266 |
| DB1P5058X | 178 | 58" | 50" | 58 | 1.3 | 2.6 | 6 | 0.283 |
| DB1P5066X | 178 | 66" | 50" | 66 | 1.3 | 2.6 | 7 | 0.322 |
| DB1P5074X | 194 | 74" | 50" | 74 | 1.3 | 2.6 | 8 | 0.360 |
| DB1P5082X | 208 | 82" | 50" | 82 | 1.3 | 2.6 | 9 | 0.399 |
| DB1P5458X | 162 | 58" | 54" | 58 | 1.3 | 2.6 | 6 | 0.283 |
| DB1P5466X | 178 | 66" | 54" | 66 | 1.3 | 2.6 | 7 | 0.322 |
| DB1P5474X | 194 | 74" | 54" | 74 | 1.3 | 2.6 | 8 | 0.360 |
| DB1P5482X | 208 | 82" | 54" | 82 | 1.3 | 2.6 | 9 | 0.399 |
| DB1P6666X | 178 | 66" | 66" | 66 | 1.3 | 2.6 | 7 | 0.322 |
| DB1P6674X | 194 | 74" | 66" | 74 | 1.3 | 2.6 | 8 | 0.360 |
| DB1P6682X | 208 | 82" | 66" | 82 | 1.3 | 2.6 | 9 | 0.399 |

Diet to System 3 "X" Configuration

| PRODUCT CODE | PRICE | SYSTEM 3 HEIGHT | DIET PANEL HEIGHT | SIZE/ H | INCHES W | D | WEIGHT LBS | VOL FT ³ |
|--------------|-------|-----------------|-------------------|---------|----------|-----|------------|---------------------|
| DB3P4242X | 132 | 42" | 42" | 42 | 1.3 | 2.6 | 4 | 0.207 |
| DB3P4250X | 147 | 50" | 42" | 50 | 1.3 | 2.6 | 5 | 0.245 |
| DB3P4266X | 178 | 66" | 42" | 66 | 1.3 | 2.6 | 7 | 0.322 |
| DB3P5050X | 178 | 50" | 50" | 50 | 1.3 | 2.6 | 5 | 0.245 |
| DB3P5066X | 178 | 66" | 50" | 66 | 1.3 | 2.6 | 7 | 0.322 |
| DB3P5466X | 178 | 66" | 54" | 66 | 1.3 | 2.6 | 7 | 0.322 |
| DB3P5454X | 178 | 54" | 54" | 54 | 1.3 | 2.6 | 6 | 0.266 |
| DB3P6666X | 178 | 66" | 66" | 66 | 1.3 | 2.6 | 7 | 0.322 |

Diet to Boulevard 1 Overpanels

| PRODUCT CODE | PRICE | OVERPANEL HEIGHT | SIZE/ H | INCHES W | D | WEIGHT LBS | VOL FT ³ |
|--------------|-------|------------------|---------|----------|-----|------------|---------------------|
| DB1OPPC08X | 60 | 8" | 8 | 1.3 | 2.6 | 0.8 | 0.043 |
| DB1OPPC16X | 64 | 16" | 16 | 1.3 | 2.6 | 1.6 | 0.082 |
| DB1OPPC24X | 66 | 24" | 24 | 1.3 | 2.6 | 2.5 | 0.120 |
| DB1OPPC37X | 74 | 37" | 37 | 1.3 | 2.6 | 3.5 | 0.183 |
| DB1OPPC42X | 83 | 42" | 42 | 1.3 | 2.6 | 4.0 | 0.207 |

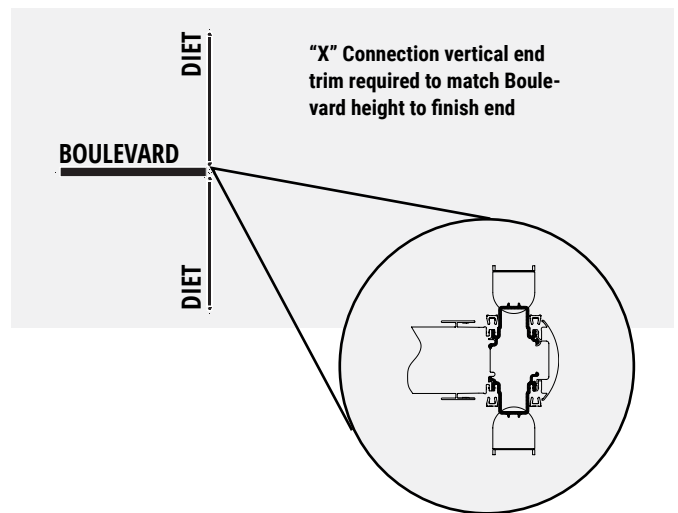
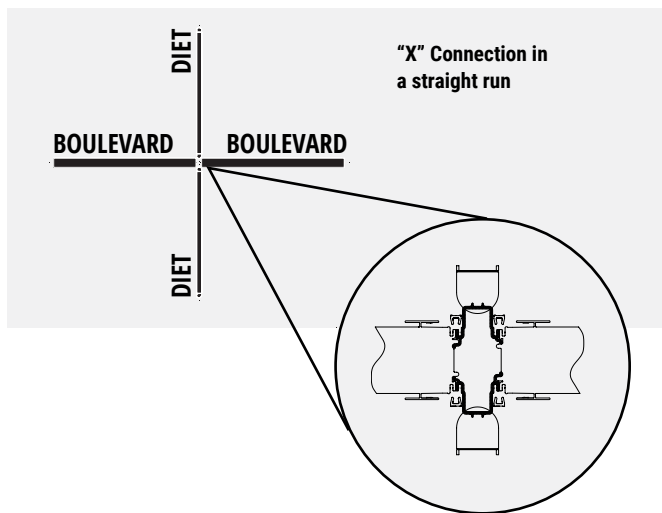

DBXP-T • Diet to Boulevard Slim Connector in “T” Configuration

- Creates a perpendicular connection between Diet Panel and Boulevard Panel that eliminates the need for special sized worksurfaces.
- Note: For use with regular DP panels.

Diet to Boulevard 1 “T” Configuration

| PRODUCT CODE | PRICE | B1 HEIGHT | DIET PANEL HEIGHT | SIZE/ H | INCHES W | D | WEIGHT LBS | VOL FT ³ |
|--------------|-------|-----------|-------------------|---------|----------|-----|------------|---------------------|
| DB1P4242T | 132 | 42" | 42" | 42 | 1.3 | 2.6 | 4 | 0.207 |
| DB1P4250T | 147 | 50" | 42" | 50 | 1.3 | 2.6 | 5 | 0.245 |
| DB1P4258T | 162 | 58" | 42" | 58 | 1.3 | 2.6 | 6 | 0.283 |
| DB1P4266T | 178 | 66" | 42" | 66 | 1.6 | 2.6 | 7 | 0.322 |
| DB1P4274T | 194 | 74" | 42" | 74 | 1.3 | 2.6 | 8 | 0.360 |
| DB1P4282T | 208 | 82" | 42" | 82 | 1.3 | 2.6 | 9 | 0.399 |
| DB1P5050T | 178 | 50" | 50" | 50 | 1.3 | 2.6 | 5 | 0.245 |
| DB1P5058T | 178 | 58" | 50" | 58 | 1.3 | 2.6 | 6 | 0.283 |
| DB1P5066T | 178 | 66" | 50" | 66 | 1.3 | 2.6 | 7 | 0.322 |
| DB1P5074T | 194 | 74" | 50" | 74 | 1.3 | 2.6 | 8 | 0.360 |
| DB1P5082T | 208 | 82" | 50" | 82 | 1.3 | 2.6 | 9 | 0.399 |
| DB1P5458T | 162 | 58" | 54" | 58 | 1.3 | 2.6 | 6 | 0.283 |
| DB1P5466T | 178 | 66" | 54" | 66 | 1.3 | 2.6 | 7 | 0.322 |
| DB1P5474T | 194 | 74" | 54" | 74 | 1.3 | 2.6 | 8 | 0.360 |
| DB1P5482T | 208 | 82" | 54" | 82 | 1.3 | 2.6 | 9 | 0.399 |
| DB1P6666T | 178 | 66" | 66" | 66 | 1.3 | 2.6 | 7 | 0.322 |
| DB1P6674T | 194 | 74" | 66" | 74 | 1.3 | 2.6 | 8 | 0.360 |
| DB1P6682T | 208 | 82" | 66" | 82 | 1.3 | 2.6 | 9 | 0.399 |

Diet to System 3 “T” Configuration

| PRODUCT CODE | PRICE | SYSTEM 3 HEIGHT | DIET PANEL HEIGHT | SIZE/ H | INCHES W | D | WEIGHT LBS | VOL FT ³ |
|--------------|-------|-----------------|-------------------|---------|----------|-----|------------|---------------------|
| DB3P4242T | 132 | 42" | 42" | 42 | 1.3 | 2.6 | 4 | 0.207 |
| DB3P4250T | 147 | 50" | 42" | 50 | 1.3 | 2.6 | 5 | 0.245 |
| DB3P4266T | 178 | 66" | 42" | 66 | 1.3 | 2.6 | 7 | 0.322 |
| DB3P5050T | 178 | 50" | 50" | 50 | 1.3 | 2.6 | 5 | 0.245 |
| DP3P5066T | 178 | 66" | 50" | 66 | 1.3 | 2.6 | 7 | 0.322 |
| DB3P5466T | 178 | 66" | 54" | 66 | 1.3 | 2.6 | 7 | 0.322 |
| DB3P6666T | 178 | 66" | 66" | 66 | 1.3 | 2.6 | 7 | 0.322 |

Diet to System 3 Overpanels

| PRODUCT CODE | PRICE | OVERPANEL HEIGHT | SIZE/ H | INCHES W | D | WEIGHT LBS | VOL FT ³ |
|--------------|-------|------------------|---------|----------|-----|------------|---------------------|
| DB30PPC16 | 64 | 16" | 16 | 1.3 | 2.6 | 1.6 | 0.082 |
| DB30PPC32 | 74 | 32" | 32 | 1.3 | 2.6 | 3.2 | 0.159 |

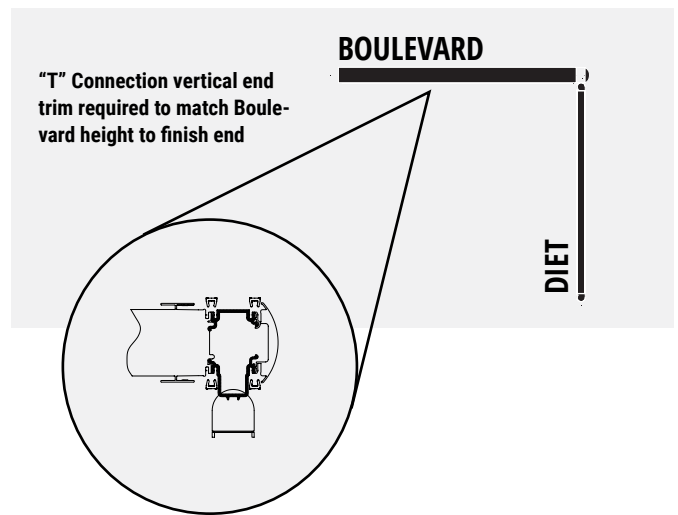
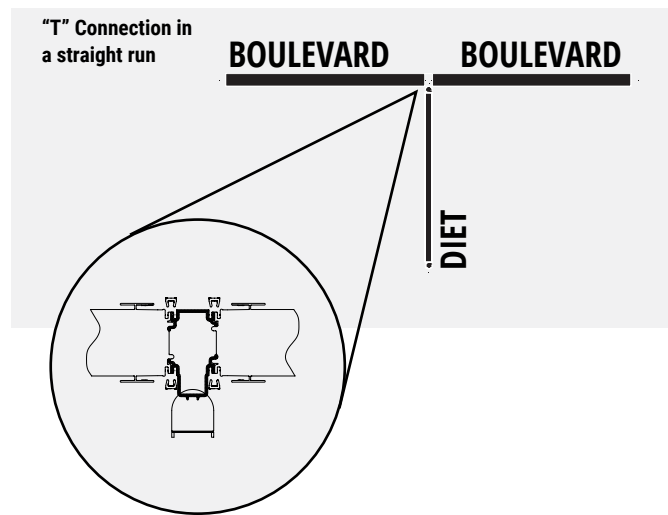

* Please specify separate end trim (round or flat) to close end.

DEK • Jumper Harness

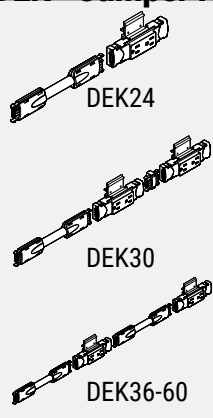

- **Kit includes all components to add power to Diet Panels.**
- Typical kit includes: 2 Duplex Receptacle Blocks (either circuit #1 or circuit #2), the Jumper Harness between the Duplex Receptacle Blocks, the Jumper Harness to the next panel, the pre-punched Raceway Cover, the aluminum Raceway Junction Cover, 2 PVC Duplex Receptacle Block Spacers and the hardware to attach the components.
- The length of the Jumper Harness between two Duplex Receptacle Blocks is based on the panel width.
- Jumper Harness going into the next panel and the aluminum Raceway Junction Covers are standard size.
- Raceway Cover and Raceway Junction Cover are Charcoal (CHR) only.
- Each kit is identified as circuit #1 (ie. DEK240*1") or circuit #2 (ie. DEK240*2").
- 24" wide panels have a single Duplex Receptacle Block only.
- 30" wide panels have 2 Duplex Receptacle Blocks, however they must be facing the same direction.
- 24" and 30" wide panels are not pre-punched for data.
- 36" to 60" wide panels are pre-punched for Duplex Receptacle Blocks on either side and for data just off-center on both sides.

| PRODUCT CODE | PRICE | SIZE/ INCHES | | | WEIGHT VOL | |
|--------------|-------|--------------|----|-----|------------|-----------------|
| | | H | W | D | LBS | FT ³ |
| DEK2401 | 202 | 4 | 18 | 1.3 | 4.90 | 0.07 |
| DEK3001 | 294 | 4 | 24 | 1.3 | 5.25 | 0.08 |
| DEK3601 | 306 | 4 | 30 | 1.3 | 5.70 | 0.10 |
| DEK4201 | 319 | 4 | 36 | 1.3 | 6.00 | 0.13 |
| DEK4801 | 331 | 4 | 42 | 1.3 | 6.40 | 0.15 |
| DEK5401 | 347 | 4 | 48 | 1.3 | 7.10 | 0.16 |
| DEK6001 | 363 | 4 | 54 | 1.3 | 7.60 | 0.19 |
| DEK2402 | 202 | 4 | 18 | 1.3 | 4.90 | 0.07 |
| DEK3002 | 294 | 4 | 24 | 1.3 | 5.25 | 0.08 |
| DEK3602 | 306 | 4 | 30 | 1.3 | 5.70 | 0.10 |
| DEK4202 | 319 | 4 | 36 | 1.3 | 6.00 | 0.13 |
| DEK4802 | 331 | 4 | 42 | 1.3 | 6.40 | 0.15 |
| DEK5402 | 347 | 4 | 48 | 1.3 | 7.10 | 0.16 |
| DEK6002 | 363 | 4 | 54 | 1.3 | 7.60 | 0.19 |

DEJH • Diet Pass-Thru Kit

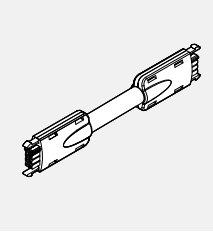

- **Kit allows electrical to pass through a Diet Panel.**
- Kit includes: female-female jumper harness, Raceway Cover and Raceway Junction Cover.
- Pass-Thru harness connects to a Duplex Receptacle Block within one powered panel; passes through a non-powered panel, and the opposite end connects to another Receptacle Block within the second powered panel.
- Raceway Cover and Raceway Junction Cover are Charcoal (CHR) only.

| PRODUCT CODE | PRICE | SIZE/ INCHES | | | WEIGHT VOL | |
|--------------|-------|--------------|----|---|------------|-----------------|
| | | H | L | D | LBS | FT ³ |
| DEJH24 | 140 | 2 | 42 | 1 | 1.81 | 0.025 |
| DEJH30 | 155 | 2 | 48 | 1 | 2.07 | 0.028 |
| DEJH36 | 171 | 2 | 54 | 1 | 2.12 | 0.032 |
| DEJH42 | 184 | 2 | 60 | 1 | 2.60 | 0.035 |
| DEJH48 | 196 | 2 | 66 | 1 | 2.86 | 0.038 |
| DEJH54 | 213 | 2 | 72 | 1 | 3.13 | 0.041 |
| DEJH60 | 226 | 2 | 78 | 1 | 3.39 | 0.044 |

DEBF • Diet Base Feed

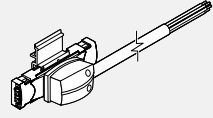

- **Provides single power entry from floor into raceway.**
- Single Ceiling Feed has a 6' whip, liquid tight.
- Raceway connection replaces one Duplex Receptacle Block in a standard kit.

| PRODUCT CODE | PRICE | SIZE/ INCHES | | | WEIGHT VOL | |
|--------------|-------|--------------|----|---|------------|-----------------|
| | | H | L | D | LBS | FT ³ |
| DEBF01 | 197 | 2 | 72 | 2 | 5.6 | 0.06 |

DECF • Diet Ceiling Feed

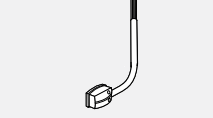

- **Provides single power entry from ceiling through a post into raceway.**
- Raceway connection replaces one Duplex Receptacle Block in a standard kit.

| PRODUCT CODE | PRICE | SIZE/ INCHES | | | WEIGHT VOL | |
|--------------|-------|--------------|-----|---|------------|-----------------|
| | | H | L | D | LBS | FT ³ |
| DECF01 | 299 | 2 | 144 | 2 | 5.6 | 0.06 |

DEPE • Diet Post Extension

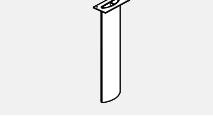

- **Lightweight aluminum pole manages power and data cables between ceiling and floor level raceway.**
- Aluminum extrusion with PVC extruded cover secures to the outside of the panel and passes through the worksurface scoop.
- Includes all hardware and bezel.
- Intended for use on Diet panels with fabric bottoms.

| PRODUCT CODE | PRICE | SIZE/ INCHES | | | WEIGHT VOL | |
|--------------|-------|--------------|-----|---|------------|-----------------|
| | | H | W | D | LBS | FT ³ |
| DEPE116 | 179 | 116 | 4.5 | 1 | 7 | 0.82 |

DERJC • Raceway Junction Cover

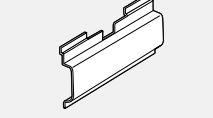

- **Provides an external cover for cables passing between adjacent, in-line panels and off-module "X" panel configurations. Also, capable of bridging two in-line panels in a "T" configuration (outside).**
- Aluminum, powder coated finish.

| PRODUCT CODE | PRICE | SIZE/ INCHES | | | WEIGHT VOL | |
|--------------|-------|--------------|----|---|------------|-----------------|
| | | H | W | D | LBS | FT ³ |
| DERJC | 23 | 4.3 | 10 | 1 | 0.5 | 0.1 |

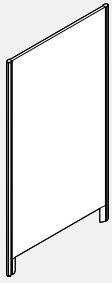
DPL • Linking Panel - Levelers on both legs

- **Diet Linking Panel provides privacy.**
- Aluminum extrusion comes in powder coated paint finish, DWT - Designer White or TUN - Tungsten.
- Laminate core available in DWTLPL - Designer White or ACJLP - Absolute Acajou.
- Edge banded to match laminate finish.
- Standard height of 54", 66", width in 6" increments from 24" to 60".
- Comes complete with hinge kits and levelers on both legs.

| PRODUCT CODE | PRICE | SIZE/ INCHES | | | WEIGHT VOL | |
|-----------------|-------|-----------------|----|-----|------------|-----------------|
| | | H | W | D | LBS | FT ³ |
| DPL5424 | 397 | 54 | 24 | 1.3 | 18 | 1.62 |
| DPL5430 | 441 | 54 | 30 | 1.3 | 23 | 2.08 |
| DPL5436 | 484 | 54 | 36 | 1.3 | 27 | 2.47 |
| DPL5442 | 527 | 54 | 42 | 1.3 | 32 | 2.85 |
| DPL5448 | 573 | 54 | 48 | 1.3 | 37 | 3.25 |
| DPL5454 | 615 | 54 | 54 | 1.3 | 42 | 3.63 |
| DPL5460 | 658 | 54 | 60 | 1.3 | 47 | 4.02 |
| DPL6624 | 450 | 66 | 24 | 1.3 | 23 | 2.04 |
| DPL6630 | 499 | 66 | 30 | 1.3 | 29 | 2.52 |
| DPL6636 | 547 | 66 | 36 | 1.3 | 35 | 3.00 |
| DPL6642 | 593 | 66 | 42 | 1.3 | 41 | 3.46 |
| DPL6648 | 644 | 66 | 48 | 1.3 | 47 | 3.93 |
| DPL6654 | 691 | 66 | 54 | 1.3 | 53 | 4.40 |
| DPL6660 | 739 | 66 | 60 | 1.3 | 59 | 4.90 |

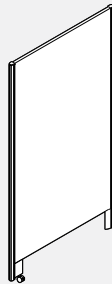
DPLSCH • Diet Laminate Panel - Single caster on one leg, leveler on the other

- **Diet Linking Panel provides privacy.**
- Aluminum extrusion comes in powder coated paint finish, DWT - Designer White or TUN - Tungsten.
- Laminate core available in DWTLPL - Designer White or ACJLP - Absolute Acajou.
- Edge banded to match laminate finish.
- Standard height of 54", 66", width in 6" increments from 24" to 60".
- Comes complete with hinge kits, caster on one leg and leveler on the other.

| PRODUCT CODE | PRICE | SIZE/ INCHES | | | WEIGHT VOL | |
|-----------------|-------|-----------------|----|-----|------------|-----------------|
| | | H | W | D | LBS | FT ³ |
| DPLSCH5424 | 476 | 54 | 24 | 1.3 | 18 | 1.62 |
| DPLSCH5430 | 522 | 54 | 30 | 1.3 | 23 | 2.08 |
| DPLSCH5436 | 568 | 54 | 36 | 1.3 | 27 | 2.47 |
| DPLSCH5442 | 613 | 54 | 42 | 1.3 | 32 | 2.85 |
| DPLSCH5448 | 658 | 54 | 48 | 1.3 | 37 | 3.25 |
| DPLSCH5454 | 705 | 54 | 54 | 1.3 | 42 | 3.63 |
| DPLSCH5460 | 751 | 54 | 60 | 1.3 | 47 | 4.02 |
| DPLSCH6624 | 530 | 66 | 24 | 1.3 | 23 | 2.04 |
| DPLSCH6630 | 580 | 66 | 30 | 1.3 | 29 | 2.52 |
| DPLSCH6636 | 630 | 66 | 36 | 1.3 | 35 | 3 |
| DPLSCH6642 | 681 | 66 | 42 | 1.3 | 41 | 3.46 |
| DPLSCH6648 | 731 | 66 | 48 | 1.3 | 47 | 3.93 |
| DPLSCH6654 | 800 | 66 | 54 | 1.3 | 53 | 4.4 |
| DPLSCH6660 | 830 | 66 | 60 | 1.3 | 59 | 4.9 |

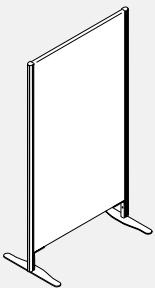
DPLDF • Diet Linking Panel - Flat foot on both legs

- **Diet Linking Panel provides privacy.**
- Aluminum extrusion comes in powder coated paint finish, DWT - Designer White or TUN - Tungsten.
- Laminate core available in DWTLPL - Designer White or ACJLP - Absolute Acajou.
- Edge banded to match laminate finish.
- Standard height of 54", 66", width in 6" increments from 24" to 60".
- Comes complete with hinge kits and flat foot on both legs.

| PRODUCT CODE | PRICE | SIZE/ INCHES | | | WEIGHT VOL | |
|-----------------|-------|-----------------|----|-----|------------|-----------------|
| | | H | W | D | LBS | FT ³ |
| DPLDF5424 | 544 | 54 | 24 | 1.3 | 40.2 | 1.6 |
| DPLDF5430 | 582 | 54 | 30 | 1.3 | 47.6 | 2.1 |
| DPLDF5436 | 619 | 54 | 36 | 1.3 | 54.9 | 2.5 |
| DPLDF5442 | 657 | 54 | 42 | 1.3 | 62.3 | 2.9 |
| DPLDF5448 | 695 | 54 | 48 | 1.3 | 69.6 | 3.3 |
| DPLDF5454 | 734 | 54 | 54 | 1.3 | 77.0 | 3.6 |
| DPLDF5460 | 774 | 54 | 60 | 1.3 | 84.3 | 4.0 |
| DPLDF6624 | 589 | 66 | 24 | 1.3 | 48.6 | 2.0 |
| DPLDF6630 | 630 | 66 | 30 | 1.3 | 57.9 | 2.5 |
| DPLDF6636 | 673 | 66 | 36 | 1.3 | 67.3 | 3.0 |
| DPLDF6642 | 714 | 66 | 42 | 1.3 | 76.6 | 3.5 |
| DPLDF6648 | 757 | 66 | 48 | 1.3 | 85.9 | 3.9 |
| DPLDF6654 | 797 | 66 | 54 | 1.3 | 95.2 | 4.4 |
| DPLDF6660 | 840 | 66 | 60 | 1.3 | 104.5 | 4.9 |

DPLMN • Diet Linking Panel - Double caster base on both legs

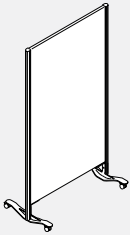

- **Diet Linking Panel provides privacy.**
- Aluminum extrusion comes in powder coated paint finish, DWT - Designer White or TUN - Tungsten.
- Laminate core available in DWTL - Designer White or ACJLP - Absolute Acajou.
- Edge banded to match laminate finish.
- Standard height of 54", 66", width in 6" increments from 24" to 60".
- Comes complete with hinge kits, and double caster foot on both legs.

| PRODUCT CODE | PRICE | SIZE/ INCHES | | | WEIGHT VOL | |
|--------------|-------|--------------|----|-----|------------|-----------------|
| | | H | W | D | LBS | FT ³ |
| DPLMN5424 | 578 | 54 | 24 | 1.3 | 41.8 | 1.6 |
| DPLMN5430 | 627 | 54 | 30 | 1.3 | 49.1 | 2.1 |
| DPLMN5436 | 679 | 54 | 36 | 1.3 | 56.5 | 2.5 |
| DPLMN5442 | 726 | 54 | 42 | 1.3 | 63.8 | 2.9 |
| DPLMN5448 | 779 | 54 | 48 | 1.3 | 71.2 | 3.3 |
| DPLMN5454 | 828 | 54 | 54 | 1.3 | 78.5 | 3.6 |
| DPLMN5460 | 879 | 54 | 60 | 1.3 | 85.8 | 4.0 |
| DPLMN6624 | 641 | 66 | 24 | 1.3 | 50.2 | 2.0 |
| DPLMN6630 | 693 | 66 | 30 | 1.3 | 59.5 | 2.5 |
| DPLMN6636 | 749 | 66 | 36 | 1.3 | 68.8 | 3.0 |
| DPLMN6642 | 805 | 66 | 42 | 1.3 | 78.1 | 3.5 |
| DPLMN6648 | 860 | 66 | 48 | 1.3 | 87.4 | 3.9 |
| DPLMN6654 | 916 | 66 | 54 | 1.3 | 96.8 | 4.4 |
| DPLMN6660 | 971 | 66 | 60 | 1.3 | 106.1 | 4.9 |

DPLDCMN • Diet Linking Panel - Single caster on one leg and double caster base on the other

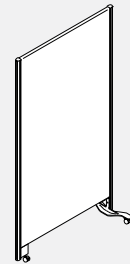

- **Diet Linking Panel provides privacy.**
- Aluminum extrusion comes in powder coated paint finish, DWT - Designer White or TUN - Tungsten.
- Laminate core available in DWTL - Designer White or ACJLP - Absolute Acajou.
- Edge banded to match laminate finish.
- Standard height of 54", 66", width in 6" increments from 24" to 60".
- Comes complete with hinge kits, single caster on the one leg and double caster foot on the other.

| PRODUCT CODE | PRICE | SIZE/ INCHES | | | WEIGHT VOL | |
|--------------|-------|--------------|----|-----|------------|-----------------|
| | | H | W | D | LBS | FT ³ |
| DPLDCMN5424 | 543 | 54 | 24 | 1.3 | 37.6 | 1.6 |
| DPLDCMN5430 | 591 | 54 | 30 | 1.3 | 45.0 | 2.1 |
| DPLDCMN5436 | 639 | 54 | 36 | 1.3 | 52.3 | 2.5 |
| DPLDCMN5442 | 688 | 54 | 42 | 1.3 | 59.7 | 2.9 |
| DPLDCMN5448 | 736 | 54 | 48 | 1.3 | 67.0 | 3.3 |
| DPLDCMN5454 | 783 | 54 | 54 | 1.3 | 74.4 | 3.6 |
| DPLDCMN5460 | 830 | 54 | 60 | 1.3 | 81.7 | 4.0 |
| DPLDCMN6624 | 602 | 66 | 24 | 1.3 | 46.0 | 2.0 |
| DPLDCMN6630 | 654 | 66 | 30 | 1.3 | 55.3 | 2.5 |
| DPLDCMN6636 | 707 | 66 | 36 | 1.3 | 64.7 | 3.0 |
| DPLDCMN6642 | 758 | 66 | 42 | 1.3 | 74.0 | 3.5 |
| DPLDCMN6648 | 812 | 66 | 48 | 1.3 | 83.3 | 3.9 |
| DPLDCMN6654 | 863 | 66 | 54 | 1.3 | 92.6 | 4.4 |
| DPLDCMN6660 | 917 | 66 | 60 | 1.3 | 101.9 | 4.9 |

DPLDCHN • Diet Linking Panel - Leveler on one leg and double caster base on the other



- **Diet Linking Panel provides privacy.**
- Aluminum extrusion comes in powder coated paint finish, DWT - Designer White or TUN - Tungsten.
- Laminate core available in DWTL - Designer White or ACJLP - Absolute Acajou.
- Edge banded to match laminate finish.
- Standard height of 54", 66", width in 6" increments from 24" to 60".
- Comes complete with hinge kits, leveler on one leg and double caster foot on the other.

| PRODUCT CODE | PRICE | SIZE/ INCHES | | | WEIGHT VOL | |
|--------------|-------|--------------|----|-----|------------|-----------------|
| | | H | W | D | LBS | FT ³ |
| DPLDCHN5424 | 512 | 54 | 24 | 1.3 | 37.1 | 1.6 |
| DPLDCHN5430 | 556 | 54 | 30 | 1.3 | 44.5 | 2.1 |
| DPLDCHN5436 | 608 | 54 | 36 | 1.3 | 51.8 | 2.5 |
| DPLDCHN5442 | 655 | 54 | 42 | 1.3 | 59.2 | 2.9 |
| DPLDCHN5448 | 701 | 54 | 48 | 1.3 | 66.5 | 3.3 |
| DPLDCHN5454 | 751 | 54 | 54 | 1.3 | 73.9 | 3.6 |
| DPLDCHN5460 | 799 | 54 | 60 | 1.3 | 81.2 | 4.0 |
| DPLDCHN6624 | 568 | 66 | 24 | 1.3 | 45.5 | 2.0 |
| DPLDCHN6630 | 621 | 66 | 30 | 1.3 | 54.9 | 2.5 |
| DPLDCHN6636 | 673 | 66 | 36 | 1.3 | 64.2 | 3.0 |
| DPLDCHN6642 | 724 | 66 | 42 | 1.3 | 73.5 | 3.5 |
| DPLDCHN6648 | 779 | 66 | 48 | 1.3 | 82.8 | 3.9 |
| DPLDCHN6654 | 830 | 66 | 54 | 1.3 | 92.1 | 4.4 |
| DPLDCHN6660 | 885 | 66 | 60 | 1.3 | 101.4 | 4.9 |

DPLWA • Wall Connection for Linking Panels

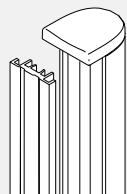

- **Wall Connection connects Linking**
- Panels to walls.
- Aluminum extrusion comes in powder coated paint finish, DWT - Designer White or TUN - Tungsten.
- Kit consists of Diet vertical extrusion, charcoal PVC cover and hinge kits.

| PRODUCT CODE | PRICE | SIZE/ INCHES | | | WEIGHT VOL | |
|--------------|-------|--------------|---|---|------------|-----------------|
| | | H | W | D | LBS | FT ³ |
| DPLWA54 | 103 | 54 | 2 | 2 | 2.3 | 0.13 |
| DPLWA66 | 115 | 66 | 2 | 2 | 3.5 | 0.15 |

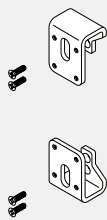
DPLEKIT • Expanding Kit

- **Expanding Kit connects two linking panels in a straight line.**
- This kit will accommodate any special width by overlapping the panels.
- Aluminum extrusion comes in powder coated paint finish, DWT - Designer White or TUN - Tungsten.
- Kit consists of a top and bottom bracket and all the hardware needed.

| PRODUCT CODE | PRICE | SIZE/ INCHES | | | WEIGHT VOL | |
|--------------|-------|--------------|---|-----|------------|-----------------|
| | | H | W | D | LBS | FT ³ |
| DPLEKIT | 179 | 3 | 2 | 2.0 | 1 | 0.05 |

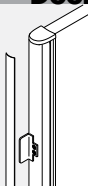
DP • Door and Door Catch Kit for Linking Panels

- **Door Catch Kit converts any Linking Panel into a door.**
- Aluminum extrusion comes in powder coated paint finish, DWT - Designer White or TUN - Tungsten.
- Kit consists of striker plate, two hinge kits, single caster foot assembly and 1" Diet caster

| PRODUCT CODE | PRICE | SIZE/ INCHES | | | WEIGHT VOL | |
|--------------|-------|--------------|---|-----|------------|-----------------|
| | | H | W | D | LBS | FT ³ |
| DPDC01 | 112 | 6 | 3 | 1.3 | 2 | 0.50 |

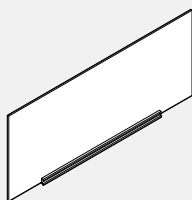
DP • Over Panel for Linking Panels

- **Over Panel sits atop of Linking Panel and bridges the gap between the top of 66" high Linking Panel and the top of the Screening Booth.**
- Kit contains aluminum extrusion and felt insert.
- Aluminum extrusion comes in powder coated paint finish, DWT - Designer White or TUN - Tungsten.

| PRODUCT CODE | PRICE | SIZE/ INCHES | | | WEIGHT VOL | |
|--------------|-------|--------------|----|------|------------|-----------------|
| | | H | W | D | LBS | FT ³ |
| DPLOP24 | 92 | 16.8 | 24 | 1.05 | 1.74 | 0.39 |
| DPLOP30 | 108 | 16.8 | 30 | 1.05 | 2.20 | 0.49 |
| DPLOP36 | 128 | 16.8 | 36 | 1.05 | 2.67 | 0.59 |
| DPLOP42 | 143 | 16.8 | 42 | 1.05 | 3.14 | 0.70 |
| DPLOP48 | 212 | 16.8 | 48 | 1.05 | 3.60 | 0.80 |
| DPLOP54 | 231 | 16.8 | 54 | 1.05 | 4.07 | 0.90 |
| DPLOP60 | 248 | 16.8 | 60 | 1.05 | 4.35 | 1.01 |

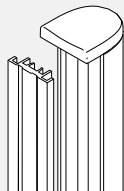
DP • Booth to Linking Panel Connector

- **Booth to Linking Panel Connector facilitates the connection of a Linking Panel to the back gable edge of the Screening Booth.**
- Aluminum extrusion comes in powder coated paint finish, DWT - Designer White or TUN - Tungsten.
- Kit includes a Diet vertical extrusion, charcoal PVC cover and all hardware.

| PRODUCT CODE | PRICE | SIZE/ INCHES | | | WEIGHT VOL | |
|--------------|-------|--------------|---|-----|------------|-----------------|
| | | H | W | D | LBS | FT ³ |
| DEBPA | 79 | 66 | 3 | 1.3 | 3.5 | 0.15 |

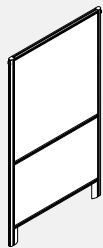
DPVAC • Diet VAC Laminate Panels

- **Special panel construction designed specifically for clinical applications.**
- Segmentented panels offer a thermally fused laminate lower and high pressure upper pressed on a lightweight core.
- Minimal footprint for storage.
- Easy to connect.
- Easy to reconfigure.
- Easy to clean.
- Laminate core available in DWTL/HP Designer White or ACJLP/ACJHP Absolute Acajou.
- Aluminum extrusion comes in powder coated paint finish. DWT Designer White or TUN Tungsten.
- Comes completed with hinge kits and levelers on both legs.

| PRODUCT CODE | PRICE | SIZE/ INCHES | | | WEIGHT VOL | |
|--------------|-------|--------------|----|-----|------------|-----------------|
| | | H | W | D | LBS | FT ³ |
| DPVAC6636 | 689 | 66 | 36 | 1.3 | 35 | 3.00 |
| DPVAC6642 | 711 | 66 | 42 | 1.3 | 41 | 3.46 |
| DPVAC6648 | 724 | 66 | 48 | 1.3 | 47 | 3.93 |
| DPVAC6660 | 1091 | 66 | 60 | 1.3 | 59 | 4.90 |

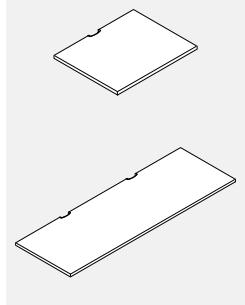
DWS • Worksurface for Diet Panels

- **Worksurfaces have scoops at back to allow wires and cables to pass to and from floor level.**
- Includes support brackets (DHBRKT), 4 for work-surfaces up to 48", and 5 for any worksurface longer than 48".
- Please choose from DWT - Designer White, SIL - Silver or BLK - Black for scoop covers.

| PRODUCT CODE | PRICE LP* | HP* | SIZE/ INCHES | | | WEIGHT VOL | |
|--------------|-----------|-----|--------------|----|----|------------|-----------------|
| | | | H | W | D | LBS | FT ³ |
| DWS2424P | 149 | 187 | 1 | 24 | 24 | 15 | 0.60 |
| DWS2430P | 159 | 199 | 1 | 30 | 24 | 19 | 0.72 |
| DWS2436P | 180 | 225 | 1 | 36 | 24 | 23 | 0.85 |
| DWS2442P | 235 | 295 | 1 | 42 | 24 | 27 | 0.98 |
| DWS2448P | 283 | 353 | 1 | 48 | 24 | 31 | 1.11 |
| DWS2454P | 333 | 412 | 1 | 54 | 24 | 35 | 1.23 |
| DWS2460P | 373 | 465 | 1 | 60 | 24 | 39 | 1.36 |
| DWS2466P | 389 | 485 | 1 | 66 | 24 | 43 | 1.49 |
| DWS2472P | 408 | 509 | 1 | 72 | 24 | 48 | 1.62 |
| DWS3024P | 174 | 218 | 1 | 24 | 30 | 19 | 0.74 |
| DWS3030P | 190 | 236 | 1 | 30 | 30 | 24 | 0.90 |
| DWS3036P | 221 | 278 | 1 | 36 | 30 | 29 | 1.06 |
| DWS3042P | 313 | 392 | 1 | 42 | 30 | 34 | 1.22 |
| DWS3048P | 333 | 412 | 1 | 48 | 30 | 39 | 1.38 |
| DWS3054P | 364 | 454 | 1 | 54 | 30 | 43 | 1.54 |
| DWS3060P | 389 | 485 | 1 | 60 | 30 | 48 | 1.69 |
| DWS3066P | 406 | 508 | 1 | 66 | 30 | 53 | 1.85 |
| DWS3072P | 430 | 537 | 1 | 72 | 30 | 58 | 2.01 |

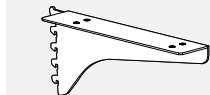
BHC • Diet/Boulevard Worksurface 12" Cantilever Support

- An economical way to connect rear part of the side edge of a worksurface to the Boulevard Panel.
- Front part of the side edge of the worksurface must be supported by an off-module Diet Worksurface Bracket and locked into the adjacent Diet Panel.
- This cantilever is not a shared support

| PRODUCT CODE | PRICE | SIZE/ INCHES | | | WEIGHT VOL | |
|--------------|-------|--------------|---|----|------------|-----------------|
| | | H | W | D | LBS | FT ³ |
| BHC12L | 41 | 6 | 2 | 12 | 2 | 0.03 |
| BHC12R | 41 | 6 | 2 | 12 | 2 | 0.03 |

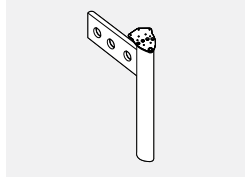
DHLEG • Diet Gable Leg

- **Universal leg, plate and side panel are non handed.**
- Supports the worksurface at 29" and enhances the stability of connected panels.
- Side plate is secured to the side of the Diet panel and leg plate bolts to worksurface.
- Made of extruded aluminum and steel.
- Levelers have 1.75" height adjustment.
- Includes all mounting hardware to connect to panel and worksurface.
- Must attach to Diet Panel vertical.

| PRODUCT CODE | PRICE | SIZE/ INCHES | | | WEIGHT VOL | |
|--------------|-------|--------------|----|---|------------|-----------------|
| | | H | W | D | LBS | FT ³ |
| DHLEG | 211 | 28 | 23 | 6 | 12 | 2.02 |

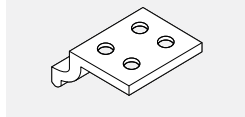
DHBRKT • Diet Worksurface Bracket

- **Extruded aluminum bracket that is bolted to the underside of the worksurface.**
- Bracket supports worksurface at any location along the mid rail of panel.
- Includes mounting hardware.
- Brackets are included for all worksurfaces DWS, 4 for worksurfaces up to 48", and 5 for any worksurface longer than 48".

| PRODUCT CODE | PRICE | SIZE/ INCHES | | | WEIGHT VOL | |
|--------------|-------|--------------|------|------|------------|-----------------|
| | | H | W | D | LBS | FT ³ |
| DHBRKT | 11 | 0.75 | 2.25 | 3.25 | 0.1 | 0.05 |

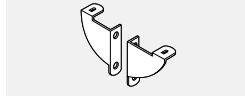
DHTBRKT • Diet Transaction Bracket

- Connects transaction tops to Diet Panels.
- Includes 1 set of two brackets and all hardware.

| PRODUCT CODE | PRICE | SIZE/ INCHES | | | WEIGHT VOL | |
|--------------|-------|--------------|-----|-----|------------|-----------------|
| | | H | W | D | LBS | FT ³ |
| DHTBRKT | 41 | 2.5 | 1.2 | 2.5 | 3 | 0.01 |

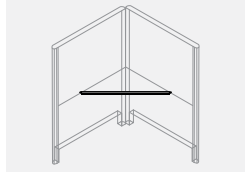
DWSCSB • Diet Support Bar

- **Supports worksurface in 90 degree corner application and eliminates the need for a leg.**
- Diagonally installed.
- If using a keyboard, spacers will be required.

| PRODUCT CODE | PRICE | SIZE/ INCHES | | | WEIGHT VOL | |
|--------------|-------|--------------|----|---|------------|-----------------|
| | | H | W | D | LBS | FT ³ |
| DWSCSB46 | 109 | 1 | 46 | 1 | 7 | 0.116 |
| DWSCSB80 | 157 | 1 | 80 | 1 | 12 | 0.189 |

For corner application where 24" deep or smaller adjoining worksurface:
For corner application where adjoining worksurface is larger than 24":

DHOMC • Diet Off-Module Cantilever

- **To be used with Diet Panels that have a fabric bottom.**
- Installs on horizontal rails of panels to provide worksurface support.
- Frees up space under the worksurface.

| PRODUCT CODE | PRICE | SIZE/ INCHES | | | WEIGHT VOL | |
|--------------|-------|--------------|---|----|------------|-----------------|
| | | H | W | D | LBS | FT ³ |
| DHOMC | 109 | 21 | 3 | 12 | 4 | 0.42 |

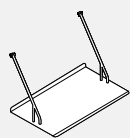
DSOMSHLF • Diet Off Module 24" Shelf

- Shelf hangs anywhere along Diet panel rails or Boulevard System 3 panel accessory tile.
- Can create a supplementary surface at worksurface level when suspended from a 42" high Diet panel.
- Shelves may be stacked, one hanging above the other from a higher rail.
- Shelf made of formed steel and includes suspended arms made of steel.

| PRODUCT CODE | PRICE | SIZE/ | INCHES | | | WEIGHT VOL | |
|--------------|-------|-------|--------|----|-----|-----------------|--|
| | | H | W | D | LBS | FT ³ | |
| DSOMSHLF | 246 | 11.5 | 24 | 12 | 4 | 1.00 | |

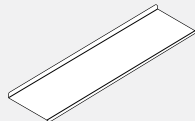
DSOS • Diet Panel Mounted Shelf

- Provides overhead storage capacity on top of 42" and 54" high Diet panels.
- Made of formed steel and includes steel mounting brackets.
- Support brackets lock to the top of Diet rail at the back and both sides of overhead.
- Must be installed on a "U" or "H" panel configuration.
- Due to structural issues, this product may not be used on top of glazed or partially glazed panels.

| PRODUCT CODE | PRICE | SIZE/ | INCHES | | | WEIGHT VOL | |
|--------------|-------|-------|--------|------|-----|-----------------|--|
| | | H | W | D | LBS | FT ³ | |
| DSOS48 | 297 | 15 | 48 | 13.5 | 40 | 5.60 | |
| DSOS60 | 316 | 15 | 60 | 13.5 | 52 | 7.00 | |

DOHLS • Diet Overhead Support

- To be used with Diet back panel and Diet wing panel either left or right. The support leg will support only one side and eliminate the need for a third panel.
- To be used and supported on worksurface installed at standard height. Ensure the worksurface that the leg sits on is properly supported.

| PRODUCT CODE | PRICE | SIZE/ | INCHES | | | WEIGHT VOL | |
|--------------|-------|-------|--------|-----|-----|-----------------|--|
| | | H | W | D | LBS | FT ³ | |
| DOHLS42 | 375 | 12 | 2 | 3.5 | 4 | 0.139 | |
| DOHLS54 | 406 | 24 | 2 | 3.5 | 6 | 0.278 | |

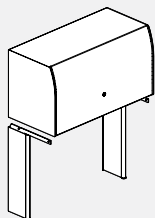
DSADA • Easy-Up Diet Overhead

- Diet Panel mounted metal overhead storage with opaque acrylic door. The Metal finish (page A.29). mechanism lifts the door up and stores it out of the way, above the storage unit.
- Meets CSA B651 Barrier Free Design & AODA (Accessibility for Ontarians with Disabilities Act).
- Meets CSA B651 Barrier Free Design & ADA (Americans with Disabilities Act).
- 16" high units accept standard and A4 binders.
- All shelves are reinforced for proper weight distribution.
- Inside dimensions: 14.375" high x 12" deep.
- Unit includes back, support cantilevers, attachment hardware, and lock.
- Shipped partially assembled.

| PRODUCT CODE | PRICE | SIZE/ | INCHES | | | WEIGHT VOL | |
|--------------|-------|-------|--------|------|-----|-----------------|--|
| | | H | W | D | LBS | FT ³ | |
| DSADA30PM | 1050 | 16 | 30 | 14.4 | 33 | 5.3 | |
| DSADA36PM | 1095 | 16 | 36 | 14.4 | 38 | 6.3 | |
| DSADA42PM | 1145 | 16 | 42 | 14.4 | 43 | 7.3 | |
| DSADA48PM | 1201 | 16 | 48 | 14.4 | 48 | 8.3 | |
| DSADA54PM | 1256 | 16 | 54 | 14.4 | 53 | 9.3 | |
| DSADA60PM | 1317 | 16 | 60 | 14.4 | 59 | 10.3 | |

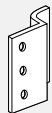
DHPEDB • Pedestal Bracket Kit for Diet Panels

- Attaches to a metal Worksurface Supporting Pedestal at the back and connects the pedestal to the Diet Panel vertical.

| PRODUCT CODE | PRICE | SIZE/ | INCHES | | | WEIGHT VOL | |
|--------------|-------|-------|--------|---|-----|-----------------|--|
| | | H | W | D | LBS | FT ³ | |
| DHPEDB | 36 | 8 | 1 | 1 | 0.5 | 0.001 | |

Introduction

Compile Systems - Protecting the Environment for Future Generations

- Our environmental success story began with the challenge to create an office system that would meet today's business requirements while maintaining a firm commitment to save and protect the environment.
- Sustainability became a part of the creative focus and development of Compile that incorporates the latest technology and design features to provide excellent performance at a competitive price.
- As government and industry environment ratings such as LEED & Greenguard become more prevalent, Compile offers designers and architects functional, attractive, and economical office designs that meet these standards.
- Global Contract is a leader in reducing waste in the manufacturing of its products as well as utilizing recycled materials wherever possible. We make extensive use of recycled plastic and wood waste from other Global factories.
- Global Contract is committed to the continuous improvement of our environmental systems, the prevention of pollution, and to comply with both the spirit and the letter of all relevant environmental legislation.

- Compile Panels are 82.3% recyclable at the end of their lifespan. Nothing from a Compile Panel needs to end up in a landfill.

Compile Systems - Product Information

- Compile offers fabrics that are made from 100% recycled polyester, which means less waste going to landfills. These fabrics also reduced the demand for petroleum products, and decrease the environmental impacts of processing those petroleum products into polyester.
- Compile's epoxy powder coating process involves no liquids and is solvent free. It contains no harmful VOC's or lead. Up to 99% of over sprayed powder is reclaimed, mixed with virgin powder and resused.
- Compile's entire panel is up to 82.3% recycled.
- Compile masonite is up to 85% recycled.
- Compile recycled wood for worksurfaces is up to 85% recycled.
- Compile's entire product line is up to 99.9% recyclable.

Components • Panel Configuration

Many components make up a panel configuration. This page provides an exploded view of a sample configuration highlighting each panel component required when specifying this configuration.

- A) CMET66 66"h. End of Run Trim Insert for Panel
- B) CMFF6636 66"h. x 36"w Single Segmented Fabric Panel
- C) CHP66 66"h. Universal Corner Post
- D) CMETP66 Trim Insert for 66"h. Universal Corner Post
- E) CMPC2 Post Base Cover for 2-Way Application
- F) CMET24 24"h Trim Insert for Step Down
- G) CMFF4236N1 42"h. x 36"w Single Segmented Fabric Panel, Punchouts on one side.
- H) CMET42 42"h. End of Run Trim Insert for Panel
- I) CMRC36NP 36"w Raceway Cover without Knockouts (if ordered separately)
- J) Panel Connectors, comes standard with panels and universal corner post

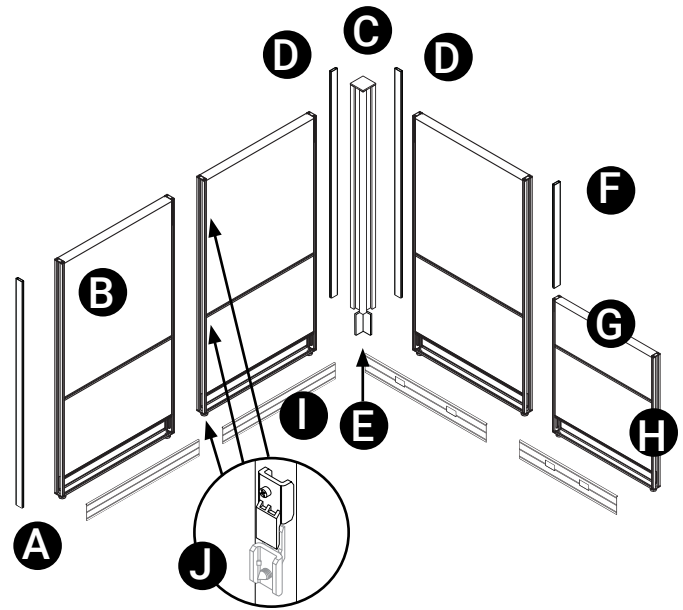

Components • Worksurfaces

- Compile thermally fused Worksurfaces are 1" thick and are finished with 3 mm PVC edging on all sides.
- Worksurfaces have pilot holes to enable proper alignment with worksurface supports.
- Most standard laminate offerings are available in thermally-fused. See laminate listings for details.
- Wood grain laminates on corner worksurfaces up to 42" available with laminate running diagonally at an upcharge. Otherwise, standard horizontal application of laminate will be used, as per drawings at right.
- Most wood grain laminate worksurfaces will have matching woodgrain trim unless specified otherwise.
- Depth of the worksurface scoops are 1 1/8" when measured from the panel the worksurface is attached to.
- All worksurfaces require support items. These are priced separately within this section.
- Grain direction for worksurfaces are as follows:
- Communication and electrical wires are routed through a cable scoop located at the back of the worksurface. When specifying a Straight Worksurface (CWS) or a Curvilinear Worksurface (CWVL), note that the number of cable scoops depends upon the width of the worksurface. All other Worksurface shapes have one scoop on panel edges.

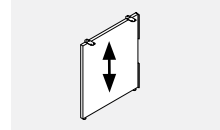

CHEP End Panels

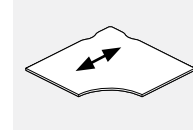

CWCC Worksurfaces

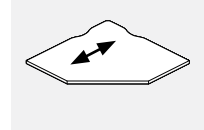

CWCF Worksurfaces

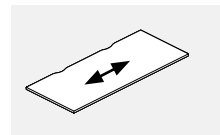

CWS Worksurfaces

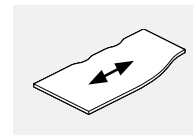

CWVL/R Worksurfaces

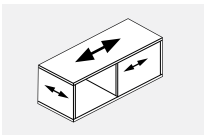

CWQRC Worksurfaces

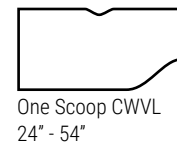

One Scoop CWVL
24" - 54"

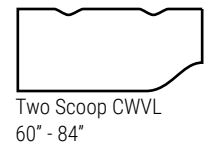

Two Scoop CWVL
60" - 84"

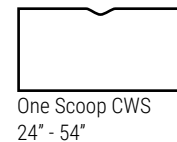

One Scoop CWS
24" - 54"

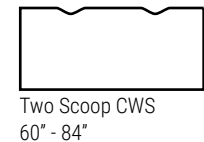

Two Scoop CWS
60" - 84"

Components • Electrical

2+2 Configuration (8 wire, 4 circuit)

Two Utility Circuits [Compile's #1 & #2 circuits] share one neutral wire and one (system) ground wire. (2 hot [circuit] wires + 1 neutral wire*** + 1 green ground wire* = 4 wires)

Two Dedicated Circuits [Compile's "A" & "B" circuits] share one neutral wire and one (isolated) ground wire. (2 hot [circuit] wires + neutral wire *** + 1 green/yellow ground wire** = 4 wires)

Note: It is the ground wire that makes the difference between "Utility" and "Dedicated" circuits. Refer to Wiring Schematics found above.

*A Green ground wire is a "system" ground. This means it could be grounded to any piece of metal, including the panel.

**A Green/Yellow ground wire is isolated, within the wiring conduit, all the way back to the box at the source (building ground).

***All neutral wires are 10 gauge rather than 12 gauge meaning they are larger than normal allowing greater protection against 'noise' or interference on the circuit.

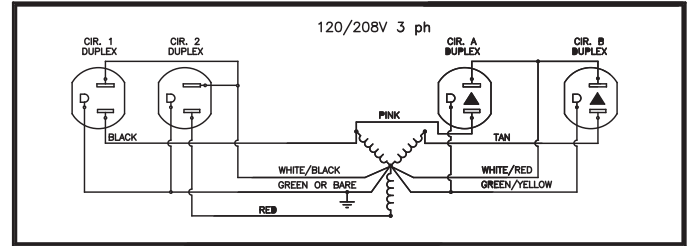
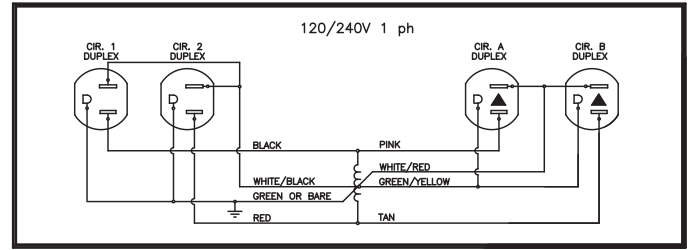

UL RECOGNIZED AND CSA CERTIFIED

Warning: It is recommended that installation of the electrical harness be made under the supervision of a licensed electrician in accordance with applicable codes and regulations.

Special Note: Always ensure that harness is electrically connected to only one power supply.

Components • Panel Configuration - Electrical

Many components make up a configuration. This page provides an exploded view of a sample configuration highlighting each Electrical component required when specifying this configuration.

A) CE8PD36 Power Distribution Housing

Note: 8 wire, 4 circuits, 2+2 configuration

B) CE8CP17 Flexible Mesh Jumper Cable (connects two panels side by side or separated by a post in a corner application)

C) CE8RD Duplex Receptacle

D) CE8CI1 "I" Connector

E) CE8CP Pass-Through Cable

Note: Must run in a straight line application only

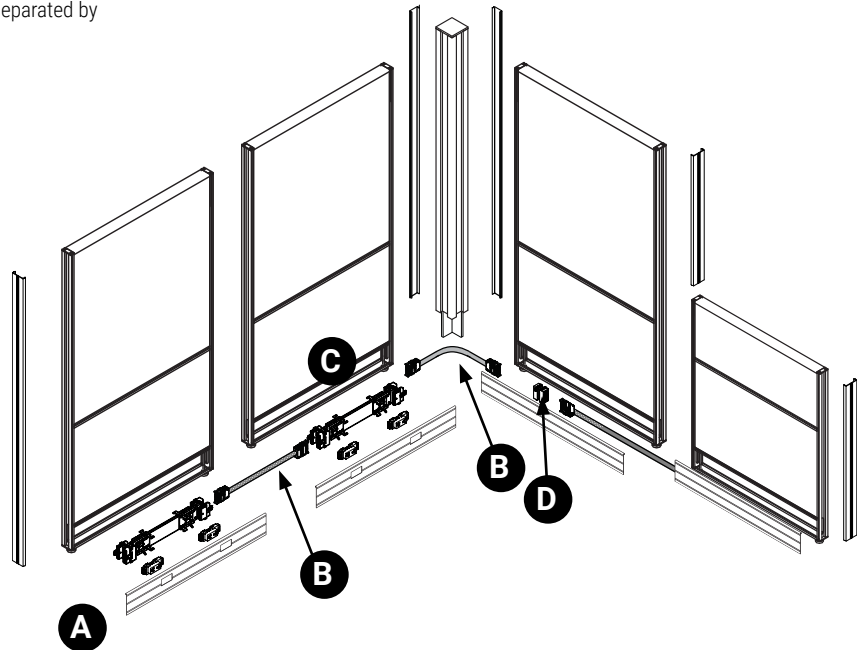

PANEL FINISHES

Panel Frame

| | |
|----------------|-----|
| Black | BLK |
| Designer White | DWT |
| Nevada | NEV |
| Fog | FOG |

Glazing Options

| | |
|---------|-----|
| Clear | CLR |
| Frosted | FRS |

COMPILE - GUIDELINES FOR ORDERING PRODUCT

Codes

The product guide uses a numbering system with meaningful alphanumeric characters to create a simple-to-understand product number. This makes specifying the product much easier and more accurate.

Example of Panel **CMFM4236** Product Code

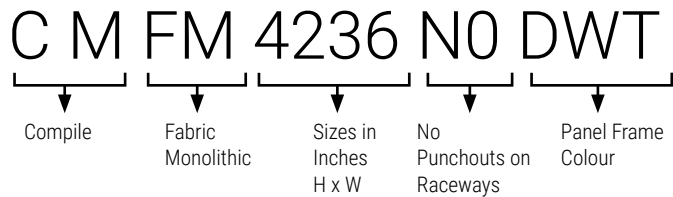

How to Specify

- Specify Compile panel type and size by code.
- Specify panel frame finish - ie. DWT (Designer White)
- Specify raceway power option.
- Specify all necessary panel fabric options.

The information listed below provides you with basic features of Compile Panels.

- Compile Panels can only be stacked one high.
- Available in four (4) basic heights: 30", 42", 54" and 66"; and seven (7) widths: 24", 30" 36", 42", 48", 54" and 60".
- 2 3/8" thick.
- Available in Monolithic and Single Segmented at just below the worksurface.
- Compile panels are not tackable.
- Raceway openings are 1.345" x 2.80".
- Opposite sides of each Module may have a different fabric within the same grade at no upcharge.
- Standard with aluminum frame.
- Individual fabric covered modules incorporated into an aluminum frame.
- Aluminum raceway covers can be ordered separately and shipped separately for reconfigurations. Raceway covers can be replaced in the field to change a panel from non powered to powered (or vice versa).

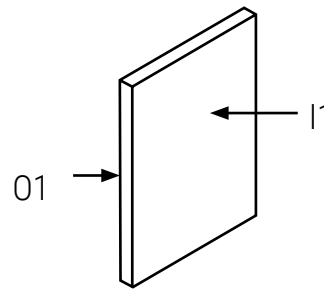

I1 AN50
01 BE21

Inside Fabric Position #1

Outside Fabric Position #1

NOTE: If different grades of fabric are used on one panel, the entire panel must be priced out at the higher grade.

- On Compile Laminate and Gallery panels, if a wood grain laminate is chosen, grain direction runs horizontally.
- Base raceway lifts up and locks in an upright 90-degree position, or can be removed for open access to base raceway.
- Electric knockouts in the raceway have plastic covers that snap into place from the outside of the cover, when a duplex is not required. Electric knockout covers must be specified separately.
- 3 panel connector brackets per side for 30"h., 42"h. and 54"h. come installed on panels and 60° and 90° posts.
- 4 panel connector brackets per side for 66"h. panels come installed on panels and 60° and 90° posts.
- Panel connector brackets are opposite direction of each other per panel side, and can be removed with one screw per bracket.
- CMFF and CMFM 66" and 72" panels must have fabric railroaded. Please confirm at time of order if all panels or only those need fabric to be railroaded.

CMFM-N0 • Monolithic Non Powered Fabric Panel, No Punchouts

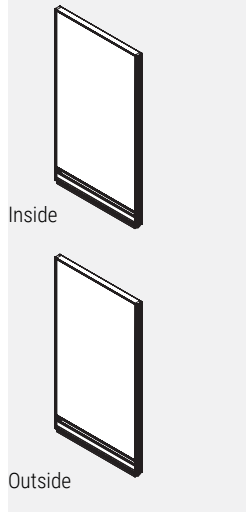

- Individual fabric-covered modules incorporated into an aluminum frame.
- Opposite sides of each module may have a different fabric within the same grade at no upcharge.
- If different grades of fabric are used on one panel, the entire panel must be priced at highest grade.
- Panels are not tackable.
- 3 Panel connector brackets per side come standard with 30”h., 42”h. and 54”h. panels.
- 4 Panel connector brackets per side come standard with 66”h. panels.
- Panels include 2 raceway covers with no punchouts, an integrated aluminum top cap and levelling glides.
- Note: Trim is not required at a straight connection between two panels of the same height.

| PRODUCT CODE | PRICE | | SIZE/ INCHES | | | WEIGHT VOL | |
|--------------|-------|------|--------------|----|-----|------------|------|
| | GR 1 | GR 2 | H | W | D | LBS | FT³ |
| CMFM3024N0 | 271 | 298 | 30 | 24 | 2.3 | 20 | 2.31 |
| CMFM3030N0 | 336 | 363 | 30 | 30 | 2.3 | 25 | 2.85 |
| CMFM3036N0 | 365 | 412 | 30 | 36 | 2.3 | 31 | 3.38 |
| CMFM3042N0 | 399 | 450 | 30 | 42 | 2.3 | 36 | 3.92 |
| CMFM3048N0 | 433 | 483 | 30 | 48 | 2.3 | 41 | 4.45 |
| CMFM3054N0 | 477 | 524 | 30 | 54 | 2.3 | 46 | 4.99 |
| CMFM3060N0 | 507 | 553 | 30 | 60 | 2.3 | 51 | 5.52 |
| CMFM4224N0 | 271 | 298 | 42 | 24 | 2.3 | 20 | 2.31 |
| CMFM4230N0 | 336 | 363 | 42 | 30 | 2.3 | 25 | 2.85 |
| CMFM4236N0 | 365 | 412 | 42 | 36 | 2.3 | 31 | 3.38 |
| CMFM4242N0 | 399 | 450 | 42 | 42 | 2.3 | 36 | 3.92 |
| CMFM4248N0 | 433 | 483 | 42 | 48 | 2.3 | 41 | 4.45 |
| CMFM4254N0 | 477 | 524 | 42 | 54 | 2.3 | 46 | 4.99 |
| CMFM4260N0 | 507 | 553 | 42 | 60 | 2.3 | 51 | 5.52 |
| CMFM4824N0 | 309 | 340 | 48 | 24 | 2.3 | 26 | 2.73 |
| CMFM4830N0 | 350 | 380 | 48 | 30 | 2.3 | 33 | 3.37 |
| CMFM4836N0 | 398 | 443 | 48 | 36 | 2.3 | 39 | 4.00 |
| CMFM4842N0 | 454 | 514 | 48 | 42 | 2.3 | 46 | 4.63 |
| CMFM4848N0 | 490 | 551 | 48 | 48 | 2.3 | 52 | 5.26 |
| CMFM4854N0 | 539 | 596 | 48 | 54 | 2.3 | 59 | 5.89 |
| CMFM4860N0 | 570 | 630 | 48 | 60 | 2.3 | 65 | 6.53 |
| CMFM5424N0 | 309 | 340 | 54 | 24 | 2.3 | 26 | 2.73 |
| CMFM5430N0 | 350 | 380 | 54 | 30 | 2.3 | 33 | 3.37 |
| CMFM5436N0 | 398 | 443 | 54 | 36 | 2.3 | 39 | 4.00 |
| CMFM5442N0 | 454 | 514 | 54 | 42 | 2.3 | 46 | 4.63 |
| CMFM5448N0 | 490 | 551 | 54 | 48 | 2.3 | 52 | 5.26 |
| CMFM5454N0 | 539 | 596 | 54 | 54 | 2.3 | 59 | 5.89 |
| CMFM5460N0 | 570 | 630 | 54 | 60 | 2.3 | 65 | 6.53 |
| CMFM6624N0 | 354 | 396 | 66 | 24 | 2.3 | 32 | 3.58 |
| CMFM6630N0 | 412 | 452 | 66 | 30 | 2.3 | 40 | 4.40 |
| CMFM6636N0 | 503 | 578 | 66 | 36 | 2.3 | 48 | 5.23 |
| CMFM6642N0 | 555 | 631 | 66 | 42 | 2.3 | 56 | 6.06 |
| CMFM6648N0 | 575 | 652 | 66 | 48 | 2.3 | 64 | 6.88 |
| CMFM6654N0 | 591 | 666 | 66 | 54 | 2.3 | 72 | 7.71 |
| CMFM6660N0 | 609 | 686 | 66 | 60 | 2.3 | 80 | 8.53 |

CMFM-N1 • Monolithic Non Powered Fabric Panel, Punchouts on One Side

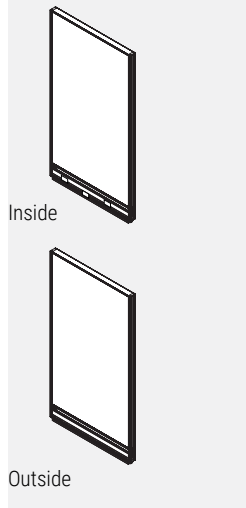

- Individual fabric-covered modules incorporated into an aluminum frame.
- Opposite sides of each module may have a different fabric within the same grade at no upcharge.
- If different grades of fabric are used on one panel, the entire panel must be priced at highest grade.
- Panels are not tackable.
- 3 Panel connector brackets per side come standard with 30”h., 42”h. and 54”h. panels.
- 4 Panel connector brackets per side come standard with 66”h. panels.
- Panels include 1 raceway cover with punchouts on one side, 1 raceway cover with no punchouts on the other, an integrated aluminum top cap and levelling glides.
- 24” wide panels have one punchout, 30” wide panels and wider have 3 punchouts.
- Note: Trim is not required at a straight connection between two panels of the same height.

| PRODUCT CODE | PRICE | | SIZE/ INCHES | | | WEIGHT VOL | |
|--------------|-------|------|--------------|----|-----|------------|------|
| | GR 1 | GR 2 | H | W | D | LBS | FT³ |
| CMFM3024N1 | 271 | 298 | 30 | 24 | 2.3 | 20 | 2.31 |
| CMFM3030N1 | 336 | 363 | 30 | 30 | 2.3 | 25 | 2.85 |
| CMFM3036N1 | 365 | 412 | 30 | 36 | 2.3 | 31 | 3.38 |
| CMFM3042N1 | 399 | 450 | 30 | 42 | 2.3 | 36 | 3.92 |
| CMFM3048N1 | 433 | 483 | 30 | 48 | 2.3 | 41 | 4.45 |
| CMFM3054N1 | 477 | 524 | 30 | 54 | 2.3 | 46 | 4.99 |
| CMFM3060N1 | 507 | 553 | 30 | 60 | 2.3 | 51 | 5.52 |
| CMFM4224N1 | 271 | 298 | 42 | 24 | 2.3 | 20 | 2.31 |
| CMFM4230N1 | 336 | 363 | 42 | 30 | 2.3 | 25 | 2.85 |
| CMFM4236N1 | 365 | 412 | 42 | 36 | 2.3 | 31 | 3.38 |
| CMFM4242N1 | 399 | 450 | 42 | 42 | 2.3 | 36 | 3.92 |
| CMFM4248N1 | 433 | 483 | 42 | 48 | 2.3 | 41 | 4.45 |
| CMFM4254N1 | 477 | 524 | 42 | 54 | 2.3 | 46 | 4.99 |
| CMFM4260N1 | 507 | 553 | 42 | 60 | 2.3 | 51 | 5.52 |
| CMFM4824N1 | 309 | 340 | 48 | 24 | 2.3 | 26 | 2.73 |
| CMFM4830N1 | 350 | 380 | 48 | 30 | 2.3 | 33 | 3.37 |
| CMFM4836N1 | 398 | 443 | 48 | 36 | 2.3 | 39 | 4.00 |
| CMFM4842N1 | 454 | 514 | 48 | 42 | 2.3 | 46 | 4.63 |
| CMFM4848N1 | 490 | 551 | 48 | 48 | 2.3 | 52 | 5.26 |
| CMFM4854N1 | 539 | 596 | 48 | 54 | 2.3 | 59 | 5.89 |
| CMFM4860N1 | 570 | 630 | 48 | 60 | 2.3 | 65 | 6.53 |
| CMFM5424N1 | 309 | 340 | 54 | 24 | 2.3 | 26 | 2.73 |
| CMFM5430N1 | 350 | 380 | 54 | 30 | 2.3 | 33 | 3.37 |
| CMFM5436N1 | 398 | 443 | 54 | 36 | 2.3 | 39 | 4.00 |
| CMFM5442N1 | 454 | 514 | 54 | 42 | 2.3 | 46 | 4.63 |
| CMFM5448N1 | 490 | 551 | 54 | 48 | 2.3 | 52 | 5.26 |
| CMFM5454N1 | 539 | 596 | 54 | 54 | 2.3 | 59 | 5.89 |
| CMFM5460N1 | 570 | 630 | 54 | 60 | 2.3 | 65 | 6.53 |
| CMFM6624N1 | 354 | 396 | 66 | 24 | 2.3 | 32 | 3.58 |
| CMFM6630N1 | 412 | 452 | 66 | 30 | 2.3 | 40 | 4.40 |
| CMFM6636N1 | 503 | 578 | 66 | 36 | 2.3 | 48 | 5.23 |
| CMFM6642N1 | 555 | 631 | 66 | 42 | 2.3 | 56 | 6.06 |
| CMFM6648N1 | 575 | 652 | 66 | 48 | 2.3 | 64 | 6.88 |
| CMFM6654N1 | 591 | 666 | 66 | 54 | 2.3 | 72 | 7.71 |
| CMFM6660N1 | 609 | 686 | 66 | 60 | 2.3 | 80 | 8.53 |

CMFM-N2 • Monolithic Non Powered Fabric Panel, Punchouts on Both Sides

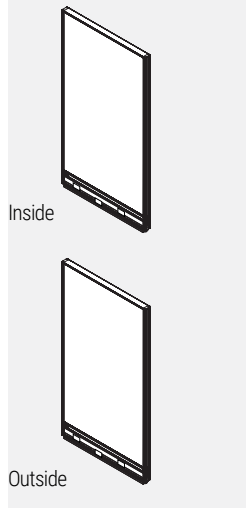

- Individual fabric-covered modules incorporated into an aluminum frame.
- Opposite sides of each module may have a different fabric within the same grade at no upcharge.
- If different grades of fabric are used on one panel, the entire panel must be priced at highest grade.
- Panels are not tackable.
- 3 Panel connector brackets per side come standard with 30”h., 42”h. and 54”h. panels.
- 4 Panel connector brackets per side come standard with 66”h. panels.
- Panels include 2 raceway covers with punchouts on both sides, an integrated aluminum top cap and levelling glides.
- 24” wide panels have two punchouts, one for electrical and one for data.
- 30” wide panels and wider have three punchouts, two for electrical and one for data.
- Note: Trim is not required at a straight connection between two panels of the same height.

| PRODUCT CODE | PRICE | | SIZE/ INCHES | | | WEIGHT VOL | |
|--------------|-------|------|--------------|----|-----|------------|-----------------|
| | GR 1 | GR 2 | H | W | D | LBS | FT ³ |
| CMFM3024N2 | 271 | 298 | 30 | 24 | 2.3 | 20 | 2.31 |
| CMFM3030N2 | 336 | 363 | 30 | 30 | 2.3 | 25 | 2.85 |
| CMFM3036N2 | 365 | 412 | 30 | 36 | 2.3 | 31 | 3.38 |
| CMFM3042N2 | 399 | 450 | 30 | 42 | 2.3 | 36 | 3.92 |
| CMFM3048N2 | 433 | 483 | 30 | 48 | 2.3 | 41 | 4.45 |
| CMFM3054N2 | 477 | 524 | 30 | 54 | 2.3 | 46 | 4.99 |
| CMFM3060N2 | 507 | 553 | 30 | 60 | 2.3 | 51 | 5.52 |
| CMFM4224N2 | 271 | 298 | 42 | 24 | 2.3 | 20 | 2.31 |
| CMFM4230N2 | 336 | 363 | 42 | 30 | 2.3 | 25 | 2.85 |
| CMFM4236N2 | 365 | 412 | 42 | 36 | 2.3 | 31 | 3.38 |
| CMFM4242N2 | 399 | 450 | 42 | 42 | 2.3 | 36 | 3.92 |
| CMFM4248N2 | 433 | 483 | 42 | 48 | 2.3 | 41 | 4.45 |
| CMFM4254N2 | 477 | 524 | 42 | 54 | 2.3 | 46 | 4.99 |
| CMFM4260N2 | 507 | 553 | 42 | 60 | 2.3 | 51 | 5.52 |
| CMFM4824N2 | 309 | 340 | 48 | 24 | 2.3 | 26 | 2.73 |
| CMFM4830N2 | 350 | 380 | 48 | 30 | 2.3 | 33 | 3.37 |
| CMFM4836N2 | 398 | 443 | 48 | 36 | 2.3 | 39 | 4.00 |
| CMFM4842N2 | 454 | 514 | 48 | 42 | 2.3 | 46 | 4.63 |
| CMFM4848N2 | 490 | 551 | 48 | 48 | 2.3 | 52 | 5.26 |
| CMFM4854N2 | 539 | 596 | 48 | 54 | 2.3 | 59 | 5.89 |
| CMFM4860N2 | 570 | 630 | 48 | 60 | 2.3 | 65 | 6.53 |
| CMFM5424N2 | 309 | 340 | 54 | 24 | 2.3 | 26 | 2.73 |
| CMFM5430N2 | 350 | 380 | 54 | 30 | 2.3 | 33 | 3.37 |
| CMFM5436N2 | 398 | 443 | 54 | 36 | 2.3 | 39 | 4.00 |
| CMFM5442N2 | 454 | 514 | 54 | 42 | 2.3 | 46 | 4.63 |
| CMFM5448N2 | 490 | 551 | 54 | 48 | 2.3 | 52 | 5.26 |
| CMFM5454N2 | 539 | 596 | 54 | 54 | 2.3 | 59 | 5.89 |
| CMFM5460N2 | 570 | 630 | 54 | 60 | 2.3 | 65 | 6.53 |
| CMFM6624N2 | 354 | 396 | 66 | 24 | 2.3 | 32 | 3.58 |
| CMFM6630N2 | 412 | 452 | 66 | 30 | 2.3 | 40 | 4.40 |
| CMFM6636N2 | 503 | 578 | 66 | 36 | 2.3 | 48 | 5.23 |
| CMFM6642N2 | 555 | 631 | 66 | 42 | 2.3 | 56 | 6.06 |
| CMFM6648N2 | 575 | 652 | 66 | 48 | 2.3 | 64 | 6.88 |
| CMFM6654N2 | 591 | 666 | 66 | 54 | 2.3 | 72 | 7.71 |
| CMFM6660N2 | 609 | 686 | 66 | 60 | 2.3 | 80 | 8.53 |

CMFM-P1 • Monolithic Fabric Panel with Power Distribution Housing, Punchouts on One Side

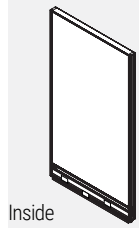

Inside

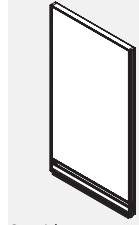

Outside

- Individual fabric-covered modules incorporated into an aluminum frame.
- Opposite sides of each module may have a different fabric within the same grade at no upcharge.
- If different grades of fabric are used on one panel, the entire panel must be priced at highest grade.
- Panels are not tackable.
- 3 Panel connector brackets per side come standard with 30"h., 42"h. and 54"h. panels.
- 4 Panel connector brackets per side come standard with 66"h. panels.
- Panels include 1 raceway cover with punchouts on one side, 1 raceway cover with no punchouts on the other, a power distribution housing, an integrated aluminum top cap and levelling glides.
- 24" wide panels have two punchouts, one for electrical and one for data.
- 30" wide panels and wider have three punchouts, two for electrical and one for data.
- Note: Trim is not required at a straight connection between two panels of the same height.
- Please specify duplex receptacles separately.

| PRODUCT CODE | PRICE | | SIZE/ INCHES | | | WEIGHT VOL | |
|--------------|-------|------|--------------|----|-----|------------|-----------------|
| | GR 1 | GR 2 | H | W | D | LBS | FT ³ |
| CMFM3024P1 | 410 | 435 | 30 | 24 | 2.3 | 20 | 2.31 |
| CMFM3030P1 | 521 | 547 | 30 | 30 | 2.3 | 25 | 2.85 |
| CMFM3036P1 | 561 | 609 | 30 | 36 | 2.3 | 31 | 3.38 |
| CMFM3042P1 | 603 | 653 | 30 | 42 | 2.3 | 36 | 3.92 |
| CMFM3048P1 | 647 | 695 | 30 | 48 | 2.3 | 41 | 4.45 |
| CMFM3054P1 | 693 | 745 | 30 | 54 | 2.3 | 46 | 4.99 |
| CMFM3060P1 | 723 | 775 | 30 | 60 | 2.3 | 51 | 5.52 |
| CMFM4224P1 | 410 | 435 | 42 | 24 | 2.3 | 20 | 2.31 |
| CMFM4230P1 | 521 | 547 | 42 | 30 | 2.3 | 25 | 2.85 |
| CMFM4236P1 | 561 | 609 | 42 | 36 | 2.3 | 31 | 3.38 |
| CMFM4242P1 | 603 | 653 | 42 | 42 | 2.3 | 36 | 3.92 |
| CMFM4248P1 | 647 | 695 | 42 | 48 | 2.3 | 41 | 4.45 |
| CMFM4254P1 | 693 | 745 | 42 | 54 | 2.3 | 46 | 4.99 |
| CMFM4260P1 | 723 | 775 | 42 | 60 | 2.3 | 51 | 5.52 |
| CMFM4824P1 | 449 | 478 | 48 | 24 | 2.3 | 26 | 2.73 |
| CMFM4830P1 | 539 | 568 | 48 | 30 | 2.3 | 33 | 3.37 |
| CMFM4836P1 | 593 | 639 | 48 | 36 | 2.3 | 39 | 4.00 |
| CMFM4842P1 | 656 | 717 | 48 | 42 | 2.3 | 46 | 4.63 |
| CMFM4848P1 | 707 | 765 | 48 | 48 | 2.3 | 52 | 5.26 |
| CMFM4854P1 | 754 | 814 | 48 | 54 | 2.3 | 59 | 5.89 |
| CMFM4860P1 | 788 | 850 | 48 | 60 | 2.3 | 65 | 6.53 |
| CMFM5424P1 | 449 | 478 | 54 | 24 | 2.3 | 26 | 2.73 |
| CMFM5430P1 | 539 | 568 | 54 | 30 | 2.3 | 33 | 3.37 |
| CMFM5436P1 | 593 | 639 | 54 | 36 | 2.3 | 39 | 4.00 |
| CMFM5442P1 | 656 | 717 | 54 | 42 | 2.3 | 46 | 4.63 |
| CMFM5448P1 | 707 | 765 | 54 | 48 | 2.3 | 52 | 5.26 |
| CMFM5454P1 | 754 | 814 | 54 | 54 | 2.3 | 59 | 5.89 |
| CMFM5460P1 | 788 | 850 | 54 | 60 | 2.3 | 65 | 6.53 |
| CMFM6624P1 | 494 | 536 | 66 | 24 | 2.3 | 32 | 3.58 |
| CMFM6630P1 | 602 | 639 | 66 | 30 | 2.3 | 40 | 4.40 |
| CMFM6636P1 | 697 | 775 | 66 | 36 | 2.3 | 48 | 5.23 |
| CMFM6642P1 | 758 | 833 | 66 | 42 | 2.3 | 56 | 6.06 |
| CMFM6648P1 | 788 | 864 | 66 | 48 | 2.3 | 64 | 6.88 |
| CMFM6654P1 | 809 | 884 | 66 | 54 | 2.3 | 72 | 7.71 |
| CMFM6660P1 | 827 | 903 | 66 | 60 | 2.3 | 80 | 8.53 |

CMFM-P2 • Monolithic Fabric Panel with Power Distribution Housing, Punchouts on Both Sides

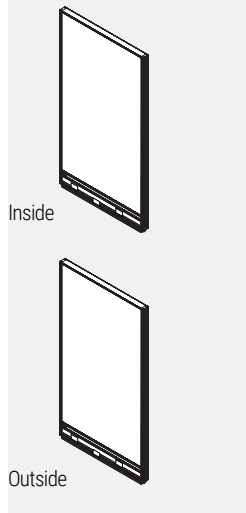

- Individual fabric-covered modules incorporated into an aluminum frame.
- Opposite sides of each module may have a different fabric within the same grade at no upcharge.
- If different grades of fabric are used on one panel, the entire panel must be priced at highest grade.
- Panels are not tackable.
- 3 Panel connector brackets per side come standard with 30”h., 42”h. and 54”h. panels.
- 4 Panel connector brackets per side come standard with 66”h. panels.
- Panels include 2 raceway covers with punchouts on both sides, a power distribution housing, an integrated aluminum top cap and levelling glides.
- 24” wide panels have two punchouts, one for electrical and one for data.
- 30” wide panels and wider have three punchouts, two for electrical and one for data.
- Note: Trim is not required at a straight connection between two panels of the same height.
- Please specify duplex receptacles separately.

| PRODUCT CODE | PRICE | | SIZE/ INCHES | | | WEIGHT VOL | |
|--------------|-------|------|--------------|----|-----|------------|------|
| | GR 1 | GR 2 | H | W | D | LBS | FT³ |
| CMFM3024P2 | 410 | 435 | 30 | 24 | 2.3 | 20 | 2.31 |
| CMFM3030P2 | 521 | 547 | 30 | 30 | 2.3 | 25 | 2.85 |
| CMFM3036P2 | 561 | 609 | 30 | 36 | 2.3 | 31 | 3.38 |
| CMFM3042P2 | 603 | 653 | 30 | 42 | 2.3 | 36 | 3.92 |
| CMFM3048P2 | 647 | 695 | 30 | 48 | 2.3 | 41 | 4.45 |
| CMFM3054P2 | 693 | 745 | 30 | 54 | 2.3 | 46 | 4.99 |
| CMFM3060P2 | 723 | 775 | 30 | 60 | 2.3 | 51 | 5.52 |
| CMFM4224P2 | 410 | 435 | 42 | 24 | 2.3 | 20 | 2.31 |
| CMFM4230P2 | 521 | 547 | 42 | 30 | 2.3 | 25 | 2.85 |
| CMFM4236P2 | 561 | 609 | 42 | 36 | 2.3 | 31 | 3.38 |
| CMFM4242P2 | 603 | 653 | 42 | 42 | 2.3 | 36 | 3.92 |
| CMFM4248P2 | 647 | 695 | 42 | 48 | 2.3 | 41 | 4.45 |
| CMFM4254P2 | 693 | 745 | 42 | 54 | 2.3 | 46 | 4.99 |
| CMFM4260P2 | 723 | 775 | 42 | 60 | 2.3 | 51 | 5.52 |
| CMFM4824P2 | 449 | 478 | 48 | 24 | 2.3 | 26 | 2.73 |
| CMFM4830P2 | 539 | 568 | 48 | 30 | 2.3 | 33 | 3.37 |
| CMFM4836P2 | 593 | 639 | 48 | 36 | 2.3 | 39 | 4.00 |
| CMFM4842P2 | 656 | 717 | 48 | 42 | 2.3 | 46 | 4.63 |
| CMFM4848P2 | 707 | 765 | 48 | 48 | 2.3 | 52 | 5.26 |
| CMFM4854P2 | 754 | 814 | 48 | 54 | 2.3 | 59 | 5.89 |
| CMFM4860P2 | 788 | 850 | 48 | 60 | 2.3 | 65 | 6.53 |
| CMFM5424P2 | 449 | 478 | 54 | 24 | 2.3 | 26 | 2.73 |
| CMFM5430P2 | 539 | 568 | 54 | 30 | 2.3 | 33 | 3.37 |
| CMFM5436P2 | 593 | 639 | 54 | 36 | 2.3 | 39 | 4.00 |
| CMFM5442P2 | 656 | 717 | 54 | 42 | 2.3 | 46 | 4.63 |
| CMFM5448P2 | 707 | 765 | 54 | 48 | 2.3 | 52 | 5.26 |
| CMFM5454P2 | 754 | 814 | 54 | 54 | 2.3 | 59 | 5.89 |
| CMFM5460P2 | 788 | 850 | 54 | 60 | 2.3 | 65 | 6.53 |
| CMFM6624P2 | 494 | 536 | 66 | 24 | 2.3 | 32 | 3.58 |
| CMFM6630P2 | 602 | 639 | 66 | 30 | 2.3 | 40 | 4.40 |
| CMFM6636P2 | 697 | 775 | 66 | 36 | 2.3 | 48 | 5.23 |
| CMFM6642P2 | 758 | 833 | 66 | 42 | 2.3 | 56 | 6.06 |
| CMFM6648P2 | 788 | 864 | 66 | 48 | 2.3 | 64 | 6.88 |
| CMFM6654P2 | 809 | 884 | 66 | 54 | 2.3 | 72 | 7.71 |
| CMFM6660P2 | 827 | 903 | 66 | 60 | 2.3 | 80 | 8.53 |

CMLFM-N0 • Monolithic Non Powered Laminate One Side, Fabric One Side Panel, No Punchouts

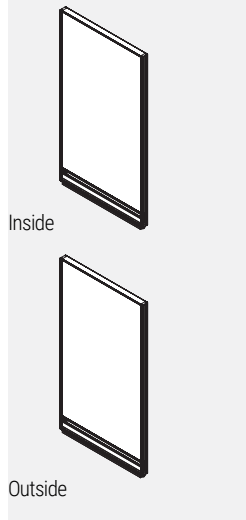

- Individual modules, one in fabric and one in laminate, incorporated into an aluminum frame.
- Panels are not tackable.
- 3 panel connector brackets per side come standard with 30”h., 42”h., and 54”h. panels.
- 4 panel connector brackets per side come standard with 66”h. panels.
- Panels include 2 raceway covers with no punchouts, an integrated aluminum top cap and levelling glides.
- Note: Trim is not required at a straight connection between two panels of the same height.

| PRODUCT CODE | PRICE | | SIZE/ INCHES | | | WEIGHT VOL | |
|--------------|-------|------|--------------|----|-----|------------|------|
| | GR 1 | GR 2 | H | W | D | LBS | FT³ |
| CMLFM3024N0 | 391 | 399 | 30 | 24 | 2.3 | 20 | 2.31 |
| CMLFM3030N0 | 456 | 469 | 30 | 30 | 2.3 | 25 | 2.85 |
| CMLFM3036N0 | 520 | 535 | 30 | 36 | 2.3 | 31 | 3.38 |
| CMLFM3042N0 | 591 | 604 | 30 | 42 | 2.3 | 36 | 3.92 |
| CMLFM3048N0 | 639 | 654 | 30 | 48 | 2.3 | 41 | 4.45 |
| CMLFM3054N0 | 713 | 725 | 30 | 54 | 2.3 | 46 | 4.99 |
| CMLFM3060N0 | 770 | 794 | 30 | 60 | 2.3 | 51 | 5.52 |
| CMLFM4224N0 | 464 | 477 | 42 | 24 | 2.3 | 20 | 2.31 |
| CMLFM4230N0 | 542 | 553 | 42 | 30 | 2.3 | 25 | 2.85 |
| CMLFM4236N0 | 623 | 641 | 42 | 36 | 2.3 | 31 | 3.38 |
| CMLFM4242N0 | 707 | 724 | 42 | 42 | 2.3 | 36 | 3.92 |
| CMLFM4248N0 | 766 | 788 | 42 | 48 | 2.3 | 41 | 4.45 |
| CMLFM4254N0 | 853 | 877 | 42 | 54 | 2.3 | 46 | 4.99 |
| CMLFM4260N0 | 935 | 960 | 42 | 60 | 2.3 | 51 | 5.52 |
| CMLFM4824N0 | 550 | 573 | 48 | 24 | 2.3 | 26 | 2.73 |
| CMLFM4830N0 | 647 | 665 | 48 | 30 | 2.3 | 33 | 3.37 |
| CMLFM4836N0 | 741 | 762 | 48 | 36 | 2.3 | 39 | 4.00 |
| CMLFM4842N0 | 839 | 863 | 48 | 42 | 2.3 | 46 | 4.63 |
| CMLFM4848N0 | 917 | 943 | 48 | 48 | 2.3 | 52 | 5.26 |
| CMLFM4854N0 | 1021 | 1052 | 48 | 54 | 2.3 | 59 | 5.89 |
| CMLFM5424N0 | 550 | 573 | 54 | 24 | 2.3 | 65 | 6.53 |
| CMLFM5430N0 | 647 | 665 | 54 | 30 | 2.3 | 33 | 3.37 |
| CMLFM5436N0 | 741 | 762 | 54 | 36 | 2.3 | 39 | 4.00 |
| CMLFM5442N0 | 839 | 863 | 54 | 42 | 2.3 | 46 | 4.63 |
| CMLFM5448N0 | 917 | 943 | 54 | 48 | 2.3 | 52 | 5.26 |
| CMLFM5454N0 | 1021 | 1052 | 54 | 54 | 2.3 | 59 | 5.89 |
| CMLFM6624N0 | 683 | 699 | 66 | 24 | 2.3 | 32 | 3.58 |
| CMLFM6630N0 | 796 | 820 | 66 | 30 | 2.3 | 40 | 4.40 |
| CMLFM6636N0 | 918 | 947 | 66 | 36 | 2.3 | 48 | 5.23 |
| CMLFM6642N0 | 1046 | 1078 | 66 | 42 | 2.3 | 56 | 6.06 |
| CMLFM6648N0 | 1139 | 1174 | 66 | 48 | 2.3 | 64 | 6.68 |

CMLFM-N1 • Monolithic Non Powered Laminate One Side, Fabric Other, Punchouts on One Side

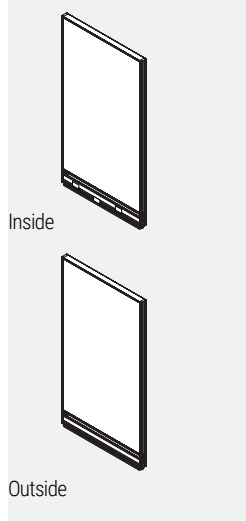

- Individual modules, one in fabric and one in laminate, incorporated into an aluminum frame.
- Panels are not tackable.
- 3 panel connector brackets per side come standard with 30”h., 42”h., and 54”h. panels.
- 4 panel connector brackets per side come standard with 66”h. panels.
- Panels include 1 raceway cover with punchouts on one side, 1 raceway cover with no punchouts on the other, an integrated aluminum top cap and levelling glides.
- 24” wide panels have two punchouts, one for electrical and one for data.
- 30” wide panels and wider have three punchouts, two for electrical and one for data.
- Note: Trim is not required at a straight connection between two panels of the same height.

| PRODUCT CODE | PRICE | | SIZE/ INCHES | | | WEIGHT VOL | |
|--------------|-------|------|--------------|----|-----|------------|------|
| | GR 1 | GR 2 | H | W | D | LBS | FT³ |
| CMLFM3024N1 | 391 | 399 | 30 | 24 | 2.3 | 20 | 2.31 |
| CMLFM3030N1 | 456 | 469 | 30 | 30 | 2.3 | 25 | 2.85 |
| CMLFM3036N1 | 520 | 535 | 30 | 36 | 2.3 | 31 | 3.38 |
| CMLFM3042N1 | 591 | 604 | 30 | 42 | 2.3 | 36 | 3.92 |
| CMLFM3048N1 | 639 | 654 | 30 | 48 | 2.3 | 41 | 4.45 |
| CMLFM3054N1 | 713 | 725 | 30 | 54 | 2.3 | 46 | 4.99 |
| CMLFM3060N1 | 770 | 794 | 30 | 60 | 2.3 | 51 | 5.52 |
| CMLFM4224N1 | 464 | 477 | 42 | 24 | 2.3 | 20 | 2.31 |
| CMLFM4230N1 | 542 | 553 | 42 | 30 | 2.3 | 25 | 2.85 |
| CMLFM4236N1 | 623 | 641 | 42 | 36 | 2.3 | 31 | 3.38 |
| CMLFM4242N1 | 707 | 724 | 42 | 42 | 2.3 | 36 | 3.92 |
| CMLFM4248N1 | 766 | 788 | 42 | 48 | 2.3 | 41 | 4.45 |
| CMLFM4254N1 | 853 | 877 | 42 | 54 | 2.3 | 46 | 4.99 |
| CMLFM4260N1 | 935 | 960 | 42 | 60 | 2.3 | 51 | 5.52 |
| CMLFM4824N1 | 550 | 573 | 48 | 24 | 2.3 | 26 | 2.73 |
| CMLFM4830N1 | 647 | 665 | 48 | 30 | 2.3 | 33 | 3.37 |
| CMLFM4836N1 | 741 | 762 | 48 | 36 | 2.3 | 39 | 4.00 |
| CMLFM4842N1 | 839 | 863 | 48 | 42 | 2.3 | 46 | 4.63 |
| CMLFM4848N1 | 917 | 943 | 48 | 48 | 2.3 | 52 | 5.26 |
| CMLFM4854N1 | 1021 | 1052 | 48 | 54 | 2.3 | 59 | 5.89 |
| CMLFM5424N1 | 550 | 573 | 54 | 24 | 2.3 | 65 | 6.53 |
| CMLFM5430N1 | 647 | 665 | 54 | 30 | 2.3 | 33 | 3.37 |
| CMLFM5436N1 | 741 | 762 | 54 | 36 | 2.3 | 39 | 4.00 |
| CMLFM5442N1 | 839 | 863 | 54 | 42 | 2.3 | 46 | 4.63 |
| CMLFM5448N1 | 917 | 943 | 54 | 48 | 2.3 | 52 | 5.26 |
| CMLFM5454N1 | 1021 | 1052 | 54 | 54 | 2.3 | 59 | 5.89 |
| CMLFM6624N1 | 683 | 699 | 66 | 24 | 2.3 | 32 | 3.58 |
| CMLFM6630N1 | 796 | 820 | 66 | 30 | 2.3 | 40 | 4.40 |
| CMLFM6636N1 | 918 | 947 | 66 | 36 | 2.3 | 48 | 5.23 |
| CMLFM6642N1 | 1046 | 1078 | 66 | 42 | 2.3 | 56 | 6.06 |
| CMLFM6648N1 | 1139 | 1174 | 66 | 48 | 2.3 | 64 | 6.68 |

CMLFM-N2 • Monolithic Non Powered Laminate 1 Side, Fabric Other Panel, Punchouts on Both Sides

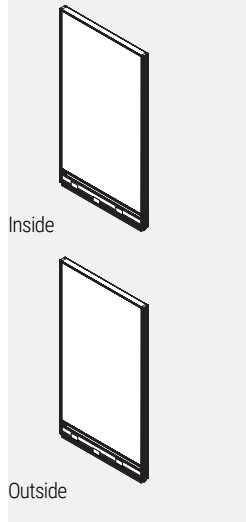

- Individual modules, one in fabric and one in laminate, incorporated into an aluminum frame.
- Panels are not tackable.
- 3 panel connector brackets per side come standard with 30”h., 42”h., and 54”h. panels.
- 4 panel connector brackets per side come standard with 66”h. panels.
- Panels include 2 raceway covers with punchouts, an integrated aluminum top cap and levelling glides.
- 24” wide panels have two punchouts, one for electrical and one for data.
- 30” wide panels and wider have three punchouts, two for electrical and one for data.
- Note: Trim is not required at a straight connection between two panels of the same height.

| PRODUCT CODE | PRICE | | SIZE/ INCHES | | | WEIGHT VOL | |
|--------------|-------|------|--------------|----|-----|------------|------|
| | GR 1 | GR 2 | H | W | D | LBS | FT³ |
| CMLFM3024N2 | 391 | 399 | 30 | 24 | 2.3 | 20 | 2.31 |
| CMLFM3030N2 | 456 | 469 | 30 | 30 | 2.3 | 25 | 2.85 |
| CMLFM3036N2 | 520 | 535 | 30 | 36 | 2.3 | 31 | 3.38 |
| CMLFM3042N2 | 591 | 604 | 30 | 42 | 2.3 | 36 | 3.92 |
| CMLFM3048N2 | 639 | 654 | 30 | 48 | 2.3 | 41 | 4.45 |
| CMLFM3054N2 | 713 | 725 | 30 | 54 | 2.3 | 46 | 4.99 |
| CMLFM3060N2 | 770 | 794 | 30 | 60 | 2.3 | 51 | 5.52 |
| CMLFM4224N2 | 464 | 477 | 42 | 24 | 2.3 | 20 | 2.31 |
| CMLFM4230N2 | 542 | 553 | 42 | 30 | 2.3 | 25 | 2.85 |
| CMLFM4236N2 | 623 | 641 | 42 | 36 | 2.3 | 31 | 3.38 |
| CMLFM4242N2 | 707 | 724 | 42 | 42 | 2.3 | 36 | 3.92 |
| CMLFM4248N2 | 766 | 788 | 42 | 48 | 2.3 | 41 | 4.45 |
| CMLFM4254N2 | 853 | 877 | 42 | 54 | 2.3 | 46 | 4.99 |
| CMLFM4260N2 | 935 | 960 | 42 | 60 | 2.3 | 51 | 5.52 |
| CMLFM4824N2 | 550 | 573 | 48 | 24 | 2.3 | 26 | 2.73 |
| CMLFM4830N2 | 647 | 665 | 48 | 30 | 2.3 | 33 | 3.37 |
| CMLFM4836N2 | 741 | 762 | 48 | 36 | 2.3 | 39 | 4.00 |
| CMLFM4842N2 | 839 | 863 | 48 | 42 | 2.3 | 46 | 4.63 |
| CMLFM4848N2 | 917 | 943 | 48 | 48 | 2.3 | 52 | 5.26 |
| CMLFM4854N2 | 1021 | 1052 | 48 | 54 | 2.3 | 59 | 5.89 |
| CMLFM5424N2 | 550 | 573 | 54 | 24 | 2.3 | 65 | 6.53 |
| CMLFM5430N2 | 647 | 665 | 54 | 30 | 2.3 | 33 | 3.37 |
| CMLFM5436N2 | 741 | 762 | 54 | 36 | 2.3 | 39 | 4.00 |
| CMLFM5442N2 | 839 | 863 | 54 | 42 | 2.3 | 46 | 4.63 |
| CMLFM5448N2 | 917 | 943 | 54 | 48 | 2.3 | 52 | 5.26 |
| CMLFM5454N2 | 1021 | 1052 | 54 | 54 | 2.3 | 59 | 5.89 |
| CMLFM6624N2 | 683 | 699 | 66 | 24 | 2.3 | 32 | 3.58 |
| CMLFM6630N2 | 796 | 820 | 66 | 30 | 2.3 | 40 | 4.40 |
| CMLFM6636N2 | 918 | 947 | 66 | 36 | 2.3 | 48 | 5.23 |
| CMLFM6642N2 | 1046 | 1078 | 66 | 42 | 2.3 | 56 | 6.06 |
| CMLFM6648N2 | 1139 | 1174 | 66 | 48 | 2.3 | 64 | 6.68 |

CMLFM-P1 • Monolithic Laminate One Side, Fabric Other Side Panel with PDH, Punchouts on One Side

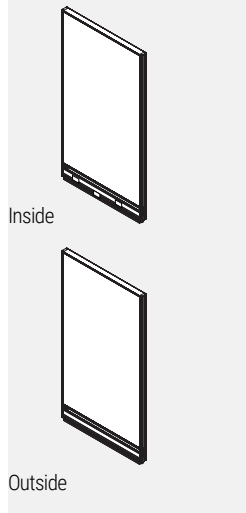

- Individual modules, one in fabric and one in laminate, incorporated into an aluminum frame.
- Panels are not tackable.
- 3 panel connector brackets per side come standard with 30”h., 42”h., and 54”h. panels.
- 4 panel connector brackets per side come standard with 66”h. panels.
- Panels include 1 raceway cover with punchouts on one side, 1 raceway cover with no punchouts on the other, a power distribution housing, an integrated aluminum top cap and levelling glides.
- 24” wide panels have two punchouts, one for electrical and one for data.
- 30” wide panels and wider have three punchouts, two for electrical and one for data.
- Note: Trim is not required at a straight connection between two panels of the same height.
- Please specify duplex receptacles separately.

| PRODUCT CODE | PRICE | | SIZE/ INCHES | | | WEIGHT VOL | |
|--------------|-------|------|--------------|----|-----|------------|------|
| | GR 1 | GR 2 | H | W | D | LBS | FT³ |
| CMLFM3024P1 | 522 | 535 | 30 | 24 | 2.3 | 20 | 2.31 |
| CMLFM3030P1 | 645 | 655 | 30 | 30 | 2.3 | 25 | 2.85 |
| CMLFM3036P1 | 713 | 720 | 30 | 36 | 2.3 | 31 | 3.38 |
| CMLFM3042P1 | 784 | 796 | 30 | 42 | 2.3 | 36 | 3.92 |
| CMLFM3048P1 | 843 | 856 | 30 | 48 | 2.3 | 41 | 4.45 |
| CMLFM3054P1 | 918 | 933 | 30 | 54 | 2.3 | 46 | 4.99 |
| CMLFM3060P1 | 986 | 1001 | 30 | 60 | 2.3 | 51 | 5.52 |
| CMLFM4224P1 | 596 | 609 | 42 | 24 | 2.3 | 20 | 2.31 |
| CMLFM4230P1 | 720 | 733 | 42 | 30 | 2.3 | 25 | 2.85 |
| CMLFM4236P1 | 811 | 827 | 42 | 36 | 2.3 | 31 | 3.38 |
| CMLFM4242P1 | 897 | 918 | 42 | 42 | 2.3 | 36 | 3.92 |
| CMLFM4248P1 | 971 | 994 | 42 | 48 | 2.3 | 41 | 4.45 |
| CMLFM4254P1 | 1061 | 1084 | 42 | 54 | 2.3 | 46 | 4.99 |
| CMLFM4260P1 | 1143 | 1169 | 42 | 60 | 2.3 | 51 | 5.52 |
| CMLFM4824P1 | 683 | 697 | 48 | 24 | 2.3 | 26 | 2.73 |
| CMLFM4830P1 | 825 | 843 | 48 | 30 | 2.3 | 33 | 3.37 |
| CMLFM4836P1 | 928 | 951 | 48 | 36 | 2.3 | 39 | 4.00 |
| CMLFM4842P1 | 1030 | 1056 | 48 | 42 | 2.3 | 46 | 4.63 |
| CMLFM4848P1 | 1121 | 1147 | 48 | 48 | 2.3 | 52 | 5.26 |
| CMLFM4854P1 | 1171 | 1226 | 48 | 54 | 2.3 | 59 | 5.89 |
| CMLFM5424P1 | 683 | 697 | 54 | 24 | 2.3 | 65 | 6.53 |
| CMLFM5430P1 | 825 | 843 | 54 | 30 | 2.3 | 33 | 3.37 |
| CMLFM5436P1 | 928 | 951 | 54 | 36 | 2.3 | 39 | 4.00 |
| CMLFM5442P1 | 1030 | 1056 | 54 | 42 | 2.3 | 46 | 4.63 |
| CMLFM5448P1 | 1121 | 1147 | 54 | 48 | 2.3 | 52 | 5.26 |
| CMLFM5454P1 | 1226 | 1259 | 54 | 54 | 2.3 | 59 | 5.89 |
| CMLFM6624P1 | 816 | 833 | 66 | 24 | 2.3 | 32 | 3.58 |
| CMLFM6630P1 | 973 | 998 | 66 | 30 | 2.3 | 40 | 4.40 |
| CMLFM6636P1 | 1106 | 1132 | 66 | 36 | 2.3 | 48 | 5.23 |
| CMLFM6642P1 | 1238 | 1269 | 66 | 42 | 2.3 | 56 | 6.06 |
| CMLFM6648P1 | 1343 | 1378 | 66 | 48 | 2.3 | 64 | 6.68 |

CMLFM-P2 • Monolithic Laminate One Side, Fabric Other Panel with PDH, Punchouts on Both Side

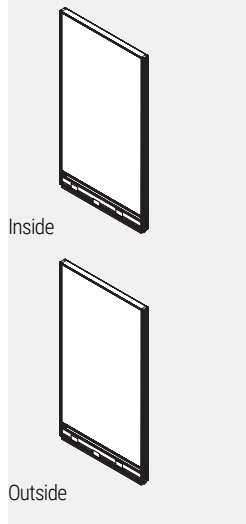

- Individual modules, one in fabric and one in laminate, incorporated into an aluminum frame.
- Panels are not tackable.
- 3 panel connector brackets per side come standard with 30”h., 42”h., and 54”h. panels.
- 4 panel connector brackets per side come standard with 66”h. panels.
- Panels include 2 raceway cover with punchouts, a power distribution housing, an integrated aluminum top cap and levelling glides.
- 24” wide panels have two punchouts, one for electrical and one for data.
- 30” wide panels and wider have three punchouts, two for electrical and one for data.
- Note: Trim is not required at a straight connection between two panels of the same height.
- Please specify duplex receptacles separately.

| PRODUCT CODE | PRICE | | SIZE/ INCHES | | | WEIGHT VOL | |
|--------------|-------|------|--------------|----|-----|------------|------|
| | GR 1 | GR 2 | H | W | D | LBS | FT³ |
| CMLFM3024P2 | 522 | 535 | 30 | 24 | 2.3 | 20 | 2.31 |
| CMLFM3030P2 | 645 | 655 | 30 | 30 | 2.3 | 25 | 2.85 |
| CMLFM3036P2 | 713 | 720 | 30 | 36 | 2.3 | 31 | 3.38 |
| CMLFM3042P2 | 784 | 796 | 30 | 42 | 2.3 | 36 | 3.92 |
| CMLFM3048P2 | 843 | 856 | 30 | 48 | 2.3 | 41 | 4.45 |
| CMLFM3054P2 | 918 | 933 | 30 | 54 | 2.3 | 46 | 4.99 |
| CMLFM3060P2 | 986 | 1001 | 30 | 60 | 2.3 | 51 | 5.52 |
| CMLFM4224P2 | 596 | 609 | 42 | 24 | 2.3 | 20 | 2.31 |
| CMLFM4230P2 | 720 | 733 | 42 | 30 | 2.3 | 25 | 2.85 |
| CMLFM4236P2 | 811 | 827 | 42 | 36 | 2.3 | 31 | 3.38 |
| CMLFM4242P2 | 897 | 918 | 42 | 42 | 2.3 | 36 | 3.92 |
| CMLFM4248P2 | 971 | 994 | 42 | 48 | 2.3 | 41 | 4.45 |
| CMLFM4254P2 | 1061 | 1084 | 42 | 54 | 2.3 | 46 | 4.99 |
| CMLFM4260P2 | 1143 | 1169 | 42 | 60 | 2.3 | 51 | 5.52 |
| CMLFM4824P2 | 683 | 697 | 48 | 24 | 2.3 | 26 | 2.73 |
| CMLFM4830P2 | 825 | 843 | 48 | 30 | 2.3 | 33 | 3.37 |
| CMLFM4836P2 | 928 | 951 | 48 | 36 | 2.3 | 39 | 4.00 |
| CMLFM4842P2 | 1030 | 1056 | 48 | 42 | 2.3 | 46 | 4.63 |
| CMLFM4848P2 | 1121 | 1147 | 48 | 48 | 2.3 | 52 | 5.26 |
| CMLFM4854P2 | 1171 | 1226 | 48 | 54 | 2.3 | 59 | 5.89 |
| CMLFM5424P2 | 683 | 697 | 54 | 24 | 2.3 | 65 | 6.53 |
| CMLFM5430P2 | 825 | 843 | 54 | 30 | 2.3 | 33 | 3.37 |
| CMLFM5436P2 | 928 | 951 | 54 | 36 | 2.3 | 39 | 4.00 |
| CMLFM5442P2 | 1030 | 1056 | 54 | 42 | 2.3 | 46 | 4.63 |
| CMLFM5448P2 | 1121 | 1147 | 54 | 48 | 2.3 | 52 | 5.26 |
| CMLFM5454P2 | 1226 | 1259 | 54 | 54 | 2.3 | 59 | 5.89 |
| CMLFM6624P2 | 816 | 833 | 66 | 24 | 2.3 | 32 | 3.58 |
| CMLFM6630P2 | 973 | 998 | 66 | 30 | 2.3 | 40 | 4.40 |
| CMLFM6636P2 | 1106 | 1132 | 66 | 36 | 2.3 | 48 | 5.23 |
| CMLFM6642P2 | 1238 | 1269 | 66 | 42 | 2.3 | 56 | 6.06 |
| CMLFM6648P2 | 1343 | 1378 | 66 | 48 | 2.3 | 64 | 6.68 |

CMLLM-N0 • Monolithic Non Powered Laminate Two Sides Panel, No Punchouts

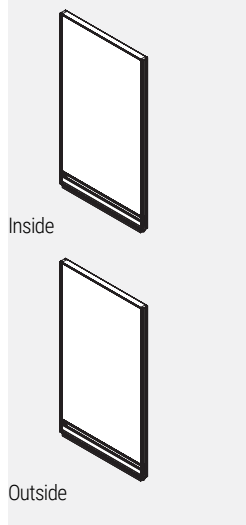

- Individual laminate modules incorporated into an aluminum frame.
- Panels are not tackable.
- 3 panel connector brackets per side come standard with 30”h., 42”h., and 54”h. panels.
- 4 panel connector brackets per side come standard with 66”h. panels.
- Panels include 2 raceway covers with no punchouts, an integrated aluminum top cap and levelling glides.
- Note: Trim is not required at a straight connection between two panels of the same height.

| PRODUCT CODE | PRICE | | SIZE/ INCHES | | | WEIGHT VOL | |
|--------------|-------|------|--------------|----|-----|------------|------|
| | GR 1 | GR 2 | H | W | D | LBS | FT³ |
| CMLLM3024N0 | 448 | | 30 | 24 | 2.3 | 20 | 2.31 |
| CMLLM3030N0 | 527 | | 30 | 30 | 2.3 | 25 | 2.85 |
| CMLLM3036N0 | 604 | | 30 | 36 | 2.3 | 31 | 3.38 |
| CMLLM3042N0 | 687 | | 30 | 42 | 2.3 | 36 | 3.92 |
| CMLLM3048N0 | 766 | | 30 | 48 | 2.3 | 41 | 4.45 |
| CMLLM3054N0 | 850 | | 30 | 54 | 2.3 | 46 | 4.99 |
| CMLLM3060N0 | 918 | | 30 | 60 | 2.3 | 51 | 5.52 |
| CMLLM4224N0 | 527 | | 42 | 24 | 2.3 | 20 | 2.31 |
| CMLLM4230N0 | 622 | | 42 | 30 | 2.3 | 25 | 2.85 |
| CMLLM4236N0 | 722 | | 42 | 36 | 2.3 | 31 | 3.38 |
| CMLLM4242N0 | 825 | | 42 | 42 | 2.3 | 36 | 3.92 |
| CMLLM4248N0 | 922 | | 42 | 48 | 2.3 | 41 | 4.45 |
| CMLLM4254N0 | 1017 | | 42 | 54 | 2.3 | 46 | 4.99 |
| CMLLM4260N0 | 1107 | | 42 | 60 | 2.3 | 51 | 5.52 |
| CMLLM4824N0 | 625 | | 48 | 24 | 2.3 | 26 | 2.73 |
| CMLLM4830N0 | 741 | | 48 | 30 | 2.3 | 33 | 3.37 |
| CMLLM4836N0 | 860 | | 48 | 36 | 2.3 | 39 | 4.00 |
| CMLLM4842N0 | 983 | | 48 | 42 | 2.3 | 46 | 4.63 |
| CMLLM4848N0 | 1107 | | 48 | 48 | 2.3 | 52 | 5.26 |
| CMLLM4854N0 | 1216 | | 48 | 54 | 2.3 | 59 | 5.89 |
| CMLLM5424N0 | 625 | | 54 | 24 | 2.3 | 65 | 6.53 |
| CMLLM5430N0 | 741 | | 54 | 30 | 2.3 | 33 | 3.37 |
| CMLLM5436N0 | 860 | | 54 | 36 | 2.3 | 39 | 4.00 |
| CMLLM5442N0 | 983 | | 54 | 42 | 2.3 | 46 | 4.63 |
| CMLLM5448N0 | 1107 | | 54 | 48 | 2.3 | 52 | 5.26 |
| CMLLM5454N0 | 1216 | | 54 | 54 | 2.3 | 59 | 5.89 |
| CMLLM6624N0 | 788 | | 66 | 24 | 2.3 | 32 | 3.58 |
| CMLLM6630N0 | 935 | | 66 | 30 | 2.3 | 40 | 4.40 |
| CMLLM6636N0 | 1087 | | 66 | 36 | 2.3 | 48 | 5.23 |
| CMLLM6642N0 | 1244 | | 66 | 42 | 2.3 | 56 | 6.06 |
| CMLLM6648N0 | 1395 | | 66 | 48 | 2.3 | 64 | 6.68 |

CMLLM-N1 • Monolithic Non Powered Laminate Two Sides Panel, Punchouts on One Side

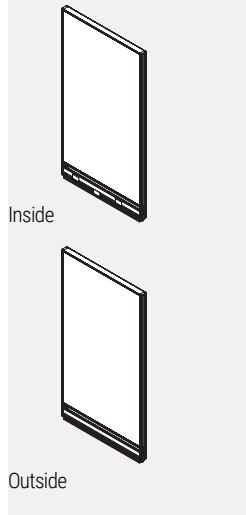

- Individual laminate modules incorporated into an aluminum frame.
- Panels are not tackable.
- 3 panel connector brackets per side come standard with 30”h., 42”h., and 54”h. panels.
- 4 panel connector brackets per side come standard with 66”h. panels.
- Panels include 1 raceway cover with punchouts on one side, 1 raceway cover with no punchouts on the other, an integrated aluminum top cap and levelling glides.
- 24” wide panels have two punchouts, one for electrical and one for data.
- 30” wide panels and wider have three punchouts, two for electrical and one for data.
- Note: Trim is not required at a straight connection between two panels of the same height.

| PRODUCT CODE | PRICE | SIZE/ INCHES | | | WEIGHT VOL | |
|--------------|-------|--------------|----|-----|------------|------|
| | | H | W | D | LBS | FT³ |
| CMLLM3024N1 | 448 | 30 | 24 | 2.3 | 20 | 2.31 |
| CMLLM3030N1 | 527 | 30 | 30 | 2.3 | 25 | 2.85 |
| CMLLM3036N1 | 604 | 30 | 36 | 2.3 | 31 | 3.38 |
| CMLLM3042N1 | 687 | 30 | 42 | 2.3 | 36 | 3.92 |
| CMLLM3048N1 | 766 | 30 | 48 | 2.3 | 41 | 4.45 |
| CMLLM3054N1 | 850 | 30 | 54 | 2.3 | 46 | 4.99 |
| CMLLM3060N1 | 918 | 30 | 60 | 2.3 | 51 | 5.52 |
| CMLLM4224N1 | 527 | 42 | 24 | 2.3 | 20 | 2.31 |
| CMLLM4230N1 | 622 | 42 | 30 | 2.3 | 25 | 2.85 |
| CMLLM4236N1 | 722 | 42 | 36 | 2.3 | 31 | 3.38 |
| CMLLM4242N1 | 825 | 42 | 42 | 2.3 | 36 | 3.92 |
| CMLLM4248N1 | 922 | 42 | 48 | 2.3 | 41 | 4.45 |
| CMLLM4254N1 | 1017 | 42 | 54 | 2.3 | 46 | 4.99 |
| CMLLM4260N1 | 1107 | 42 | 60 | 2.3 | 51 | 5.52 |
| CMLLM4824N1 | 625 | 48 | 24 | 2.3 | 26 | 2.73 |
| CMLLM4830N1 | 741 | 48 | 30 | 2.3 | 33 | 3.37 |
| CMLLM4836N1 | 860 | 48 | 36 | 2.3 | 39 | 4.00 |
| CMLLM4842N1 | 983 | 48 | 42 | 2.3 | 46 | 4.63 |
| CMLLM4848N1 | 1107 | 48 | 48 | 2.3 | 52 | 5.26 |
| CMLLM4854N1 | 1216 | 48 | 54 | 2.3 | 59 | 5.89 |
| CMLLM5424N1 | 625 | 54 | 24 | 2.3 | 65 | 6.53 |
| CMLLM5430N1 | 741 | 54 | 30 | 2.3 | 33 | 3.37 |
| CMLLM5436N1 | 860 | 54 | 36 | 2.3 | 39 | 4.00 |
| CMLLM5442N1 | 983 | 54 | 42 | 2.3 | 46 | 4.63 |
| CMLLM5448N1 | 1107 | 54 | 48 | 2.3 | 52 | 5.26 |
| CMLLM5454N1 | 1216 | 54 | 54 | 2.3 | 59 | 5.89 |
| CMLLM6624N1 | 788 | 66 | 24 | 2.3 | 32 | 3.58 |
| CMLLM6630N1 | 935 | 66 | 30 | 2.3 | 40 | 4.40 |
| CMLLM6636N1 | 1087 | 66 | 36 | 2.3 | 48 | 5.23 |
| CMLLM6642N1 | 1244 | 66 | 42 | 2.3 | 56 | 6.06 |
| CMLLM6648N1 | 1395 | 66 | 48 | 2.3 | 64 | 6.68 |

CMLLM-N2 • Monolithic Non Powered Laminate Two Sides Panel, Punchouts on Both Sides

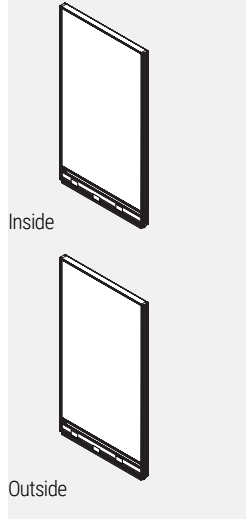

- Individual laminate modules incorporated into an aluminum frame.
- Panels are not tackable.
- 3 panel connector brackets per side come standard with 30”h., 42”h., and 54”h. panels.
- 4 panel connector brackets per side come standard with 66”h. panels.
- Panels include 2 raceway covers with punchouts, an integrated aluminum top cap and levelling glides.
- 24” wide panels have two punchouts, one for electrical and one for data.
- 30” wide panels and wider have three punchouts, two for electrical and one for data.
- Note: Trim is not required at a straight connection between two panels of the same height.

| PRODUCT CODE | PRICE | SIZE/ INCHES | | | WEIGHT VOL | |
|--------------|-------|--------------|----|-----|------------|------|
| | | H | W | D | LBS | FT³ |
| CMLLM3024N2 | 448 | 30 | 24 | 2.3 | 20 | 2.31 |
| CMLLM3030N2 | 527 | 30 | 30 | 2.3 | 25 | 2.85 |
| CMLLM3036N2 | 604 | 30 | 36 | 2.3 | 31 | 3.38 |
| CMLLM3042N2 | 687 | 30 | 42 | 2.3 | 36 | 3.92 |
| CMLLM3048N2 | 766 | 30 | 48 | 2.3 | 41 | 4.45 |
| CMLLM3054N2 | 850 | 30 | 54 | 2.3 | 46 | 4.99 |
| CMLLM3060N2 | 918 | 30 | 60 | 2.3 | 51 | 5.52 |
| CMLLM4224N2 | 527 | 42 | 24 | 2.3 | 20 | 2.31 |
| CMLLM4230N2 | 622 | 42 | 30 | 2.3 | 25 | 2.85 |
| CMLLM4236N2 | 722 | 42 | 36 | 2.3 | 31 | 3.38 |
| CMLLM4242N2 | 825 | 42 | 42 | 2.3 | 36 | 3.92 |
| CMLLM4248N2 | 922 | 42 | 48 | 2.3 | 41 | 4.45 |
| CMLLM4254N2 | 1017 | 42 | 54 | 2.3 | 46 | 4.99 |
| CMLLM4260N2 | 1107 | 42 | 60 | 2.3 | 51 | 5.52 |
| CMLLM4824N2 | 625 | 48 | 24 | 2.3 | 26 | 2.73 |
| CMLLM4830N2 | 741 | 48 | 30 | 2.3 | 33 | 3.37 |
| CMLLM4836N2 | 860 | 48 | 36 | 2.3 | 39 | 4.00 |
| CMLLM4842N2 | 983 | 48 | 42 | 2.3 | 46 | 4.63 |
| CMLLM4848N2 | 1107 | 48 | 48 | 2.3 | 52 | 5.26 |
| CMLLM4854N2 | 1216 | 48 | 54 | 2.3 | 59 | 5.89 |
| CMLLM5424N2 | 625 | 54 | 24 | 2.3 | 65 | 6.53 |
| CMLLM5430N2 | 741 | 54 | 30 | 2.3 | 33 | 3.37 |
| CMLLM5436N2 | 860 | 54 | 36 | 2.3 | 39 | 4.00 |
| CMLLM5442N2 | 983 | 54 | 42 | 2.3 | 46 | 4.63 |
| CMLLM5448N2 | 1107 | 54 | 48 | 2.3 | 52 | 5.26 |
| CMLLM5454N2 | 1216 | 54 | 54 | 2.3 | 59 | 5.89 |
| CMLLM6624N2 | 788 | 66 | 24 | 2.3 | 32 | 3.58 |
| CMLLM6630N2 | 935 | 66 | 30 | 2.3 | 40 | 4.40 |
| CMLLM6636N2 | 1087 | 66 | 36 | 2.3 | 48 | 5.23 |
| CMLLM6642N2 | 1244 | 66 | 42 | 2.3 | 56 | 6.06 |
| CMLLM6648N2 | 1395 | 66 | 48 | 2.3 | 64 | 6.68 |

CMLLM-P1 • Monolithic Laminate Two Sides Panel with PDH, Punchouts on One Side

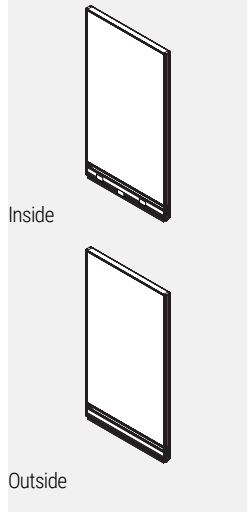

- Individual laminate modules incorporated into an aluminum frame.
- Panels are not tackable.
- 3 panel connector brackets per side come standard with 30”h., 42”h., and 54”h. panels.
- 4 panel connector brackets per side come standard with 66”h. panels.
- Panels include 1 raceway cover with punchouts on one side, 1 raceway cover with no punchouts on the other, a power distribution housing, an integrated aluminum top cap and levelling glides.
- 24” wide panels have two punchouts, one for electrical and one for data.
- 30” wide panels and wider have three punchouts, two for electrical and one for data.
- Note: Trim is not required at a straight connection between two panels of the same height.
- Please specify duplex receptacles separately.

| PRODUCT CODE | PRICE | SIZE/ INCHES | | | WEIGHT VOL | |
|--------------|-------|--------------|----|-----|------------|------|
| | | H | W | D | LBS | FT³ |
| CMLLM3024P1 | 579 | 30 | 24 | 2.3 | 20 | 2.31 |
| CMLLM3030P1 | 707 | 30 | 30 | 2.3 | 25 | 2.85 |
| CMLLM3036P1 | 790 | 30 | 36 | 2.3 | 31 | 3.38 |
| CMLLM3042P1 | 880 | 30 | 42 | 2.3 | 36 | 3.92 |
| CMLLM3048P1 | 971 | 30 | 48 | 2.3 | 41 | 4.45 |
| CMLLM3054P1 | 1056 | 30 | 54 | 2.3 | 46 | 4.99 |
| CMLLM3060P1 | 1126 | 30 | 60 | 2.3 | 51 | 5.52 |
| CMLLM4224P1 | 659 | 42 | 24 | 2.3 | 20 | 2.31 |
| CMLLM4230P1 | 800 | 42 | 30 | 2.3 | 25 | 2.85 |
| CMLLM4236P1 | 909 | 42 | 36 | 2.3 | 31 | 3.38 |
| CMLLM4242P1 | 1018 | 42 | 42 | 2.3 | 36 | 3.92 |
| CMLLM4248P1 | 1126 | 42 | 48 | 2.3 | 41 | 4.45 |
| CMLLM4254P1 | 1224 | 42 | 54 | 2.3 | 46 | 4.99 |
| CMLLM4260P1 | 1315 | 42 | 60 | 2.3 | 51 | 5.52 |
| CMLLM4824P1 | 757 | 48 | 24 | 2.3 | 26 | 2.73 |
| CMLLM4830P1 | 918 | 48 | 30 | 2.3 | 33 | 3.37 |
| CMLLM4836P1 | 1046 | 48 | 36 | 2.3 | 39 | 4.00 |
| CMLLM4842P1 | 1174 | 48 | 42 | 2.3 | 46 | 4.63 |
| CMLLM4848P1 | 1310 | 48 | 48 | 2.3 | 52 | 5.26 |
| CMLLM4854P1 | 1424 | 48 | 54 | 2.3 | 59 | 5.89 |
| CMLLM5424P1 | 757 | 54 | 24 | 2.3 | 65 | 6.53 |
| CMLLM5430P1 | 918 | 54 | 30 | 2.3 | 33 | 3.37 |
| CMLLM5436P1 | 1046 | 54 | 36 | 2.3 | 39 | 4.00 |
| CMLLM5442P1 | 1174 | 54 | 42 | 2.3 | 46 | 4.63 |
| CMLLM5448P1 | 1310 | 54 | 48 | 2.3 | 52 | 5.26 |
| CMLLM5454P1 | 1424 | 54 | 54 | 2.3 | 59 | 5.89 |
| CMLLM6624P1 | 921 | 66 | 24 | 2.3 | 32 | 3.58 |
| CMLLM6630P1 | 1113 | 66 | 30 | 2.3 | 40 | 4.40 |
| CMLLM6636P1 | 1272 | 66 | 36 | 2.3 | 48 | 5.23 |
| CMLLM6642P1 | 1438 | 66 | 42 | 2.3 | 56 | 6.06 |
| CMLLM6648P1 | 1600 | 66 | 48 | 2.3 | 64 | 6.68 |

CMLLM-P2 • Monolithic Laminate Two Sides Panel with PDH, Punchouts on Both Side

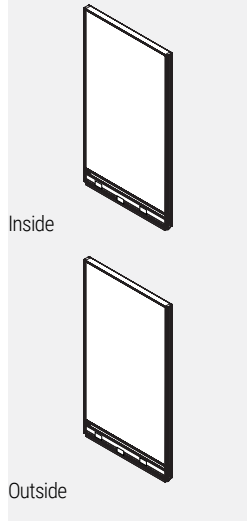

- Individual laminate modules incorporated into an aluminum frame.
- Panels are not tackable.
- 3 panel connector brackets per side come standard with 30”h., 42”h., and 54”h. panels.
- 4 panel connector brackets per side come standard with 66”h. panels.
- Panels include 2 raceway cover with punchouts, a power distribution housing, an integrated aluminum top cap and levelling glides.
- 24” wide panels have two punchouts, one for electrical and one for data.
- 30” wide panels and wider have three punchouts, two for electrical and one for data.
- Note: Trim is not required at a straight connection between two panels of the same height.
- Please specify duplex receptacles separately.

| PRODUCT CODE | PRICE | SIZE/ INCHES | | | WEIGHT VOL | |
|--------------|-------|--------------|----|-----|------------|------|
| | | H | W | D | LBS | FT³ |
| CMLLM3024P2 | 579 | 30 | 24 | 2.3 | 20 | 2.31 |
| CMLLM3030P2 | 707 | 30 | 30 | 2.3 | 25 | 2.85 |
| CMLLM3036P2 | 790 | 30 | 36 | 2.3 | 31 | 3.38 |
| CMLLM3042P2 | 880 | 30 | 42 | 2.3 | 36 | 3.92 |
| CMLLM3048P2 | 971 | 30 | 48 | 2.3 | 41 | 4.45 |
| CMLLM3054P2 | 1056 | 30 | 54 | 2.3 | 46 | 4.99 |
| CMLLM3060P2 | 1126 | 30 | 60 | 2.3 | 51 | 5.52 |
| CMLLM4224P2 | 659 | 42 | 24 | 2.3 | 20 | 2.31 |
| CMLLM4230P2 | 800 | 42 | 30 | 2.3 | 25 | 2.85 |
| CMLLM4236P2 | 909 | 42 | 36 | 2.3 | 31 | 3.38 |
| CMLLM4242P2 | 1018 | 42 | 42 | 2.3 | 36 | 3.92 |
| CMLLM4248P2 | 1126 | 42 | 48 | 2.3 | 41 | 4.45 |
| CMLLM4254P2 | 1224 | 42 | 54 | 2.3 | 46 | 4.99 |
| CMLLM4260P2 | 1315 | 42 | 60 | 2.3 | 51 | 5.52 |
| CMLLM4824P2 | 757 | 48 | 24 | 2.3 | 26 | 2.73 |
| CMLLM4830P2 | 918 | 48 | 30 | 2.3 | 33 | 3.37 |
| CMLLM4836P2 | 1046 | 48 | 36 | 2.3 | 39 | 4.00 |
| CMLLM4842P2 | 1174 | 48 | 42 | 2.3 | 46 | 4.63 |
| CMLLM4848P2 | 1310 | 48 | 48 | 2.3 | 52 | 5.26 |
| CMLLM4854P2 | 1424 | 48 | 54 | 2.3 | 59 | 5.89 |
| CMLLM5424P2 | 757 | 54 | 24 | 2.3 | 65 | 6.53 |
| CMLLM5430P2 | 918 | 54 | 30 | 2.3 | 33 | 3.37 |
| CMLLM5436P2 | 1046 | 54 | 36 | 2.3 | 39 | 4.00 |
| CMLLM5442P2 | 1174 | 54 | 42 | 2.3 | 46 | 4.63 |
| CMLLM5448P2 | 1310 | 54 | 48 | 2.3 | 52 | 5.26 |
| CMLLM5454P2 | 1424 | 54 | 54 | 2.3 | 59 | 5.89 |
| CMLLM6624P2 | 921 | 66 | 24 | 2.3 | 32 | 3.58 |
| CMLLM6630P2 | 1113 | 66 | 30 | 2.3 | 40 | 4.40 |
| CMLLM6636P2 | 1272 | 66 | 36 | 2.3 | 48 | 5.23 |
| CMLLM6642P2 | 1438 | 66 | 42 | 2.3 | 56 | 6.06 |
| CMLLM6648P2 | 1600 | 66 | 48 | 2.3 | 64 | 6.68 |

CMFF-N0 • Single Segmented Non Powered Fabric Panel, No Punchouts

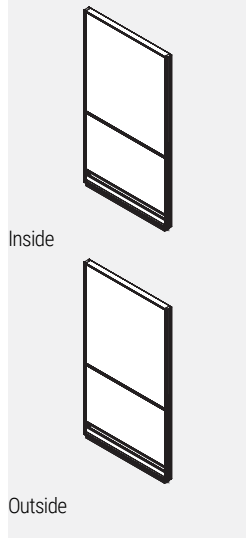

- Individual fabric-covered modules incorporated into an aluminum frame.
- Opposite sides of each module may have a different fabric within the same grade at no upcharge.
- If different grades of fabric are used on one panel, the entire panel must be priced at highest grade.
- Panels are not tackable.
- Note: Trim is not required at a straight connection between two panels of the same height.
- 3 Panel connector brackets per side come standard with 42”h. and 54”h. panels.
- 4 Panel connector brackets per side come standard with 66”h. panels.
- Panels include 2 raceway covers with no punchouts, an integrated aluminum top cap and levelling glides.

| PRODUCT CODE | PRICE | | SIZE/ INCHES | | | WEIGHT VOL | |
|--------------|-------|------|--------------|----|-----|------------|------|
| | GR 1 | GR 2 | H | W | D | LBS | FT³ |
| CMFF4224N0 | 295 | 319 | 42 | 24 | 2.3 | 20 | 2.31 |
| CMFF4230N0 | 366 | 391 | 42 | 30 | 2.3 | 25 | 2.85 |
| CMFF4236N0 | 394 | 443 | 42 | 36 | 2.3 | 31 | 3.38 |
| CMFF4242N0 | 451 | 501 | 42 | 42 | 2.3 | 36 | 3.92 |
| CMFF4248N0 | 482 | 534 | 42 | 48 | 2.3 | 41 | 4.45 |
| CMFF4254N0 | 524 | 577 | 42 | 54 | 2.3 | 46 | 4.99 |
| CMFF4260N0 | 578 | 627 | 42 | 60 | 2.3 | 51 | 5.52 |
| CMFF4266N0 | 748 | 857 | 42 | 66 | 2.3 | 55 | 6.05 |
| CMFF4272N0 | 786 | 895 | 42 | 72 | 2.3 | 60 | 6.60 |
| CMFF4824N0 | 344 | 375 | 48 | 24 | 2.3 | 26 | 2.73 |
| CMFF4830N0 | 394 | 422 | 48 | 30 | 2.3 | 33 | 3.37 |
| CMFF4836N0 | 449 | 491 | 48 | 36 | 2.3 | 39 | 4.00 |
| CMFF4842N0 | 514 | 575 | 48 | 42 | 2.3 | 46 | 4.63 |
| CMFF4848N0 | 547 | 608 | 48 | 48 | 2.3 | 52 | 5.26 |
| CMFF4854N0 | 602 | 659 | 48 | 54 | 2.3 | 59 | 5.89 |
| CMFF4860N0 | 636 | 695 | 48 | 60 | 2.3 | 65 | 6.53 |
| CMFF5424N0 | 344 | 375 | 54 | 24 | 2.3 | 26 | 2.73 |
| CMFF5430N0 | 394 | 422 | 54 | 30 | 2.3 | 33 | 3.37 |
| CMFF5436N0 | 449 | 491 | 54 | 36 | 2.3 | 39 | 4.00 |
| CMFF5442N0 | 514 | 575 | 54 | 42 | 2.3 | 46 | 4.63 |
| CMFF5448N0 | 547 | 608 | 54 | 48 | 2.3 | 52 | 5.26 |
| CMFF5454N0 | 602 | 659 | 54 | 54 | 2.3 | 59 | 5.89 |
| CMFF5460N0 | 636 | 695 | 54 | 60 | 2.3 | 65 | 6.53 |
| CMFF6624N0 | 382 | 420 | 66 | 24 | 2.3 | 32 | 3.58 |
| CMFF6630N0 | 425 | 464 | 66 | 30 | 2.3 | 40 | 4.40 |
| CMFF6636N0 | 510 | 584 | 66 | 36 | 2.3 | 48 | 5.23 |
| CMFF6642N0 | 578 | 654 | 66 | 42 | 2.3 | 56 | 6.06 |
| CMFF6648N0 | 605 | 681 | 66 | 48 | 2.3 | 64 | 6.88 |
| CMFF6654N0 | 660 | 737 | 66 | 54 | 2.3 | 72 | 7.71 |
| CMFF6660N0 | 707 | 781 | 66 | 60 | 2.3 | 80 | 8.53 |

CMFF-N1 • Single Segmented Non Powered Fabric Panel, Punchouts on One Side

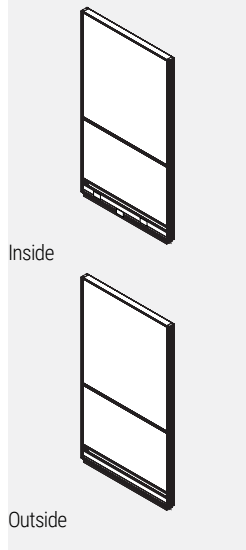

- Individual fabric-covered modules incorporated into an aluminum frame.
- Opposite sides of each module may have a different fabric within the same grade at no upcharge.
- If different grades of fabric are used on one panel, the entire panel must be priced at highest grade.
- Panels are not tackable.
- Note: Trim is not required at a straight connection between two panels of the same height.
- 3 Panel connector brackets per side come standard with 42”h. and 54”h. panels.
- 4 Panel connector brackets per side come standard with 66”h. panels.
- Panels include 1 raceway cover with punchouts on one side, 1 raceway cover with no punchouts on the other, an integrated aluminum top cap and levelling glides.
- 24” wide panels have two punchouts, one for electrical and one for data.
- 30” wide panels and wider have three punchouts, two for electrical and one for data.

| PRODUCT CODE | PRICE | | SIZE/ INCHES | | | WEIGHT VOL | |
|--------------|-------|------|--------------|----|-----|------------|------|
| | GR 1 | GR 2 | H | W | D | LBS | FT³ |
| CMFF4224N1 | 295 | 319 | 42 | 24 | 2.3 | 20 | 2.31 |
| CMFF4230N1 | 366 | 391 | 42 | 30 | 2.3 | 25 | 2.85 |
| CMFF4236N1 | 394 | 443 | 42 | 36 | 2.3 | 31 | 3.38 |
| CMFF4242N1 | 451 | 501 | 42 | 42 | 2.3 | 36 | 3.92 |
| CMFF4248N1 | 482 | 534 | 42 | 48 | 2.3 | 41 | 4.45 |
| CMFF4254N1 | 524 | 577 | 42 | 54 | 2.3 | 46 | 4.99 |
| CMFF4260N1 | 578 | 627 | 42 | 60 | 2.3 | 51 | 5.52 |
| CMFF4266N1 | 748 | 857 | 42 | 66 | 2.3 | 55 | 6.05 |
| CMFF4272N1 | 786 | 895 | 42 | 72 | 2.3 | 60 | 6.60 |
| CMFF4824N1 | 344 | 375 | 48 | 24 | 2.3 | 26 | 2.73 |
| CMFF4830N1 | 394 | 422 | 48 | 30 | 2.3 | 33 | 3.37 |
| CMFF4836N1 | 449 | 491 | 48 | 36 | 2.3 | 39 | 4.00 |
| CMFF4842N1 | 514 | 575 | 48 | 42 | 2.3 | 46 | 4.63 |
| CMFF4848N1 | 547 | 608 | 48 | 48 | 2.3 | 52 | 5.26 |
| CMFF4854N1 | 602 | 659 | 48 | 54 | 2.3 | 59 | 5.89 |
| CMFF4860N1 | 636 | 695 | 48 | 60 | 2.3 | 65 | 6.53 |
| CMFF5424N1 | 344 | 375 | 54 | 24 | 2.3 | 26 | 2.73 |
| CMFF5430N1 | 394 | 422 | 54 | 30 | 2.3 | 33 | 3.37 |
| CMFF5436N1 | 449 | 491 | 54 | 36 | 2.3 | 39 | 4.00 |
| CMFF5442N1 | 514 | 575 | 54 | 42 | 2.3 | 46 | 4.63 |
| CMFF5448N1 | 547 | 608 | 54 | 48 | 2.3 | 52 | 5.26 |
| CMFF5454N1 | 602 | 659 | 54 | 54 | 2.3 | 59 | 5.89 |
| CMFF5460N1 | 636 | 695 | 54 | 60 | 2.3 | 65 | 6.53 |
| CMFF6624N1 | 382 | 420 | 66 | 24 | 2.3 | 32 | 3.58 |
| CMFF6630N1 | 425 | 464 | 66 | 30 | 2.3 | 40 | 4.40 |
| CMFF6636N1 | 510 | 584 | 66 | 36 | 2.3 | 48 | 5.23 |
| CMFF6642N1 | 578 | 654 | 66 | 42 | 2.3 | 56 | 6.06 |
| CMFF6648N1 | 605 | 681 | 66 | 48 | 2.3 | 64 | 6.88 |
| CMFF6654N1 | 660 | 737 | 66 | 54 | 2.3 | 72 | 7.71 |
| CMFF6660N1 | 707 | 781 | 66 | 60 | 2.3 | 80 | 8.53 |

CMFF-N2 • Single Segmented Non Powered Fabric Panel, Punchouts on Both Sides

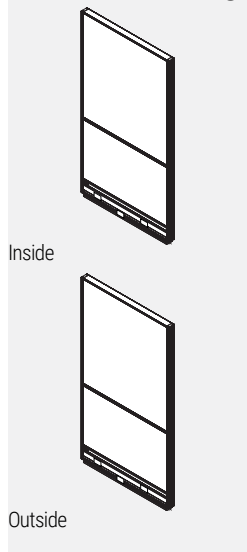

- Individual fabric-covered modules incorporated into an aluminum frame.
- Opposite sides of each module may have a different fabric within the same grade at no upcharge.
- If different grades of fabric are used on one panel, the entire panel must be priced at highest grade.
- Panels are not tackable.
- Note: Trim is not required at a straight connection between two panels of the same height.
- 3 Panel connector brackets per side come standard with 42”h. and 54”h. panels.
- 4 Panel connector brackets per side come standard with 66”h. panels.
- Panels include 2 raceway covers with punchouts on both sides, an integrated aluminum top cap and levelling glides.
- 24” wide panels have two punchouts, one for electrical and one for data.
- 30” wide panels and wider have three punchouts, two for electrical and one for data.

| PRODUCT CODE | PRICE | | SIZE/ H | INCHES | | | WEIGHT VOL | |
|--------------|-------|------|---------|--------|-----|-----|------------|--|
| | GR 1 | GR 2 | | W | D | LBS | FT³ | |
| CMFF4224N2 | 295 | 319 | 42 | 24 | 2.3 | 20 | 2.31 | |
| CMFF4230N2 | 366 | 391 | 42 | 30 | 2.3 | 25 | 2.85 | |
| CMFF4236N2 | 394 | 443 | 42 | 36 | 2.3 | 31 | 3.38 | |
| CMFF4242N2 | 451 | 501 | 42 | 42 | 2.3 | 36 | 3.92 | |
| CMFF4248N2 | 482 | 534 | 42 | 48 | 2.3 | 41 | 4.45 | |
| CMFF4254N2 | 524 | 577 | 42 | 54 | 2.3 | 46 | 4.99 | |
| CMFF4260N2 | 578 | 627 | 42 | 60 | 2.3 | 51 | 5.52 | |
| CMFF4266N2 | 748 | 857 | 42 | 66 | 2.3 | 55 | 6.05 | |
| CMFF4272N2 | 786 | 895 | 42 | 72 | 2.3 | 60 | 6.60 | |
| CMFF4824N2 | 344 | 375 | 48 | 24 | 2.3 | 26 | 2.73 | |
| CMFF4830N2 | 394 | 422 | 48 | 30 | 2.3 | 33 | 3.37 | |
| CMFF4836N2 | 449 | 491 | 48 | 36 | 2.3 | 39 | 4.00 | |
| CMFF4842N2 | 514 | 575 | 48 | 42 | 2.3 | 46 | 4.63 | |
| CMFF4848N2 | 547 | 608 | 48 | 48 | 2.3 | 52 | 5.26 | |
| CMFF4854N2 | 602 | 659 | 48 | 54 | 2.3 | 59 | 5.89 | |
| CMFF4860N2 | 636 | 695 | 48 | 60 | 2.3 | 65 | 6.53 | |
| CMFF5424N2 | 344 | 375 | 54 | 24 | 2.3 | 26 | 2.73 | |
| CMFF5430N2 | 394 | 422 | 54 | 30 | 2.3 | 33 | 3.37 | |
| CMFF5436N2 | 449 | 491 | 54 | 36 | 2.3 | 39 | 4.00 | |
| CMFF5442N2 | 514 | 575 | 54 | 42 | 2.3 | 46 | 4.63 | |
| CMFF5448N2 | 547 | 608 | 54 | 48 | 2.3 | 52 | 5.26 | |
| CMFF5454N2 | 602 | 659 | 54 | 54 | 2.3 | 59 | 5.89 | |
| CMFF5460N2 | 636 | 695 | 54 | 60 | 2.3 | 65 | 6.53 | |
| CMFF6624N2 | 382 | 420 | 66 | 24 | 2.3 | 32 | 3.58 | |
| CMFF6630N2 | 425 | 464 | 66 | 30 | 2.3 | 40 | 4.40 | |
| CMFF6636N2 | 510 | 584 | 66 | 36 | 2.3 | 48 | 5.23 | |
| CMFF6642N2 | 578 | 654 | 66 | 42 | 2.3 | 56 | 6.06 | |
| CMFF6648N2 | 605 | 681 | 66 | 48 | 2.3 | 64 | 6.88 | |
| CMFF6654N2 | 660 | 737 | 66 | 54 | 2.3 | 72 | 7.71 | |
| CMFF6660N2 | 707 | 781 | 66 | 60 | 2.3 | 80 | 8.53 | |

CMFF-P1 • Single Segmented Powered Fabric Panel, Punchouts on One Side

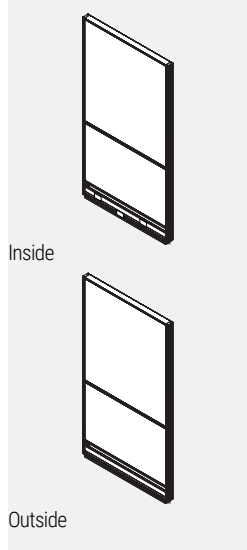

- Individual fabric-covered modules incorporated into an aluminum frame.
- Opposite sides of each module may have a different fabric within the same grade at no upcharge.
- If different grades of fabric are used on one panel, the entire panel must be priced at highest grade.
- Panels are not tackable.
- Note: Trim is not required at a straight connection between two panels of the same height.
- 3 Panel connector brackets per side come standard with 42”h. and 54”h. panels.
- 4 Panel connector brackets per side come standard with 66”h. panels.
- Panels include 1 raceway cover with punchouts on one side, 1 raceway cover with no punchouts on the other, a power distribution housing, an integrated aluminum top cap and levelling glides.
- 24” wide panels have two punchouts, one for electrical and one for data.
- 30” wide panels and wider have three punchouts, two for electrical and one for data.
- Please specify duplex receptacles separately.

| PRODUCT CODE | PRICE | | SIZE/ H | INCHES | | | WEIGHT VOL | |
|--------------|-------|------|---------|--------|-----|-----|------------|--|
| | GR 1 | GR 2 | | W | D | LBS | FT³ | |
| CMFF4224P1 | 433 | 457 | 42 | 24 | 2.3 | 20 | 2.31 | |
| CMFF4230P1 | 551 | 578 | 42 | 30 | 2.3 | 25 | 2.85 | |
| CMFF4236P1 | 590 | 639 | 42 | 36 | 2.3 | 31 | 3.38 | |
| CMFF4242P1 | 654 | 701 | 42 | 42 | 2.3 | 36 | 3.92 | |
| CMFF4248P1 | 694 | 746 | 42 | 48 | 2.3 | 41 | 4.45 | |
| CMFF4254P1 | 745 | 792 | 42 | 54 | 2.3 | 46 | 4.99 | |
| CMFF4260P1 | 796 | 846 | 42 | 60 | 2.3 | 51 | 5.52 | |
| CMFF4266P1 | 975 | 1086 | 42 | 66 | 2.3 | 55 | 6.05 | |
| CMFF4272P1 | 1022 | 1130 | 42 | 72 | 2.3 | 60 | 6.60 | |
| CMFF4824P1 | 484 | 514 | 48 | 24 | 2.3 | 26 | 2.73 | |
| CMFF4830P1 | 580 | 610 | 48 | 30 | 2.3 | 33 | 3.37 | |
| CMFF4836P1 | 644 | 689 | 48 | 36 | 2.3 | 39 | 4.00 | |
| CMFF4842P1 | 717 | 778 | 48 | 42 | 2.3 | 46 | 4.63 | |
| CMFF4848P1 | 761 | 823 | 48 | 48 | 2.3 | 52 | 5.26 | |
| CMFF4854P1 | 817 | 879 | 48 | 54 | 2.3 | 59 | 5.89 | |
| CMFF4860P1 | 854 | 916 | 48 | 60 | 2.3 | 65 | 6.53 | |
| CMFF5424P1 | 484 | 514 | 54 | 24 | 2.3 | 26 | 2.73 | |
| CMFF5430P1 | 580 | 610 | 54 | 30 | 2.3 | 33 | 3.37 | |
| CMFF5436P1 | 644 | 689 | 54 | 36 | 2.3 | 39 | 4.00 | |
| CMFF5442P1 | 717 | 778 | 54 | 42 | 2.3 | 46 | 4.63 | |
| CMFF5448P1 | 761 | 823 | 54 | 48 | 2.3 | 52 | 5.26 | |
| CMFF5454P1 | 817 | 879 | 54 | 54 | 2.3 | 59 | 5.89 | |
| CMFF5460P1 | 854 | 916 | 54 | 60 | 2.3 | 65 | 6.53 | |
| CMFF6624P1 | 520 | 561 | 66 | 24 | 2.3 | 32 | 3.58 | |
| CMFF6630P1 | 612 | 653 | 66 | 30 | 2.3 | 40 | 4.40 | |
| CMFF6636P1 | 707 | 781 | 66 | 36 | 2.3 | 48 | 5.23 | |
| CMFF6642P1 | 780 | 854 | 66 | 42 | 2.3 | 56 | 6.06 | |
| CMFF6648P1 | 819 | 894 | 66 | 48 | 2.3 | 64 | 6.88 | |
| CMFF6654P1 | 880 | 955 | 66 | 54 | 2.3 | 72 | 7.71 | |
| CMFF6660P1 | 925 | 999 | 66 | 60 | 2.3 | 80 | 8.53 | |

CMFF-P2 • Single Segmented Powered Fabric Panel, Punchouts on Both Sides

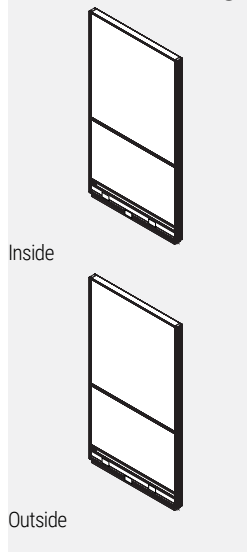

- Individual fabric-covered modules incorporated into an aluminum frame.
- Opposite sides of each module may have a different fabric within the same grade at no upcharge.
- If different grades of fabric are used on one panel, the entire panel must be priced at highest grade.
- Panels are not tackable.
- Note: Trim is not required at a straight connection between two panels of the same height.
- 3 Panel connector brackets per side come standard with 42”h. and 54”h. panels.
- 4 Panel connector brackets per side come standard with 66”h. panels.
- Panels include 2 raceway covers with punchouts on both sides, a power distribution housing, an integrated aluminum top cap and levelling glides.
- 24” wide panels have two punchouts, one for electrical and one for data.
- 30” wide panels and wider have three punchouts, two for electrical and one for data.
- Please specify duplex receptacles separately.

| PRODUCT CODE | PRICE | | SIZE/ INCHES | | | WEIGHT VOL | |
|--------------|-------|------|--------------|----|-----|------------|-----------------|
| | GR 1 | GR 2 | H | W | D | LBS | FT ³ |
| CMFF4224P2 | 433 | 457 | 42 | 24 | 2.3 | 20 | 2.31 |
| CMFF4230P2 | 551 | 578 | 42 | 30 | 2.3 | 25 | 2.85 |
| CMFF4236P2 | 590 | 639 | 42 | 36 | 2.3 | 31 | 3.38 |
| CMFF4242P2 | 654 | 701 | 42 | 42 | 2.3 | 36 | 3.92 |
| CMFF4248P2 | 694 | 746 | 42 | 48 | 2.3 | 41 | 4.45 |
| CMFF4254P2 | 745 | 792 | 42 | 54 | 2.3 | 46 | 4.99 |
| CMFF4260P2 | 796 | 846 | 42 | 60 | 2.3 | 51 | 5.52 |
| CMFF4266P2 | 975 | 1086 | 42 | 66 | 2.3 | 55 | 6.05 |
| CMFF4272P2 | 1022 | 1130 | 42 | 72 | 2.3 | 60 | 6.60 |
| CMFF4824P2 | 484 | 514 | 48 | 24 | 2.3 | 26 | 2.73 |
| CMFF4830P2 | 580 | 610 | 48 | 30 | 2.3 | 33 | 3.37 |
| CMFF4836P2 | 644 | 689 | 48 | 36 | 2.3 | 39 | 4.00 |
| CMFF4842P2 | 717 | 778 | 48 | 42 | 2.3 | 46 | 4.63 |
| CMFF4848P2 | 761 | 823 | 48 | 48 | 2.3 | 52 | 5.26 |
| CMFF4854P2 | 817 | 879 | 48 | 54 | 2.3 | 59 | 5.89 |
| CMFF4860P2 | 854 | 916 | 48 | 60 | 2.3 | 65 | 6.53 |
| CMFF5424P2 | 484 | 514 | 54 | 24 | 2.3 | 26 | 2.73 |
| CMFF5430P2 | 580 | 610 | 54 | 30 | 2.3 | 33 | 3.37 |
| CMFF5436P2 | 644 | 689 | 54 | 36 | 2.3 | 39 | 4.00 |
| CMFF5442P2 | 717 | 778 | 54 | 42 | 2.3 | 46 | 4.63 |
| CMFF5448P2 | 761 | 823 | 54 | 48 | 2.3 | 52 | 5.26 |
| CMFF5454P2 | 817 | 879 | 54 | 54 | 2.3 | 59 | 5.89 |
| CMFF5460P2 | 854 | 916 | 54 | 60 | 2.3 | 65 | 6.53 |
| CMFF6624P2 | 520 | 561 | 66 | 24 | 2.3 | 32 | 3.58 |
| CMFF6630P2 | 612 | 653 | 66 | 30 | 2.3 | 40 | 4.40 |
| CMFF6636P2 | 707 | 781 | 66 | 36 | 2.3 | 48 | 5.23 |
| CMFF6642P2 | 780 | 854 | 66 | 42 | 2.3 | 56 | 6.06 |
| CMFF6648P2 | 819 | 894 | 66 | 48 | 2.3 | 64 | 6.88 |
| CMFF6654P2 | 880 | 955 | 66 | 54 | 2.3 | 72 | 7.71 |
| CMFF6660P2 | 925 | 999 | 66 | 60 | 2.3 | 80 | 8.53 |

CMFL-N0 • Single Segmented Non Powered Laminate One Side Panel, No Punchouts

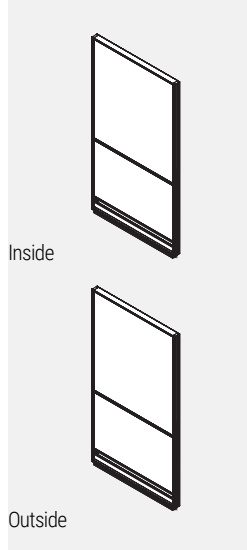

- Individual fabric or laminate covered modules incorporated into an aluminum frame.
- Modules have laminate on one side and fabric on the other.
- If different grades of fabric are used on one panel, the entire panel must be priced at highest grade.
- Panels are not tackable.
- Note: Trim is not required at a straight connection between two panels of the same height.
- 3 Panel connector brackets per side come standard with 30” to 54”h. panels.
- 4 Panel connector brackets per side come standard with 66”h. panels.
- Panels include 2 raceway covers with no punchouts, an integrated aluminum top cap and levelling glides.

| PRODUCT CODE | PRICE | | SIZE/ INCHES | | | WEIGHT VOL | |
|--------------|-------|------|--------------|----|-----|------------|-----------------|
| | GR 1 | GR 2 | H | W | D | LBS | FT ³ |
| CMFL4224N0 | 464 | 477 | 42 | 24 | 2.3 | 20 | 2.31 |
| CMFL4230N0 | 542 | 553 | 42 | 30 | 2.3 | 25 | 2.85 |
| CMFL4236N0 | 623 | 641 | 42 | 36 | 2.3 | 31 | 3.38 |
| CMFL4242N0 | 707 | 724 | 42 | 42 | 2.3 | 36 | 3.92 |
| CMFL4248N0 | 766 | 788 | 42 | 48 | 2.3 | 41 | 4.45 |
| CMFL4254N0 | 853 | 879 | 42 | 54 | 2.3 | 46 | 4.99 |
| CMFL4260N0 | 935 | 962 | 42 | 60 | 2.3 | 51 | 5.52 |
| CMFL4824N0 | 550 | 567 | 48 | 24 | 2.3 | 26 | 2.73 |
| CMFL4830N0 | 647 | 665 | 48 | 30 | 2.3 | 33 | 3.37 |
| CMFL4836N0 | 741 | 762 | 48 | 36 | 2.3 | 39 | 4.00 |
| CMFL4842N0 | 839 | 864 | 48 | 42 | 2.3 | 46 | 4.63 |
| CMFL4848N0 | 917 | 947 | 48 | 48 | 2.3 | 52 | 5.26 |
| CMFL4854N0 | 1021 | 1052 | 48 | 54 | 2.3 | 59 | 5.89 |
| CMFL4860N0 | 1122 | 1156 | 48 | 60 | 2.3 | 65 | 6.53 |
| CMFL5424N0 | 550 | 567 | 54 | 24 | 2.3 | 26 | 2.73 |
| CMFL5430N0 | 647 | 665 | 54 | 30 | 2.3 | 33 | 3.37 |
| CMFL5436N0 | 741 | 762 | 54 | 36 | 2.3 | 39 | 4.00 |
| CMFL5442N0 | 839 | 864 | 54 | 42 | 2.3 | 46 | 4.63 |
| CMFL5448N0 | 917 | 947 | 54 | 48 | 2.3 | 52 | 5.26 |
| CMFL5454N0 | 1021 | 1052 | 54 | 54 | 2.3 | 59 | 5.89 |
| CMFL5460N0 | 1122 | 1156 | 54 | 60 | 2.3 | 65 | 6.53 |
| CMFL6624N0 | 683 | 699 | 66 | 24 | 2.3 | 32 | 3.58 |
| CMFL6630N0 | 796 | 820 | 66 | 30 | 2.3 | 40 | 4.4 |
| CMFL6636N0 | 918 | 948 | 66 | 36 | 2.3 | 48 | 5.23 |
| CMFL6642N0 | 1046 | 1078 | 66 | 42 | 2.3 | 56 | 6.06 |
| CMFL6648N0 | 1139 | 1174 | 66 | 48 | 2.3 | 64 | 6.88 |
| CMFL6654N0 | 1265 | 1303 | 66 | 54 | 2.3 | 72 | 7.71 |
| CMFL6660N0 | 1395 | 1438 | 66 | 60 | 2.3 | 80 | 8.53 |

CMFL-N1 • Single Segmented Non Powered Laminate One Side Panel, Punchouts on One Side

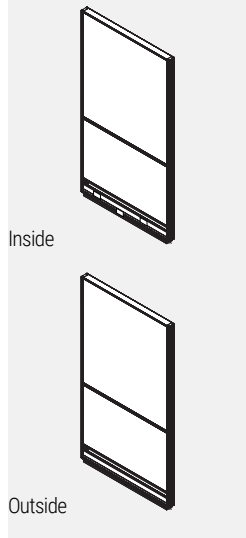

- Individual fabric or laminate covered modules incorporated into an aluminum frame.
- Modules have laminate on one side and fabric on the other.
- If different grades of fabric are used on one panel, the entire panel must be priced at highest grade.
- Panels are not tackable.
- Note: Trim is not required at a straight connection between two panels of the same height.
- 3 Panel connector brackets per side come standard with 30”h. to 54”h. panels.
- 4 Panel connector brackets per side come standard with 66”h. panels.
- Panels include 1 raceway cover with punchouts on one side, 1 raceway cover with no punchouts on the other, an integrated aluminum top cap and levelling glides.
- 24” wide panels have two punchouts, one for electrical and one for data.
- 30” wide panels and wider have three punchouts, two for electrical and one for data.

| PRODUCT CODE | PRICE | | SIZE/ INCHES | | | WEIGHT VOL | |
|--------------|-------|------|--------------|----|-----|------------|-----------------|
| | GR 1 | GR 2 | H | W | D | LBS | FT ³ |
| CMFL4224N1 | 464 | 477 | 42 | 24 | 2.3 | 20 | 2.31 |
| CMFL4230N1 | 542 | 553 | 42 | 30 | 2.3 | 25 | 2.85 |
| CMFL4236N1 | 623 | 641 | 42 | 36 | 2.3 | 31 | 3.38 |
| CMFL4242N1 | 707 | 724 | 42 | 42 | 2.3 | 36 | 3.92 |
| CMFL4248N1 | 766 | 788 | 42 | 48 | 2.3 | 41 | 4.45 |
| CMFL4254N1 | 853 | 879 | 42 | 54 | 2.3 | 46 | 4.99 |
| CMFL4260N1 | 935 | 962 | 42 | 60 | 2.3 | 51 | 5.52 |
| CMFL4824N1 | 550 | 567 | 48 | 24 | 2.3 | 26 | 2.73 |
| CMFL4830N1 | 647 | 665 | 48 | 30 | 2.3 | 33 | 3.37 |
| CMFL4836N1 | 741 | 762 | 48 | 36 | 2.3 | 39 | 4.00 |
| CMFL4842N1 | 839 | 864 | 48 | 42 | 2.3 | 46 | 4.63 |
| CMFL4848N1 | 917 | 947 | 48 | 48 | 2.3 | 52 | 5.26 |
| CMFL4854N1 | 1021 | 1052 | 48 | 54 | 2.3 | 59 | 5.89 |
| CMFL4860N1 | 1122 | 1156 | 48 | 60 | 2.3 | 65 | 6.53 |
| CMFL5424N1 | 550 | 567 | 54 | 24 | 2.3 | 26 | 2.73 |
| CMFL5430N1 | 647 | 665 | 54 | 30 | 2.3 | 33 | 3.37 |
| CMFL5436N1 | 741 | 762 | 54 | 36 | 2.3 | 39 | 4.00 |
| CMFL5442N1 | 839 | 864 | 54 | 42 | 2.3 | 46 | 4.63 |
| CMFL5448N1 | 917 | 947 | 54 | 48 | 2.3 | 52 | 5.26 |
| CMFL5454N1 | 1021 | 1052 | 54 | 54 | 2.3 | 59 | 5.89 |
| CMFL5460N1 | 1122 | 1156 | 54 | 60 | 2.3 | 65 | 6.53 |
| CMFL6624N1 | 683 | 699 | 66 | 24 | 2.3 | 32 | 3.58 |
| CMFL6630N1 | 796 | 820 | 66 | 30 | 2.3 | 40 | 4.40 |
| CMFL6636N1 | 918 | 948 | 66 | 36 | 2.3 | 48 | 5.23 |
| CMFL6642N1 | 1046 | 1078 | 66 | 42 | 2.3 | 56 | 6.06 |
| CMFL6648N1 | 1139 | 1174 | 66 | 48 | 2.3 | 64 | 6.88 |
| CMFL6654N1 | 1265 | 1303 | 66 | 54 | 2.3 | 72 | 7.71 |
| CMFL6660N1 | 1395 | 1438 | 66 | 60 | 2.3 | 80 | 8.53 |

CMFL-N2 • Single Segmented Non Powered Laminate One Side Panel, Punchouts on Both Sides

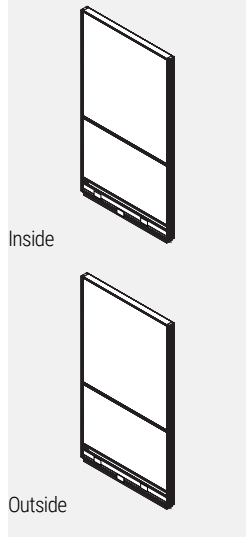

- Individual fabric or laminate covered modules incorporated into an aluminum frame.
- Modules have laminate on one side and fabric on the other.
- If different grades of fabric are used on one panel, the entire panel must be priced at highest grade.
- Panels are not tackable.
- Note: Trim is not required at a straight connection between two panels of the same height.
- 3 Panel connector brackets per side come standard with 30”h. to 54”h. panels.
- 4 Panel connector brackets per side come standard with 66”h. panels.
- Panels include 2 raceway covers with punchouts on both sides, an integrated aluminum top cap and levelling glides.
- 24” wide panels have two punchouts, one for electrical and one for data.
- 30” wide panels and wider have three punchouts, two for electrical and one for data.

| PRODUCT CODE | PRICE | | SIZE/ INCHES | | | WEIGHT VOL | |
|--------------|-------|------|--------------|----|-----|------------|-----------------|
| | GR 1 | GR 2 | H | W | D | LBS | FT ³ |
| CMFL4224N2 | 464 | 477 | 42 | 24 | 2.3 | 20 | 2.31 |
| CMFL4230N2 | 542 | 553 | 42 | 30 | 2.3 | 25 | 2.85 |
| CMFL4236N2 | 623 | 641 | 42 | 36 | 2.3 | 31 | 3.38 |
| CMFL4242N2 | 707 | 724 | 42 | 42 | 2.3 | 36 | 3.92 |
| CMFL4248N2 | 766 | 788 | 42 | 48 | 2.3 | 41 | 4.45 |
| CMFL4254N2 | 853 | 879 | 42 | 54 | 2.3 | 46 | 4.99 |
| CMFL4260N2 | 935 | 962 | 42 | 60 | 2.3 | 51 | 5.52 |
| CMFL4824N2 | 550 | 567 | 48 | 24 | 2.3 | 26 | 2.73 |
| CMFL4830N2 | 647 | 665 | 48 | 30 | 2.3 | 33 | 3.37 |
| CMFL4836N2 | 741 | 762 | 48 | 36 | 2.3 | 39 | 4.00 |
| CMFL4842N2 | 839 | 864 | 48 | 42 | 2.3 | 46 | 4.63 |
| CMFL4848N2 | 917 | 947 | 48 | 48 | 2.3 | 52 | 5.26 |
| CMFL4854N2 | 1021 | 1052 | 48 | 54 | 2.3 | 59 | 5.89 |
| CMFL4860N2 | 1122 | 1156 | 48 | 60 | 2.3 | 65 | 6.53 |
| CMFL5424N2 | 550 | 567 | 54 | 24 | 2.3 | 26 | 2.73 |
| CMFL5430N2 | 647 | 665 | 54 | 30 | 2.3 | 33 | 3.37 |
| CMFL5436N2 | 741 | 762 | 54 | 36 | 2.3 | 39 | 4.00 |
| CMFL5442N2 | 839 | 864 | 54 | 42 | 2.3 | 46 | 4.63 |
| CMFL5448N2 | 917 | 947 | 54 | 48 | 2.3 | 52 | 5.26 |
| CMFL5454N2 | 1021 | 1052 | 54 | 54 | 2.3 | 59 | 5.89 |
| CMFL5460N2 | 1122 | 1156 | 54 | 60 | 2.3 | 65 | 6.53 |
| CMFL6624N2 | 683 | 699 | 66 | 24 | 2.3 | 32 | 3.58 |
| CMFL6630N2 | 796 | 820 | 66 | 30 | 2.3 | 40 | 4.40 |
| CMFL6636N2 | 918 | 948 | 66 | 36 | 2.3 | 48 | 5.23 |
| CMFL6642N2 | 1046 | 1078 | 66 | 42 | 2.3 | 56 | 6.06 |
| CMFL6648N2 | 1139 | 1174 | 66 | 48 | 2.3 | 64 | 6.88 |
| CMFL6654N2 | 1265 | 1303 | 66 | 54 | 2.3 | 72 | 7.71 |
| CMFL6660N2 | 1395 | 1438 | 66 | 60 | 2.3 | 80 | 8.53 |

CMFL-P1 • Single Segmented Powered Laminate One Side Panel, Punchouts on One Side

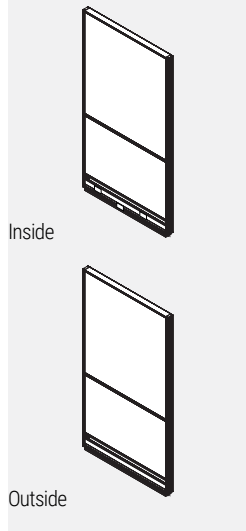

- Individual fabric or laminate covered modules incorporated into an aluminum frame.
- Modules have laminate on one side and fabric on the other.
- If different grades of fabric are used on one panel, the entire panel must be priced at highest grade.
- Panels are not tackable.
- Note: Trim is not required at a straight connection between two panels of the same height.
- 3 Panel connector brackets per side come standard with 30”h. to 54”h. panels.
- 4 Panel connector brackets per side come standard with 66”h. panels.
- Panels include 1 raceway cover with punchouts on one side, 1 raceway cover with no punchouts on the other, a power distribution housing, an integrated aluminum top cap and levelling glides.
- 24” wide panels have two punchouts, one for electrical and one for data.
- 30” wide panels and wider have three punchouts, two for electrical and one for data.
- Please specify duplex receptacles separately.

| PRODUCT CODE | PRICE | | SIZE/ H | INCHES | | | WEIGHT VOL | |
|--------------|-------|------|---------|--------|-----|-----|-----------------|--|
| | GR 1 | GR 2 | | W | D | LBS | FT ³ | |
| CMFL4224P1 | 604 | 614 | 42 | 24 | 2.3 | 20 | 2.31 | |
| CMFL4230P1 | 726 | 744 | 42 | 30 | 2.3 | 25 | 2.85 | |
| CMFL4236P1 | 819 | 837 | 42 | 36 | 2.3 | 31 | 3.38 | |
| CMFL4242P1 | 908 | 928 | 42 | 42 | 2.3 | 36 | 3.92 | |
| CMFL4248P1 | 983 | 1001 | 42 | 48 | 2.3 | 41 | 4.45 | |
| CMFL4254P1 | 1069 | 1094 | 42 | 54 | 2.3 | 46 | 4.99 | |
| CMFL4260P1 | 1154 | 1180 | 42 | 60 | 2.3 | 51 | 5.52 | |
| CMFL4824P1 | 689 | 705 | 48 | 24 | 2.3 | 26 | 2.73 | |
| CMFL4830P1 | 833 | 852 | 48 | 30 | 2.3 | 33 | 3.37 | |
| CMFL4836P1 | 936 | 959 | 48 | 36 | 2.3 | 39 | 4.00 | |
| CMFL4842P1 | 1040 | 1065 | 48 | 42 | 2.3 | 46 | 4.63 | |
| CMFL4848P1 | 1131 | 1158 | 48 | 48 | 2.3 | 52 | 5.26 | |
| CMFL4854P1 | 1236 | 1267 | 48 | 54 | 2.3 | 59 | 5.89 | |
| CMFL4860P1 | 1340 | 1375 | 48 | 60 | 2.3 | 65 | 6.53 | |
| CMFL5424P1 | 689 | 705 | 54 | 24 | 2.3 | 26 | 2.73 | |
| CMFL5430P1 | 833 | 852 | 54 | 30 | 2.3 | 33 | 3.37 | |
| CMFL5436P1 | 936 | 959 | 54 | 36 | 2.3 | 39 | 4.00 | |
| CMFL5442P1 | 1040 | 1065 | 54 | 42 | 2.3 | 46 | 4.63 | |
| CMFL5448P1 | 1131 | 1158 | 54 | 48 | 2.3 | 52 | 5.26 | |
| CMFL5454P1 | 1236 | 1267 | 54 | 54 | 2.3 | 59 | 5.89 | |
| CMFL5460P1 | 1340 | 1375 | 54 | 60 | 2.3 | 65 | 6.53 | |
| CMFL6624P1 | 823 | 840 | 66 | 24 | 2.3 | 32 | 3.58 | |
| CMFL6630P1 | 984 | 1006 | 66 | 30 | 2.3 | 40 | 4.40 | |
| CMFL6636P1 | 1114 | 1143 | 66 | 36 | 2.3 | 48 | 5.23 | |
| CMFL6642P1 | 1246 | 1278 | 66 | 42 | 2.3 | 56 | 6.06 | |
| CMFL6648P1 | 1352 | 1389 | 66 | 48 | 2.3 | 64 | 6.88 | |
| CMFL6654P1 | 1482 | 1520 | 66 | 54 | 2.3 | 72 | 7.71 | |
| CMFL6660P1 | 1613 | 1656 | 66 | 60 | 2.3 | 80 | 8.53 | |

CMFL-P2 • Single Segmented Powered Laminate One Side Panel, Punchouts on Both Sides

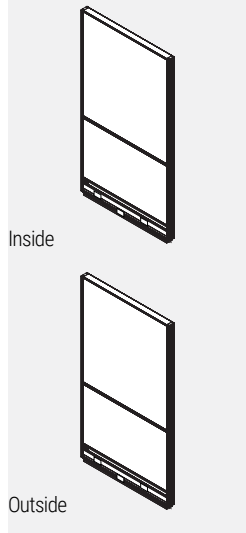

- Individual fabric or laminate covered modules incorporated into an aluminum frame.
- Modules have laminate on one side and fabric on the other.
- If different grades of fabric are used on one panel, the entire panel must be priced at highest grade.
- Panels are not tackable.
- Note: Trim is not required at a straight connection between two panels of the same height.
- 3 Panel connector brackets per side come standard with 30”h. to 54”h. panels.
- 4 Panel connector brackets per side come standard with 66”h. panels.
- Panels include 2 raceway covers with punchouts on both sides, a power distribution housing, an integrated aluminum top cap and levelling glides.
- 24” wide panels have two punchouts, one for electrical and one for data.
- 30” wide panels and wider have three punchouts, two for electrical and one for data.
- Please specify duplex receptacles separately.

| PRODUCT CODE | PRICE | | SIZE/ H | INCHES | | | WEIGHT VOL | |
|--------------|-------|------|---------|--------|-----|-----|-----------------|--|
| | GR 1 | GR 2 | | W | D | LBS | FT ³ | |
| CMFL4224P2 | 604 | 614 | 42 | 24 | 2.3 | 20 | 2.31 | |
| CMFL4230P2 | 726 | 744 | 42 | 30 | 2.3 | 25 | 2.85 | |
| CMFL4236P2 | 819 | 837 | 42 | 36 | 2.3 | 31 | 3.38 | |
| CMFL4242P2 | 908 | 928 | 42 | 42 | 2.3 | 36 | 3.92 | |
| CMFL4248P2 | 983 | 1001 | 42 | 48 | 2.3 | 41 | 4.45 | |
| CMFL4254P2 | 1069 | 1094 | 42 | 54 | 2.3 | 46 | 4.99 | |
| CMFL4260P2 | 1154 | 1180 | 42 | 60 | 2.3 | 51 | 5.52 | |
| CMFL4824P2 | 689 | 705 | 48 | 24 | 2.3 | 26 | 2.73 | |
| CMFL4830P2 | 833 | 852 | 48 | 30 | 2.3 | 33 | 3.37 | |
| CMFL4836P2 | 936 | 959 | 48 | 36 | 2.3 | 39 | 4.00 | |
| CMFL4842P2 | 1040 | 1065 | 48 | 42 | 2.3 | 46 | 4.63 | |
| CMFL4848P2 | 1131 | 1158 | 48 | 48 | 2.3 | 52 | 5.26 | |
| CMFL4854P2 | 1236 | 1267 | 48 | 54 | 2.3 | 59 | 5.89 | |
| CMFL4860P2 | 1340 | 1375 | 48 | 60 | 2.3 | 65 | 6.53 | |
| CMFL5424P2 | 689 | 705 | 54 | 24 | 2.3 | 26 | 2.73 | |
| CMFL5430P2 | 833 | 852 | 54 | 30 | 2.3 | 33 | 3.37 | |
| CMFL5436P2 | 936 | 959 | 54 | 36 | 2.3 | 39 | 4.00 | |
| CMFL5442P2 | 1040 | 1065 | 54 | 42 | 2.3 | 46 | 4.63 | |
| CMFL5448P2 | 1131 | 1158 | 54 | 48 | 2.3 | 52 | 5.26 | |
| CMFL5454P2 | 1236 | 1267 | 54 | 54 | 2.3 | 59 | 5.89 | |
| CMFL5460P2 | 1340 | 1375 | 54 | 60 | 2.3 | 65 | 6.53 | |
| CMFL6624P2 | 823 | 840 | 66 | 24 | 2.3 | 32 | 3.58 | |
| CMFL6630P2 | 984 | 1006 | 66 | 30 | 2.3 | 40 | 4.40 | |
| CMFL6636P2 | 1114 | 1143 | 66 | 36 | 2.3 | 48 | 5.23 | |
| CMFL6642P2 | 1246 | 1278 | 66 | 42 | 2.3 | 56 | 6.06 | |
| CMFL6648P2 | 1352 | 1389 | 66 | 48 | 2.3 | 64 | 6.88 | |
| CMFL6654P2 | 1482 | 1520 | 66 | 54 | 2.3 | 72 | 7.71 | |
| CMFL6660P2 | 1613 | 1656 | 66 | 60 | 2.3 | 80 | 8.53 | |

CMLL-N0 • Single Segmented Non Powered Laminate Two Sides Panel, No Punchouts

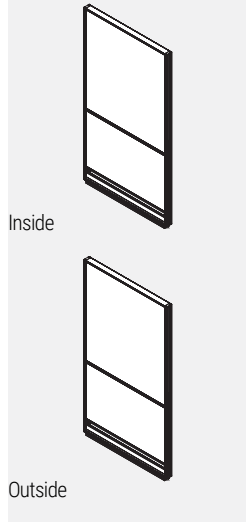

- Individual laminate covered modules incorporated into an aluminum frame.
- Opposite sides of each module may have a different laminate within the same grade at no upcharge.
- Note: Trim is not required at a straight connection between two panels of the same height.
- 3 Panel connector brackets per side come standard with 30”h. to 54”h. panels.
- 4 Panel connector brackets per side come standard with 66”h. panels.
- Panels include 2 raceway covers with no punchouts, an integrated aluminum top cap and levelling glides.

| PRODUCT CODE | PRICE | SIZE/ INCHES | | | WEIGHT VOL | |
|--------------|-------|--------------|----|-----|------------|-----------------|
| | | H | W | D | LBS | FT ³ |
| CMLL4224N0 | 527 | 42 | 24 | 2.3 | 20 | 2.31 |
| CMLL4230N0 | 622 | 42 | 30 | 2.3 | 25 | 2.85 |
| CMLL4236N0 | 722 | 42 | 36 | 2.3 | 31 | 3.38 |
| CMLL4242N0 | 825 | 42 | 42 | 2.3 | 36 | 3.92 |
| CMLL4248N0 | 922 | 42 | 48 | 2.3 | 41 | 4.45 |
| CMLL4254N0 | 1017 | 42 | 54 | 2.3 | 46 | 4.99 |
| CMLL4260N0 | 1107 | 42 | 60 | 2.3 | 51 | 5.52 |
| CMLL4824N0 | 625 | 48 | 24 | 2.3 | 26 | 2.73 |
| CMLL4830N0 | 741 | 48 | 30 | 2.3 | 33 | 3.37 |
| CMLL4836N0 | 860 | 48 | 36 | 2.3 | 39 | 4.00 |
| CMLL4842N0 | 983 | 48 | 42 | 2.3 | 46 | 4.63 |
| CMLL4848N0 | 1107 | 48 | 48 | 2.3 | 52 | 5.26 |
| CMLL4854N0 | 1216 | 48 | 54 | 2.3 | 59 | 5.89 |
| CMLL4860N0 | 1326 | 48 | 60 | 2.3 | 65 | 6.53 |
| CMLL5424N0 | 625 | 54 | 24 | 2.3 | 26 | 2.73 |
| CMLL5430N0 | 741 | 54 | 30 | 2.3 | 33 | 3.37 |
| CMLL5436N0 | 860 | 54 | 36 | 2.3 | 39 | 4.00 |
| CMLL5442N0 | 983 | 54 | 42 | 2.3 | 46 | 4.63 |
| CMLL5448N0 | 1107 | 54 | 48 | 2.3 | 52 | 5.26 |
| CMLL5454N0 | 1216 | 54 | 54 | 2.3 | 59 | 5.89 |
| CMLL5460N0 | 1326 | 54 | 60 | 2.3 | 65 | 6.53 |
| CMLL6624N0 | 788 | 66 | 24 | 2.3 | 32 | 3.58 |
| CMLL6630N0 | 935 | 66 | 30 | 2.3 | 40 | 4.40 |
| CMLL6636N0 | 1087 | 66 | 36 | 2.3 | 48 | 5.23 |
| CMLL6642N0 | 1244 | 66 | 42 | 2.3 | 56 | 6.06 |
| CMLL6648N0 | 1395 | 66 | 48 | 2.3 | 64 | 6.88 |
| CMLL6654N0 | 1541 | 66 | 54 | 2.3 | 72 | 7.71 |
| CMLL6660N0 | 1684 | 66 | 60 | 2.3 | 80 | 8.53 |

CMLL-N1 • Single Segmented Non Powered Laminate Two Sides Panel, Punchouts on One Side

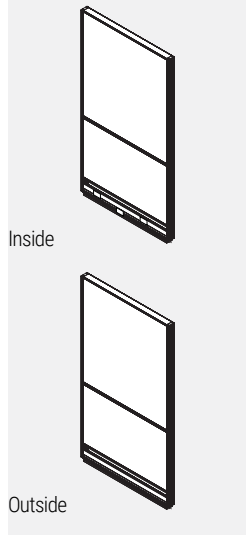

- Individual laminate covered modules incorporated into an aluminum frame.
- Opposite sides of each module may have a different laminate within the same grade at no upcharge.
- Note: Trim is not required at a straight connection between two panels of the same height.
- 3 Panel connector brackets per side come standard with 30”h. to 54”h. panels.
- 4 Panel connector brackets per side come standard with 66”h. panels.
- Panels include 1 raceway cover with punchouts on one side, 1 raceway cover with no punchouts on the other, an integrated aluminum top cap and levelling glides.
- 24” wide panels have two punchouts, one for electrical and one for data.
- 30” wide panels and wider have three punchouts, two for electrical and one for data.

| PRODUCT CODE | PRICE | SIZE/ INCHES | | | WEIGHT VOL | |
|--------------|-------|--------------|----|-----|------------|-----------------|
| | | H | W | D | LBS | FT ³ |
| CMLL4224N1 | 527 | 42 | 24 | 2.3 | 20 | 2.31 |
| CMLL4230N1 | 622 | 42 | 30 | 2.3 | 25 | 2.85 |
| CMLL4236N1 | 722 | 42 | 36 | 2.3 | 31 | 3.38 |
| CMLL4242N1 | 825 | 42 | 42 | 2.3 | 36 | 3.92 |
| CMLL4248N1 | 922 | 42 | 48 | 2.3 | 41 | 4.45 |
| CMLL4254N1 | 1017 | 42 | 54 | 2.3 | 46 | 4.99 |
| CMLL4260N1 | 1107 | 42 | 60 | 2.3 | 51 | 5.52 |
| CMLL4824N1 | 625 | 48 | 24 | 2.3 | 26 | 2.73 |
| CMLL4830N1 | 741 | 48 | 30 | 2.3 | 33 | 3.37 |
| CMLL4836N1 | 860 | 48 | 36 | 2.3 | 39 | 4.00 |
| CMLL4842N1 | 983 | 48 | 42 | 2.3 | 46 | 4.63 |
| CMLL4848N1 | 1107 | 48 | 48 | 2.3 | 52 | 5.26 |
| CMLL4854N1 | 1216 | 48 | 54 | 2.3 | 59 | 5.89 |
| CMLL4860N1 | 1326 | 48 | 60 | 2.3 | 65 | 6.53 |
| CMLL5424N1 | 625 | 54 | 24 | 2.3 | 26 | 2.73 |
| CMLL5430N1 | 741 | 54 | 30 | 2.3 | 33 | 3.37 |
| CMLL5436N1 | 860 | 54 | 36 | 2.3 | 39 | 4.00 |
| CMLL5442N1 | 983 | 54 | 42 | 2.3 | 46 | 4.63 |
| CMLL5448N1 | 1107 | 54 | 48 | 2.3 | 52 | 5.26 |
| CMLL5454N1 | 1216 | 54 | 54 | 2.3 | 59 | 5.89 |
| CMLL5460N1 | 1326 | 54 | 60 | 2.3 | 65 | 6.53 |
| CMLL6624N1 | 788 | 66 | 24 | 2.3 | 32 | 3.58 |
| CMLL6630N1 | 935 | 66 | 30 | 2.3 | 40 | 4.40 |
| CMLL6636N1 | 1087 | 66 | 36 | 2.3 | 48 | 5.23 |
| CMLL6642N1 | 1244 | 66 | 42 | 2.3 | 56 | 6.06 |
| CMLL6648N1 | 1395 | 66 | 48 | 2.3 | 64 | 6.88 |
| CMLL6654N1 | 1541 | 66 | 54 | 2.3 | 72 | 7.71 |
| CMLL6660N1 | 1684 | 66 | 60 | 2.3 | 80 | 8.53 |

CMLL-N2 • Single Segmented Non Powered Laminate Two Sides Panel, Punchouts on Both Sides

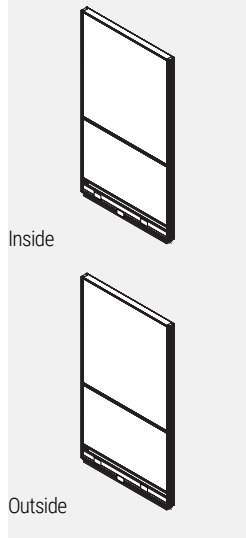

- Individual laminate covered modules incorporated into an aluminum frame.
- Opposite sides of each module may have a different laminate within the same grade at no upcharge.
- Note: Trim is not required at a straight connection between two panels of the same height.
- 3 Panel connector brackets per side come standard with 30" h. to 54" h. panels.
- 4 Panel connector brackets per side come standard with 66" h. panels.
- Panels include 2 raceway covers with punchouts on both sides, an integrated aluminum top cap and levelling glides.
- 24" wide panels have two punchouts, one for electrical and one for data.
- 30" wide panels and wider have three punchouts, two for electrical and one for data.

| PRODUCT CODE | PRICE | SIZE/ INCHES | | | WEIGHT VOL | |
|--------------|-------|--------------|----|-----|------------|-----------------|
| | | H | W | D | LBS | FT ³ |
| CMLL4224N2 | 527 | 42 | 24 | 2.3 | 20 | 2.31 |
| CMLL4230N2 | 622 | 42 | 30 | 2.3 | 25 | 2.85 |
| CMLL4236N2 | 722 | 42 | 36 | 2.3 | 31 | 3.38 |
| CMLL4242N2 | 825 | 42 | 42 | 2.3 | 36 | 3.92 |
| CMLL4248N2 | 922 | 42 | 48 | 2.3 | 41 | 4.45 |
| CMLL4254N2 | 1017 | 42 | 54 | 2.3 | 46 | 4.99 |
| CMLL4260N2 | 1107 | 42 | 60 | 2.3 | 51 | 5.52 |
| CMLL4824N2 | 625 | 48 | 24 | 2.3 | 26 | 2.73 |
| CMLL4830N2 | 741 | 48 | 30 | 2.3 | 33 | 3.37 |
| CMLL4836N2 | 860 | 48 | 36 | 2.3 | 39 | 4.00 |
| CMLL4842N2 | 983 | 48 | 42 | 2.3 | 46 | 4.63 |
| CMLL4848N2 | 1107 | 48 | 48 | 2.3 | 52 | 5.26 |
| CMLL4854N2 | 1216 | 48 | 54 | 2.3 | 59 | 5.89 |
| CMLL4860N2 | 1326 | 48 | 60 | 2.3 | 65 | 6.53 |
| CMLL5424N2 | 625 | 54 | 24 | 2.3 | 26 | 2.73 |
| CMLL5430N2 | 741 | 54 | 30 | 2.3 | 33 | 3.37 |
| CMLL5436N2 | 860 | 54 | 36 | 2.3 | 39 | 4 |
| CMLL5442N2 | 983 | 54 | 42 | 2.3 | 46 | 4.63 |
| CMLL5448N2 | 1107 | 54 | 48 | 2.3 | 52 | 5.26 |
| CMLL5454N2 | 1216 | 54 | 54 | 2.3 | 59 | 5.89 |
| CMLL5460N2 | 1326 | 54 | 60 | 2.3 | 65 | 6.53 |
| CMLL6624N2 | 788 | 66 | 24 | 2.3 | 32 | 3.58 |
| CMLL6630N2 | 935 | 66 | 30 | 2.3 | 40 | 4.4 |
| CMLL6636N2 | 1087 | 66 | 36 | 2.3 | 48 | 5.23 |
| CMLL6642N2 | 1244 | 66 | 42 | 2.3 | 56 | 6.06 |
| CMLL6648N2 | 1395 | 66 | 48 | 2.3 | 64 | 6.88 |
| CMLL6654N2 | 1541 | 66 | 54 | 2.3 | 72 | 7.71 |
| CMLL6660N2 | 1684 | 66 | 60 | 2.3 | 80 | 8.53 |

CMLL-P1 • Single Segmented Powered Laminate Two Sides Panel, Punchouts on One Side

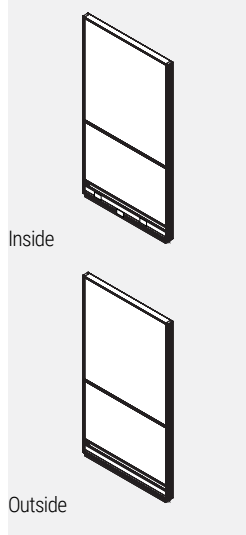

- Individual laminate covered modules incorporated into an aluminum frame.
- Opposite sides of each module may have a different laminate within the same grade at no upcharge.
- Note: Trim is not required at a straight connection between two panels of the same height.
- 3 Panel connector brackets per side come standard with 30" h. to 54" h. panels.
- 4 Panel connector brackets per side come standard with 66" h. panels.
- Panels include 1 raceway cover with punchouts on one side, 1 raceway cover with no punchouts on the other, a power distribution housing, an integrated aluminum top cap and levelling glides.
- 24" wide panels have two punchouts, one for electrical and one for data.
- 30" wide panels and wider have three punchouts, two for electrical and one for data.
- Please specify duplex receptacles separately.

| PRODUCT CODE | PRICE | SIZE/ INCHES | | | WEIGHT VOL | |
|--------------|-------|--------------|----|-----|------------|-----------------|
| | | H | W | D | LBS | FT ³ |
| CMLL4224P1 | 666 | 42 | 24 | 2.3 | 20 | 2.31 |
| CMLL4230P1 | 809 | 42 | 30 | 2.3 | 25 | 2.85 |
| CMLL4236P1 | 918 | 42 | 36 | 2.3 | 31 | 3.38 |
| CMLL4242P1 | 1027 | 42 | 42 | 2.3 | 36 | 3.92 |
| CMLL4248P1 | 1137 | 42 | 48 | 2.3 | 41 | 4.45 |
| CMLL4254P1 | 1234 | 42 | 54 | 2.3 | 46 | 4.99 |
| CMLL4260P1 | 1326 | 42 | 60 | 2.3 | 51 | 5.52 |
| CMLL4824P1 | 762 | 48 | 24 | 2.3 | 26 | 2.73 |
| CMLL4830P1 | 928 | 48 | 30 | 2.3 | 33 | 3.37 |
| CMLL4836P1 | 1056 | 48 | 36 | 2.3 | 39 | 4.00 |
| CMLL4842P1 | 1182 | 48 | 42 | 2.3 | 46 | 4.63 |
| CMLL4848P1 | 1323 | 48 | 48 | 2.3 | 52 | 5.26 |
| CMLL4854P1 | 1435 | 48 | 54 | 2.3 | 59 | 5.89 |
| CMLL4860P1 | 1543 | 48 | 60 | 2.3 | 65 | 6.53 |
| CMLL5424P1 | 762 | 54 | 24 | 2.3 | 26 | 2.73 |
| CMLL5430P1 | 928 | 54 | 30 | 2.3 | 33 | 3.37 |
| CMLL5436P1 | 1056 | 54 | 36 | 2.3 | 39 | 4 |
| CMLL5442P1 | 1182 | 54 | 42 | 2.3 | 46 | 4.63 |
| CMLL5448P1 | 1323 | 54 | 48 | 2.3 | 52 | 5.26 |
| CMLL5454P1 | 1435 | 54 | 54 | 2.3 | 59 | 5.89 |
| CMLL5460P1 | 1543 | 54 | 60 | 2.3 | 65 | 6.53 |
| CMLL6624P1 | 928 | 66 | 24 | 2.3 | 32 | 3.58 |
| CMLL6630P1 | 1122 | 66 | 30 | 2.3 | 40 | 4.4 |
| CMLL6636P1 | 1283 | 66 | 36 | 2.3 | 48 | 5.23 |
| CMLL6642P1 | 1447 | 66 | 42 | 2.3 | 56 | 6.06 |
| CMLL6648P1 | 1608 | 66 | 48 | 2.3 | 64 | 6.88 |
| CMLL6654P1 | 1757 | 66 | 54 | 2.3 | 72 | 7.71 |
| CMLL6660P1 | 1903 | 66 | 60 | 2.3 | 80 | 8.53 |

CMLL-P2 • Single Segmented Powered Laminate Two Sides Panel, Punchouts on Both Sides

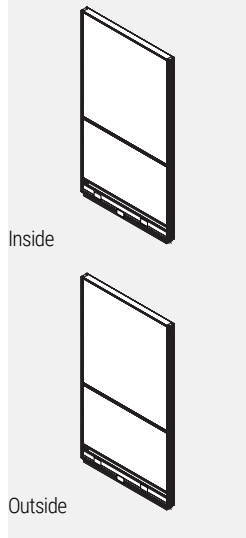

- Individual laminate covered modules incorporated into an aluminum frame.
- Opposite sides of each module may have a different laminate within the same grade at no upcharge.
- Note: Trim is not required at a straight connection between two panels of the same height.
- 3 Panel connector brackets per side come standard with 30”h. to 54”h. panels.
- 4 Panel connector brackets per side come standard with 66”h. panels.
- Panels include 2 raceway covers with punchouts on both sides, a power distribution housing, an integrated aluminum top cap and levelling glides.
- 24” wide panels have two punchouts, one for electrical and one for data.
- 30” wide panels and wider have three punchouts, two for electrical and one for data.
- Please specify duplex receptacles separately.

| PRODUCT CODE | PRICE | SIZE/ INCHES | | | WEIGHT VOL | |
|--------------|-------|--------------|----|-----|------------|-----------------|
| | | H | W | D | LBS | FT ³ |
| CMLL4224P2 | 666 | 42 | 24 | 2.3 | 20 | 2.31 |
| CMLL4230P2 | 809 | 42 | 30 | 2.3 | 25 | 2.85 |
| CMLL4236P2 | 918 | 42 | 36 | 2.3 | 31 | 3.38 |
| CMLL4242P2 | 1027 | 42 | 42 | 2.3 | 36 | 3.92 |
| CMLL4248P2 | 1137 | 42 | 48 | 2.3 | 41 | 4.45 |
| CMLL4254P2 | 1234 | 42 | 54 | 2.3 | 46 | 4.99 |
| CMLL4260P2 | 1326 | 42 | 60 | 2.3 | 51 | 5.52 |
| CMLL4824P2 | 762 | 48 | 24 | 2.3 | 26 | 2.73 |
| CMLL4830P2 | 928 | 48 | 30 | 2.3 | 33 | 3.37 |
| CMLL4836P2 | 1056 | 48 | 36 | 2.3 | 39 | 4.00 |
| CMLL4842P2 | 1182 | 48 | 42 | 2.3 | 46 | 4.63 |
| CMLL4848P2 | 1323 | 48 | 48 | 2.3 | 52 | 5.26 |
| CMLL4854P2 | 1435 | 48 | 54 | 2.3 | 59 | 5.89 |
| CMLL4860P2 | 1543 | 48 | 60 | 2.3 | 65 | 6.53 |
| CMLL5424P2 | 762 | 54 | 24 | 2.3 | 26 | 2.73 |
| CMLL5430P2 | 928 | 54 | 30 | 2.3 | 33 | 3.37 |
| CMLL5436P2 | 1056 | 54 | 36 | 2.3 | 39 | 4 |
| CMLL5442P2 | 1182 | 54 | 42 | 2.3 | 46 | 4.63 |
| CMLL5448P2 | 1323 | 54 | 48 | 2.3 | 52 | 5.26 |
| CMLL5454P2 | 1435 | 54 | 54 | 2.3 | 59 | 5.89 |
| CMLL5460P2 | 1543 | 54 | 60 | 2.3 | 65 | 6.53 |
| CMLL6624P2 | 928 | 66 | 24 | 2.3 | 32 | 3.58 |
| CMLL6630P2 | 1122 | 66 | 30 | 2.3 | 40 | 4.4 |
| CMLL6636P2 | 1283 | 66 | 36 | 2.3 | 48 | 5.23 |
| CMLL6642P2 | 1447 | 66 | 42 | 2.3 | 56 | 6.06 |
| CMLL6648P2 | 1608 | 66 | 48 | 2.3 | 64 | 6.88 |
| CMLL6654P2 | 1757 | 66 | 54 | 2.3 | 72 | 7.71 |
| CMLL6660P2 | 1903 | 66 | 60 | 2.3 | 80 | 8.53 |

CMFW-N0 • Single Segmented Non Powered Write Board One Side Panel, No Punchouts

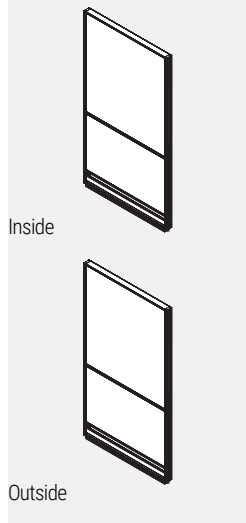

- Individual fabric or write board covered modules incorporated into an aluminum frame.
- Modules have write board on one side and fabric on the other at the top and fabric on two sides at the bottom.
- If different grades of fabric are used on one panel, the entire panel must be priced at highest grade.
- Panels are not tackable.
- Note: Trim is not required at a straight connection between two panels of the same height.
- 3 Panel connector brackets per side come standard with 30”h. to 54”h. panels.
- 4 Panel connector brackets per side come standard with 66”h. panels.
- Panels include 2 raceway covers with no punchouts, an integrated aluminum top cap and levelling glides.

| PRODUCT CODE | PRICE | | SIZE/ INCHES | | | WEIGHT VOL | |
|--------------|-------|------|--------------|----|-----|------------|-----------------|
| | GR 1 | GR 2 | H | W | D | LBS | FT ³ |
| CMFW4824N0 | 494 | 517 | 48 | 24 | 2.3 | 26 | 2.73 |
| CMFW4830N0 | 595 | 623 | 48 | 30 | 2.3 | 33 | 3.37 |
| CMFW4836N0 | 658 | 691 | 48 | 36 | 2.3 | 39 | 4.00 |
| CMFW4842N0 | 744 | 781 | 48 | 42 | 2.3 | 46 | 4.63 |
| CMFW4848N0 | 837 | 877 | 48 | 48 | 2.3 | 52 | 5.26 |
| CMFW4854N0 | 931 | 964 | 48 | 54 | 2.3 | 59 | 5.89 |
| CMFW4860N0 | 1026 | 1079 | 48 | 60 | 2.3 | 65 | 6.53 |
| CMFW5424N0 | 494 | 517 | 54 | 24 | 2.3 | 26 | 2.73 |
| CMFW5430N0 | 593 | 622 | 54 | 30 | 2.3 | 33 | 3.37 |
| CMFW5436N0 | 658 | 691 | 54 | 36 | 2.3 | 39 | 4 |
| CMFW5442N0 | 745 | 781 | 54 | 42 | 2.3 | 46 | 4.63 |
| CMFW5448N0 | 837 | 879 | 54 | 48 | 2.3 | 52 | 5.26 |
| CMFW5454N0 | 931 | 963 | 54 | 54 | 2.3 | 59 | 5.89 |
| CMFW5460N0 | 1026 | 1079 | 54 | 60 | 2.3 | 65 | 6.53 |
| CMFW6624N0 | 623 | 654 | 66 | 24 | 2.3 | 32 | 3.58 |
| CMFW6630N0 | 741 | 778 | 66 | 30 | 2.3 | 40 | 4.4 |
| CMFW6636N0 | 824 | 867 | 66 | 36 | 2.3 | 48 | 5.23 |
| CMFW6642N0 | 933 | 984 | 66 | 42 | 2.3 | 56 | 6.06 |
| CMFW6648N0 | 1041 | 1096 | 66 | 48 | 2.3 | 64 | 6.88 |
| CMFW6654N0 | 1160 | 1223 | 66 | 54 | 2.3 | 72 | 7.71 |
| CMFW6660N0 | 1279 | 1348 | 66 | 60 | 2.3 | 80 | 8.53 |

CMFW-N1 • Single Segmented Non Powered Write Board One Side Panel, Punchouts on One Side

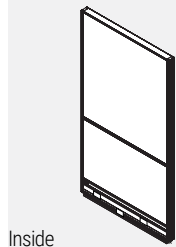

Inside

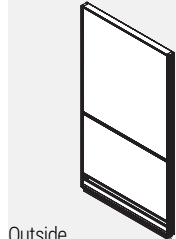

Outside

- Individual fabric or write board covered modules incorporated into an aluminum frame.
- Modules have write board on one side and fabric on the other at the top and fabric on two sides at the bottom.
- If different grades of fabric are used on one panel, the entire panel must be priced at highest grade.
- Panels are not tackable.
- Note: Trim is not required at a straight connection between two panels of the same height.
- 3 Panel connector brackets per side come standard with 30”h. to 54”h. panels.
- 4 Panel connector brackets per side come standard with 66”h. panels.
- Panels include 1 raceway cover with punchouts on one side, 1 raceway cover with no punchouts on the other, an integrated aluminum top cap and levelling glides.
- 24” wide panels have two punchouts, one for electrical and one for data.
- 30” wide panels and wider have three punchouts, two for electrical and one for data.

| PRODUCT CODE | PRICE | | SIZE/ INCHES | | | WEIGHT VOL | |
|--------------|-------|------|--------------|----|-----|------------|-----------------|
| | GR 1 | GR 2 | H | W | D | LBS | FT ³ |
| CMFW4824N1 | 494 | 517 | 48 | 24 | 2.3 | 26 | 2.73 |
| CMFW4830N1 | 595 | 623 | 48 | 30 | 2.3 | 33 | 3.37 |
| CMFW4836N1 | 658 | 691 | 48 | 36 | 2.3 | 39 | 4.00 |
| CMFW4842N1 | 744 | 781 | 48 | 42 | 2.3 | 46 | 4.63 |
| CMFW4848N1 | 837 | 877 | 48 | 48 | 2.3 | 52 | 5.26 |
| CMFW4854N1 | 931 | 964 | 48 | 54 | 2.3 | 59 | 5.89 |
| CMFW4860N1 | 1026 | 1079 | 48 | 60 | 2.3 | 65 | 6.53 |
| CMFW5424N1 | 494 | 517 | 54 | 24 | 2.3 | 26 | 2.73 |
| CMFW5430N1 | 593 | 622 | 54 | 30 | 2.3 | 33 | 3.37 |
| CMFW5436N1 | 658 | 691 | 54 | 36 | 2.3 | 39 | 4 |
| CMFW5442N1 | 745 | 781 | 54 | 42 | 2.3 | 46 | 4.63 |
| CMFW5448N1 | 837 | 879 | 54 | 48 | 2.3 | 52 | 5.26 |
| CMFW5454N1 | 931 | 963 | 54 | 54 | 2.3 | 59 | 5.89 |
| CMFW5460N1 | 1026 | 1079 | 54 | 60 | 2.3 | 65 | 6.53 |
| CMFW6624N1 | 623 | 654 | 66 | 24 | 2.3 | 32 | 3.58 |
| CMFW6630N1 | 741 | 778 | 66 | 30 | 2.3 | 40 | 4.4 |
| CMFW6636N1 | 824 | 867 | 66 | 36 | 2.3 | 48 | 5.23 |
| CMFW6642N1 | 933 | 984 | 66 | 42 | 2.3 | 56 | 6.06 |
| CMFW6648N1 | 1041 | 1096 | 66 | 48 | 2.3 | 64 | 6.88 |
| CMFW6654N1 | 1160 | 1223 | 66 | 54 | 2.3 | 72 | 7.71 |
| CMFW6660N1 | 1279 | 1348 | 66 | 60 | 2.3 | 80 | 8.53 |

CMFW-N2 • Single Segmented Non Powered Write Board One Side Panel, Punchouts on Both Sides

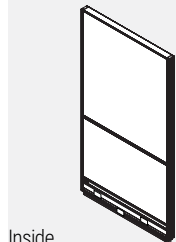

Inside

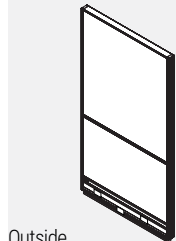

Outside

- Individual fabric or write board covered modules incorporated into an aluminum frame.
- Modules have write board on one side and fabric on the other at the top and fabric on two sides at the bottom.
- If different grades of fabric are used on one panel, the entire panel must be priced at highest grade.
- Panels are not tackable.
- Note: Trim is not required at a straight connection between two panels of the same height.
- 3 Panel connector brackets per side come standard with 30”h. to 54”h. panels.
- 4 Panel connector brackets per side come standard with 66”h. panels.
- Panels include 2 raceway covers with punchouts on both sides, an integrated aluminum top cap and levelling glides.
- 24” wide panels have two punchouts, one for electrical and one for data.
- 30” wide panels and wider have three punchouts, two for electrical and one for data.

| PRODUCT CODE | PRICE | | SIZE/ INCHES | | | WEIGHT VOL | |
|--------------|-------|------|--------------|----|-----|------------|-----------------|
| | GR 1 | GR 2 | H | W | D | LBS | FT ³ |
| CMFW4824N2 | 494 | 517 | 48 | 24 | 2.3 | 26 | 2.73 |
| CMFW4830N2 | 595 | 623 | 48 | 30 | 2.3 | 33 | 3.37 |
| CMFW4836N2 | 658 | 691 | 48 | 36 | 2.3 | 39 | 4.00 |
| CMFW4842N2 | 744 | 781 | 48 | 42 | 2.3 | 46 | 4.63 |
| CMFW4848N2 | 837 | 877 | 48 | 48 | 2.3 | 52 | 5.26 |
| CMFW4854N2 | 931 | 964 | 48 | 54 | 2.3 | 59 | 5.89 |
| CMFW4860N2 | 1026 | 1079 | 48 | 60 | 2.3 | 65 | 6.53 |
| CMFW5424N2 | 494 | 517 | 54 | 24 | 2.3 | 26 | 2.73 |
| CMFW5430N2 | 593 | 622 | 54 | 30 | 2.3 | 33 | 3.37 |
| CMFW5436N2 | 658 | 691 | 54 | 36 | 2.3 | 39 | 4 |
| CMFW5442N2 | 745 | 781 | 54 | 42 | 2.3 | 46 | 4.63 |
| CMFW5448N2 | 837 | 879 | 54 | 48 | 2.3 | 52 | 5.26 |
| CMFW5454N2 | 931 | 963 | 54 | 54 | 2.3 | 59 | 5.89 |
| CMFW5460N2 | 1026 | 1079 | 54 | 60 | 2.3 | 65 | 6.53 |
| CMFW6624N2 | 623 | 654 | 66 | 24 | 2.3 | 32 | 3.58 |
| CMFW6630N2 | 741 | 778 | 66 | 30 | 2.3 | 40 | 4.4 |
| CMFW6636N2 | 824 | 867 | 66 | 36 | 2.3 | 48 | 5.23 |
| CMFW6642N2 | 933 | 984 | 66 | 42 | 2.3 | 56 | 6.06 |
| CMFW6648N2 | 1041 | 1096 | 66 | 48 | 2.3 | 64 | 6.88 |
| CMFW6654N2 | 1160 | 1223 | 66 | 54 | 2.3 | 72 | 7.71 |
| CMFW6660N2 | 1279 | 1348 | 66 | 60 | 2.3 | 80 | 8.53 |

CMFW-P1 • Single Segmented Powered Write Board One Side Panel, Punchouts on One Side

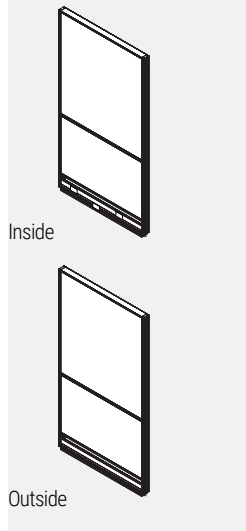

- Individual fabric or write board covered modules incorporated into an aluminum frame.
- Modules have write board on one side and fabric on the other at the top and fabric on two sides at the bottom.
- If different grades of fabric are used on one panel, the entire panel must be priced at highest grade.
- Panels are not tackable.
- Note: Trim is not required at a straight connection between two panels of the same height.
- 3 Panel connector brackets per side come standard with 30”h. to 54”h. panels.
- 4 Panel connector brackets per side come standard with 66”h. panels.
- Panels include 1 raceway cover with punchouts on one side, 1 raceway cover with no punchouts on the other, a power distribution housing, an integrated aluminum top cap and levelling glides.
- 24” wide panels have two punchouts, one for electrical and one for data.
- 30” wide panels and wider have three punchouts, two for electrical and one for data.
- Please specify duplex receptacles separately.

| PRODUCT CODE | PRICE | | SIZE/ INCHES | | | WEIGHT VOL | |
|--------------|-------|------|--------------|----|-----|------------|-----------------|
| | GR 1 | GR 2 | H | W | D | LBS | FT ³ |
| CMFW4824P1 | 633 | 656 | 48 | 24 | 2.3 | 26 | 2.73 |
| CMFW4830P1 | 781 | 808 | 48 | 30 | 2.3 | 33 | 3.37 |
| CMFW4836P1 | 854 | 886 | 48 | 36 | 2.3 | 39 | 4.00 |
| CMFW4842P1 | 947 | 984 | 48 | 42 | 2.3 | 46 | 4.63 |
| CMFW4848P1 | 1052 | 1091 | 48 | 48 | 2.3 | 52 | 5.26 |
| CMFW4854P1 | 1148 | 1179 | 48 | 54 | 2.3 | 59 | 5.89 |
| CMFW4860P1 | 1243 | 1298 | 48 | 60 | 2.3 | 65 | 6.53 |
| CMFW5424P1 | 633 | 656 | 54 | 24 | 2.3 | 26 | 2.73 |
| CMFW5430P1 | 781 | 809 | 54 | 30 | 2.3 | 33 | 3.37 |
| CMFW5436P1 | 854 | 886 | 54 | 36 | 2.3 | 39 | 4 |
| CMFW5442P1 | 947 | 984 | 54 | 42 | 2.3 | 46 | 4.63 |
| CMFW5448P1 | 1052 | 1091 | 54 | 48 | 2.3 | 52 | 5.26 |
| CMFW5454P1 | 1148 | 1180 | 54 | 54 | 2.3 | 59 | 5.89 |
| CMFW5460P1 | 1243 | 1298 | 54 | 60 | 2.3 | 65 | 6.53 |
| CMFW6624P1 | 761 | 791 | 66 | 24 | 2.3 | 32 | 3.58 |
| CMFW6630P1 | 928 | 963 | 66 | 30 | 2.3 | 40 | 4.4 |
| CMFW6636P1 | 1021 | 1063 | 66 | 36 | 2.3 | 48 | 5.23 |
| CMFW6642P1 | 1135 | 1186 | 66 | 42 | 2.3 | 56 | 6.06 |
| CMFW6648P1 | 1258 | 1312 | 66 | 48 | 2.3 | 64 | 6.88 |
| CMFW6654P1 | 1378 | 1438 | 66 | 54 | 2.3 | 72 | 7.71 |
| CMFW6660P1 | 1499 | 1567 | 66 | 60 | 2.3 | 80 | 8.53 |

CMFW-P2 • Single Segmented Powered Write Board One Side Panel, Punchouts on Both Sides

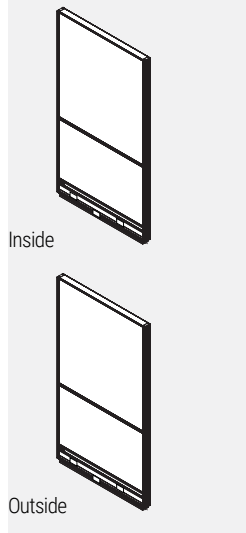

- Individual fabric or write board covered modules incorporated into an aluminum frame.
- Modules have write board on one side and fabric on the other at the top and fabric on two sides at the bottom.
- If different grades of fabric are used on one panel, the entire panel must be priced at highest grade.
- Panels are not tackable.
- Note: Trim is not required at a straight connection between two panels of the same height.
- 3 Panel connector brackets per side come standard with 30”h. to 54”h. panels.
- 4 Panel connector brackets per side come standard with 66”h. panels.
- Panels include 2 raceway covers with punchouts on both sides, a power distribution housing, an integrated aluminum top cap and levelling glides.
- 24” wide panels have two punchouts, one for electrical and one for data.
- 30” wide panels and wider have three punchouts, two for electrical and one for data.
- Please specify duplex receptacles separately.

| PRODUCT CODE | PRICE | | SIZE/ INCHES | | | WEIGHT VOL | |
|--------------|-------|------|--------------|----|-----|------------|-----------------|
| | GR 1 | GR 2 | H | W | D | LBS | FT ³ |
| CMFW4824P2 | 633 | 656 | 48 | 24 | 2.3 | 26 | 2.73 |
| CMFW4830P2 | 781 | 808 | 48 | 30 | 2.3 | 33 | 3.37 |
| CMFW4836P2 | 854 | 886 | 48 | 36 | 2.3 | 39 | 4.00 |
| CMFW4842P2 | 947 | 984 | 48 | 42 | 2.3 | 46 | 4.63 |
| CMFW4848P2 | 1052 | 1091 | 48 | 48 | 2.3 | 52 | 5.26 |
| CMFW4854P2 | 1148 | 1179 | 48 | 54 | 2.3 | 59 | 5.89 |
| CMFW4860P2 | 1243 | 1298 | 48 | 60 | 2.3 | 65 | 6.53 |
| CMFW5424P2 | 633 | 656 | 54 | 24 | 2.3 | 26 | 2.73 |
| CMFW5430P2 | 781 | 809 | 54 | 30 | 2.3 | 33 | 3.37 |
| CMFW5436P2 | 854 | 886 | 54 | 36 | 2.3 | 39 | 4 |
| CMFW5442P2 | 947 | 984 | 54 | 42 | 2.3 | 46 | 4.63 |
| CMFW5448P2 | 1052 | 1091 | 54 | 48 | 2.3 | 52 | 5.26 |
| CMFW5454P2 | 1148 | 1180 | 54 | 54 | 2.3 | 59 | 5.89 |
| CMFW5460P2 | 1243 | 1298 | 54 | 60 | 2.3 | 65 | 6.53 |
| CMFW6624P2 | 761 | 791 | 66 | 24 | 2.3 | 32 | 3.58 |
| CMFW6630P2 | 928 | 963 | 66 | 30 | 2.3 | 40 | 4.4 |
| CMFW6636P2 | 1021 | 1063 | 66 | 36 | 2.3 | 48 | 5.23 |
| CMFW6642P2 | 1135 | 1186 | 66 | 42 | 2.3 | 56 | 6.06 |
| CMFW6648P2 | 1258 | 1312 | 66 | 48 | 2.3 | 64 | 6.88 |
| CMFW6654P2 | 1378 | 1438 | 66 | 54 | 2.3 | 72 | 7.71 |
| CMFW6660P2 | 1499 | 1567 | 66 | 60 | 2.3 | 80 | 8.53 |

CMWW-N0 • Single Segmented Non Powered Write Board Two Sides Panel, No Punchouts

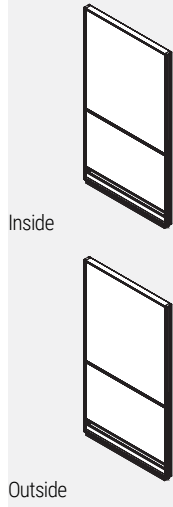

- Individual fabric or write board covered modules incorporated into an aluminum frame.
- Modules have either write board on two sides at the top and fabric on two sides at the bottom.
- If different grades of fabric are used on one panel, the entire panel must be priced at highest grade.
- Panels are not tackable.
- Note: Trim is not required at a straight connection between two panels of the same height.
- 3 Panel connector brackets per side come standard with 30”h. to 54”h. panels.
- 4 Panel connector brackets per side come standard with 66”h. panels.
- Panels include 2 raceway covers with no punchouts, an integrated aluminum top cap and levelling glides.

| PRODUCT CODE | PRICE | | SIZE/ INCHES | | | WEIGHT | | VOL FT³ |
|--------------|-------|------|--------------|----|-----|--------|------|---------|
| | GR 1 | GR 2 | H | W | D | LBS | | |
| CMWW4824N0 | 539 | 551 | 48 | 24 | 2.3 | 26 | 2.73 | |
| CMWW4830N0 | 671 | 688 | 48 | 30 | 2.3 | 33 | 3.37 | |
| CMWW4836N0 | 725 | 751 | 48 | 36 | 2.3 | 39 | 4.00 | |
| CMWW4842N0 | 825 | 849 | 48 | 42 | 2.3 | 46 | 4.63 | |
| CMWW4848N0 | 965 | 995 | 48 | 48 | 2.3 | 52 | 5.26 | |
| CMWW4854N0 | 1074 | 1108 | 48 | 54 | 2.3 | 59 | 5.89 | |
| CMWW4860N0 | 1186 | 1216 | 48 | 60 | 2.3 | 65 | 6.53 | |
| CMWW5424N0 | 539 | 551 | 54 | 24 | 2.3 | 26 | 2.73 | |
| CMWW5430N0 | 671 | 688 | 54 | 30 | 2.3 | 33 | 3.37 | |
| CMWW5436N0 | 725 | 751 | 54 | 36 | 2.3 | 39 | 4 | |
| CMWW5442N0 | 825 | 850 | 54 | 42 | 2.3 | 46 | 4.63 | |
| CMWW5448N0 | 964 | 995 | 54 | 48 | 2.3 | 52 | 5.26 | |
| CMWW5454N0 | 1074 | 1107 | 54 | 54 | 2.3 | 59 | 5.89 | |
| CMWW5460N0 | 1186 | 1218 | 54 | 60 | 2.3 | 65 | 6.53 | |
| CMWW6624N0 | 661 | 687 | 66 | 24 | 2.3 | 32 | 3.58 | |
| CMWW6630N0 | 817 | 845 | 66 | 30 | 2.3 | 40 | 4.4 | |
| CMWW6636N0 | 892 | 922 | 66 | 36 | 2.3 | 48 | 5.23 | |
| CMWW6642N0 | 1016 | 1053 | 66 | 42 | 2.3 | 56 | 6.06 | |
| CMWW6648N0 | 1166 | 1205 | 66 | 48 | 2.3 | 64 | 6.88 | |
| CMWW6654N0 | 1299 | 1345 | 66 | 54 | 2.3 | 72 | 7.71 | |
| CMWW6660N0 | 1436 | 1485 | 66 | 60 | 2.3 | 80 | 8.53 | |

CMWW-N1 • Single Segmented Non Powered Write Board Two Sides Panel, Punchouts on One Side

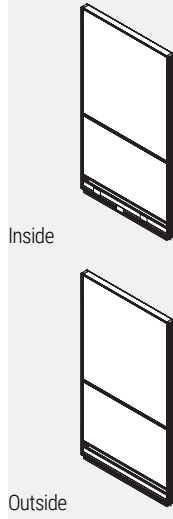

- Individual fabric or write board covered modules incorporated into an aluminum frame.
- Modules have either write board on two sides at the top and fabric on two sides at the bottom.
- If different grades of fabric are used on one panel, the entire panel must be priced at highest grade.
- Panels are not tackable.
- Note: Trim is not required at a straight connection between two panels of the same height.
- 3 Panel connector brackets per side come standard with 30”h. to 54”h. panels.
- 4 Panel connector brackets per side come standard with 66”h. panels.
- Panels include 1 raceway cover with punchouts on two sides, 1 raceway cover with no punchouts on the other, an integrated aluminum top cap and levelling glides.
- 24” wide panels have two punchouts, one for electrical and one for data.
- 30” wide panels and wider have three punchouts, two for electrical and one for data.

| PRODUCT CODE | PRICE | | SIZE/ INCHES | | | WEIGHT | | VOL FT³ |
|--------------|-------|------|--------------|----|-----|--------|------|---------|
| | GR 1 | GR 2 | H | W | D | LBS | | |
| CMWW4824N1 | 539 | 551 | 48 | 24 | 2.3 | 26 | 2.73 | |
| CMWW4830N1 | 671 | 688 | 48 | 30 | 2.3 | 33 | 3.37 | |
| CMWW4836N1 | 725 | 751 | 48 | 36 | 2.3 | 39 | 4.00 | |
| CMWW4842N1 | 825 | 849 | 48 | 42 | 2.3 | 46 | 4.63 | |
| CMWW4848N1 | 965 | 995 | 48 | 48 | 2.3 | 52 | 5.26 | |
| CMWW4854N1 | 1074 | 1108 | 48 | 54 | 2.3 | 59 | 5.89 | |
| CMWW4860N1 | 1186 | 1216 | 48 | 60 | 2.3 | 65 | 6.53 | |
| CMWW5424N1 | 539 | 551 | 54 | 24 | 2.3 | 26 | 2.73 | |
| CMWW5430N1 | 671 | 688 | 54 | 30 | 2.3 | 33 | 3.37 | |
| CMWW5436N1 | 725 | 751 | 54 | 36 | 2.3 | 39 | 4 | |
| CMWW5442N1 | 825 | 850 | 54 | 42 | 2.3 | 46 | 4.63 | |
| CMWW5448N1 | 964 | 995 | 54 | 48 | 2.3 | 52 | 5.26 | |
| CMWW5454N1 | 1074 | 1107 | 54 | 54 | 2.3 | 59 | 5.89 | |
| CMWW5460N1 | 1186 | 1218 | 54 | 60 | 2.3 | 65 | 6.53 | |
| CMWW6624N1 | 661 | 687 | 66 | 24 | 2.3 | 32 | 3.58 | |
| CMWW6630N1 | 817 | 845 | 66 | 30 | 2.3 | 40 | 4.4 | |
| CMWW6636N1 | 892 | 922 | 66 | 36 | 2.3 | 48 | 5.23 | |
| CMWW6642N1 | 1016 | 1053 | 66 | 42 | 2.3 | 56 | 6.06 | |
| CMWW6648N1 | 1166 | 1205 | 66 | 48 | 2.3 | 64 | 6.88 | |
| CMWW6654N1 | 1299 | 1345 | 66 | 54 | 2.3 | 72 | 7.71 | |
| CMWW6660N1 | 1436 | 1485 | 66 | 60 | 2.3 | 80 | 8.53 | |

CMWW-N2 • Single Segmented Non Powered Write Board Two Sides Panel, Punchouts on Both Sides

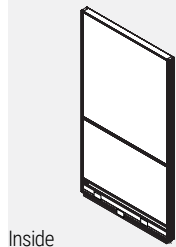

Inside

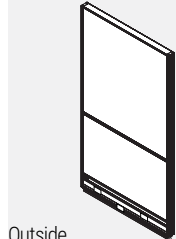

Outside

- Individual fabric or write board covered modules incorporated into an aluminum frame.
- Modules have either write board on two sides at the top and fabric on two sides at the bottom.
- If different grades of fabric are used on one panel, the entire panel must be priced at highest grade.
- Panels are not tackable.
- Note: Trim is not required at a straight connection between two panels of the same height.
- 3 Panel connector brackets per side come standard with 30”h. to 54”h. panels.
- 4 Panel connector brackets per side come standard with 66”h. panels.
- Panels include 2 raceway covers with punchouts on both sides, an integrated aluminum top cap and levelling glides.
- 24” wide panels have two punchouts, one for electrical and one for data.
- 30” wide panels and wider have three punchouts, two for electrical and one for data.

| PRODUCT CODE | PRICE | | SIZE/ INCHES | | | WEIGHT VOL | |
|--------------|-------|------|--------------|----|-----|------------|-----------------|
| | GR 1 | GR 2 | H | W | D | LBS | FT ³ |
| CMWW4824N2 | 539 | 551 | 48 | 24 | 2.3 | 26 | 2.73 |
| CMWW4830N2 | 671 | 688 | 48 | 30 | 2.3 | 33 | 3.37 |
| CMWW4836N2 | 725 | 751 | 48 | 36 | 2.3 | 39 | 4.00 |
| CMWW4842N2 | 825 | 849 | 48 | 42 | 2.3 | 46 | 4.63 |
| CMWW4848N2 | 965 | 995 | 48 | 48 | 2.3 | 52 | 5.26 |
| CMWW4854N2 | 1074 | 1108 | 48 | 54 | 2.3 | 59 | 5.89 |
| CMWW4860N2 | 1186 | 1216 | 48 | 60 | 2.3 | 65 | 6.53 |
| CMWW5424N2 | 539 | 551 | 54 | 24 | 2.3 | 26 | 2.73 |
| CMWW5430N2 | 671 | 688 | 54 | 30 | 2.3 | 33 | 3.37 |
| CMWW5436N2 | 725 | 751 | 54 | 36 | 2.3 | 39 | 4 |
| CMWW5442N2 | 825 | 850 | 54 | 42 | 2.3 | 46 | 4.63 |
| CMWW5448N2 | 964 | 995 | 54 | 48 | 2.3 | 52 | 5.26 |
| CMWW5454N2 | 1074 | 1107 | 54 | 54 | 2.3 | 59 | 5.89 |
| CMWW5460N2 | 1186 | 1218 | 54 | 60 | 2.3 | 65 | 6.53 |
| CMWW6624N2 | 661 | 687 | 66 | 24 | 2.3 | 32 | 3.58 |
| CMWW6630N2 | 817 | 845 | 66 | 30 | 2.3 | 40 | 4.4 |
| CMWW6636N2 | 892 | 922 | 66 | 36 | 2.3 | 48 | 5.23 |
| CMWW6642N2 | 1016 | 1053 | 66 | 42 | 2.3 | 56 | 6.06 |
| CMWW6648N2 | 1166 | 1205 | 66 | 48 | 2.3 | 64 | 6.88 |
| CMWW6654N2 | 1299 | 1345 | 66 | 54 | 2.3 | 72 | 7.71 |
| CMWW6660N2 | 1436 | 1485 | 66 | 60 | 2.3 | 80 | 8.53 |

CMWW-P1 • Single Segmented Powered Write Board Two Sides Panel, Punchouts on One Side

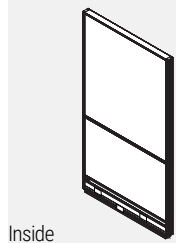

Inside

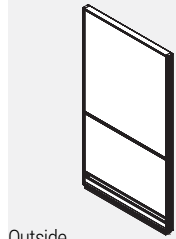

Outside

- Individual fabric or write board covered modules incorporated into an aluminum frame.
- Modules have either write board on two sides at the top and fabric on two sides at the bottom.
- If different grades of fabric are used on one panel, the entire panel must be priced at highest grade.
- Panels are not tackable.
- Note: Trim is not required at a straight connection between two panels of the same height.
- 3 Panel connector brackets per side come standard with 30”h. to 54”h. panels.
- 4 Panel connector brackets per side come standard with 66”h. panels.
- Panels include 1 raceway cover with punchouts on two sides, 1 raceway cover with no punchouts on the other, a power distribution housing, an integrated aluminum top cap and levelling glides.
- 24” wide panels have two punchouts, one for electrical and one for data.
- 30” wide panels and wider have three punchouts, two for electrical and one for data.
- Please specify duplex receptacles separately.

| PRODUCT CODE | PRICE | | SIZE/ INCHES | | | WEIGHT VOL | |
|--------------|-------|------|--------------|----|-----|------------|-----------------|
| | GR 1 | GR 2 | H | W | D | LBS | FT ³ |
| CMWW4824P1 | 676 | 691 | 48 | 24 | 2.3 | 26 | 2.73 |
| CMWW4830P1 | 857 | 873 | 48 | 30 | 2.3 | 33 | 3.37 |
| CMWW4836P1 | 922 | 948 | 48 | 36 | 2.3 | 39 | 4.00 |
| CMWW4842P1 | 1027 | 1052 | 48 | 42 | 2.3 | 46 | 4.63 |
| CMWW4848P1 | 1178 | 1208 | 48 | 48 | 2.3 | 52 | 5.26 |
| CMWW4854P1 | 1292 | 1324 | 48 | 54 | 2.3 | 59 | 5.89 |
| CMWW4860P1 | 1405 | 1437 | 48 | 60 | 2.3 | 65 | 6.53 |
| CMWW5424P1 | 676 | 691 | 54 | 24 | 2.3 | 26 | 2.73 |
| CMWW5430P1 | 857 | 874 | 54 | 30 | 2.3 | 33 | 3.37 |
| CMWW5436P1 | 922 | 948 | 54 | 36 | 2.3 | 39 | 4 |
| CMWW5442P1 | 1027 | 1052 | 54 | 42 | 2.3 | 46 | 4.63 |
| CMWW5448P1 | 1178 | 1208 | 54 | 48 | 2.3 | 52 | 5.26 |
| CMWW5454P1 | 1292 | 1325 | 54 | 54 | 2.3 | 59 | 5.89 |
| CMWW5460P1 | 1405 | 1437 | 54 | 60 | 2.3 | 65 | 6.53 |
| CMWW6624P1 | 802 | 825 | 66 | 24 | 2.3 | 32 | 3.58 |
| CMWW6630P1 | 1003 | 1030 | 66 | 30 | 2.3 | 40 | 4.4 |
| CMWW6636P1 | 1088 | 1119 | 66 | 36 | 2.3 | 48 | 5.23 |
| CMWW6642P1 | 1216 | 1257 | 66 | 42 | 2.3 | 56 | 6.06 |
| CMWW6648P1 | 1378 | 1419 | 66 | 48 | 2.3 | 64 | 6.88 |
| CMWW6654P1 | 1515 | 1563 | 66 | 54 | 2.3 | 72 | 7.71 |
| CMWW6660P1 | 1654 | 1706 | 66 | 60 | 2.3 | 80 | 8.53 |

CMWW-P2 • Single Segmented Powered Write Board Two Sides Panel, Punchouts on Both Sides

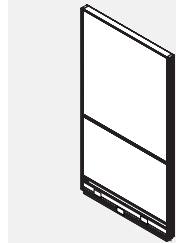

Inside

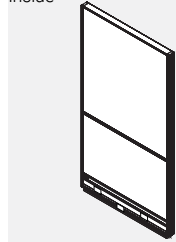

Outside

- Individual fabric or write board covered modules incorporated into an aluminum frame.
- Modules have either write board on two sides at the top and fabric on two sides at the bottom.
- If different grades of fabric are used on one panel, the entire panel must be priced at highest grade.
- Panels are not tackable.
- Note: Trim is not required at a straight connection between two panels of the same height.
- 3 Panel connector brackets per side come standard with 30”h. to 54”h. panels.
- 4 Panel connector brackets per side come standard with 66”h. panels.
- Panels include 2 raceway covers with punchouts on both sides, a power distribution housing, an integrated aluminum top cap and levelling glides.
- 24” wide panels have two punchouts, one for electrical and one for data.
- 30” wide panels and wider have three punchouts, two for electrical and one for data.
- Please specify duplex receptacles separately.

| PRODUCT CODE | PRICE | | SIZE/ INCHES | | | WEIGHT VOL | |
|--------------|-------|------|--------------|----|-----|------------|-----------------|
| | GR 1 | GR 2 | H | W | D | LBS | FT ³ |
| CMWW4824P2 | 676 | 691 | 48 | 24 | 2.3 | 26 | 2.73 |
| CMWW4830P2 | 857 | 873 | 48 | 30 | 2.3 | 33 | 3.37 |
| CMWW4836P2 | 922 | 948 | 48 | 36 | 2.3 | 39 | 4.00 |
| CMWW4842P2 | 1027 | 1052 | 48 | 42 | 2.3 | 46 | 4.63 |
| CMWW4848P2 | 1178 | 1208 | 48 | 48 | 2.3 | 52 | 5.26 |
| CMWW4854P2 | 1292 | 1324 | 48 | 54 | 2.3 | 59 | 5.89 |
| CMWW4860P2 | 1405 | 1437 | 48 | 60 | 2.3 | 65 | 6.53 |
| CMWW5424P2 | 676 | 691 | 54 | 24 | 2.3 | 26 | 2.73 |
| CMWW5430P2 | 857 | 874 | 54 | 30 | 2.3 | 33 | 3.37 |
| CMWW5436P2 | 922 | 948 | 54 | 36 | 2.3 | 39 | 4 |
| CMWW5442P2 | 1027 | 1052 | 54 | 42 | 2.3 | 46 | 4.63 |
| CMWW5448P2 | 1178 | 1208 | 54 | 48 | 2.3 | 52 | 5.26 |
| CMWW5454P2 | 1292 | 1325 | 54 | 54 | 2.3 | 59 | 5.89 |
| CMWW5460P2 | 1405 | 1437 | 54 | 60 | 2.3 | 65 | 6.53 |
| CMWW6624P2 | 802 | 825 | 66 | 24 | 2.3 | 32 | 3.58 |
| CMWW6630P2 | 1003 | 1030 | 66 | 30 | 2.3 | 40 | 4.4 |
| CMWW6636P2 | 1088 | 1119 | 66 | 36 | 2.3 | 48 | 5.23 |
| CMWW6642P2 | 1216 | 1257 | 66 | 42 | 2.3 | 56 | 6.06 |
| CMWW6648P2 | 1378 | 1419 | 66 | 48 | 2.3 | 64 | 6.88 |
| CMWW6654P2 | 1515 | 1563 | 66 | 54 | 2.3 | 72 | 7.71 |
| CMWW6660P2 | 1654 | 1706 | 66 | 60 | 2.3 | 80 | 8.53 |

CMFG-N0 • Single Glazed, Non Powered Fabric Panel, No Punchouts

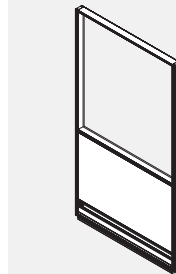

Inside

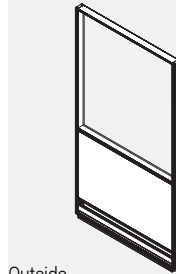

Outside

- Individual fabric-covered module in lower position with glazed module in upper position incorporated into an aluminum frame.
- Opposite sides of each module may have a different fabric within the same grade at no upcharge.
- If different grades of fabric are used on one panel, the entire panel must be priced at highest grade.
- Panels are not tackable.
- Note: Trim is not required at a straight connection between two panels of the same height.
- 3 Panel connector brackets per side come standard with 42”h. and 54”h. panels.
- 4 Panel connector brackets per side come standard with 66”h. panels.
- Panels include 2 raceway covers with no punchouts, an integrated aluminum top cap and levelling glides.
- Standard in clear (CLR) plexi.
- Optional frosted (FRST) plexi
- Glazing starts at 29” high to the top of the panel.

| PRODUCT CODE | PRICE | | SIZE/ INCHES | | | WEIGHT VOL | |
|--------------|-------|------|--------------|----|-----|------------|-----------------|
| | GR 1 | GR 2 | H | W | D | LBS | FT ³ |
| CMFG4224N0 | 446 | 459 | 42 | 24 | 2.3 | 20 | 2.31 |
| CMFG4230N0 | 488 | 507 | 42 | 30 | 2.3 | 25 | 2.85 |
| CMFG4236N0 | 537 | 567 | 42 | 36 | 2.3 | 31 | 3.38 |
| CMFG4242N0 | 593 | 625 | 42 | 42 | 2.3 | 36 | 3.92 |
| CMFG4248N0 | 652 | 681 | 42 | 48 | 2.3 | 41 | 4.45 |
| CMFG4254N0 | 736 | 765 | 42 | 54 | 2.3 | 46 | 4.99 |
| CMFG4260N0 | 811 | 840 | 42 | 60 | 2.3 | 51 | 5.52 |
| CMFG4824N0 | 482 | 495 | 48 | 24 | 2.3 | 26 | 2.73 |
| CMFG4830N0 | 524 | 542 | 48 | 30 | 2.3 | 33 | 3.37 |
| CMFG4836N0 | 599 | 629 | 48 | 36 | 2.3 | 39 | 4.00 |
| CMFG4842N0 | 671 | 700 | 48 | 42 | 2.3 | 46 | 4.63 |
| CMFG4848N0 | 734 | 763 | 48 | 48 | 2.3 | 52 | 5.26 |
| CMFG4854N0 | 854 | 885 | 48 | 54 | 2.3 | 59 | 5.89 |
| CMFG4860N0 | 966 | 997 | 48 | 60 | 2.3 | 65 | 6.53 |
| CMFG5424N0 | 482 | 495 | 54 | 24 | 2.3 | 26 | 2.73 |
| CMFG5430N0 | 524 | 542 | 54 | 30 | 2.3 | 33 | 3.37 |
| CMFG5436N0 | 600 | 629 | 54 | 36 | 2.3 | 39 | 4.00 |
| CMFG5442N0 | 671 | 699 | 54 | 42 | 2.3 | 46 | 4.63 |
| CMFG5448N0 | 734 | 763 | 54 | 48 | 2.3 | 52 | 5.26 |
| CMFG5454N0 | 854 | 885 | 54 | 54 | 2.3 | 59 | 5.89 |
| CMFG5460N0 | 966 | 997 | 54 | 60 | 2.3 | 65 | 6.53 |
| CMFG6624N0 | 619 | 633 | 66 | 24 | 2.3 | 32 | 3.58 |
| CMFG6630N0 | 720 | 734 | 66 | 30 | 2.3 | 40 | 4.40 |
| CMFG6636N0 | 820 | 851 | 66 | 36 | 2.3 | 48 | 5.23 |
| CMFG6642N0 | 918 | 949 | 66 | 42 | 2.3 | 56 | 6.06 |
| CMFG6648N0 | 1006 | 1037 | 66 | 48 | 2.3 | 64 | 6.88 |
| CMFG6654N0 | 1113 | 1143 | 66 | 54 | 2.3 | 72 | 7.71 |
| CMFG6660N0 | 1212 | 1243 | 66 | 60 | 2.3 | 80 | 8.53 |

CMFG-N1 • Single Glazed, Non Powered Fabric Panel, Punchouts on One Side

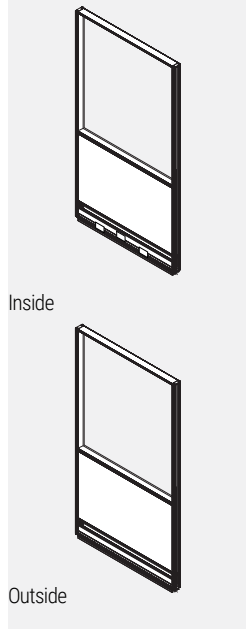

- Individual fabric-covered module in lower position with glazed module in upper position incorporated into an aluminum frame.
- Opposite sides of each module may have a different fabric within the same grade at no upcharge.
- If different grades of fabric are used on one panel, the entire panel must be priced at highest grade.
- Panels are not tackable.
- Note: Trim is not required at a straight connection between two panels of the same height.
- 3 Panel connector brackets per side come standard with 42" h. and 54" h. panels.
- 4 Panel connector brackets per side come standard with 66" h. panels.
- Panels include 1 raceway cover with punchouts on one side, 1 raceway cover with no punchouts on the other, an integrated aluminum top cap and levelling glides.
- Standard in clear (CLR) plexi.
- Optional frosted (FRST) plexi
- 24" wide panels have two punchouts, one for electrical and one for data.
- 30" wide panels and wider have three punchouts, two for electrical and one for data.
- Glazing starts at 29" high to the top of the panel.

| PRODUCT CODE | PRICE | | SIZE/ INCHES | | | WEIGHT VOL | |
|--------------|-------|------|--------------|----|-----|------------|-----------------|
| | GR 1 | GR 2 | H | W | D | LBS | FT ³ |
| CMFG4224N1 | 446 | 459 | 42 | 24 | 2.3 | 20 | 2.31 |
| CMFG4230N1 | 488 | 507 | 42 | 30 | 2.3 | 25 | 2.85 |
| CMFG4236N1 | 537 | 567 | 42 | 36 | 2.3 | 31 | 3.38 |
| CMFG4242N1 | 593 | 625 | 42 | 42 | 2.3 | 36 | 3.92 |
| CMFG4248N1 | 652 | 681 | 42 | 48 | 2.3 | 41 | 4.45 |
| CMFG4254N1 | 736 | 765 | 42 | 54 | 2.3 | 46 | 4.99 |
| CMFG4260N1 | 811 | 840 | 42 | 60 | 2.3 | 51 | 5.52 |
| CMFG4824N1 | 482 | 495 | 48 | 24 | 2.3 | 26 | 2.73 |
| CMFG4830N1 | 524 | 542 | 48 | 30 | 2.3 | 33 | 3.37 |
| CMFG4836N1 | 599 | 629 | 48 | 36 | 2.3 | 39 | 4.00 |
| CMFG4842N1 | 671 | 700 | 48 | 42 | 2.3 | 46 | 4.63 |
| CMFG4848N1 | 734 | 763 | 48 | 48 | 2.3 | 52 | 5.26 |
| CMFG4854N1 | 854 | 885 | 48 | 54 | 2.3 | 59 | 5.89 |
| CMFG4860N1 | 966 | 997 | 48 | 60 | 2.3 | 65 | 6.53 |
| CMFG5424N1 | 482 | 495 | 54 | 24 | 2.3 | 26 | 2.73 |
| CMFG5430N1 | 524 | 542 | 54 | 30 | 2.3 | 33 | 3.37 |
| CMFG5436N1 | 600 | 629 | 54 | 36 | 2.3 | 39 | 4.00 |
| CMFG5442N1 | 671 | 699 | 54 | 42 | 2.3 | 46 | 4.63 |
| CMFG5448N1 | 734 | 763 | 54 | 48 | 2.3 | 52 | 5.26 |
| CMFG5454N1 | 854 | 885 | 54 | 54 | 2.3 | 59 | 5.89 |
| CMFG5460N1 | 966 | 997 | 54 | 60 | 2.3 | 65 | 6.53 |
| CMFG6624N1 | 619 | 633 | 66 | 24 | 2.3 | 32 | 3.58 |
| CMFG6630N1 | 720 | 734 | 66 | 30 | 2.3 | 40 | 4.40 |
| CMFG6636N1 | 820 | 851 | 66 | 36 | 2.3 | 48 | 5.23 |
| CMFG6642N1 | 918 | 949 | 66 | 42 | 2.3 | 56 | 6.06 |
| CMFG6648N1 | 1006 | 1037 | 66 | 48 | 2.3 | 64 | 6.88 |
| CMFG6654N1 | 1113 | 1143 | 66 | 54 | 2.3 | 72 | 7.71 |
| CMFG6660N1 | 1212 | 1243 | 66 | 60 | 2.3 | 80 | 8.53 |

CMFG-N2 • Single Glazed, Non Powered Fabric Panel, Punchouts on Both Sides

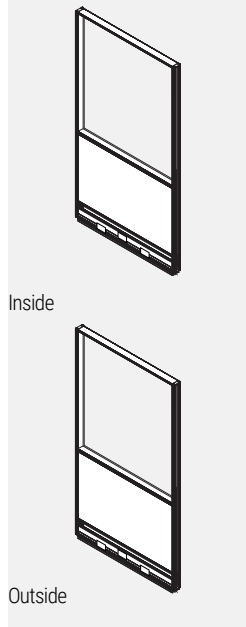

- Individual fabric-covered module in lower position with glazed module in upper position incorporated into an aluminum frame.
- Opposite sides of each module may have a different fabric within the same grade at no upcharge.
- If different grades of fabric are used on one panel, the entire panel must be priced at highest grade.
- Panels are not tackable.
- Note: Trim is not required at a straight connection between two panels of the same height.
- 3 Panel connector brackets per side come standard with 42" h. and 54" h. panels.
- 4 Panel connector brackets per side come standard with 66" h. panels.
- Panels include 2 raceway covers with punchouts on both sides, an integrated aluminum top cap and levelling glides.
- Standard in clear (CLR) plexi.
- Optional frosted (FRST) plexi
- 24" wide panels have two punchouts, one for electrical and one for data.
- 30" wide panels and wider have three punchouts, two for electrical and one for data.
- Glazing starts at 29" high to the top of the panel.

| PRODUCT CODE | PRICE | | SIZE/ INCHES | | | WEIGHT VOL | |
|--------------|-------|------|--------------|----|-----|------------|-----------------|
| | GR 1 | GR 2 | H | W | D | LBS | FT ³ |
| CMFG4224N2 | 446 | 459 | 42 | 24 | 2.3 | 20 | 2.31 |
| CMFG4230N2 | 488 | 507 | 42 | 30 | 2.3 | 25 | 2.85 |
| CMFG4236N2 | 537 | 567 | 42 | 36 | 2.3 | 31 | 3.38 |
| CMFG4242N2 | 593 | 625 | 42 | 42 | 2.3 | 36 | 3.92 |
| CMFG4248N2 | 652 | 681 | 42 | 48 | 2.3 | 41 | 4.45 |
| CMFG4254N2 | 736 | 765 | 42 | 54 | 2.3 | 46 | 4.99 |
| CMFG4260N2 | 811 | 840 | 42 | 60 | 2.3 | 51 | 5.52 |
| CMFG4824N2 | 482 | 495 | 48 | 24 | 2.3 | 26 | 2.73 |
| CMFG4830N2 | 524 | 542 | 48 | 30 | 2.3 | 33 | 3.37 |
| CMFG4836N2 | 599 | 629 | 48 | 36 | 2.3 | 39 | 4.00 |
| CMFG4842N2 | 671 | 700 | 48 | 42 | 2.3 | 46 | 4.63 |
| CMFG4848N2 | 734 | 763 | 48 | 48 | 2.3 | 52 | 5.26 |
| CMFG4854N2 | 854 | 885 | 48 | 54 | 2.3 | 59 | 5.89 |
| CMFG4860N2 | 966 | 997 | 48 | 60 | 2.3 | 65 | 6.53 |
| CMFG5424N2 | 482 | 495 | 54 | 24 | 2.3 | 26 | 2.73 |
| CMFG5430N2 | 524 | 542 | 54 | 30 | 2.3 | 33 | 3.37 |
| CMFG5436N2 | 600 | 629 | 54 | 36 | 2.3 | 39 | 4.00 |
| CMFG5442N2 | 671 | 699 | 54 | 42 | 2.3 | 46 | 4.63 |
| CMFG5448N2 | 734 | 763 | 54 | 48 | 2.3 | 52 | 5.26 |
| CMFG5454N2 | 854 | 885 | 54 | 54 | 2.3 | 59 | 5.89 |
| CMFG5460N2 | 966 | 997 | 54 | 60 | 2.3 | 65 | 6.53 |
| CMFG6624N2 | 619 | 633 | 66 | 24 | 2.3 | 32 | 3.58 |
| CMFG6630N2 | 720 | 734 | 66 | 30 | 2.3 | 40 | 4.40 |
| CMFG6636N2 | 820 | 851 | 66 | 36 | 2.3 | 48 | 5.23 |
| CMFG6642N2 | 918 | 949 | 66 | 42 | 2.3 | 56 | 6.06 |
| CMFG6648N2 | 1006 | 1037 | 66 | 48 | 2.3 | 64 | 6.88 |
| CMFG6654N2 | 1113 | 1143 | 66 | 54 | 2.3 | 72 | 7.71 |
| CMFG6660N2 | 1212 | 1243 | 66 | 60 | 2.3 | 80 | 8.53 |

CMFG-P1 • Single Glazed, Powered Fabric Panel, Punchouts on One Side

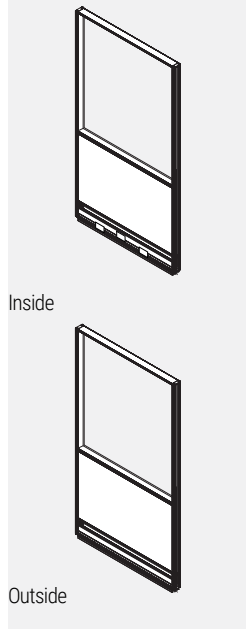

- Individual fabric-covered module in lower position with glazed module in upper position incorporated into an aluminum frame.
- Opposite sides of each module may have a different fabric within the same grade at no upcharge.
- If different grades of fabric are used on one panel, the entire panel must be priced at highest grade.
- Panels are not tackable.
- Note: Trim is not required at a straight connection between two panels of the same height.
- 3 Panel connector brackets per side come standard with 42" h. and 54" h. panels.
- 4 Panel connector brackets per side come standard with 66" h. panels.
- Panels include 1 raceway cover with punchouts on one side, 1 raceway cover with no punchouts on the other, a power distribution housing, an integrated aluminum top cap and levelling glides.
- Standard in clear (CLR) plexi.
- Optional frosted (FRST) plexi
- 24" wide panels have two punchouts, one for electrical and one for data.
- 30" wide panels and wider have three punchouts, two for electrical and one for data.
- Glazing starts at 29" high to the top of the panel.
- Please specify duplex receptacles separately.

| PRODUCT CODE | PRICE | | SIZE/ INCHES | | | WEIGHT VOL | |
|--------------|-------|------|--------------|----|-----|------------|-----------------|
| | GR 1 | GR 2 | H | W | D | LBS | FT ³ |
| CMFG4224P1 | 582 | 600 | 42 | 24 | 2.3 | 20 | 2.31 |
| CMFG4230P1 | 678 | 692 | 42 | 30 | 2.3 | 25 | 2.85 |
| CMFG4236P1 | 731 | 761 | 42 | 36 | 2.3 | 31 | 3.38 |
| CMFG4242P1 | 796 | 826 | 42 | 42 | 2.3 | 36 | 3.92 |
| CMFG4248P1 | 864 | 894 | 42 | 48 | 2.3 | 41 | 4.45 |
| CMFG4254P1 | 954 | 984 | 42 | 54 | 2.3 | 46 | 4.99 |
| CMFG4260P1 | 1028 | 1060 | 42 | 60 | 2.3 | 51 | 5.52 |
| CMFG4824P1 | 621 | 634 | 48 | 24 | 2.3 | 26 | 2.73 |
| CMFG4830P1 | 714 | 727 | 48 | 30 | 2.3 | 33 | 3.37 |
| CMFG4836P1 | 795 | 825 | 48 | 36 | 2.3 | 39 | 4.00 |
| CMFG4842P1 | 872 | 903 | 48 | 42 | 2.3 | 46 | 4.63 |
| CMFG4848P1 | 949 | 977 | 48 | 48 | 2.3 | 52 | 5.26 |
| CMFG4854P1 | 1072 | 1102 | 48 | 54 | 2.3 | 59 | 5.89 |
| CMFG4860P1 | 1186 | 1214 | 48 | 60 | 2.3 | 65 | 6.53 |
| CMFG5424P1 | 621 | 634 | 54 | 24 | 2.3 | 26 | 2.73 |
| CMFG5430P1 | 714 | 726 | 54 | 30 | 2.3 | 33 | 3.37 |
| CMFG5436P1 | 794 | 825 | 54 | 36 | 2.3 | 39 | 4.00 |
| CMFG5442P1 | 872 | 903 | 54 | 42 | 2.3 | 46 | 4.63 |
| CMFG5448P1 | 949 | 977 | 54 | 48 | 2.3 | 52 | 5.26 |
| CMFG5454P1 | 1072 | 1102 | 54 | 54 | 2.3 | 59 | 5.89 |
| CMFG5460P1 | 1186 | 1214 | 54 | 60 | 2.3 | 65 | 6.53 |
| CMFG6624P1 | 757 | 774 | 66 | 24 | 2.3 | 32 | 3.58 |
| CMFG6630P1 | 907 | 921 | 66 | 30 | 2.3 | 40 | 4.40 |
| CMFG6636P1 | 1017 | 1046 | 66 | 36 | 2.3 | 48 | 5.23 |
| CMFG6642P1 | 1121 | 1152 | 66 | 42 | 2.3 | 56 | 6.06 |
| CMFG6648P1 | 1223 | 1254 | 66 | 48 | 2.3 | 64 | 6.88 |
| CMFG6654P1 | 1329 | 1360 | 66 | 54 | 2.3 | 72 | 7.71 |
| CMFG6660P1 | 1434 | 1463 | 66 | 60 | 2.3 | 80 | 8.53 |

CMFG-P2 • Single Glazed, Powered Fabric Panel, Punchouts on Both Sides

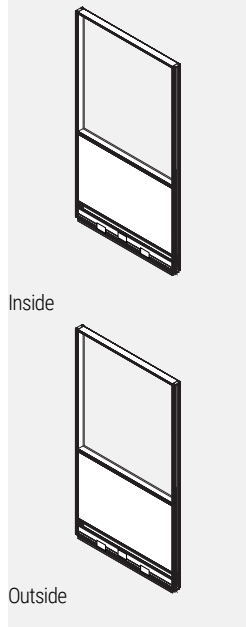

- Individual fabric-covered module in lower position with glazed module in upper position incorporated into a aluminum frame.
- Opposite sides of each module may have a different fabric within the same grade at no upcharge.
- If different grades of fabric are used on one panel, the entire panel must be priced at highest grade.
- Panels are not tackable.
- Note: Trim is not required at a straight connection between two panels of the same height.
- 3 Panel connector brackets per side come standard with 42" h. and 54" h. panels.
- 4 Panel connector brackets per side come standard with 66" h. panels.
- Panels include 2 raceway covers with punchouts on both sides, a power distribution housing, an integrated aluminum top cap and levelling glides.
- Standard in clear (CLR) plexi.
- Optional frosted (FRST) plexi
- 24" wide panels have two punchouts, one for electrical and one for data.
- 30" wide panels and wider have three punchouts, two for electrical and one for data.
- Glazing starts at 29" high to the top of the panel.
- Please specify duplex receptacles separately.

| PRODUCT CODE | PRICE | | SIZE/ INCHES | | | WEIGHT VOL | |
|--------------|-------|------|--------------|----|-----|------------|-----------------|
| | GR 1 | GR 2 | H | W | D | LBS | FT ³ |
| CMFG4224P2 | 582 | 600 | 42 | 24 | 2.3 | 20 | 2.31 |
| CMFG4230P2 | 678 | 692 | 42 | 30 | 2.3 | 25 | 2.85 |
| CMFG4236P2 | 731 | 761 | 42 | 36 | 2.3 | 31 | 3.38 |
| CMFG4242P2 | 796 | 826 | 42 | 42 | 2.3 | 36 | 3.92 |
| CMFG4248P2 | 864 | 894 | 42 | 48 | 2.3 | 41 | 4.45 |
| CMFG4254P2 | 954 | 984 | 42 | 54 | 2.3 | 46 | 4.99 |
| CMFG4260P2 | 1028 | 1060 | 42 | 60 | 2.3 | 51 | 5.52 |
| CMFG4824P2 | 621 | 634 | 48 | 24 | 2.3 | 26 | 2.73 |
| CMFG4830P2 | 714 | 727 | 48 | 30 | 2.3 | 33 | 3.37 |
| CMFG4836P2 | 795 | 825 | 48 | 36 | 2.3 | 39 | 4.00 |
| CMFG4842P2 | 872 | 903 | 48 | 42 | 2.3 | 46 | 4.63 |
| CMFG4848P2 | 949 | 977 | 48 | 48 | 2.3 | 52 | 5.26 |
| CMFG4854P2 | 1072 | 1102 | 48 | 54 | 2.3 | 59 | 5.89 |
| CMFG4860P2 | 1186 | 1214 | 48 | 60 | 2.3 | 65 | 6.53 |
| CMFG5424P2 | 621 | 634 | 54 | 24 | 2.3 | 26 | 2.73 |
| CMFG5430P2 | 714 | 726 | 54 | 30 | 2.3 | 33 | 3.37 |
| CMFG5436P2 | 794 | 825 | 54 | 36 | 2.3 | 39 | 4.00 |
| CMFG5442P2 | 872 | 903 | 54 | 42 | 2.3 | 46 | 4.63 |
| CMFG5448P2 | 949 | 977 | 54 | 48 | 2.3 | 52 | 5.26 |
| CMFG5454P2 | 1072 | 1102 | 54 | 54 | 2.3 | 59 | 5.89 |
| CMFG5460P2 | 1186 | 1214 | 54 | 60 | 2.3 | 65 | 6.53 |
| CMFG6624P2 | 757 | 774 | 66 | 24 | 2.3 | 32 | 3.58 |
| CMFG6630P2 | 907 | 921 | 66 | 30 | 2.3 | 40 | 4.40 |
| CMFG6636P2 | 1017 | 1046 | 66 | 36 | 2.3 | 48 | 5.23 |
| CMFG6642P2 | 1121 | 1152 | 66 | 42 | 2.3 | 56 | 6.06 |
| CMFG6648P2 | 1223 | 1254 | 66 | 48 | 2.3 | 64 | 6.88 |
| CMFG6654P2 | 1329 | 1360 | 66 | 54 | 2.3 | 72 | 7.71 |
| CMFG6660P2 | 1434 | 1463 | 66 | 60 | 2.3 | 80 | 8.53 |

CMPLG-N0 • Single 12" Glazed at top, Non Powered Fabric Panel, No Punchouts

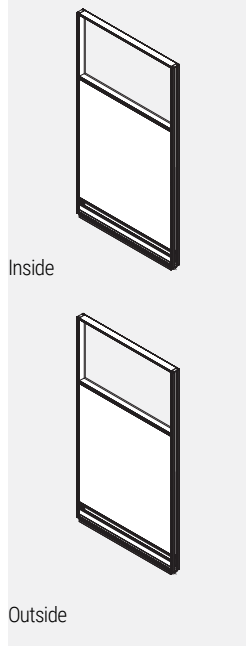

- Individual fabric-covered module in lower position with glazed module in upper position incorporated into an aluminum frame.
- Opposite sides of each module may have a different fabric within the same grade at no upcharge.
- If different grades of fabric are used on one panel, the entire panel must be priced at highest grade.
- Panels are not tackable.
- Note: Trim is not required at a straight connection between two panels of the same height.
- 3 Panel connector brackets per side come standard with 42"h. and 54"h. panels.
- 4 Panel connector brackets per side come standard with 66"h. panels.
- Panels include 2 raceway covers with no punchouts, an integrated aluminum top cap and levelling glides.
- Standard in clear (CLR) plexi.
- Optional frosted (FRST) plexi
- Glazing is 12" nominal from the top of the panel.

| PRODUCT CODE | PRICE | | SIZE/ INCHES | | | WEIGHT VOL | |
|--------------|-------|------|--------------|----|-----|------------|------|
| | GR 1 | GR 2 | H | W | D | LBS | FT³ |
| CMPLG4224N0 | 446 | 459 | 42 | 24 | 2.3 | 20 | 2.31 |
| CMPLG4230N0 | 488 | 507 | 42 | 30 | 2.3 | 25 | 2.85 |
| CMPLG4236N0 | 537 | 567 | 42 | 36 | 2.3 | 31 | 3.38 |
| CMPLG4242N0 | 593 | 625 | 42 | 42 | 2.3 | 36 | 3.92 |
| CMPLG4248N0 | 652 | 681 | 42 | 48 | 2.3 | 41 | 4.45 |
| CMPLG4254N0 | 736 | 765 | 42 | 54 | 2.3 | 46 | 4.99 |
| CMPLG4260N0 | 811 | 840 | 42 | 60 | 2.3 | 51 | 5.52 |
| CMPLG4824N0 | 477 | 491 | 48 | 24 | 2.3 | 26 | 2.73 |
| CMPLG4830N0 | 550 | 567 | 48 | 30 | 2.3 | 33 | 3.37 |
| CMPLG4836N0 | 613 | 644 | 48 | 36 | 2.3 | 39 | 4.00 |
| CMPLG4842N0 | 690 | 720 | 48 | 42 | 2.3 | 46 | 4.63 |
| CMPLG4848N0 | 759 | 790 | 48 | 48 | 2.3 | 52 | 5.26 |
| CMPLG4854N0 | 839 | 870 | 48 | 54 | 2.3 | 59 | 5.89 |
| CMPLG4860N0 | 913 | 941 | 48 | 60 | 2.3 | 65 | 6.53 |
| CMPLG5424N0 | 477 | 490 | 54 | 24 | 2.3 | 26 | 2.73 |
| CMPLG5430N0 | 550 | 567 | 54 | 30 | 2.3 | 33 | 3.37 |
| CMPLG5436N0 | 613 | 644 | 54 | 36 | 2.3 | 39 | 4.00 |
| CMPLG5442N0 | 689 | 720 | 54 | 42 | 2.3 | 46 | 4.63 |
| CMPLG5448N0 | 759 | 790 | 54 | 48 | 2.3 | 52 | 5.26 |
| CMPLG5454N0 | 840 | 869 | 54 | 54 | 2.3 | 59 | 5.89 |
| CMPLG5460N0 | 913 | 942 | 54 | 60 | 2.3 | 65 | 6.53 |
| CMPLG6624N0 | 524 | 555 | 66 | 24 | 2.3 | 32 | 3.58 |
| CMPLG6630N0 | 608 | 638 | 66 | 30 | 2.3 | 40 | 4.40 |
| CMPLG6636N0 | 676 | 736 | 66 | 36 | 2.3 | 48 | 5.23 |
| CMPLG6642N0 | 754 | 814 | 66 | 42 | 2.3 | 56 | 6.06 |
| CMPLG6648N0 | 833 | 894 | 66 | 48 | 2.3 | 64 | 6.88 |
| CMPLG6654N0 | 920 | 982 | 66 | 54 | 2.3 | 72 | 7.71 |
| CMPLG6660N0 | 999 | 1061 | 66 | 60 | 2.3 | 80 | 8.53 |

CMPLG-N1 • Single 12" Glazed at top, Non Powered Panel, Punchouts on One Side

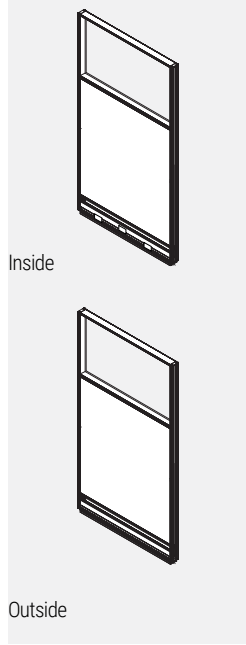

- Individual fabric-covered module in lower position with glazed module in upper position incorporated into an aluminum frame.
- Opposite sides of each module may have a different fabric within the same grade at no upcharge.
- If different grades of fabric are used on one panel, the entire panel must be priced at highest grade.
- Panels are not tackable.
- Note: Trim is not required at a straight connection between two panels of the same height.
- 3 Panel connector brackets per side come standard with 42"h. and 54"h. panels.
- 4 Panel connector brackets per side come standard with 66"h. panels.
- Panels include 1 raceway cover with punchouts on one side, 1 raceway cover with no punchouts on the other, an integrated aluminum top cap and levelling glides.
- Standard in clear (CLR) plexi.
- Optional frosted (FRST) plexi
- 24" wide panels have two punchouts, one for electrical and one for data.
- 30" wide panels and wider have three punchouts, two for electrical and one for data.
- Glazing is 12" nominal from the top of the panel.

| PRODUCT CODE | PRICE | | SIZE/ INCHES | | | WEIGHT VOL | |
|--------------|-------|------|--------------|----|-----|------------|------|
| | GR 1 | GR 2 | H | W | D | LBS | FT³ |
| CMPLG4224N1 | 446 | 459 | 42 | 24 | 2.3 | 20 | 2.31 |
| CMPLG4230N1 | 488 | 507 | 42 | 30 | 2.3 | 25 | 2.85 |
| CMPLG4236N1 | 537 | 567 | 42 | 36 | 2.3 | 31 | 3.38 |
| CMPLG4242N1 | 593 | 625 | 42 | 42 | 2.3 | 36 | 3.92 |
| CMPLG4248N1 | 652 | 681 | 42 | 48 | 2.3 | 41 | 4.45 |
| CMPLG4254N1 | 736 | 765 | 42 | 54 | 2.3 | 46 | 4.99 |
| CMPLG4260N1 | 811 | 840 | 42 | 60 | 2.3 | 51 | 5.52 |
| CMPLG4824N1 | 477 | 491 | 48 | 24 | 2.3 | 26 | 2.73 |
| CMPLG4830N1 | 550 | 567 | 48 | 30 | 2.3 | 33 | 3.37 |
| CMPLG4836N1 | 613 | 644 | 48 | 36 | 2.3 | 39 | 4.00 |
| CMPLG4842N1 | 690 | 720 | 48 | 42 | 2.3 | 46 | 4.63 |
| CMPLG4848N1 | 759 | 790 | 48 | 48 | 2.3 | 52 | 5.26 |
| CMPLG4854N1 | 839 | 870 | 48 | 54 | 2.3 | 59 | 5.89 |
| CMPLG4860N1 | 913 | 941 | 48 | 60 | 2.3 | 65 | 6.53 |
| CMPLG5424N1 | 477 | 490 | 54 | 24 | 2.3 | 26 | 2.73 |
| CMPLG5430N1 | 550 | 567 | 54 | 30 | 2.3 | 33 | 3.37 |
| CMPLG5436N1 | 613 | 644 | 54 | 36 | 2.3 | 39 | 4.00 |
| CMPLG5442N1 | 689 | 720 | 54 | 42 | 2.3 | 46 | 4.63 |
| CMPLG5448N1 | 759 | 790 | 54 | 48 | 2.3 | 52 | 5.26 |
| CMPLG5454N1 | 840 | 869 | 54 | 54 | 2.3 | 59 | 5.89 |
| CMPLG5460N1 | 913 | 942 | 54 | 60 | 2.3 | 65 | 6.53 |
| CMPLG6624N1 | 524 | 555 | 66 | 24 | 2.3 | 32 | 3.58 |
| CMPLG6630N1 | 608 | 638 | 66 | 30 | 2.3 | 40 | 4.40 |
| CMPLG6636N1 | 676 | 736 | 66 | 36 | 2.3 | 48 | 5.23 |
| CMPLG6642N1 | 754 | 814 | 66 | 42 | 2.3 | 56 | 6.06 |
| CMPLG6648N1 | 833 | 894 | 66 | 48 | 2.3 | 64 | 6.88 |
| CMPLG6654N1 | 920 | 982 | 66 | 54 | 2.3 | 72 | 7.71 |
| CMPLG6660N1 | 999 | 1061 | 66 | 60 | 2.3 | 80 | 8.53 |

CMPLG-N2 • Single 12" at Top, Non Powered Fabric Panel, Punchouts on Both Sides

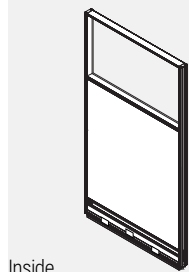

Inside

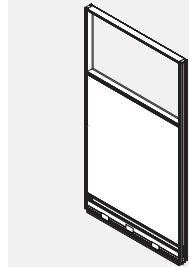

Outside

- Individual fabric-covered module in lower position with glazed module in upper position incorporated into a solid steel frame.
- Opposite sides of each module may have a different fabric within the same grade at no upcharge.
- If different grades of fabric are used on one panel, the entire panel must be priced at highest grade.
- Panels are not tackable.
- Note: Trim is not required at a straight connection between two panels of the same height.
- 3 Panel connector brackets per side come standard with 42" h. and 54" h. panels.
- 4 Panel connector brackets per side come standard with 66" h. panels.
- Panels include 2 raceway covers with punchouts on both sides, an integrated aluminum top cap and levelling glides.
- Standard in clear (CLR) plexi.
- Optional frosted (FRST) plexi
- 24" wide panels have two punchouts, one for electrical and one for data.
- 30" wide panels and wider have three punchouts, two for electrical and one for data.
- Glazing is 12" nominal from the top of the panel.

| PRODUCT CODE | PRICE | | SIZE/ INCHES | | | WEIGHT VOL | |
|--------------|-------|------|--------------|----|-----|------------|-----------------|
| | GR 1 | GR 2 | H | W | D | LBS | FT ³ |
| CMPLG4224N2 | 446 | 459 | 42 | 24 | 2.3 | 20 | 2.31 |
| CMPLG4230N2 | 488 | 507 | 42 | 30 | 2.3 | 25 | 2.85 |
| CMPLG4236N2 | 537 | 567 | 42 | 36 | 2.3 | 31 | 3.38 |
| CMPLG4242N2 | 593 | 625 | 42 | 42 | 2.3 | 36 | 3.92 |
| CMPLG4248N2 | 652 | 681 | 42 | 48 | 2.3 | 41 | 4.45 |
| CMPLG4254N2 | 736 | 765 | 42 | 54 | 2.3 | 46 | 4.99 |
| CMPLG4260N2 | 811 | 840 | 42 | 60 | 2.3 | 51 | 5.52 |
| CMPLG4824N2 | 477 | 491 | 48 | 24 | 2.3 | 26 | 2.73 |
| CMPLG4830N2 | 550 | 567 | 48 | 30 | 2.3 | 33 | 3.37 |
| CMPLG4836N2 | 613 | 644 | 48 | 36 | 2.3 | 39 | 4.00 |
| CMPLG4842N2 | 690 | 720 | 48 | 42 | 2.3 | 46 | 4.63 |
| CMPLG4848N2 | 759 | 790 | 48 | 48 | 2.3 | 52 | 5.26 |
| CMPLG4854N2 | 839 | 870 | 48 | 54 | 2.3 | 59 | 5.89 |
| CMPLG4860N2 | 913 | 941 | 48 | 60 | 2.3 | 65 | 6.53 |
| CMPLG5424N2 | 477 | 490 | 54 | 24 | 2.3 | 26 | 2.73 |
| CMPLG5430N2 | 550 | 567 | 54 | 30 | 2.3 | 33 | 3.37 |
| CMPLG5436N2 | 613 | 644 | 54 | 36 | 2.3 | 39 | 4.00 |
| CMPLG5442N2 | 689 | 720 | 54 | 42 | 2.3 | 46 | 4.63 |
| CMPLG5448N2 | 759 | 790 | 54 | 48 | 2.3 | 52 | 5.26 |
| CMPLG5454N2 | 840 | 869 | 54 | 54 | 2.3 | 59 | 5.89 |
| CMPLG5460N2 | 913 | 942 | 54 | 60 | 2.3 | 65 | 6.53 |
| CMPLG6624N2 | 524 | 555 | 66 | 24 | 2.3 | 32 | 3.58 |
| CMPLG6630N2 | 608 | 638 | 66 | 30 | 2.3 | 40 | 4.40 |
| CMPLG6636N2 | 676 | 736 | 66 | 36 | 2.3 | 48 | 5.23 |
| CMPLG6642N2 | 754 | 814 | 66 | 42 | 2.3 | 56 | 6.06 |
| CMPLG6648N2 | 833 | 894 | 66 | 48 | 2.3 | 64 | 6.88 |
| CMPLG6654N2 | 920 | 982 | 66 | 54 | 2.3 | 72 | 7.71 |
| CMPLG6660N2 | 999 | 1061 | 66 | 60 | 2.3 | 80 | 8.53 |

CMPLG-P1 • Single 12" Glazed at Top, Powered Fabric Panel, Punchouts on One Side

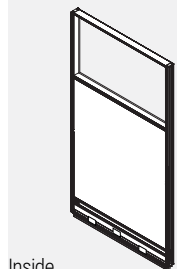

Inside

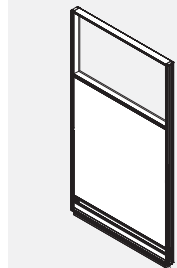

Outside

- Individual fabric-covered module in lower position with glazed module in upper position incorporated into a solid steel frame.
- Opposite sides of each module may have a different fabric within the same grade at no upcharge.
- If different grades of fabric are used on one panel, the entire panel must be priced at highest grade.
- Panels are not tackable.
- Note: Trim is not required at a straight connection between two panels of the same height.
- 3 Panel connector brackets per side come standard with 42" h. and 54" h. panels.
- 4 Panel connector brackets per side come standard with 66" h. panels.
- Panels include 1 raceway cover with punchouts on one side, 1 raceway cover with no punchouts on the other, a power distribution housing, an integrated aluminum top cap and levelling glides.
- Standard in clear (CLR) plexi.
- Optional frosted (FRST) plexi
- 24" wide panels have two punchouts, one for electrical and one for data.
- 30" wide panels and wider have three punchouts, two for electrical and one for data.
- Please specify duplex receptacles separately.
- Glazing is 12" nominal from the top of the panel.

| PRODUCT CODE | PRICE | | SIZE/ INCHES | | | WEIGHT VOL | |
|--------------|-------|------|--------------|----|-----|------------|-----------------|
| | GR 1 | GR 2 | H | W | D | LBS | FT ³ |
| CMPLG4224P1 | 582 | 600 | 42 | 24 | 2.3 | 20 | 2.31 |
| CMPLG4230P1 | 678 | 692 | 42 | 30 | 2.3 | 25 | 2.85 |
| CMPLG4236P1 | 731 | 761 | 42 | 36 | 2.3 | 31 | 3.38 |
| CMPLG4242P1 | 796 | 826 | 42 | 42 | 2.3 | 36 | 3.92 |
| CMPLG4248P1 | 864 | 894 | 42 | 48 | 2.3 | 41 | 4.45 |
| CMPLG4254P1 | 954 | 984 | 42 | 54 | 2.3 | 46 | 4.99 |
| CMPLG4260P1 | 1028 | 1060 | 42 | 60 | 2.3 | 51 | 5.52 |
| CMPLG4824P1 | 614 | 630 | 48 | 24 | 2.3 | 26 | 2.73 |
| CMPLG4830P1 | 737 | 752 | 48 | 30 | 2.3 | 33 | 3.37 |
| CMPLG4836P1 | 809 | 839 | 48 | 36 | 2.3 | 39 | 4.00 |
| CMPLG4842P1 | 892 | 921 | 48 | 42 | 2.3 | 46 | 4.63 |
| CMPLG4848P1 | 974 | 1004 | 48 | 48 | 2.3 | 52 | 5.26 |
| CMPLG4854P1 | 1057 | 1087 | 48 | 54 | 2.3 | 59 | 5.89 |
| CMPLG4860P1 | 1131 | 1160 | 48 | 60 | 2.3 | 65 | 6.53 |
| CMPLG5424P1 | 614 | 630 | 54 | 24 | 2.3 | 26 | 2.73 |
| CMPLG5430P1 | 737 | 752 | 54 | 30 | 2.3 | 33 | 3.37 |
| CMPLG5436P1 | 811 | 840 | 54 | 36 | 2.3 | 39 | 4.00 |
| CMPLG5442P1 | 892 | 921 | 54 | 42 | 2.3 | 46 | 4.63 |
| CMPLG5448P1 | 973 | 1003 | 54 | 48 | 2.3 | 52 | 5.26 |
| CMPLG5454P1 | 1057 | 1088 | 54 | 54 | 2.3 | 59 | 5.89 |
| CMPLG5460P1 | 1131 | 1160 | 54 | 60 | 2.3 | 65 | 6.53 |
| CMPLG6624P1 | 665 | 694 | 66 | 24 | 2.3 | 32 | 3.58 |
| CMPLG6630P1 | 794 | 825 | 66 | 30 | 2.3 | 40 | 4.40 |
| CMPLG6636P1 | 870 | 931 | 66 | 36 | 2.3 | 48 | 5.23 |
| CMPLG6642P1 | 956 | 1017 | 66 | 42 | 2.3 | 56 | 6.06 |
| CMPLG6648P1 | 1050 | 1108 | 66 | 48 | 2.3 | 64 | 6.88 |
| CMPLG6654P1 | 1137 | 1198 | 66 | 54 | 2.3 | 72 | 7.71 |
| CMPLG6660P1 | 1218 | 1278 | 66 | 60 | 2.3 | 80 | 8.53 |

CMPLG-P2 • Single 12" Glazed at Top, Powered Fabric Panel, Punchouts on Both Sides

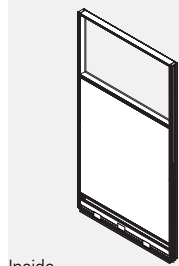

Inside

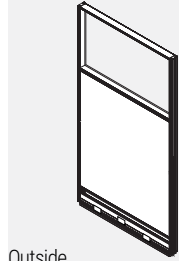

Outside

- Individual fabric-covered module in lower position with glazed module in upper position incorporated into an aluminum frame.
- Opposite sides of each module may have a different fabric within the same grade at no upcharge.
- If different grades of fabric are used on one panel, the entire panel must be priced at highest grade.
- Panels are not tackable.
- Note: Trim is not required at a straight connection between two panels of the same height.
- 3 Panel connector brackets per side come standard with 42"h. and 54"h. panels.
- 4 Panel connector brackets per side come standard with 66"h. panels.
- Panels include 2 raceway covers with punchouts on both sides, a power distribution housing, an integrated aluminum top cap and levelling glides.
- Standard in clear (CLR) plexi.
- Optional frosted (FRST) plexi
- 24" wide panels have two punchouts, one for electrical and one for data.
- 30" wide panels and wider have three punchouts, two for electrical and one for data.
- Glazing is 12" nominal from the top of the panel. panels and wider have 2 punchouts.
- Please specify duplex receptacles separately.

| PRODUCT CODE | PRICE | | SIZE/ INCHES | | | WEIGHT VOL | |
|--------------|-------|------|--------------|----|-----|------------|------|
| | GR 1 | GR 2 | H | W | D | LBS | FT³ |
| CMPLG4224P2 | 582 | 600 | 42 | 24 | 2.3 | 20 | 2.31 |
| CMPLG4230P2 | 678 | 692 | 42 | 30 | 2.3 | 25 | 2.85 |
| CMPLG4236P2 | 731 | 761 | 42 | 36 | 2.3 | 31 | 3.38 |
| CMPLG4242P2 | 796 | 826 | 42 | 42 | 2.3 | 36 | 3.92 |
| CMPLG4248P2 | 864 | 894 | 42 | 48 | 2.3 | 41 | 4.45 |
| CMPLG4254P2 | 954 | 984 | 42 | 54 | 2.3 | 46 | 4.99 |
| CMPLG4260P2 | 1028 | 1060 | 42 | 60 | 2.3 | 51 | 5.52 |
| CMPLG4824P2 | 614 | 630 | 48 | 24 | 2.3 | 26 | 2.73 |
| CMPLG4830P2 | 737 | 752 | 48 | 30 | 2.3 | 33 | 3.37 |
| CMPLG4836P2 | 809 | 839 | 48 | 36 | 2.3 | 39 | 4.00 |
| CMPLG4842P2 | 892 | 921 | 48 | 42 | 2.3 | 46 | 4.63 |
| CMPLG4848P2 | 974 | 1004 | 48 | 48 | 2.3 | 52 | 5.26 |
| CMPLG4854P2 | 1057 | 1087 | 48 | 54 | 2.3 | 59 | 5.89 |
| CMPLG4860P2 | 1131 | 1160 | 48 | 60 | 2.3 | 65 | 6.53 |
| CMPLG5424P2 | 614 | 630 | 54 | 24 | 2.3 | 26 | 2.73 |
| CMPLG5430P2 | 737 | 752 | 54 | 30 | 2.3 | 33 | 3.37 |
| CMPLG5436P2 | 811 | 840 | 54 | 36 | 2.3 | 39 | 4.00 |
| CMPLG5442P2 | 892 | 921 | 54 | 42 | 2.3 | 46 | 4.63 |
| CMPLG5448P2 | 973 | 1003 | 54 | 48 | 2.3 | 52 | 5.26 |
| CMPLG5454P2 | 1057 | 1088 | 54 | 54 | 2.3 | 59 | 5.89 |
| CMPLG5460P2 | 1131 | 1160 | 54 | 60 | 2.3 | 65 | 6.53 |
| CMPLG6624P2 | 665 | 694 | 66 | 24 | 2.3 | 32 | 3.58 |
| CMPLG6630P2 | 794 | 825 | 66 | 30 | 2.3 | 40 | 4.40 |
| CMPLG6636P2 | 870 | 931 | 66 | 36 | 2.3 | 48 | 5.23 |
| CMPLG6642P2 | 956 | 1017 | 66 | 42 | 2.3 | 56 | 6.06 |
| CMPLG6648P2 | 1050 | 1108 | 66 | 48 | 2.3 | 64 | 6.88 |
| CMPLG6654P2 | 1137 | 1198 | 66 | 54 | 2.3 | 72 | 7.71 |
| CMPLG6660P2 | 1218 | 1278 | 66 | 60 | 2.3 | 80 | 8.53 |

CMPG-N0 • Single 14" Glazed at Top Glazed Panel, Non Powered Fabric Panel, No Punchouts

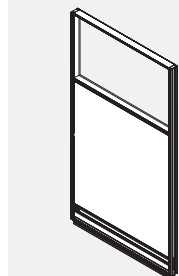

Inside

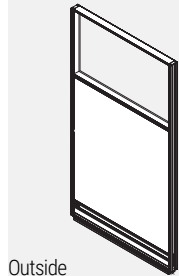

Outside

- Individual fabric-covered module in lower position with glazed module in upper position incorporated into an aluminum frame.
- Opposite sides of each module may have a different fabric within the same grade at no upcharge.
- If different grades of fabric are used on one panel, the entire panel must be priced at highest grade.
- Panels are not tackable.
- Note: Trim is not required at a straight connection between two panels of the same height.
- 3 Panel connector brackets per side come standard with 42"h. and 54"h. panels.
- 4 Panel connector brackets per side come standard with 66"h. panels.
- Panels include 2 raceway covers with no punchouts, an integrated aluminum top cap and levelling glides.
- Standard in clear (CLR) plexi.
- Optional frosted (FRST) plexi
- PVC Glass Retainer may match any panel frame finish.
- Glazing is 14" nominal from the top of the panel.

| PRODUCT CODE | PRICE | | SIZE/ INCHES | | | WEIGHT VOL | |
|--------------|-------|------|--------------|----|-----|------------|------|
| | GR 1 | GR 2 | H | W | D | LBS | FT³ |
| CMPG4224N0 | 446 | 459 | 42 | 24 | 2.3 | 20 | 2.31 |
| CMPG4230N0 | 488 | 507 | 42 | 30 | 2.3 | 25 | 2.85 |
| CMPG4236N0 | 537 | 567 | 42 | 36 | 2.3 | 31 | 3.38 |
| CMPG4242N0 | 593 | 625 | 42 | 42 | 2.3 | 36 | 3.92 |
| CMPG4248N0 | 652 | 681 | 42 | 48 | 2.3 | 41 | 4.45 |
| CMPG4254N0 | 736 | 765 | 42 | 54 | 2.3 | 46 | 4.99 |
| CMPG4260N0 | 811 | 840 | 42 | 60 | 2.3 | 51 | 5.52 |
| CMPG4824N0 | 477 | 491 | 48 | 24 | 2.3 | 26 | 2.73 |
| CMPG4830N0 | 550 | 567 | 48 | 30 | 2.3 | 33 | 3.37 |
| CMPG4836N0 | 613 | 644 | 48 | 36 | 2.3 | 39 | 4.00 |
| CMPG4842N0 | 690 | 720 | 48 | 42 | 2.3 | 46 | 4.63 |
| CMPG4848N0 | 759 | 790 | 48 | 48 | 2.3 | 52 | 5.26 |
| CMPG4854N0 | 839 | 870 | 48 | 54 | 2.3 | 59 | 5.89 |
| CMPG4860N0 | 913 | 941 | 48 | 60 | 2.3 | 65 | 6.53 |
| CMPG5424N0 | 477 | 490 | 54 | 24 | 2.3 | 26 | 2.73 |
| CMPG5430N0 | 550 | 567 | 54 | 30 | 2.3 | 33 | 3.37 |
| CMPG5436N0 | 613 | 644 | 54 | 36 | 2.3 | 39 | 4.00 |
| CMPG5442N0 | 689 | 720 | 54 | 42 | 2.3 | 46 | 4.63 |
| CMPG5448N0 | 759 | 790 | 54 | 48 | 2.3 | 52 | 5.26 |
| CMPG5454N0 | 840 | 869 | 54 | 54 | 2.3 | 59 | 5.89 |
| CMPG5460N0 | 913 | 942 | 54 | 60 | 2.3 | 65 | 6.53 |
| CMPG6624N0 | 524 | 555 | 66 | 24 | 2.3 | 32 | 3.58 |
| CMPG6630N0 | 608 | 638 | 66 | 30 | 2.3 | 40 | 4.40 |
| CMPG6636N0 | 676 | 736 | 66 | 36 | 2.3 | 48 | 5.23 |
| CMPG6642N0 | 754 | 814 | 66 | 42 | 2.3 | 56 | 6.06 |
| CMPG6648N0 | 833 | 894 | 66 | 48 | 2.3 | 64 | 6.88 |
| CMPG6654N0 | 920 | 982 | 66 | 54 | 2.3 | 72 | 7.71 |
| CMPG6660N0 | 999 | 1061 | 66 | 60 | 2.3 | 80 | 8.53 |

CMPG-N1 • Single 14" Glazed at Top Glazed Panel, Non Powered Fabric Panel, Punchouts on One Side

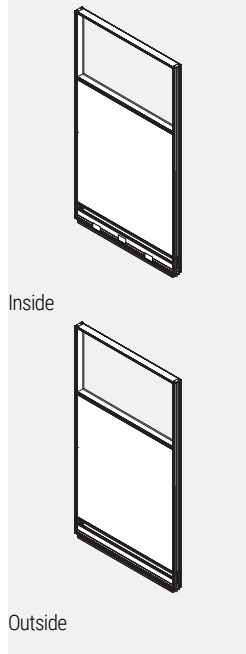

- Individual fabric-covered module in lower position with glazed module in upper position incorporated into an aluminum frame.
- Opposite sides of each module may have a different fabric within the same grade at no upcharge.
- If different grades of fabric are used on one panel, the entire panel must be priced at highest grade.
- Panels are not tackable.
- Note: Trim is not required at a straight connection between two panels of the same height.
- 3 Panel connector brackets per side come standard with 42" h. and 54" h. panels.
- 4 Panel connector brackets per side come standard with 66" h. panels.
- Panels include 1 raceway cover with punchouts on one side, 1 raceway cover with no punchouts on the other, an integrated aluminum top cap and levelling glides.
- Standard in clear (CLR) plexi.
- Optional frosted (FRST) plexi
- 24" wide panels have two punchouts, one for electrical and one for data.
- 30" wide panels and wider have three punchouts, two for electrical and one for data.
- Glazing is 14" nominal from the top of the panel.

| PRODUCT CODE | PRICE | | SIZE/ INCHES | | | WEIGHT VOL | |
|--------------|-------|------|--------------|----|-----|------------|-----------------|
| | GR 1 | GR 2 | H | W | D | LBS | FT ³ |
| CMPG4224N1 | 446 | 459 | 42 | 24 | 2.3 | 20 | 2.31 |
| CMPG4230N1 | 488 | 507 | 42 | 30 | 2.3 | 25 | 2.85 |
| CMPG4236N1 | 537 | 567 | 42 | 36 | 2.3 | 31 | 3.38 |
| CMPG4242N1 | 593 | 625 | 42 | 42 | 2.3 | 36 | 3.92 |
| CMPG4248N1 | 652 | 681 | 42 | 48 | 2.3 | 41 | 4.45 |
| CMPG4254N1 | 736 | 765 | 42 | 54 | 2.3 | 46 | 4.99 |
| CMPG4260N1 | 811 | 840 | 42 | 60 | 2.3 | 51 | 5.52 |
| CMPG4824N1 | 477 | 491 | 48 | 24 | 2.3 | 26 | 2.73 |
| CMPG4830N1 | 550 | 567 | 48 | 30 | 2.3 | 33 | 3.37 |
| CMPG4836N1 | 613 | 644 | 48 | 36 | 2.3 | 39 | 4.00 |
| CMPG4842N1 | 690 | 720 | 48 | 42 | 2.3 | 46 | 4.63 |
| CMPG4848N1 | 759 | 790 | 48 | 48 | 2.3 | 52 | 5.26 |
| CMPG4854N1 | 839 | 870 | 48 | 54 | 2.3 | 59 | 5.89 |
| CMPG4860N1 | 913 | 941 | 48 | 60 | 2.3 | 65 | 6.53 |
| CMPG5424N1 | 477 | 490 | 54 | 24 | 2.3 | 26 | 2.73 |
| CMPG5430N1 | 550 | 567 | 54 | 30 | 2.3 | 33 | 3.37 |
| CMPG5436N1 | 613 | 644 | 54 | 36 | 2.3 | 39 | 4.00 |
| CMPG5442N1 | 689 | 720 | 54 | 42 | 2.3 | 46 | 4.63 |
| CMPG5448N1 | 759 | 790 | 54 | 48 | 2.3 | 52 | 5.26 |
| CMPG5454N1 | 840 | 869 | 54 | 54 | 2.3 | 59 | 5.89 |
| CMPG5460N1 | 913 | 942 | 54 | 60 | 2.3 | 65 | 6.53 |
| CMPG6624N1 | 524 | 555 | 66 | 24 | 2.3 | 32 | 3.58 |
| CMPG6630N1 | 608 | 638 | 66 | 30 | 2.3 | 40 | 4.40 |
| CMPG6636N1 | 676 | 736 | 66 | 36 | 2.3 | 48 | 5.23 |
| CMPG6642N1 | 754 | 814 | 66 | 42 | 2.3 | 56 | 6.06 |
| CMPG6648N1 | 833 | 894 | 66 | 48 | 2.3 | 64 | 6.88 |
| CMPG6654N1 | 920 | 982 | 66 | 54 | 2.3 | 72 | 7.71 |
| CMPG6660N1 | 999 | 1061 | 66 | 60 | 2.3 | 80 | 8.53 |

CMPG-N2 • Single 14" Glazed at Top, Non Powered Fabric Panel, Punchouts on Both Sides

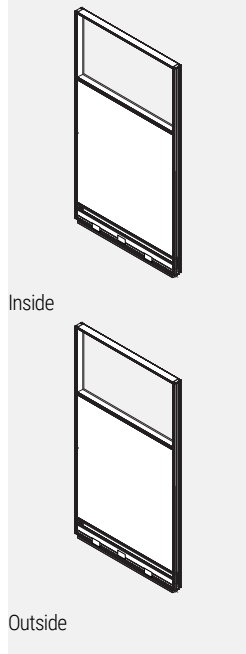

- Individual fabric-covered module in lower position with glazed module in upper position incorporated into a solid steel frame.
- Opposite sides of each module may have a different fabric within the same grade at no upcharge.
- If different grades of fabric are used on one panel, the entire panel must be priced at highest grade.
- Panels are not tackable.
- Note: Trim is not required at a straight connection between two panels of the same height.
- 3 Panel connector brackets per side come standard with 42" h. and 54" h. panels.
- 4 Panel connector brackets per side come standard with 66" h. panels.
- Panels include 2 raceway covers with punchouts on both sides, an integrated aluminum top cap and levelling glides.
- Standard in clear (CLR) plexi.
- Optional frosted (FRST) plexi
- 24" wide panels have two punchouts, one for electrical and one for data.
- 30" wide panels and wider have three punchouts, two for electrical and one for data.
- Glazing is 14" nominal from the top of the panel.

| PRODUCT CODE | PRICE | | SIZE/ INCHES | | | WEIGHT VOL | |
|--------------|-------|------|--------------|----|-----|------------|-----------------|
| | GR 1 | GR 2 | H | W | D | LBS | FT ³ |
| CMPG4224N2 | 446 | 459 | 42 | 24 | 2.3 | 20 | 2.31 |
| CMPG4230N2 | 488 | 507 | 42 | 30 | 2.3 | 25 | 2.85 |
| CMPG4236N2 | 537 | 567 | 42 | 36 | 2.3 | 31 | 3.38 |
| CMPG4242N2 | 593 | 625 | 42 | 42 | 2.3 | 36 | 3.92 |
| CMPG4248N2 | 652 | 681 | 42 | 48 | 2.3 | 41 | 4.45 |
| CMPG4254N2 | 736 | 765 | 42 | 54 | 2.3 | 46 | 4.99 |
| CMPG4260N2 | 811 | 840 | 42 | 60 | 2.3 | 51 | 5.52 |
| CMPG4824N2 | 477 | 491 | 48 | 24 | 2.3 | 26 | 2.73 |
| CMPG4830N2 | 550 | 567 | 48 | 30 | 2.3 | 33 | 3.37 |
| CMPG4836N2 | 613 | 644 | 48 | 36 | 2.3 | 39 | 4.00 |
| CMPG4842N2 | 690 | 720 | 48 | 42 | 2.3 | 46 | 4.63 |
| CMPG4848N2 | 759 | 790 | 48 | 48 | 2.3 | 52 | 5.26 |
| CMPG4854N2 | 839 | 870 | 48 | 54 | 2.3 | 59 | 5.89 |
| CMPG4860N2 | 913 | 941 | 48 | 60 | 2.3 | 65 | 6.53 |
| CMPG5424N2 | 477 | 490 | 54 | 24 | 2.3 | 26 | 2.73 |
| CMPG5430N2 | 550 | 567 | 54 | 30 | 2.3 | 33 | 3.37 |
| CMPG5436N2 | 613 | 644 | 54 | 36 | 2.3 | 39 | 4.00 |
| CMPG5442N2 | 689 | 720 | 54 | 42 | 2.3 | 46 | 4.63 |
| CMPG5448N2 | 759 | 790 | 54 | 48 | 2.3 | 52 | 5.26 |
| CMPG5454N2 | 840 | 869 | 54 | 54 | 2.3 | 59 | 5.89 |
| CMPG5460N2 | 913 | 942 | 54 | 60 | 2.3 | 65 | 6.53 |
| CMPG6624N2 | 524 | 555 | 66 | 24 | 2.3 | 32 | 3.58 |
| CMPG6630N2 | 608 | 638 | 66 | 30 | 2.3 | 40 | 4.40 |
| CMPG6636N2 | 676 | 736 | 66 | 36 | 2.3 | 48 | 5.23 |
| CMPG6642N2 | 754 | 814 | 66 | 42 | 2.3 | 56 | 6.06 |
| CMPG6648N2 | 833 | 894 | 66 | 48 | 2.3 | 64 | 6.88 |
| CMPG6654N2 | 920 | 982 | 66 | 54 | 2.3 | 72 | 7.71 |
| CMPG6660N2 | 999 | 1061 | 66 | 60 | 2.3 | 80 | 8.53 |

CMPG-P1 • Single 14" Glazed at Top, Powered Fabric Panel, Punchouts on One Side

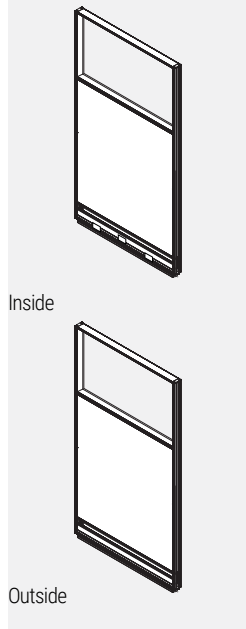

- Individual fabric-covered module in lower position with glazed module in upper position incorporated into a solid steel frame.
- Opposite sides of each module may have a different fabric within the same grade at no upcharge.
- If different grades of fabric are used on one panel, the entire panel must be priced at highest grade.
- Panels are not tackable.
- Note: Trim is not required at a straight connection between two panels of the same height.
- 3 Panel connector brackets per side come standard with 42"h. and 54"h. panels.
- 4 Panel connector brackets per side come standard with 66"h. panels.
- Panels include 1 raceway cover with punchouts on one side, 1 raceway cover with no punchouts on the other, a power distribution housing, an integrated aluminum top cap and levelling glides.
- Standard in clear (CLR) plexi.
- Optional frosted (FRST) plexi
- 24" wide panels have two punchouts, one for electrical and one for data.
- 30" wide panels and wider have three punchouts, two for electrical and one for data.
- Please specify duplex receptacles separately.
- Glazing is 14" nominal from the top of the panel.

| PRODUCT CODE | PRICE | | SIZE/ H | INCHES | | | WEIGHT VOL | |
|--------------|-------|------|---------|--------|-----|-----|-----------------|--|
| | GR 1 | GR 2 | | W | D | LBS | FT ³ | |
| CMPG4224P1 | 582 | 600 | 42 | 24 | 2.3 | 20 | 2.31 | |
| CMPG4230P1 | 678 | 692 | 42 | 30 | 2.3 | 25 | 2.85 | |
| CMPG4236P1 | 731 | 761 | 42 | 36 | 2.3 | 31 | 3.38 | |
| CMPG4242P1 | 796 | 826 | 42 | 42 | 2.3 | 36 | 3.92 | |
| CMPG4248P1 | 864 | 894 | 42 | 48 | 2.3 | 41 | 4.45 | |
| CMPG4254P1 | 954 | 984 | 42 | 54 | 2.3 | 46 | 4.99 | |
| CMPG4260P1 | 1028 | 1060 | 42 | 60 | 2.3 | 51 | 5.52 | |
| CMPG4824P1 | 614 | 630 | 48 | 24 | 2.3 | 26 | 2.73 | |
| CMPG4830P1 | 737 | 752 | 48 | 30 | 2.3 | 33 | 3.37 | |
| CMPG4836P1 | 809 | 839 | 48 | 36 | 2.3 | 39 | 4.00 | |
| CMPG4842P1 | 892 | 921 | 48 | 42 | 2.3 | 46 | 4.63 | |
| CMPG4848P1 | 974 | 1004 | 48 | 48 | 2.3 | 52 | 5.26 | |
| CMPG4854P1 | 1057 | 1087 | 48 | 54 | 2.3 | 59 | 5.89 | |
| CMPG4860P1 | 1131 | 1160 | 48 | 60 | 2.3 | 65 | 6.53 | |
| CMPG5424P1 | 614 | 630 | 54 | 24 | 2.3 | 26 | 2.73 | |
| CMPG5430P1 | 737 | 752 | 54 | 30 | 2.3 | 33 | 3.37 | |
| CMPG5436P1 | 811 | 840 | 54 | 36 | 2.3 | 39 | 4.00 | |
| CMPG5442P1 | 892 | 921 | 54 | 42 | 2.3 | 46 | 4.63 | |
| CMPG5448P1 | 973 | 1003 | 54 | 48 | 2.3 | 52 | 5.26 | |
| CMPG5454P1 | 1057 | 1088 | 54 | 54 | 2.3 | 59 | 5.89 | |
| CMPG5460P1 | 1131 | 1160 | 54 | 60 | 2.3 | 65 | 6.53 | |
| CMPG6624P1 | 665 | 694 | 66 | 24 | 2.3 | 32 | 3.58 | |
| CMPG6630P1 | 794 | 825 | 66 | 30 | 2.3 | 40 | 4.40 | |
| CMPG6636P1 | 870 | 931 | 66 | 36 | 2.3 | 48 | 5.23 | |
| CMPG6642P1 | 956 | 1017 | 66 | 42 | 2.3 | 56 | 6.06 | |
| CMPG6648P1 | 1050 | 1108 | 66 | 48 | 2.3 | 64 | 6.88 | |
| CMPG6654P1 | 1137 | 1198 | 66 | 54 | 2.3 | 72 | 7.71 | |
| CMPG6660P1 | 1218 | 1278 | 66 | 60 | 2.3 | 80 | 8.53 | |

CMPG-P2 • Single 14" Glazed at Top, Powered Fabric Panel, Punchouts on Both Sides

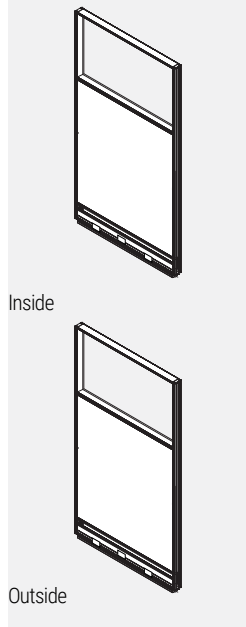

- Individual fabric-covered module in lower position with glazed module in upper position incorporated into an aluminum frame.
- Opposite sides of each module may have a different fabric within the same grade at no upcharge.
- If different grades of fabric are used on one panel, the entire panel must be priced at highest grade.
- Panels are not tackable.
- Note: Trim is not required at a straight connection between two panels of the same height.
- 3 Panel connector brackets per side come standard with 42"h. and 54"h. panels.
- 4 Panel connector brackets per side come standard with 66"h. panels.
- Panels include 2 raceway covers with punchouts on both sides, a power distribution housing, an integrated aluminum top cap and levelling glides.
- Standard in clear (CLR) plexi.
- Optional frosted (FRST) plexi
- 24" wide panels have two punchouts, one for electrical and one for data.
- 30" wide panels and wider have three punchouts, two for electrical and one for data.
- Glazing is 14" nominal from the top of the panel. panels and wider have 2 punchouts.
- Please specify duplex receptacles separately.

| PRODUCT CODE | PRICE | | SIZE/ H | INCHES | | | WEIGHT VOL | |
|--------------|-------|------|---------|--------|-----|-----|-----------------|--|
| | GR 1 | GR 2 | | W | D | LBS | FT ³ | |
| CMPG4224P2 | 582 | 600 | 42 | 24 | 2.3 | 20 | 2.31 | |
| CMPG4230P2 | 678 | 692 | 42 | 30 | 2.3 | 25 | 2.85 | |
| CMPG4236P2 | 731 | 761 | 42 | 36 | 2.3 | 31 | 3.38 | |
| CMPG4242P2 | 796 | 826 | 42 | 42 | 2.3 | 36 | 3.92 | |
| CMPG4248P2 | 864 | 894 | 42 | 48 | 2.3 | 41 | 4.45 | |
| CMPG4254P2 | 954 | 984 | 42 | 54 | 2.3 | 46 | 4.99 | |
| CMPG4260P2 | 1028 | 1060 | 42 | 60 | 2.3 | 51 | 5.52 | |
| CMPG4824P2 | 614 | 630 | 48 | 24 | 2.3 | 26 | 2.73 | |
| CMPG4830P2 | 737 | 752 | 48 | 30 | 2.3 | 33 | 3.37 | |
| CMPG4836P2 | 809 | 839 | 48 | 36 | 2.3 | 39 | 4.00 | |
| CMPG4842P2 | 892 | 921 | 48 | 42 | 2.3 | 46 | 4.63 | |
| CMPG4848P2 | 974 | 1004 | 48 | 48 | 2.3 | 52 | 5.26 | |
| CMPG4854P2 | 1057 | 1087 | 48 | 54 | 2.3 | 59 | 5.89 | |
| CMPG4860P2 | 1131 | 1160 | 48 | 60 | 2.3 | 65 | 6.53 | |
| CMPG5424P2 | 614 | 630 | 54 | 24 | 2.3 | 26 | 2.73 | |
| CMPG5430P2 | 737 | 752 | 54 | 30 | 2.3 | 33 | 3.37 | |
| CMPG5436P2 | 811 | 840 | 54 | 36 | 2.3 | 39 | 4.00 | |
| CMPG5442P2 | 892 | 921 | 54 | 42 | 2.3 | 46 | 4.63 | |
| CMPG5448P2 | 973 | 1003 | 54 | 48 | 2.3 | 52 | 5.26 | |
| CMPG5454P2 | 1057 | 1088 | 54 | 54 | 2.3 | 59 | 5.89 | |
| CMPG5460P2 | 1131 | 1160 | 54 | 60 | 2.3 | 65 | 6.53 | |
| CMPG6624P2 | 665 | 694 | 66 | 24 | 2.3 | 32 | 3.58 | |
| CMPG6630P2 | 794 | 825 | 66 | 30 | 2.3 | 40 | 4.40 | |
| CMPG6636P2 | 870 | 931 | 66 | 36 | 2.3 | 48 | 5.23 | |
| CMPG6642P2 | 956 | 1017 | 66 | 42 | 2.3 | 56 | 6.06 | |
| CMPG6648P2 | 1050 | 1108 | 66 | 48 | 2.3 | 64 | 6.88 | |
| CMPG6654P2 | 1137 | 1198 | 66 | 54 | 2.3 | 72 | 7.71 | |
| CMPG6660P2 | 1218 | 1278 | 66 | 60 | 2.3 | 80 | 8.53 | |

CMFO-N0 • Single Segmented Open Bottom Non Powered Fabric Panel, No Punchouts

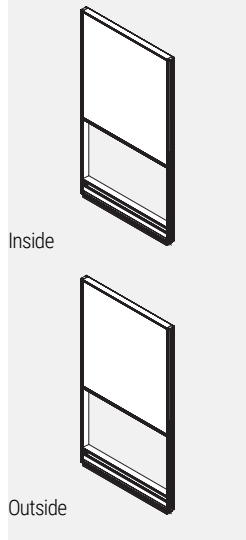

- Individual fabric-covered module in upper position incorporated into an aluminum frame.
- Bottom is open.
- Opposite sides of each module may have a different fabric within the same grade at no upcharge.
- If different grades of fabric are used on one panel, the entire panel must be priced at highest grade.
- Panels are not tackable.
- Note: Trim is not required at a straight connection between two panels of the same height.
- 3 Panel connector brackets per side come standard with 42”h. and 54”h. panels.
- 4 Panel connector brackets per side come standard with 66”h. panels.
- Panels include 2 raceway covers with no punchouts, an integrated aluminum top cap and levelling glides.
- PVC trim kit available in black only.

| PRODUCT CODE | PRICE | | SIZE/ H | INCHES | | | WEIGHT VOL | |
|--------------|-------|------|---------|--------|-----|-----|-----------------|--|
| | GR 1 | GR 2 | | W | D | LBS | FT ³ | |
| CMFO4224N0 | 271 | 281 | 42 | 24 | 2.3 | 15 | 2.31 | |
| CMFO4230N0 | 339 | 349 | 42 | 30 | 2.3 | 17 | 2.85 | |
| CMFO4236N0 | 365 | 383 | 42 | 36 | 2.3 | 21 | 3.38 | |
| CMFO4242N0 | 418 | 438 | 42 | 42 | 2.3 | 24 | 3.92 | |
| CMFO4248N0 | 446 | 464 | 42 | 48 | 2.3 | 28 | 4.45 | |
| CMFO4254N0 | 486 | 513 | 42 | 54 | 2.3 | 31 | 4.99 | |
| CMFO4260N0 | 536 | 552 | 42 | 60 | 2.3 | 34 | 5.52 | |
| CMFO5424N0 | 319 | 336 | 54 | 24 | 2.3 | 20 | 2.73 | |
| CMFO5430N0 | 365 | 378 | 54 | 30 | 2.3 | 25 | 3.37 | |
| CMFO5436N0 | 415 | 431 | 54 | 36 | 2.3 | 29 | 4.00 | |
| CMFO5442N0 | 476 | 507 | 54 | 42 | 2.3 | 34 | 4.63 | |
| CMFO5448N0 | 508 | 539 | 54 | 48 | 2.3 | 38 | 5.26 | |
| CMFO5454N0 | 553 | 584 | 54 | 54 | 2.3 | 43 | 5.89 | |
| CMFO5460N0 | 589 | 619 | 54 | 60 | 2.3 | 48 | 6.53 | |
| CMFO6624N0 | 352 | 377 | 66 | 24 | 2.3 | 25 | 3.58 | |
| CMFO6630N0 | 394 | 418 | 66 | 30 | 2.3 | 31 | 4.40 | |
| CMFO6636N0 | 473 | 516 | 66 | 36 | 2.3 | 38 | 5.23 | |
| CMFO6642N0 | 536 | 578 | 66 | 42 | 2.3 | 44 | 6.06 | |
| CMFO6648N0 | 561 | 604 | 66 | 48 | 2.3 | 50 | 6.88 | |
| CMFO6654N0 | 612 | 656 | 66 | 54 | 2.3 | 56 | 7.71 | |
| CMFO6660N0 | 654 | 695 | 66 | 60 | 2.3 | 63 | 8.53 | |

CMFO-N1 • Single Segmented Open Bottom Non Powered Fabric Panel, Punchouts on One Side

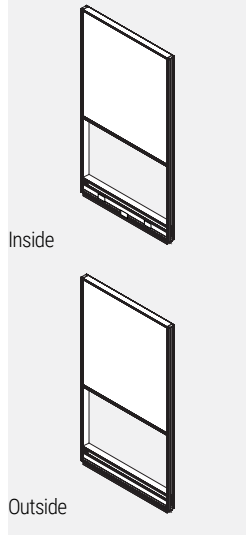

- Individual fabric-covered module in upper position incorporated into an aluminum frame.
- Bottom is open.
- Opposite sides of each module may have a different fabric within the same grade at no upcharge.
- If different grades of fabric are used on one panel, the entire panel must be priced at highest grade.
- Panels are not tackable.
- Note: Trim is not required at a straight connection between two panels of the same height.
- 3 Panel connector brackets per side come standard with 42”h. and 54”h. panels.
- 4 Panel connector brackets per side come standard with 66”h. panels.
- Panels include 1 raceway cover with punchouts on one side, 1 raceway cover with no punchouts on the other, an integrated aluminum top cap and levelling glides.
- 24” wide panels have two punchouts, one for electrical and one for data.
- 30” wide panels and wider have three punchouts, two for electrical and one for data.
- PVC trim kit available in black only.

| PRODUCT CODE | PRICE | | SIZE/ H | INCHES | | | WEIGHT VOL | |
|--------------|-------|------|---------|--------|-----|-----|-----------------|--|
| | GR 1 | GR 2 | | W | D | LBS | FT ³ | |
| CMFO4224N1 | 271 | 281 | 42 | 24 | 2.3 | 15 | 2.31 | |
| CMFO4230N1 | 339 | 349 | 42 | 30 | 2.3 | 17 | 2.85 | |
| CMFO4236N1 | 365 | 383 | 42 | 36 | 2.3 | 21 | 3.38 | |
| CMFO4242N1 | 418 | 438 | 42 | 42 | 2.3 | 24 | 3.92 | |
| CMFO4248N1 | 446 | 464 | 42 | 48 | 2.3 | 28 | 4.45 | |
| CMFO4254N1 | 486 | 513 | 42 | 54 | 2.3 | 31 | 4.99 | |
| CMFO4260N1 | 536 | 552 | 42 | 60 | 2.3 | 34 | 5.52 | |
| CMFO5424N1 | 319 | 336 | 54 | 24 | 2.3 | 20 | 2.73 | |
| CMFO5430N1 | 365 | 378 | 54 | 30 | 2.3 | 25 | 3.37 | |
| CMFO5436N1 | 415 | 431 | 54 | 36 | 2.3 | 29 | 4.00 | |
| CMFO5442N1 | 476 | 507 | 54 | 42 | 2.3 | 34 | 4.63 | |
| CMFO5448N1 | 508 | 539 | 54 | 48 | 2.3 | 38 | 5.26 | |
| CMFO5454N1 | 553 | 584 | 54 | 54 | 2.3 | 43 | 5.89 | |
| CMFO5460N1 | 589 | 619 | 54 | 60 | 2.3 | 48 | 6.53 | |
| CMFO6624N1 | 352 | 377 | 66 | 24 | 2.3 | 25 | 3.58 | |
| CMFO6630N1 | 394 | 418 | 66 | 30 | 2.3 | 31 | 4.40 | |
| CMFO6636N1 | 473 | 516 | 66 | 36 | 2.3 | 38 | 5.23 | |
| CMFO6642N1 | 536 | 578 | 66 | 42 | 2.3 | 44 | 6.06 | |
| CMFO6648N1 | 561 | 604 | 66 | 48 | 2.3 | 50 | 6.88 | |
| CMFO6654N1 | 612 | 656 | 66 | 54 | 2.3 | 56 | 7.71 | |
| CMFO6660N1 | 654 | 695 | 66 | 60 | 2.3 | 63 | 8.53 | |

CMFO-N2 • Single Segmented Open Bottom Non Powered Fabric Panel, Punchouts on Both Sides

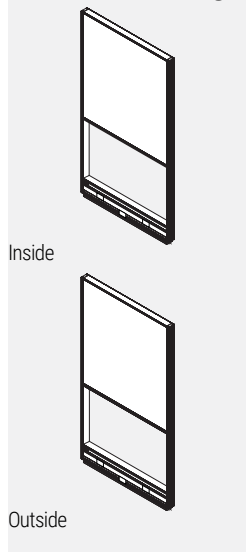

- Individual fabric-covered module in upper position incorporated into an aluminum frame.
- Bottom is open.
- Opposite sides of each module may have a different fabric within the same grade at no upcharge.
- If different grades of fabric are used on one panel, the entire panel must be priced at highest grade.
- Panels are not tackable.
- Note: Trim is not required at a straight connection between two panels of the same height.
- 3 Panel connector brackets per side come standard with 42”h. and 54”h. panels.
- 4 Panel connector brackets per side come standard with 66”h. panels.
- Panels include 2 raceway covers with punchouts on both sides, an integrated aluminum top cap and levelling glides.
- 24” wide panels have two punchouts, one for electrical and one for data.
- 30” wide panels and wider have three punchouts, two for electrical and one for data.
- PVC trim kit available in black only.

| PRODUCT CODE | PRICE | | SIZE/ INCHES | | | WEIGHT VOL | |
|--------------|-------|------|--------------|----|-----|------------|------|
| | GR 1 | GR 2 | H | W | D | LBS | FT³ |
| CMFO4224N2 | 271 | 281 | 42 | 24 | 2.3 | 15 | 2.31 |
| CMFO4230N2 | 339 | 349 | 42 | 30 | 2.3 | 17 | 2.85 |
| CMFO4236N2 | 365 | 383 | 42 | 36 | 2.3 | 21 | 3.38 |
| CMFO4242N2 | 418 | 438 | 42 | 42 | 2.3 | 24 | 3.92 |
| CMFO4248N2 | 446 | 464 | 42 | 48 | 2.3 | 28 | 4.45 |
| CMFO4254N2 | 486 | 513 | 42 | 54 | 2.3 | 31 | 4.99 |
| CMFO4260N2 | 536 | 552 | 42 | 60 | 2.3 | 34 | 5.52 |
| CMFO5424N2 | 319 | 336 | 54 | 24 | 2.3 | 20 | 2.73 |
| CMFO5430N2 | 365 | 378 | 54 | 30 | 2.3 | 25 | 3.37 |
| CMFO5436N2 | 415 | 431 | 54 | 36 | 2.3 | 29 | 4.00 |
| CMFO5442N2 | 476 | 507 | 54 | 42 | 2.3 | 34 | 4.63 |
| CMFO5448N2 | 508 | 539 | 54 | 48 | 2.3 | 38 | 5.26 |
| CMFO5454N2 | 553 | 584 | 54 | 54 | 2.3 | 43 | 5.89 |
| CMFO5460N2 | 589 | 619 | 54 | 60 | 2.3 | 48 | 6.53 |
| CMFO6624N2 | 352 | 377 | 66 | 24 | 2.3 | 25 | 3.58 |
| CMFO6630N2 | 394 | 418 | 66 | 30 | 2.3 | 31 | 4.40 |
| CMFO6636N2 | 473 | 516 | 66 | 36 | 2.3 | 38 | 5.23 |
| CMFO6642N2 | 536 | 578 | 66 | 42 | 2.3 | 44 | 6.06 |
| CMFO6648N2 | 561 | 604 | 66 | 48 | 2.3 | 50 | 6.88 |
| CMFO6654N2 | 612 | 656 | 66 | 54 | 2.3 | 56 | 7.71 |
| CMFO6660N2 | 654 | 695 | 66 | 60 | 2.3 | 63 | 8.53 |

CMFO-P1 • Single Segmented Open Bottom Powered Fabric Panel, Punchouts on One Side

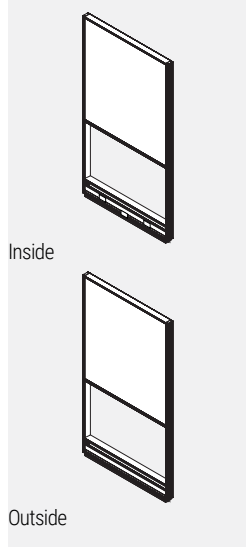

- Individual fabric-covered module in upper position incorporated into an aluminum frame.
- Bottom is open.
- Opposite sides of each module may have a different fabric within the same grade at no upcharge.
- If different grades of fabric are used on one panel, the entire panel must be priced at highest grade.
- Panels are not tackable.
- Note: Trim is not required at a straight connection between two panels of the same height.
- 3 Panel connector brackets per side come standard with 42”h. and 54”h. panels.
- 4 Panel connector brackets per side come standard with 66”h. panels.
- Panels include 1 raceway cover with punchouts on one side, 1 raceway cover with no punchouts on the other, a power distribution housing, an integrated aluminum top cap and levelling glides.
- 24” wide panels have two punchouts, one for electrical and one for data.
- 30” wide panels and wider have three punchouts, two for electrical and one for data.
- Please specify duplex receptacles separately.
- PVC trim kit available in black only.

| PRODUCT CODE | PRICE | | SIZE/ INCHES | | | WEIGHT VOL | |
|--------------|-------|------|--------------|----|-----|------------|------|
| | GR 1 | GR 2 | H | W | D | LBS | FT³ |
| CMFO4224P1 | 401 | 411 | 42 | 24 | 2.3 | 15 | 2.31 |
| CMFO4230P1 | 512 | 521 | 42 | 30 | 2.3 | 17 | 2.85 |
| CMFO4236P1 | 546 | 567 | 42 | 36 | 2.3 | 21 | 3.38 |
| CMFO4242P1 | 605 | 625 | 42 | 42 | 2.3 | 24 | 3.92 |
| CMFO4248P1 | 644 | 661 | 42 | 48 | 2.3 | 28 | 4.45 |
| CMFO4254P1 | 689 | 698 | 42 | 54 | 2.3 | 31 | 4.99 |
| CMFO4260P1 | 737 | 757 | 42 | 60 | 2.3 | 34 | 5.52 |
| CMFO5424P1 | 449 | 462 | 54 | 24 | 2.3 | 20 | 2.73 |
| CMFO5430P1 | 540 | 552 | 54 | 30 | 2.3 | 25 | 3.37 |
| CMFO5436P1 | 595 | 610 | 54 | 36 | 2.3 | 29 | 4.00 |
| CMFO5442P1 | 661 | 693 | 54 | 42 | 2.3 | 34 | 4.63 |
| CMFO5448P1 | 707 | 736 | 54 | 48 | 2.3 | 38 | 5.26 |
| CMFO5454P1 | 757 | 786 | 54 | 54 | 2.3 | 43 | 5.89 |
| CMFO5460P1 | 791 | 823 | 54 | 60 | 2.3 | 48 | 6.53 |
| CMFO6624P1 | 482 | 507 | 66 | 24 | 2.3 | 25 | 3.58 |
| CMFO6630P1 | 568 | 591 | 66 | 30 | 2.3 | 31 | 4.40 |
| CMFO6636P1 | 654 | 695 | 66 | 36 | 2.3 | 38 | 5.23 |
| CMFO6642P1 | 722 | 765 | 66 | 42 | 2.3 | 44 | 6.06 |
| CMFO6648P1 | 758 | 802 | 66 | 48 | 2.3 | 50 | 6.88 |
| CMFO6654P1 | 814 | 857 | 66 | 54 | 2.3 | 56 | 7.71 |
| CMFO6660P1 | 856 | 898 | 66 | 60 | 2.3 | 63 | 8.53 |

CMFO-P2 • Single Segmented Open Bottom Powered Fabric Panel, Punchouts on Both Sides

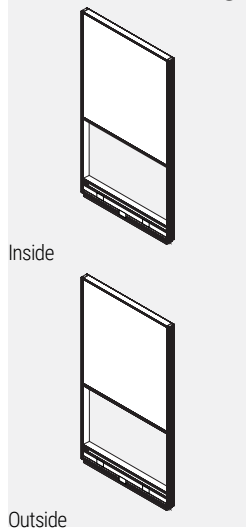

- Individual fabric-covered module in upper position incorporated into an aluminum frame.
- Bottom is open.
- Opposite sides of each module may have a different fabric within the same grade at no upcharge.
- If different grades of fabric are used on one panel, the entire panel must be priced at highest grade.
- Panels are not tackable.
- Note: Trim is not required at a straight connection between two panels of the same height.
- 3 Panel connector brackets per side come standard with 42”h. and 54”h. panels.
- 4 Panel connector brackets per side come standard with 66”h. panels.
- Panels include 2 raceway covers with punchouts on both sides, a power distribution housing, an integrated aluminum top cap and levelling glides.
- 24” wide panels have two punchouts, one for electrical and one for data.
- 30” wide panels and wider have three punchouts, two for electrical and one for data.
- Please specify duplex receptacles separately.
- PVC trim kit available in black only.

| PRODUCT CODE | PRICE | | SIZE/ INCHES | | | WEIGHT VOL | |
|--------------|-------|------|--------------|----|-----|------------|-----------------|
| | GR 1 | GR 2 | H | W | D | LBS | FT ³ |
| CMFO4224P2 | 401 | 411 | 42 | 24 | 2.3 | 15 | 2.31 |
| CMFO4230P2 | 512 | 521 | 42 | 30 | 2.3 | 17 | 2.85 |
| CMFO4236P2 | 546 | 567 | 42 | 36 | 2.3 | 21 | 3.38 |
| CMFO4242P2 | 605 | 625 | 42 | 42 | 2.3 | 24 | 3.92 |
| CMFO4248P2 | 644 | 661 | 42 | 48 | 2.3 | 28 | 4.45 |
| CMFO4254P2 | 689 | 698 | 42 | 54 | 2.3 | 31 | 4.99 |
| CMFO4260P2 | 737 | 757 | 42 | 60 | 2.3 | 34 | 5.52 |
| CMFO5424P2 | 449 | 462 | 54 | 24 | 2.3 | 20 | 2.73 |
| CMFO5430P2 | 540 | 552 | 54 | 30 | 2.3 | 25 | 3.37 |
| CMFO5436P2 | 595 | 610 | 54 | 36 | 2.3 | 29 | 4.00 |
| CMFO5442P2 | 661 | 693 | 54 | 42 | 2.3 | 34 | 4.63 |
| CMFO5448P2 | 707 | 736 | 54 | 48 | 2.3 | 38 | 5.26 |
| CMFO5454P2 | 757 | 786 | 54 | 54 | 2.3 | 43 | 5.89 |
| CMFO5460P2 | 791 | 823 | 54 | 60 | 2.3 | 48 | 6.53 |
| CMFO6624P2 | 482 | 507 | 66 | 24 | 2.3 | 25 | 3.58 |
| CMFO6630P2 | 568 | 591 | 66 | 30 | 2.3 | 31 | 4.40 |
| CMFO6636P2 | 654 | 695 | 66 | 36 | 2.3 | 38 | 5.23 |
| CMFO6642P2 | 722 | 765 | 66 | 42 | 2.3 | 44 | 6.06 |
| CMFO6648P2 | 758 | 802 | 66 | 48 | 2.3 | 50 | 6.88 |
| CMFO6654P2 | 814 | 857 | 66 | 54 | 2.3 | 56 | 7.71 |
| CMFO6660P2 | 856 | 898 | 66 | 60 | 2.3 | 63 | 8.53 |

CMOF • Compile Fabric Over Panel

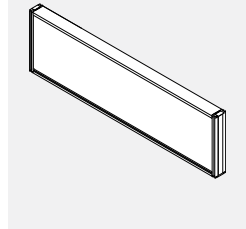

- Individual fabric-covered modules incorporated into an aluminum frame.
- Opposite sides of each module may have a different fabric within the same grade at no upcharge.
- If different grades of fabric are used on one panel, the entire panel must be priced at highest grade.
- Panels are not tackable.
- 2 Panel connector brackets per side are standard
- CHSD Compile Slider Kit for Over Panel required for installation and is included with each over panel.
- Note: Trim is not required at a straight connection between two panels of the same height.
- **Note: All over panels are non load bearing.**

| PRODUCT CODE | PRICE | | SIZE/ INCHES | | | WEIGHT VOL | |
|--------------|-------|------|--------------|----|-----|------------|-----------------|
| | GR 1 | GR 2 | H | W | D | LBS | FT ³ |
| CMOF1224 | 134 | 156 | 12 | 24 | 2.3 | 8 | 0.38 |
| CMOF1230 | 158 | 178 | 12 | 30 | 2.3 | 10 | 0.48 |
| CMOF1236 | 174 | 196 | 12 | 36 | 2.3 | 12.4 | 0.58 |
| CMOF1242 | 199 | 218 | 12 | 42 | 2.3 | 14.4 | 0.67 |
| CMOF1248 | 231 | 249 | 12 | 48 | 2.3 | 16.4 | 0.7 |
| CMOF1254 | 238 | 260 | 12 | 54 | 2.3 | 18.4 | 0.86 |
| CMOF1260 | 283 | 304 | 12 | 60 | 2.3 | 20.4 | 0.96 |
| CMOF1624 | 157 | 180 | 16 | 30 | 2.3 | 15 | 0.64 |
| CMOF1630 | 182 | 208 | 16 | 36 | 2.3 | 18.6 | 0.77 |
| CMOF1636 | 194 | 217 | 16 | 42 | 2.3 | 21.6 | 0.89 |
| CMOF1642 | 233 | 255 | 16 | 48 | 2.3 | 24.6 | 1.02 |
| CMOF1648 | 264 | 287 | 16 | 54 | 2.3 | 27.6 | 1.15 |
| CMOF1654 | 276 | 302 | 16 | 60 | 2.3 | 30.6 | 1.28 |
| CMOF1660 | 324 | 349 | 16 | 66 | 2.3 | 33.6 | 1.42 |
| CMOF2424 | 202 | 240 | 24 | 24 | 2.3 | 16 | 0.77 |
| CMOF2430 | 235 | 268 | 24 | 30 | 2.3 | 20 | 0.96 |
| CMOF2436 | 263 | 298 | 24 | 36 | 2.3 | 24.8 | 1.15 |
| CMOF2442 | 297 | 330 | 24 | 42 | 2.3 | 28.8 | 1.34 |
| CMOF2448 | 317 | 351 | 24 | 48 | 2.3 | 32.8 | 1.53 |
| CMOF2454 | 352 | 386 | 24 | 54 | 2.3 | 36.8 | 1.73 |
| CMOF2460 | 406 | 439 | 24 | 60 | 2.3 | 40.8 | 1.92 |

CMOLF • Compile Laminate One Side, Fabric One Side Over Panel

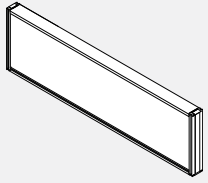

- Individual modules, one side in fabric and one side in laminate, incorporated into an aluminum frame.
- Panels are not tackable.
- 2 Panel connector brackets per side are standard
- CHSD Compile Slider Kit for Over Panel required for installation and is included with each over panel.
- Note: Trim is not required at a straight connection between two panels of the same height.
- **Note: All over panels are non load bearing.**

| PRODUCT CODE | PRICE | | SIZE/ INCHES | | | WEIGHT VOL | |
|--------------|-------|------|--------------|----|-----|------------|-----------------|
| | GR 1 | GR 2 | H | W | D | LBS | FT ³ |
| CMOLF1224 | 151 | 161 | 12 | 24 | 2.3 | 8 | 0.38 |
| CMOLF1230 | 178 | 187 | 12 | 30 | 2.3 | 10 | 0.48 |
| CMOLF1236 | 201 | 211 | 12 | 36 | 2.3 | 12.4 | 0.58 |
| CMOLF1242 | 229 | 238 | 12 | 42 | 2.3 | 14.4 | 0.67 |
| CMOLF1248 | 264 | 274 | 12 | 48 | 2.3 | 16.4 | 0.7 |
| CMOLF1254 | 276 | 285 | 12 | 54 | 2.3 | 18.4 | 0.86 |
| CMOLF1260 | 327 | 336 | 12 | 60 | 2.3 | 20.4 | 0.96 |
| CMOLF1624 | 179 | 193 | 16 | 30 | 2.3 | 15 | 0.64 |
| CMOLF1630 | 215 | 229 | 16 | 36 | 2.3 | 18.6 | 0.77 |
| CMOLF1636 | 238 | 249 | 16 | 42 | 2.3 | 21.6 | 0.89 |
| CMOLF1642 | 271 | 283 | 16 | 48 | 2.3 | 24.6 | 1.02 |
| CMOLF1648 | 309 | 320 | 16 | 54 | 2.3 | 27.6 | 1.15 |
| CMOLF1654 | 328 | 340 | 16 | 60 | 2.3 | 30.6 | 1.28 |
| CMOLF1660 | 380 | 392 | 16 | 66 | 2.3 | 33.6 | 1.41 |
| CMOLF2424 | 237 | 252 | 24 | 24 | 2.3 | 16 | 0.77 |
| CMOLF2430 | 283 | 301 | 24 | 30 | 2.3 | 20 | 0.96 |
| CMOLF2436 | 313 | 330 | 24 | 36 | 2.3 | 24.8 | 1.15 |
| CMOLF2442 | 353 | 371 | 24 | 42 | 2.3 | 28.8 | 1.34 |
| CMOLF2448 | 385 | 404 | 24 | 48 | 2.3 | 32.8 | 1.53 |
| CMOLF2454 | 430 | 444 | 24 | 54 | 2.3 | 36.8 | 1.73 |
| CMOLF2460 | 488 | 507 | 24 | 60 | 2.3 | 40.8 | 1.92 |

CMOLL • Compile Laminate Two Sides Over Panel

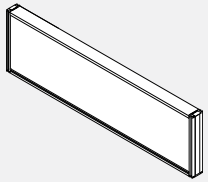

- Individual laminate modules incorporated into an aluminum frame.
- Panels are not tackable.
- 2 Panel connector brackets per side are standard
- CHSD Compile Slider Kit for Over Panel required for installation and is included with each over panel.
- Note: Trim is not required at a straight connection between two panels of the same height.
- **Note: All over panels are non load bearing.**

| PRODUCT CODE | PRICE | | SIZE/ INCHES | | | WEIGHT VOL | |
|--------------|-------|------|--------------|----|-----|------------|-----------------|
| | GR 1 | GR 2 | H | W | D | LBS | FT ³ |
| CMOLL1224 | 168 | | 12 | 24 | 2.3 | 8 | 0.38 |
| CMOLL1230 | 192 | | 12 | 30 | 2.3 | 10 | 0.48 |
| CMOLL1236 | 225 | | 12 | 36 | 2.3 | 12.4 | 0.58 |
| CMOLL1242 | 255 | | 12 | 42 | 2.3 | 14.4 | 0.67 |
| CMOLL1248 | 295 | | 12 | 48 | 2.3 | 16.4 | 0.7 |
| CMOLL1254 | 312 | | 12 | 54 | 2.3 | 18.4 | 0.86 |
| CMOLL1260 | 365 | | 12 | 60 | 2.3 | 20.4 | 0.96 |
| CMOLL1624 | 200 | | 16 | 24 | 2.3 | 12 | 0.51 |
| CMOLL1630 | 237 | | 16 | 30 | 2.3 | 15 | 0.64 |
| CMOLL1636 | 270 | | 16 | 36 | 2.3 | 18.6 | 0.77 |
| CMOLL1642 | 306 | | 16 | 42 | 2.3 | 21.6 | 0.89 |
| CMOLL1648 | 350 | | 16 | 48 | 2.3 | 24.6 | 1.02 |
| CMOLL1654 | 373 | | 16 | 54 | 2.3 | 27.6 | 1.15 |
| CMOLL1660 | 433 | | 16 | 60 | 2.3 | 30.6 | 1.28 |
| CMOLL2424 | 268 | | 24 | 24 | 2.3 | 16 | 0.77 |
| CMOLL2430 | 316 | | 24 | 30 | 2.3 | 20 | 0.96 |
| CMOLL2436 | 361 | | 24 | 36 | 2.3 | 24.8 | 1.15 |
| CMOLL2442 | 408 | | 24 | 42 | 2.3 | 28.8 | 1.34 |
| CMOLL2448 | 448 | | 24 | 48 | 2.3 | 32.8 | 1.53 |
| CMOLL2454 | 499 | | 24 | 54 | 2.3 | 36.8 | 1.73 |
| CMOLL2460 | 568 | | 24 | 60 | 2.3 | 40.8 | 1.92 |

CMOG • Compile Glazed Over Panel

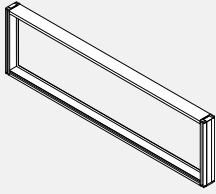

- Individual glazed module incorporated into an aluminum frame.
- Standard in clear (CLR) plexi.
- Optional frosted (FRST) plexi.
- Panels are not tackable.
- 2 Panel connector brackets per side are standard
- The PVC trim for glass can be different finish than the frame of the over panels, please specify two finishes.
- CHSD Compile Slider Kit for Over Panel required for installation and is included with each over panel.
- Note: Trim is not required at a straight connection between two panels of the same height.
- **Note: All over panels are non load bearing.**

| PRODUCT CODE | PRICE | SIZE/ INCHES | | | WEIGHT VOL | |
|--------------|-------|--------------|----|-----|------------|-----------------|
| | | H | W | D | LBS | FT ³ |
| CMOG1224 | 122 | 12 | 24 | 2.3 | 8 | 0.38 |
| CMOG1230 | 139 | 12 | 30 | 2.3 | 10 | 0.48 |
| CMOG1236 | 156 | 12 | 36 | 2.3 | 12.4 | 0.58 |
| CMOG1242 | 174 | 12 | 42 | 2.3 | 14.4 | 0.67 |
| CMOG1248 | 201 | 12 | 48 | 2.3 | 16.4 | 0.7 |
| CMOG1254 | 210 | 12 | 54 | 2.3 | 18.4 | 0.86 |
| CMOG1260 | 248 | 12 | 60 | 2.3 | 20.4 | 0.96 |
| CMOG1624 | 139 | 16 | 24 | 2.3 | 12 | 0.51 |
| CMOG1630 | 161 | 16 | 30 | 2.3 | 15 | 0.64 |
| CMOG1636 | 179 | 16 | 36 | 2.3 | 18.6 | 0.77 |
| CMOG1642 | 202 | 16 | 42 | 2.3 | 21.6 | 0.89 |
| CMOG1648 | 233 | 16 | 48 | 2.3 | 24.6 | 1.02 |
| CMOG1654 | 239 | 16 | 54 | 2.3 | 27.6 | 1.15 |
| CMOG1660 | 283 | 16 | 60 | 2.3 | 30.6 | 1.28 |
| CMOG2424 | 178 | 24 | 24 | 2.3 | 16 | 0.77 |
| CMOG2430 | 194 | 24 | 30 | 2.3 | 20 | 0.96 |
| CMOG2436 | 227 | 24 | 36 | 2.3 | 24.8 | 1.15 |
| CMOG2442 | 253 | 24 | 42 | 2.3 | 28.8 | 1.34 |
| CMOG2448 | 273 | 24 | 48 | 2.3 | 32.8 | 1.53 |
| CMOG2454 | 303 | 24 | 54 | 2.3 | 36.8 | 1.73 |
| CMOG2460 | 350 | 24 | 60 | 2.3 | 40.8 | 1.92 |

CMOFW • Compile One Side Write Board Over Panel

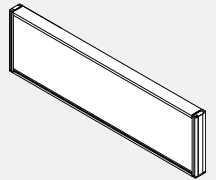

- Individual fabric or write board covered modules incorporated into an aluminum frame.
- Modules have write board on one side and fabric on the other.
- Panels are not tackable.
- 2 Panel connector brackets per side are standard
- CHSD Compile Slider Kit for Over Panel required for installation and is included with each over panel.
- Note: Trim is not required at a straight connection between two panels of the same height.
- **Note: All over panels are non load bearing.**

| PRODUCT CODE | PRICE | | SIZE/ INCHES | | | WEIGHT VOL | |
|--------------|-------|------|--------------|----|-----|------------|-----------------|
| | GR 1 | GR 2 | H | W | D | LBS | FT ³ |
| CMOFW1224 | 170 | 179 | 12 | 24 | 2.3 | 8 | 0.38 |
| CMOFW1230 | 201 | 211 | 12 | 30 | 2.3 | 10 | 0.48 |
| CMOFW1236 | 229 | 238 | 12 | 36 | 2.3 | 12.4 | 0.58 |
| CMOFW1242 | 262 | 271 | 12 | 42 | 2.3 | 14.4 | 0.67 |
| CMOFW1248 | 287 | 299 | 12 | 48 | 2.3 | 16.4 | 0.7 |
| CMOFW1254 | 318 | 329 | 12 | 54 | 2.3 | 18.4 | 0.86 |
| CMOFW1260 | 371 | 380 | 12 | 60 | 2.3 | 20.4 | 0.96 |
| CMOFW1624 | 204 | 215 | 16 | 24 | 2.3 | 12 | 0.51 |
| CMOFW1630 | 241 | 253 | 16 | 30 | 2.3 | 15 | 0.64 |
| CMOFW1636 | 276 | 287 | 16 | 36 | 2.3 | 18.6 | 0.77 |
| CMOFW1642 | 313 | 327 | 16 | 42 | 2.3 | 21.6 | 0.89 |
| CMOFW1648 | 357 | 371 | 16 | 48 | 2.3 | 24.6 | 1.02 |
| CMOFW1654 | 383 | 396 | 16 | 54 | 2.3 | 27.6 | 1.15 |
| CMOFW1660 | 442 | 454 | 16 | 60 | 2.3 | 30.6 | 1.28 |
| CMOFW2424 | 265 | 281 | 24 | 24 | 2.3 | 16 | 0.77 |
| CMOFW2430 | 305 | 320 | 24 | 30 | 2.3 | 20 | 0.96 |
| CMOFW2436 | 373 | 389 | 24 | 36 | 2.3 | 24.8 | 1.15 |
| CMOFW2442 | 418 | 435 | 24 | 42 | 2.3 | 28.8 | 1.34 |
| CMOFW2448 | 441 | 456 | 24 | 48 | 2.3 | 32.8 | 1.53 |
| CMOFW2454 | 525 | 543 | 24 | 54 | 2.3 | 36.8 | 1.73 |
| CMOFW2460 | 584 | 602 | 24 | 60 | 2.3 | 40.8 | 1.92 |

CMOWW• Compile Write Board Two Sides Over Panel

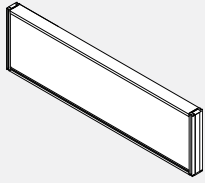

- Individual write board covered modules incorporated into an aluminum frame.
- Modules have write board on both sides.
- Panels are not tackable.
- 2 Panel connector brackets per side are standard
- CHSD Compile Slider Kit for Over Panel required for installation and is included with each over panel.
- Note: Trim is not required at a straight connection between two panels of the same height.
- **Note: All over panels are non load bearing.**

| PRODUCT CODE | PRICE | SIZE/ INCHES | | | WEIGHT VOL | |
|--------------|-------|--------------|----|-----|------------|-----------------|
| | | H | W | D | LBS | FT ³ |
| CMOWW1224 | 207 | 12 | 24 | 2.3 | 8 | 0.38 |
| CMOWW1230 | 239 | 12 | 30 | 2.3 | 10 | 0.48 |
| CMOWW1236 | 284 | 12 | 36 | 2.3 | 12.4 | 0.58 |
| CMOWW1242 | 318 | 12 | 42 | 2.3 | 14.4 | 0.67 |
| CMOWW1248 | 373 | 12 | 48 | 2.3 | 16.4 | 0.7 |
| CMOWW1254 | 394 | 12 | 54 | 2.3 | 18.4 | 0.86 |
| CMOWW1260 | 455 | 12 | 60 | 2.3 | 20.4 | 0.96 |
| CMOWW1624 | 252 | 16 | 24 | 2.3 | 12 | 0.51 |
| CMOWW1630 | 304 | 16 | 30 | 2.3 | 15 | 0.64 |
| CMOWW1636 | 349 | 16 | 36 | 2.3 | 18.6 | 0.77 |
| CMOWW1642 | 399 | 16 | 42 | 2.3 | 21.6 | 0.89 |
| CMOWW1648 | 456 | 16 | 48 | 2.3 | 24.6 | 1.02 |
| CMOWW1654 | 494 | 16 | 54 | 2.3 | 27.6 | 1.15 |
| CMOWW1660 | 565 | 16 | 60 | 2.3 | 30.6 | 1.28 |
| CMOWW2424 | 347 | 24 | 24 | 2.3 | 16 | 0.77 |
| CMOWW2430 | 416 | 24 | 30 | 2.3 | 20 | 0.96 |
| CMOWW2436 | 480 | 24 | 36 | 2.3 | 24.8 | 1.15 |
| CMOWW2442 | 548 | 24 | 42 | 2.3 | 28.8 | 1.34 |
| CMOWW2448 | 608 | 24 | 48 | 2.3 | 32.8 | 1.53 |
| CMOWW2454 | 679 | 24 | 54 | 2.3 | 36.8 | 1.73 |
| CMOWW2460 | 766 | 24 | 60 | 2.3 | 40.8 | 1.92 |

BPDSL • Sliding Door

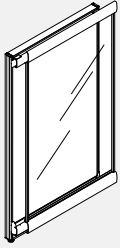

- Provides territorial privacy in an open plan environment.
- Lightweight, panel mounted sliding partition.
- Consists of translucent polycarbonate.
- Must be mounted to a straight panel of the same size.
- The face of the Privacy Screen sits 3" away from the face of the panel to which it is attached.
- When open, the screen may interfere with access doors that open on the outside of an adjacent panel.
- Caps located on the end of the frame default to the panel frame colour.
- Four sliders included for each door.
- Can be mounted on panels of the same width.
- Note: Specify left or right for the direction in which the door will slide as per examples above.

| PRODUCT CODE | PRICE | SIZE/ INCHES | | | WEIGHT VOL | |
|--------------|-------|--------------|----|------|------------|-----------------|
| | | H | W | D | LBS | FT ³ |
| BPDSL6636R | 1981 | 66 | 36 | 2.61 | 35 | 5.98 |
| BPDSL6642R | 2132 | 66 | 42 | 2.61 | 42 | 6.93 |
| BPDSL6636L | 1981 | 66 | 36 | 2.61 | 35 | 5.98 |
| BPDSL6642L | 2132 | 66 | 42 | 2.61 | 42 | 6.93 |

Left Hang Option

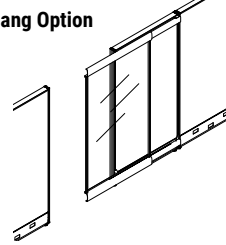

Right Hang Hung

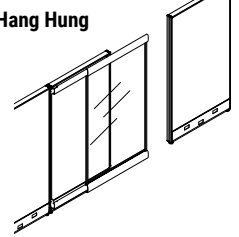

CMPS • Privacy Glass

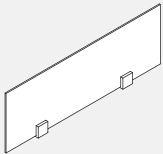

- Privacy Glass with no frame sits on top of a Panel with clamps that are secured to the top of the panel to provide division.
- Tempered glass is 12", 9" or 6" high (nominal).
- Custom sizes available, contact your Customer Service Representative.
- Square clamps included.

| PRODUCT CODE | PRICE | | SIZE/ INCHES | | | WEIGHT VOL | |
|--------------|-------|------|--------------|----|-----|------------|-----------------|
| | CLR | FRST | H | W | D | LBS | FT ³ |
| 12" | | | | | | | |
| CMPS24 | 200 | 227 | 12 | 24 | 1.3 | 8 | 0.44 |
| CMPS30 | 219 | 249 | 12 | 30 | 1.3 | 10 | 0.59 |
| CMPS36 | 235 | 271 | 12 | 36 | 1.3 | 12 | 0.73 |
| CMPS42 | 249 | 293 | 12 | 42 | 1.3 | 14 | 0.88 |
| CMPS48 | 259 | 306 | 12 | 48 | 1.3 | 16 | 0.96 |
| CMPS54 | 259 | 306 | 12 | 54 | 1.3 | 18 | 1.13 |
| CMPS60 | 299 | 339 | 12 | 60 | 1.3 | 20 | 1.28 |
| 9" | | | | | | | |
| CMPS0924 | 200 | 227 | 9 | 24 | 1.3 | 8 | 0.44 |
| CMPS0930 | 219 | 249 | 9 | 30 | 1.3 | 10 | 0.59 |
| CMPS0936 | 235 | 271 | 9 | 36 | 1.3 | 12 | 0.73 |
| CMPS0942 | 249 | 293 | 9 | 42 | 1.3 | 14 | 0.88 |
| CMPS0948 | 259 | 306 | 9 | 48 | 1.3 | 18 | 0.98 |
| CMPS0954 | 259 | 306 | 9 | 54 | 1.3 | 18 | 1.13 |
| CMPS0960 | 299 | 339 | 9 | 60 | 1.3 | 20 | 1.28 |
| 6" | | | | | | | |
| CMPS0624 | 200 | 227 | 6 | 24 | 1.3 | 8 | 0.44 |
| CMPS0630 | 219 | 249 | 6 | 30 | 1.3 | 10 | 0.59 |
| CMPS0636 | 235 | 271 | 6 | 36 | 1.3 | 12 | 0.73 |
| CMPS0642 | 249 | 293 | 6 | 42 | 1.3 | 14 | 0.88 |
| CMPS0648 | 259 | 306 | 6 | 48 | 1.3 | 18 | 0.98 |
| CMPS0654 | 259 | 306 | 6 | 54 | 1.3 | 18 | 1.13 |
| CMPS0660 | 299 | 339 | 6 | 60 | 1.3 | 20 | 1.28 |

CMPSG • Integrated Privacy Glass Divider

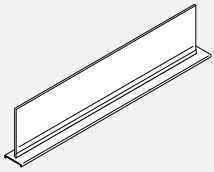

- Privacy Glass integrated with aluminum top trim.
- Attaches on top of panels to add privacy or divide space Includes aluminum trim with channel and glass tile.
- Standard in clear (CLR) or frosted (FRST) glass.
- Glass and attachment hardware to ship seperately.

| PRODUCT CODE | PRICE | | SIZE/INCHES | | | WEIGHT VOL | |
|--------------|-------|------|-------------|-------|------|------------|-----------------|
| | CLR | FRST | H | W | D | LBS | FT ³ |
| CMPSG0624 | 182 | 229 | 6.40 | 22.67 | 2.41 | 3.54 | 0.20 |
| CMPSG0630 | 200 | 251 | 6.40 | 28.67 | 2.41 | 4.49 | 0.26 |
| CMPSG0636 | 212 | 265 | 6.40 | 34.67 | 2.41 | 5.44 | 0.31 |
| CMPSG0642 | 229 | 284 | 6.40 | 40.67 | 2.41 | 6.39 | 0.36 |
| CMPSG0648 | 238 | 297 | 6.40 | 46.67 | 2.41 | 7.34 | 0.42 |
| CMPSG0654 | 245 | 306 | 6.40 | 52.67 | 2.41 | 8.29 | 0.47 |
| CMPSG0660 | 251 | 312 | 6.40 | 58.67 | 2.41 | 9.23 | 0.52 |
| CMPSG0924 | 182 | 229 | 9.40 | 22.67 | 2.41 | 4.99 | 0.30 |
| CMPSG0930 | 200 | 251 | 9.40 | 28.67 | 2.41 | 6.32 | 0.38 |
| CMPSG0936 | 212 | 265 | 9.40 | 34.67 | 2.41 | 7.66 | 0.46 |
| CMPSG0942 | 229 | 284 | 9.40 | 40.67 | 2.41 | 8.99 | 0.53 |
| CMPSG0948 | 238 | 297 | 9.40 | 46.67 | 2.41 | 10.33 | 0.61 |
| CMPSG0954 | 245 | 306 | 9.40 | 52.67 | 2.41 | 11.66 | 0.69 |
| CMPSG0960 | 251 | 312 | 9.40 | 58.67 | 2.41 | 13.00 | 0.77 |
| CMPSG1224 | 182 | 229 | 12.40 | 22.67 | 2.41 | 6.43 | 0.39 |
| CMPSG1230 | 200 | 251 | 12.40 | 28.67 | 2.41 | 8.15 | 0.50 |
| CMPSG1236 | 212 | 265 | 12.40 | 34.67 | 2.41 | 9.87 | 0.60 |
| CMPSG1242 | 229 | 284 | 12.40 | 40.67 | 2.41 | 11.59 | 0.70 |
| CMPSG1248 | 238 | 297 | 12.40 | 46.67 | 2.41 | 13.31 | 0.81 |
| CMPSG1254 | 245 | 306 | 12.40 | 52.67 | 2.41 | 15.04 | 0.91 |
| CMPSG1260 | 251 | 312 | 12.40 | 58.67 | 2.41 | 16.76 | 1.02 |

CMPEEG • Integrated Privacy Glass Extended Divider

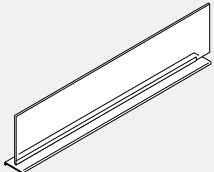

- Privacy Glass integrated with aluminum top trim.
- Glass is longer to extend partially over the post for a corner application.
- Attaches on top of panels to add privacy or divide space Includes aluminum trim with channel and glass tile.
- Standard in clear (CLR) or frosted (FRST) glass.
- Glass and attachment hardware to ship seperately.

| PRODUCT CODE | PRICE | | SIZE/INCHES | | | WEIGHT VOL | |
|--------------|-------|------|-------------|-------|------|------------|-----------------|
| | CLR | FRST | H | W | D | LBS | FT ³ |
| CMPEEG0624 | 182 | 229 | 6.4 | 23.88 | 2.41 | 3.54 | 0.21 |
| CMPEEG0630 | 200 | 251 | 6.4 | 29.88 | 2.41 | 4.49 | 0.27 |
| CMPEEG0636 | 212 | 265 | 6.4 | 35.88 | 2.41 | 5.44 | 0.32 |
| CMPEEG0642 | 229 | 284 | 6.4 | 41.88 | 2.41 | 6.39 | 0.37 |
| CMPEEG0648 | 238 | 297 | 6.4 | 47.88 | 2.41 | 7.34 | 0.43 |
| CMPEEG0654 | 245 | 306 | 6.4 | 53.88 | 2.41 | 8.29 | 0.48 |
| CMPEEG0660 | 251 | 312 | 6.4 | 59.88 | 2.41 | 9.23 | 0.54 |
| CMPEEG0924 | 182 | 229 | 9.4 | 23.88 | 2.41 | 4.99 | 0.31 |
| CMPEEG0930 | 200 | 251 | 9.4 | 29.88 | 2.41 | 6.32 | 0.39 |
| CMPEEG0936 | 212 | 265 | 9.4 | 35.88 | 2.41 | 7.66 | 0.47 |
| CMPEEG0942 | 229 | 284 | 9.4 | 41.88 | 2.41 | 8.99 | 0.55 |
| CMPEEG0948 | 238 | 297 | 9.4 | 47.88 | 2.41 | 10.33 | 0.63 |
| CMPEEG0954 | 245 | 306 | 9.4 | 53.88 | 2.41 | 11.66 | 0.71 |
| CMPEEG0960 | 251 | 312 | 9.4 | 59.88 | 2.41 | 13 | 0.79 |
| CMPEEG1224 | 182 | 229 | 12.4 | 23.88 | 2.41 | 6.43 | 0.41 |
| CMPEEG1230 | 200 | 251 | 12.4 | 29.88 | 2.41 | 8.15 | 0.52 |
| CMPEEG1236 | 212 | 265 | 12.4 | 35.88 | 2.41 | 9.87 | 0.62 |
| CMPEEG1242 | 229 | 284 | 12.4 | 41.88 | 2.41 | 11.59 | 0.73 |
| CMPEEG1248 | 238 | 297 | 12.4 | 47.88 | 2.41 | 13.31 | 0.83 |
| CMPEEG1254 | 245 | 306 | 12.4 | 53.88 | 2.41 | 15.04 | 0.93 |
| CMPEEG1260 | 251 | 312 | 12.4 | 59.88 | 2.41 | 16.76 | 1.04 |

CMPSF • Integrated Felt Divider

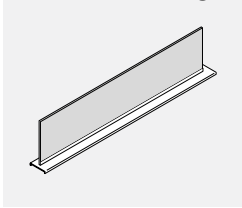

- Privacy felt panel intergrated with aluminum top trim.
- Attaches on top of panels to add privacy or divide space. Includes aluminum trim with channel and felt tile.
- Felt and attachment hardware to ship seperarely.
- 9mm Felt material is tackable and comes in 18 different colours. Please specify colour.

| PRODUCT CODE | PRICE | SIZE/INCHES | | | WEIGHT VOL | |
|--------------|-------|-------------|-------|------|------------|-----------------|
| | | H | W | D | LBS | FT ³ |
| CMPSF0624 | 66 | 6.33 | 22.42 | 2.41 | 1.21 | 0.20 |
| CMPSF0630 | 78 | 6.33 | 28.42 | 2.41 | 1.54 | 0.25 |
| CMPSF0636 | 92 | 6.33 | 34.42 | 2.41 | 1.86 | 0.30 |
| CMPSF0642 | 103 | 6.33 | 40.42 | 2.41 | 2.19 | 0.36 |
| CMPSF0648 | 156 | 6.33 | 46.42 | 2.41 | 2.51 | 0.41 |
| CMPSF0654 | 169 | 6.33 | 52.42 | 2.41 | 2.84 | 0.46 |
| CMPSF0660 | 180 | 6.33 | 58.42 | 2.41 | 3.16 | 0.52 |
| CMPSF0924 | 66 | 9.33 | 22.42 | 2.41 | 1.48 | 0.29 |
| CMPSF0930 | 78 | 9.33 | 28.42 | 2.41 | 1.87 | 0.37 |
| CMPSF0936 | 92 | 9.33 | 34.42 | 2.41 | 2.27 | 0.45 |
| CMPSF0942 | 103 | 9.33 | 40.42 | 2.41 | 2.66 | 0.53 |
| CMPSF0948 | 156 | 9.33 | 46.42 | 2.41 | 3.06 | 0.60 |
| CMPSF0954 | 169 | 9.33 | 52.42 | 2.41 | 3.45 | 0.68 |
| CMPSF0960 | 180 | 9.33 | 58.42 | 2.41 | 3.85 | 0.76 |
| CMPSF1224 | 66 | 12.33 | 22.42 | 2.41 | 1.74 | 0.39 |
| CMPSF1230 | 78 | 12.33 | 28.42 | 2.41 | 2.20 | 0.49 |
| CMPSF1236 | 92 | 12.33 | 34.42 | 2.41 | 2.67 | 0.59 |
| CMPSF1242 | 103 | 12.33 | 40.42 | 2.41 | 3.14 | 0.70 |
| CMPSF1248 | 156 | 12.33 | 46.42 | 2.41 | 3.60 | 0.80 |
| CMPSF1254 | 169 | 12.33 | 52.42 | 2.41 | 4.07 | 0.90 |
| CMPSF1260 | 180 | 12.33 | 58.42 | 2.41 | 4.53 | 1.01 |

CMPEF • Integrated Felt Extended Divider

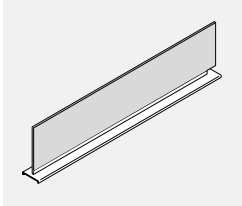

- Privacy felt panel intergrated with aluminum top trim.
- Felt is longer to extend partially over the post for a corner application.
- Attaches on top of panels to add privacy or divide space. Includes aluminum trim with channel and felt tile.
- Felt and attachment hardware to ship seperarely.
- 9mm Felt material is tackable and comes in 18 different colours. Please specify colour.

| PRODUCT CODE | PRICE | SIZE/INCHES | | | WEIGHT VOL | |
|--------------|-------|-------------|-------|------|------------|-----------------|
| | | H | W | D | LBS | FT ³ |
| CMPEF0624 | 66 | 6.33 | 23.88 | 2.41 | 1.21 | 0.21 |
| CMPEF0630 | 78 | 6.33 | 29.88 | 2.41 | 1.54 | 0.36 |
| CMPEF0636 | 92 | 6.33 | 35.88 | 2.41 | 1.86 | 0.32 |
| CMPEF0642 | 103 | 6.33 | 41.88 | 2.41 | 2.19 | 0.37 |
| CMPEF0648 | 156 | 6.33 | 47.88 | 2.41 | 2.51 | 0.42 |
| CMPEF0654 | 169 | 6.33 | 53.88 | 2.41 | 2.84 | 0.48 |
| CMPEF0660 | 180 | 6.33 | 59.88 | 2.41 | 3.16 | 0.53 |
| CMPEF0924 | 66 | 9.33 | 23.88 | 2.41 | 1.48 | 0.31 |
| CMPEF0930 | 78 | 9.33 | 29.88 | 2.41 | 1.87 | 0.39 |
| CMPEF0936 | 92 | 9.33 | 35.88 | 2.41 | 2.27 | 0.47 |
| CMPEF0942 | 103 | 9.33 | 41.88 | 2.41 | 2.66 | 0.55 |
| CMPEF0948 | 156 | 9.33 | 47.88 | 2.41 | 3.06 | 0.62 |
| CMPEF0954 | 169 | 9.33 | 53.88 | 2.41 | 3.45 | 0.7 |
| CMPEF0960 | 180 | 9.33 | 59.88 | 2.41 | 3.85 | 0.78 |
| CMPEF1224 | 66 | 12.33 | 23.88 | 2.41 | 1.74 | 0.41 |
| CMPEF1230 | 78 | 12.33 | 29.88 | 2.41 | 2.2 | 0.51 |
| CMPEF1236 | 92 | 12.33 | 35.88 | 2.41 | 2.67 | 0.62 |
| CMPEF1242 | 103 | 12.33 | 41.88 | 2.41 | 3.14 | 0.72 |
| CMPEF1248 | 156 | 12.33 | 47.88 | 2.41 | 3.6 | 0.82 |
| CMPEF1254 | 169 | 12.33 | 53.88 | 2.41 | 4.07 | 0.93 |
| CMPEF1260 | 180 | 12.33 | 59.88 | 2.41 | 4.53 | 1.03 |

CMLEP-NC • End of Run Gallery Panel With No End Connection

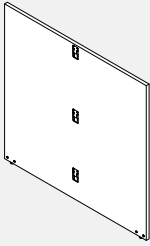

- Provides floor standing support while enclosing the end of a panel run.
- Attached at the end of a straight panel run with connectors to form a T configuration.
- No connections at both ends, connection is at the center interior face.
- Includes all attachment hardware and glides.
- Total height is inclusive of panel glides extended to their full height.
- 51" wide gallery panel accommodates two 24" deep surface while the 63" wide accommodates two 30" deep surfaces.
- Please specify LP laminate finish and PVC edge finish.
- If a wood grain laminate is chosen, grain direction run horizontally.
- Gallery panel is edged in PVC on exposed edges and self edged on bottom.

| PRODUCT CODE | PRICE LP | SIZE / INCHES | | | WEIGHT LBS | VOL FT ³ |
|--------------|----------|---------------|-------|---|------------|---------------------|
| | | H | W | D | | |
| CMLEP4227NC | 299 | 42 | 26.25 | 1 | 28.70 | 0.64 |
| CMLEP4251NC | 523 | 42 | 50.30 | 1 | 57.25 | 3.67 |
| CMLEP4263NC | 607 | 42 | 62.30 | 1 | 70.75 | 4.54 |
| CMLEP4827NC | 329 | 48 | 26.25 | 1 | 32.80 | 0.73 |
| CMLEP4851NC | 575 | 48 | 50.30 | 1 | 65.50 | 4.19 |
| CMLEP4863NC | 667 | 48 | 62.30 | 1 | 80.95 | 5.19 |
| CMLEP5427NC | 358 | 54 | 26.25 | 1 | 36.90 | 0.82 |
| CMLEP5451NC | 626 | 54 | 50.30 | 1 | 73.65 | 4.72 |
| CMLEP5463NC | 727 | 54 | 62.30 | 1 | 91.05 | 5.84 |

CMLMP-NC • Middle of Run Gallery Panel With No End Connection

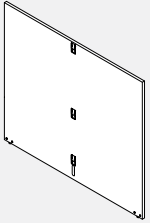

- Provides floor standing support in the middle of a panel run.
- Attached in the middle of a straight panel run with connectors to form an X configuration..
- No connections at both ends, connection is at center on both faces.
- Includes all attachment hardware and glides.
- Total height is inclusive of panel glides extended to their full height.
- 51" wide gallery panel accommodates two 24" deep surface while the 63" wide accommodates two 30" deep surfaces.
- Please specify LP laminate finish and PVC edge finish.
- If a wood grain laminate is chosen, grain direction run horizontally.
- Gallery panel is edged in PVC on exposed edges and self edged on bottom.

| PRODUCT CODE | PRICE LP | SIZE / INCHES | | | WEIGHT LBS | VOL FT ³ |
|--------------|----------|---------------|-------|---|------------|---------------------|
| | | H | W | D | | |
| CMLMP4251NC | 608 | 42 | 50.30 | 1 | 57.25 | 3.67 |
| CMLMP4263NC | 692 | 42 | 62.30 | 1 | 70.75 | 4.54 |
| CMLMP4851NC | 658 | 48 | 50.30 | 1 | 65.50 | 4.19 |
| CMLMP4863NC | 752 | 48 | 62.30 | 1 | 80.95 | 5.19 |
| CMLMP5451NC | 711 | 54 | 50.30 | 1 | 73.65 | 4.72 |
| CMLMP5463NC | 814 | 54 | 62.30 | 1 | 91.05 | 5.84 |

CMLSEPL-NC • Single End Of Run Gallery Panel With No End Connection



- Provides floor standing support while enclosing the end of a panel run.
- Attached at the end of a straight panel run with connectors to form an L configuration.
- No connection at ends, connection is on interior face at one end.
- Includes all attachment hardware and glides.
- Total height is inclusive of panel glides extended to their full height.
- 27" wide gallery panel accommodates a 24" deep surface while the 33" wide accommodates a 30" deep surface.
- Please specify LP laminate finish and PVC edge finish.
- If a wood grain laminate is chosen, grain direction run horizontally.
- Gallery panel is edged in PVC on exposed edges and self edged on bottom.

| PRODUCT CODE | PRICE LP | SIZE / INCHES | | | WEIGHT LBS | VOL FT ³ |
|---------------|----------|---------------|-------|---|------------|---------------------|
| | | H | W | D | | |
| CMLSEPL4215NC | 225 | 42 | 14.25 | 1 | 15.72 | 0.35 |
| CMLSEPR4215NC | 225 | 48 | 14.25 | 1 | 15.72 | 0.40 |
| CMLSEPL4815NC | 244 | 48 | 14.25 | 1 | 17.95 | 0.40 |
| CMLSEPR4815NC | 244 | 48 | 14.25 | 1 | 17.95 | 0.40 |
| CMLSEPL5415NC | 263 | 54 | 14.25 | 1 | 20.18 | 0.45 |
| CMLSEPR5415NC | 263 | 54 | 14.25 | 1 | 20.18 | 0.45 |
| CMLSEPL4227NC | 397 | 42 | 26.30 | 1 | 29.99 | 1.9 |
| CMLSEPR4227NC | 397 | 42 | 26.30 | 1 | 29.99 | 1.9 |
| CMLSEPL4827NC | 434 | 48 | 26.30 | 1 | 34.28 | 2.2 |
| CMLSEPR4827NC | 434 | 48 | 26.30 | 1 | 34.28 | 2.2 |
| CMLSEPL5427NC | 473 | 54 | 26.30 | 1 | 38.56 | 2.5 |
| CMLSEPR5427NC | 473 | 54 | 26.30 | 1 | 38.56 | 2.5 |
| CMLSEPL4233NC | 410 | 42 | 32.33 | 1 | 36.77 | 2.4 |
| CMLSEPR4233NC | 410 | 42 | 32.33 | 1 | 36.77 | 2.4 |
| CMLSEPL4833NC | 448 | 48 | 32.33 | 1 | 42.03 | 2.7 |
| CMLSEPR4833NC | 448 | 48 | 32.33 | 1 | 42.03 | 2.7 |
| CMLSEPL5433NC | 485 | 54 | 32.33 | 1 | 47.3 | 3.0 |
| CMLSEPR5433NC | 485 | 54 | 32.33 | 1 | 47.3 | 3.0 |

CMLSMP-NC • Single Middle of Run Gallery Panel With No End Connection

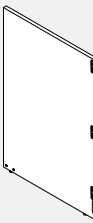

- Provides floor standing support at the middle of a panel run.
- Attached in the middle of a straight panel run with connectors to form a T configuration.
- No connections at the exposed end, connection is at both the interior and exterior face near the opposite end.
- Includes all attachment hardware and glides.
- Total height is inclusive of panel glides extended to their full height.
- 27" wide gallery panel accommodates a 24" deep surface while the 33" wide accommodates a 30" deep surface.
- Please specify LP laminate finish and PVC edge finish.
- If a wood grain laminate is chosen, grain direction run horizontally.
- Gallery panel is edged in PVC on exposed edges and self edged on bottom.

| PRODUCT CODE | PRICE LP | SIZE / INCHES | | | WEIGHT LBS | VOL FT ³ |
|--------------|----------|---------------|-------|---|------------|---------------------|
| | | H | W | D | | |
| CMLSMP4227NC | 483 | 42 | 26.30 | 1 | 30.14 | 1.92 |
| CMLSMP4827NC | 520 | 48 | 26.30 | 1 | 34.42 | 2.19 |
| CMLSMP5427NC | 556 | 54 | 26.30 | 1 | 38.72 | 2.47 |
| CMLSMP4233NC | 497 | 42 | 32.30 | 1 | 36.92 | 2.36 |
| CMLSMP4833NC | 536 | 48 | 32.30 | 1 | 42.18 | 2.69 |
| CMLSMP5433NC | 574 | 54 | 32.30 | 1 | 47.45 | 3.03 |

CMLEP • End Of Run Gallery Panel With End Connections

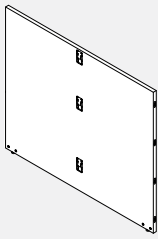

- Provides floor standing support while enclosing the end of a panel run.
- Attached at the end of a straight panel run with connectors to form a T configuration.
- Connections at both ends as well as the center on the interior face.
- Includes all attachment hardware and glides.
- Total height is inclusive of panel glides extended to their full height.
- 51" wide gallery panel accommodates two 24" deep surface while the 63" wide accommodates two 30" deep surfaces.
- Please specify LP laminate finish and PVC edge finish.
- If a wood grain laminate is chosen, grain direction run horizontally.
- Gallery panel is edged in PVC on exposed edges and self edged on edge connecting to panel and bottom edge.

| PRODUCT CODE | PRICE LP | SIZE/INCHES | | | WEIGHT VOL | |
|--------------|----------|-------------|-------|---|------------|-----------------|
| | | H | W | D | LBS | FT ³ |
| CMLEP4251 | 543 | 42 | 50.30 | 1 | 57.25 | 3.67 |
| CMLEP4263 | 626 | 42 | 62.30 | 1 | 70.75 | 4.54 |
| CMLEP4851 | 593 | 48 | 50.30 | 1 | 65.50 | 4.19 |
| CMLEP4863 | 688 | 48 | 62.30 | 1 | 80.95 | 5.19 |
| CMLEP5451 | 646 | 54 | 50.30 | 1 | 73.65 | 4.72 |
| CMLEP5463 | 748 | 54 | 62.30 | 1 | 91.05 | 5.84 |

CMLMP • Middle of Run Gallery Panel With End Connections

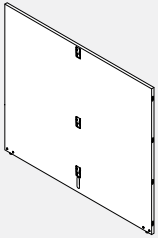

- Provides floor standing support in the middle of a panel run.
- Attached in the middle of a straight panel run with connectors to form an X configuration.
- Connections at both ends as well as the center on the interior and exterior face.
- Includes all attachment hardware and glides.
- Total height is inclusive of panel glides extended to their full height.
- 51" wide gallery panel accommodates two 24" deep surface while the 63" wide accommodates two 30" deep surfaces.
- Please specify LP laminate finish and PVC edge finish.
- If a wood grain laminate is chosen, grain direction run horizontally.
- Gallery panel is edged in PVC on exposed edges and self edged on edge connecting to panel and bottom edge.

| PRODUCT CODE | PRICE LP | SIZE/INCHES | | | WEIGHT VOL | |
|--------------|----------|-------------|-------|---|------------|-----------------|
| | | H | W | D | LBS | FT ³ |
| CMLMP4251 | 612 | 42 | 50.30 | 1 | 57.25 | 3.67 |
| CMLMP4263 | 695 | 42 | 62.30 | 1 | 70.75 | 4.54 |
| CMLMP4851 | 665 | 48 | 50.30 | 1 | 65.50 | 4.19 |
| CMLMP4863 | 757 | 48 | 62.30 | 1 | 80.95 | 5.19 |
| CMLMP5451 | 715 | 54 | 50.30 | 1 | 73.65 | 4.72 |
| CMLMP5463 | 818 | 54 | 62.30 | 1 | 91.05 | 5.84 |

CMLSEPL • Single End Panel With End Connections

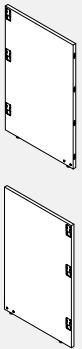

- Provides floor standing support while enclosing the end of a panel run.
- Attached at the end of a straight panel run with connectors to form an L configuration.
- Connections are at the exposed end on one side and near the end on the other interior face.
- Total height is inclusive of panel glides extended to their full height.
- 27" wide gallery panel accommodates a 24" deep surface while the 33" wide accommodates a 30" deep surface.
- Please specify LP laminate finish and PVC edge finish.
- If a wood grain laminate is chosen, grain direction run horizontally.
- Gallery panel is edged in PVC on exposed edges and self edged on edge connecting to panel and bottom edge.

| PRODUCT CODE | PRICE LP | SIZE/INCHES | | | WEIGHT VOL | |
|--------------|----------|-------------|-------|---|------------|-----------------|
| | | H | W | D | LBS | FT ³ |
| CMLSEPL4227 | 408 | 42 | 26.30 | 1 | 29.99 | 1.9 |
| CMLSEPR4227 | 408 | 42 | 26.30 | 1 | 29.99 | 1.9 |
| CMLSEPL4827 | 444 | 48 | 26.30 | 1 | 34.28 | 2.2 |
| CMLSEPR4827 | 444 | 48 | 26.30 | 1 | 34.28 | 2.2 |
| CMLSEPL5427 | 482 | 54 | 26.30 | 1 | 38.56 | 2.5 |
| CMLSEPR5427 | 482 | 54 | 26.30 | 1 | 38.56 | 2.5 |
| CMLSEPL4233 | 419 | 42 | 32.33 | 1 | 36.77 | 2.4 |
| CMLSEPR4233 | 419 | 42 | 32.33 | 1 | 36.77 | 2.4 |
| CMLSEPL4833 | 457 | 48 | 32.33 | 1 | 42.03 | 2.7 |
| CMLSEPR4833 | 457 | 48 | 32.33 | 1 | 42.03 | 2.7 |
| CMLSEPL5433 | 496 | 54 | 32.33 | 1 | 47.3 | 3.0 |
| CMLSEPR5433 | 496 | 54 | 32.33 | 1 | 47.3 | 3.0 |

CMLSMP • Single Middle of Run Gallery Panel With End Connections

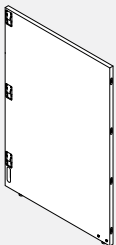

- Provides floor standing support at the middle of a panel run.
- Attached in the middle of a straight panel run with connectors to form a T configuration
- Connections are at the exposed end and at the interior and exterior near the opposite end, allows for left connection of CML2PL only.
- Includes all attachment hardware and glides.
- Total height is inclusive of panel glides extended to their full height.
- 27" wide gallery panel accommodates a 24" deep surface while the 33" wide accommodates a 30" deep surface.
- Please specify LP laminate finish and PVC edge finish.
- If a wood grain laminate is chosen, grain direction run horizontally.
- Gallery panel is edged in PVC on exposed edges and self edged on edge connecting to panel and bottom edge.

| PRODUCT CODE | PRICE LP | SIZE/INCHES | | | WEIGHT VOL | |
|--------------|----------|-------------|-------|------|------------|-----------------|
| | | H | W | D | LBS | FT ³ |
| CMLSMP4227 | 494 | 42 | 26.30 | 1.00 | 30.14 | 1.92 |
| CMLSMP4827 | 529 | 48 | 26.30 | 1.00 | 34.42 | 2.19 |
| CMLSMP5427 | 567 | 54 | 26.30 | 1.00 | 38.72 | 2.47 |
| CMLSMP4233 | 508 | 42 | 32.30 | 1.00 | 36.92 | 2.36 |
| CMLSMP4833 | 546 | 48 | 32.30 | 1.00 | 42.18 | 2.69 |
| CMLSMP5433 | 584 | 54 | 32.30 | 1.00 | 47.45 | 3.03 |

CML2PL • Left Two Way Return End of Run Gallery Panel With End Connections

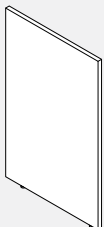

- Provides floor standing support while enclosing the end of a panel run.
- Attached at the end of a gallery panel with connectors to form an L configuration.
- Connections are at one exposed end.
- Includes all attachment hardware and glides.
- Total height is inclusive of panel glides extended to their full height.
- 25" wide gallery panel accommodates a 24" deep surface while the 31" wide accommodates a 30" deep surface.
- Please specify LP laminate finish and PVC edge finish.
- If a wood grain laminate is chosen, grain direction run horizontally.
- Gallery panel is edged in PVC on exposed edges and self edged on edge connecting to panel and bottom edge.

| PRODUCT CODE | PRICE LP | SIZE/INCHES | | | WEIGHT VOL | |
|--------------|----------|-------------|----|---|------------|-----------------|
| | | H | W | D | LBS | FT ³ |
| CML2PL4213 | 153 | 42 | 13 | 1 | 14.16 | 0.32 |
| CML2PL4225 | 323 | 42 | 25 | 1 | 27.14 | 1.82 |
| CML2PL4231 | 331 | 42 | 31 | 1 | 33.62 | 2.26 |
| CML2PL4813 | 172 | 48 | 13 | 1 | 16.19 | 0.36 |
| CML2PL4825 | 359 | 48 | 25 | 1 | 31.04 | 2.08 |
| CML2PL4831 | 370 | 48 | 31 | 1 | 38.47 | 2.58 |
| CML2PL5413 | 192 | 54 | 13 | 1 | 18.22 | 0.41 |
| CML2PL5425 | 396 | 54 | 25 | 1 | 34.95 | 2.34 |
| CML2PL5431 | 408 | 54 | 31 | 1 | 43.31 | 2.91 |

CML2PR • Right Two Way Return End of Run Gallery Panel With End Connections



- Provides floor standing support while enclosing the end of a panel run.
- Attached at the end of a gallery panel with connectors to form an L configuration.
- Connections are at one exposed end.
- Includes all attachment hardware and glides.
- Total height is inclusive of panel glides extended to their full height.
- 25" wide gallery panel accommodates a 24" deep surface while the 31" wide accommodates a 30" deep surface.
- Please specify LP laminate finish and PVC edge finish.
- If a wood grain laminate is chosen, grain direction run horizontally.
- Gallery panel is edged in PVC on exposed edges and self edged on edge connecting to panel and bottom edge.

| PRODUCT CODE | PRICE LP | SIZE/INCHES | | | WEIGHT VOL | |
|--------------|----------|-------------|----|---|------------|-----------------|
| | | H | W | D | LBS | FT ³ |
| CML2PR4213 | 153 | 42 | 13 | 1 | 14.16 | 0.32 |
| CML2PR4225 | 323 | 42 | 25 | 1 | 27.14 | 1.82 |
| CML2PR4231 | 331 | 42 | 31 | 1 | 33.62 | 2.26 |
| CML2PR4813 | 172 | 48 | 13 | 1 | 16.19 | 0.36 |
| CML2PR4825 | 359 | 48 | 25 | 1 | 31.04 | 2.08 |
| CML2PR4831 | 370 | 48 | 31 | 1 | 38.47 | 2.58 |
| CML2PR5413 | 192 | 54 | 13 | 1 | 18.22 | 0.41 |
| CML2PR5425 | 396 | 54 | 25 | 1 | 34.95 | 2.34 |
| CML2PR5431 | 408 | 54 | 31 | 1 | 43.31 | 2.91 |

CML3PL • Left Three Way Return End of Run Gallery Panel

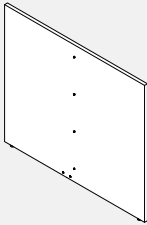

- Provides floor standing support while enclosing the end of a gallery panel run.
- Attached at the end of a gallery panel with connectors to form a T configuration.
- There are no connections at the exposed ends. Connection is at the center of the interior face.
- Connects to CMLXPL or CMLSEPL.
- Includes all attachment hardware and glides.
- Total height is inclusive of panel glides extended to their full height.
- 49" wide gallery panel accommodates two 24" deep surface while the 61" wide accommodates two 30" deep surfaces.
- Please specify LP laminate finish and PVC edge finish.
- If a wood grain laminate is chosen, grain direction run horizontally.
- Gallery panel is edged in PVC on exposed edges and self edged on edge connecting to panel and bottom edge.

| PRODUCT CODE | PRICE LP | SIZE/INCHES | | | WEIGHT VOL | |
|--------------|----------|-------------|----|-----|------------|-----------------|
| | | H | W | D | LBS | FT ³ |
| CML3PL4225 | 229 | 42 | 25 | 1.3 | 27.14 | 0.79 |
| CML3PL4249 | 448 | 42 | 49 | 1 | 53.09 | 3.57 |
| CML3PL4261 | 529 | 42 | 61 | 1 | 66.06 | 4.45 |
| CML3PL4825 | 256 | 48 | 25 | 1.3 | 31.04 | 0.90 |
| CML3PL4849 | 499 | 48 | 49 | 1 | 60.74 | 4.08 |
| CML3PL4861 | 591 | 48 | 61 | 1 | 75.60 | 5.08 |
| CML3PL5425 | 286 | 54 | 25 | 1.3 | 34.95 | 1.02 |
| CML3PL5449 | 550 | 54 | 49 | 1 | 68.40 | 4.59 |
| CML3PL5461 | 653 | 54 | 61 | 1 | 85.13 | 5.72 |

CML3PR • Right Three Way Return End of Run Gallery Panel

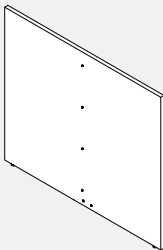

- Provides floor standing support while enclosing the end of a gallery panel run.
- Attached at the end of a gallery panel with connectors to form a T configuration.
- There are no connections at the exposed ends. Connection is at the center of the interior face.
- Connects to CMLXPR or CMLSEPR.
- Includes all attachment hardware and glides.
- Total height is inclusive of panel glides extended to their full height.
- 49" wide gallery panel accommodates two 24" deep surface while the 61" wide accommodates two 30" deep surfaces.
- Please specify LP laminate finish and PVC edge finish.
- If a wood grain laminate is chosen, grain direction run horizontally.
- Gallery panel is edged in PVC on exposed edges and self edged on edge connecting to panel and bottom edge.

| PRODUCT CODE | PRICE LP | SIZE/INCHES | | | WEIGHT VOL | |
|--------------|----------|-------------|----|-----|------------|-----------------|
| | | H | W | D | LBS | FT ³ |
| CML3PR4225 | 229 | 42 | 25 | 1.3 | 27.14 | 0.79 |
| CML3PR4249 | 448 | 42 | 49 | 1 | 53.09 | 3.57 |
| CML3PR4261 | 529 | 42 | 61 | 1 | 66.06 | 4.45 |
| CML3PR4825 | 256 | 48 | 25 | 1.3 | 31.04 | 0.90 |
| CML3PR4849 | 499 | 48 | 49 | 1 | 60.74 | 4.08 |
| CML3PR4861 | 591 | 48 | 61 | 1 | 75.60 | 5.08 |
| CML3PR5425 | 286 | 54 | 25 | 1.3 | 34.95 | 1.02 |
| CML3PR5449 | 550 | 54 | 49 | 1 | 68.40 | 4.59 |
| CML3PR5461 | 653 | 54 | 61 | 1 | 85.13 | 5.72 |

CMLXPL • Left Extension End of Run Return Gallery Panel With End Connection

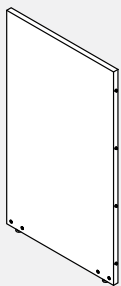

- Provides floor standing support while enclosing the end of a gallery panel run.
- Attached at the end of a panel to allow for extending the gallery panel run.
- Connections at both exposed ends, one to connect to the panel and one to connect to another gallery panel.
- Includes all attachment hardware and glides.
- Total height is inclusive of panel glides extended to their full height.
- Please specify LP laminate finish and PVC edge finish.
- If a wood grain laminate is chosen, grain direction run horizontally.
- Gallery panel is edged in PVC on exposed edges and self edges on edge connecting to panel.

| PRODUCT CODE | PRICE LP | SIZE/INCHES | | | WEIGHT VOL | |
|--------------|----------|-------------|------|---|------------|-----------------|
| | | H | W | D | LBS | FT ³ |
| CMLXPL4212 | 142 | 42 | 12.3 | 1 | 13.08 | 0.30 |
| CMLXPL4224 | 268 | 42 | 24 | 1 | 26.1 | 1.75 |
| CMLXPL4230 | 314 | 42 | 30 | 1 | 32.59 | 2.19 |
| CMLXPL4236 | 361 | 42 | 36 | 1 | 39.07 | 2.63 |
| CMLXPL4242 | 454 | 42 | 42 | 1 | 45.56 | 3.06 |
| CMLXPL4248 | 469 | 42 | 48 | 1 | 52.05 | 3.50 |
| CMLXPL4812 | 159 | 48 | 12.3 | 1 | 14.95 | 0.34 |
| CMLXPL4824 | 276 | 48 | 24 | 1 | 29.85 | 2.00 |
| CMLXPL4830 | 324 | 48 | 30 | 1 | 37.27 | 2.50 |
| CMLXPL4836 | 372 | 48 | 36 | 1 | 44.7 | 3.00 |
| CMLXPL4842 | 469 | 48 | 42 | 1 | 52.12 | 3.50 |
| CMLXPL4848 | 482 | 48 | 48 | 1 | 59.55 | 4.00 |
| CMLXPL5412 | 177 | 54 | 12.3 | 1 | 16.83 | 0.38 |
| CMLXPL5424 | 295 | 54 | 24 | 1 | 33.55 | 2.25 |
| CMLXPL5430 | 346 | 54 | 30 | 1 | 41.92 | 2.81 |
| CMLXPL5436 | 397 | 54 | 36 | 1 | 50.28 | 3.38 |
| CMLXPL5442 | 450 | 54 | 42 | 1 | 58.64 | 3.94 |
| CMLXPL5448 | 552 | 54 | 48 | 1 | 67.01 | 4.50 |

CMLXPR • Right Extension End of Run Return Gallery Panel With End Connection

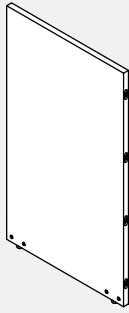

- Provides floor standing support while enclosing the end of a gallery panel run.
- Attached at the end of a panel to allow for extending the gallery panel run.
- Connections are at both exposed ends, one to connect to the panel and one to connect to another gallery panel.
- Includes all attachment hardware and glides.
- Total height is inclusive of panel glides extended to their full height.
- Please specify LP laminate finish and PVC edge finish.
- If a wood grain laminate is chosen, grain direction run horizontally.
- Gallery panel is edged in PVC on exposed edges and self edged on edge connecting to panel.

| PRODUCT CODE | PRICE LP | SIZE/INCHES | | | WEIGHT VOL | |
|--------------|----------|-------------|------|---|------------|-----------------|
| | | H | W | D | LBS | FT ³ |
| CMLXPR4212 | 142 | 42 | 12.3 | 1 | 13.08 | 0.30 |
| CMLXPR4224 | 268 | 42 | 24 | 1 | 26.1 | 1.75 |
| CMLXPR4230 | 314 | 42 | 30 | 1 | 32.59 | 2.19 |
| CMLXPR4236 | 361 | 42 | 36 | 1 | 39.07 | 2.63 |
| CMLXPR4242 | 454 | 42 | 42 | 1 | 45.56 | 3.06 |
| CMLXPR4248 | 469 | 42 | 48 | 1 | 52.05 | 3.50 |
| CMLXPR4812 | 159 | 48 | 12.3 | 1 | 14.95 | 0.34 |
| CMLXPR4824 | 276 | 48 | 24 | 1 | 29.85 | 2.00 |
| CMLXPR4830 | 324 | 48 | 30 | 1 | 37.27 | 2.50 |
| CMLXPR4836 | 372 | 48 | 36 | 1 | 44.7 | 3.00 |
| CMLXPR4842 | 469 | 48 | 42 | 1 | 52.12 | 3.50 |
| CMLXPR4848 | 482 | 48 | 48 | 1 | 59.55 | 4.00 |
| CMLXPR5412 | 177 | 54 | 12.3 | 1 | 16.83 | 0.38 |
| CMLXPR5424 | 295 | 54 | 24 | 1 | 33.55 | 2.25 |
| CMLXPR5430 | 346 | 54 | 30 | 1 | 41.92 | 2.81 |
| CMLXPR5436 | 397 | 54 | 36 | 1 | 50.28 | 3.38 |
| CMLXPR5442 | 450 | 54 | 42 | 1 | 58.64 | 3.94 |
| CMLXPR5448 | 552 | 54 | 48 | 1 | 67.01 | 4.50 |

CMLXPL-NC • Extension End of Run, Left, No Connection

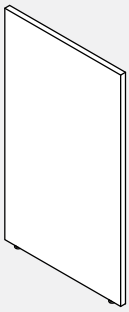

- Provides floor standing support while enclosing the end of a gallery panel run.
- Attached at the end of a gallery panel to extend the gallery panel run.
- Connections only at one exposed end.
- Includes all attachment hardware and glides.
- Total height is inclusive of panel glides extended to their full height.
- Please specify LP laminate finish and PVC edge finish.
- If a wood grain laminate is chosen, grain direction run horizontally.
- Gallery panel is edged in PVC on exposed edges and self edged on edge connecting to panel.

| PRODUCT CODE | PRICE LP | SIZE/INCHES | | | WEIGHT VOL | |
|--------------|----------|-------------|----|---|------------|-----------------|
| | | H | W | D | LBS | FT ³ |
| CMLXPL4224NC | 265 | 42 | 24 | 1 | 26.05 | 1.75 |
| CMLXPL4230NC | 312 | 42 | 30 | 1 | 32.54 | 2.19 |
| CMLXPL4236NC | 359 | 42 | 36 | 1 | 39.03 | 2.63 |
| CMLXPL4242NC | 452 | 42 | 42 | 1 | 45.52 | 3.06 |
| CMLXPL4248NC | 465 | 42 | 48 | 1 | 52.01 | 3.50 |
| CMLXPL4824NC | 274 | 48 | 24 | 1 | 29.8 | 2.00 |
| CMLXPL4830NC | 323 | 48 | 30 | 1 | 37.23 | 2.50 |
| CMLXPL4836NC | 370 | 48 | 36 | 1 | 44.66 | 3.00 |
| CMLXPL4842NC | 465 | 48 | 42 | 1 | 52.08 | 3.50 |
| CMLXPL4848NC | 480 | 48 | 48 | 1 | 59.51 | 4.00 |
| CMLXPL5424NC | 293 | 54 | 24 | 1 | 33.55 | 2.25 |
| CMLXPL5430NC | 344 | 54 | 30 | 1 | 41.92 | 2.81 |
| CMLXPL5436NC | 396 | 54 | 36 | 1 | 50.28 | 3.38 |
| CMLXPL5442NC | 448 | 54 | 42 | 1 | 58.64 | 3.94 |
| CMLXPL5448NC | 550 | 54 | 48 | 1 | 67.01 | 4.50 |

CMLXPR-NC • Extension End of Run, Right, No Connection

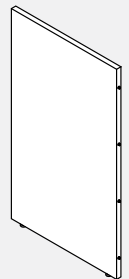

- Provides floor standing support while enclosing the end of a gallery panel run.
- Attached at the end of a gallery panel to extend the gallery panel run.
- Connections only at one exposed end.
- Includes all attachment hardware and glides.
- Total height is inclusive of panel glides extended to their full height.
- Please specify LP laminate finish and PVC edge finish.
- If a wood grain laminate is chosen, grain direction run horizontally.
- Gallery panel is edged in PVC on exposed edges and self edges on edge connecting to panel.

| PRODUCT CODE | PRICE LP | SIZE/INCHES | | | WEIGHT VOL | |
|--------------|----------|-------------|----|---|------------|-----------------|
| | | H | W | D | LBS | FT ³ |
| CMLXPR4224NC | 265 | 42 | 24 | 1 | 26.05 | 1.75 |
| CMLXPR4230NC | 312 | 42 | 30 | 1 | 32.54 | 2.19 |
| CMLXPR4236NC | 359 | 42 | 36 | 1 | 39.03 | 2.63 |
| CMLXPR4242NC | 452 | 42 | 42 | 1 | 45.52 | 3.06 |
| CMLXPR4248NC | 465 | 42 | 48 | 1 | 52.01 | 3.5 |
| CMLXPR4824NC | 274 | 48 | 24 | 1 | 29.8 | 2 |
| CMLXPR4830NC | 323 | 48 | 30 | 1 | 37.23 | 2.5 |
| CMLXPR4836NC | 370 | 48 | 36 | 1 | 44.66 | 3 |
| CMLXPR4842NC | 465 | 48 | 42 | 1 | 52.08 | 3.5 |
| CMLXPR4848NC | 480 | 48 | 48 | 1 | 59.51 | 4 |
| CMLXPR5424NC | 293 | 54 | 24 | 1 | 33.55 | 2.25 |
| CMLXPR5430NC | 344 | 54 | 30 | 1 | 41.92 | 2.81 |
| CMLXPR5436NC | 396 | 54 | 36 | 1 | 50.28 | 3.38 |
| CMLXPR5442NC | 448 | 54 | 42 | 1 | 58.64 | 3.94 |
| CMLXPR5448NC | 550 | 54 | 48 | 1 | 67.01 | 4.5 |

CMHLPBB01 • Gallery Panel Bracket

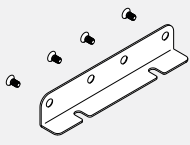

- Gallery panel bottom bracket connects two gallery end panels at bottom with screws.
- Available in standard paint colors.
- Screws are included with the bracket.

| PRODUCT CODE | PRICE | SIZE/INCHES | | | WEIGHT VOL | |
|--------------|-------|-------------|------|---|------------|-----------------|
| | | H | W | D | LBS | FT ³ |
| CMHLPBB01 | 35 | 1.5 | 8.00 | 1 | 0.5 | 0.11 |

CMHLPB01 • Gallery Panel Corner Bracket

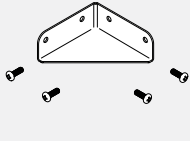

- Gallery panel corner bottom bracket connects two laminate panels at 90 degrees.
- Available in standard paint colors.
- Screws are included with the bracket.

| PRODUCT CODE | PRICE | SIZE/INCHES | | | WEIGHT VOL | |
|--------------|-------|-------------|------|---|------------|-----------------|
| | | H | W | D | LBS | FT ³ |
| CMHLPB01 | 34 | 1.5 | 4.00 | 4 | 0.5 | 0.11 |

CMPMP-GI-W • Privacy Glass for 1" Laminate Gallery Panels

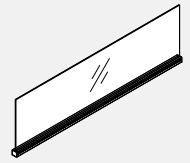

- **Privacy glass integrated with aluminum top trim.**
- Attaches on top of gallery panels to add privacy or divide space.
- Includes aluminum trim with channel, end caps and glass tile.
- Top rail may also be used to hang accessories.
- Glass and attachment hardware ship separately.
- Please specify standard paint finish for the channel.
- Standard in clear (CLR) or frosted (FRST).

| PRODUCT CODE | PRICE | FRST | SIZE/INCHES | | | WEIGHT LBS | VOL FT ³ |
|--------------|-------|------|-------------|----|---|------------|---------------------|
| | | | H | W | D | | |
| CMPMP24GI6W | 201 | 251 | 6 | 24 | 1 | 3.58 | 0.08 |
| CMPMP30GI6W | 219 | 276 | 6 | 30 | 1 | 4.48 | 0.10 |
| CMPMP36GI6W | 235 | 291 | 6 | 36 | 1 | 5.37 | 0.13 |
| CMPMP42GI6W | 251 | 313 | 6 | 42 | 1 | 6.26 | 0.15 |
| CMPMP48GI6W | 262 | 327 | 6 | 48 | 1 | 7.16 | 0.17 |
| CMPMP24GI9W | 201 | 251 | 9 | 24 | 1 | 4.77 | 0.13 |
| CMPMP30GI9W | 219 | 276 | 9 | 30 | 1 | 5.97 | 0.16 |
| CMPMP36GI9W | 235 | 291 | 9 | 36 | 1 | 7.16 | 0.19 |
| CMPMP42GI9W | 251 | 313 | 9 | 42 | 1 | 8.35 | 0.22 |
| CMPMP48GI9W | 262 | 327 | 9 | 48 | 1 | 9.55 | 0.25 |
| CMPMP24GIW | 201 | 251 | 12 | 24 | 1 | 4.77 | 0.17 |
| CMPMP30GIW | 219 | 276 | 12 | 30 | 1 | 5.97 | 0.21 |
| CMPMP36GIW | 235 | 291 | 12 | 36 | 1 | 7.16 | 0.25 |
| CMPMP42GIW | 251 | 313 | 12 | 42 | 1 | 8.35 | 0.29 |
| CMPMP48GIW | 262 | 327 | 12 | 48 | 1 | 9.55 | 0.33 |

CMPFD-W • Privacy Felt for 1" Laminate Gallery Panels

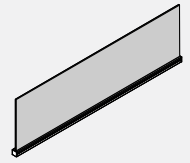

- **Privacy felt integrated with aluminum top trim.**
- Attaches on top of gallery panels to add privacy or divide space.
- Includes aluminum trim with channel, end caps and felt tile.
- Top rail may also be used to hang accessories.
- Felt and attachment hardware ship separately.
- Please specify standard paint finish for the channel.
- Please specify standard felt finish.

| PRODUCT CODE | PRICE | SIZE/INCHES | | | WEIGHT LBS | VOL FT ³ |
|--------------|-------|-------------|----|---|------------|---------------------|
| | | H | W | D | | |
| CMPFD0624W | 72 | 6 | 24 | 1 | 1.42 | 0.08 |
| CMPFD0630W | 88 | 6 | 30 | 1 | 1.73 | 0.10 |
| CMPFD0636W | 102 | 6 | 36 | 1 | 2.03 | 0.13 |
| CMPFD0642W | 114 | 6 | 42 | 1 | 2.34 | 0.15 |
| CMPFD0648W | 170 | 6 | 48 | 1 | 2.64 | 0.17 |
| CMPFD0654W | 183 | 6 | 54 | 1 | 2.95 | 0.19 |
| CMPFD0660W | 199 | 6 | 60 | 1 | 3.25 | 0.21 |
| CMPFD0666W | 210 | 6 | 66 | 1 | 3.56 | 0.23 |
| CMPFD0672W | 238 | 6 | 72 | 1 | 3.86 | 0.25 |
| CMPFD0924W | 72 | 9 | 24 | 1 | 2.26 | 0.13 |
| CMPFD0930W | 88 | 9 | 30 | 1 | 2.77 | 0.16 |
| CMPFD0936W | 102 | 9 | 36 | 1 | 3.29 | 0.19 |
| CMPFD0942W | 114 | 9 | 42 | 1 | 3.8 | 0.22 |
| CMPFD0948W | 170 | 9 | 48 | 1 | 4.32 | 0.25 |
| CMPFD0954W | 183 | 9 | 54 | 1 | 4.83 | 0.28 |
| CMPFD0960W | 199 | 9 | 60 | 1 | 5.35 | 0.31 |
| CMPFD0966W | 210 | 9 | 66 | 1 | 6.68 | 0.34 |
| CMPFD0972W | 238 | 9 | 72 | 1 | 7.2 | 0.38 |
| CMPFD1224W | 72 | 12 | 24 | 1 | 2.26 | 0.17 |
| CMPFD1230W | 88 | 12 | 30 | 1 | 2.77 | 0.21 |
| CMPFD1236W | 102 | 12 | 36 | 1 | 3.29 | 0.25 |
| CMPFD1242W | 114 | 12 | 42 | 1 | 3.8 | 0.29 |
| CMPFD1248W | 170 | 12 | 48 | 1 | 4.32 | 0.33 |
| CMPFD1254W | 183 | 12 | 54 | 1 | 4.83 | 0.38 |
| CMPFD1260W | 199 | 12 | 60 | 1 | 5.35 | 0.42 |
| CMPFD1266W | 210 | 12 | 66 | 1 | 6.68 | 0.46 |
| CMPFD1272W | 238 | 12 | 72 | 1 | 7.2 | 0.50 |

CHP • 90 Degree Corner Post Kits



- Standard Compile paint options.
- Specify the corner post height that matches the tallest or smallest panel connection.
- 6" shorter than panel height to accommodate electric in base.
- Made of aluminum.
- 2-Way Kits include 2 trims (CMETP), 2 way post base (CMPC) and post cap (CMPC).
- 3-Way Kits include 1 trim (CMTEP), 3 way post base (CMPC) and post cap (CMPC).
- 4 Way Kits includes post cap (CMPC) only.

| PRODUCT CODE | PRICE | SIZE/ H | INCHES | | | WEIGHT VOL | |
|-------------------|-------|---------|--------|-----|-----|-----------------|--|
| | | | W | D | LBS | FT ³ | |
| 2-Way Kits | | | | | | | |
| CHP30-2 | 104 | 30 | 2.3 | 2.3 | 5 | 0.22 | |
| CHP42-2 | 104 | 42 | 2.3 | 2.3 | 5 | 0.22 | |
| CHP46-2 | 109 | 46 | 2.3 | 2.3 | 5 | 0.22 | |
| CHP48-2 | 126 | 48 | 2.3 | 2.3 | 5 | 0.22 | |
| CHP54-2 | 126 | 54 | 2.3 | 2.3 | 5 | 0.22 | |
| CHP58-2 | 136 | 58 | 2.3 | 2.3 | 5 | 0.22 | |
| CHP60-2 | 136 | 60 | 2.3 | 2.3 | 5 | 0.22 | |
| CHP64-2 | 158 | 64 | 2.3 | 2.3 | 5 | 0.22 | |
| CHP66-2 | 151 | 66 | 2.3 | 2.3 | 5 | 0.22 | |
| CHP70-2 | 161 | 70 | 2.3 | 2.3 | 5 | 0.22 | |
| CHP72-2 | 158 | 72 | 2.3 | 2.3 | 5 | 0.22 | |
| CHP78-2 | 179 | 78 | 2.3 | 2.3 | 5 | 0.22 | |
| CHP82-2 | 190 | 82 | 2.3 | 2.3 | 5 | 0.22 | |
| CHP90-2 | 190 | 90 | 2.3 | 2.3 | 5 | 0.22 | |
| 3-Way Kits | | | | | | | |
| CHP30-3 | 91 | 30 | 2.3 | 2.3 | 5 | 0.22 | |
| CHP42-3 | 91 | 42 | 2.3 | 2.3 | 5 | 0.22 | |
| CHP46-3 | 100 | 46 | 2.3 | 2.3 | 5 | 0.22 | |
| CHP48-3 | 110 | 48 | 2.3 | 2.3 | 5 | 0.22 | |
| CHP54-3 | 110 | 54 | 2.3 | 2.3 | 5 | 0.22 | |
| CHP58-3 | 124 | 58 | 2.3 | 2.3 | 5 | 0.22 | |
| CHP60-3 | 124 | 60 | 2.3 | 2.3 | 5 | 0.22 | |
| CHP64-3 | 132 | 64 | 2.3 | 2.3 | 5 | 0.22 | |
| CHP66-3 | 136 | 66 | 2.3 | 2.3 | 5 | 0.22 | |
| CHP70-3 | 143 | 70 | 2.3 | 2.3 | 5 | 0.22 | |
| CHP72-3 | 143 | 72 | 2.3 | 2.3 | 5 | 0.22 | |
| CHP78-3 | 161 | 78 | 2.3 | 2.3 | 5 | 0.22 | |
| CHP82-3 | 170 | 82 | 2.3 | 2.3 | 5 | 0.22 | |
| CHP90-3 | 187 | 90 | 2.3 | 2.3 | 5 | 0.22 | |
| 4-Way Kits | | | | | | | |
| CHP30-4 | 68 | 30 | 2.3 | 2.3 | 5 | 0.22 | |
| CHP42-4 | 68 | 42 | 2.3 | 2.3 | 5 | 0.22 | |
| CHP46-4 | 90 | 46 | 2.3 | 2.3 | 5 | 0.22 | |
| CHP48-4 | 89 | 48 | 2.3 | 2.3 | 5 | 0.22 | |
| CHP54-4 | 89 | 54 | 2.3 | 2.3 | 5 | 0.22 | |
| CHP58-4 | 102 | 58 | 2.3 | 2.3 | 5 | 0.22 | |
| CHP60-4 | 102 | 60 | 2.3 | 2.3 | 5 | 0.22 | |
| CHP64-4 | 106 | 64 | 2.3 | 2.3 | 5 | 0.22 | |
| CHP66-4 | 112 | 66 | 2.3 | 2.3 | 5 | 0.22 | |
| CHP70-4 | 116 | 70 | 2.3 | 2.3 | 5 | 0.22 | |
| CHP72-4 | 116 | 72 | 2.3 | 2.3 | 5 | 0.22 | |
| CHP78-4 | 133 | 78 | 2.3 | 2.3 | 5 | 0.22 | |
| CHP82-4 | 139 | 82 | 2.3 | 2.3 | 5 | 0.22 | |
| CHP90-4 | 156 | 90 | 2.3 | 2.3 | 5 | 0.22 | |

CHOP • 90 Degree Corner Post Kits for Over Panels



- Standard Compile paint options.
- Specify the corner post height that matches the height of the over panel
- Made of aluminum.

| PRODUCT CODE | PRICE | SIZE/ H | INCHES | | | WEIGHT VOL | |
|--------------|-------|---------|--------|-----|-----|-----------------|--|
| | | | W | D | LBS | FT ³ | |
| CHOP12-4 | 27 | 12 | 2.3 | 2.3 | 5 | 0.22 | |
| CHOP16-4 | 41 | 16 | 2.3 | 2.3 | 5 | 0.22 | |
| CHOP24-4 | 40 | 24 | 2.3 | 2.3 | 5 | 0.22 | |

CHP2W • 60 Degree 2 Way Corner Post



- Standard Compile paint options.
- Specify the corner post height that matches the tallest or smallest panel connection.
- Note: Made of aluminum.
- Outer part is full panel height, inner part is 6" shorter.
- Post cap included.

| PRODUCT CODE | PRICE | SIZE/ INCHES | | | WEIGHT VOL | |
|--------------|-------|--------------|-----|-----|------------|-----------------|
| | | H | W | D | LBS | FT ³ |
| CHP2W30 | 68 | 30 | 2.3 | 2.3 | 5 | 0.22 |
| CHP2W42 | 68 | 42 | 2.3 | 2.3 | 5 | 0.22 |
| CHP2W46 | 75 | 46 | 2.3 | 2.3 | 5 | 0.22 |
| CHP2W48 | 89 | 48 | 2.3 | 2.3 | 5 | 0.22 |
| CHP2W54 | 89 | 54 | 2.3 | 2.3 | 5 | 0.22 |
| CHP2W58 | 93 | 58 | 2.3 | 2.3 | 5 | 0.22 |
| CHP2W60 | 103 | 60 | 2.3 | 2.3 | 5 | 0.22 |
| CHP2W64 | 112 | 64 | 2.3 | 2.3 | 5 | 0.22 |
| CHP2W66 | 112 | 66 | 2.3 | 2.3 | 5 | 0.22 |
| CHP2W70 | 117 | 70 | 2.3 | 2.3 | 5 | 0.22 |
| CHP2W72 | 117 | 72 | 2.3 | 2.3 | 5 | 0.22 |
| CHP2W78 | 133 | 78 | 2.3 | 2.3 | 5 | 0.22 |
| CHP2W82 | 139 | 82 | 2.3 | 2.3 | 5 | 0.22 |
| CHP2W90 | 153 | 90 | 2.3 | 2.3 | 5 | 0.22 |

CHP3W • 60 Degree 3 Way Corner Post



- Standard Compile paint options.
- Specify the corner post height that matches the tallest or smallest panel connection.
- 6" shorter than panel height to accommodate electric in base.
- Note: Made of aluminum.
- Actual post size is 6" shorter than panel height.
- Post cap included.

| PRODUCT CODE | PRICE | SIZE/ INCHES | | | WEIGHT VOL | |
|--------------|-------|--------------|-----|-----|------------|-----------------|
| | | H | W | D | LBS | FT ³ |
| CHP3W30 | 68 | 30 | 2.3 | 2.3 | 5 | 0.22 |
| CHP3W42 | 68 | 42 | 2.3 | 2.3 | 5 | 0.22 |
| CHP3W46 | 75 | 46 | 2.3 | 2.3 | 5 | 0.22 |
| CHP3W48 | 89 | 48 | 2.3 | 2.3 | 5 | 0.22 |
| CHP3W54 | 89 | 54 | 2.3 | 2.3 | 5 | 0.22 |
| CHP3W58 | 93 | 58 | 2.3 | 2.3 | 5 | 0.22 |
| CHP3W60 | 103 | 60 | 2.3 | 2.3 | 5 | 0.22 |
| CHP3W64 | 112 | 64 | 2.3 | 2.3 | 5 | 0.22 |
| CHP3W66 | 112 | 66 | 2.3 | 2.3 | 5 | 0.22 |
| CHP3W70 | 117 | 70 | 2.3 | 2.3 | 5 | 0.22 |
| CHP3W72 | 117 | 72 | 2.3 | 2.3 | 5 | 0.22 |
| CHP3W78 | 133 | 78 | 2.3 | 2.3 | 5 | 0.22 |
| CHP3W82 | 139 | 82 | 2.3 | 2.3 | 5 | 0.22 |
| CHP3W90 | 153 | 90 | 2.3 | 2.3 | 5 | 0.22 |

CMPC • 90 Degree Post Cap

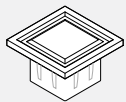

- Included with any post.
- Specified separately for reconfiguration purposes.
- Available in standard Compile paint options.

| PRODUCT CODE | PRICE | SIZE/ INCHES | | | WEIGHT VOL | |
|--------------|-------|--------------|-----|-----|------------|-----------------|
| | | H | W | D | LBS | FT ³ |
| CMPC | 8 | 0.7 | 2.5 | 2.5 | 0.02 | 0.01 |

CMPC • 60 Degree Post Cap

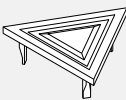

- Included with any post.
- Specified separately for reconfiguration purposes.
- Available in standard Compile paint options.

| PRODUCT CODE | PRICE | SIZE/ INCHES | | | WEIGHT VOL | |
|--------------|-------|--------------|-----|-----|------------|-----------------|
| | | H | W | D | LBS | FT ³ |
| CMPC60 | 8 | 0.7 | 2.5 | 2.5 | 0.02 | 0.01 |

CMPC • Post Base Cover



- Included with any post kit.
- Specified separately for reconfiguration purposes.
- Available in standard Compile paint options.
- Available for 2-way and 3-way configurations.
- Note: Finish is smooth plastic.

| PRODUCT CODE | PRICE | SIZE/INCHES | | | WEIGHT VOL | | |
|--------------|-------|-------------|---|-----|------------|-----------------|------|
| | | H | W | D | LBS | FT ³ | |
| CMPC1 | 12 | 3-Way | 5 | 2.3 | 0.33 | 0.04 | 0.02 |
| CMPC2 | 13 | 2-Way | 5 | 2.3 | 2.31 | 0.08 | 0.04 |

CEPE • Data Post Extension



- Data Post extension comes with 4 trims, 3 brackets, connecting hardware and ceiling bezel and two post clips.
- Data Post extension available in standard Compile paint options. (Ceiling bezel available in white only.)
- Includes cut out along the post for easy cable insert.

| PRODUCT CODE | PRICE | SIZE/INCHES | | | WEIGHT VOL | |
|--------------|-------|-------------|-----|-----|------------|-----------------|
| | | H | W | D | LBS | FT ³ |
| CEPE64 | 190 | 64 | 2.3 | 2.3 | 9 | 0.42 |
| CEPE82 | 245 | 82 | 2.3 | 2.3 | 9 | 0.42 |

CMET • End of Run Insert for Panel



- End of Run inserts are not included with panels.
- Cannot be used for a 60° and 90° post application.
- Used at the end of each panel run and cannot be used to attach a panel run to a fixed wall.
- Vertical trims must be specified separately. Trim snaps in the panel at the end of run.
- Available in standard Compile paint options.

| PRODUCT CODE | PRICE | SIZE/INCHES | | | WEIGHT VOL | |
|--------------|-------|-------------|-----|-----|------------|------|
| | | H | W | D | LBS | FT³ |
| CMET16 | 12 | 16 | 2.3 | 0.5 | 0.12 | 0.01 |
| CMET30 | 14 | 30 | 2.3 | 0.5 | 0.12 | 0.05 |
| CMET42 | 14 | 42 | 2.3 | 0.5 | 0.74 | 0.05 |
| CMET46 | 14 | 46 | 2.3 | 0.5 | 0.74 | 0.05 |
| CMET48 | 14 | 48 | 2.3 | 0.5 | 0.82 | 0.18 |
| CMET54 | 14 | 54 | 2.3 | 0.5 | 0.90 | 0.18 |
| CMET58 | 15 | 58 | 2.3 | 0.5 | 0.9 | 0.18 |
| CMET60 | 15 | 60 | 2.3 | 0.5 | 1.48 | 0.31 |
| CMET64 | 19 | 64 | 2.3 | 0.5 | 1.48 | 0.31 |
| CMET66 | 19 | 66 | 2.3 | 0.5 | 1.48 | 0.31 |
| CMET70 | 20 | 70 | 2.3 | 0.5 | 1.48 | 0.31 |
| CMET72 | 20 | 72 | 2.3 | 0.5 | 1.48 | 0.31 |
| CMET78 | 21 | 78 | 2.3 | 0.5 | 2.06 | 0.44 |
| CMET82 | 22 | 82 | 2.3 | 0.5 | 2.06 | 0.44 |
| CMET90 | 24 | 90 | 2.3 | 0.5 | 2.06 | 0.44 |

CMET • End of Run Trim Insert for Step Down



- Specify for any step down application and to meet the taller post or panel.
- Trim snaps in the post or end of run at a change in height.
- Available in standard Compile paint options.

| PRODUCT CODE | PRICE | SIZE/INCHES | | | WEIGHT VOL | |
|--------------|-------|-------------|-----|-----|------------|------|
| | | H | W | D | LBS | FT³ |
| CEMT06 | 5 | 6 | 2.3 | 0.5 | 0.06 | 0.05 |
| CMET12 | 9 | 12 | 2.3 | 0.5 | 0.12 | 0.05 |
| CMET24 | 12 | 24 | 2.3 | 0.5 | 0.12 | 0.05 |
| CMET36 | 14 | 36 | 2.3 | 0.5 | 0.12 | 0.05 |

CMETP • Trim Insert for Corner Post



- Trim installs on all sides of an exposed Corner Post.
- Specify to equal post height.
- Vertical trims must be specified separately. Trim snaps in the post.
- Available in standard Compile paint options.

| PRODUCT CODE | PRICE | SIZE/INCHES | | | WEIGHT VOL | |
|--------------|-------|-------------|-----|-----|------------|------|
| | | H | W | D | LBS | FT³ |
| CMETP30 | 14 | 30 | 2.3 | 0.5 | 0.12 | 0.05 |
| CMETP42 | 14 | 42 | 2.3 | 0.5 | 0.74 | 0.05 |
| CMETP46 | 14 | 46 | 2.3 | 0.5 | 0.74 | 0.05 |
| CMETP48 | 16 | 48 | 2.3 | 0.5 | 0.82 | 1.18 |
| CMETP54 | 16 | 54 | 2.3 | 0.5 | 0.90 | 0.18 |
| CMETP58 | 16 | 58 | 2.3 | 0.5 | 0.9 | 0.18 |
| CMETP60 | 16 | 60 | 2.3 | 0.5 | 2.06 | 0.44 |
| CMETP64 | 19 | 64 | 2.3 | 0.5 | 1.48 | 0.31 |
| CMETP66 | 19 | 66 | 2.3 | 0.5 | 1.48 | 0.31 |
| CMETP70 | 19 | 70 | 2.3 | 0.5 | 1.48 | 0.31 |
| CMETP72 | 19 | 72 | 2.3 | 0.5 | 2.06 | 0.44 |
| CMETP78 | 21 | 78 | 2.3 | 0.5 | 2.06 | 0.44 |
| CMETP82 | 22 | 82 | 2.3 | 0.5 | 2.06 | 0.44 |
| CMETP90 | 24 | 90 | 2.3 | 0.5 | 2.06 | 0.44 |

CHWA • Wall Mount Extrusion



- Starts a run of panels off an existing wall.
- Includes panel connectors.
- Mounting hardware not included. The mounting hardware selected must be based on the wall or wall stud material.
- Wall adapter adds 5/16" to a panel run.

| PRODUCT CODE | PRICE | SIZE/INCHES | | | WEIGHT VOL | |
|--------------|-------|-------------|-----|-----|------------|------|
| | | H | W | D | LBS | FT³ |
| CHWA30 | 37 | 30 | 2.3 | 0.5 | 0.12 | 0.05 |
| CHWA42 | 37 | 42 | 2.3 | 0.5 | 0.74 | 0.05 |
| CHWA54 | 46 | 54 | 2.3 | 0.5 | 0.90 | 0.18 |
| CHWA66 | 56 | 66 | 2.3 | 0.5 | 1.48 | 0.31 |

CWMA • Wall Vertical Channel



- Used to attach system components to fixed wall.
- Panel frame finish.
- Comes in 60" length only.
- Care should be taken to mount adapters only to wall studs using correct fasteners.
- Does not include mounting hardware. Mounting hardware selection to be based on wall material.
- Sold in pairs.
- Failure to do this may result in collapse of the unit and subsequent possible personal injury.

| PRODUCT CODE | PRICE | SIZE/INCHES | | | WEIGHT VOL | |
|--------------|-------|-------------|-----|-----|------------|-------|
| | | H | W | D | LBS | FT³ |
| CWMA60 | 31 | 60 | 0.6 | 0.7 | 1.07 | 0.006 |

CHHF01 • High Profile Foot

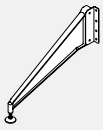

- Provides added support to a panel or worksurface under load.
- Includes Compile attachment bracket and two levelling glides to adapt to different panel clearances.

| PRODUCT CODE | PRICE | SIZE/INCHES | | | WEIGHT VOL | |
|--------------|-------|-------------|---|----|------------|-----------------|
| | | H | W | D | LBS | FT ³ |
| CHHF01 | 249 | 6 | 1 | 21 | 2.80 | 0.15 |

CMPS01 • Post Separator

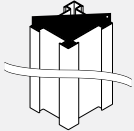

- Creates a diagonal division within a compile post.
- Please specify post height.

| PRODUCT CODE | PRICE | SIZE/INCHES | | | WEIGHT VOL | |
|--------------|-------|-------------|------|----------|------------|-----------------|
| | | H | W | D | LBS | FT ³ |
| CMPS01 | 136 | 96 | 3.25 | 14 guage | 0.01 | 0.015 |

CBEZEL • Post Extension Bezel

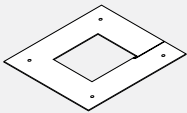

- Finishes the connection between post extension and ceiling.
- Comes in white only.
- Includes screws.

| PRODUCT CODE | PRICE | SIZE/INCHES | | | WEIGHT VOL | |
|--------------|-------|-------------|---|---|------------|-----------------|
| | | H | W | D | LBS | FT ³ |
| CBEZEL | 12 | 0.06 | 6 | 6 | 0.01 | 0.006 |

CMRC • Raceway Cover Without Punchouts (Each)

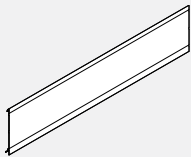

- Durable extruded aluminum.

| PRODUCT CODE | PRICE | SIZE/INCHES | | | WEIGHT VOL | |
|--------------|-------|-------------|----|-----|------------|-----------------|
| | | H | W | D | LBS | FT ³ |
| CMRC24NP | 16 | 5 | 24 | 0.8 | 1.9 | 0.06 |
| CMRC30NP | 21 | 5 | 30 | 0.8 | 2.0 | 0.06 |
| CMRC36NP | 23 | 5 | 36 | 0.8 | 2.2 | 0.07 |
| CMRC42NP | 25 | 5 | 42 | 0.8 | 2.5 | 0.08 |
| CMRC48NP | 27 | 5 | 48 | 0.8 | 2.9 | 0.09 |
| CMRC54NP | 34 | 5 | 54 | 0.8 | 3.2 | 0.10 |
| CMRC60NP | 36 | 5 | 60 | 0.8 | 3.7 | 0.11 |

CMHLPF • Flat Leg for Freestanding Panels

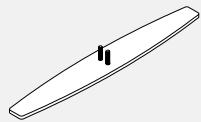

- Single flat leg for end of run/wing applications where the customer is looking for more stability.
- Kit will contains one legs and all attachment hardware.
- For the installation the customer will have to remove the existing levelers on the panel and replace it with the legs.
- Please specify paint finish.

| PRODUCT CODE | PRICE | SIZE/ INCHES | | | WEIGHT VOL | |
|--------------|-------|--------------|----|---|------------|-----------------|
| | | H | W | D | LBS | FT ³ |
| CMHLPF01 | 81 | 0.31 | 21 | 3 | 3 | 0.01 |

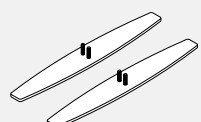

- Double kit for freestanding applications.
- Kit will contains two legs and all attachment hardware.
- For the installation the customer will have to remove the existing levelers on the panel and replace it with the legs.
- Please specify paint finish.

| PRODUCT CODE | PRICE | SIZE/ INCHES | | | WEIGHT VOL | |
|--------------|-------|--------------|----|---|------------|-----------------|
| | | H | W | D | LBS | FT ³ |
| CMHLPF02 | 162 | 0.31 | 21 | 3 | 6 | 0.02 |

CMHLLP01 • Low Profile Foot

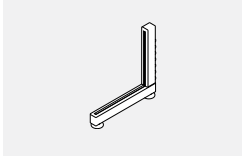

- Provides added support to a panel under load.
- Adjustable glides and connectors included.
- Made of powder coated steel.
- Please choose panel frame finish.

| PRODUCT CODE | PRICE | SIZE/INCHES | | | WEIGHT VOL | |
|--------------|-------|-------------|----|-----|------------|-----------------|
| | | H | W | D | LBS | FT ³ |
| CMHLLP01 | 123 | 12 | 11 | 1.1 | 2.87 | 0.08 |

CMHLLP02 • Low Profile Foot, Set of 2

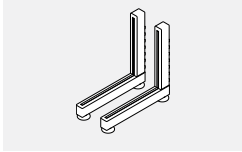

- Provides added support to a panel under load.
- Adjustable glides and connectors included.
- Made of powder coated steel.
- Please choose panel frame finish.
- Set includes 2 complete legs.

| PRODUCT CODE | PRICE | SIZE/INCHES | | | WEIGHT VOL | |
|--------------|-------|-------------|----|-----|------------|-----------------|
| | | H | W | D | LBS | FT ³ |
| CMHLLP02 | 245 | 12 | 11 | 1.1 | 5.74 | 0.17 |

CMRCB01 • Electrical Blank Cover

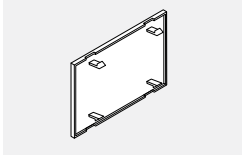

- Fills punchout when opening is not used.
- Available in Black (BLK), Tungsten (TUN), White (WHT) and Nevada (NEV).
- Note: Punchout covers are made of plastic.

| PRODUCT CODE | PRICE | SIZE/INCHES | | | WEIGHT VOL | |
|--------------|-------|-------------|-------|------|------------|-----------------|
| | | H | W | D | LBS | FT ³ |
| CMRCB01 | 14 | 1.5 | 2.756 | 0.01 | 0.04 | 0.02 |

CMRC • Raceway Cover With Punchouts (Each)

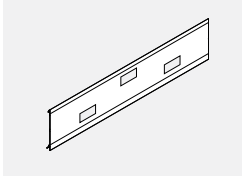

- Cover not included
- Raceway Punchout Cover must be added to openings where duplex receptacles are not used.
- Durable extruded aluminum.
- 24" wide panels have two punchouts, one for electrical and one for data.
- 30" wide panels and wider have three punchouts, two for electrical and one for data.

| PRODUCT CODE | PRICE | SIZE/INCHES | | | WEIGHT VOL | |
|--------------|-------|-------------|----|-----|------------|-----------------|
| | | H | W | D | LBS | FT ³ |
| CMRC24PO | 16 | 5 | 24 | 0.8 | 1.9 | 0.06 |
| CMRC30PO | 21 | 5 | 30 | 0.8 | 2.0 | 0.06 |
| CMRC36PO | 23 | 5 | 36 | 0.8 | 2.2 | 0.07 |
| CMRC42PO | 25 | 5 | 42 | 0.8 | 2.5 | 0.08 |
| CMRC48PO | 27 | 5 | 48 | 0.8 | 2.9 | 0.09 |
| CMRC54PO | 34 | 5 | 54 | 0.8 | 3.2 | 0.10 |
| CMRC60PO | 36 | 5 | 60 | 0.8 | 3.7 | 0.11 |
| CMRC66PO | 40 | 5 | 66 | 0.8 | 4.0 | 0.12 |
| CMRC72PO | 44 | 5 | 72 | 0.8 | 4.4 | 0.13 |

CM0100LKCLIP • Lock Clip

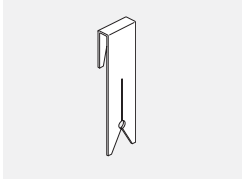

- Use to hold and lock 2 panels or panel post together and prevents disconnection.

| PRODUCT CODE | PRICE | SIZE/INCHES | | | WEIGHT VOL | |
|--------------|-------|-------------|------|------|------------|-----------------|
| | | H | W | D | LBS | FT ³ |
| CM0100LKCLIP | 8 | 2.6 | 0.75 | 0.32 | 0.026 | 0.001 |

CPN01 • Name Plate

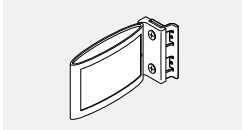

- Name plate can be set either as a single-sided (parallel to panel surface) or double-sided (perpendicular to panel surface - for isle applications, displaying name on both sides).
- Injection molded frame and die-cast base with black rubberized finish. Steel bracket and fasteners included.
- Includes two slide-in name cards.

| PRODUCT CODE | PRICE | SIZE/ INCHES | | | WEIGHT VOL | |
|--------------|-------|--------------|-----|------|------------|-----------------|
| | | H | W | D | LBS | FT ³ |
| CPNP01 | 74 | 3.3 | 5.3 | 1.25 | 0.3 | 0.013 |

CE8PD • Power Distribution Housing

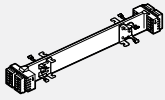

- Power distribution housing is specified per panel size (e.g. CE8PD36 is for use in a 36" panel).
- 8 wire, 4 circuits (A and B circuit dedicated). Provides two duplex receptacles per panel side on all panel widths except the 24" wide panel.
- 24" wide panel allows for only one (1) duplex receptacle on one panel side.
- Each power distribution housing supports 15 amps.
- Must specify Raceway Cover with punchouts on panels, where Power Distribution Housings will be utilized. (Panel Kits P1 and P2)

| PRODUCT CODE | PRICE | SIZE/INCHES | | | WEIGHT VOL | |
|--------------|-------|-------------|-------|-----|------------|-----------------|
| | | H | W | D | LBS | FT ³ |
| CE8PD24 | 156 | 2 | 9.25 | 2.3 | 0.83 | 1.17 |
| CE8PD30 | 208 | 2 | 15.25 | 2.3 | 1.28 | 1.17 |
| CE8PD36 | 220 | 2 | 21.25 | 2.3 | 1.62 | 1.65 |
| CE8PD42 | 226 | 2 | 27.25 | 2.3 | 2.00 | 2.00 |
| CE8PD48 | 238 | 2 | 33.25 | 2.3 | 2.32 | 2.54 |
| CE8PD54 | 242 | 2 | 39.25 | 2.3 | 2.66 | 3.20 |
| CE8PD60 | 243 | 2 | 45.25 | 2.3 | 3.04 | 3.20 |
| CE8PD66 | 253 | 2 | 51.25 | 2.3 | 3.42 | 3.48 |
| CE8PD72 | 262 | 2 | 57.25 | 2.3 | 3.80 | 3.48 |

CE8CP • 17" Mesh Jumper Cable

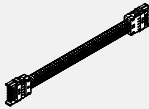

- 17" mesh jumper.
- Jumper cable is used to pass through a post or connect two panels together.

| PRODUCT CODE | PRICE | SIZE/INCHES | | | WEIGHT VOL | |
|--------------|-------|-------------|----|-----|------------|-----------------|
| | | H | W | D | LBS | FT ³ |
| CE8CP17 | 149 | 2 | 17 | 0.5 | 0.71 | 0.67 |

CE8CP • Pass Through Cable

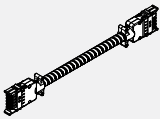

- Flexible metal conduit is used to distribute electrical power through non-powered panels.
- Metal conduit pass through cables should be in used in a straight runs. Metal conduit pass through cables cannot go around a post.
- Flexible conduit is required to turn a post. This only comes as 17"w. If panels at the posts do not all have power distribution housings, they must be added even if duplexes are not specified.
- To calculate the length of a Pass-Through Cable, add the widths of the non-powered panels separating the powered panels (panels with distribution housing attached). To this add 16" (distance from the edge of the panel to the distribution housing x 2).
- Add additional 3" when passing through a corner post.

| PRODUCT CODE | PRICE | SIZE/INCHES | | | WEIGHT VOL | |
|--------------|-------|-------------|-------|-----|------------|-----------------|
| | | H | W | D | LBS | FT ³ |
| CE8CP40 | 164 | 2 | 40.5 | 0.5 | 1.44 | 1.17 |
| CE8CP46 | 169 | 2 | 46.5 | 0.5 | 1.71 | 1.17 |
| CE8CP52 | 177 | 2 | 52.5 | 0.5 | 1.95 | 1.17 |
| CE8CP58 | 188 | 2 | 58.5 | 0.5 | 2.21 | 1.17 |
| CE8CP64 | 196 | 2 | 64.5 | 0.5 | 2.37 | 1.17 |
| CE8CP70 | 200 | 2 | 70.5 | 0.5 | 2.60 | 1.17 |
| CE8CP76 | 204 | 2 | 76.5 | 0.5 | 2.81 | 1.17 |
| CE8CP82 | 213 | 2 | 82.5 | 0.5 | 3.03 | 1.17 |
| CE8CP88 | 220 | 2 | 88.5 | 0.5 | 3.05 | 1.17 |
| CE8CP94 | 228 | 2 | 94.5 | 0.5 | 3.30 | 1.17 |
| CE8CP100 | 233 | 2 | 100.5 | 0.5 | 3.47 | 1.17 |
| CE8CP106 | 243 | 2 | 106.5 | 0.5 | 3.87 | 1.17 |
| CE8CP118 | 257 | 2 | 118.5 | 0.5 | 4.08 | 1.17 |
| CE8CP130 | 281 | 2 | 130.5 | 0.5 | 4.73 | 1.17 |
| CE8CP142 | 293 | 2 | 142.5 | 0.5 | 4.99 | 1.17 |

CE8CI • "I" Connector

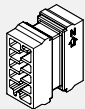

- Female - Female connector connects two Pass-Through Cables .
- Connects 17" Flexible Jumper Cable or ceiling feeds to pass through cables.

| PRODUCT CODE | PRICE | SIZE/INCHES | | | WEIGHT VOL | |
|--------------|-------|-------------|-----|-------|------------|-----------------|
| | | H | W | D | LBS | FT ³ |
| CE8CI1 | 81 | 1.5 | 1.5 | 4.625 | 0.06 | 0.03 |

CE8RD • Duplex Receptacle

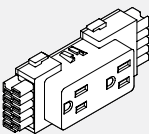

- Up to 6 receptacles per circuit.
- Duplex Receptacles standard in Black (BLK).
- CE8RD1 = Circuit #1 (utility circuit)
- CE8RD2 = Circuit #2 (utility circuit)
- CE8RDA = Circuit A (dedicated)
- CE8RDB = Circuit B (dedicated)
- Note:
- CE8RD1 and CE8RD2 (#1 and #2 share common ground)
- CE8RDA and CE8RDB (A and B share dedicated ground)

| PRODUCT CODE | PRICE | SIZE/INCHES | | | WEIGHT VOL | |
|--------------|-------|-------------|-------|------|------------|-----------------|
| | | H | W | D | LBS | FT ³ |
| CE8RD1 | 35 | 2 | 4.625 | 1.25 | 0.10 | 0.01 |
| CE8RD2 | 35 | 2 | 4.625 | 1.25 | 0.10 | 0.01 |
| CE8RDA | 35 | 2 | 4.625 | 1.25 | 0.10 | 0.01 |
| CE8RDB | 35 | 2 | 4.625 | 1.25 | 0.10 | 0.01 |

CMEUSB • USB Receptacle

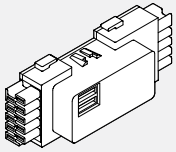

- USB charging module provides convenient charging power access through dual ports on face of the receptacle.
- Two USB ports.
- 2 Amp output via two USB ports.

| PRODUCT CODE | PRICE | SIZE/INCHES | | | WEIGHT VOL | |
|--------------|-------|-------------|-------|------|------------|-----------------|
| | | H | W | D | LBS | FT ³ |
| CMEUSB01WHT | 238 | 2 | 4.625 | 1.25 | 0.10 | 0.01 |
| CMEUSB01BLK | 238 | 2 | 4.625 | 1.25 | 0.10 | 0.01 |

CE8EC • Ceiling Power Entry

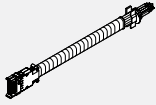

- Snaps into the end of Power Distribution Housing.
- Flexible metal conduit extends into the ceiling through a corner post and post extension (both ordered separately).
- Must be hard wired to source power by a licensed electrician.
- 4" Junction Box included.

| PRODUCT CODE | PRICE | SIZE/INCHES | | | WEIGHT VOL | |
|--------------|-------|-------------|-----|-----|------------|-----------------|
| | | H | L | D | LBS | FT ³ |
| CE8EC1 | 268 | 2 | 132 | 0.5 | 5.24 | 2.00 |
| CE8EC2 | 479 | 2 | 144 | 0.5 | 5.96 | 2.00 |

CE8FR • Base Feed

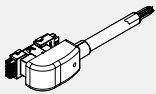

- Takes the place of a duplex receptacle by snapping into the base power way.
- CE8FR1 Includes 72" long flexible metal conduit. CE8FR2 Includes 144" long flexible metal conduit.
- Must be hard wired to source power by a licensed electrician.

| PRODUCT CODE | PRICE | SIZE/INCHES | | | WEIGHT VOL | |
|--------------|-------|-------------|-----|---|------------|-----------------|
| | | H | W | D | LBS | FT ³ |
| CE8FR1 | 353 | 6 | 72 | 3 | 3.82 | 2 |
| CE8FR2 | 454 | 6 | 144 | 3 | 5.96 | 2 |

GCLEDES • Undercabinet LED Task Light

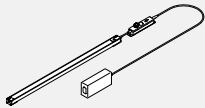

- Linear LED Light.
- Includes light fixture with lens and ON/OFF switch.
 - Magnet mounted with adhesive metal plates.
 - Plug-in power supply with 72" cord length plus 78" DC cord.
- Technical information:
- 4100 K Colour Temperature
 - 90 Colour Rendering Index
 - 30,000 hrs rated Lifespan
 - Total power input per light, 9.0 for 24", 13.5 per 36" and 18.0 for 48"

| PRODUCT CODE | PRICE | SIZE/ | INCHES | | WEIGHT VOL | |
|--------------|-------|-------|--------|---|------------|-----------------|
| | | H | W | D | LBS | FT ³ |
| GCLEDES24 | 164 | 1 | 22.9 | 1 | 2.5 | 0.135 |
| GCLEDES36 | 189 | 1 | 33.5 | 1 | 2.8 | 0.161 |
| GCLEDES48 | 209 | 1 | 45.5 | 1 | 3.2 | 0.213 |

GCLEDES-DCS • Undercabinet Daisychain LED Light

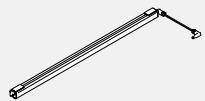

- Undercabinet LED light, 48 inches nominal size, daisychain unit with 1 meter (39 inches) linking cable but no power supply.
- Daisychain units can only be linked up to a total of 48 Watts for all lights on one power supply. This equates to a maximum of 10 feet total nominal length of lights per power supply.

- Technical information:
- 4100 K Colour Temperature
 - 90 Colour Rendering Index
 - 30,000 hrs rated Lifespan
 - Total power input per light, 9.0 for 24", 13.5 per 36" and 18.0 for 48"

| PRODUCT CODE | PRICE | SIZE/ | INCHES | | WEIGHT VOL | |
|--------------|-------|-------|--------|---|------------|-----------------|
| | | H | W | D | LBS | FT ³ |
| GCLEDES24DSC | 134 | 1 | 24 | 1 | 2.5 | 0.135 |
| GCLEDES36DSC | 157 | 1 | 36 | 1 | 2.8 | 0.161 |
| GCLEDES48DSC | 178 | 1 | 48 | 1 | 3.2 | 0.213 |

GCLEDESOS • Occupancy Sensor and Dimmer

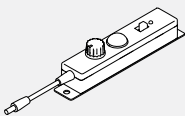

- Inline add-on controller for dimming & occupancy sensor.
- Included, from right to left, a rotary dimmer control, an occupancy sensor and a sensor bypass switch.

| PRODUCT CODE | PRICE | SIZE/ | INCHES | | WEIGHT VOL | |
|--------------|-------|-------|--------|---|------------|-----------------|
| | | H | W | D | LBS | FT ³ |
| GCLEDESOS | 66 | 6 | 2.5 | 2 | 0.4 | 0.500 |

CWS • Rectangular Worksurface

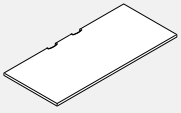

- All tops are thermally fused 1" thick with pilot holes to enable proper alignment with worksurface supports. Wood screws must be used.
- Compile worksurfaces feature a 3mm edge.
- Support hardware must be ordered separately.
- All surfaces longer than 54" have 2 scoops, all others have one.
- Please choose from DWT - Designer White, SIL- Silver or BLK - Black for scoop covers.
- Note: Width and depth dimensions listed include a nominal measurement (3/8") to account for wire management between the worksurface and adjoining panel.

| PRODUCT CODE | PRICE LP | SIZE/INCHES | | | WEIGHT LBS | VOL FT ³ |
|--------------|----------|-------------|----|----|------------|---------------------|
| | | H | W | D | | |
| CWS2424P | 133 | 1 | 24 | 24 | 16 | 0.52 |
| CWS2430P | 145 | 1 | 30 | 24 | 20 | 0.62 |
| CWS2436P | 161 | 1 | 36 | 24 | 23 | 0.78 |
| CWS2442P | 211 | 1 | 42 | 24 | 28 | 0.90 |
| CWS2448P | 252 | 1 | 48 | 24 | 31 | 1.03 |
| CWS2454P | 299 | 1 | 54 | 24 | 35 | 1.20 |
| CWS2460P | 336 | 1 | 60 | 24 | 39 | 1.30 |
| CWS2466P | 350 | 1 | 66 | 24 | 43 | 1.41 |
| CWS2472P | 366 | 1 | 72 | 24 | 47 | 1.54 |
| CWS2478P | 392 | 1 | 78 | 24 | 51 | 1.70 |
| CWS2484P | 422 | 1 | 84 | 24 | 55 | 1.80 |
| CWS2490P | 486 | 1 | 90 | 24 | 58 | 1.96 |
| CWS2496P | 517 | 1 | 96 | 24 | 63 | 2.10 |
| CWS3024P | 159 | 1 | 24 | 30 | 20 | 0.70 |
| CWS3030P | 170 | 1 | 30 | 30 | 25 | 0.97 |
| CWS3036P | 200 | 1 | 36 | 30 | 30 | 1.06 |
| CWS3042P | 283 | 1 | 42 | 30 | 34 | 1.12 |
| CWS3048P | 299 | 1 | 48 | 30 | 39 | 1.30 |
| CWS3054P | 327 | 1 | 54 | 30 | 44 | 1.44 |
| CWS3060P | 350 | 1 | 60 | 30 | 49 | 1.60 |
| CWS3066P | 364 | 1 | 66 | 30 | 54 | 1.80 |
| CWS3072P | 385 | 1 | 72 | 30 | 59 | 2.00 |
| CWS3078P | 410 | 1 | 78 | 30 | 64 | 2.10 |
| CWS3084P | 456 | 1 | 84 | 30 | 69 | 2.24 |

CWSNSCP • Rectangular Worksurface, No Scoops

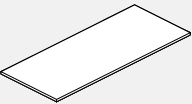

- All tops are thermally fused 1" thick with pilot holes to enable proper alignment with worksurface supports. Wood screws must be used.
- Compile worksurfaces feature a 3mm edge.
- Support hardware must be ordered separately. See the listings in this section.
- All surfaces have no scoops.

| PRODUCT CODE | PRICE LP | SIZE/INCHES | | | WEIGHT LBS | VOL FT ³ |
|--------------|----------|-------------|----|----|------------|---------------------|
| | | H | W | D | | |
| CWS2424NSCP | 133 | 1 | 24 | 24 | 16 | 0.52 |
| CWS2430NSCP | 145 | 1 | 30 | 24 | 20 | 0.62 |
| CWS2436NSCP | 161 | 1 | 36 | 24 | 23 | 0.78 |
| CWS2442NSCP | 211 | 1 | 42 | 24 | 28 | 0.90 |
| CWS2448NSCP | 252 | 1 | 48 | 24 | 31 | 1.03 |
| CWS2454NSCP | 299 | 1 | 54 | 24 | 35 | 1.20 |
| CWS2460NSCP | 336 | 1 | 60 | 24 | 39 | 1.30 |
| CWS2466NSCP | 350 | 1 | 66 | 24 | 43 | 1.41 |
| CWS2472NSCP | 366 | 1 | 72 | 24 | 47 | 1.54 |
| CWS2478NSCP | 392 | 1 | 78 | 24 | 51 | 1.70 |
| CWS2484NSCP | 422 | 1 | 84 | 24 | 55 | 1.80 |
| CWS2490NSCP | 486 | 1 | 90 | 24 | 58 | 1.96 |
| CWS2496NSCP | 517 | 1 | 96 | 24 | 63 | 2.10 |
| CWS3024NSCP | 159 | 1 | 24 | 30 | 20 | 0.70 |
| CWS3030NSCP | 170 | 1 | 30 | 30 | 25 | 0.97 |
| CWS3036NSCP | 200 | 1 | 36 | 30 | 30 | 1.06 |
| CWS3042NSCP | 283 | 1 | 42 | 30 | 34 | 1.12 |
| CWS3048NSCP | 299 | 1 | 48 | 30 | 39 | 1.30 |
| CWS3054NSCP | 327 | 1 | 54 | 30 | 44 | 1.44 |
| CWS3060NSCP | 350 | 1 | 60 | 30 | 49 | 1.60 |
| CWS3066NSCP | 364 | 1 | 66 | 30 | 54 | 1.80 |
| CWS3072NSCP | 385 | 1 | 72 | 30 | 59 | 2.00 |
| CWS3078NSCP | 410 | 1 | 78 | 30 | 64 | 2.10 |
| CWS3084NSCP | 456 | 1 | 84 | 30 | 69 | 2.24 |

CWSP • Worksurface to Span a Post

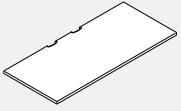

- All tops are thermally fused 1" thick with pilot holes to enable proper alignment with worksurface supports. Wood screws must be used.
- Compile worksurfaces feature a 3mm edge.
- Support hardware must be ordered separately.
- All surfaces longer than 54" have 2 scoops, all others have one.
- Please choose from DWT - Designer White, SIL- Silver or BLK - Black for scoop covers.
- Note: Width and depth dimensions listed include a nominal measurement (3/8") to account for wire management between the worksurface and adjoining panel.

| PRODUCT CODE | PRICE LP | SIZE/INCHES | | | WEIGHT LBS | VOL FT ³ |
|--------------|----------|-------------|----|----|------------|---------------------|
| | | H | W | D | | |
| CWSP2426P | 145 | 1 | 26 | 24 | 17 | 0.60 |
| CWSP2432P | 161 | 1 | 32 | 24 | 21 | 0.70 |
| CWSP2438P | 211 | 1 | 38 | 24 | 25 | 0.83 |
| CWSP2444P | 252 | 1 | 44 | 24 | 29 | 1.00 |
| CWSP2450P | 299 | 1 | 50 | 24 | 33 | 1.10 |
| CWSP2456P | 336 | 1 | 56 | 24 | 37 | 1.22 |
| CWSP2462P | 350 | 1 | 62 | 24 | 41 | 1.34 |
| CWSP2468P | 366 | 1 | 68 | 24 | 45 | 1.47 |
| CWSP2474P | 391 | 1 | 74 | 24 | 49 | 1.60 |
| CWSP2480P | 422 | 1 | 80 | 24 | 53 | 1.73 |
| CWSP2486P | 456 | 1 | 86 | 24 | 57 | 1.90 |
| CWSP3026P | 170 | 1 | 26 | 30 | 22 | 0.72 |
| CWSP3032P | 200 | 1 | 32 | 30 | 27 | 0.88 |
| CWSP3038P | 283 | 1 | 38 | 30 | 32 | 1.04 |
| CWSP3044P | 299 | 1 | 44 | 30 | 37 | 1.20 |
| CWSP3050P | 327 | 1 | 50 | 30 | 41 | 1.40 |
| CWSP3056P | 350 | 1 | 56 | 30 | 46 | 1.51 |
| CWSP3062P | 364 | 1 | 62 | 30 | 51 | 1.67 |
| CWSP3068P | 385 | 1 | 68 | 30 | 56 | 1.83 |
| CWSP3074P | 410 | 1 | 74 | 30 | 61 | 2.00 |
| CWSP3080P | 456 | 1 | 80 | 30 | 66 | 2.20 |
| CWSP3086P | 503 | 1 | 86 | 30 | 70 | 2.30 |

CWVL • Left Curvilinear Worksurface

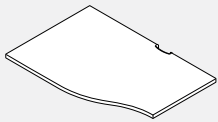

- All tops are thermally fused 1" thick with pilot holes to enable proper alignment with worksurface supports. Wood screws must be used.
- Compile worksurfaces feature a 3mm edge.
- When deepest end equals 24", the opposite depth is 18". When deepest end equals 30", the opposite depth is 24".
- Support hardware must be ordered separately.
- All surfaces longer than 54" have 2 scoops, all others have one.
- Please choose from DWT - Designer White, SIL- Silver or BLK - Black for scoop covers.
- Note: Width and depth dimensions listed include a nominal measurement (3/8") to account for wire management between the worksurface and adjoining panel.

| PRODUCT CODE | PRICE LP | SIZE/INCHES | | | WEIGHT LBS | VOL FT ³ |
|--------------|----------|-------------|----|----|------------|---------------------|
| | | H | W | D | | |
| CWVL2424P | 172 | 1 | 24 | 24 | 15 | 0.59 |
| CWVL2430P | 182 | 1 | 30 | 24 | 18 | 0.65 |
| CWVL2436P | 217 | 1 | 36 | 24 | 22 | 0.78 |
| CWVL2442P | 252 | 1 | 42 | 24 | 26 | 0.90 |
| CWVL2448P | 289 | 1 | 48 | 24 | 30 | 1.03 |
| CWVL2454P | 327 | 1 | 54 | 24 | 34 | 1.20 |
| CWVL2460P | 354 | 1 | 60 | 24 | 38 | 1.30 |
| CWVL2466P | 392 | 1 | 66 | 24 | 43 | 1.49 |
| CWVL2472P | 420 | 1 | 72 | 24 | 47 | 1.62 |
| CWVL2478P | 516 | 1 | 78 | 24 | 57 | 2.16 |
| CWVL2484P | 749 | 1 | 84 | 24 | 61 | 2.33 |
| CWVL3024P | 174 | 1 | 24 | 30 | 19 | 0.74 |
| CWVL3030P | 192 | 1 | 30 | 30 | 23 | 0.81 |
| CWVL3036P | 229 | 1 | 36 | 30 | 28 | 1.00 |
| CWVL3042P | 312 | 1 | 42 | 30 | 33 | 1.13 |
| CWVL3048P | 327 | 1 | 48 | 30 | 38 | 1.30 |
| CWVL3054P | 364 | 1 | 54 | 30 | 42 | 1.44 |
| CWVL3060P | 391 | 1 | 60 | 30 | 47 | 1.60 |
| CWVL3066P | 420 | 1 | 66 | 30 | 52 | 1.81 |
| CWVL3072P | 451 | 1 | 72 | 30 | 59 | 2.01 |
| CWVL3078P | 653 | 1 | 78 | 30 | 72 | 2.71 |
| CWVL3084P | 833 | 1 | 84 | 30 | 77 | 2.91 |

CWVR • Right Curvilinear Worksurface

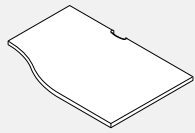

- All tops are thermally fused 1" thick with pilot holes to enable proper alignment with worksurface supports. Wood screws must be used.
- Compile worksurfaces feature a 3mm edge.
- When deepest end equals 24", the opposite depth is 18". When deepest end equals 30", the opposite depth is 24".
- Support hardware must be ordered separately.
- All surfaces longer than 54" have 2 scoops, all others have one.
- Please choose from DWT - Designer White, SIL- Silver or BLK - Black for scoop covers.
- Note: Width and depth dimensions listed include a nominal measurement (3/8") to account for wire management between the worksurface and adjoining panel.

| PRODUCT CODE | PRICE LP | SIZE/INCHES | | | WEIGHT VOL | |
|--------------|----------|-------------|----|----|------------|-----------------|
| | | H | W | D | LBS | FT ³ |
| CWVR2424P | 172 | 1 | 24 | 24 | 15 | 0.59 |
| CWVR2430P | 182 | 1 | 30 | 24 | 18 | 0.65 |
| CWVR2436P | 217 | 1 | 36 | 24 | 22 | 0.78 |
| CWVR2442P | 252 | 1 | 42 | 24 | 26 | 0.90 |
| CWVR2448P | 289 | 1 | 48 | 24 | 30 | 1.03 |
| CWVR2454P | 327 | 1 | 54 | 24 | 34 | 1.20 |
| CWVR2460P | 354 | 1 | 60 | 24 | 38 | 1.30 |
| CWVR2466P | 392 | 1 | 66 | 24 | 43 | 1.49 |
| CWVR2472P | 420 | 1 | 72 | 24 | 47 | 1.62 |
| CWVR2478P | 516 | 1 | 78 | 24 | 57 | 2.16 |
| CWVR2484P | 749 | 1 | 84 | 24 | 61 | 2.33 |
| CWVR3024P | 174 | 1 | 24 | 30 | 19 | 0.74 |
| CWVR3030P | 192 | 1 | 30 | 30 | 23 | 0.81 |
| CWVR3036P | 229 | 1 | 36 | 30 | 28 | 1.00 |
| CWVR3042P | 312 | 1 | 42 | 30 | 33 | 1.13 |
| CWVR3048P | 327 | 1 | 48 | 30 | 38 | 1.30 |
| CWVR3054P | 364 | 1 | 54 | 30 | 42 | 1.44 |
| CWVR3060P | 391 | 1 | 60 | 30 | 47 | 1.60 |
| CWVR3066P | 420 | 1 | 66 | 30 | 52 | 1.81 |
| CWVR3072P | 451 | 1 | 72 | 30 | 59 | 2.01 |
| CWVR3078P | 653 | 1 | 78 | 30 | 72 | 2.71 |
| CWVR3084P | 833 | 1 | 84 | 30 | 77 | 2.91 |

CWBT • Transition Worksurface

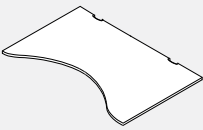

Right Shown

- Support hardware must be ordered separately.
- Please choose from DWT - Designer White, SIL- Silver or BLK - Black for scoop covers.
- Opposing side of the 30" deep surface has a depth of 24"
- Must be specified as right or left handed.

| PRODUCT CODE | PRICE LP | SIZE/INCHES | | | WEIGHT VOL | |
|--------------|----------|-------------|----|----|------------|-----------------|
| | | H | W | D | LBS | FT ³ |
| CWBTL302460P | 614 | 1 | 60 | 30 | 55 | 2.08 |
| CWBTL302466P | 678 | 1 | 66 | 30 | 61 | 2.29 |
| CWBTL302472P | 701 | 1 | 72 | 30 | 66 | 2.50 |
| CWBTR302460P | 614 | 1 | 60 | 30 | 55 | 2.08 |
| CWBTR302466P | 678 | 1 | 66 | 30 | 61 | 2.29 |
| CWBTR302472P | 701 | 1 | 72 | 30 | 66 | 2.50 |

CWCC • Corner Curved Worksurface



- All tops are thermally fused 1" thick with pilot holes to enable proper alignment with worksurface supports. Wood screws must be used.
- Compile worksurfaces feature a 3mm edge.
- Support hardware must be ordered separately.
- Please choose from DWT - Designer White, SIL- Silver or BLK - Black for scoop covers.
- Note: Width and depth dimensions listed include a nominal measurement (3/8") to account for wire management between the worksurface and adjoining panel.
- "WG" indicates diagonal woodgrain.
- "WG" worksurface over 42" cannot be done on the diagonal.

| PRODUCT CODE | PRICE LP | SIZE/INCHES | | | WEIGHT VOL | |
|--------------|----------|-------------|----|----|------------|-----------------|
| | | H | W | D | LBS | FT ³ |
| CWCC3618P | 397 | 1 | 36 | 36 | 29 | 1.20 |
| CWCC3624P | 439 | 1 | 36 | 36 | 32 | 1.20 |
| CWCC3618WGP | 575 | 1 | 36 | 36 | 29 | 1.20 |
| CWCC3624WGP | 740 | 1 | 36 | 36 | 32 | 1.20 |
| CWCC4224P | 591 | 1 | 42 | 42 | 41 | 1.60 |
| CWCC4230P | 607 | 1 | 42 | 42 | 45 | 1.60 |
| CWCC4224WGP | 846 | 1 | 42 | 42 | 41 | 1.60 |
| CWCC4230WGP | 963 | 1 | 42 | 42 | 45 | 1.60 |
| CWCC4824P | 688 | 1 | 48 | 48 | 50 | 2.00 |
| CWCC4830P | 688 | 1 | 48 | 48 | 56 | 2.00 |

CWCF • Five Sided Worksurface

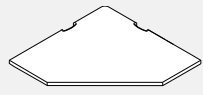

- All tops are thermally fused 1" thick with pilot holes to enable proper alignment with worksurface supports. Wood screws must be used.
- Compile worksurfaces feature a 3mm edge.
- Support hardware must be ordered separately.
- Please choose from DWT - Designer White, SIL- Silver or BLK - Black for scoop covers.
- Note: Width and depth dimensions listed include a nominal measurement (3/8") to account for wire management between the worksurface and adjoining panel.
- "WG" indicates diagonal woodgrain.
- "WG" worksurface over 42" cannot be done on the diagonal.

| PRODUCT CODE | PRICE LP | SIZE/INCHES | | | WEIGHT VOL | |
|--------------|----------|-------------|----|----|------------|-----------------|
| | | H | W | D | LBS | FT ³ |
| CWCF3618P | 341 | 1 | 36 | 36 | 29 | 1.20 |
| CWCF3624P | 354 | 1 | 36 | 36 | 32 | 1.20 |
| CWCF3618WGP | 563 | 1 | 36 | 36 | 29 | 1.20 |
| CWCF3624WGP | 621 | 1 | 36 | 36 | 32 | 1.20 |
| CWCF4224P | 503 | 1 | 42 | 42 | 41 | 1.60 |
| CWCF4230P | 517 | 1 | 42 | 42 | 45 | 1.60 |
| CWCF4224WGP | 835 | 1 | 42 | 42 | 41 | 1.60 |
| CWCF4230WGP | 911 | 1 | 42 | 42 | 45 | 1.60 |
| CWCF4824P | 567 | 1 | 48 | 48 | 50 | 2.00 |
| CWCF4830P | 596 | 1 | 48 | 48 | 56 | 2.00 |

CWC6 • Corner Curved Worksurface for 60° post

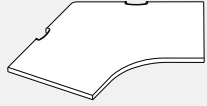

- When specifying wood grain laminate for worksurfaces 42" wide or less, grain will be run diagonally.
- Please add "WG" to the end of the product code and add 50% upcharge to the list price.
- Support hardware must be ordered separately.
- Please choose from DWT - Designer White, SIL- Silver or BLK - Black for scoop covers.

| PRODUCT CODE | PRICE LP | SIZE/INCHES | | | WEIGHT VOL | |
|--------------|----------|-------------|----|----|------------|------|
| | | H | W | D | LBS | FT³ |
| CWC62424P | 399 | 1 | 24 | 24 | 21.25 | 0.47 |
| CWC62430P | 709 | 1 | 30 | 24 | 28.59 | 0.64 |
| CWC62436P | 800 | 1 | 36 | 24 | 35.94 | 0.80 |
| CWC62442P | 1223 | 1 | 42 | 24 | 43.28 | 0.96 |
| CWC62448P | 1330 | 1 | 48 | 24 | 50.63 | 1.13 |
| CWC63024P | 399 | 1 | 24 | 30 | 23.72 | 0.53 |
| CWC63030P | 709 | 1 | 30 | 30 | 32.94 | 0.73 |
| CWC63036P | 800 | 1 | 36 | 30 | 42.16 | 0.94 |
| CWC63042P | 1223 | 1 | 42 | 30 | 51.38 | 1.14 |
| CWC63048P | 1330 | 1 | 48 | 30 | 60.60 | 1.35 |

CWCEL • Extended Curved Corner Left

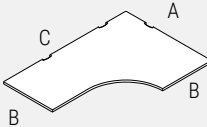

- For 48" wide ("C" dimension) worksurfaces, there are two cable scoops, all others have three.
- All tops are thermally fused 1" thick with pilot holes to enable proper alignment with worksurface supports. Wood screws must be used.
- Compile worksurfaces feature a 3mm edge.
- Support hardware must be ordered separately.
- Please choose from DWT - Designer White, SIL- Silver or BLK - Black for scoop covers.
- Note: Width and depth dimensions listed include a nominal measurement (3/8") to account for wire management between the worksurface and adjoining panel.

NOTE: CWCEL

| A | B | C |
|-------|-------|-------|
| DEPTH | DEPTH | WIDTH |

| PRODUCT CODE | PRICE LP | SIZE/INCHES | | | WEIGHT VOL | |
|--------------|----------|-------------|------|------|------------|------|
| | | H | W"C" | D"A" | LBS | FT³ |
| CWCEL362448P | 600 | 1 | 48 | 36 | 43.92 | 1.25 |
| CWCEL362460P | 655 | 1 | 60 | 36 | 52.79 | 1.50 |
| CWCEL362466P | 721 | 1 | 66 | 36 | 57.18 | 1.62 |
| CWCEL362472P | 796 | 1 | 72 | 36 | 61.58 | 1.75 |
| CWCEL362478P | 850 | 1 | 78 | 36 | 65.98 | 1.87 |
| CWCEL362484P | 917 | 1 | 84 | 36 | 70.38 | 2.00 |
| CWCEL422460P | 688 | 1 | 60 | 42 | 57.18 | 1.63 |
| CWCEL422466P | 758 | 1 | 66 | 42 | 61.58 | 1.57 |
| CWCEL422472P | 835 | 1 | 72 | 42 | 65.98 | 1.87 |
| CWCEL422478P | 893 | 1 | 78 | 42 | 70.38 | 2.00 |
| CWCEL422484P | 962 | 1 | 84 | 42 | 74.78 | 2.00 |
| CWCEL423060P | 775 | 1 | 60 | 42 | 63.78 | 1.82 |
| CWCEL423066P | 850 | 1 | 66 | 42 | 69.28 | 1.96 |
| CWCEL423072P | 929 | 1 | 72 | 42 | 74.78 | 2.12 |
| CWCEL423078P | 996 | 1 | 78 | 42 | 80.28 | 2.28 |
| CWCEL423084P | 1062 | 1 | 84 | 42 | 85.78 | 2.43 |
| CWCEL482460P | 786 | 1 | 60 | 48 | 65.18 | 1.90 |
| CWCEL482466P | 874 | 1 | 66 | 48 | 71.39 | 1.92 |
| CWCEL482472P | 956 | 1 | 72 | 48 | 76.18 | 1.95 |
| CWCEL482478P | 1021 | 1 | 78 | 48 | 74.78 | 2.20 |
| CWCEL482484P | 1083 | 1 | 84 | 48 | 96.78 | 3.66 |
| CWCEL483060P | 874 | 1 | 60 | 48 | 68.18 | 1.93 |
| CWCEL483066P | 956 | 1 | 66 | 48 | 73.68 | 2.09 |
| CWCEL483072P | 1021 | 1 | 72 | 48 | 79.18 | 2.25 |
| CWCEL483078P | 1083 | 1 | 78 | 48 | 84.68 | 2.40 |
| CWCEL483084P | 1158 | 1 | 84 | 48 | 90.18 | 2.56 |

CWCER • Extended Curved Corner Right

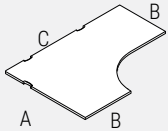

- For 48" wide ("C" dimension) worksurfaces, there are two cable scoops, all others have three.
- All tops are thermally fused 1" thick with pilot holes to enable proper alignment with worksurface supports. Wood screws must be used.
- Compile worksurfaces feature a 3mm edge.
- Support hardware must be ordered separately.
- Please choose from DWT - Designer White, SIL- Silver or BLK - Black for scoop covers.
- Note: Width and depth dimensions listed include a nominal measurement (3/8") to account for wire management between the worksurface and adjoining panel.

NOTE: CWCER

| A | B | C |
|-------|-------|-------|
| DEPTH | DEPTH | WIDTH |

| PRODUCT CODE | PRICE LP | SIZE/INCHES | | | WEIGHT LBS | VOL FT ³ |
|--------------|----------|-------------|------|------|------------|---------------------|
| | | H | W"C" | D"A" | | |
| CWCER362448P | 600 | 1 | 48 | 36 | 43.92 | 1.25 |
| CWCER362460P | 655 | 1 | 60 | 36 | 52.79 | 1.50 |
| CWCER362466P | 721 | 1 | 66 | 36 | 57.18 | 1.62 |
| CWCER362472P | 796 | 1 | 72 | 36 | 61.58 | 1.75 |
| CWCER362478P | 850 | 1 | 78 | 36 | 65.98 | 1.87 |
| CWCER362484P | 917 | 1 | 84 | 36 | 70.38 | 2.00 |
| CWCER422460P | 688 | 1 | 60 | 42 | 57.18 | 1.63 |
| CWCER422466P | 758 | 1 | 66 | 42 | 61.58 | 1.57 |
| CWCER422472P | 835 | 1 | 72 | 42 | 65.98 | 1.87 |
| CWCER422478P | 893 | 1 | 78 | 42 | 70.38 | 2.00 |
| CWCER422484P | 962 | 1 | 84 | 42 | 74.78 | 2.00 |
| CWCER423060P | 775 | 1 | 60 | 42 | 63.78 | 1.82 |
| CWCER423066P | 850 | 1 | 66 | 42 | 69.28 | 1.96 |
| CWCER423072P | 929 | 1 | 72 | 42 | 74.78 | 2.12 |
| CWCER423078P | 996 | 1 | 78 | 42 | 80.28 | 2.28 |
| CWCER423084P | 1062 | 1 | 84 | 42 | 85.78 | 2.43 |
| CWCER482460P | 786 | 1 | 60 | 48 | 65.18 | 1.90 |
| CWCER482466P | 874 | 1 | 66 | 48 | 71.39 | 1.92 |
| CWCER482472P | 956 | 1 | 72 | 48 | 76.18 | 1.95 |
| CWCER482478P | 1021 | 1 | 78 | 48 | 74.78 | 2.20 |
| CWCER482484P | 1083 | 1 | 84 | 48 | 96.78 | 3.66 |
| CWCER483060P | 874 | 1 | 60 | 48 | 68.18 | 1.93 |
| CWCER483066P | 956 | 1 | 66 | 48 | 73.68 | 2.09 |
| CWCER483072P | 1021 | 1 | 72 | 48 | 79.18 | 2.25 |
| CWCER483078P | 1083 | 1 | 78 | 48 | 84.68 | 2.40 |
| CWCER483084P | 1158 | 1 | 84 | 48 | 90.18 | 2.56 |

CWD • "D" Worksurface

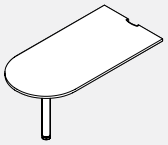

- Includes Monoleg available in standard compile finishes.
- All tops are thermally fused 1" thick with pilot holes to enable proper alignment with worksurface supports. Wood screws must be used.
- Compile worksurfaces feature a 3mm edge.
- Support hardware must be ordered separately. See the listings in this section.
- Please choose from DWT - Designer White, SIL- Silver or BLK - Black for scoop covers.
- Note: Width and depth dimensions listed include a nominal measurement (3/8") to account for wire management between the worksurface and adjoining panel.

| PRODUCT CODE | PRICE LP | SIZE/INCHES | | | WEIGHT LBS | VOL FT ³ |
|--------------|----------|-------------|----|----|------------|---------------------|
| | | H | W | D | | |
| CWD2442P | 569 | 1 | 42 | 24 | 28.00 | 0.98 |
| CWD2448P | 593 | 1 | 48 | 24 | 32.00 | 1.11 |
| CWD2460P | 623 | 1 | 60 | 24 | 40.00 | 1.36 |
| CWD2472P | 661 | 1 | 72 | 24 | 48.00 | 1.61 |
| CWD3042P | 573 | 1 | 42 | 30 | 35.00 | 1.10 |
| CWD3048P | 596 | 1 | 48 | 30 | 39.00 | 1.37 |
| CWD3060P | 665 | 1 | 60 | 30 | 49.00 | 1.69 |
| CWD3072P | 731 | 1 | 72 | 30 | 59.00 | 2.01 |

CWSW • Straight Wedge Worksurface

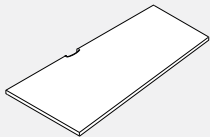

- All tops are thermally fused 1" thick with pilot holes to enable proper alignment with worksurface supports. Wood screws must be used.
- Compile worksurfaces feature a 3mm edge.
- Support hardware must be ordered separately.
- All surfaces longer than 48" have 2 scoops, all others have one.
- Please choose from DWT - Designer White, SIL- Silver or BLK - Black for scoop covers.
- Note: Width and depth dimensions listed include a nominal measurement (3/8") to account for wire management between the worksurface and adjoining panel.

| PRODUCT CODE | PRICE LP | SIZE/INCHES | | | WEIGHT LBS | VOL FT ³ |
|--------------|----------|-------------|----|----|------------|---------------------|
| | | H | W | D | | |
| CWSW241848P | 286 | 1 | 48 | 24 | 30.00 | 0.58 |
| CWSW241854P | 320 | 1 | 54 | 24 | 34.00 | 0.65 |
| CWSW241860P | 354 | 1 | 60 | 24 | 38.00 | 0.73 |
| CWSW241866P | 392 | 1 | 66 | 24 | 42.00 | 0.80 |
| CWSW241872P | 430 | 1 | 72 | 24 | 46.00 | 0.88 |
| CWSW302448P | 354 | 1 | 48 | 30 | 38.00 | 0.75 |
| CWSW302454P | 404 | 1 | 54 | 30 | 42.00 | 0.84 |
| CWSW302460P | 448 | 1 | 60 | 30 | 47.00 | 0.94 |
| CWSW302466P | 490 | 1 | 66 | 30 | 51.00 | 1.03 |
| CWSW302472P | 537 | 1 | 72 | 30 | 56.00 | 1.13 |
| CWSW182448P | 286 | 1 | 48 | 24 | 30.00 | 0.58 |
| CWSW182454P | 320 | 1 | 54 | 24 | 34.00 | 0.65 |
| CWSW182460P | 354 | 1 | 60 | 24 | 38.00 | 0.73 |
| CWSW182466P | 392 | 1 | 66 | 24 | 42.00 | 0.80 |
| CWSW182472P | 430 | 1 | 72 | 24 | 46.00 | 0.88 |
| CWSW243048P | 354 | 1 | 48 | 30 | 38.00 | 0.75 |
| CWSW243054P | 404 | 1 | 54 | 30 | 42.00 | 0.84 |
| CWSW243060P | 448 | 1 | 60 | 30 | 47.00 | 0.94 |
| CWSW243066P | 490 | 1 | 66 | 30 | 51.00 | 1.03 |
| CWSW243072P | 537 | 1 | 72 | 30 | 56.00 | 1.13 |

CWSW-NSCP • Straight Wedge Worksurface

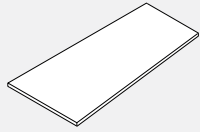

- All tops are thermally fused 1" thick with pilot holes to enable proper alignment with worksurface supports. Wood screws must be used.
- Compile worksurfaces feature a 3mm edge.
- Support hardware must be ordered separately. See the listings in this section.
- All worksurfaces have no scoops.

| PRODUCT CODE | PRICE LP | SIZE/INCHES | | | WEIGHT VOL | |
|----------------|----------|-------------|----|----|------------|-----------------|
| | | H | W | D | LBS | FT ³ |
| CWSW241848NSCP | 286 | 1 | 48 | 24 | 30.00 | 0.58 |
| CWSW241854NSCP | 320 | 1 | 54 | 24 | 34.00 | 0.65 |
| CWSW241860NSCP | 354 | 1 | 60 | 24 | 38.00 | 0.73 |
| CWSW241866NSCP | 392 | 1 | 66 | 24 | 42.00 | 0.80 |
| CWSW241872NSCP | 430 | 1 | 72 | 24 | 46.00 | 0.88 |
| CWSW302448NSCP | 354 | 1 | 48 | 30 | 38.00 | 0.75 |
| CWSW302454NSCP | 404 | 1 | 54 | 30 | 42.00 | 0.84 |
| CWSW302460NSCP | 448 | 1 | 60 | 30 | 47.00 | 0.94 |
| CWSW302466NSCP | 490 | 1 | 66 | 30 | 51.00 | 1.03 |
| CWSW302472NSCP | 537 | 1 | 72 | 30 | 56.00 | 1.13 |
| CWSW182448NSCP | 286 | 1 | 48 | 24 | 30.00 | 0.58 |
| CWSW182454NSCP | 320 | 1 | 54 | 24 | 34.00 | 0.65 |
| CWSW182460NSCP | 354 | 1 | 60 | 24 | 38.00 | 0.73 |
| CWSW182466NSCP | 392 | 1 | 66 | 24 | 42.00 | 0.80 |
| CWSW182472NSCP | 430 | 1 | 72 | 24 | 46.00 | 0.88 |
| CWSW243048NSCP | 354 | 1 | 48 | 30 | 38.00 | 0.75 |
| CWSW243054NSCP | 404 | 1 | 54 | 30 | 42.00 | 0.84 |
| CWSW243060NSCP | 448 | 1 | 60 | 30 | 47.00 | 0.94 |
| CWSW243066NSCP | 490 | 1 | 66 | 30 | 51.00 | 1.03 |
| CWSW243072NSCP | 537 | 1 | 72 | 30 | 56.00 | 1.13 |

CWHL/R • Hatchet Worksurface

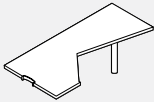

Right Shown

- Wood grain laminate not available on the diagonal.
- Must be specified either left or right.
- Includes Monoleg, available in standard compile finishes.
- Please choose from DWT - Designer White, SIL- Silver or BLK - Black for scoop covers.

| PRODUCT CODE | PRICE LP | | SIZE/INCHES | | | WEIGHT VOL | |
|--------------|----------|-------|-------------|----|----|------------|-----------------|
| | | | H | W | D | LBS | FT ³ |
| CWHL3672P | 1079 | Left | 1 | 72 | 36 | 73.00 | 2.70 |
| CWHR3672P | 1079 | Right | 1 | 72 | 36 | 73.00 | 2.70 |

CWQRL/R • Quarter Round Worksurface



Left Shown

- The worksurface edge running along the panel face is a slightly different length than that of the worksurface end, causing the surface to be handed.
- The user edge abutting the adjacent worksurface runs straight for 2" before starting to curve.

| PRODUCT CODE | PRICE LP | | SIZE/INCHES | | | WEIGHT VOL | |
|--------------|----------|-------|-------------|----|----|------------|-----------------|
| | | | H | W | D | LBS | FT ³ |
| CWQRL2424 | 200 | Left | 1 | 24 | 24 | 16 | 0.52 |
| CWQRL3030 | 259 | | 1 | 30 | 30 | 25 | 0.81 |
| CWQRR2424 | 200 | Right | 1 | 24 | 24 | 16 | 0.52 |
| CWQRR3030 | 259 | | 1 | 30 | 30 | 25 | 0.81 |

CWQRC • Quarter Round Corner Worksurface

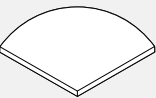

- Wraps around a 90° corner post.
- Putting the adjacent worksurface runs straight for 3" before starting to curve.
- Note: Width and depth dimensions listed include a nominal measurement (3/8") to account for wire management between the worksurface and adjoining panel.

| PRODUCT CODE | PRICE LP | SIZE/INCHES | | | WEIGHT VOL | |
|--------------|----------|-------------|----|----|------------|-----------------|
| | | H | W | D | LBS | FT ³ |
| CWQRC2424 | 235 | 1 | 24 | 24 | 17.00 | 0.58 |
| CWQRC3030 | 289 | 1 | 30 | 30 | 25.50 | 0.86 |

CWT • Straight Transaction Worksurface

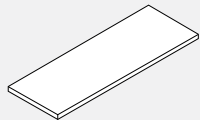

- Support hardware must be ordered separately.
- All tops are thermally fused 1" thick with pilot holes to enable proper alignment with worksurface supports. Wood screws must be used.
- Compile worksurfaces feature a 3mm edge.

| PRODUCT CODE | PRICE LP | SIZE/INCHES | | | WEIGHT VOL | |
|--------------|----------|-------------|----|----|------------|-----------------|
| | | H | W | D | LBS | FT ³ |
| CWT1512 | 57 | 1 | 12 | 15 | 5 | 0.22 |
| CWT1518 | 69 | 1 | 18 | 15 | 7 | 0.30 |
| CWT1524 | 90 | 1 | 24 | 15 | 10 | 0.38 |
| CWT1530 | 106 | 1 | 30 | 15 | 12 | 0.46 |
| CWT1536 | 123 | 1 | 36 | 15 | 14 | 0.54 |
| CWT1542 | 139 | 1 | 42 | 15 | 17 | 0.62 |
| CWT1548 | 157 | 1 | 48 | 15 | 19 | 0.70 |
| CWT1554 | 170 | 1 | 54 | 15 | 22 | 0.78 |
| CWT1560 | 190 | 1 | 60 | 15 | 24 | 0.86 |
| CWT1566 | 204 | 1 | 66 | 15 | 28 | 0.94 |
| CWT1572 | 221 | 1 | 72 | 15 | 29 | 1.02 |
| CWT1578 | 238 | 1 | 78 | 15 | 31 | 1.10 |
| CWT1584 | 253 | 1 | 84 | 15 | 34 | 1.18 |

CWTCL90 • “L” Corner Transaction Surface

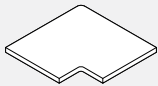

- Used where two panels meet at a 90° angle.
- Support hardware must be ordered separately.

| PRODUCT CODE | PRICE | SIZE/INCHES | | | WEIGHT VOL | |
|--------------|-------|-------------|------|----|------------|------|
| | | H | W | D | LBS | FT³ |
| CWTCL90 | 159 | 1 | 20.7 | 15 | 12.00 | 0.75 |

CW9T • Corner Transaction Surface for 90° Post

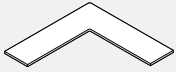

- Used where two panels meet at a 90° angle.
- Support hardware must be ordered separately.

Note: CW9T15 xx

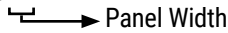

| PRODUCT CODE | PRICE | SIZE/INCHES | | | WEIGHT VOL | |
|--------------|-------|-------------|------|----|------------|------|
| | | H | W | D | LBS | FT³ |
| CW9T1524 | 168 | 1 | 32.7 | 15 | 10.00 | 0.70 |
| CW9T1530 | 265 | 1 | 38.7 | 15 | 12.00 | 0.75 |
| CW9T1536 | 373 | 1 | 44.7 | 15 | 14.00 | 0.82 |
| CW9T1542 | 509 | 1 | 50.7 | 15 | 16.00 | 0.95 |
| CW9T1548 | 665 | 1 | 56.7 | 15 | 18.00 | 1.00 |

CHMSL1 • Round Mid Support Leg

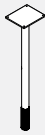

- Available in standard compile standard panel frame colours.
- Includes levelling glide, PVC sleeve and 4.8" x 4.8" plate.
- 1.5" diameter.

| PRODUCT CODE | PRICE | LEG DIAMETER | SIZE/INCHES | | | WEIGHT VOL | |
|--------------|-------|--------------|-------------|-----|-----|------------|------|
| | | | H | W | D | LBS | FT³ |
| CHMSL1 | 77 | 1.5 | 28 | 4.8 | 4.8 | 8 | 0.15 |

CHMSL2 • Square Mid Support Leg

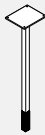

- Available in standard compile standard panel frame colours.
- Includes levelling glide, PVC sleeve and 4.8" x 4.8" plate.

| PRODUCT CODE | PRICE | LEG SIZE | SIZE/INCHES | | | WEIGHT VOL | |
|--------------|-------|----------|-------------|-----|-----|------------|------|
| | | | H | W | D | LBS | FT³ |
| CHMSL2 | 77 | 1.5 | 28 | 4.8 | 4.8 | 8 | 0.15 |

BHML • Monoleg



- Provides support for a worksurface.
- Includes an adjustable foot and an attachment plate.
- 3" diameter.
- 1" Height adjustment range.

| PRODUCT CODE | PRICE | LEG DIAMETER | SIZE/INCHES | | | WEIGHT VOL | |
|--------------|-------|--------------|-------------|---|---|------------|------|
| | | | H | W | D | LBS | FT³ |
| BHML03 | 207 | 3 | 28 | 3 | 3 | 8 | 0.15 |

CMHCL1 • Round Corner Leg With Leveler



- Provides support for worksurface.
- Includes levelling glide, PVC Sleeve and attachment plate.
- 1.5" diameter.
- Available in standard paint colours.
- Legs can be used in the corner of a single worksurface or be rotated 45 degrees to support the corners of two worksurfaces.

| PRODUCT CODE | PRICE | LEG DIAMETER | SIZE/INCHES | | | WEIGHT VOL | |
|--------------|-------|--------------|-------------|---|---|------------|------|
| | | | H | W | D | LBS | FT³ |
| CMHCL1 | 108 | 1.5 | 28 | 3 | 3 | 8 | 0.15 |

CMHCL2 • Square Corner Leg With Leveler



- Provides support for worksurface.
- Includes levelling glide, PVC Sleeve and attachment plate.
- 1.5" diameter.
- Available in standard paint colours.
- Legs can be used in the corner of a single worksurface or be rotated 45 degrees to support the corners of two worksurfaces.

| PRODUCT CODE | PRICE | LEG DIAMETER | SIZE/INCHES | | | WEIGHT VOL | |
|--------------|-------|--------------|-------------|---|---|------------|------|
| | | | H | W | D | LBS | FT³ |
| CMHCL2 | 108 | 1.5 | 28 | 3 | 3 | 8 | 0.15 |

CHC • Cantilever



- CHC15 come with wood screws and 3 hole slider, while CHC22 comes with wood screws & 4 hole slider.
- Corresponding panel frame colours only.
- Cantilevers do not share support.

| PRODUCT CODE | PRICE | SIZE/INCHES | | | WEIGHT VOL | |
|--------------|-------|-------------|-----|------|------------|------|
| | | H | W | D | LBS | FT³ |
| CHC15L | 48 | 5 | 1.2 | 15.2 | 2 | 0.04 |
| CHC15R | 48 | 5 | 1.2 | 15.2 | 2 | 0.04 |
| CHC22L | 80 | 8 | 1.2 | 21.5 | 2.6 | 0.06 |
| CHC22R | 80 | 8 | 1.2 | 21.5 | 2.6 | 0.06 |

CHCB2 • Corner and Transaction Bracket

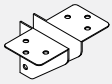

- Attaches the corner of any worksurface to a panel connector.
- Priced and shipped in pairs.
- Available in Standard paint colours.
- Cannot be used off modular.
- Comes with a 2 hole slider.

| PRODUCT CODE | PRICE | SIZE/INCHES | | | WEIGHT LBS | VOL FT ³ |
|--------------|-------|-------------|------|---|------------|---------------------|
| | | H | W | D | | |
| CHCB2 | 22 | 3 | 1.81 | 3 | 0.5 | 0.02 |

CH • Worksurface Bracket

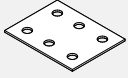

- Black (BLK) only

| PRODUCT CODE | PRICE | SIZE/INCHES | | | WEIGHT LBS | VOL FT ³ | |
|--------------|-------|--------------|-----|---|------------|---------------------|-------|
| | | H | W | D | | | |
| CHFB1 | 21 | Flat Bracket | 0.1 | 3 | 4 | 0.5 | 0.007 |

CHWB • Mid Span Bracket



- Attaches to a segmented panel.
- Must be specified with a worksurface longer than 48".
- Zinc finish only.

| PRODUCT CODE | PRICE | SIZE/INCHES | | | WEIGHT LBS | VOL FT ³ |
|--------------|-------|-------------|-----|-----|------------|---------------------|
| | | H | W | D | | |
| CHWB1 | 13 | 0.5 | 2.8 | 2.1 | 0.5 | 0.02 |

DHPEDB • Pedestal Bracket



- Available in standard paint colours.
- Attaches pedestal to panel and end panel.

| PRODUCT CODE | PRICE | SIZE/INCHES | | | WEIGHT LBS | VOL FT ³ |
|--------------|-------|-------------|---|---|------------|---------------------|
| | | H | W | D | | |
| DHPEDB | 36 | 8 | 1 | 1 | 0.5 | 0.001 |

CHEP • End Panel

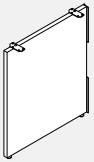

- Supports the worksurface and enhances the stability of connected panels.
- Provides solid support at the end of a run of worksurfaces.
- Finished in thermally-fused laminate.
- End panel height is inclusive of panel glides extended to their fullest height.
- Includes 2 flat brackets (black), 2 pedestal brackets (frame colour) and required screws.
- If wood grains is selected, grain runs vertically.
- Note: May be used as a shared gable between two adjoining worksurfaces.

| PRODUCT CODE | PRICE | SIZE/ INCHES | | | WEIGHT LBS | VOL FT ³ |
|--------------|-------|--------------|---|----|------------|---------------------|
| | | H | W | D | | |
| CHEP2924 | 239 | 28 | 1 | 24 | 17 | 0.40 |
| CHEP2930 | 280 | 28 | 1 | 30 | 21 | 0.50 |

CHWSRL01 • Worksurface round Support Leg

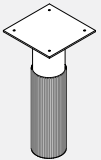

- Provides supports when worksurface overhangs 21" Double Wall Storage or 1.5H 1200 Series Cabinet Storage must have File Top.
- Must be used to support the worksurface in conjunction with panel mounted hardware.
- Contains a levelling glide and PVC sleeve.
- 1.5 diameter round tube.
- Available in BLK (Black) only

| PRODUCT CODE | PRICE | SIZE/ | INCHES | | WEIGHT VOL | |
|--------------|-------|-------|--------|---|------------|-----------------|
| | | H | W | D | LBS | FT ³ |
| CHWSRL01 | 46 | 4.5 | 3 | 3 | 1.00 | 0.03 |

CHMEGR • Metal End Gable Round Leg, Non-handed

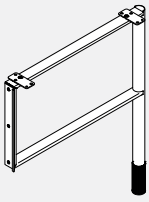

Left Assembly Shown

- **Metal End Gable Leg supports the worksurface and enhances the stability of connected panels.**
- Includes a leveling glide and decorative PVC sleeve to cover the glide.
- Attached to Compile panel connectors. The mounting bracket is universal and attaches with screws to the back of the leg.
- Please specify standard paint finish.
- Non-handed, can be adjusted to left or right handed application.
- NOTE: Cannot be used to support worksurfaces side by side. Please use EVHMSRL12 for supporting adjoining worksurfaces.

| PRODUCT CODE | PRICE | SIZE/INCHES | | | WEIGHT LBS | VOL FT ³ |
|--------------|-------|-------------|---|----|------------|---------------------|
| | | H | W | D | | |
| CHMEGR24 | 173 | 29 | 2 | 23 | 6.00 | 0.73 |
| CHMEGR30 | 185 | 29 | 2 | 29 | 6.80 | 0.90 |

CHMSRL • Metal Mid Support Round Leg, Non-handed

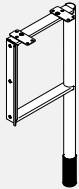

Left Assembly Shown

- **Metal Mid Support Leg supports two adjoining worksurfaces and enhances the stability of connected panels.**
- Includes a leveling glide and decorative PVC sleeve to cover the glide.
- Attached to Compile Panels.
- Please specify standard paint finish.
- Non-handed, can be adjusted to left or right handed application.

| PRODUCT CODE | PRICE | SIZE/INCHES | | | WEIGHT LBS | VOL FT ³ |
|--------------|-------|-------------|---|----|------------|---------------------|
| | | H | W | D | | |
| CHMSRL12 | 149 | 29 | 2 | 11 | 4.60 | 0.36 |

CHMEGS • Metal End Gable Square Leg, Non-handed

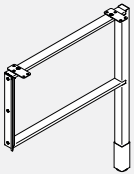

Left Assembly Shown

- **Metal End Gable Leg supports the worksurface and enhances the stability of connected panels.**
- Includes a leveling glide and decorative PVC sleeve to cover the glide.
- Attached to Compile panel connectors. The mounting bracket is universal and attaches with screws to the back of the leg.
- Please specify standard paint finish.
- Non-handed, can be adjusted to left or right handed application.
- NOTE: Cannot be used to support worksurfaces side by side. Please use EVHMSL12 for supporting adjoining worksurfaces.

| PRODUCT CODE | PRICE | SIZE/INCHES | | | WEIGHT LBS | VOL FT ³ |
|--------------|-------|-------------|---|----|------------|---------------------|
| | | H | W | D | | |
| CHMEGS24 | 177 | 29 | 2 | 23 | 6.00 | 0.73 |
| CHMEGS30 | 188 | 29 | 2 | 29 | 6.80 | 0.90 |

CHMSSL • Metal Mid Support Square Leg, Non-handed

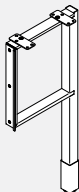

Left Assembly Shown

- **Metal Mid Support Leg supports two adjoining worksurfaces and enhances the stability of connected panels.**
- Includes a leveling glide and decorative PVC sleeve to cover the glide.
- Attached to Compile Panels.
- Please specify standard paint finish.
- Non-handed, can be adjusted to left or right handed application.

| PRODUCT CODE | PRICE | SIZE/INCHES | | | WEIGHT LBS | VOL FT ³ |
|--------------|-------|-------------|---|----|------------|---------------------|
| | | H | W | D | | |
| CHMSSL12 | 152 | 29 | 2 | 11 | 4.60 | 0.36 |

CMHLEG • Compile Bridges Leg Assembly

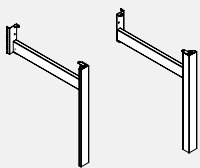

- **Compile Bridges Leg Assembly attaches to a Compile panel for applications which require functionality of Compile panels with an open environment of Bridges tables.**
- One leg with horizontal member connecting to 1" increment slots in panel's vertical frame member. Provides support to panel and panel-connected worksurface at the end of a run; design coordinated with Bridges freestanding tables.
- Supports 24" and 30" deep worksurfaces. By adding 2 CHFB1 flat brackets and 1 CHCB2 corner bracket, a single leg can then support the adjoining worksurface. Leveling glide is standard. No worksurface supporting beams, use panel cantilevers and storage for worksurface support. One aluminum leg with steel structure - specify Left or Right and 24" or 30" deep for corresponding worksurface depths. Panel bracket, dislodgment clip and worksurface hardware included.
- Anodized aluminum leg upcharge \$23.
- Please specify paint finish for support.

| PRODUCT CODE | PRICE | SIZE/INCHES | | | WEIGHT LBS | VOL FT ³ |
|--------------|-------|-------------|-----|----|------------|---------------------|
| | | H | W | D | | |
| CMHLEG24LL | 317 | 28 | 2.5 | 24 | 9 | 1.25 |
| CMHLEG24RL | 317 | 28 | 2.5 | 24 | 9 | 1.25 |
| CMHLEG30LL | 333 | 28 | 2.5 | 30 | 11 | 1.45 |
| CMHLEG30RL | 333 | 28 | 2.5 | 30 | 11 | 1.45 |

CMHC • HAT Channel

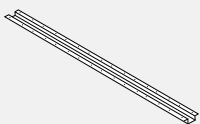

- Support worksurfaces.

| PRODUCT CODE | PRICE | SIZE/INCHES | | | WEIGHT LBS | VOL FT ³ |
|--------------|-------|-------------|----|---|------------|---------------------|
| | | H | W | D | | |
| CMHC40 | 58 | 1.4 | 40 | 5 | 4 | 0.20 |
| CMHC46 | 64 | 1.4 | 46 | 5 | 6 | 0.22 |
| CMHC52 | 68 | 1.4 | 52 | 5 | 7 | 0.25 |
| CMHC58 | 78 | 1.4 | 58 | 5 | 8 | 0.28 |
| CMHC64 | 88 | 1.4 | 64 | 5 | 9 | 0.31 |
| CMHC70 | 94 | 1.4 | 70 | 5 | 10 | 0.33 |

CSSL13 • Panel Mount Shelf

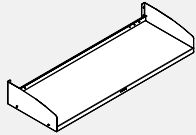

- 13" deep panel-mounted storage shelf with backlip.
- Mounting brackets are included.

| PRODUCT CODE | PRICE | SIZE/INCHES | | | WEIGHT VOL | |
|--------------|-------|-------------|----|----|------------|-----------------|
| | | H | W | D | LBS | FT ³ |
| CSSL1324 | 146 | 5 | 24 | 13 | 11 | 1.28 |
| CSSL1330 | 152 | 5 | 30 | 13 | 12 | 1.28 |
| CSSL1336 | 154 | 5 | 36 | 13 | 13 | 1.28 |
| CSSL1342 | 166 | 5 | 42 | 13 | 15 | 1.70 |
| CSSL1348 | 182 | 5 | 48 | 13 | 16 | 1.70 |
| CSSL1354 | 195 | 5 | 54 | 13 | 19 | 2.12 |
| CSSL1360 | 204 | 5 | 60 | 13 | 21 | 2.12 |

CSOF13 • Flush Front KD Overhead Cabinet

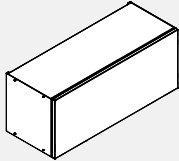

- Door retracts up and over the cabinet.
- Ready for quick assembly on site.
- Quality steel construction.
- Mounting brackets are included.
- 60" unit is reinforced for proper weight distribution.
- Inside dimensions: 12" h. x 12.75" d.
- Lock is not included, please order separately.

| PRODUCT CODE | PRICE | SIZE/INCHES | | | WEIGHT VOL | |
|--------------|-------|-------------|----|----|------------|-----------------|
| | | H | W | D | LBS | FT ³ |
| CSOF1324 | 499 | 14.5 | 24 | 13 | 27 | 1.28 |
| CSOF1330 | 517 | 14.5 | 30 | 13 | 31 | 1.28 |
| CSOF1336 | 573 | 14.5 | 36 | 13 | 34 | 1.28 |
| CSOF1342 | 630 | 14.5 | 42 | 13 | 38 | 1.70 |
| CSOF1348 | 690 | 14.5 | 48 | 13 | 43 | 1.70 |
| CSOF1354 | 747 | 14.5 | 54 | 13 | 48 | 2.12 |
| CSOF1360 | 803 | 14.5 | 60 | 13 | 53 | 2.12 |

CMSLK13 • Lock for CSOF13

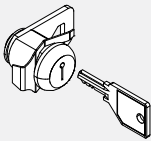

- Lock and key for CSOF13 overhead cabinet.
- Includes one lock assembly and two keys.

| PRODUCT CODE | PRICE |
|--------------|-------|
| CMSLK13 | 30 |

CMADA • Panel Mounted Overhead Storage, AODA Compliant

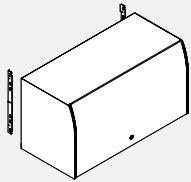

- Panel mounted metal overhead storage with opaque acrylic door. The mechanism lifts the door up and stores it out of the way, above the storage unit.
- Meets CSA B651 Barrier Free Design & AODA (Accessibility for Ontarians with Disabilities Act).
- 16" high units accept standard and A4 binders.
- All shelves are reinforced for proper weight distribution.
- Inside dimensions: 14.25" high x 13.4" deep.
- Shipped partially assembled.
- Unit includes attachment hardware, lock and mounting brackets. Back not included.

| PRODUCT CODE | PRICE | SIZE/INCHES | | | WEIGHT VOL | |
|--------------|-------|-------------|----|------|------------|-----------------|
| | | H | W | D | LBS | FT ³ |
| CMADA30PM | 839 | 16 | 30 | 14.2 | 27 | 5.3 |
| CMADA36PM | 906 | 16 | 36 | 14.2 | 32 | 6.3 |
| CMADA42PM | 970 | 16 | 42 | 14.2 | 37 | 7.3 |
| CMADA48PM | 1037 | 16 | 48 | 14.2 | 42 | 8.3 |
| CMADA54PM | 1101 | 16 | 54 | 14.2 | 47 | 9.3 |
| CMADA60PM | 1167 | 16 | 60 | 14.2 | 53 | 10.3 |

CMDAOH • Center Mount Overhead

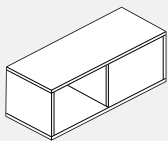

- Inside dimensions 13" high x 13" deep.
- Laminate Overhead.
- Available in standard Compile laminate finishes.
- Top mount on panels.
- Overhead Support Brackets included.

| PRODUCT CODE | PRICE | SIZE/INCHES | | | WEIGHT VOL | |
|--------------|-------|-------------|----|-------|------------|-----------------|
| | | H | W | D | LBS | FT ³ |
| CMDAOH36 | 1135 | 15 | 36 | 14.12 | 10 | 4.4 |
| CMDAOH42 | 1222 | 15 | 42 | 14.12 | 11 | 5.1 |
| CMDAOH48 | 1273 | 15 | 48 | 14.12 | 12 | 5.8 |
| CMDAOH54 | 1367 | 15 | 54 | 14.12 | 13 | 6.6 |
| CMDAOH60 | 1415 | 15 | 60 | 14.12 | 14 | 7.3 |

CS93FPxxBFP • 9300 Series Freestanding Box File Pedestal

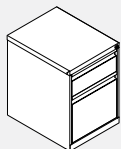

- One box and one file drawer pedestal.
- Freestanding, counterweight included.
- All drawers are locking.
- Box drawer includes pencil tray.

| PRODUCT CODE | PRICE | SIZE/INCHES | | | WEIGHT VOL | |
|--------------|-------|-------------|----|----|------------|-----------------|
| | | H | W | D | LBS | FT ³ |
| CS93FP19BFP | 524 | 21.31 | 15 | 19 | 50 | 5.1 |
| CS93FP23BFP | 531 | 21.31 | 15 | 23 | 55 | 6.0 |
| CS93FP29BFP | 642 | 21.31 | 15 | 29 | 64 | 7.5 |

CS93FPxxBBFP • 9300 Series Freestanding Box Box File Pedestal

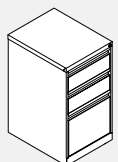

- Two box and one file drawer pedestal.
- Freestanding, counterweight included.
- All drawers are locking.
- Top box drawer includes pencil tray.

| PRODUCT CODE | PRICE | SIZE/INCHES | | | WEIGHT VOL | |
|--------------|-------|-------------|----|----|------------|-----------------|
| | | H | W | D | LBS | FT ³ |
| CS93FP19BBFP | 568 | 27.87 | 15 | 19 | 55 | 6.5 |
| CS93FP23BBFP | 578 | 27.87 | 15 | 23 | 68 | 7.7 |
| CS93FP29BBFP | 692 | 27.87 | 15 | 29 | 78 | 9.6 |

CS93FPxxFFP • 9300 Series Freestanding File File Pedestal

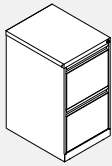

- Two file drawer pedestal.
- Freestanding, counterweight included.
- All drawers are locking.

| PRODUCT CODE | PRICE | SIZE / INCHES | | | WEIGHT VOL | |
|--------------|-------|---------------|----|----|------------|-----------------|
| | | H | W | D | LBS | FT ³ |
| CS93FP19FFP | 547 | 27.87 | 15 | 19 | 53 | 6.5 |
| CS93FP23FFP | 554 | 27.87 | 15 | 23 | 60 | 7.7 |
| CS93FP29FFP | 656 | 27.87 | 15 | 29 | 70 | 9.6 |

CS93WPxxBBFP • 9300 Series Worksurface Supporting Box Box File Pedestal

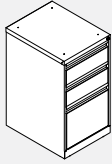

- Two box and one file drawer pedestal.
- Worksurface supporting, includes mounting holes in the top.
- All drawers are locking.
- Top box drawer includes pencil tray.
- Note: Specify bracket and filler kit separately, CSPWSB93.

| PRODUCT CODE | PRICE | SIZE / INCHES | | | WEIGHT VOL | |
|--------------|-------|---------------|----|----|------------|-----------------|
| | | H | W | D | LBS | FT ³ |
| CS93WP19BBFP | 563 | 27.87 | 15 | 19 | 55 | 6.5 |
| CS93WP23BBFP | 571 | 27.87 | 15 | 23 | 68 | 7.7 |
| CS93WP29BBFP | 662 | 27.87 | 15 | 29 | 78 | 9.6 |

CS93WPxxFFP • 9300 Series Worksurface Supporting File File Pedestal

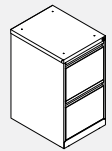

- Two file drawer pedestal.
- Worksurface supporting, includes mounting holes in the top.
- All drawers are locking.
- Note: Specify bracket and filler kit separately, CSPWSB93.

| PRODUCT CODE | PRICE | SIZE / INCHES | | | WEIGHT VOL | |
|--------------|-------|---------------|----|----|------------|-----------------|
| | | H | W | D | LBS | FT ³ |
| CS93WP19FFP | 540 | 27.87 | 15 | 19 | 53 | 6.5 |
| CS93WP23FFP | 545 | 27.87 | 15 | 23 | 60 | 7.7 |
| CS93WP29FFP | 658 | 27.87 | 15 | 29 | 70 | 9.6 |

CS93MPxxBFP • 9300 Series Mobile Box File Pedestal

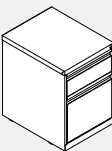

- One box and one file drawer mobile pedestal.
- Casters preinstalled, casters non-locking.
- Counterweight included.
- All drawers locking.
- Box drawer includes pencil tray.
- NOTE: Cannot be used as guest seating.

| PRODUCT CODE | PRICE | SIZE / INCHES | | | WEIGHT VOL | |
|--------------|-------|---------------|----|----|------------|-----------------|
| | | H | W | D | LBS | FT ³ |
| CS93MP19BFP | 624 | 21.87 | 15 | 19 | 66 | 5.2 |
| CS93MP23BFP | 646 | 21.87 | 15 | 23 | 72 | 6.2 |
| CS93MP29BFP | 694 | 21.87 | 15 | 29 | 92 | 7.6 |

CS93MPxxBBFP • 9300 Series Mobile Box Box File Pedestal

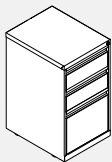

- Two box and one file drawer mobile pedestal.
- Casters preinstalled, casters non-locking.
- Counterweight included.
- All drawers locking.
- Top box drawer includes pencil tray.
- NOTE: Cannot be used as guest seating.

| PRODUCT CODE | PRICE | SIZE / INCHES | | | WEIGHT VOL | |
|--------------|-------|---------------|----|----|------------|-----------------|
| | | H | W | D | LBS | FT ³ |
| CS93MP19BBFP | 646 | 27.87 | 15 | 19 | 76 | 6.5 |
| CS93MP23BBFP | 653 | 27.87 | 15 | 23 | 85 | 7.7 |
| CS93MP29BBFP | 708 | 27.87 | 15 | 29 | 94 | 9.6 |

CS93MPxxFFP • 9300 Series Mobile File File Pedestal

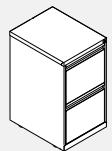

- Two file drawer pedestal.
- Casters preinstalled, casters non-locking.
- Counterweight included.
- All drawers locking.
- NOTE: Cannot be used as guest seating.

| PRODUCT CODE | PRICE | SIZE / INCHES | | | WEIGHT VOL | |
|--------------|-------|---------------|----|----|------------|-----------------|
| | | H | W | D | LBS | FT ³ |
| CS93MP19FFP | 612 | 27.87 | 15 | 19 | 73 | 6.5 |
| CS93MP23FFP | 638 | 27.87 | 15 | 23 | 81 | 7.7 |
| CS93MP29FFP | 706 | 27.87 | 15 | 29 | 90 | 9.6 |

BSPF0BFxxC • Prime Freestanding Box File Pedestal

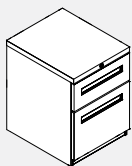

- One box and one file drawer pedestal.
- All drawers are locking.
- Box drawer includes pencil tray.
- For freestanding, to add counterweight (W2 option), add \$49 list.
- For mobile, to add casters and counterweight (W1 option), add \$73 list. Adds 0.5" to height.
- NOTE: Cannot be used as guest seating.

| PRODUCT CODE | PRICE | SIZE / INCHES | | | WEIGHT VOL | |
|--------------|-------|---------------|----|----|------------|-----------------|
| | | H | W | D | LBS | FT ³ |
| BSPF0BF18C | 722 | 20.8 | 15 | 18 | 52.4 | 4.2 |
| BSPF0BF22C | 756 | 20.8 | 15 | 22 | 58.8 | 5.0 |
| BSPF0BF28C | 791 | 20.8 | 15 | 28 | 68.7 | 6.3 |

BSPFSBGxxC • Prime Box Box File Pedestal



- Two box and one file drawer pedestal.
- All drawers are locking.
- Top box drawer includes pencil tray.
- For freestanding, to add counterweight (W2 option), add \$49 list.
- For mobile, to add casters and counterweight (W1 option), add \$73 list. Adds 0.5" to height.
- Top box drawer 4.8"h; middle box drawer 6.4"h; bottom file drawer 13.6"h (interior 12.5"h).
- Note: Specify bracket and filler kit separately, CSPWSBPM18 for 18" deep and CSPWSBPM22 for 22 and 28" deep.

| PRODUCT CODE | PRICE | SIZE/INCHES | | | WEIGHT VOL | |
|--------------|-------|-------------|----|----|------------|-----------------|
| | | H | W | D | LBS | FT ³ |
| BSPFSBG18C | 834 | 28 | 15 | 18 | 67.5 | 5.5 |
| BSPFSBG22C | 874 | 28 | 15 | 22 | 75.0 | 6.6 |
| BSPFSBG28C | 913 | 28 | 15 | 28 | 86.8 | 8.3 |

BSPF0FGxxC • Prime File File Pedestal

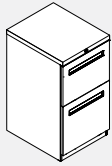

- Two file drawer pedestal.
- All drawers are locking.
- For freestanding, to add counterweight (W2 option), add \$49 list.
- For mobile, to add casters and counterweight (W1 option), add \$73 list. Adds 0.5" to height.
- Top file drawer 11.2"h (interior 10.6"h); bottom file drawer 13.6"h (interior 12.5"h).
- Note: Specify bracket and filler kit separately, CSPWSBPM18 for 18" deep and CSPWSBPM22 for 22 and 28" deep.

| PRODUCT CODE | PRICE | SIZE/INCHES | | | WEIGHT VOL | |
|--------------|-------|-------------|----|----|------------|-----------------|
| | | H | W | D | LBS | FT ³ |
| BSPF0FG18C | 761 | 28 | 15 | 18 | 67.5 | 5.5 |
| BSPF0FG22C | 791 | 28 | 15 | 22 | 75.0 | 6.6 |
| BSPF0FG28C | 825 | 28 | 15 | 28 | 86.8 | 8.3 |

BSPW0BFxxC • Prime Mobile Box File Pedestal



- Mobile one box and one file drawer pedestal.
- All drawers are locking.
- 60mm casters.
- Front casters are locking.

| PRODUCT CODE | PRICE | SIZE/INCHES | | | WEIGHT VOL | |
|--------------|-------|-------------|----|----|------------|-----------------|
| | | H | W | D | LBS | FT ³ |
| BSPW0BF18C | 888 | 23.3 | 15 | 18 | 73.5 | 4.6 |
| BSPW0BF22C | 917 | 23.3 | 15 | 22 | 79.1 | 5.6 |
| BSPW0BF28C | 947 | 23.3 | 15 | 28 | 87.7 | 7.0 |

BSK • Keys and Replacement Lock Core (Fileco Prime Series)

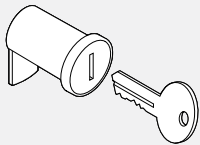

- BSKY - Set of two extra keys for existing Prime storage. Specify core #. Key range W401-W550.
- BSKC - Includes one lock core and a set of two keys for Prime storage. Specify core #. Key range W401-W550.

| PRODUCT CODE | PRICE | SIZE/INCHES | | | WEIGHT VOL | |
|----------------------|-------|-------------|------|-----|------------|-----------------|
| | | H | W | D | LBS | FT ³ |
| BSKY EXTRA KEY | 13 | 1.75 | 0.75 | 0.2 | 0.2 | 0.01 |
| BSKC LOCK CORE & KEY | 30 | 2 | 1 | 0.5 | 0.4 | 0.01 |

CSPWSB93 • Compile Worksurface Supporting Bracket for 9300 Series Pedestals

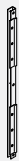

- Kit includes filler and bracket.

| PRODUCT CODE | PRICE | SIZE/ | INCHES | | WEIGHT VOL | |
|--------------|-------|-------|--------|---|------------|-----------------|
| | | H | W | D | LBS | FT ³ |
| CSPWSB93 | 68 | 27.63 | 0.855 | 1 | 2.16 | 0.014 |

CSPWSBPM18 • Compile Worksurface Supporting Bracket for Prime Series 18" deep Pedestals

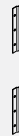

- Kit includes bracket.

| PRODUCT CODE | PRICE | SIZE/ | INCHES | | WEIGHT VOL | |
|--------------|-------|-------|--------|---|------------|-----------------|
| | | H | W | D | LBS | FT ³ |
| CSPWSBPM18 | 31 | 9 | 1.27 | 1 | 0.83 | 0.007 |

CSPWSBPM22 • Compile Worksurface Supporting Bracket for Prime Series 22 and 28" deep Pedestals



- Kit includes filler and bracket.

| PRODUCT CODE | PRICE | SIZE/ | INCHES | | WEIGHT VOL | |
|--------------|-------|-------|--------|---|------------|-----------------|
| | | H | W | D | LBS | FT ³ |
| CSPWSBPM22 | 73 | 28 | 1.75 | 1 | 2.83 | 0.284 |

ACCESSORIES

Boulevard, Boulevard System 3, Compile, Diet & Evolve Ergonomic Solutions

Helping Office Inhabitants be Healthy and Efficient

- Ergonomic Computer Accessories
- Energy Efficient Lighting and Power Accessories
- Paper Management Accessories
- Workstation Enhancement Accessories

For use with Boulevard, Boulevard System 3, Compile, Diet and Evolve (unless otherwise specified).

GAKSM01 • Keyboard Support Mechanism

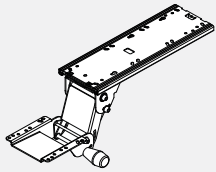

- Soft Touch Knob for simultaneous height & tilt adjustment.
- Spring-assist mechanism helps counter balance weight of keyboard & tray.
- Low-profile design for maximum leg room.
- Includes 21.75" under worksurface Glide Track
- Optional Glide Tracks available at no upcharge:
 - 12" Glide Track add suffix "12" (EXAMPLE GAKSM0112)
 - 18" Glide Track add suffix "18" (EXAMPLE GAKSM0118)
- Available in black only
- To be used with keyboard trays, sold separately.

| PRODUCT CODE | PRICE | SIZE/ INCHES | | | WEIGHT VOL | |
|--------------|-------|--------------|---|------|------------|-----------------|
| | | H | W | D | LBS | FT ³ |
| GAKSM01 | 244 | 4.3 | 9 | 23.8 | 9.2 | 0.533 |

- Height Range 6" (+1.0"/-5.5")
- Soft Touch Knob tilt adjustable range +15°/-15°
- 360° base swivel

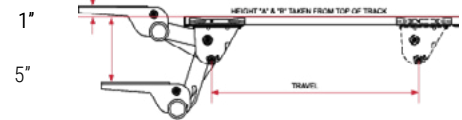
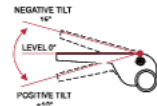

GAKSML • Slim Fit Keyboard Support Mechanism

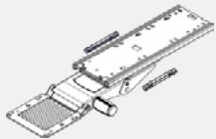

- Height Range 8.88" (+2.38" / - 6.5")
- Tilt Range (+10° / -20°)
- 360° Swivel.
- Meets ANSI/HFES, 100-2007 conformance requirement for height clearance.
- Super slim mechanism design increases clearance under the worksurface.
- Height & depth indicator incorporated together in an intelligently designed dashboard.
- Patented Lift-N-Lock™ height adjustment without knobs or levers automatically locks into position with release of tray for better AODA/Barrier Free compliance.
- Easy access to tilt control knob.
- Designed for disassembly and fully recyclable.
- Includes 21.75" undersurface Glide Track.
- Optional Glide Tracks available:
 - 12" Glide Track add suffix "12" (EXAMPLE GAKSML12)
 - 18" Glide Track add suffix "18" (EXAMPLE GAKSML18)
- "W" Indicated white finish.

| PRODUCT CODE | PRICE | SIZE/ INCHES | | | WEIGHT VOL | |
|--------------|-------|--------------|-----|----|------------|-----------------|
| | | H | W | D | LBS | FT ³ |
| GAKSML | 321 | 4.75 | 9.5 | 24 | 9 | 0.627 |
| GAKSMLW | 321 | 4.75 | 9.5 | 24 | 9 | 0.627 |

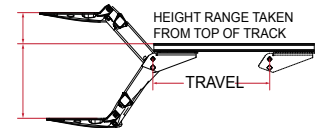
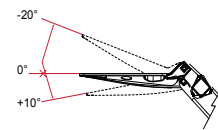

GAKSM02 • Lift-N-Lock Keyboard Support Mechanism

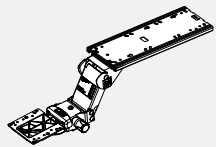

- Patent Pending Height Indicator Gauge allows for precise height setting when used by multiple users, or for returning to optimal height setting after storage.
- Exceeds BIFMA performance standards.

- Includes 21.75" under worksurface Glide Track
- Optional Glide Tracks available at no upcharge:
 - 12" Glide Track add suffix "12" (EXAMPLE GAKSM0212)
 - 18" Glide Track add suffix "18" (EXAMPLE GAKSM0218)
- Available in Black Only
- To be used with keyboard trays, sold separately.

NOTE: Positive Tilt Lockout available. Contact your Customer Service Representative.
 • Patented Lift-N-Lock™ height adjustment without knobs or levers automatically locks into position with release of tray for greater. Meets CSA B651 Barrier Free Design & AODA (Accessibility for Ontarians with Disabilities Act).

| PRODUCT CODE | PRICE | SIZE/ INCHES | | | WEIGHT VOL | |
|--------------|-------|--------------|---|------|------------|-----------------|
| | | H | W | D | LBS | FT ³ |
| GAKSM02 | 321 | 4.3 | 9 | 23.8 | 9.7 | 0.533 |

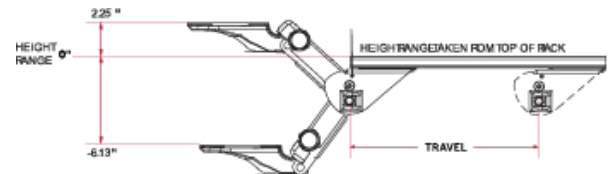

- Height Range 8.38" (+2.25"/-6.13")
- Dial-Tilt Gauge shows precise tilt angles from +10°/-15° positions.
- 360° base swivel

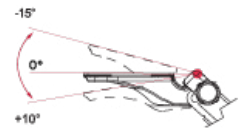

ACCESSORIES

GAKSM03 • Lift-N-Lock Keyboard Support Mechanism

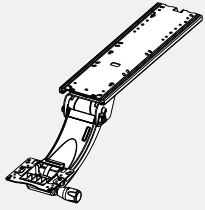

- Patent Pending Height Indicator Gauge allows for precise height setting when used by multiple users, or for returning to optimal height setting after storage.
- Curved neck allows user to be closer to the desk when in standing position.
- Exceeds BIFMA performance standards.

- Includes 21.75" under worksurface Glide Track
- Optional Glide Tracks available at no upcharge:
 - 12" Glide Track add suffix "12" (EXAMPLE GAKSM0312)
 - 18" Glide Track add suffix "18" (EXAMPLE GAKSM0318)

- Available in black only
- To be used with keyboard trays, sold separately.

- **NOTE:** Positive Tilt Lockout available. Contact your Customer Service Representative.
- Maximizes ergonomic support for both seated and standing positions.
- Patented Lift-N-Lock™ height adjustment without knobs or levelers automatically locks into position with release of tray for greater. Meets CSA B651 Barrier Free Design & AODA (Accessibility for Ontarians with Disabilities Act).

| PRODUCT CODE | PRICE | SIZE/ INCHES | | | WEIGHT VOL | |
|--------------|-------|--------------|---|------|------------|-----------------|
| | | H | W | D | LBS | FT ³ |
| GAKSM03 | 519 | 5.8 | 9 | 23.8 | 11.3 | 0.719 |

- Height Range 14.13" (+8.25"/-5.88")
- Dial-Tilt Gauge shows precise tilt angles from +10°/-15° positions.
- 360° base swivel

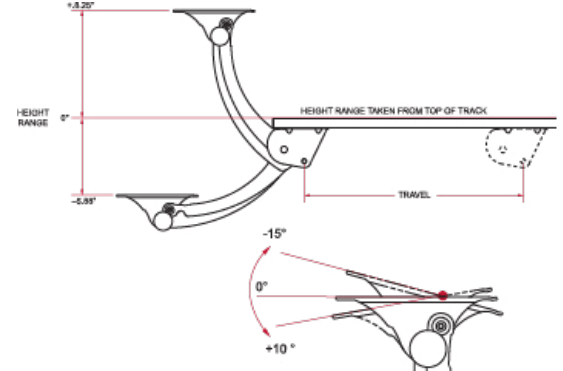

GAKSM05 • Fixed Mount Trackless Keyboard Arm

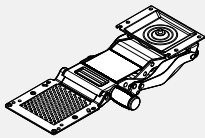

Features:

- Direct Mount, no track required. Ideal solution for Bridges and FreeFit Tables.
- Total height adjustment of 5.73" (-1.25" to -6.98" under the desk surface).
- Enhanced patented Lift-N-Lock™ braking mechanism.
- Soft Touch Knob Dial Tilt with +10° to -15° tilt angles.
- Low profile tray head.
- Separate height and tilt gauges.
- 360° of swivel.
- Optional factory or field installable tilt lockout available.

Benefits:

- Full storage in 9 3/8" undersurface space.
- Exceeds HFES & BIFMA 5" percentile seated keyboarding heights (HFES 22" BIFMA 22.6").
- Easy height adjustment, providing superior lock up and stability with infinite adjustment.
- ADA Compliant tilt adjustment with easily accessible tilt knob.
- Greater knee clearance under desk surface.

| PRODUCT CODE | PRICE | SIZE/ INCHES | | | WEIGHT VOL | |
|--------------|-------|--------------|----|---|------------|-----------------|
| | | H | W | D | LBS | FT ³ |
| GAKSM05 | 300 | 5 | 13 | 9 | 6 | 0.317 |
| GAKSM05W | 300 | 5 | 13 | 9 | 6 | 0.317 |

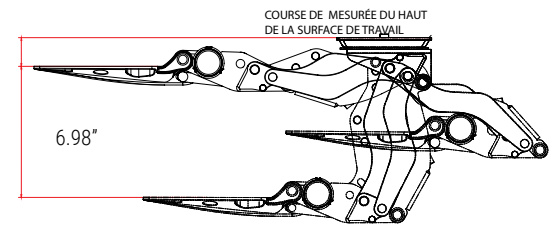

- Allows accurate, repeatable tray placement.
- Allows side to side arm movement.
- Locks out positive tilt for specific ergonomic applications or users preference.
- Provides increased storage where space permits.
- "W" indicated white finish.

GATM01 • Tray with Sliding Mouse Support

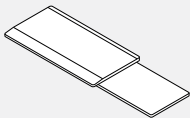

MDF Tray:

- Formed MDF with Textured Finish.
- Foam Anti-skid mat.

Sliding Retractable Mouse Support:

- ABS tray
- Sliding Retractable Mouse Support slides below the tray for left or right mouse positioning.
- Extends 9.91" beyond the end of the Keyboard Tray.
 - 33% recycled content by weight content) and 92.64% recyclable.
- Available in black only

| PRODUCT CODE | PRICE | SIZE/ INCHES | | | WEIGHT VOL | |
|--------------|-------|--------------|------|------|------------|-----------------|
| | | H | W | D | LBS | FT ³ |
| GATM01 | 245 | 2 | 21.3 | 10.5 | 7 | 0.259 |

GATM02 • 27" HDPE Tray with Two Mousing Surfaces

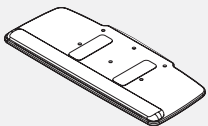

HDPE Tray:

- 1/2" thick High Density Polyethylene with textured finish.
- Includes removable plug-in, gel free foam palm rest.
- Anti-skid strips.

Mousing Surface:

- Keyboard and Mouse can be set up left or right.
- Includes Mouse Fence with Cable Manager.
 - 92.64% recyclable.
- Available in black only

| PRODUCT CODE | PRICE | SIZE/ INCHES | | | WEIGHT VOL | |
|--------------|-------|--------------|----|----|------------|-----------------|
| | | H | W | D | LBS | FT ³ |
| GATM02 | 317 | 1 | 27 | 11 | 6 | 0.179 |

ACCESSORIES

GATM03 • Phenolic Tray with Height Adjustable Mouse Support

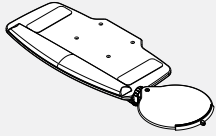

Height Adjustable Mouse Support:

- Ergonomic adjustment of tilt, swivel & height adjustment.
- Can be mounted either left or right.
- Includes mouse fence with cable manager.
- Available in black or white.
- "W" indicates white finish.

| PRODUCT CODE | PRICE | SIZE/ INCHES | | | WEIGHT VOL | |
|--------------|-------|--------------|------|----|------------|-----------------|
| | | H | W | D | LBS | FT ³ |
| GATM03 | 341 | 2.8 | 20.5 | 11 | 5.8 | 0.429 |
| GATM03W | 341 | 2.8 | 20.5 | 11 | 5.8 | 0.429 |

Phenolic Tray:

- Solid low profile keyboard tray.
- Graphite finish helps hide fingerprints and smudges.
- Includes removable plug-in, gel-free foam palm rest.
- Includes foam Anti-skid strips.

GATM04 • HDPE Tray with Height Adjustable Mouse Support

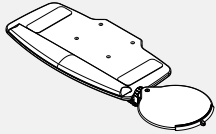

HDPE Tray:

- 1/2" thick High Density Polyethylene with textured finish.
- Includes removable plug-in, gel free foam palm rest.
- 45% recycled content by weight (45% Post Industrial content) and 99.97% recyclable.
- Includes foam anti-skid strips.

| PRODUCT CODE | PRICE | SIZE/ INCHES | | | WEIGHT VOL | |
|--------------|-------|--------------|------|----|------------|-----------------|
| | | H | W | D | LBS | FT ³ |
| GATM04 | 383 | 3.2 | 20.5 | 11 | 6 | 0.5 |

Height Adjustable Mouse Support:

- Ergonomic adjustment of tilt, swivel & height adjustment.
- Can be mounted either left or right.
- Includes mouse fence with cable manager.
 - 92.64% recyclable.
- Available in black only.

GAGTA01 • Glide Tray Adapter (set of 2)

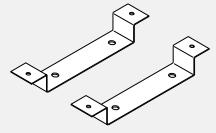





- Attaches to Glide Tracks of all Keyboard Mechanisms and Sliding CPU Holders found within this price list.
- Mounting hardware included.
- Available in black only.
- Not required for use with GAKSM05.

| PRODUCT CODE | PRICE | SIZE/ INCHES | | | WEIGHT VOL | |
|--------------|-------|--------------|---|---|------------|-----------------|
| | | H | W | D | LBS | FT ³ |
| GAGTA01 | 88 | 2.5 | 9 | 2 | 0.5 | 0.025 |

- Accommodates the placement of sliding keyboard mechanisms and CPU holders below the cross beam of a Bridges tables.

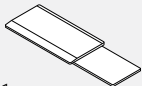
Keyboard Combination Chart • Package Codes and Pricing

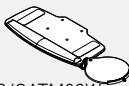
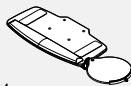
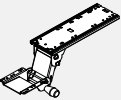
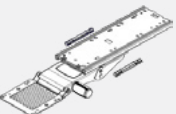
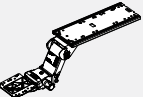
- "W" at the end of the code designates white keyboard.
- "W" before 2 numbers designates white mechanism.
- "W" in both places in code designates white keyboard and mechanism.

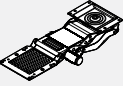
| | | | | |
|---------------------------------------------------------------------------------------------------------|-----------------------------------------------------------------------------------------------|--------------------------------------------------------------------------------------------------------|-------------------------------------------------------------------------------------------------|------------------------------------|
|  GATM01 |  GATM02 |  GATM03/GATM03W |  GATM04 | |
|  GAKSM01 | GAKSP0101 \$492 | GAKSP0102 \$560 | GAKSP0103 / GAKSP103W \$586 | GAKSP0104 \$626 |
|  GAKSML/GAKSMLW | GAKSPML01 / GAKSPMLW01 \$564 | GAKSPML02 / GAKSPMLW02 \$637 | GAKSPML03 / GAKSPML03W / GAKSPMLW03 / GAKSPMLW03W \$662 | GAKSPML04 / GAKSPMLW04 \$702 |
|  GAKSM02 | GAKSP0201 \$564 | GAKSP0202 \$637 | GAKSP0203 / GAKSP0203W \$662 | GAKSP0204 \$702 |
|  GAKSM03 | GAKSP0301 \$762 | GAKSP0302 \$832 | GAKSP0303 / GAKSP0303W \$858 | GAKSP0304 \$898 |
|  GAKSM05/GAKSM05W | GAKSP0501 / GAKSP0501W \$547 | GAKSP0502 / GAKSP0502W \$616 | GAKSP0503 / GAKSP0503W / GAKSP0503W \$640 | GAKSP0504 / GAKSP0504W \$681 |

ACCESSORIES

GACPU01 • Fixed Mount CPU Holder

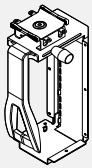

- Fully adjustable clamping mechanism to accept tower CPU's with a wide range of 3.5" to 9.3" and a height range of 12.5" to 22.5".
- Directly mounts to underside of desk surface.
- Soft Touch knob for side clamp adjustment and bayonet lance for vertical height adjustment.
- CPU Holder can also be mounted directly to an upright desk leg surface or wall, via side mounting holes.
- Manufactured from Steel and Engineered Resin,
- Providing rugged durability and support.
- Available in Black Only

| PRODUCT CODE | PRICE | SIZE/ INCHES | | | WEIGHT VOL | |
|--------------|-------|--------------|------|-----|------------|-----------------|
| | | H | W | D | LBS | FT ³ |
| GACPU01 | 202 | 18.5 | 11.7 | 9.2 | 9 | 1.152 |

GACPU02 • CPU Holder on Glide Track

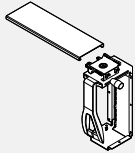

- Accepts tower CPU's with a width range of 3.5" to 9.3" and a height range of 12.5" to 22.5".
- Soft Touch knob for side clamp adjustment and bayonet lance for vertical height adjustment.
- 12" Glide Track mounted and 360° swivel for easy access for rear of CPU
- Manufactured from Steel and Engineered Resin, providing rugged durability and support.
- Available in Black Only

| PRODUCT CODE | PRICE | SIZE/ INCHES | | | WEIGHT VOL | |
|--------------|-------|--------------|------|-----|------------|-----------------|
| | | H | W | D | LBS | FT ³ |
| GACPU02 | 290 | 18.5 | 11.7 | 9.2 | 12.6 | 1.152 |

GACPUH • Woof CPU Holder

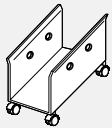

- Provides convenience access to front and back of CPU.
- Expandable width accommodates various sizes of CPU's. Adjusts from 7" to 10".
- Includes 4 locking casters and 4 protective "O" rings.
- Available in Tungsten Only

| PRODUCT CODE | PRICE | SIZE/ INCHES | | | WEIGHT VOL | |
|--------------|-------|--------------|----|------|------------|-----------------|
| | | H | W | D | LBS | FT ³ |
| GACPUH | 187 | 11 | 16 | 7-10 | 5 | 1.0 |

GAAKS1818 • CRT Corner Plate

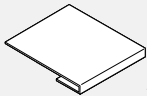

- Converts two abutting worksurfaces in a 90° corner into a 45° angle keyboard worksurface.
- Keyboard mechanism not included.
- Fits worksurfaces 1" to 1.25" thick.
- Available in Panel Frame Finish

| PRODUCT CODE | PRICE | SIZE/ INCHES | | | WEIGHT VOL | |
|--------------|-------|--------------|----|----|------------|-----------------|
| | | H | W | D | LBS | FT ³ |
| GAAKS1818 | 99 | 1.25 | 18 | 18 | 3.7 | 0.454 |

GAMA1 • Single Clamp Mount Monitor Arm

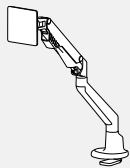

- Finger touch dynamic height adjustment, 12" height range. 4.4 to 19.8 lbs. per monitor loading capacity; accepts screen size 17"-30".
- Maximum monitor width of 34".
- Maximum of 20.5" extension from rear of desk to back of monitor, folds to 4.5".
- Tilt, pan and landscape to portrait rotation; quick release VESA plate, 180 degree lock out.
- Clamp mount and grommet mount options included, accommodates 0.5" to 2" thick tops.
- Accepts mini slide arm GAMS.
- Available in Tungsten (TUN)

| PRODUCT CODE | PRICE | SIZE/ INCHES | | | WEIGHT VOL | |
|--------------|-------|--------------|---|-----|------------|-----------------|
| | | H | W | D | LBS | FT ³ |
| GAMA1 | 418 | 21 | | 5.5 | 6.6 | 0.4 |

GAMA2 • Double Clamp Mount Monitor Arm

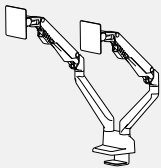

- Finger touch dynamic height adjustment, 12" height range.
- 4.4 to 19.8 lbs. per monitor loading capacity; accepts screen size 17"-30".
- Maximum monitor width of 34".
- Maximum of 20.5" extension from rear of desk to back of monitor, folds to 4.5".
- Tilt, pan and landscape to portrait rotation; quick release VESA plate, 180 degree lock out.
- Clamp mount and grommet mount options included, accommodates 0.5" to 2" thick tops.
- Accepts mini slide arm GAMS.
- Available in Tungsten (TUN)

| PRODUCT CODE | PRICE | SIZE/ INCHES | | | WEIGHT VOL | |
|--------------|-------|--------------|---|-----|------------|-----------------|
| | | H | W | D | LBS | FT ³ |
| GAMA2 | 734 | 21 | | 5.5 | 12.8 | 1 |

GAMS • Mini Slide Monitor Arm

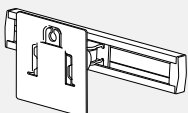

- Works with GAMA1 and GAMA2 monitor arms.
- 9" slide, loading capacity 13.2lbs.
- Quick release VESA plate.
- Available in Tungsten (TUN)

| PRODUCT CODE | PRICE | SIZE/ INCHES | | | WEIGHT VOL | |
|--------------|-------|--------------|----|---|------------|-----------------|
| | | H | W | D | LBS | FT ³ |
| GAMS | 145 | 4.5 | 11 | 6 | 3.3 | 0.3 |

ACCESSORIES

Monitor Arm Specs

- VESA Mounting plate contains 75 mm & 100 mm mounting configuration
- VESA Plate head is fully adjustable with 180° of tilt, 180° of swivel and 360° of rotation for portrait to landscape viewing
- Keyhole slots in VESA Plate for quick mounting of Display Screen
- Counterbalance spring mechanism does not contain gas cylinders (that are prone to leakage)
- Cable Management provided on arm swivel joints
- Arm components manufactured from 100% recyclable aluminum die cast material, providing stability and durability
- 13" Arm height adjustment on 11" Stainless Steel Pole.
- Pole Support Ring doubles as cable manager.
- 360° of arm swivel around pole.
- Desk Clamp and Grommet mounting options standard on pole applications.
- Monitor arms available in Silver (SIL), Black (BLK), or White (WHT).

GAMCSSDE • Double Extension Monitor Arm for Single Screen

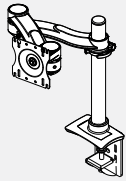

Monitor Arm Single Screen Dual Arm Extension.

- 9 1/2" reach from centre of pole to front of VESA Plate
 - Display Viewing - 180° of tilt, 180° of swivel and 360° of rotation.
 - Quick Mount Versa Plate.
 - 12" Pole Adjustment.
 - 9" Chrome pole adjustment.
- Available in Silver (SIL), Black (BLK) or White (WHT).
- Post is chromed.

| PRODUCT CODE | PRICE | SIZE/ INCHES | | | WEIGHT VOL | |
|--------------|-------|--------------|-----|-----|------------|-----------------|
| | | H | W | D | LBS | FT ³ |
| GAMCSSDE | 506 | 29.3 | 6.8 | 9.5 | 7.5 | 1.095 |

GAMCSSDEH • Double Extension with Height Adjustable Monitor Arm for Single Screen

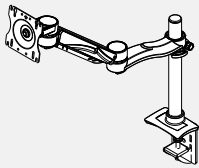

Double extension with height adjustable monitor arm for single screen frees up worksurface space and supports a sit/stand working posture.

- Attaches to the edge of the worksurface or through a grommet.
- Monitor arm adjusts from 3" to 12" from the worksurface.
- Counterbalanced arm provides an additional 13" of height adjustment.
- Monitor connecting bracket swivels 360 degrees and tilts +/- 90 degrees (180 degrees).
- Double extension has 19" of back and forth movement to allow for different focal depths of viewing comfort.
- Built-in cable clips on underside of extension arms and pole base allows organized cable management.
- Available in Silver (SIL), Black (BLK) or White (WHT).
- Post is chromed.

| PRODUCT CODE | PRICE | SIZE/ INCHES | | | WEIGHT VOL | |
|--------------|-------|--------------|-----|-----|------------|-----------------|
| | | H | W | D | LBS | FT ³ |
| GAMCSSDEH | 609 | 29.3 | 6.8 | 9.5 | 8.2 | 1.095 |

GAMCDSDE • Monitor Arms for Dual Screens

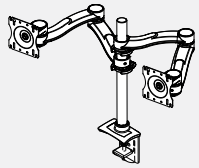

Double extension monitor arms for dual screens frees up worksurface space.

- Used for side-by-side or back-to-back applications.
- Attaches to the edge of the worksurface or through a grommet.
- Monitor arm adjusts from 3" to 12" from the worksurface.
- Monitor connecting extension has 19" of back and forth movement to allow for different focal depths of viewing comfort.
- Max 32" screen width.
- Built-in cable clips on underside of extension arms and pole base allows organized cable management.
- Available in Silver (SIL), Black (BLK) or White (WHT).
- Post is chromed.

| PRODUCT CODE | PRICE | SIZE/ INCHES | | | WEIGHT VOL | |
|--------------|-------|--------------|-----|-----|------------|-----------------|
| | | H | W | D | LBS | FT ³ |
| GAMCDSDE | 898 | 29.3 | 6.8 | 9.5 | 10.7 | 1.095 |

GAMCDSDEH • Double Extension with Height Adjustable Monitor Arms for Dual Screens

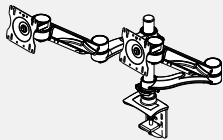

Double extension with height adjustable monitor arms for dual screens frees up the worksurface space and supports a sit/stand working posture.

- Used for side-by-side or back-to-back applications.
- Attaches to the edge of the worksurface or through a grommet.
- Monitor arm adjusts from 3" to 12" from the worksurface.
- Counterbalanced arm provides an additional 13" of height adjustment.
- Monitor connecting bracket swivels 360 degrees and tilts +/- 90 degrees (180 degrees).
- Double extension has 19" of back and forth movement to allow for different focal depths of viewing comfort.
- Built-in cable clips on underside of extension arms and pole base allows organized cable management.
- Max 35" screen width.
- Available in Silver (SIL), Black (BLK) or White (WHT).
- Post is chromed.

| PRODUCT CODE | PRICE | SIZE/ INCHES | | | WEIGHT VOL | |
|--------------|-------|--------------|-----|-----|------------|-----------------|
| | | H | W | D | LBS | FT ³ |
| GAMCDSDEH | 1114 | 29.3 | 6.8 | 9.5 | 12.2 | 1.095 |

ACCESSORIES

GAMLDM20 • Single Screen Monitor Arm for 5 to 20lbs

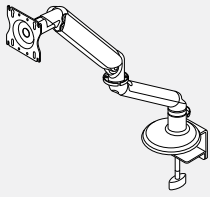

- Comes with clamp and grommet mount, ideal for all desk mounting configurations, minimizing SKU's.
- Adjustable counterbalance cylinder provides smooth 14 1/2" of height adjustment with fingertip control. - counterbalances monitors from 5 lbs. to 20 lbs.
- Double extension arms provide a maximum of 26 3/4" extension from the rear edge of the mounting surface to the VESA Plate for greater monitor adjustment on deep or corner workstations.
- Arms fold back to a minimum dimension of 4 1/2" to provide maximum desk utilization.
- Monitor mounting bracket, with Quick Connect adaptor, contains both 75mm & 100mm hole patterns to match most screen types and compliant with VESA mounting standards.
- Weight gauge provided to allow for quick and easy counterbalance adjustment of the arm prior to installing the screen. Saves time and guesswork especially for multiple arm installations.
- VESA Plate rotates for portrait or landscape viewing with 180° side to side rotation and -90° to +45° tilt for optimal viewing adjustment.
- Die cast aluminum construction provides greater stability and contains high recycled material content with full recyclability.
- Adjustable rotation limiter to restrict arm rotation to 180°, preventing arms from hitting walls.
- Comes with all tools and mounting hardware for quick and easy installation (Tool-free).
- Available in Silver (SIL), Black (BLK) or White (WHT).

| PRODUCT CODE | PRICE | SIZE/ INCHES | | | WEIGHT VOL | |
|-----------------|-------|-----------------|---|-----|------------|-----------------|
| | | H | W | D | LBS | FT ³ |
| GAMLDM20 | 471 | 38 | 6 | 8.5 | 10.23 | 1.122 |

GAMLDM30 • Single Screen Monitor Arm for 10 to 30lbs

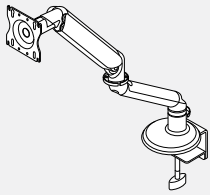

- Comes with clamp and grommet mount, ideal for all desk mounting configurations, minimizing multiple SKU's
- Adjustable counterbalance cylinder provides smooth 14 1/2" of height adjustment with fingertip control - counterbalances monitors from 10 lbs. to 30 lbs.
- Double extension arms provides a maximum of 26.7" extension from the rear edge of the mounting surface to the VESA Plate for greater monitor adjustment on deep or corner workstations
- Arms fold back to a minimum dimension of 4 1/2" to provide maximum desk utilization
- Monitor mounting bracket with Quick Connect adaptor, contains both 75mm & 100mm hole patterns to match most screen types and compliant with VESA mounting standards
- Weight gauge provided to allow for quick and easy counterbalance adjustment of the arm prior to installing the screen.
- Saves time and guesswork especially for multiple arm installations VESA Plate rotates for portrait and landscape viewing with 180° side to side rotation and -90° to +45° tilt for optimal viewing adjustment
- Die cast aluminum construction provides greater stability and contains high recycled material content with full recyclability
- Adjustable rotation limiter to restrict arm rotation to 180°, preventing arms from contacting walls
- Comes with all tools and mounting hardware for quick and easy installation (Tool-free)
- Available in Silver (SIL), Black (BLK) or White (WHT).

| PRODUCT CODE | PRICE | SIZE/ INCHES | | | WEIGHT VOL | |
|-----------------|-------|-----------------|---|-----|------------|-----------------|
| | | H | W | D | LBS | FT ³ |
| GAMLDM30 | 505 | 38 | 6 | 8.5 | 10.23 | 1.122 |

GAMLDM40 • Dual Screen Monitor Arm for combined 15 to 40lbs

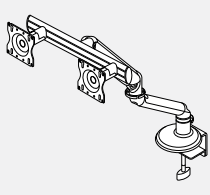

- Comes with clamp and grommet mount, ideal for all desk mounting configurations, minimizing multiple SKU's
- Adjustable counterbalance cylinder provides smooth 14 1/2" of height adjustment with fingertip control and a counterbalance range from 15 lbs. to 40 lbs.
- Double extension arms provide a maximum of 30 3/4" extension from the rear edge of the mounting surface to the VESA Plate for greater monitor adjustment on deep or corner workstations
- Arms fold back to a minimum dimension of 8 3/8" to provide maximum desk utilization
- Monitor mounting bracket with Quick Connect Adaptor, contains both 75mm & 100mm hole patterns to match most screen types and is compliant with VESA mounting standards
- Weight gauge provided to allow for quick and easy counterbalance adjustment of the arm prior to installing the screen. Saves time and guesswork especially for multiple arm installations.
- VESA Plate rotates for portrait and landscape viewing with 180° side to side rotation and -90° to +45° tilt for optimal viewing adjustment
- Die cast aluminum construction provides greater stability and contains high recycled material content with full recyclability
- Adjustable rotation limiter to restrict arm rotation to 180°, preventing arms from contacting walls
- Comes with all tools and mounting hardware for quick and easy installation (Tool-free)
- Available in Silver (SIL), Black (BLK) or White (WHT).

| PRODUCT CODE | PRICE | SIZE/ INCHES | | | WEIGHT VOL | |
|-----------------|-------|-----------------|------|-----|------------|-----------------|
| | | H | W | D | LBS | FT ³ |
| GAMLDM40 | 607 | 38 | 6.25 | 8.5 | 12.75 | 1.168 |

ACCESSORIES

BLVELEDVS • LED Single Arm Lamp



- 7 System watts, 18-fractional LEDs.
- 3500K 250 lumens, 84 CRI.
- Soft touch - instant on, fade to off.
- Infinite dimming 100% down to 15%, last state memory.
- Standard 10 hours turn off (ATO).
- 50,000 hour life LEDs.
- 15 watt, 24 volt wall transformer, 6' cord.
- White (WHT) Silver (SIL) or Black (BLK) - Must specify colour choice.

| PRODUCT CODE | PRICE | SIZE/ INCHES | | | WEIGHT VOL | |
|------------------------------|-------|--------------|---|----|------------|-----------------|
| | | H | W | D | LBS | FT ³ |
| BLVELEDVS | 616 | 8 | 7 | 33 | 7.3 | 0.98 |
| With Occupancy Sensor | | | | | | |
| BLVELEDVSO | 920 | 10 | 9 | 35 | 8.3 | 1.51 |

- UL, CUL and CSA compliant, ETL Listed.
- Base not included.

BLVELEDVD • LED Double Arm Lamp

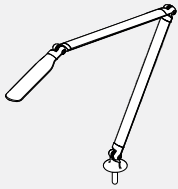

- 7 System watts, 18-fractional LEDs.
- 3500K 250 lumens, 84 CRI.
- Double arm articulation with 20" base to head reaches.
- Soft touch - instant on, fade to off.
- Infinite dimming 100% down to 15%, last state memory.
- Standard 10 hours turn off (ATO).
- 50,000 hour life LEDs.
- 15 watt, 24 volt wall transformer, 6' cord.

| PRODUCT CODE | PRICE | SIZE/ INCHES | | | WEIGHT VOL | |
|------------------------------|-------|--------------|---|----|------------|-----------------|
| | | H | W | D | LBS | FT ³ |
| BLVELEDVD | 646 | 8 | 7 | 33 | 7.6 | 1.02 |
| With Occupancy Sensor | | | | | | |
| BLVELEDVDO | 931 | 10 | 9 | 35 | 8.6 | 1.57 |

- White (WHT) Silver (SIL) or Black (BLK) - Must specify colour choice.
- UL, CUL and CSA compliant, ETL Listed.
- Base not included.

BLVELEDRS • LED Single Arm Lamp

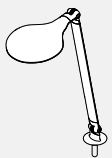

- 7 System watts, 18-fractional LEDs.
- 3500K 250 lumens, 84 CRI.
- Soft touch - instant on, fade to off.
- Infinite dimming 100% down to 15%, last state memory.
- Standard 10 hours turn off (ATO).
- 50,000 hour life LEDs.
- 15 watt, 24 volt wall transformer, 6' cord.
- White (WHT) Silver (SIL) or Black (BLK) - Must specify colour choice.

| PRODUCT CODE | PRICE | SIZE/ INCHES | | | WEIGHT VOL | |
|------------------------------|-------|--------------|---|----|------------|-----------------|
| | | H | W | D | LBS | FT ³ |
| BLVELEDRS | 616 | 8 | 7 | 33 | 7.3 | 0.98 |
| With Occupancy Sensor | | | | | | |
| BLVELEDRSO | 920 | 10 | 9 | 35 | 8.3 | 1.51 |

- UL, CUL and CSA compliant, ETL Listed.
- Base not included.

BLVELEDRD • LED Double Arm Lamp

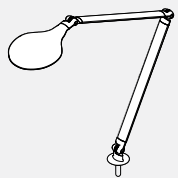

- 7 System watts, 18-fractional LEDs.
- 3500K 250 lumens, 84 CRI.
- Double arm articulation with 20" base to head reaches.
- Soft touch - instant on, fade to off.
- Infinite dimming 100% down to 15%, last state memory.
- Standard 10 hours turn off (ATO).
- 50,000 hour life LEDs.
- 15 watt, 24 volt wall transformer, 6' cord.

| PRODUCT CODE | PRICE | SIZE/ INCHES | | | WEIGHT VOL | |
|------------------------------|-------|--------------|---|----|------------|-----------------|
| | | H | W | D | LBS | FT ³ |
| BLVELEDRD | 633 | 8 | 7 | 33 | 7.6 | 1.02 |
| With Occupancy Sensor | | | | | | |
| BLVELEDRDO | 931 | 10 | 9 | 35 | 8.6 | 1.57 |

- White (WHT) Silver (SIL) or Black (BLK) - Must specify colour choice.
- UL, CUL and CSA compliant, ETL Listed.
- Base not included.

Lamp Mounting Options

- White (WHT) Silver (SIL) or Black (BLK) - Must specify colour choice.



| Grommet Mount | | | | | | |
|----------------------|-------|--------------|---|---|------------|-----------------|
| PRODUCT CODE | PRICE | SIZE/ INCHES | | | WEIGHT VOL | |
| | | H | W | D | LBS | FT ³ |
| BLVELEDASM | 155 | 3 | 6 | 6 | 3 | 0.06 |



| Worksurface Clamp Mount | | | | | | |
|--------------------------------|-------|--------------|---|---|------------|-----------------|
| PRODUCT CODE | PRICE | SIZE/ INCHES | | | WEIGHT VOL | |
| | | H | W | D | LBS | FT ³ |
| BLVELEDASCM | 155 | 3 | 6 | 6 | 2 | 0.04 |



| Slat Wall Mount | | | | | | |
|------------------------|-------|--------------|---|---|------------|-----------------|
| PRODUCT CODE | PRICE | SIZE/ INCHES | | | WEIGHT VOL | |
| | | H | W | D | LBS | FT ³ |
| BLVELEDASW | 155 | 3 | 6 | 6 | 3 | 0.06 |



| Panel Mount | | | | | | |
|--------------------|-------|--------------|---|---|------------|-----------------|
| PRODUCT CODE | PRICE | SIZE/ INCHES | | | WEIGHT VOL | |
| | | H | W | D | LBS | FT ³ |
| BLVELEDAPM | 155 | 3 | 6 | 6 | 3 | 0.06 |

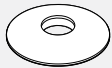

| Freestanding Base | | | | | | |
|--------------------------|-------|--------------|----|----|------------|-----------------|
| PRODUCT CODE | PRICE | SIZE/ INCHES | | | WEIGHT VOL | |
| | | H | W | D | LBS | FT ³ |
| BLVELEDAFS | 173 | 4 | 12 | 12 | 6 | 0.50 |

ACCESSORIES

GCLEDES • Undercabinet LED Task Light

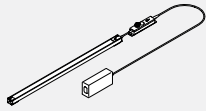

Linear LED Light.

- Includes light fixture with lens and ON/OFF switch.
- Magnet mounted with adhesive metal plates.
- Plug-in power supply with 72" cord length plus 78" DC cord.

Technical information:

- 4100 K Colour Temperature
- 90 Colour Rendering Index
- 30,000 hrs rated Lifespan
- Total power input per light, 9.0 for 24", 13.5 per 36" and 18.0 for 48"

| PRODUCT CODE | PRICE | SIZE/ INCHES | | | WEIGHT VOL | |
|--------------|-------|--------------|------|---|------------|-----------------|
| | | H | W | D | LBS | FT ³ |
| GCLEDES24 | 164 | 1 | 22.9 | 1 | 2.5 | 0.135 |
| GCLEDES36 | 189 | 1 | 33.5 | 1 | 2.8 | 0.161 |
| GCLEDES48 | 209 | 1 | 45.5 | 1 | 3.2 | 0.213 |

GCLEDES-DCS • Undercabinet Daisychain LED Light

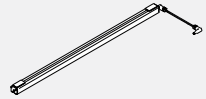

- Undercabinet LED light, 48 inches nominal size, daisychain unit with 1 meter (39 inches) linking cable but no power supply.
- Daisychain units can only be linked up to a total of 48 Watts for all lights on one power supply. This equates to a maximum of 10 feet total nominal length of lights per power supply.

Technical information:

- 4100 K Colour Temperature
- 90 Colour Rendering Index
- 30,000 hrs rated Lifespan
- Total power input per light, 9.0 for 24", 13.5 per 36" and 18.0 for 48"

| PRODUCT CODE | PRICE | SIZE/ INCHES | | | WEIGHT VOL | |
|--------------|-------|--------------|----|---|------------|-----------------|
| | | H | W | D | LBS | FT ³ |
| GCLEDES24DSC | 134 | 1 | 24 | 1 | 2.5 | 0.135 |
| GCLEDES36DSC | 157 | 1 | 36 | 1 | 2.8 | 0.161 |
| GCLEDES48DSC | 178 | 1 | 48 | 1 | 3.2 | 0.213 |

GCLEDESOS • Occupancy Sensor and Dimmer

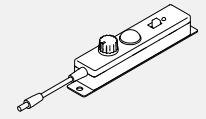

- Inline add-on controller for dimming & occupancy sensor.
- Included, from right to left, a rotary dimmer control, an occupancy sensor and a sensor bypass switch.

| PRODUCT CODE | PRICE | SIZE/ INCHES | | | WEIGHT VOL | |
|--------------|-------|--------------|-----|---|------------|-----------------|
| | | H | W | D | LBS | FT ³ |
| GCLEDESOS | 66 | 6 | 2.5 | 2 | 0.4 | 0.500 |

BEMAE • Mini-Adapt Power Module

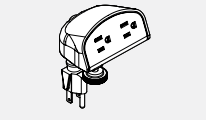

- **Accessory Data/Power House.**
- Attaches to scoop at the back of a worksurface.
- BEMAE1 includes 2 simplex outlets, 6' power cord.
- Available in Black Only

| PRODUCT CODE | PRICE | SIZE/ INCHES | | | WEIGHT VOL | |
|--------------|-------|--------------|-------|---|------------|-----------------|
| | | H | W | D | LBS | FT ³ |
| BEMAE1 | 193 | 2 | 3.625 | 3 | 2.5 | 0.149 |

BRED50AC • Duo Module with A+C

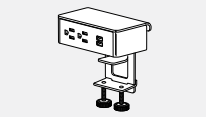

- **The Duo power module is completely integrated with a mounting clamp to attach to the edge of a worksurface.**
- Provides two 15 Amp 120 Volt AC Receptacles; 2.4 amp USB-A port and 60 watt USB-C power delivery port.
- 10' long three-prong cord.
- Available in W - White or B - Black as indicated by last letter of model number.

| PRODUCT CODE | PRICE | SIZE/ INCHES | | | WEIGHT VOL | |
|--------------|-------|--------------|-----|-----|------------|-----------------|
| | | H | W | D | LBS | FT ³ |
| BRED50ACW | 695 | 3 | 5.5 | 3.2 | 3 | 0.2 |
| BRED50ACB | 695 | 3 | 5.5 | 3.2 | 3 | 0.2 |

BREDU51AC • Duo Under Module with A+C

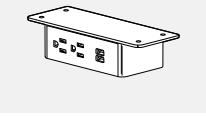

- **The Duo under power module comes with a thin flush mounting bracket to attach to the underside of a work surface or above work surface shelves.**
- Provides two 15 Amp 120 Volt AC Receptacles; 2.4 amp USB-A port and 60 watt USB-C power delivery port.
- 10' long three-prong cord.
- Available in W - White or B - Black as indicated by last letter of model number.

| PRODUCT CODE | PRICE | SIZE/ INCHES | | | WEIGHT VOL | |
|--------------|-------|--------------|-----|-----|------------|-----------------|
| | | H | W | D | LBS | FT ³ |
| BREDU51ACW | 695 | 1.8 | 5.5 | 2.8 | 3 | 0.2 |
| BREDU51ACB | 695 | 1.8 | 5.5 | 2.8 | 3 | 0.2 |

BREDB52AC • Duo Under Module with A+C

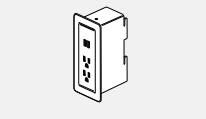

- **The Duo bezel power module is embedded and flush-mounted in a piece of furniture or a work surface.**
- Provides two 15 Amp 120 Volt AC Receptacles; 2.4 amp USB-A port and 60 watt USB-C power delivery port.
- 10' long three-prong cord, silver trim.
- Available in W - White or B - Black as indicated by last letter of model number.
- Will not work on W thick worksurfaces, please contact your Customer Service Representative for specific surface applications.

| PRODUCT CODE | PRICE | SIZE/ INCHES | | | WEIGHT VOL | |
|--------------|-------|--------------|-----|-----|------------|-----------------|
| | | H | W | D | LBS | FT ³ |
| BREDB52ACW | 695 | 4 | 6.5 | 3.2 | 3 | 0.2 |
| BREDB52ACB | 695 | 4 | 6.5 | 3.2 | 3 | 0.2 |

ACCESSORIES

BRETP53AC • Trio Module with A+C



- The Trio plus power module is completely integrated with a mounting clamp to attach to the edge of a work surface or above work surface shelves.
- Provides two 15 Amp 120 Volt AC Receptacles; 2.4 amp USB-A port and 60 watt USB-C power delivery port and an adapter kit containing blank cover, HDMI, RJ45 or VGA adapter brackets. Note: HDMI, RJ45 and VGA connectors are not included.
- 10' long three-prong cord, silver trim.
- Available in W - White or B - Black as indicated by last letter of model number.

| PRODUCT CODE | PRICE | SIZE/ H | INCHES W | D | WEIGHT LBS | VOL FT ³ |
|--------------|-------|---------|----------|-----|------------|---------------------|
| BRETP53ACW | 735 | 3 | 8 | 3.2 | 2.5 | 0.14 |
| BRETP53ACB | 735 | 3 | 8 | 3.2 | 2.5 | 0.14 |

BRETB55AC • Trio Plus Module with A+C



- The Trio plus bezel power module is embedded and flush-mounted in a piece of furniture or a work surface.
- Provides two 15 Amp 120 Volt AC Receptacles; 2.4 amp USB-A port and 60 watt USB-C power delivery port and an adapter kit containing blank cover, HDMI, RJ45 or VGA adapter brackets. Note: HDMI, RJ45 and VGA connectors are not included.
- 10' long three-prong cord, silver trim.
- Available in W - White or B - Black as indicated by last letter of model number.
- Will not work on W thick worksurfaces, please contact your Customer Service Representative for specific surface applications.

| PRODUCT CODE | PRICE | SIZE/ H | INCHES W | D | WEIGHT LBS | VOL FT ³ |
|--------------|-------|---------|----------|-----|------------|---------------------|
| BRETB55ACW | 752 | 4 | 9 | 3.2 | 2.5 | 0.14 |
| BRETPB55ACB | 752 | 4 | 9 | 3.2 | 2.5 | 0.14 |

Telecom Plates

Note: To be used in conjunction with BPGDPS21 and BPGDPS41.



| PRODUCT CODE | PRICE |
|--------------------------------------------|-------|
| Black telecom plate with 2 RJ45 cat 6 data | |
| ABLBB | 245 |



| | |
|--------------------------------------------|-----|
| Black telecom plate with 3 RJ45 cat 6 data | |
| ABLBBB | 361 |



| | |
|--------------------------------------------|-----|
| Black telecom plate with 4 RJ45 cat 6 data | |
| ABLBBBB | 476 |

ACCESSORIES

GCRTMCS401 • Recessed Power Block, 1 Duplex, 1 Data Knock-outs, 1 Power Duplex

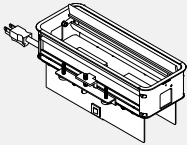

- Single sided recessed power block with 1 regular duplex and 1 data knock-out on top, 1 power duplex on bottom.
- 10 ft power cord with straight plug.
- Telecom plates ordered separately.
- Available in Black - B, Tungsten - T or Designer White - W as indicated by last letter of model number; duplexes always grey.
- Not approved for daisy-chain applications.

| PRODUCT CODE | PRICE | SIZE/ INCHES | | | WEIGHT LBS | VOL FT ³ |
|--------------|-------|--------------|-------|------|------------|---------------------|
| | | H | W | D | | |
| GCRTMCS401B | 578 | 4.86 | 10.78 | 4.22 | 4.3 | 0.51 |
| GCRTMCS401T | 578 | 4.86 | 10.78 | 4.22 | 4.3 | 0.51 |
| GCRTMCS401W | 578 | 4.86 | 10.78 | 4.22 | 4.3 | 0.51 |

GCRTMCS421 • Recessed Power Block, 1 Power including USB A+C, 1 Data Knock-outs, 1 Power Duplex

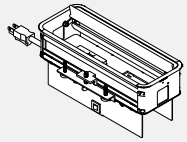

- Single sided recessed power block with 1 power and USB A+C duplex and 1 data knock-out on top, 1 power duplex on bottom.
- USB Type A port charges maximum 2.4 amps at 5V and Type C port charges maximum 3 amps at 5V.
- 10 ft power cord with straight plug.
- Telecom plates ordered separately.
- Available in Black - B, Tungsten - T or Designer White - W as indicated by last letter of model number; duplexes always grey.
- Not approved for daisy-chain applications.

| PRODUCT CODE | PRICE | SIZE/ INCHES | | | WEIGHT LBS | VOL FT ³ |
|--------------|-------|--------------|-------|------|------------|---------------------|
| | | H | W | D | | |
| GCRTMCS421B | 759 | 4.86 | 10.78 | 4.22 | 4.3 | 0.51 |
| GCRTMCS421T | 759 | 4.86 | 10.78 | 4.22 | 4.3 | 0.51 |
| GCRTMCS421W | 759 | 4.86 | 10.78 | 4.22 | 4.3 | 0.51 |

GCRTMCD602 • Recessed Power Block, 2 Duplex, 2 Data Knock-outs, 1 Power Duplex

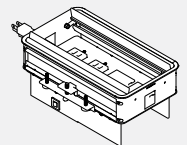

- Double sided recessed power block with 2 regular duplex and 2 data knock-outs on top, 1 power duplex on bottom.
- 10 ft power cord with straight plug.
- Telecom plates ordered separately.
- Available in Black - B, Tungsten - T or Designer White - W as indicated by last letter of model number; duplexes always grey.
- Not approved for daisy-chain applications.

| PRODUCT CODE | PRICE | SIZE/ INCHES | | | WEIGHT LBS | VOL FT ³ |
|--------------|-------|--------------|-------|------|------------|---------------------|
| | | H | W | D | | |
| GCRTMCD602B | 660 | 4.86 | 10.78 | 6.22 | 5.9 | 0.51 |
| GCRTMCD602T | 660 | 4.86 | 10.78 | 6.22 | 5.9 | 0.51 |
| GCRTMCD602W | 660 | 4.86 | 10.78 | 6.22 | 5.9 | 0.51 |

GCRTMCD622 • Recessed Power Block, 1 Duplex, 1 Power including USB A+C, 2 Data Knock-outs, 1 Power Duplex

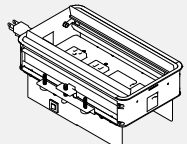

- Double sided recessed power block with 1 regular duplex, 1 power and USB A+C and 2 data knock-outs on top, 1 power duplex on bottom.
- USB Type A port charges maximum 2.4 amps at 5V and Type C port charges maximum 3 amps at 5V.
- 10 ft power cord with straight plug.
- Telecom plates ordered separately.
- Available in Black - B, Tungsten - T or Designer White - W as indicated by last letter of model number; duplexes always grey.
- Not approved for daisy-chain applications.

| PRODUCT CODE | PRICE | SIZE/ INCHES | | | WEIGHT LBS | VOL FT ³ |
|--------------|-------|--------------|-------|------|------------|---------------------|
| | | H | W | D | | |
| GCRTMCD622B | 831 | 4.86 | 10.78 | 6.22 | 6.1 | 0.51 |
| GCRTMCD622T | 831 | 4.86 | 10.78 | 6.22 | 6.1 | 0.51 |
| GCRTMCD622W | 831 | 4.86 | 10.78 | 6.22 | 6.1 | 0.51 |

GCRTMCD642 • Recessed Power Block, 2 Power including USB A+C, 2 Data Knock-outs, 1 Power Duplex

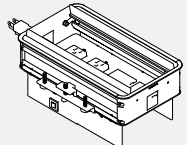

- Double sided recessed power block with 2 power and USB A+C and 2 data knock-outs on top, 1 power duplex on bottom.
- USB Type A port charges maximum 2.4 amps at 5V and Type C port charges maximum 3 amps at 5V.
- 10 ft power cord with straight plug.
- Telecom plates ordered separately.
- Available in Black - B, Tungsten - T or Designer White - W as indicated by last letter of model number; duplexes always grey.
- Not approved for daisy-chain applications.

| PRODUCT CODE | PRICE | SIZE/ INCHES | | | WEIGHT LBS | VOL FT ³ |
|--------------|-------|--------------|-------|------|------------|---------------------|
| | | H | W | D | | |
| GCRTMCD642B | 1001 | 4.86 | 10.78 | 6.22 | 6.3 | 0.51 |
| GCRTMCD642T | 1001 | 4.86 | 10.78 | 6.22 | 6.3 | 0.51 |
| GCRTMCD642W | 1001 | 4.86 | 10.78 | 6.22 | 6.3 | 0.51 |

DABAR • Power Bar

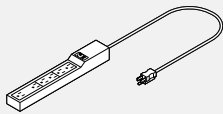

- Power bar with 5 + 1 receptacles (one spaced wide for adapter use), built-in transient voltage surge suppressor and power switch.
- Standard with 10' cord.
- Integrated key hole mounting in the back.
- Rating 15A, 125V, AC 60Hz, 1875W.
- Suppressed voltage rating: 330V peak.

| PRODUCT CODE | PRICE | SIZE/ INCHES | | | WEIGHT LBS | VOL FT ³ |
|--------------|-------|--------------|---|----|------------|---------------------|
| | | H | W | D | | |
| DABAR | 65 | | | 12 | 2 | 0.02 |

BABC • Wire Manager



- Attaches to the underside of the worksurface with a peel and stick adhesive that is located on the top of the wire manager. Comes 10 per package.
- Black only

| PRODUCT CODE | PRICE | SIZE/ INCHES | | | WEIGHT LBS | VOL FT ³ |
|--------------|-------|--------------|---|---|------------|---------------------|
| | | H | W | D | | |
| BABC04 | 41 | 2 | 4 | 2 | 2 | 0.14 |

BRACS • Cable Snake



- Flexible cable management trough.
- Two pathways within the snake, one for data/communication and one for routing power cables.
- Clear (CLR) available only.

| PRODUCT CODE | PRICE | SIZE/ INCHES | | | WEIGHT LBS | VOL FT ³ |
|--------------|-------|--------------|---|---|------------|---------------------|
| | | H | W | D | | |
| BRACS | 127 | 30 | 8 | | 3 | 0.19 |
| BRACSH | 213 | 49 | 8 | | 5 | 0.27 |

ACCESSORIES

ModPower Power Solution

- Power solutions for flexible spaces. Connect up to four units (in Canada)/six units in the USA from a single infeed with NEMA plug to deliver power and charging ports to the table top. In-surface modules and clamp on modules available.
- Easy to install; code compliant that allows users to optimize any space providing convenient power access. Perfect for training areas, meeting rooms, in-office workstations and more. Units feature tamper-resistant receptacles as well as both USB-A and USB-C charging ports.
- Easy to use connectors that are touch-safe with added latch to prevent unintended separation. Easy push together to connect, and simple press down on latch to disconnect.
- Maximum overall length not to exceed 48.5 feet per infeed. UL listed to UL962A SD, the standard for furniture power distribution units for portable/moveable work space tables.
- Certified to CSA standard C22.2 No. 203-16.
- Will work with Licence, Terina and Bridges Products.

- Surface mounted module ships with a clamp mount that will accommodate any material 1/2" to 1-1/2" thick; additional brackets are also included for screw in mounting options that can accommodate vertical or horizontal positions.
- Modules can be integrated into surfaces but the surface must be specified as a special.

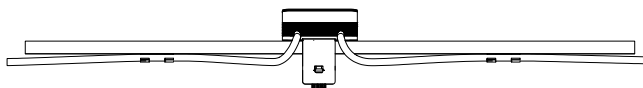
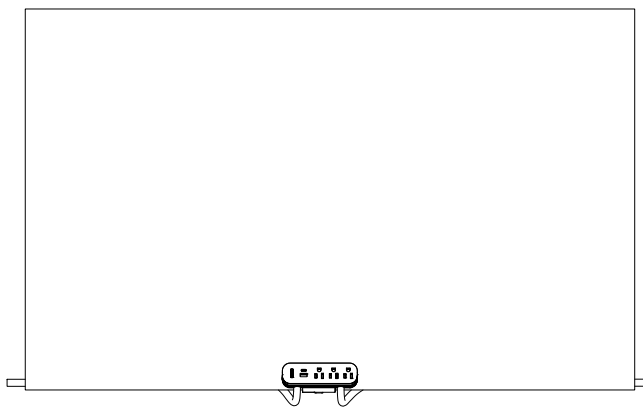
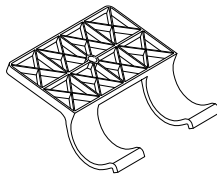

GMDSF10 • ModPower In Surface Starter Unit

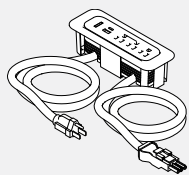

- ModPower starter unit includes one 10' cord with a NEMA plug and one 3' connector cord.
- Unit equipped with three 15A tamper resistant receptacles, one USB-A and one USB-C charging ports and a circuit breaker.
- 4 cable management cord clips included.
- MG at the end of the code indicates a magnesium finish, while WH is a white finish.

| PRODUCT CODE | PRICE | DIMENSIONS | | | WEIGHT | | VOL FT ³ |
|--------------|-------|------------|------|------|--------|-----------------|---------------------|
| | | H | W | D | LBS | FT ³ | |
| GMDSF10MG | 597 | 2.63 | 7.63 | 2.63 | 3.44 | 1.0 | |
| GMDSF10WH | 597 | 2.63 | 7.63 | 2.63 | 3.44 | 1.0 | |

GMDCF3 • ModPower In Surface Middle Unit

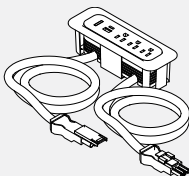

- ModPower middle unit includes two 3' connector cords.
- Unit equipped with three 15A rated 12A tamper resistant receptacles, one USB-A and one USB-C charging ports and a circuit breaker.
- 4 cable management cord clips included.
- MG at the end of the code indicates a magnesium finish, while WH is a white finish.

| PRODUCT CODE | PRICE | DIMENSIONS | | | WEIGHT | | VOL FT ³ |
|--------------|-------|------------|------|------|--------|-----------------|---------------------|
| | | H | W | D | LBS | FT ³ | |
| GMDCF3MG | 562 | 2.63 | 7.63 | 2.63 | 2.44 | 1.0 | |
| GMDCF3WH | 562 | 2.63 | 7.63 | 2.63 | 2.44 | 1.0 | |

GMDEF3 • ModPower In Surface End Unit

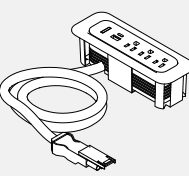

- ModPower end unit includes one 3' connector cord.
- Unit equipped with three 15A rated 12A tamper resistant receptacles, one USB-A and one USB-C charging ports and a circuit breaker.
- 2 cable management cord clips included.
- MG at the end of the code indicates a magnesium finish, while WH is a white finish.

| PRODUCT CODE | PRICE | DIMENSIONS | | | WEIGHT | | VOL FT ³ |
|--------------|-------|------------|------|------|--------|-----------------|---------------------|
| | | H | W | D | LBS | FT ³ | |
| GMDEF3MG | 494 | 2.63 | 7.63 | 2.63 | 1.85 | 1.0 | |
| GMDEF3WH | 494 | 2.63 | 7.63 | 2.63 | 1.85 | 1.0 | |

ACCESSORIES

GMDSA10 • ModPower Starter Mounted Unit

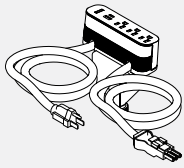

- ModPower starter unit includes one 10' cord with a NEMA plug and one 3' connector cord.
- Unit equipped with three 15A tamper resistant receptacles, one USB-A and one USB-C charging ports and a circuit breaker.
- Includes edge clamp and 3 other mounting methods; and 4 cable management cord clips.
- MG at the end of the code indicates a magnesium finish, while WH is a white finish.

| PRODUCT CODE | PRICE | PRICE | | | WEIGHT | | VOL FT ³ |
|--------------|-------|-------|------|------|--------|-----------------|---------------------|
| | | H | W | D | LBS | FT ³ | |
| GMDSA10MG | 631 | 2.5 | 6.13 | 1.75 | 4.33 | 1.0 | |
| GMDSA10WH | 631 | 2.5 | 6.13 | 1.75 | 4.33 | 1.0 | |

GMDCA3 • ModPower Middle Mounted Unit

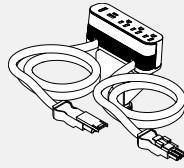

- ModPower middle unit includes two 3' connector cords.
- Unit equipped with three 15A rated 12A tamper resistant receptacles, one USB-A and one USB-C charging ports and a circuit breaker.
- Includes edge clamp and 3 other mounting methods; and 4 cable management cord clips.
- MG at the end of the code indicates a magnesium finish, while WH is a white finish.

| PRODUCT CODE | PRICE | PRICE | | | WEIGHT | | VOL FT ³ |
|--------------|-------|-------|------|------|--------|-----------------|---------------------|
| | | H | W | D | LBS | FT ³ | |
| GMDCA3MG | 597 | 2.5 | 6.13 | 1.75 | 3.33 | 1.0 | |
| GMDCA3WH | 597 | 2.5 | 6.13 | 1.75 | 3.33 | 1.0 | |

GMDEA3 • ModPower End Mounted Unit

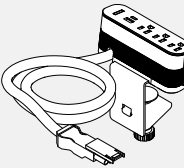

- ModPower end unit includes one 3' connector cord.
- Unit equipped with three 15A rated 12A tamper resistant receptacles, one USB-A and one USB-C charging ports and a circuit breaker.
- Includes edge clamp and 3 other mounting methods; and 2 cable management cord clips.
- MG at the end of the code indicates a magnesium finish, while WH is a white finish.

| PRODUCT CODE | PRICE | PRICE | | | WEIGHT | | VOL FT ³ |
|--------------|-------|-------|------|------|--------|-----------------|---------------------|
| | | H | W | D | LBS | FT ³ | |
| GMDEA3MG | 528 | 2.5 | 6.13 | 1.75 | 2.75 | 1.0 | |
| GMDEA3WH | 528 | 2.5 | 6.13 | 1.75 | 2.75 | 1.0 | |

GMDCLIPS • ModPower Management Clips

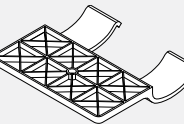

- Includes 10 clips.

| PRODUCT CODE | PRICE | PRICE | | | WEIGHT | | VOL FT ³ |
|--------------|-------|-------|-----|-----|--------|-----------------|---------------------|
| | | H | W | D | LBS | FT ³ | |
| GMDCLIPS | 102 | 0.6 | 2.6 | 2.5 | 0.3 | 0.2 | |

GMDJ36BK • ModPower Interconnecting Jumper

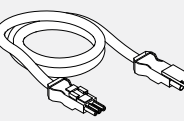

- ModPower interconnecting jumper cord to add an additional 3 feet of cord length between ModPower units.
- Package of 2, each 3 feet with male & female connector.

| PRODUCT CODE | PRICE | PRICE | | | WEIGHT | | VOL FT ³ |
|--------------|-------|-------|----|---|--------|-----------------|---------------------|
| | | H | W | D | LBS | FT ³ | |
| GMDJ36BK | 329 | | 36 | | 1.38 | 0.9 | |

GMDPC22W • Slim Desktop Power Module, 2 Duplex



- Desktop power center with two 15A tamper resistant power receptacles, one USB-A and one USB-C (provides 3.1A); 10' power cord.
- Includes three mounting options (i) a screw-in mounting plate for forward facing outlets; or (ii) an under surface mount bracket; or (iii) a clamp mounting kit for 0.5-1.5" thick surfaces.
- Gloss white body with grey face.

| PRODUCT CODE | PRICE | PRICE | | | WEIGHT | | VOL FT ³ |
|--------------|-------|-------|------|------|--------|-----------------|---------------------|
| | | H | W | D | LBS | FT ³ | |
| GMDPC22W | 449 | 2.25 | 4.88 | 2.25 | 2.5 | 0.5 | |

GMDPC32W • Slim Desktop Power Module, 3 Duplex

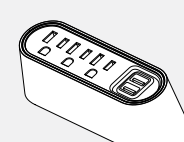

- Desktop power center with three 15A tamper resistant power receptacles, one USB-A and one USB-C (provides 3.1A); 10' power cord.
- Includes three mounting options (i) a screw-in mounting plate for forward facing outlets; or (ii) an under surface mount bracket; or (iii) a clamp mounting kit for 0.5-1.5" thick surfaces.
- Gloss white body with grey face.

| PRODUCT CODE | PRICE | PRICE | | | WEIGHT | | VOL FT ³ |
|--------------|-------|-------|------|------|--------|-----------------|---------------------|
| | | H | W | D | LBS | FT ³ | |
| GMDPC32W | 586 | 2.25 | 6.00 | 2.25 | 2.6 | 0.5 | |

ACCESSORIES

BAVC • Vertical Wire Channel



- PVC extrusion attaches to panel vertical to provide enclosure for a power or light cord.
- Available in 16" and 32" lengths, six per package.
- Can be cut to required lengths on site.
- Panel frame finish

| PRODUCT CODE | PRICE | SIZE/ | INCHES | | WEIGHT VOL | |
|--------------|-------|-------|--------|---|------------|-----------------|
| | | H | W | D | LBS | FT ³ |
| BAVC016 | 38 | | 16 | | 0.5 | 0.018 |
| BAVC032 | 80 | | 32 | | 1.0 | 0.036 |

VVCM • Wire Manager

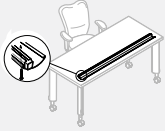

- Replacement wire manager can be added to Viceversa tables. Wire manager neatly organizes and stores electrical and communication cables.
- Two lengths, 46" for tops 60" and under, 58" for tops 72".
- Mounts below surface via threaded metal inserts.
- Integrated steel reinforcement bar.
- Not required on oval, 1/2 ellipse, 1/2 moon, square or round table.

| PRODUCT CODE | PRICE | SIZE/ | INCHES | | | WEIGHT VOL | |
|--------------|-------|-------|--------|----|-----|-----------------|--|
| | | H | D | W | LBS | FT ³ | |
| VVCM43 | 143 | 3 | 5 | 46 | 8 | 0.67 | |
| VVCM55 | 169 | 3 | 5 | 58 | 9 | 0.85 | |

BAR • Panel Mounted Slotted Accessory Rail for Boulevard

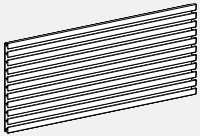

- Includes 10 horizontal slats for hanging capacity.
- Includes mousing hardware.
- Panel frame finish

Hangs on standard Boulevard panels and accepts standard accessories.

| PRODUCT CODE | PRICE | SIZE/ | INCHES | | | WEIGHT VOL | |
|--------------|-------|-------|--------|-----|-----|-----------------|--|
| | | H | W | D | LBS | FT ³ | |
| BAR18 | 161 | 10.6 | 18 | 0.5 | 3 | 0.12 | |
| BAR24 | 176 | 10.6 | 24 | 0.5 | 4 | 0.17 | |
| BAR30 | 195 | 10.6 | 30 | 0.5 | 5 | 0.22 | |
| BAR36 | 211 | 10.6 | 36 | 0.5 | 6 | 0.26 | |
| BAR42 | 231 | 10.6 | 42 | 0.5 | 7 | 0.31 | |
| BAR48 | 246 | 10.6 | 48 | 0.5 | 8 | 0.35 | |
| BAR54 | 262 | 10.6 | 54 | 0.5 | 9 | 0.43 | |
| BAR60 | 280 | 10.6 | 60 | 0.5 | 10 | 0.49 | |

BALB • Panel Mounted Load Bar for Boulevard

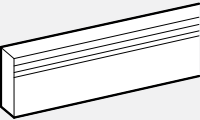

- Can be panel mounted or wall mounted on rail (BHV01 or BHV02).
- Includes mousing brackets and end caps.
- Panel frame finish

| PRODUCT CODE | PRICE | SIZE/ | INCHES | | | WEIGHT VOL | |
|--------------|-------|-------|--------|------|-----|-----------------|--|
| | | H | W | D | LBS | FT ³ | |
| BALB18 | 122 | 3.5 | 18 | 0.75 | 2 | 0.031 | |
| BALB24 | 133 | 3.5 | 24 | 0.75 | 2 | 0.038 | |
| BALB30 | 146 | 3.5 | 30 | 0.75 | 3 | 0.048 | |
| BALB36 | 162 | 3.5 | 36 | 0.75 | 3 | 0.057 | |
| BALB42 | 187 | 3.5 | 42 | 0.75 | 4 | 0.067 | |
| BALB48 | 213 | 3.5 | 48 | 0.75 | 4 | 0.076 | |
| BALB54 | 234 | 3.5 | 54 | 0.75 | 5 | 0.086 | |
| BALB60 | 247 | 3.5 | 60 | 0.75 | 5 | 0.096 | |

BADLB • Panel Mounted Accessory Rail for Boulevard

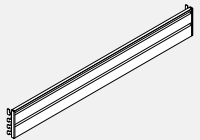

- Enables accessory items to be hung from a panel.
- Includes end caps and mounting brackets.

| PRODUCT CODE | PRICE | SIZE/ | INCHES | | | WEIGHT VOL | |
|--------------|-------|-------|--------|------|------|-----------------|--|
| | | H | W | D | LBS | FT ³ | |
| BADLB18 | 195 | 4.23 | 18 | 1.53 | 2.34 | 0.07 | |
| BADLB24 | 205 | 4.23 | 24 | 1.53 | 2.88 | 0.09 | |
| BADLB30 | 217 | 4.23 | 30 | 1.53 | 3.42 | 0.11 | |
| BADLB36 | 231 | 4.23 | 36 | 1.53 | 3.97 | 0.13 | |
| BADLB42 | 240 | 4.23 | 42 | 1.53 | 4.51 | 0.16 | |
| BADLB48 | 253 | 4.23 | 48 | 1.53 | 5.05 | 0.18 | |
| BADLB54 | 265 | 4.23 | 54 | 1.53 | 5.59 | 0.20 | |
| BADLB60 | 275 | 4.23 | 60 | 1.53 | 6.13 | 0.22 | |

BABB01 • Binder Bin

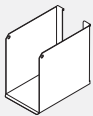

- Load bar/accessory rail mounted metal binder bin.
- Panel frame finish

| PRODUCT CODE | PRICE | SIZE/ | INCHES | | | WEIGHT VOL | |
|--------------|-------|-------|--------|------|------|-----------------|--|
| | | H | W | D | LBS | FT ³ | |
| BABB01 | 58 | 9 | 5.75 | 9.25 | 1.85 | 0.21 | |

BAFS01 • Flip Sorter

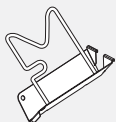

- Load bar/accessory rail mounted metal flip sorter. Comes with chrome wire.
- Panel frame finish

| PRODUCT CODE | PRICE | SIZE/ | INCHES | | | WEIGHT VOL | |
|--------------|-------|-------|--------|---|-----|-----------------|--|
| | | H | W | D | LBS | FT ³ | |
| BAFS01 | 40 | 9 | 3 | 9 | 0.6 | 0.14 | |

ACCESSORIES

BASS01 • Slant Sorter

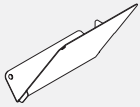

Right Shown

- Load bar/accessory rail mounted metal slant sorter.
- Panel frame finish

| PRODUCT CODE | PRICE | SIZE/ INCHES | | | WEIGHT VOL | |
|--------------|-------|--------------|------|---|------------|-----------------|
| | | H | W | D | LBS | FT ³ |
| BASS01R | 35 | 9.25 | 2.75 | 9 | 1 | 0.28 |
| BASS01L | 35 | 9.25 | 2.75 | 9 | 1 | 0.28 |

BALT • Letter Tray/Legal Tray

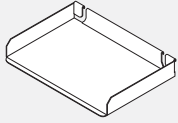

- Load bar/accessory rail mounted metal letter or legal tray.
- Panel frame finish

| PRODUCT CODE | PRICE | SIZE/ INCHES | | | WEIGHT VOL | |
|--------------|-------|--------------|------|------|------------|-----------------|
| | | H | W | D | LBS | FT ³ |
| BALT01 | 43 | 1.75 | 12 | 8.75 | 0.5 | 0.15 |
| BALT01LGL | 58 | 1.75 | 14.7 | 8.75 | 0.5 | 0.15 |

BAMB01 • Media Bin

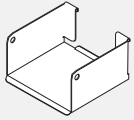

- Load bar/accessory rail mounted metal media bin.
- Panel frame finish

| PRODUCT CODE | PRICE | SIZE/ INCHES | | | WEIGHT VOL | |
|--------------|-------|--------------|------|------|------------|-----------------|
| | | H | W | D | LBS | FT ³ |
| BAMB01 | 43 | 3 | 5.75 | 5.25 | 0.8 | 0.05 |

BAUT01 • Utility Tray

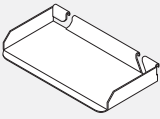

- Load bar/accessory rail mounted metal utility tray.
- Panel frame finish

| PRODUCT CODE | PRICE | SIZE/ INCHES | | | WEIGHT VOL | |
|--------------|-------|--------------|-----|---|------------|-----------------|
| | | H | W | D | LBS | FT ³ |
| BAUT01 | 30 | 1 | 7.5 | 4 | 0.5 | 0.02 |

BAPP01 • Mail Box

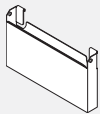

- Freestanding unit or load bar/accessory rail mounted.
- Panel frame finish

| PRODUCT CODE | PRICE | SIZE/ INCHES | | | WEIGHT VOL | |
|--------------|-------|--------------|----|------|------------|-----------------|
| | | H | W | D | LBS | FT ³ |
| BAPP01 | 72 | 7 | 12 | 1.75 | 2 | 0.25 |

BATH01 • Telephone Holder

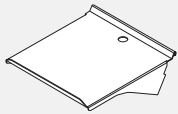

- Load bar/rail mounted telephone holder.
- Panel frame finish

| PRODUCT CODE | PRICE | SIZE/ INCHES | | | WEIGHT VOL | |
|--------------|-------|--------------|---|----|------------|-----------------|
| | | H | W | D | LBS | FT ³ |
| BATH01 | 68 | 2 | 8 | 10 | 2 | 0.26 |

BAPD1821 • Pencil Drawer

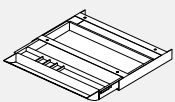

- Provides accommodation for writing instruments and small items at the workspace.
- Attaches to the underside of worksurface with drawer slides.
- Available in Black ABS Only

| PRODUCT CODE | PRICE | TAILLE/ POUCES | | | POIDS VOLUME | |
|--------------|-------|----------------|------|------|--------------|-----------------|
| | | H | L | P | LB | PI ³ |
| BAPD1821 | 125 | 1.9 | 21.2 | 16.1 | 0.5 | 0.3 |

BAHO • Coat Hook

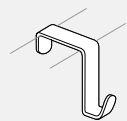

- Over the panel mounted coat hook for Boulevard 1 panels only. Priced six per package.
- Panel Frame Finish

| PRODUCT CODE | PRICE | SIZE/ INCHES | | | WEIGHT VOL | |
|--------------|-------|--------------|---|---|------------|-----------------|
| | | H | W | D | LBS | FT ³ |
| BAHO3080 | 63 | 3 | 1 | 3 | 0.2 | 0.001 |

BAHB3CH • Coat Hook for System 3

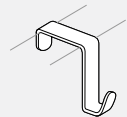

- Over the panel mounted coat hook for Boulevard, System 3 panels or Boulevard 1 panels with top trim. Priced six per package.
- Panel Frame Finish

| PRODUCT CODE | PRICE | SIZE/ INCHES | | | WEIGHT VOL | |
|--------------|-------|--------------|---|---|------------|-----------------|
| | | H | W | D | LBS | FT ³ |
| BAHB3CH | 83 | 3 | 1 | 3 | 0.2 | 0.001 |

DAHOCH • Coat Hook for Diet

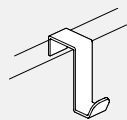

- Panel mounted coat hook Diet Panels.
- Panel Frame Finish

| PRODUCT CODE | PRICE | SIZE/ INCHES | | | WEIGHT VOL | |
|--------------|-------|--------------|------|---|------------|-----------------|
| | | H | W | D | LBS | FT ³ |
| DAHOCH | 29 | 3 | 0.75 | 3 | 0.2 | 0.001 |

ACCESSORIES

BPNP • Boulevard Name Plate

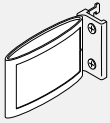

- Name plate attaches to 1" increment slots of Boulevard. It can be set either as a single-sided (parallel to panel surface) or double-sided (perpendicular to panel surface - for aisle applications, displaying name on both sides).
- Injection molded frame and die-cast base with black rubberized finish. Steel bracket and fasteners included.
- Includes two slide-in name cards.

| PRODUCT CODE | PRICE | SIZE/ INCHES | | | WEIGHT VOL | |
|--------------|-------|--------------|-----|------|------------|-----------------|
| | | H | W | D | LBS | FT ³ |
| BPNP01 | 82 | 3.3 | 5.3 | 1.25 | 0.3 | 0.013 |

DPNP01 • Diet Name Plate

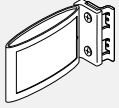

- Name plate can be set either as a single-sided (parallel to panel surface) or double-sided (perpendicular to panel surface - for aisle applications, displaying name on both sides).
- Injection molded frame and die-cast base with black rubberized finish. Steel bracket and fasteners included.
- Includes two slide-in name cards.

| PRODUCT CODE | PRICE | SIZE/ INCHES | | | WEIGHT VOL | |
|--------------|-------|--------------|-----|------|------------|-----------------|
| | | H | W | D | LBS | FT ³ |
| DPNP01 | 82 | 3.3 | 5.3 | 1.25 | 0.3 | 0.013 |

BHTPO1 • Bracket to connect Licence Towers to Boulevard Panels

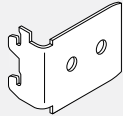

- Panel Frame Finish

| PRODUCT CODE | PRICE | SIZE/ INCHES | | | WEIGHT VOL | |
|--------------|-------|--------------|-----|---|------------|-----------------|
| | | H | W | D | LBS | FT ³ |
| BHTPO1 | 64 | 2 | 2.5 | 1 | 2 | 0.05 |

BATB • Fabric Tackboard for Boulevard

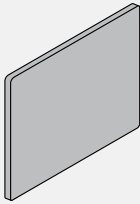

- To provide a tackable surface for notes and memos in a work area. Panel mounted.
- Includes mounting brackets.
- Class "A" Fire Rated Fabric.

| PRODUCT CODE | PRICE | | SIZE/ INCHES | | | WEIGHT VOL | |
|--------------|-------|-----|--------------|----|---|------------|-----------------|
| | GR1 | GR2 | H | W | D | LBS | FT ³ |
| BATB2430 | 298 | 312 | 24 | 30 | | 3 | 0.416 |
| BATB2436 | 340 | 352 | 24 | 36 | | 4 | 0.500 |
| BATB2442 | 388 | 404 | 24 | 42 | | 4 | 0.583 |
| BATB2448 | 433 | 462 | 24 | 48 | | 5 | 0.666 |
| BATB2454 | 478 | 509 | 24 | 54 | | 5 | 0.750 |
| BATB2460 | 524 | 555 | 24 | 60 | | 6 | 0.833 |
| BATB2472 | 636 | 678 | 24 | 72 | | 6 | 0.999 |

BAWB • Write Board for Boulevard

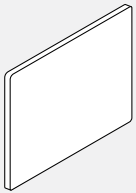

- To provide a writing surface in a work area. Panel mounted.
- Includes mounting brackets.
- Black Trim Only

| PRODUCT CODE | PRICE | SIZE/ INCHES | | | WEIGHT VOL | |
|--------------|-------|--------------|----|---|------------|-----------------|
| | | H | W | D | LBS | FT ³ |
| BAWB2436 | 350 | 24 | 36 | | 13 | 0.500 |
| BAWB2442 | 391 | 24 | 42 | | 15 | 0.583 |
| BAWB2448 | 454 | 24 | 48 | | 18 | 0.666 |

BAMT12 • Marker Tray

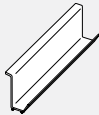

- Marker tray intended for BATB and BAWB only.

| PRODUCT CODE | PRICE | SIZE/ INCHES | | | WEIGHT VOL | |
|--------------|-------|--------------|----|---|------------|-----------------|
| | | H | W | D | LBS | FT ³ |
| BAMT12 | 16 | | 12 | | 0.5 | 0.01 |

BATP • Touch Up Paint Kit



- Paint to match panel frame colours for easy touch ups. 1/2oz. (15ml) bottle

| PRODUCT CODE | PRICE | SIZE/ INCHES | | | WEIGHT VOL | |
|--------------|-------|--------------|---|---|------------|-----------------|
| | | H | W | D | LBS | FT ³ |
| BATP91 | 41 | | | | 0.41 | 0.1 |

ACCESSORIES

CATB • Tackboard for Compile

- Mounting brackets included.

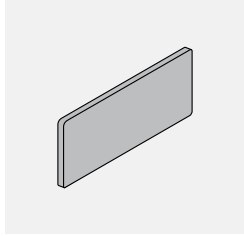

| PRODUCT CODE | PRICE | | SIZE/INCHES | | | WEIGHT VOL | |
|--------------|-------|-----|-------------|----|---|------------|-----------------|
| | GR1 | GR2 | H | W | D | LBS | FT ³ |
| CATB1024 | 192 | 200 | 10 | 24 | 1 | 1 | 0.175 |
| CATB1030 | 201 | 212 | 10 | 30 | 1 | 1 | 0.208 |
| CATB1036 | 221 | 236 | 10 | 36 | 1 | 2 | 0.250 |
| CATB1042 | 245 | 260 | 10 | 42 | 1 | 2 | 0.291 |
| CATB1048 | 270 | 284 | 10 | 48 | 1 | 3 | 0.333 |
| CATB1054 | 297 | 317 | 10 | 54 | 1 | 3 | 0.370 |
| CATB1060 | 317 | 340 | 10 | 60 | 1 | 4 | 0.415 |
| CATB2124 | 276 | 284 | 21 | 24 | 1 | 2 | 0.340 |
| CATB2130 | 298 | 312 | 21 | 30 | 1 | 2 | 0.406 |
| CATB2136 | 340 | 352 | 21 | 36 | 1 | 3 | 0.490 |
| CATB2142 | 388 | 404 | 21 | 42 | 1 | 3 | 0.573 |
| CATB2148 | 433 | 462 | 21 | 48 | 1 | 4 | 0.656 |
| CATB2154 | 478 | 509 | 21 | 54 | 1 | 4 | 0.740 |
| CATB2160 | 524 | 555 | 21 | 60 | 1 | 5 | 0.823 |
| CATB2424 | 276 | 284 | 24 | 24 | 1 | 3 | 0.350 |
| CATB2430 | 298 | 312 | 24 | 30 | 1 | 3 | 0.416 |
| CATB2436 | 340 | 352 | 24 | 36 | 1 | 4 | 0.500 |
| CATB2442 | 388 | 404 | 24 | 42 | 1 | 4 | 0.583 |
| CATB2448 | 433 | 462 | 24 | 48 | 1 | 5 | 0.666 |
| CATB2454 | 478 | 509 | 24 | 54 | 1 | 5 | 0.750 |
| CATB2460 | 524 | 555 | 24 | 60 | 1 | 6 | 0.833 |

CAWB • Whiteboard for Compile

- Mounting brackets included.

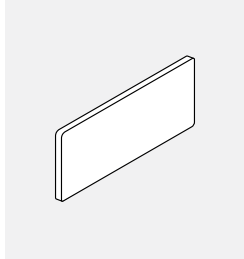

| PRODUCT CODE | PRICE | | SIZE/INCHES | | | WEIGHT VOL | |
|--------------|-------|--|-------------|----|-------|------------|-----------------|
| | | | H | W | D | LBS | FT ³ |
| CAWB1024 | 168 | | 10 | 24 | 0.625 | 5 | 0.210 |
| CAWB1036 | 190 | | 10 | 36 | 0.625 | 6 | 0.394 |
| CAWB1042 | 211 | | 10 | 42 | 0.625 | 7 | 0.470 |
| CAWB1048 | 240 | | 10 | 48 | 0.625 | 8 | 0.540 |
| CAWB2124 | 279 | | 21 | 24 | 0.625 | 11 | 0.400 |
| CAWB2136 | 333 | | 21 | 36 | 0.625 | 12 | 0.485 |
| CAWB2142 | 372 | | 21 | 42 | 0.625 | 14 | 0.564 |
| CAWB2148 | 433 | | 21 | 48 | 0.625 | 17 | 0.621 |
| CAWB2424 | 279 | | 24 | 24 | 0.625 | 12 | 0.422 |
| CAWB2436 | 333 | | 24 | 36 | 0.625 | 13 | 0.500 |
| CAWB2442 | 372 | | 24 | 42 | 0.625 | 15 | 0.583 |
| CAWB2448 | 433 | | 24 | 48 | 0.625 | 18 | 0.666 |

CALB • Load Bar for Compile

- Available in standard panel frame colours.
- Mounting brackets and clear end caps included.
- Optional - Load Bar can connect to each other to create a "Slat Wall".

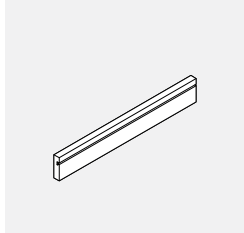

| PRODUCT CODE | PRICE | | SIZE/INCHES | | | WEIGHT VOL | |
|--------------|-------|--|-------------|----|---|------------|-----------------|
| | | | H | W | D | LBS | FT ³ |
| CALB24 | 133 | | 2.25 | 24 | 1 | 2 | 0.083 |
| CALB30 | 146 | | 2.25 | 30 | 1 | 3 | 0.048 |
| CALB36 | 161 | | 2.25 | 36 | 1 | 3 | 0.057 |
| CALB42 | 187 | | 2.25 | 42 | 1 | 4 | 0.067 |
| CALB48 | 213 | | 2.25 | 48 | 1 | 4 | 0.076 |
| CALB54 | 234 | | 2.25 | 54 | 1 | 5 | 0.086 |
| CALB60 | 247 | | 2.25 | 60 | 1 | 5 | 0.096 |

CMECC • Cable Cover for Compile

- Available in standard panel frame colours.
- Comes 6 per package

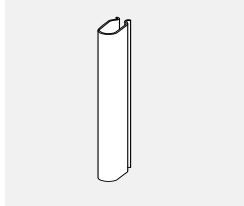

| PRODUCT CODE | PRICE | | SIZE/INCHES | | | WEIGHT VOL | |
|--------------|-------|--|-------------|-----|---|------------|-----------------|
| | | | H | W | D | LBS | FT ³ |
| CMECC21 | 31 | | 21 | 0.5 | 1 | 0.5 | 0.018 |
| CMECC36 | 56 | | 36 | 0.5 | 1 | 1.0 | 0.036 |

CMCH01 • Coat Hook for Compile

- Coat hook for Compile panels.

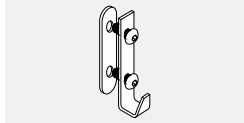

| PRODUCT CODE | PRICE | | SIZE/ INCHES | | | WEIGHT VOL | |
|--------------|-------|--|--------------|------|---|------------|-----------------|
| | | | H | W | D | LBS | FT ³ |
| CMCH01 | 43 | | 5.5 | 0.65 | 1 | 0.06 | 0.001 |

ENVIRONMENTAL COMMITMENT

Evolve Systems-Protecting the Environment for Future Generations

- Our environmental success story began with the challenge to create an office system that would meet today's business requirements while maintaining a firm commitment to save and protect the environment.
- Sustainability became a part of the creative focus and development of Evolve that incorporates the latest technology and design features to provide excellent performance at a competitive price.
- As government and industry environment ratings such as LEED become more prevalent, Evolve offers designers and architects functional, attractive, and economical office designs that meet these standards.
- Evolve is a leader in reducing waste and recycling materials in the manufacture of its products. We make extensive use of recycled plastic and wood waste from other Global factories.
- Evolve is committed to exercise diligence in the continuous improvement of our environmental systems, the prevention of pollution, and to comply with both the spirit and the letter of all relevant environmental legislation.
- Evolve panels are 100% recyclable at the end of their lifespan. Nothing from an Evolve panel needs to end up in a landfill.

Evolve Systems-Product Information

- Evolve offers fabrics that are made from 100% recycled polyester, which means less waste going to landfills, reduced demand for petroleum products, and fewer environmental impacts from the processing of petroleum products into polyester.
- Evolve has developed a panel interior made from 100% recycled wood and polypropylene. Through innovative design and technology, Evolve utilizes waste that would have normally been sent to landfill.
- Evolve panels are insulated with a mineral fibre insulation made from slag (an inert steel by-product) and basalt rock. This material's high density provides maximum sound absorption to reduce noise in the work environment. Mineral fibre insulation is fire resistant, water repellent and will not support the growth of fungi or mildew.

Evolve Systems-Special Product

- When ordering specials, copies of the Special Quote Form (SQ's) must be submitted with the order to ensure accuracy of the special product.

PANELS

- Panel Fabric modules consist of Module Frames, Module Interiors and Fabric Skins. **Module Construction**

- Module Frames feature a combination of 100% recycled PVC horizontal extrusions and unique, molded vertical ends made from equal parts of 100% recycled polypropylene and 100% recycled wood (from Global's factory waste).
- Module Interiors feature honeycomb made from 75% recycled kraft paper and acoustical mineral board derived from slag (inert steel by-product) and volcanic material.

Fabric

- Fabric offerings include selections woven with 100% recycled yarn.

Panel Frame

- Panel Frame is made of cold rolled steel which has a recycled content of 25%. **Metal Components/Raceway Finish**
- All metal components are painted with environmentally friendly epoxy powder.
- Raceway interiors are coated with recycled epoxy powder.

Panel Options

- Factory installed Panel Modules are available in 6", 12", 18" and 24" heights and a variety of options including: Semi-Tackable Fabric Acoustic, Glass, Open, Slatwall, Laminate and Whiteboard Modules.

- Standard Fabric Acoustic Panels come in a variety of heights: 30", 42", 54" and 66". Monolithic Panels are available in 42", 48", 54".
- Panel Extension Modules attach to the top of the base structural panels. These are offered in 6", 12", 18" and 24" heights and can be stacked one on top of the other to create a visually continuous panel in excess of 14'-0" high.
- Panels can be modified on-site by swapping fabric modules for glazed, open, laminate or whiteboard modules at any time after the initial installation. Panels can also be altered in height by replacing the vertical liners (panel sides) and adding or subtracting modules as required.
- Panel widths come in 8 sizes including: 18", 24", 30", 36", 42", 48", 54" and 60".
- All Fabric Modules are semi-tackable.
- One sided and two sided whiteboard modules are available.
- Panels conform to CGSB and ANSI/BIFMA standards.
- Evolve panels carry an acoustical rating of .65 NRC and 20 STC.
- Rigid, steel panel frame is 2 7/8" thick.
- Levelling glides extend 2 1/2".

VOICE/DATA AND ELECTRIC POWER

- Voice/data cables can be laid in at both the base and the top of the panel.
- 8 wire, 4 circuit electrical capability, 2 utility + 2 dedicated circuits, each with 10 gauge (oversized) neutrals. All circuits are 20 amps (15 CSA).
- Additional 8 wire features. No tools required.
- Both power and data is available at desk height.
- Raceway Cover opening sizes conform to the ANSI/TIA/EIA Furniture Opening Standard of 1.37 x 2.68.
- Panels and electrical components are CSA/UL approved.

WORKSURFACES

- Worksurfaces come in a variety of shapes and sizes. Essentially, they are 18", 24" or 30" deep and are available in 6" increments from 24" to 72" wide. Custom tops are available at a modest upcharge and on the same delivery schedule.
- Cable scoops located at the back of each worksurface provide routing of power and data cables.
- Metal inserts for the connection of supporting hardware.
- Thermally fused and high pressure laminate tops are available, both with tough PVC edging.
- All worksurfaces utilize balanced construction.
- Curved worksurfaces incorporate ergonomic design.

OVERHEAD STORAGE

Features:

- Steel and all laminate based options
- Panel mount and up-mount options
- Completely enclosed unit for 16" overheads
- Style dependent- ship fully assembled or knocked down
- 13.5" inside height for oversized binders
- Metal-to-metal connection
- Lock secures into bottom shelf
- Doors operate smoothly
- Flipper door retrofittable on site
- Safety bracket used for extra support
- Reinforcement built in for larger unit
- Can be removed and reconfigured without disassembly

Fronts:

- Open or closed fronts
- AODA compliant options available

Sizes:

- Overheads - 7 widths in 6" increments
- Shelves - 7 widths in 6" increments
- 13.5" deep welded overheads
- 14.2" deep AODA overheads
- 16.5" deep welded overheads for EDP, ring binder, letter/legal

Paint:

- Dry epoxy powder coating

PEDESTALS

Features:

- Premium quality steel reinforced welded construction
- Double wall construction on all drawer fronts
- Fully progressive suspension system
- Full pull
- Worksurface supporting option
- Full extension roller bearing glides on all file drawers
- Rubber bumpers for quietness
- Movable drawer divider in box drawers
 - Pencil Tray
 - Each file drawer includes a hanging file bar (22" and 28" depth only)
- 3 depths with varying filing capacity
- Random or specific keying instructions available

Construction:

- Double wall drawer fronts
- 18-20 gauge steel case components

Sizes:

- (Prime) 18", 22", 28" depth
- (9300) 19", 23", 29" depth

Types:

- Worksurface Supporting, Mobile, Freestanding

Paint:

- Dry epoxy powder coating

WARRANTIES AND PERFORMANCE

- Lifetime Warranty.
- Non Obsolescence Warranty.
- Aggressive product pricing.
- Reduced cost of assembly and reconfiguration.
- Exceptions: panel textiles, electrical devices and task lights - 5 years.
- ISO9001:2000 Registered.
- ISO14001:2004 Registered.
- Greenguard Certified.
- ANSI/BIFMA CGSB testing on all products.
- Run through capability.

PANELS • TECHNICAL INFORMATION

- Evolve panels are 2 7/8" thick. They are available in four (5) basic heights: 30", 42", 48", 54" and 66" and eight (8) widths: 18" to 60" in 6" increments.
- Individual fabric covered acoustic modules incorporated into a rigid steel frame.
- Opposite side of each module may have a different fabric within the same grade at no upcharge.
- If different grades of fabric are used on one panel, the entire panel must be priced at highest grade.
- A low profile top cap is included. It allows for storage of up to 8, 5mm (0.002") diameter data cables.
- No panel creep.
- All Panels, except Monolithic are composed of a 6" raceway module and a 24"

high base module. Subsequent heights are created by adding either a 12" high module or a 24" high module.

- Raceway openings are 1.37 x 2.68
- 12" high and 24" high modules of all types (fabric, laminate, glass, open) are available for field installation. Contact your Customer Service Representative for requirements and installation.
- Frosted glazing is available at an upcharge, please contact your Customer Service Representative.
- Laminate for laminate panels cannot be replaced in the field, complete module must be ordered.
- Writeboard for Writeboard panels cannot be replaced in the field, complete module must be ordered.

PANEL CONNECTORS • TECHNICAL INFORMATION

Panel Connectors

- Available in one-way, two-way, three-way or four-way based on the configuration.
- Available with either PVC or Aluminum Trims.
- 6" high connectors cannot be stacked on top of each other.

Panel Trims

- Available in PVC or Aluminum.

COMPONENTS

A. EVPERA66

End-of-Run Kit (Wall mount) Note: adds 1" to the width of a panel run.

B. EVPFA6636

Fabric Acoustic Panel Note: there is no panel creep.

C. EVPIC66

Inline Panel Connector

D. EVPCPA266

Two-Way Corner Post Note: trim kit included. Post Connectors can be custom manufactured with or without slots on one side only. Contact your Evolve Customer Service Representative for a special quote.

E. EVPVTLA66

Vertical "L" Trim Note: Can be purchased separately when required for reconfiguration

F. EVPVC66

Variable-Height Connector Note: Connector height must reference taller panel. (Must be ordered separately).

G. EVPTVA24

Panel Trim Variable-Height

H. EVPFA4236

Fabric Acoustic Panel

I. EVPTNTA36

Panel Top Notched Trim

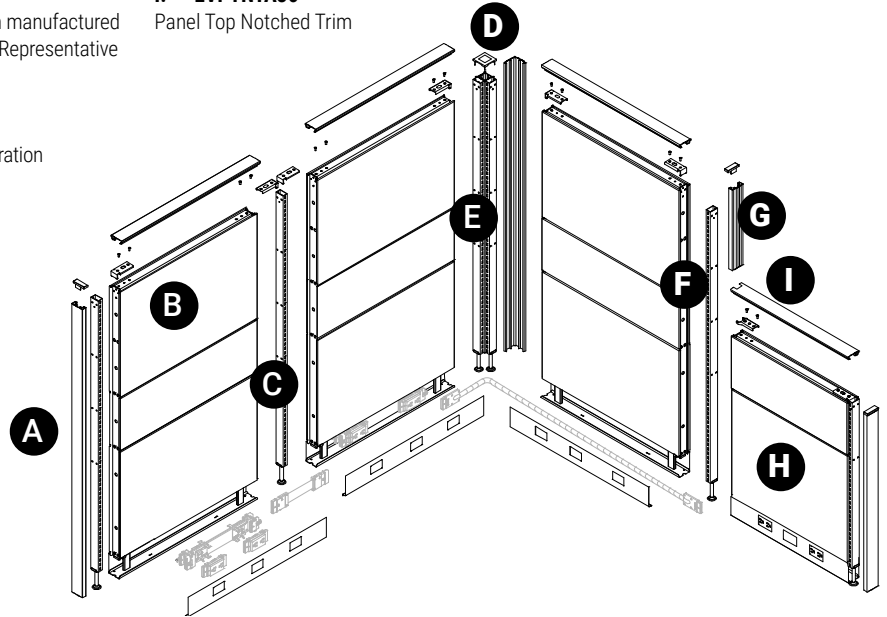

CONNECTORS • TECHNICAL INFORMATION

Slotted connectors and trim are included with each Variable-Height Corner Post. The height of each slotted connector must be specified when ordering a Variable-Height Corner Post. Slotted connector height is determined by the height of the connecting panel run.

Example:

Step 1 Specify base code listed on pricing page.

Fabric Acoustic Panel:

Step 2 Specify slotted connector heights.

Note: To specify height, use the first number of the connecting panel run height dimension.

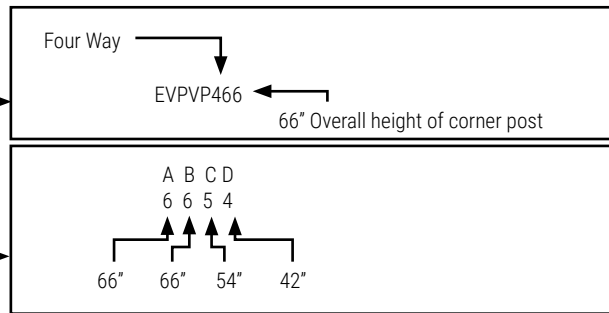

PANELS

- The entire Evolve panel and the processes to manufacture it are designed to save and protect the environment. Evolve panels are made from recycled materials and are 100% recyclable.
- Evolve makes it easy to select a panel function type and height that is suitable for your application.
- The extension module makes private offices available, with the use of Panel Extension Modules combined with a door.
- When Panel Extension Modules are used in the initial installation in conjunction with low panels (30" to 42"), future panel height flexibility is attained while maintaining storage hang-on capabilities up to 66".
- Panel frames can be totally disassembled in the field. Panel modules can be reconfigured or replaced and panel heights altered as changing circumstances demand.
- This level of flexibility makes it easy to select the correct height of panel to suit your requirements.
- Whiteboards incorporated into the panel remove the need for add-ons.
- The quality, and performance level of these panels has been tested to equal or exceed the requirements of the Canadian and US governments.
- Classified as acoustic, these panels meet the acoustical requirements of both Canadian and US governments.
- Solid steel panel frame combined with easy to assemble panel to panel clamps, create a rigid panel wall.
- Panel glide adjustment enables the client to deal with severe uneven floors of a building.

VOICE/DATA AND ELECTRIC POWER

- The base raceway cavity can accommodate 140 Category 5 data cables or 48 Category 5 data cables when the power distribution housings are present. In addition, 8 Category 5 data cables can be housed within a standard Panel Top Cap and 50 Category 5 cables can be accommodated in the optional High Profile Top Cap. This is a "true lay-in" method whereby cables can be run from the ceiling to worksurface without needing to be "fished".
- Evolve's 8 wire system provides two utility circuits plus two separate dedicated circuits (2+2).
- Snap-in Power Distribution Housings and lay-in Jumper and Pass-Through cables enable quick and simple electrical installation and modification by a qualified electrician. Circuits can easily be added, or exchanged (circuit #1 for circuit #2, circuit #1 for dedicated circuit #A or #B etc. if all are connected to base)
- The Desk Top Data/Power House attaches to the back of the worksurface to provide access to two simplex power outlets and two voice/data outlets.
- Standard Data Face Mount Plates can be used without the need of adapter plates (supplied by others).

WORKSURFACES

- The addition of custom sizes shows a commitment to client satisfaction that not every manufacturer offers. With this choice of product, we can tailor each installation to your requirements.
- This convenient scoop feature, together with a 3/8" gap between the worksurface and the panel, allows access to cables without having grommet holes in the worksurface.
- Metal-to-metal connection ensures that, no matter how many times you reconfigure your product, it will perform over the long term.
- Highest quality, thermally fused laminated surfaces ensure lasting durability. High pressure laminates are also available for those areas where rugged use is expected. A 3mm PVC edge banding is used on both options, to take the knocks of everyday wear and tear.
- Whether thermally fused or high pressure, all worksurfaces are manufactured with equal laminates on both sides of the worksurface to deter warpage.
- Curved worksurfaces are ergonomically designed to facilitate the interaction between the keyboard, mouse and worksurface.

STORAGE

- Steel construction guarantees the performance of the product over the long term. Welded joints with a full top, back and base ensure that the pedestal will sit square and adequately support the worksurface where necessary.
- Due to the quality of the construction and the slides, the pedestal drawers will continue to operate efficiently for the lifetime of the furniture. The rubber bumpers dampen the noise of closing a drawer and stop any metal-to-metal contact.
- The pencil tray is double width for extra storage.
- The glides enable you to level the cabinet to the floor and or worksurface. This convenient adjustment feature allows the installer to adjust the height of the cabinet while it is under the worksurface. This saves time in the installation process.
- For additional security and piece of mind. These locks can be keyed alike or master keyed for additional convenience.
- Quality construction with no exposed metal edges. Recessed handle offers uncluttered aesthetic.
- The construction of the drawer enables you to hang files from the drawer side so no extra hardware is necessary. File drawers accept legal, letter and metric sized files.
- Some manufacturers use the same drawer for their 24" deep pedestal as they do for their 30" deep pedestal. The 24" deep drawer gives you only 19.5" of filing. This is 25% extra filing in every file pedestal drawer.
- Worksurface supporting pedestal feature saves you money as you do not have to buy worksurface supporting hardware. Each pedestal comes with a finished end panel. The addition of a non handed bracket enables the pedestal to attach to a structural panel.
- This item, which is shipped knocked down, is more economically priced to minimize shipping damage. The lock is optional in the 12" overhead and included in the 13" overhead. The base shelf features a back lip which stops binders touching the fabric of the panel it is mounted on. All components are metal and the door slides are roller bearing for longer life.
- These rugged overhead units are extremely well priced yet accommodate a full load of binders with ease. They can be mounted above or below the worksurface.
- Storage Towers provide storage without pedestals or binder bins. This allows for greater flexibility in worksurface heights and increases the viability of 54" panels.
- "Environmentally friendly" epoxy powder coat is 15 times more durable in independent testing than a wet paint spray. This helps maintain the look of the product over its many years of service.

WARRANTIES AND PERFORMANCE

- For peace of mind over the long term, we cover you with a comprehensive warranty that is supported by our dealer network.
- We agree to make product available for a period of 20 years from the date of purchase. This product will be 100% compatible with your existing system.
- Evolve is priced well below other major "A" grade products on the market.
- Some installation companies claim that the Evolve System panels can be installed in half the time it takes to install most of our competitor's panels. This cost saving can amount to thousands of dollars over the lifetime of our furniture.
- Your assurance of consistent quality to an international standard. Evolve Systems is committed to design, manufacture and distribute superior quality office furniture, which meets or exceeds the requirements of our customers.
- Confirmation that Evolve is committed: (1) to providing product that, through their entire life cycle, minimize negative environmental impacts on the environment, (2) to continuous improvement to our environmental systems and programs and, (3) to comply to all relevant environmental legislation and regulations.
- Evolve Systems meets LEED requirements for office furniture.
- Evolve components are tested to the highest standard in the industry. This is your assurance of quality and longevity.
- On occasion, parts and pieces get missed. The run-through program is an emergency production space that we use to make items you need in a hurry.

WOOD GRAIN (WG) LAMINATE DIRECTION

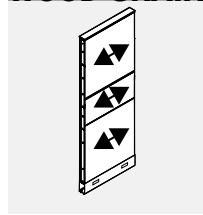

EVP Panels
With Exception of 66" high monolithic panels, they are vertical.

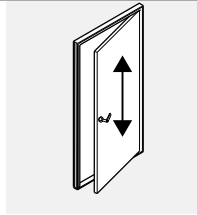

EVPD
Doors.

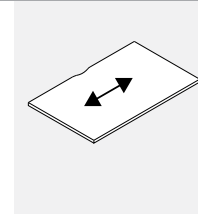

EVWS
Worksurfaces.

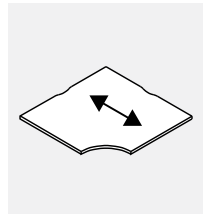

EVWCC
Worksurfaces.

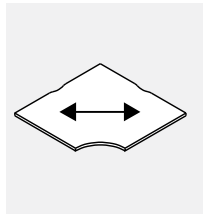

EVWCC-WG
Worksurfaces.

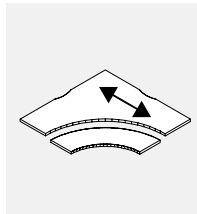

EVWCCK
Worksurfaces.

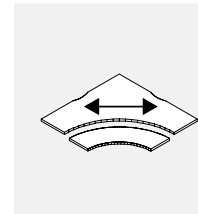

EVWCCK-WG
Worksurfaces.

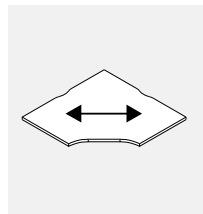

EVWCK-WG
Worksurfaces.

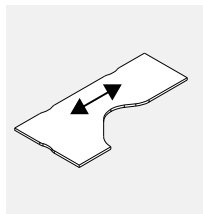

EVWCF
Worksurfaces.

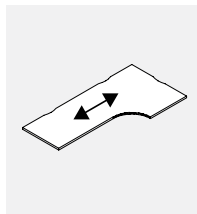

EVWCE
Worksurfaces.

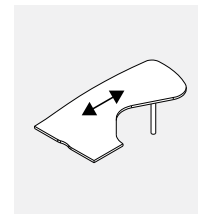

EVWHL/R
Worksurfaces.

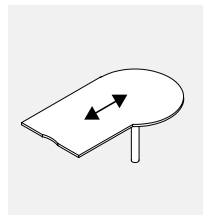

EVWP
Worksurfaces.

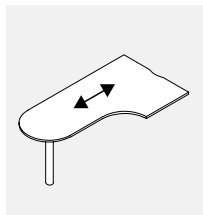

EVWPL/R
Worksurfaces.

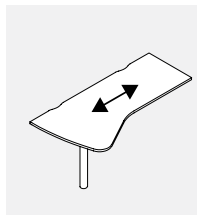

EVWWL/R
Worksurfaces.

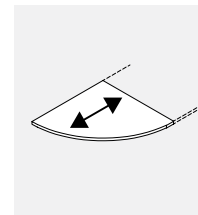

EVQR and EVWQRC
Worksurfaces.

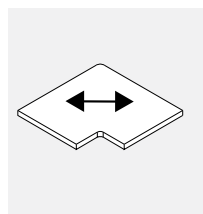

EVWTCL-WG
Worksurfaces.

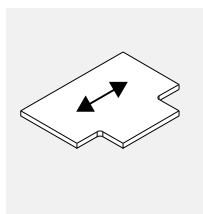

EVWTC
Worksurfaces.

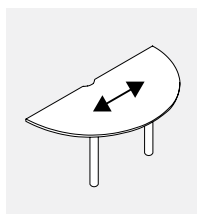

EVWR
Worksurfaces.

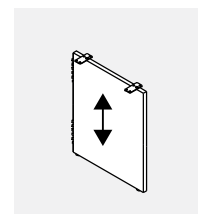

EVHP/EVLMP
End Panels.

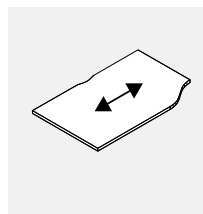

EVWVL/R
Worksurfaces.

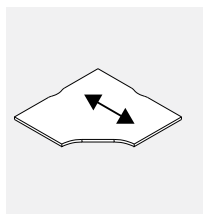

EVWCK
Worksurfaces.

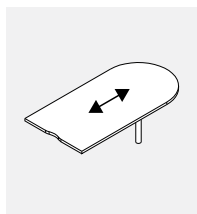

EVWD
Worksurfaces.

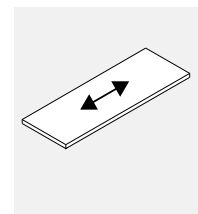

EVWT, EVWTV, EVWTE, EVWTEV, EVWTD, EVWTDV, EVWTDG
Worksurfaces.

WG - indiscated woodgrain in cross pattern

ORDERS

Each Order Must Include

Purchase Order
 Layout showing where the image(s) appear in the run of panels.
 A completed Price Chart, showing the location of the image(s) on each appropriate panel.

Artwork must be submitted in accordance with the following artwork specifications.

NOTE: Final artwork specification approval must be given before order can be processed.

Transfer Devices

• E-mail up to 10MB to your Evolve/Global Contract Customer Service Representative.

• Courier CD/DVD/USB stick to your Evolve/Global Contract Customer Service Representative.

Artwork Specifications

- Non-Photographic artwork should be vector art. Saved in Adobe Illustrator (.ai) or as an EPS (.eps)
- All bitmap or photographic artwork has to be at a minimum of 100 dpi at the full size of the panel to be printed.
- We accept Adobe CS5 files.
- Any linked files must be included or imbedded.

- Leave any PSD files un-flattened
- All fonts must be converted to outlines.
- Do not convert to CMYK, leave all images as RGB if possible
- No Word, Powerpoint, Publisher or other Microsoft files can be used.
- Include a PDF or .jpg for reference when sending native Photoshop or Illustrator format files.

Colour Matching

• A Pantone colour reference must be supplied or we cannot accept responsibility for correct colour or colour correction.

• When it is not possible to refer to Pantone colours, we will do our best to meet your requirements.

Image Clarity

• We will advise should the selected image not lend itself to the element size requested.

NOTE:

We reserve the right to put an order on hold when the files are found to be incomplete or when documents have been either incorrectly saved, fonts have not been converted to curves or the job appears not to be commercially acceptable.

Image Bleed:

To facilitate placement on the panel. Extension of the image past the finished visible area of the panel (bleed) is required.

• Evolve Panels need a 3" bleed on all sides.

Example of Image resolution:

The resolution required for a 36 wide x 24 high Evolve panel at 100dpi (minimum resolution)

The resolution required for a 36 wide x 24 high Evolve panel at 300dpi (higher quality)

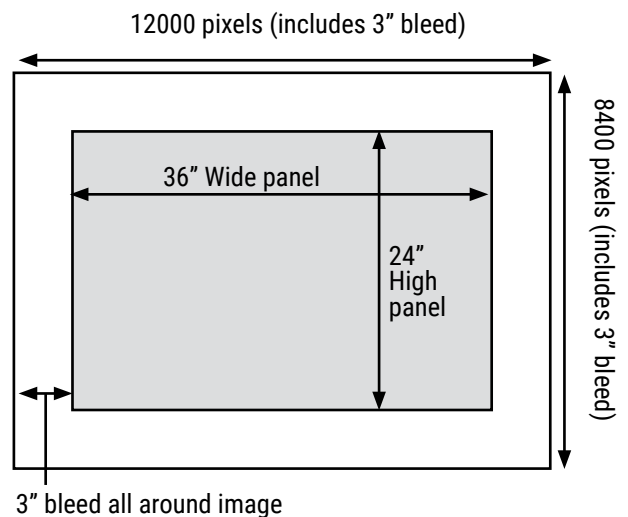
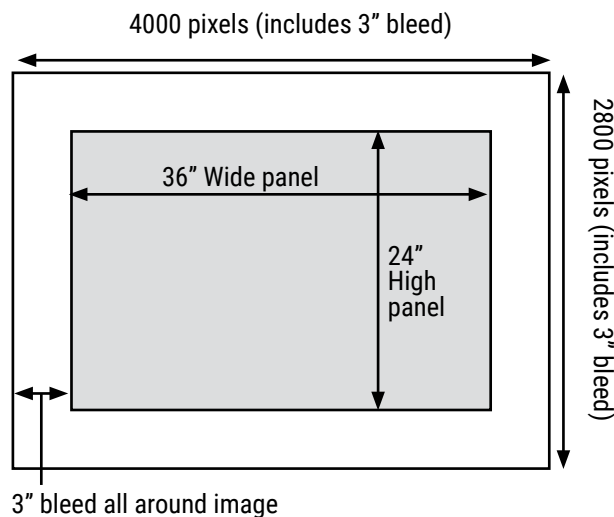

Pricing Initial Set-Up Charge per Image: \$264 net

Evolve 12" Modules

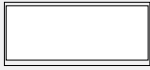

| PANEL WIDTH | LIST PRICE |
|-------------|------------|
| 24" | 144 |
| 30" | 179 |
| 36" | 217 |
| 42" | 249 |
| 48" | 289 |
| 54" | 329 |
| 60" | 366 |

- Applies to the following panels:
- EVPFA
 - EVPPOL
 - EVPPFP
 - EVPPFO
 - EVPPF1W
 - EVPPFO
 - EVPPF2W
 - EVPPFE12
 - EVPPF1S
 - EVPPFE
 - EVPPF2S
 - EVPPFGT
 - EVPPFGTU
 - EVPPFOL

Evolve 24" Modules



| PANEL WIDTH | LIST PRICE |
|-------------|------------|
| 24" | 283 |
| 30" | 363 |
| 36" | 433 |
| 42" | 508 |
| 48" | 579 |
| 54" | 655 |
| 60" | 725 |

- Applies to the following panels:
- EVPFA
 - EVPPGTX
 - EVPPFP
 - EVPPGTX
 - EVPPF1W
 - EVPPFOL
 - EVPPF2W
 - EVPPFO
 - EVPPF1S
 - EVPPFPO
 - EVPPF2S
 - EVPPFOX
 - EVPPFGT
 - EVPPFE24
 - EVPPFGTU

Evolve Monolithic Panels

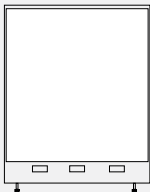

| PANEL WIDTH | HEIGHT | LIST PRICE | 42" | 48" | 54" | 66" |
|-------------|--------|------------|------|------|-----|-----|
| 24" | 42" | 48 | 54 | 66 | | |
| 30" | 433 | 508 | 579 | 726 | | |
| 36" | 555 | 652 | 741 | 928 | | |
| 42" | 665 | 779 | 891 | 1112 | | |
| 48" | 779 | 908 | 1038 | 1298 | | |
| 54" | 891 | 1038 | 1186 | 1482 | | |
| 60" | 999 | 1168 | 1333 | 1666 | | |

- Applies to the following panels:
- EVPFAM

Note: Prices shown are an upcharge to the panel price, please add to the list price of panel which you are specifying the graphic for.

EVOLVE SYSTEMS - GRAPHIC PANEL EXAMPLE PROCEDURE

STEP 1: Customer orders the following EVPFA6636 panel with;

- Bottom module inside face (24/36 size fabric) with image 01.
- Middle module inside face (12/36 size fabric) with image 02.
- All other fabric material is regular fabric - top module inside face and all outside module faces.

STEP 2: On the regular panel - replace fabric pieces with corresponding graphic pieces.

STEP 3: Enter separate lines in order for the corresponding fabric image graphic pieces:

- EVPGRP1236 for the middle module inside face
- EVPGRP2436 for the bottom module inside face

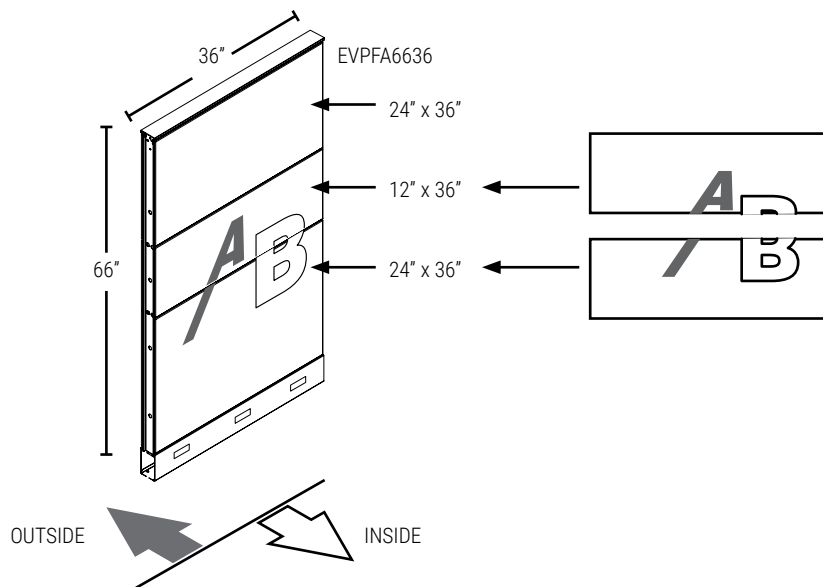

Note: To order, please use graphic codes below

(A)
EVPGRP1236

(B)
EVPGRP2436

PANELS • TECHNICAL INFORMATION

- Evolve panels are 2 7/8" thick. They are available in four (5) basic heights: 30", 42", 48" and 54" and eight (8) widths: 18" to 60" in 6" increments.
- Individual fabric covered acoustic modules incorporated into a rigid steel frame.
- Opposite side of each module may have a different fabric within the same grade at no upcharge.
- If different grades of fabric are used on one panel, the entire panel must be priced at highest grade.
- A low profile top cap is included.
- No panel creep.
- All Panels, except Monolithic are composed of a 6" raceway module and a 24" high base module. Subsequent heights are created by adding either a 12" high module or a 24" high module.
- Raceway openings are 1.37 x 2.68
- 12" high and 24" high modules of all types (fabric, laminate, glass, open) are available for field installation. Contact your Customer Service Representative.
- Frosted glazing is available at an upcharge, please contact your Customer Service Representative.
- Laminate for laminate panels cannot be replaced in the field, complete module must be ordered.
- Writeboard for Writeboard panels cannot be replaced in the field, complete module must be ordered.
- Panels 18" wide have no knockout, panels 24" wide have 1 knockout, panels 30" have 2 knockouts and panels 36" to 60" have 3 knockouts.

PANEL EXTENSION MODULES • TECHNICAL INFORMATION

- 6", 12", 18" and 24" Panel Extension Modules attach to the top of the panel.
- Modules can be stacked to add privacy or divide space.
- Each side of a fabric module may have a different fabric within the same grade at no upcharge.
- When extension modules are used, the double or single clamp is moved to the top of the extension for panel connection.

PANELS • GUIDELINES FOR ORDERING PRODUCT

The price list uses a numbering system with meaningful alphanumeric characters to create a simple-to-understand product number. This makes specifying the product much easier and more accurate.

EXAMPLE OF PANEL CODE

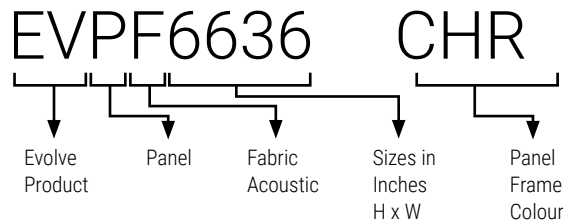

| | | |
|----|------|----------------------------|
| I1 | AN50 | Inside Fabric Position #1 |
| I2 | AN50 | Inside Fabric Position #2 |
| I3 | AN50 | Inside Fabric Position #3 |
| O1 | BE21 | Outside Fabric Position #1 |
| O2 | BE21 | Outside Fabric Position #2 |
| O3 | BE21 | Outside Fabric Position #3 |

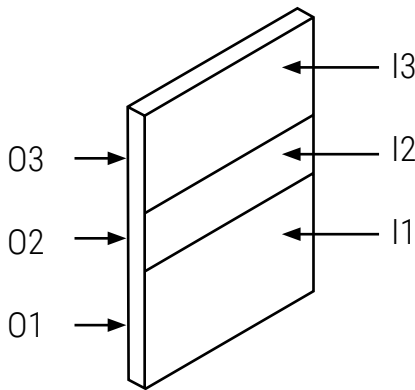

HOW TO SPECIFY

- Specify Evolve panel type and size by code.
- Specify panel frame finish - ie. CHR (Charcoal).
- Specify all necessary panel fabric options.

NOTE: If different grades of fabric are used on one panel, the entire panel must be priced out at the higher grade.

EVPFA • Fabric Acoustic Panel

- Standard panels incorporate a single 12" or 24" module or combination of 12" and 24" modules above the 30" base section. Application is based on panel height.
- 66" high panel can be configured with 12" at the top of the panel, see EVPFA66-S.

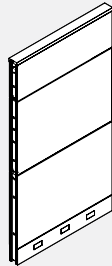
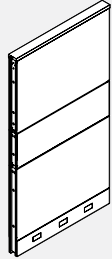
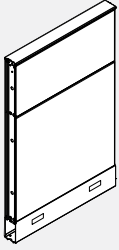

| PRODUCT CODE | PRICE | | SIZE/ INCHES | | | WEIGHT LBS | VOL FT ³ |
|--------------|-------|------|--------------|----|-------|------------|---------------------|
| | GR 1 | GR 2 | H | W | D | | |
| EVPFA3018 | 305 | 317 | 30 | 18 | 2.875 | 15.38 | 1.23 |
| EVPFA3024 | 318 | 336 | 30 | 24 | 2.875 | 18.20 | 1.63 |
| EVPFA3030 | 352 | 372 | 30 | 30 | 2.875 | 21.76 | 2.00 |
| EVPFA3036 | 378 | 401 | 30 | 36 | 2.875 | 24.80 | 2.38 |
| EVPFA3042 | 408 | 434 | 30 | 42 | 2.875 | 26.49 | 2.76 |
| EVPFA3048 | 451 | 482 | 30 | 48 | 2.875 | 32.00 | 3.13 |
| EVPFA3054 | 486 | 520 | 30 | 54 | 2.875 | 35.31 | 3.51 |
| EVPFA3060 | 522 | 562 | 30 | 60 | 2.875 | 38.20 | 3.89 |
| EVPFA4218 | 338 | 354 | 42 | 18 | 2.875 | 20.58 | 1.71 |
| EVPFA4224 | 354 | 382 | 42 | 24 | 2.875 | 24.60 | 2.31 |
| EVPFA4230 | 412 | 443 | 42 | 30 | 2.875 | 29.35 | 2.81 |
| EVPFA4236 | 446 | 482 | 42 | 36 | 2.875 | 35.60 | 3.38 |
| EVPFA4242 | 509 | 548 | 42 | 42 | 2.875 | 39.29 | 3.92 |
| EVPFA4248 | 548 | 593 | 42 | 48 | 2.875 | 43.20 | 4.45 |
| EVPFA4254 | 607 | 657 | 42 | 54 | 2.875 | 47.52 | 4.98 |
| EVPFA4260 | 665 | 721 | 42 | 60 | 2.875 | 51.60 | 5.52 |
| EVPFA5418 | 363 | 385 | 54 | 18 | 2.875 | 23.98 | 2.19 |
| EVPFA5424 | 397 | 431 | 54 | 24 | 2.875 | 27.80 | 2.94 |
| EVPFA5430 | 452 | 490 | 54 | 30 | 2.875 | 33.15 | 3.62 |
| EVPFA5436 | 505 | 550 | 54 | 36 | 2.875 | 37.40 | 4.31 |
| EVPFA5442 | 570 | 625 | 54 | 42 | 2.875 | 40.69 | 4.99 |
| EVPFA5448 | 634 | 694 | 54 | 48 | 2.875 | 48.20 | 5.67 |
| EVPFA5454 | 691 | 758 | 54 | 54 | 2.875 | 52.92 | 6.35 |
| EVPFA5460 | 740 | 814 | 54 | 60 | 2.875 | 57.40 | 7.03 |
| EVPFA6618 | 455 | 486 | 66 | 18 | 2.875 | 29.98 | 2.68 |
| EVPFA6624 | 490 | 536 | 66 | 24 | 2.875 | 35.00 | 3.58 |
| EVPFA6630 | 544 | 593 | 66 | 30 | 2.875 | 41.54 | 4.40 |
| EVPFA6636 | 638 | 697 | 66 | 36 | 2.875 | 49.00 | 5.23 |
| EVPFA6642 | 722 | 790 | 66 | 42 | 2.875 | 54.29 | 6.06 |
| EVPFA6648 | 774 | 850 | 66 | 48 | 2.875 | 60.20 | 6.08 |
| EVPFA6654 | 842 | 926 | 66 | 54 | 2.875 | 65.93 | 7.70 |
| EVPFA6660 | 909 | 1001 | 66 | 60 | 2.875 | 71.60 | 8.53 |
| EVPFA6618S | 455 | 486 | 66 | 18 | 2.875 | 29.98 | 2.68 |
| EVPFA6624S | 490 | 536 | 66 | 24 | 2.875 | 35.00 | 3.58 |
| EVPFA6630S | 544 | 593 | 66 | 30 | 2.875 | 41.54 | 4.40 |
| EVPFA6636S | 638 | 695 | 66 | 36 | 2.875 | 49.00 | 5.23 |
| EVPFA6642S | 722 | 790 | 66 | 42 | 2.875 | 54.29 | 6.06 |
| EVPFA6648S | 774 | 850 | 66 | 48 | 2.875 | 60.20 | 6.88 |
| EVPFA6654S | 842 | 926 | 66 | 54 | 2.875 | 65.93 | 6.88 |
| EVPFA6660S | 909 | 1001 | 66 | 60 | 2.875 | 71.60 | 8.53 |

EVFPF • Fabric Acoustic Panel Premium

• Premium panels incorporate 12" high acoustic modules above the 30" base section.

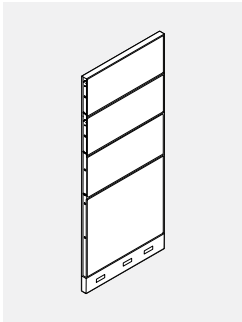
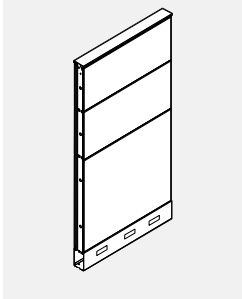

| PRODUCT CODE | PRICE | | SIZE/ INCHES | | | WEIGHT LBS | VOL FT ³ |
|--------------|-------|------|--------------|----|-------|------------|---------------------|
| | GR 1 | GR 2 | H | W | D | | |
| EVFPF5418 | 422 | 450 | 54 | 18 | 2.875 | 26.18 | 2.19 |
| EVFPF5424 | 451 | 484 | 54 | 24 | 2.875 | 31.40 | 2.06 |
| EVFPF5430 | 499 | 540 | 54 | 30 | 2.875 | 37.34 | 2.58 |
| EVFPF5436 | 589 | 634 | 54 | 36 | 2.875 | 46.80 | 3.09 |
| EVFPF5442 | 661 | 718 | 54 | 42 | 2.875 | 52.49 | 3.61 |
| EVFPF5448 | 707 | 765 | 54 | 48 | 2.875 | 54.80 | 4.36 |
| EVFPF5454 | 755 | 824 | 54 | 54 | 2.875 | 60.13 | 6.35 |
| EVFPF5460 | 797 | 872 | 54 | 60 | 2.875 | 65.40 | 5.16 |
| EVFPF6618 | 537 | 568 | 66 | 18 | 2.875 | 32.18 | 2.68 |
| EVFPF6624 | 574 | 613 | 66 | 24 | 2.875 | 38.60 | 3.58 |
| EVFPF6630 | 634 | 686 | 66 | 30 | 2.875 | 45.73 | 4.40 |
| EVFPF6636 | 747 | 809 | 66 | 36 | 2.875 | 58.40 | 5.23 |
| EVFPF6642 | 843 | 911 | 66 | 42 | 2.875 | 66.09 | 6.06 |
| EVFPF6648 | 905 | 983 | 66 | 48 | 2.875 | 66.80 | 6.88 |
| EVFPF6654 | 985 | 1067 | 66 | 54 | 2.875 | 73.14 | 7.70 |
| EVFPF6660 | 1055 | 1147 | 66 | 60 | 2.875 | 79.60 | 8.53 |

EVPFAM • Fabric Acoustic Panel Monolithic

• Monolithic panels incorporate a single acoustic module within a solid rigid steel frame.

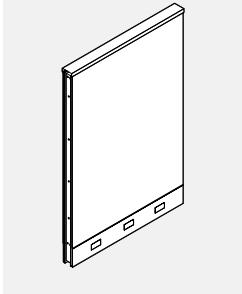

| PRODUCT CODE | PRICE | | SIZE/ INCHES | | | WEIGHT LBS | VOL FT ³ |
|--------------|-------|------|--------------|----|-------|------------|---------------------|
| | GR 1 | GR 2 | H | W | D | | |
| EVPFAM4218 | 333 | 364 | 42 | 18 | 2.875 | 20.58 | 1.71 |
| EVPFAM4224 | 355 | 394 | 42 | 24 | 2.875 | 23.40 | 2.31 |
| EVPFAM4230 | 406 | 450 | 42 | 30 | 2.875 | 26.96 | 2.85 |
| EVPFAM4236 | 436 | 487 | 42 | 36 | 2.875 | 30.00 | 3.38 |
| EVPFAM4242 | 483 | 543 | 42 | 42 | 2.875 | 31.69 | 3.92 |
| EVPFAM4248 | 525 | 593 | 42 | 48 | 2.875 | 37.20 | 4.45 |
| EVPFAM4254 | 579 | 653 | 42 | 54 | 2.875 | 40.51 | 4.98 |
| EVPFAM4260 | 629 | 711 | 42 | 60 | 2.875 | 43.40 | 5.52 |
| EVPFAM4818 | 340 | 371 | 48 | 18 | 2.875 | 21.38 | 1.92 |
| EVPFAM4824 | 374 | 410 | 48 | 24 | 2.875 | 24.40 | 2.62 |
| EVPFAM4830 | 431 | 476 | 48 | 30 | 2.875 | 27.76 | 3.23 |
| EVPFAM4836 | 469 | 520 | 48 | 36 | 2.875 | 30.80 | 3.85 |
| EVPFAM4842 | 524 | 584 | 48 | 42 | 2.875 | 32.49 | 4.45 |
| EVPFAM4848 | 572 | 637 | 48 | 48 | 2.875 | 37.80 | 5.06 |
| EVPFAM4854 | 630 | 704 | 48 | 54 | 2.875 | 41.31 | 5.66 |
| EVPFAM4860 | 684 | 767 | 48 | 60 | 2.875 | 44.20 | 6.27 |
| EVPFAM5418 | 342 | 374 | 54 | 18 | 2.875 | 24.58 | 2.19 |
| EVPFAM5424 | 376 | 415 | 54 | 24 | 2.875 | 27.40 | 2.94 |
| EVPFAM5430 | 437 | 482 | 54 | 30 | 2.875 | 30.96 | 3.62 |
| EVPFAM5436 | 486 | 541 | 54 | 36 | 2.875 | 34.00 | 4.31 |
| EVPFAM5442 | 545 | 605 | 54 | 42 | 2.875 | 35.69 | 4.99 |
| EVPFAM5448 | 591 | 661 | 54 | 48 | 2.875 | 41.20 | 5.67 |
| EVPFAM5454 | 651 | 728 | 54 | 54 | 2.875 | 44.51 | 6.35 |
| EVPFAM5460 | 712 | 796 | 54 | 60 | 2.875 | 47.40 | 7.03 |
| EVPFAM6618 | 425 | 455 | 66 | 18 | 2.875 | 27.58 | 2.68 |
| EVPFAM6624 | 463 | 503 | 66 | 24 | 2.875 | 30.40 | 3.58 |
| EVPFAM6630 | 524 | 573 | 66 | 30 | 2.875 | 33.96 | 4.40 |
| EVPFAM6636 | 608 | 663 | 66 | 36 | 2.875 | 37.00 | 5.23 |
| EVPFAM6642 | 684 | 743 | 66 | 42 | 2.875 | 38.69 | 6.06 |
| EVPFAM6648 | 743 | 811 | 66 | 48 | 2.875 | 44.20 | 6.88 |
| EVPFAM6654 | 826 | 900 | 66 | 54 | 2.875 | 47.51 | 7.70 |
| EVPFAM6660 | 909 | 991 | 66 | 60 | 2.875 | 50.40 | 8.53 |

EVPH1S • Laminate Panel - One Side

• Laminate faces on one side of all modules provide durable, washable surfaces. Opposite side is fabric.

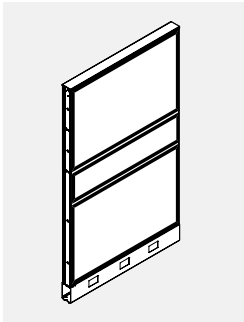
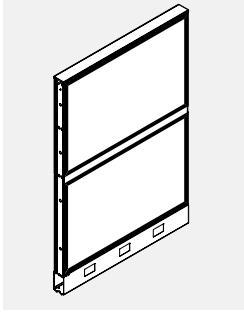

| PRODUCT CODE | PRICE | | SIZE / INCHES | | | WEIGHT LBS | VOL FT ³ |
|--------------|-------|------|---------------|----|-------|------------|---------------------|
| | GR 1 | GR 2 | H | W | D | | |
| EVPH1S3018 | 364 | 370 | 30 | 18 | 2.875 | 15.88 | 1.23 |
| EVPH1S3024 | 434 | 443 | 30 | 24 | 2.875 | 18.70 | 1.63 |
| EVPH1S3030 | 509 | 518 | 30 | 30 | 2.875 | 22.26 | 2.00 |
| EVPH1S3036 | 578 | 591 | 30 | 36 | 2.875 | 24.85 | 2.58 |
| EVPH1S3042 | 656 | 670 | 30 | 42 | 2.875 | 26.99 | 2.76 |
| EVPH1S3048 | 712 | 724 | 30 | 48 | 2.875 | 32.05 | 3.13 |
| EVPH1S3054 | 790 | 806 | 30 | 54 | 2.875 | 35.81 | 3.51 |
| EVPH1S3060 | 864 | 883 | 30 | 60 | 2.875 | 38.07 | 3.89 |
| EVPH1S4218 | 432 | 441 | 42 | 18 | 2.875 | 21.38 | 1.71 |
| EVPH1S4224 | 516 | 528 | 42 | 24 | 2.875 | 22.13 | 2.31 |
| EVPH1S4230 | 603 | 615 | 42 | 30 | 2.875 | 30.15 | 2.31 |
| EVPH1S4236 | 692 | 713 | 42 | 36 | 2.875 | 36.40 | 3.38 |
| EVPH1S4242 | 784 | 805 | 42 | 42 | 2.875 | 40.09 | 3.92 |
| EVPH1S4248 | 853 | 877 | 42 | 48 | 2.875 | 44.00 | 4.45 |
| EVPH1S4254 | 949 | 973 | 42 | 54 | 2.875 | 48.32 | 4.98 |
| EVPH1S4260 | 1038 | 1066 | 42 | 60 | 2.875 | 52.40 | 5.52 |
| EVPH1S5418 | 508 | 520 | 54 | 18 | 2.875 | 24.98 | 2.19 |
| EVPH1S5424 | 612 | 629 | 54 | 24 | 2.875 | 28.80 | 2.94 |
| EVPH1S5430 | 720 | 740 | 54 | 30 | 2.875 | 34.15 | 3.62 |
| EVPH1S5436 | 824 | 849 | 54 | 36 | 2.875 | 38.40 | 4.31 |
| EVPH1S5442 | 931 | 959 | 54 | 42 | 2.875 | 41.69 | 4.99 |
| EVPH1S5448 | 1018 | 1051 | 54 | 48 | 2.875 | 49.20 | 5.67 |
| EVPH1S5454 | 1132 | 1168 | 54 | 54 | 2.875 | 53.92 | 6.35 |
| EVPH1S5460 | 1245 | 1286 | 54 | 60 | 2.875 | 58.40 | 7.03 |
| EVPH1S6618 | 629 | 645 | 66 | 18 | 2.875 | 31.29 | 2.68 |
| EVPH1S6624 | 758 | 780 | 66 | 24 | 2.875 | 36.30 | 3.58 |
| EVPH1S6630 | 885 | 911 | 66 | 30 | 2.875 | 42.84 | 4.40 |
| EVPH1S6636 | 1022 | 1052 | 66 | 36 | 2.875 | 50.30 | 5.23 |
| EVPH1S6642 | 1165 | 1197 | 66 | 42 | 2.875 | 55.59 | 6.06 |
| EVPH1S6648 | 1265 | 1303 | 66 | 48 | 2.875 | 61.50 | 5.23 |
| EVPH1S6654 | 1406 | 1448 | 66 | 54 | 2.875 | 67.23 | 7.70 |
| EVPH1S6660 | 1549 | 1600 | 66 | 60 | 2.875 | 72.90 | 8.53 |

EVPH2S • Laminate Panel - Two Sides

- Laminate faces on both sides of all modules provide durable, washable surfaces.

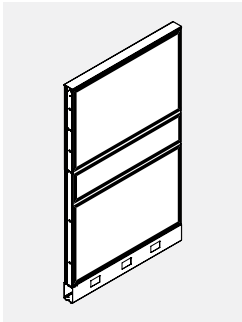
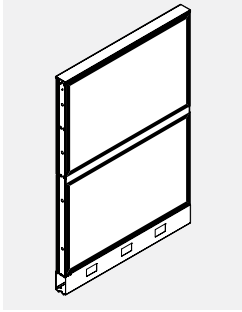

| PRODUCT CODE | PRICE | SIZE/ INCHES | | | WEIGHT LBS | VOL FT ³ |
|--------------|-------|--------------|----|-------|------------|---------------------|
| | | H | W | D | | |
| EVPH2S3018 | 406 | 30 | 18 | 2.875 | 16.38 | 1.23 |
| EVPH2S3024 | 495 | 30 | 24 | 2.875 | 19.20 | 1.63 |
| EVPH2S3030 | 586 | 30 | 30 | 2.875 | 22.76 | 2.00 |
| EVPH2S3036 | 670 | 30 | 36 | 2.875 | 25.80 | 2.58 |
| EVPH2S3042 | 762 | 30 | 42 | 2.875 | 27.49 | 2.76 |
| EVPH2S3048 | 852 | 30 | 48 | 2.875 | 33.00 | 3.35 |
| EVPH2S3054 | 943 | 30 | 54 | 2.875 | 36.31 | 3.95 |
| EVPH2S3060 | 1022 | 30 | 60 | 2.875 | 39.20 | 4.52 |
| EVPH2S4218 | 483 | 42 | 18 | 2.875 | 22.18 | 1.71 |
| EVPH2S4224 | 586 | 42 | 24 | 2.875 | 26.20 | 2.31 |
| EVPH2S4230 | 691 | 42 | 30 | 2.875 | 30.95 | 2.85 |
| EVPH2S4236 | 802 | 42 | 36 | 2.875 | 37.20 | 3.38 |
| EVPH2S4242 | 917 | 42 | 42 | 2.875 | 40.89 | 3.92 |
| EVPH2S4248 | 1026 | 42 | 48 | 2.875 | 42.80 | 4.45 |
| EVPH2S4254 | 1129 | 42 | 54 | 2.875 | 49.12 | 5.52 |
| EVPH2S4260 | 1232 | 42 | 60 | 2.875 | 53.20 | 5.52 |
| EVPH2S5418 | 565 | 54 | 18 | 2.875 | 25.98 | 2.19 |
| EVPH2S5424 | 693 | 54 | 24 | 2.875 | 29.80 | 2.94 |
| EVPH2S5430 | 824 | 54 | 30 | 2.875 | 35.15 | 3.62 |
| EVPH2S5436 | 955 | 54 | 36 | 2.875 | 39.40 | 4.31 |
| EVPH2S5442 | 1090 | 54 | 42 | 2.875 | 42.69 | 4.99 |
| EVPH2S5448 | 1231 | 54 | 48 | 2.875 | 50.20 | 5.67 |
| EVPH2S5454 | 1352 | 54 | 54 | 2.875 | 52.92 | 6.35 |
| EVPH2S5460 | 1473 | 54 | 60 | 2.875 | 59.40 | 7.03 |
| EVPH2S6618 | 712 | 66 | 18 | 2.875 | 32.58 | 2.68 |
| EVPH2S6624 | 877 | 66 | 24 | 2.875 | 37.60 | 3.58 |
| EVPH2S6630 | 1038 | 66 | 30 | 2.875 | 44.14 | 4.40 |
| EVPH2S6636 | 1205 | 66 | 36 | 2.875 | 51.60 | 5.23 |
| EVPH2S6642 | 1383 | 66 | 42 | 2.875 | 56.89 | 6.06 |
| EVPH2S6648 | 1549 | 66 | 48 | 2.875 | 62.80 | 6.88 |
| EVPH2S6654 | 1713 | 66 | 54 | 2.875 | 68.53 | 7.70 |
| EVPH2S6660 | 1870 | 66 | 60 | 2.875 | 74.20 | 8.53 |

EVPF1W • Writeboard Panel - One Side

- Writing surface is built into the top module on one side of the panel, alleviating the need for a panel-mounted Writeboard.
- Use of erasable Writeboard markers only.

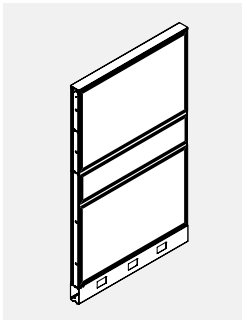
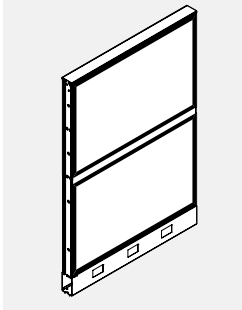

| PRODUCT CODE | PRICE | | SIZE/ INCHES | | | WEIGHT LBS | VOL FT ³ |
|--------------|-------|------|--------------|----|-------|------------|---------------------|
| | GR 1 | GR 2 | H | W | D | | |
| EVPF1W5418 | 441 | 456 | 54 | 18 | 2.875 | 24.98 | 2.19 |
| EVPF1W5424 | 548 | 575 | 54 | 24 | 2.875 | 28.80 | 2.94 |
| EVPF1W5430 | 659 | 691 | 54 | 30 | 2.875 | 34.15 | 3.62 |
| EVPF1W5436 | 731 | 766 | 54 | 36 | 2.875 | 38.40 | 4.31 |
| EVPF1W5442 | 826 | 867 | 54 | 42 | 2.875 | 41.69 | 4.99 |
| EVPF1W5448 | 930 | 975 | 54 | 48 | 2.875 | 49.20 | 5.67 |
| EVPF1W5454 | 1035 | 1069 | 54 | 54 | 2.875 | 53.92 | 6.35 |
| EVPF1W5460 | 1140 | 1198 | 54 | 60 | 2.875 | 58.40 | 7.03 |
| EVPF1W6618 | 562 | 582 | 66 | 18 | 2.875 | 30.48 | 2.57 |
| EVPF1W6624 | 692 | 724 | 66 | 24 | 2.875 | 35.50 | 3.58 |
| EVPF1W6630 | 823 | 863 | 66 | 30 | 2.875 | 42.04 | 4.40 |
| EVPF1W6636 | 916 | 963 | 66 | 36 | 2.875 | 49.50 | 5.23 |
| EVPF1W6642 | 1037 | 1091 | 66 | 42 | 2.875 | 54.79 | 6.06 |
| EVPF1W6648 | 1157 | 1220 | 66 | 48 | 2.875 | 60.70 | 6.88 |
| EVPF1W6654 | 1290 | 1357 | 66 | 54 | 2.875 | 66.43 | 7.70 |
| EVPF1W6660 | 1422 | 1498 | 66 | 60 | 2.875 | 72.10 | 8.53 |

EVVPF2W • Writeboard Panel - Two Side

- Writing surface is built into the top module on both sides of the panel, alleviating the need for 2 panel-mounted Writeboards.
- Use of erasable Writeboard markers only.

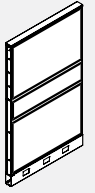
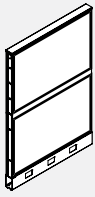

| PRODUCT CODE | PRICE | | SIZE/ INCHES | | | WEIGHT LBS | VOL FT ³ |
|--------------|-------|------|--------------|----|-------|------------|---------------------|
| | GR 1 | GR 2 | H | W | D | | |
| EVVPF2W5418 | 476 | 487 | 54 | 18 | 2.875 | 25.48 | 2.19 |
| EVVPF2W5424 | 596 | 613 | 54 | 24 | 2.875 | 29.30 | 2.94 |
| EVVPF2W5430 | 746 | 763 | 54 | 30 | 2.875 | 34.65 | 3.62 |
| EVVPF2W5436 | 809 | 833 | 54 | 36 | 2.875 | 38.90 | 4.31 |
| EVVPF2W5442 | 917 | 943 | 54 | 42 | 2.875 | 42.19 | 4.99 |
| EVVPF2W5448 | 1072 | 1103 | 54 | 48 | 2.875 | 49.70 | 5.67 |
| EVVPF2W5454 | 1196 | 1231 | 54 | 54 | 2.875 | 54.51 | 6.35 |
| EVVPF2W5460 | 1317 | 1354 | 54 | 60 | 2.875 | 58.90 | 7.03 |
| EVVPF2W6618 | 593 | 613 | 66 | 18 | 2.875 | 30.98 | 2.57 |
| EVVPF2W6624 | 737 | 762 | 66 | 24 | 2.875 | 36.00 | 3.58 |
| EVVPF2W6630 | 908 | 937 | 66 | 30 | 2.875 | 42.54 | 4.40 |
| EVVPF2W6636 | 992 | 1026 | 66 | 36 | 2.875 | 50.00 | 5.23 |
| EVVPF2W6642 | 1128 | 1169 | 66 | 42 | 2.875 | 55.29 | 6.06 |
| EVVPF2W6648 | 1294 | 1340 | 66 | 48 | 2.875 | 61.20 | 6.88 |
| EVVPF2W6654 | 1442 | 1496 | 66 | 54 | 2.875 | 66.93 | 7.70 |
| EVVPF2W6660 | 1595 | 1653 | 66 | 60 | 2.875 | 72.60 | 8.53 |

EVVPF1S • Slat Wall Panel - One Sided

- Standard panels incorporating a single 12" or 24" module or combination of 12" and 24" modules above the 30" base section.
- Slat module is only on one side, fabric on the other.
- 66" high panel can be configured with either a 24" slat module at the top, see EVVPF1S66, or a 12" slat module at the centre, see EVVPF1S66M.

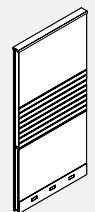
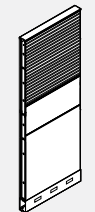
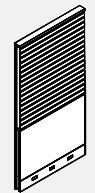
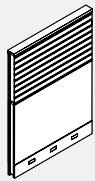

| PRODUCT CODE | PRICE | | SIZE/ INCHES | | | WEIGHT LBS | VOL FT ³ |
|--------------|-------|------|--------------|----|-------|------------|---------------------|
| | GR 1 | GR 2 | H | W | D | | |
| EVVPF1S4218 | 383 | 399 | 42 | 18 | 2.875 | 13.50 | 1.71 |
| EVVPF1S4224 | 419 | 441 | 42 | 24 | 2.875 | 33.50 | 2.31 |
| EVVPF1S4230 | 490 | 517 | 42 | 30 | 2.875 | 45.50 | 2.85 |
| EVVPF1S4236 | 542 | 573 | 42 | 36 | 2.875 | 49.50 | 3.38 |
| EVVPF1S4242 | 625 | 658 | 42 | 42 | 2.875 | 54.50 | 3.92 |
| EVVPF1S4248 | 671 | 711 | 42 | 48 | 2.875 | 60.50 | 4.47 |
| EVVPF1S4254 | 747 | 788 | 42 | 54 | 2.875 | 67.50 | 4.98 |
| EVVPF1S4260 | 819 | 865 | 42 | 60 | 2.875 | 74.50 | 5.52 |
| EVVPF1S5418 | 464 | 484 | 54 | 18 | 2.875 | 36.50 | 2.19 |
| EVVPF1S5424 | 527 | 552 | 54 | 24 | 2.875 | 36.40 | 2.94 |
| EVVPF1S5430 | 612 | 643 | 54 | 30 | 2.875 | 40.40 | 3.62 |
| EVVPF1S5436 | 694 | 731 | 54 | 36 | 2.875 | 44.40 | 4.31 |
| EVVPF1S5442 | 790 | 830 | 54 | 42 | 2.875 | 46.40 | 5.67 |
| EVVPF1S5448 | 884 | 929 | 54 | 48 | 2.875 | 48.40 | 5.67 |
| EVVPF1S5454 | 969 | 1021 | 54 | 54 | 2.875 | 50.00 | 6.35 |
| EVVPF1S5460 | 1050 | 1106 | 54 | 60 | 2.875 | 52.40 | 7.03 |
| EVVPF1S6618 | 561 | 584 | 66 | 18 | 2.875 | 42.00 | 2.57 |
| EVVPF1S6624 | 623 | 656 | 66 | 24 | 2.875 | 48.00 | 3.58 |
| EVVPF1S6630 | 705 | 746 | 66 | 30 | 2.875 | 50.00 | 4.40 |
| EVVPF1S6636 | 829 | 879 | 66 | 36 | 2.875 | 54.00 | 5.23 |
| EVVPF1S6642 | 938 | 995 | 66 | 42 | 2.875 | 60.00 | 6.06 |
| EVVPF1S6648 | 1022 | 1084 | 66 | 48 | 2.875 | 67.00 | 6.88 |
| EVVPF1S6654 | 1119 | 1187 | 66 | 54 | 2.875 | 80.00 | 7.07 |
| EVVPF1S6660 | 1216 | 1292 | 66 | 60 | 2.875 | 86.00 | 8.53 |
| EVVPF1S6618M | 503 | 534 | 66 | 18 | 2.875 | 42.00 | 2.57 |
| EVVPF1S6624M | 553 | 592 | 66 | 24 | 2.875 | 48.00 | 3.58 |
| EVVPF1S6630M | 623 | 668 | 66 | 30 | 2.875 | 50.00 | 4.40 |
| EVVPF1S6636M | 734 | 788 | 66 | 36 | 2.875 | 54.00 | 5.23 |
| EVVPF1S6642M | 835 | 896 | 66 | 42 | 2.875 | 60.00 | 6.06 |
| EVVPF1S6648M | 896 | 966 | 66 | 48 | 2.875 | 67.00 | 6.88 |
| EVVPF1S6654M | 983 | 1060 | 66 | 54 | 2.875 | 80.00 | 7.70 |
| EVVPF1S6660M | 1063 | 1147 | 66 | 60 | 2.875 | 86.00 | 8.53 |

EVPF2S • Slat Wall Module Panel - Two Sided

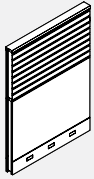

- Standard panels incorporating a single 12" or 24" module or combination of 12" and 24" modules above the 30" base section.
- Slat module is only on both sides.
- 66" high panel can be configured with either a 24" slat module at the top, see EVPF2S66, or a 12" slat module at the centre, see EVPF2S66-M.

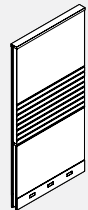
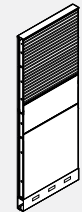
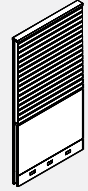

| PRODUCT CODE | PRICE | | SIZE/ INCHES | | | WEIGHT VOL | |
|--------------|-------|------|--------------|----|-------|------------|-----------------|
| | GR 1 | GR 2 | H | W | D | LBS | FT ³ |
| EVPF2S4218 | 411 | 425 | 42 | 18 | 2.875 | 16.50 | 1.71 |
| EVPF2S4224 | 459 | 477 | 42 | 24 | 2.875 | 36.50 | 2.31 |
| EVPF2S4230 | 543 | 563 | 42 | 30 | 2.875 | 48.50 | 2.85 |
| EVPF2S4236 | 604 | 627 | 42 | 36 | 2.875 | 52.50 | 3.38 |
| EVPF2S4242 | 694 | 722 | 42 | 42 | 2.875 | 57.50 | 3.92 |
| EVPF2S4248 | 755 | 786 | 42 | 48 | 2.875 | 63.50 | 4.47 |
| EVPF2S4254 | 842 | 877 | 42 | 54 | 2.875 | 70.50 | 4.98 |
| EVPF2S4260 | 922 | 960 | 42 | 60 | 2.875 | 77.50 | 5.52 |
| EVPF2S5418 | 542 | 553 | 54 | 18 | 2.875 | 38.50 | 2.19 |
| EVPF2S5424 | 631 | 649 | 54 | 24 | 2.875 | 44.40 | 2.94 |
| EVPF2S5430 | 744 | 761 | 54 | 30 | 2.875 | 46.40 | 3.62 |
| EVPF2S5436 | 852 | 877 | 54 | 36 | 2.875 | 48.40 | 4.31 |
| EVPF2S5442 | 973 | 1000 | 54 | 42 | 2.875 | 50.40 | 4.99 |
| EVPF2S5448 | 1095 | 1128 | 54 | 48 | 2.875 | 52.40 | 5.67 |
| EVPF2S5454 | 1205 | 1239 | 54 | 54 | 2.875 | 54.40 | 6.35 |
| EVPF2S5460 | 1315 | 1352 | 54 | 60 | 2.875 | 56.40 | 7.03 |
| EVPF2S6618 | 634 | 655 | 66 | 18 | 2.875 | 45.00 | 2.57 |
| EVPF2S6624 | 725 | 752 | 66 | 24 | 2.875 | 51.00 | 3.58 |
| EVPF2S6630 | 835 | 865 | 66 | 30 | 2.875 | 53.00 | 4.40 |
| EVPF2S6636 | 986 | 1023 | 66 | 36 | 2.875 | 57.00 | 5.23 |
| EVPF2S6642 | 1125 | 1167 | 66 | 42 | 2.875 | 63.00 | 6.06 |
| EVPF2S6648 | 1234 | 1279 | 66 | 48 | 2.875 | 70.40 | 6.88 |
| EVPF2S6654 | 1358 | 1409 | 66 | 54 | 2.875 | 83.40 | 7.70 |
| EVPF2S6660 | 1482 | 1540 | 66 | 60 | 2.875 | 89.40 | 8.53 |
| EVPF2S6618M | 535 | 557 | 66 | 18 | 2.875 | 45.00 | 2.57 |
| EVPF2S6624M | 593 | 627 | 66 | 24 | 2.875 | 51.00 | 3.58 |
| EVPF2S6630M | 672 | 714 | 66 | 30 | 2.875 | 53.00 | 4.40 |
| EVPF2S6636M | 797 | 846 | 66 | 36 | 2.875 | 57.00 | 5.23 |
| EVPF2S6642M | 908 | 962 | 66 | 42 | 2.875 | 63.00 | 6.06 |
| EVPF2S6648M | 977 | 1040 | 66 | 48 | 2.875 | 70.40 | 6.88 |
| EVPF2S6654M | 1074 | 1143 | 66 | 54 | 2.875 | 83.40 | 7.70 |
| EVPF2S6660M | 1168 | 1241 | 66 | 60 | 2.875 | 89.40 | 8.53 |

EVPF2S-F • Frameless Slat Wall Module Panel - Two Sided

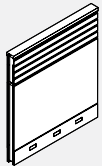

- Slat Wall is manufactured with 2 snap-in sections.
- Accessories can be hung on Slat Wall. Please see accessories section for additional details.
- For 42" H Slat Wall Panel only Aluminum Top Trim can be used. Aluminum Top Trim is included.
- Stackability: Evolve panels can be increased in height in 6", 12" and 24" increments. See module listing for part numbers.

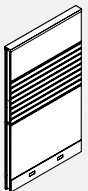

| PRODUCT CODE | PRICE | | SIZE/ INCHES | | | WEIGHT VOL | |
|--------------|-------|------|--------------|----|-------|------------|-----------------|
| | GR 1 | GR 2 | H | W | D | LBS | FT ³ |
| EVPF2S4224F | 412 | 431 | 42 | 24 | 2.875 | 33.50 | 2.31 |
| EVPF2S4230F | 485 | 507 | 42 | 30 | 2.875 | 45.50 | 2.81 |
| EVPF2S4236F | 567 | 590 | 42 | 36 | 2.875 | 49.50 | 3.38 |
| EVPF2S4242F | 641 | 668 | 42 | 42 | 2.875 | 54.50 | 3.92 |
| EVPF2S4248F | 711 | 741 | 42 | 48 | 2.875 | 60.50 | 4.45 |
| EVPF2S4254F | 785 | 820 | 42 | 54 | 2.875 | 67.50 | 4.98 |
| EVPF2S4260F | 865 | 903 | 42 | 60 | 2.875 | 74.50 | 5.52 |
| EVPF2S5424F | 563 | 589 | 54 | 24 | 2.875 | 36.40 | 2.94 |
| EVPF2S5430F | 658 | 689 | 54 | 30 | 2.875 | 40.40 | 3.62 |
| EVPF2S5436F | 763 | 801 | 54 | 36 | 2.875 | 44.40 | 4.31 |
| EVPF2S5442F | 867 | 908 | 54 | 42 | 2.875 | 46.60 | 4.99 |
| EVPF2S5448F | 962 | 1007 | 54 | 48 | 2.875 | 48.40 | 5.67 |
| EVPF2S5454F | 1090 | 1142 | 54 | 54 | 2.875 | 50.40 | 6.35 |
| EVPF2S5460F | 1173 | 1232 | 54 | 60 | 2.875 | 52.40 | 7.03 |
| EVPF2S6624F | 623 | 656 | 66 | 24 | 2.875 | 48.00 | 3.58 |
| EVPF2S6630F | 726 | 770 | 66 | 30 | 2.875 | 50.00 | 4.40 |
| EVPF2S6636F | 860 | 908 | 66 | 36 | 2.875 | 54.00 | 5.23 |
| EVPF2S6642F | 966 | 1022 | 66 | 42 | 2.875 | 60.00 | 6.06 |
| EVPF2S6648F | 1069 | 1132 | 66 | 48 | 2.875 | 67.00 | 6.08 |
| EVPF2S6654F | 1177 | 1244 | 66 | 54 | 2.875 | 80.00 | 7.70 |
| EVPF2S6660F | 1294 | 1369 | 66 | 60 | 2.875 | 86.00 | 8.53 |

EVPFGT • Fabric Glazed Panel - Tempered Glass

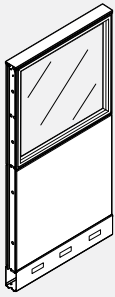

- Fabric Glazed Panel consists of individual fabric covered acoustic module in lower position(s) with one 12" or 24" glazed module in upper position.
- Glazing is replaceable on site.

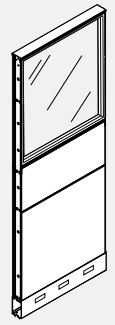

| PRODUCT CODE | PRICE | | SIZE/ INCHES | | | WEIGHT | | VOL FT ³ |
|--------------|-------|------|--------------|----|-------|--------|------|---------------------|
| | GR 1 | GR 2 | H | W | D | LBS | | |
| EVPFGT4218 | 406 | 419 | 42 | 18 | 2.875 | 23.96 | 1.71 | |
| EVPFGT4224 | 478 | 494 | 42 | 24 | 2.875 | 28.98 | 2.31 | |
| EVPFGT4230 | 542 | 562 | 42 | 30 | 2.875 | 34.62 | 2.85 | |
| EVPFGT4236 | 609 | 633 | 42 | 36 | 2.875 | 39.76 | 3.38 | |
| EVPFGT4242 | 673 | 699 | 42 | 42 | 2.875 | 43.45 | 3.92 | |
| EVPFGT4248 | 736 | 766 | 42 | 48 | 2.875 | 51.56 | 4.45 | |
| EVPFGT4254 | 826 | 862 | 42 | 54 | 2.875 | 56.87 | 4.98 | |
| EVPFGT4260 | 911 | 949 | 42 | 60 | 2.875 | 61.95 | 5.52 | |
| EVPFGT5418 | 448 | 459 | 54 | 18 | 2.875 | 28.25 | 2.19 | |
| EVPFGT5424 | 520 | 539 | 54 | 24 | 2.875 | 34.76 | 2.94 | |
| EVPFGT5430 | 605 | 625 | 54 | 30 | 2.875 | 41.80 | 3.62 | |
| EVPFGT5436 | 688 | 713 | 54 | 36 | 2.875 | 48.34 | 4.31 | |
| EVPFGT5442 | 770 | 796 | 54 | 42 | 2.875 | 53.12 | 4.99 | |
| EVPFGT5448 | 840 | 870 | 54 | 48 | 2.875 | 62.11 | 5.67 | |
| EVPFGT5454 | 973 | 1007 | 54 | 54 | 2.875 | 68.42 | 6.35 | |
| EVPFGT5460 | 1106 | 1143 | 54 | 60 | 2.875 | 74.49 | 7.03 | |
| EVPFGT6618 | 569 | 589 | 66 | 18 | 2.875 | 34.25 | 2.68 | |
| EVPFGT6624 | 660 | 688 | 66 | 24 | 2.875 | 41.96 | 3.58 | |
| EVPFGT6630 | 763 | 794 | 66 | 30 | 2.875 | 50.19 | 4.40 | |
| EVPFGT6636 | 870 | 908 | 66 | 36 | 2.875 | 59.94 | 5.23 | |
| EVPFGT6642 | 984 | 1024 | 66 | 42 | 2.875 | 66.72 | 6.06 | |
| EVPFGT6648 | 1065 | 1113 | 66 | 48 | 2.875 | 74.11 | 6.88 | |
| EVPFGT6654 | 1226 | 1276 | 66 | 54 | 2.875 | 81.43 | 7.70 | |
| EVPFGT6660 | 1389 | 1445 | 66 | 60 | 2.875 | 88.69 | 8.53 | |

EVFPFGT • Fabric Glazed Panel Premium - Tempered Glass

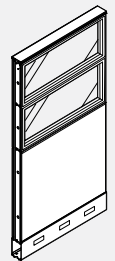

- Fabric Glazed Panel consists of individual fabric covered acoustic module in lower position with 2 or 3 glazed modules in upper position.
- Glazing is replaceable on site.

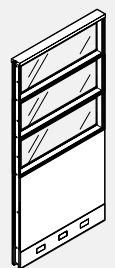

| PRODUCT CODE | PRICE | | SIZE/ INCHES | | | WEIGHT | | VOL FT ³ |
|--------------|-------|------|--------------|----|-------|--------|------|---------------------|
| | GR 1 | GR 2 | H | W | D | LBS | | |
| EVFPFGT5418 | 542 | 553 | 54 | 18 | 2.875 | 32.95 | 2.19 | |
| EVFPFGT5424 | 652 | 668 | 54 | 24 | 2.875 | 40.16 | 2.06 | |
| EVFPFGT5430 | 726 | 749 | 54 | 30 | 2.875 | 47.89 | 2.58 | |
| EVFPFGT5436 | 809 | 831 | 54 | 36 | 2.875 | 55.14 | 3.09 | |
| EVFPFGT5442 | 898 | 929 | 54 | 42 | 2.875 | 60.82 | 3.61 | |
| EVFPFGT5448 | 988 | 1022 | 54 | 48 | 2.875 | 71.78 | 4.36 | |
| EVFPFGT5454 | 1107 | 1142 | 54 | 54 | 2.875 | 78.83 | 6.35 | |
| EVFPFGT5460 | 1224 | 1262 | 54 | 60 | 2.875 | 86.09 | 5.16 | |
| EVFPFGT6618 | 678 | 691 | 66 | 18 | 2.875 | 42.33 | 2.68 | |
| EVFPFGT6624 | 817 | 835 | 66 | 24 | 2.875 | 51.74 | 3.58 | |
| EVFPFGT6630 | 916 | 936 | 66 | 30 | 2.875 | 61.55 | 5.23 | |
| EVFPFGT6636 | 1011 | 1035 | 66 | 36 | 2.875 | 70.90 | 5.23 | |
| EVFPFGT6642 | 1128 | 1155 | 66 | 42 | 2.875 | 78.58 | 6.06 | |
| EVFPFGT6648 | 1241 | 1273 | 66 | 48 | 2.875 | 91.87 | 6.88 | |
| EVFPFGT6654 | 1405 | 1438 | 66 | 54 | 2.875 | 101.20 | 6.88 | |
| EVFPFGT6660 | 1568 | 1607 | 66 | 60 | 2.875 | 110.64 | 6.30 | |

EVPFGTU • Fabric 12" Glazed Panel - Tempered Glass

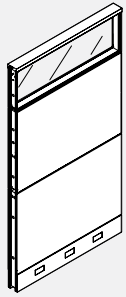

- Fabric 12" Glazed Panel incorporates one 12" glazed module and one 24" fabric modules above the 30" base section.
- Glazing is replaceable on site.

| PRODUCT CODE | PRICE | | SIZE/ INCHES | | | WEIGHT LBS | VOL FT ³ |
|--------------|-------|------|--------------|----|-------|------------|---------------------|
| | GR 1 | GR 2 | H | W | D | | |
| EVPFGTU6618 | 573 | 596 | 66 | 18 | 2.875 | 33.36 | 2.68 |
| EVPFGTU6624 | 670 | 701 | 66 | 24 | 2.875 | 39.38 | 3.58 |
| EVPFGTU6630 | 763 | 805 | 66 | 30 | 2.875 | 46.81 | 4.40 |
| EVPFGTU6636 | 860 | 908 | 66 | 36 | 2.875 | 53.17 | 5.23 |
| EVPFGTU6642 | 966 | 1022 | 66 | 42 | 2.875 | 58.45 | 6.06 |
| EVPFGTU6648 | 1052 | 1113 | 66 | 48 | 2.875 | 68.56 | 6.88 |
| EVPFGTU6654 | 1173 | 1239 | 66 | 54 | 2.875 | 75.28 | 7.70 |
| EVPFGTU6660 | 1294 | 1369 | 66 | 60 | 2.875 | 81.95 | 8.53 |

EVFPFGTU • Fabric 12" Glazed Panel Premium - Tempered Glass

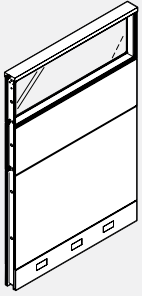

- Premium Fabric 12" Glazed Panel incorporates one 12" glazed module and 1 or 2 12" fabric module or 2 fabric modules above a 30" base section.
- Glazing is replaceable on site.

| PRODUCT CODE | PRICE | | SIZE/ INCHES | | | WEIGHT LBS | VOL FT ³ |
|--------------|-------|------|--------------|----|-------|------------|---------------------|
| | GR 1 | GR 2 | H | W | D | | |
| EVFPFGTU5418 | 524 | 546 | 54 | 18 | 2.875 | 29.56 | 2.19 |
| EVFPFGTU5424 | 621 | 645 | 54 | 24 | 2.875 | 35.78 | 2.06 |
| EVFPFGTU5430 | 699 | 731 | 54 | 30 | 2.875 | 42.61 | 2.58 |
| EVFPFGTU5436 | 791 | 827 | 54 | 36 | 2.875 | 50.97 | 3.09 |
| EVFPFGTU5442 | 886 | 929 | 54 | 42 | 2.875 | 56.65 | 3.61 |
| EVFPFGTU5448 | 962 | 1007 | 54 | 48 | 2.875 | 63.16 | 4.36 |
| EVFPFGTU5454 | 1079 | 1129 | 54 | 54 | 2.875 | 69.48 | 7.70 |
| EVFPFGTU5460 | 1197 | 1255 | 54 | 60 | 2.875 | 75.75 | 5.16 |
| EVFPFGTU6618 | 652 | 676 | 66 | 18 | 2.875 | 35.56 | 2.68 |
| EVFPFGTU6624 | 761 | 794 | 66 | 24 | 2.875 | 42.98 | 3.58 |
| EVFPFGTU6630 | 864 | 905 | 66 | 30 | 2.875 | 51.00 | 4.38 |
| EVFPFGTU6636 | 973 | 1023 | 66 | 36 | 2.875 | 62.56 | 5.23 |
| EVFPFGTU6642 | 1101 | 1155 | 66 | 42 | 2.875 | 70.25 | 6.06 |
| EVFPFGTU6648 | 1188 | 1250 | 66 | 48 | 2.875 | 75.16 | 7.23 |
| EVFPFGTU6654 | 1330 | 1401 | 66 | 54 | 2.875 | 82.50 | 7.70 |
| EVFPFGTU6660 | 1475 | 1550 | 66 | 60 | 2.875 | 82.95 | 6.30 |

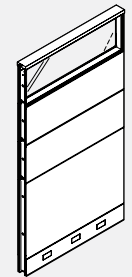

EVPMGTU • Monolithic 12" Glazed Panel - Tempered Glass

- Monolithic 12" Glazed Panel incorporates one 12" glazed module at the top of an otherwise Monolithic Panel.
- Glazing is replaceable on site.

| PRODUCT CODE | PRICE | | SIZE/ INCHES | | | WEIGHT LBS | VOL FT ³ |
|--------------|-------|------|--------------|----|-------|------------|---------------------|
| | GR 1 | GR 2 | H | W | D | | |
| EVPMGTU4818 | 495 | 521 | 48 | 18 | 2.875 | 26.96 | 1.92 |
| EVPMGTU4824 | 580 | 618 | 48 | 24 | 2.875 | 31.98 | 2.62 |
| EVPMGTU4830 | 674 | 718 | 48 | 30 | 2.875 | 37.62 | 3.23 |
| EVPMGTU4836 | 773 | 829 | 48 | 36 | 2.875 | 42.77 | 3.85 |
| EVPMGTU4842 | 856 | 914 | 48 | 42 | 2.875 | 46.45 | 4.45 |
| EVPMGTU4848 | 932 | 1000 | 48 | 48 | 2.875 | 54.45 | 5.06 |
| EVPMGTU4854 | 1035 | 1106 | 48 | 54 | 2.875 | 59.87 | 5.66 |
| EVPMGTU4860 | 1135 | 1220 | 48 | 60 | 2.875 | 67.15 | 6.27 |
| EVPMGTU5418 | 510 | 542 | 54 | 18 | 2.875 | 29.56 | 2.19 |
| EVPMGTU5424 | 593 | 633 | 54 | 24 | 2.875 | 34.58 | 2.94 |
| EVPMGTU5430 | 678 | 755 | 54 | 30 | 2.875 | 40.22 | 3.62 |
| EVPMGTU5436 | 755 | 859 | 54 | 36 | 2.875 | 45.37 | 4.31 |
| EVPMGTU5442 | 845 | 897 | 54 | 42 | 2.875 | 49.05 | 4.99 |
| EVPMGTU5448 | 932 | 1059 | 54 | 48 | 2.875 | 57.16 | 5.67 |
| EVPMGTU5454 | 1020 | 1162 | 54 | 54 | 2.875 | 62.47 | 6.32 |
| EVPMGTU5460 | 1108 | 1268 | 54 | 60 | 2.875 | 67.55 | 7.03 |
| EVPMGTU6618 | 547 | 578 | 66 | 18 | 2.875 | 33.96 | 2.68 |
| EVPMGTU6624 | 656 | 697 | 66 | 24 | 2.875 | 38.98 | 3.58 |
| EVPMGTU6630 | 755 | 800 | 66 | 30 | 2.875 | 44.62 | 4.40 |
| EVPMGTU6636 | 836 | 888 | 66 | 36 | 2.875 | 49.77 | 5.23 |
| EVPMGTU6642 | 930 | 992 | 66 | 42 | 2.875 | 53.45 | 6.06 |
| EVPMGTU6648 | 1027 | 1096 | 66 | 48 | 2.875 | 61.16 | 6.88 |
| EVPMGTU6654 | 1126 | 1201 | 66 | 54 | 2.875 | 66.87 | 6.88 |
| EVPMGTU6660 | 1222 | 1307 | 66 | 60 | 2.875 | 71.95 | 8.53 |

EVPFGTX • Fabric 36" Glazed Panel - Tempered Glass

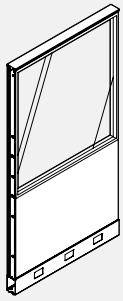

- Fabric 36" Glazed Panel incorporates one 36" glazed module above the 30" base section.
- Glazing is replaceable on site.

| PRODUCT CODE | PRICE | | SIZE/ INCHES | | | WEIGHT LBS | VOL FT³ |
|--------------|-------|------|--------------|----|-------|------------|---------|
| | GR 1 | GR 2 | H | W | D | | |
| EVPFGTX6618 | 658 | 672 | 66 | 18 | 2.875 | 35.45 | 4.23 |
| EVPFGTX6624 | 727 | 747 | 66 | 24 | 2.875 | 42.54 | 5.23 |
| EVPFGTX6630 | 845 | 864 | 66 | 30 | 2.875 | 50.15 | 6.23 |
| EVPFGTX6636 | 960 | 985 | 66 | 36 | 2.875 | 57.26 | 6.23 |
| EVPFGTX6642 | 1074 | 1102 | 66 | 42 | 2.875 | 63.02 | 6.56 |
| EVPFGTX6648 | 1175 | 1208 | 66 | 48 | 2.875 | 72.99 | 6.88 |
| EVPFGTX6654 | 1294 | 1328 | 66 | 54 | 2.875 | 80.28 | 7.70 |
| EVPFGTX6660 | 1411 | 1448 | 66 | 60 | 2.875 | 87.32 | 8.53 |

EVPXGT • Fully Glazed Monolithic Panel - Tempered Glass

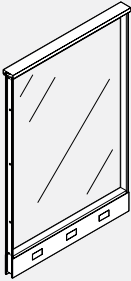

- Fully Glazed Monolithic Panel incorporates one glazed module into a rigid steel frame.
- Glazing is replaceable on site.

| PRODUCT CODE | PRICE | | SIZE/ INCHES | | | WEIGHT LBS | VOL FT³ |
|--------------|-------|----|--------------|-------|-------|------------|---------|
| | H | W | D | LBS | FT³ | | |
| EVPXGT4218 | 463 | 42 | 18 | 2.875 | 26.05 | 1.71 | |
| EVPXGT4224 | 510 | 42 | 24 | 2.875 | 32.14 | 2.31 | |
| EVPXGT4230 | 593 | 42 | 30 | 2.875 | 37.96 | 3.11 | |
| EVPXGT4236 | 670 | 42 | 36 | 2.875 | 43.86 | 3.46 | |
| EVPXGT4242 | 745 | 42 | 42 | 2.875 | 48.02 | 4.46 | |
| EVPXGT4818 | 411 | 48 | 18 | 2.875 | 29.02 | 1.92 | |
| EVPXGT4824 | 529 | 48 | 24 | 2.875 | 35.61 | 2.62 | |
| EVPXGT4830 | 587 | 48 | 30 | 2.875 | 41.93 | 3.23 | |
| EVPXGT4836 | 724 | 48 | 36 | 2.875 | 48.33 | 3.85 | |
| EVPXGT4842 | 760 | 48 | 42 | 2.875 | 52.98 | 4.45 | |
| EVPXGT5418 | 516 | 54 | 18 | 2.875 | 31.60 | 2.19 | |
| EVPXGT5424 | 605 | 54 | 24 | 2.875 | 37.60 | 2.58 | |
| EVPXGT5430 | 702 | 54 | 30 | 2.875 | 45.48 | 3.29 | |
| EVPXGT5436 | 790 | 54 | 36 | 2.875 | 52.39 | 4.58 | |
| EVPXGT5442 | 880 | 54 | 42 | 2.875 | 57.54 | 5.58 | |
| EVPXGT6618 | 604 | 66 | 18 | 2.875 | 37.54 | 2.68 | |
| EVPXGT6624 | 700 | 66 | 24 | 2.875 | 45.61 | 3.58 | |
| EVPXGT6630 | 810 | 66 | 30 | 2.875 | 53.43 | 3.99 | |
| EVPXGT6636 | 909 | 66 | 36 | 2.875 | 61.32 | 4.58 | |
| EVPXGT6642 | 1013 | 66 | 42 | 2.875 | 67.46 | 5.58 | |

EVPGPT • Fully Glazed Premium Panel - Tempered Glass

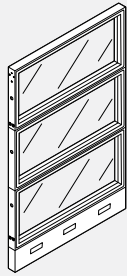

- Fully Glazed Premium Panel incorporates all 12" glazed modules above the 6" base raceway channel.
- Glazing is replaceable on site.

| PRODUCT CODE | PRICE | | SIZE/ INCHES | | | WEIGHT LBS | VOL FT³ |
|--------------|-------|----|--------------|-------|--------|------------|---------|
| | H | W | D | LBS | FT³ | | |
| EVPGPT4218 | 608 | 42 | 18 | 2.875 | 32.13 | 1.71 | |
| EVPGPT4224 | 744 | 42 | 24 | 2.875 | 39.74 | 2.31 | |
| EVPGPT4230 | 826 | 42 | 30 | 2.875 | 47.56 | 2.85 | |
| EVPGPT4236 | 898 | 42 | 36 | 2.875 | 50.90 | 3.38 | |
| EVPGPT4242 | 999 | 42 | 42 | 2.875 | 54.98 | 3.92 | |
| EVPGPT4248 | 1109 | 42 | 48 | 2.875 | 72.27 | 4.45 | |
| EVPGPT4254 | 1225 | 42 | 54 | 2.875 | 70.89 | 4.98 | |
| EVPGPT4260 | 1333 | 42 | 60 | 2.875 | 87.44 | 5.52 | |
| EVPGPT5418 | 773 | 54 | 18 | 2.875 | 35.19 | 2.19 | |
| EVPGPT5424 | 949 | 54 | 24 | 2.875 | 49.76 | 2.58 | |
| EVPGPT5430 | 1050 | 54 | 30 | 2.875 | 52.08 | 3.62 | |
| EVPGPT5436 | 1142 | 54 | 36 | 2.875 | 64.54 | 4.31 | |
| EVPGPT5442 | 1267 | 54 | 42 | 2.875 | 72.62 | 4.99 | |
| EVPGPT5448 | 1415 | 54 | 48 | 2.875 | 78.11 | 5.67 | |
| EVPGPT5454 | 1560 | 54 | 54 | 2.875 | 86.04 | 6.35 | |
| EVPGPT5460 | 1700 | 54 | 60 | 2.875 | 94.09 | 7.03 | |
| EVPGPT6618 | 936 | 66 | 18 | 2.875 | 41.15 | 2.68 | |
| EVPGPT6624 | 1148 | 66 | 24 | 2.875 | 50.96 | 3.58 | |
| EVPGPT6630 | 1269 | 66 | 30 | 2.875 | 60.47 | 3.58 | |
| EVPGPT6636 | 1385 | 66 | 36 | 2.875 | 76.14 | 4.58 | |
| EVPGPT6642 | 1539 | 66 | 42 | 2.875 | 86.22 | 6.06 | |
| EVPGPT6648 | 1714 | 66 | 48 | 2.875 | 90.11 | 6.88 | |
| EVPGPT6654 | 1891 | 66 | 54 | 2.875 | 99.05 | 7.70 | |
| EVPGPT6660 | 2063 | 66 | 60 | 2.875 | 108.29 | 8.53 | |

EVPGT • Fully Glazed Panel - Tempered Glass

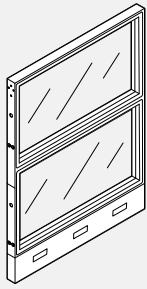

- 54" H Fully Glazed Panels incorporates two 24" Glazed modules.
- Stackability: Evolve Panels can be increased in height in 6", 12" or 24" increments.
- See Extension Module listings for part numbers.
- Standard in clear (CLR)
- Frosted Glass (FRST) upcharge varies. Contact EVOLVE Customer Support for details.
- Glazing is replaceable on site.

| PRODUCT CODE | PRICE | SIZE/ INCHES | | | WEIGHT LBS | VOL FT³ |
|--------------|-------|--------------|----|-------|------------|---------|
| | | H | W | D | | |
| EVPGT5418 | 619 | 54 | 18 | 2.875 | 35.19 | 2.19 |
| EVPGT5424 | 758 | 54 | 24 | 2.875 | 49.76 | 2.58 |
| EVPGT5430 | 837 | 54 | 30 | 2.875 | 52.08 | 3.62 |
| EVPGT5436 | 916 | 54 | 36 | 2.875 | 64.54 | 4.31 |
| EVPGT5442 | 1016 | 54 | 42 | 2.875 | 72.62 | 4.99 |
| EVPGT5448 | 1132 | 54 | 48 | 2.875 | 78.11 | 5.67 |
| EVPGT5454 | 1245 | 54 | 54 | 2.875 | 86.04 | 6.35 |
| EVPGT5460 | 1360 | 54 | 60 | 2.875 | 94.09 | 7.03 |

EVPFOL • Open Bottom Panel

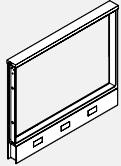

- Open Bottom Panel incorporates a 24" opening in the base section to provide maximum air circulation and access to electrical or data panels.

| PRODUCT CODE | PRICE | | SIZE/ INCHES | | | WEIGHT LBS | VOL FT³ |
|--------------|-------|------|--------------|----|-------|------------|---------|
| | GR 1 | GR 2 | H | W | D | | |
| EVPFOL3018 | 236 | - | 30 | 18 | 2.875 | 17.08 | 1.23 |
| EVPFOL3024 | 270 | - | 30 | 24 | 2.875 | 19.20 | 1.63 |
| EVPFOL3030 | 306 | - | 30 | 30 | 2.875 | 23.05 | 2.00 |
| EVPFOL3036 | 339 | - | 30 | 36 | 2.875 | 25.80 | 2.38 |
| EVPFOL3042 | 371 | - | 30 | 42 | 2.875 | 27.99 | 2.76 |
| EVPFOL3048 | 399 | - | 30 | 48 | 2.875 | 34.00 | 3.13 |
| EVPFOL3054 | 433 | - | 30 | 54 | 2.875 | 37.71 | 3.51 |
| EVPFOL3060 | 464 | - | 30 | 60 | 2.875 | 41.00 | 3.89 |
| EVPFOL4218 | 354 | 365 | 42 | 18 | 2.875 | 22.28 | 1.71 |
| EVPFOL4224 | 409 | 418 | 42 | 24 | 2.875 | 25.60 | 2.31 |
| EVPFOL4230 | 464 | 476 | 42 | 30 | 2.875 | 30.65 | 2.85 |
| EVPFOL4236 | 520 | 535 | 42 | 36 | 2.875 | 36.60 | 3.38 |
| EVPFOL4242 | 579 | 592 | 42 | 42 | 2.875 | 40.79 | 3.92 |
| EVPFOL4248 | 625 | 639 | 42 | 48 | 2.875 | 45.20 | 4.45 |
| EVPFOL4254 | 687 | 705 | 42 | 54 | 2.875 | 49.92 | 4.98 |
| EVPFOL4260 | 744 | 761 | 42 | 60 | 2.875 | 54.40 | 5.52 |
| EVPFOL5418 | 404 | 417 | 54 | 18 | 2.875 | 25.68 | 2.19 |
| EVPFOL5424 | 460 | 478 | 54 | 24 | 2.875 | 28.80 | 2.94 |
| EVPFOL5430 | 524 | 546 | 54 | 30 | 2.875 | 34.45 | 3.24 |
| EVPFOL5436 | 591 | 614 | 54 | 36 | 2.875 | 38.40 | 4.31 |
| EVPFOL5442 | 658 | 687 | 54 | 42 | 2.875 | 42.19 | 4.99 |
| EVPFOL5448 | 712 | 744 | 54 | 48 | 2.875 | 50.20 | 5.67 |
| EVPFOL5454 | 780 | 814 | 54 | 54 | 2.875 | 55.32 | 6.35 |
| EVPFOL5460 | 846 | 884 | 54 | 60 | 2.875 | 60.20 | 7.03 |
| EVPFOL6618 | 523 | 544 | 66 | 18 | 2.875 | 31.68 | 2.68 |
| EVPFOL6624 | 603 | 627 | 66 | 24 | 2.875 | 36.00 | 3.58 |
| EVPFOL6630 | 691 | 721 | 66 | 30 | 2.875 | 42.84 | 4.40 |
| EVPFOL6636 | 775 | 811 | 66 | 36 | 2.875 | 50.00 | 5.23 |
| EVPFOL6642 | 870 | 913 | 66 | 42 | 2.875 | 55.79 | 6.06 |
| EVPFOL6648 | 936 | 984 | 66 | 48 | 2.875 | 62.20 | 6.88 |
| EVPFOL6654 | 1033 | 1086 | 66 | 54 | 2.875 | 68.33 | 7.70 |
| EVPFOL6660 | 1128 | 1186 | 66 | 60 | 2.875 | 74.40 | 8.53 |

EVPFPOL • Open Bottom Panel Premium

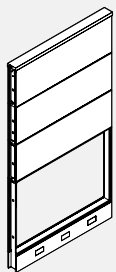

- Open Bottom Premium Panel incorporates a 24" opening in the base section to provide maximum air circulation and access to electrical or data panels.
- 12" high acoustic modules incorporated above the 30" base section.

| PRODUCT CODE | PRICE | | SIZE/ INCHES | | | WEIGHT LBS | VOL FT³ |
|--------------|-------|------|--------------|----|-------|------------|---------|
| | GR 1 | GR 2 | H | W | D | | |
| EVPFPOL5418 | 476 | 487 | 54 | 18 | 2.875 | 27.88 | 2.19 |
| EVPFPOL5424 | 548 | 568 | 54 | 24 | 2.875 | 32.40 | 2.94 |
| EVPFPOL5430 | 626 | 647 | 54 | 30 | 2.875 | 38.64 | 3.24 |
| EVPFPOL5436 | 701 | 725 | 54 | 36 | 2.875 | 47.80 | 4.31 |
| EVPFPOL5442 | 792 | 820 | 54 | 42 | 2.875 | 53.99 | 4.99 |
| EVPFPOL5448 | 850 | 882 | 54 | 48 | 2.875 | 56.80 | 5.67 |
| EVPFPOL5454 | 937 | 972 | 54 | 54 | 2.875 | 62.53 | 6.35 |
| EVPFPOL5460 | 1024 | 1062 | 54 | 60 | 2.875 | 68.20 | 7.03 |
| EVPFPOL6618 | 596 | 615 | 66 | 18 | 2.875 | 33.88 | 1.84 |
| EVPFPOL6624 | 692 | 718 | 66 | 24 | 2.875 | 39.60 | 2.52 |
| EVPFPOL6630 | 786 | 819 | 66 | 30 | 2.875 | 47.03 | 3.15 |
| EVPFPOL6636 | 888 | 925 | 66 | 36 | 2.875 | 59.40 | 5.23 |
| EVPFPOL6642 | 1001 | 1043 | 66 | 42 | 2.875 | 67.59 | 4.41 |
| EVPFPOL6648 | 1073 | 1121 | 66 | 48 | 2.875 | 68.80 | 6.06 |
| EVPFPOL6654 | 1194 | 1243 | 66 | 54 | 2.875 | 75.54 | 7.70 |
| EVPFPOL6660 | 1304 | 1362 | 66 | 60 | 2.875 | 82.40 | 6.30 |

EVPFO • Fabric Open Panel 12" Opening

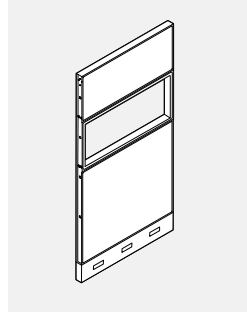

- Fabric Open Panel incorporates a 12" opening above the 30" base section to provide pass-through convenience.

| PRODUCT CODE | PRICE | | SIZE/ INCHES | | | WEIGHT | VOL |
|--------------|-------|------|--------------|----|-------|--------|-----------------|
| | GR 1 | GR 2 | H | W | D | LBS | FT ³ |
| EVPFO5418 | 484 | 505 | 54 | 18 | 2.875 | 26.58 | 2.19 |
| EVPFO5424 | 563 | 589 | 54 | 24 | 2.875 | 31.80 | 2.94 |
| EVPFO5430 | 653 | 682 | 54 | 30 | 2.875 | 37.64 | 3.38 |
| EVPFO5436 | 736 | 774 | 54 | 36 | 2.875 | 45.00 | 4.31 |
| EVPFO5442 | 830 | 870 | 54 | 42 | 2.875 | 49.69 | 4.99 |
| EVPFO5448 | 895 | 942 | 54 | 48 | 2.875 | 55.20 | 5.67 |
| EVPFO5454 | 994 | 1043 | 54 | 54 | 2.875 | 60.53 | 6.35 |
| EVPFO5460 | 1089 | 1146 | 54 | 60 | 2.875 | 65.80 | 7.03 |
| EVPFO6618 | 536 | 561 | 66 | 18 | 2.875 | 30.38 | 2.68 |
| EVPFO6624 | 619 | 653 | 66 | 24 | 2.875 | 35.40 | 3.58 |
| EVPFO6630 | 709 | 748 | 66 | 30 | 2.875 | 41.84 | 5.86 |
| EVPFO6636 | 809 | 856 | 66 | 36 | 2.875 | 47.20 | 5.23 |
| EVPFO6642 | 909 | 963 | 66 | 42 | 2.875 | 51.49 | 6.06 |
| EVPFO6648 | 985 | 1046 | 66 | 48 | 2.875 | 60.60 | 6.88 |
| EVPFO6654 | 1090 | 1157 | 66 | 54 | 2.875 | 66.33 | 7.70 |
| EVPFO6660 | 1196 | 1269 | 66 | 60 | 2.875 | 72.00 | 8.53 |

EVPFPO • Fabric Open Premium Panel 12" Opening

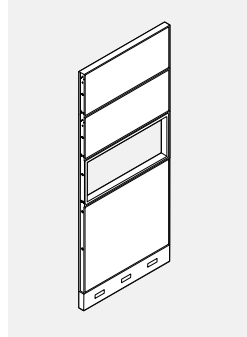

- Fabric Open Premium Panel incorporates a 12" opening above the 30" base section to provide pass-through convenience.
- Two 12" fabric acoustic modules are placed above the 12" opening.

| PRODUCT CODE | PRICE | | SIZE/ INCHES | | | WEIGHT | VOL |
|--------------|-------|------|--------------|----|-------|--------|-----------------|
| | GR 1 | GR 2 | H | W | D | LBS | FT ³ |
| EVPFPO6618 | 607 | 631 | 66 | 18 | 2.875 | 32.58 | 1.84 |
| EVPFPO6624 | 701 | 736 | 66 | 24 | 2.875 | 39.00 | 3.58 |
| EVPFPO6630 | 811 | 851 | 66 | 30 | 2.875 | 46.03 | 4.47 |
| EVPFPO6636 | 917 | 963 | 66 | 36 | 2.875 | 56.60 | 5.23 |
| EVPFPO6642 | 1041 | 1095 | 66 | 42 | 2.875 | 63.29 | 6.06 |
| EVPFPO6648 | 1122 | 1182 | 66 | 48 | 2.875 | 67.20 | 6.88 |
| EVPFPO6654 | 1245 | 1315 | 66 | 54 | 2.875 | 73.54 | 7.70 |
| EVPFPO6660 | 1369 | 1443 | 66 | 60 | 2.875 | 80.00 | 8.53 |

EVPFOX • Fabric Open Premium Panel 24" Opening

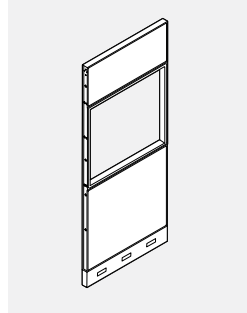

- Fabric Open Premium Panel incorporates a 24" opening above the 30" base section to provide pass-through convenience.
- May or may not have a 12" fabric acoustic module above the 24" opening.

| PRODUCT CODE | PRICE | | SIZE/ INCHES | | | WEIGHT | VOL |
|--------------|-------|------|--------------|----|-------|--------|-----------------|
| | GR 1 | GR 2 | H | W | D | LBS | FT ³ |
| EVPFOX5418 | 404 | 417 | 54 | 18 | 2.875 | 25.68 | 2.19 |
| EVPFOX5424 | 460 | 478 | 54 | 24 | 2.875 | 28.80 | 2.94 |
| EVPFOX5430 | 524 | 546 | 54 | 30 | 2.875 | 34.45 | 3.38 |
| EVPFOX5436 | 591 | 614 | 54 | 36 | 2.875 | 38.40 | 4.31 |
| EVPFOX5442 | 657 | 686 | 54 | 42 | 2.875 | 42.19 | 4.99 |
| EVPFOX5448 | 709 | 740 | 54 | 48 | 2.875 | 50.20 | 5.67 |
| EVPFOX5454 | 779 | 813 | 54 | 54 | 2.875 | 55.32 | 6.35 |
| EVPFOX5460 | 846 | 884 | 54 | 60 | 2.875 | 60.20 | 7.03 |
| EVPFOX6618 | 523 | 544 | 66 | 18 | 2.875 | 31.68 | 2.68 |
| EVPFOX6624 | 603 | 627 | 66 | 24 | 2.875 | 36.00 | 3.58 |
| EVPFOX6630 | 709 | 737 | 66 | 30 | 2.875 | 42.84 | 5.86 |
| EVPFOX6636 | 775 | 811 | 66 | 36 | 2.875 | 50.00 | 5.23 |
| EVPFOX6642 | 870 | 913 | 66 | 42 | 2.875 | 55.79 | 6.06 |
| EVPFOX6648 | 936 | 984 | 66 | 48 | 2.875 | 62.20 | 6.88 |
| EVPFOX6654 | 1033 | 1086 | 66 | 54 | 2.875 | 68.33 | 7.70 |
| EVPFOX6660 | 1128 | 1186 | 66 | 60 | 2.875 | 74.40 | 8.53 |

EVPFSG5M66 - Reception Panels, 24" Fabric Bottom Module and 6" Pass Thru

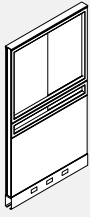

- Reception panel incorporates glazed tempered glass module and pass thru module within steel frame.
- 6" pass thru with sliding tempered glass door module.
- 24" fabric bottom module.
- Aluminum low profile top is included.
- Stackability: Evolve panels can be increased in height in 6", 12", 24" increments. See module listing for part numbers.

| PRODUCT CODE | PRICE | SIZE/ INCHES | | | WEIGHT LBS | VOL FT ³ |
|--------------|-------|--------------|----|-------|------------|---------------------|
| | | H | W | D | | |
| EVPFSG5M6636 | 1016 | 66 | 36 | 2.875 | 70.9 | 5.23 |
| EVPFSG5M6642 | 1131 | 66 | 42 | 2.875 | 78.58 | 6.06 |
| EVPFSG5M6648 | 1244 | 66 | 48 | 2.875 | 91.87 | 6.88 |

EVPFSG3M66 - Reception Panels, 30" Fabric Bottom Module and 6" Pass Thru

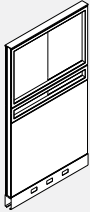

- Reception panel incorporates glazed tempered glass module and pass thru module within steel frame.
- 6" pass thru with sliding tempered glass door module.
- 30" fabric bottom module.
- Aluminum low profile top is included.
- Stackability: Evolve panels can be increased in height in 6", 12", 24" increments. See module listing for part numbers.

| PRODUCT CODE | PRICE | SIZE/ INCHES | | | WEIGHT LBS | VOL FT ³ |
|--------------|-------|--------------|----|-------|------------|---------------------|
| | | H | W | D | | |
| EVPFSG3M6636 | 1053 | 66 | 36 | 2.875 | 70.9 | 5.23 |
| EVPFSG3M6642 | 1148 | 66 | 42 | 2.875 | 78.58 | 6.06 |
| EVPFSG3M6648 | 1246 | 66 | 48 | 2.875 | 91.87 | 6.88 |

EVPFSG2M66 - Reception Panels, 24" Fabric Bottom Module and 12" Pass Thru

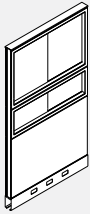

- Reception panel incorporates glazed tempered glass module and pass thru module within steel frame.
- 12" pass thru with sliding tempered glass door module.
- 24" fabric bottom module.
- Aluminum low profile top is included.
- Stackability: Evolve panels can be increased in height in 6", 12", 24" increments. See module listing for part numbers.

| PRODUCT CODE | PRICE | SIZE/ INCHES | | | WEIGHT LBS | VOL FT ³ |
|--------------|-------|--------------|----|-------|------------|---------------------|
| | | H | W | D | | |
| EVPFSG2M6636 | 998 | 66 | 36 | 2.875 | 70.9 | 5.23 |
| EVPFSG2M6642 | 1100 | 66 | 42 | 2.875 | 78.58 | 6.06 |
| EVPFSG2M6648 | 1211 | 66 | 48 | 2.875 | 91.87 | 6.88 |

EVPHSG5M66 - Reception Panels, 24" Laminate Bottom Module and 6" Pass Thru

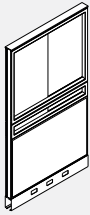

- Reception panel incorporates glazed tempered glass module and pass thru module within steel frame.
- 6" pass thru with sliding tempered glass door module.
- 24" laminate bottom module.
- Aluminum low profile top is included.
- Stackability: Evolve panels can be increased in height in 6", 12", 24" increments. See module listing for part numbers.

| PRODUCT CODE | PRICE | SIZE/ INCHES | | | WEIGHT LBS | VOL FT ³ |
|--------------|-------|--------------|----|-------|------------|---------------------|
| | | H | W | D | | |
| EVPHSG5M6636 | 1137 | 66 | 36 | 2.875 | 70.9 | 5.23 |
| EVPHSG5M6642 | 1233 | 66 | 42 | 2.875 | 78.58 | 6.06 |
| EVPHSG5M6648 | 1328 | 66 | 48 | 2.875 | 91.87 | 6.88 |

EVPHSG3M66 - Reception Panels, 30" Laminate Bottom Module and 6" Pass Thru

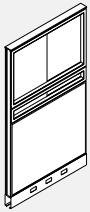

- Reception panel incorporates glazed tempered glass module and pass thru module within steel frame.
- 6" pass thru with sliding tempered glass door module.
- 30" laminate bottom module.
- Aluminum low profile top is included.
- Stackability: Evolve panels can be increased in height in 6", 12", 24" increments. See module listing for part numbers.

| PRODUCT CODE | PRICE | SIZE/ INCHES | | | WEIGHT LBS | VOL FT ³ |
|--------------|-------|--------------|----|-------|------------|---------------------|
| | | H | W | D | | |
| EVPHSG3M6636 | 1137 | 66 | 36 | 2.875 | 70.9 | 5.23 |
| EVPHSG3M6642 | 1233 | 66 | 42 | 2.875 | 78.58 | 6.06 |
| EVPHSG3M6648 | 1328 | 66 | 48 | 2.875 | 91.87 | 6.88 |

EVPHSG2M66 - Reception Panels, 24" Laminate Bottom Module and 12" Pass Thru

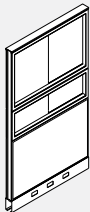

- Reception panel incorporates glazed tempered glass module and pass thru module within steel frame.
- 12" pass thru with sliding tempered glass door module.
- 24" laminate bottom module.
- Aluminum low profile top is included.
- Stackability: Evolve panels can be increased in height in 6", 12", 24" increments. See module listing for part numbers.

| PRODUCT CODE | PRICE | SIZE/ INCHES | | | WEIGHT LBS | VOL FT ³ |
|--------------|-------|--------------|----|-------|------------|---------------------|
| | | H | W | D | | |
| EVPHSG2M6636 | 1112 | 66 | 36 | 2.875 | 70.9 | 5.23 |
| EVPHSG2M6642 | 1204 | 66 | 42 | 2.875 | 78.58 | 6.06 |
| EVPHSG2M6648 | 1302 | 66 | 48 | 2.875 | 91.87 | 6.88 |

EVPPFAF • Air Flow Panel

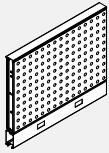

- Metal Air Flow Panel.
- Stackability: Evolve panels can be increased in height in 6", 12", 24" increments. See module listing for part numbers.

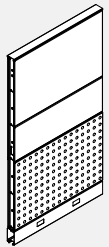
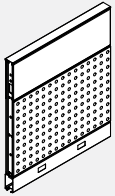

| PRODUCT CODE | PRICE | | SIZE/ INCHES | | | WEIGHT LBS | VOL FT ³ |
|--------------|-------|------|--------------|----|-------|------------|---------------------|
| | GR 1 | GR 2 | H | W | D | | |
| EVPPFAF3024 | 399 | - | 30 | 24 | 2.875 | 22.08 | 1.63 |
| EVPPFAF3030 | 475 | - | 30 | 30 | 2.875 | 26.51 | 2.00 |
| EVPPFAF3036 | 524 | - | 30 | 36 | 2.875 | 29.67 | 2.38 |
| EVPPFAF3042 | 581 | - | 30 | 42 | 2.875 | 32.19 | 2.76 |
| EVPPFAF3048 | 657 | - | 30 | 48 | 2.875 | 39.10 | 3.13 |
| EVPPFAF3054 | 755 | - | 30 | 54 | 2.875 | 43.37 | 3.51 |
| EVPPFAF3060 | 852 | - | 30 | 60 | 2.875 | 47.15 | 3.89 |
| EVPPFAF4224 | 509 | 517 | 42 | 24 | 2.875 | 29.44 | 2.31 |
| EVPPFAF4230 | 603 | 612 | 42 | 30 | 2.875 | 35.25 | 2.81 |
| EVPPFAF4236 | 670 | 682 | 42 | 36 | 2.875 | 42.09 | 3.38 |
| EVPPFAF4242 | 746 | 758 | 42 | 42 | 2.875 | 46.91 | 3.92 |
| EVPPFAF4248 | 842 | 856 | 42 | 48 | 2.875 | 51.98 | 4.45 |
| EVPPFAF4254 | 958 | 975 | 42 | 54 | 2.875 | 57.41 | 4.98 |
| EVPPFAF4260 | 972 | 994 | 42 | 60 | 2.875 | 62.56 | 5.52 |
| EVPPFAF5424 | 570 | 586 | 54 | 24 | 2.875 | 33.12 | 2.94 |
| EVPPFAF5430 | 656 | 676 | 54 | 30 | 2.875 | 39.62 | 3.62 |
| EVPPFAF5436 | 736 | 759 | 54 | 36 | 2.875 | 44.16 | 4.31 |
| EVPPFAF5442 | 820 | 849 | 54 | 42 | 2.875 | 48.52 | 4.99 |
| EVPPFAF5448 | 921 | 954 | 54 | 48 | 2.875 | 57.73 | 5.67 |
| EVPPFAF5454 | 1073 | 1108 | 54 | 54 | 2.875 | 63.62 | 6.35 |
| EVPPFAF5460 | 1169 | 1205 | 54 | 60 | 2.875 | 69.23 | 7.03 |
| EVPPFAF6624 | 665 | 691 | 66 | 24 | 2.875 | 41.40 | 3.58 |
| EVPPFAF6630 | 785 | 816 | 66 | 30 | 2.875 | 49.27 | 4.40 |
| EVPPFAF6636 | 882 | 917 | 66 | 36 | 2.875 | 57.50 | 5.23 |
| EVPPFAF6642 | 983 | 1023 | 66 | 42 | 2.875 | 64.16 | 6.06 |
| EVPPFAF6648 | 1106 | 1153 | 66 | 48 | 2.875 | 71.53 | 6.08 |
| EVPPFAF6654 | 1255 | 1303 | 66 | 54 | 2.875 | 78.58 | 7.70 |
| EVPPFAF6660 | 1391 | 1447 | 66 | 60 | 2.875 | 85.56 | 8.53 |

EVPPPAF • Premium Air Flow Panel

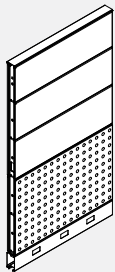

- Metal Air Flow Panel.
- Each side of panel may have different fabric within same grade at no upcharge.
- There is no panel creep.
- Stackability: Evolve panels can be increased in height in 6", 12", 24" increments. See module listing for part numbers.

| PRODUCT CODE | PRICE | | SIZE/ INCHES | | | WEIGHT LBS | VOL FT ³ |
|--------------|-------|------|--------------|----|-------|------------|---------------------|
| | GR 1 | GR 2 | H | W | D | | |
| EVPPPAF5424 | 633 | 653 | 54 | 24 | 2.875 | 37.26 | 2.94 |
| EVPPPAF5430 | 724 | 747 | 54 | 30 | 2.875 | 44.44 | 3.62 |
| EVPPPAF5436 | 814 | 839 | 54 | 36 | 2.875 | 54.97 | 4.31 |
| EVPPPAF5442 | 903 | 930 | 54 | 42 | 2.875 | 62.09 | 4.99 |
| EVPPPAF5448 | 1023 | 1055 | 54 | 48 | 2.875 | 65.32 | 5.67 |
| EVPPPAF5454 | 1157 | 1194 | 54 | 54 | 2.875 | 73.06 | 6.35 |
| EVPPPAF5460 | 1294 | 1330 | 54 | 60 | 2.875 | 78.43 | 7.03 |
| EVPPPAF6624 | 725 | 752 | 66 | 24 | 2.875 | 45.54 | 3.58 |
| EVPPPAF6630 | 853 | 885 | 66 | 30 | 2.875 | 54.08 | 4.40 |
| EVPPPAF6636 | 956 | 994 | 66 | 36 | 2.875 | 68.31 | 5.23 |
| EVPPPAF6642 | 1062 | 1102 | 66 | 42 | 2.875 | 77.73 | 6.06 |
| EVPPPAF6648 | 1205 | 1255 | 66 | 48 | 2.875 | 79.12 | 6.08 |
| EVPPPAF6654 | 1358 | 1409 | 66 | 54 | 2.875 | 86.87 | 7.70 |
| EVPPPAF6660 | 1514 | 1570 | 66 | 60 | 2.875 | 94.76 | 8.53 |

EVPPMAF • Premium Air Flow Panel

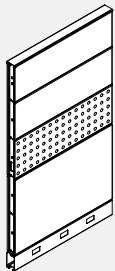

- Metal Air Flow Panel.
- Each side of panel may have different fabric within same grade at no upcharge.
- There is no panel creep.
- Stackability: Evolve panels can be increased in height in 6", 12", 24" increments. See module listing for part numbers.

| PRODUCT CODE | PRICE | | SIZE/ INCHES | | | WEIGHT LBS | VOL FT ³ |
|--------------|-------|------|--------------|----|-------|------------|---------------------|
| | GR 1 | GR 2 | H | W | D | | |
| EVPPMAF5424 | 695 | 722 | 54 | 24 | 2.875 | 36.57 | 2.94 |
| EVPPMAF5430 | 825 | 854 | 54 | 30 | 2.875 | 43.29 | 3.62 |
| EVPPMAF5436 | 937 | 973 | 54 | 36 | 2.875 | 51.75 | 4.31 |
| EVPPMAF5442 | 1055 | 1094 | 54 | 42 | 2.875 | 57.14 | 4.99 |
| EVPPMAF5448 | 1175 | 1224 | 54 | 48 | 2.875 | 63.48 | 5.67 |
| EVPPMAF5454 | 1330 | 1382 | 54 | 54 | 2.875 | 69.61 | 6.35 |
| EVPPMAF5460 | 1484 | 1542 | 54 | 60 | 2.875 | 75.67 | 7.03 |
| EVPPMAF6624 | 791 | 825 | 66 | 24 | 2.875 | 44.85 | 3.58 |
| EVPPMAF6630 | 935 | 975 | 66 | 30 | 2.875 | 52.93 | 4.40 |
| EVPPMAF6636 | 1063 | 1112 | 66 | 36 | 2.875 | 65.09 | 5.23 |
| EVPPMAF6642 | 1193 | 1244 | 66 | 42 | 2.875 | 72.78 | 6.06 |
| EVPPMAF6648 | 1330 | 1394 | 66 | 48 | 2.875 | 77.28 | 6.08 |
| EVPPMAF6654 | 1500 | 1568 | 66 | 54 | 2.875 | 84.58 | 7.70 |
| EVPPMAF6660 | 1669 | 1745 | 66 | 60 | 2.875 | 92.00 | 8.53 |

EVPDS • Door Panel - Solid

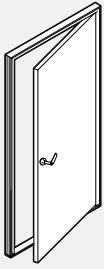

- 90" Door Panel height = 66" high panel plus one 24" or two 12" Panel Extension Modules.
- 1 3/8" thick hollow core door.
- Handedness can be changed in the field.
- Handle sold separately. Specify type of handle required.

| PRODUCT CODE | PRICE | SIZE/ INCHES | | | WEIGHT LBS | VOL FT ³ |
|--------------|-------|--------------|----|-------|------------|---------------------|
| | | H | W | D | | |
| EVPDS7836L | 2356 | 78 | 36 | 2.875 | 64.00 | 7.50 |
| EVPDS7836R | 2356 | 78 | 36 | 2.875 | 64.00 | 7.50 |
| EVPDS7842L | 2740 | 78 | 42 | 2.875 | 74.00 | 8.50 |
| EVPDS7842R | 2740 | 78 | 42 | 2.875 | 74.00 | 8.50 |
| EVPDS8436L | 2480 | 84 | 36 | 2.875 | 62.00 | 7.00 |
| EVPDS8436R | 2480 | 84 | 36 | 2.875 | 62.00 | 7.00 |
| EVPDS8442L | 2871 | 84 | 42 | 2.875 | 72.00 | 8.00 |
| EVPDS8442R | 2871 | 84 | 42 | 2.875 | 72.00 | 8.00 |
| EVPDS9036L | 2490 | 90 | 36 | 2.875 | 66.00 | 8.00 |
| EVPDS9036R | 2490 | 90 | 36 | 2.875 | 66.00 | 8.00 |
| EVPDS9042L | 2871 | 90 | 42 | 2.875 | 76.00 | 9.00 |
| EVPDS9042R | 2871 | 90 | 42 | 2.875 | 76.00 | 9.00 |

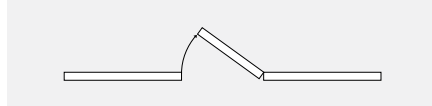

RIGHT HAND HUNG

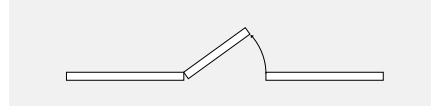

LEFT HAND HUNG

EVPDG • Full Glazed Door panel

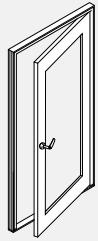

- All door surfaces are high pressure laminate with window.
- If laminate is selected in wood grain, the grain runs vertical.
- HP laminate finish available in all standard finishes.
- Select frame color from standard trim colors.
- 84" Door panel height is 66"h panel and 18" H Panel extension modules.
- 90" Door panel height is 66"h panel and 24" H or two 12" H Panel extension modules.
- Door and door trim can be specified left or right handed.
- Handedness of Door can be changed in field.
- Door Sizes:
 36" W door is 33.63" W without frame (This door is not ADA compliant)
 42" W door is 39.63" W without frame
 84" H door is 81.50" H without frame
 90" H door is 87.50" H without frame
- Customer is responsible to confirm and meet, city, county or any other municipality codes in relation to door clearances.
- Knob or lever to be ordered separately.

| PRODUCT CODE | PRICE CLR | FRST | SIZE/INCHES | | | WEIGHT LBS | VOL FT ³ |
|--------------|-----------|------|-------------|----|-------|------------|---------------------|
| | | | H | W | D | | |
| EVPDG8436L | 2762 | 2862 | 84 | 36 | 2.875 | 62 | 7 |
| EVPDG8436R | 2762 | 2862 | 84 | 36 | 2.875 | 62 | 7 |
| EVPDG8442L | 3146 | 3243 | 84 | 42 | 2.875 | 72 | 8 |
| EVPDG8442R | 3146 | 3243 | 84 | 42 | 2.875 | 72 | 8 |
| EVPDG9036L | 2762 | 2862 | 90 | 36 | 2.875 | 66 | 8 |
| EVPDG9036R | 2762 | 2862 | 90 | 36 | 2.875 | 66 | 8 |
| EVPDG9042L | 3146 | 3243 | 90 | 42 | 2.875 | 76 | 9 |
| EVPDG9042R | 3146 | 3243 | 90 | 42 | 2.875 | 76 | 9 |

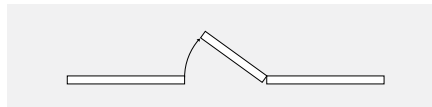

RIGHT HAND HUNG

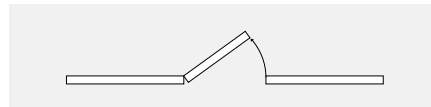

LEFT HAND HUNG

EVPDSL • Door Handles

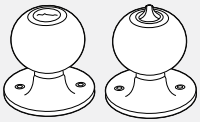

EVPDSL01



EVPDSL02

| PRODUCT CODE | PRICE | SIZE/ INCHES | | | WEIGHT LBS | VOL FT ³ |
|--------------|-------|--------------|---|---|------------|---------------------|
| | | H | W | D | | |
| EVPDSL01 | 90 | | | | 0.50 | 0.50 |
| EVPDSL02 | 127 | | | | 0.30 | 0.10 |

EVPDSL • Sliding Door

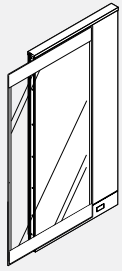

- Provides territorial privacy in an open plan environment.
- Lightweight, panel mounted sliding partition.
- Consists of translucent textured polycarbonate.
- Must be mounted to a panel of the same size.
- The face of the Privacy Screen sits 3" away from the face of the panel to which it is attached.
- When open, the screen may interfere with raceway doors that open on the outside of an adjacent panel.
- Must specify left or right for the direction in which the door will slide once installed.
- Caps located on the end of the frame default to the panel frame colour.
- All hardware included.

• Note: Specify left or right for the direction in which the door will slide as per examples above.

| PRODUCT CODE | PRICE | SIZE/ INCHES | | | WEIGHT VOL | |
|--------------|-------|--------------|----|------|------------|-----------------|
| | | H | W | D | LBS | FT ³ |
| EVPDSL6636R | 1981 | 66 | 36 | 2.61 | 35 | 5.98 |
| EVPDSL6636L | 1981 | 66 | 36 | 2.61 | 35 | 5.98 |
| EVPDSL6642R | 2132 | 66 | 42 | 2.61 | 42 | 6.93 |
| EVPDSL6642L | 2132 | 66 | 42 | 2.61 | 42 | 6.93 |
| EVPDSL8136R | 2377 | 81 | 36 | 2.61 | 43 | 7.30 |
| EVPDSL8136L | 2377 | 81 | 36 | 2.61 | 43 | 7.30 |
| EVPDSL8142R | 2551 | 81 | 42 | 2.61 | 50 | 8.45 |
| EVPDSL8142L | 2551 | 81 | 42 | 2.61 | 50 | 8.45 |

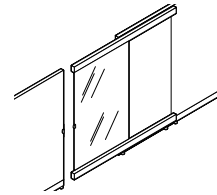

Left Hand Option

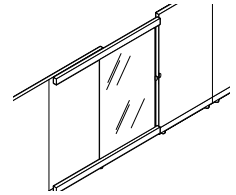

Right Hand Option

EVPDSLLOCK • Sliding Door Lock

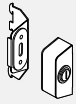

Left Hand Shown

- Lock bracket attaches to Sliding door with screws
- Includes strike plate bracket which attaches to slots in connector.
- Lock included.
- Available in tungsten only.

| PRODUCT CODE | PRICE | SIZE/INCHES | | | WEIGHT VOL | |
|--------------|-------|-------------|-----|-----|------------|-----------------|
| | | H | W | D | LBS | FT ³ |
| EVPDSLLOCKR | 240 | 2.65 | 1.2 | 0.9 | 1.0 | 0.2 |
| EVPDSLLOCKL | 240 | 2.65 | 1.2 | 0.9 | 1.0 | 0.2 |

EVAFMB01 • Floor Mount Plate

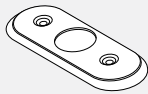

- Attached to floor.
- Secures panel to floor.
- Attachment screws not included.
- Care should be taken to use correct fasteners for type of floor.
- Available in chrome finish only.

| PRODUCT CODE | PRICE | SIZE/ INCHES | | | WEIGHT VOL | |
|--------------|-------|--------------|---|-----|------------|-----------------|
| | | H | W | D | LBS | FT ³ |
| EVAFMB01 | 72 | 0.25 | 5 | 2.5 | 0.2 | 0.02 |

EVPFE • Panel Extension Module

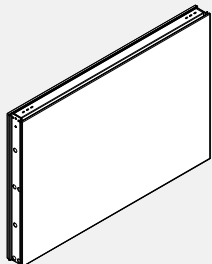

- Single modules are 6", 12", 18" or 24" high.
- When ordering Panel Extension Module, additional connectors are required.

| PRODUCT CODE | PRICE | | SIZE/ INCHES | | | WEIGHT VOL | |
|--------------|-------|------|--------------|----|-------|------------|-----------------|
| | GR 1 | GR 2 | H | W | D | LBS | FT ³ |
| EVPFE0618 | 153 | 160 | 6 | 18 | 2.875 | 4.80 | 0.21 |
| EVPFE0624 | 159 | 169 | 6 | 24 | 2.875 | 6.40 | 0.29 |
| EVPFE0630 | 174 | 183 | 6 | 30 | 2.875 | 7.40 | 0.36 |
| EVPFE0636 | 195 | 207 | 6 | 36 | 2.875 | 8.20 | 0.43 |
| EVPFE0642 | 217 | 233 | 6 | 42 | 2.875 | 9.40 | 0.51 |
| EVPFE0648 | 235 | 248 | 6 | 48 | 2.875 | 10.20 | 0.58 |
| EVPFE0654 | 253 | 271 | 6 | 54 | 2.875 | 14.40 | 0.65 |
| EVPFE0660 | 276 | 295 | 6 | 60 | 2.875 | 16.00 | 0.73 |
| EVPFE1218 | 153 | 160 | 12 | 18 | 2.875 | 7.40 | 0.38 |
| EVPFE1224 | 159 | 168 | 12 | 24 | 2.875 | 8.60 | 0.50 |
| EVPFE1230 | 174 | 183 | 12 | 30 | 2.875 | 9.60 | 0.63 |
| EVPFE1236 | 195 | 207 | 12 | 36 | 2.875 | 12.80 | 0.75 |
| EVPFE1242 | 217 | 231 | 12 | 42 | 2.875 | 14.80 | 0.88 |
| EVPFE1248 | 235 | 248 | 12 | 48 | 2.875 | 15.00 | 1.00 |
| EVPFE1254 | 253 | 271 | 12 | 54 | 2.875 | 16.20 | 1.12 |
| EVPFE1260 | 276 | 295 | 12 | 60 | 2.875 | 17.80 | 1.25 |
| EVPFE1818 | 190 | 201 | 18 | 18 | 2.875 | 9.01 | 0.54 |
| EVPFE1824 | 197 | 211 | 18 | 24 | 2.875 | 10.47 | 0.72 |
| EVPFE1830 | 212 | 234 | 18 | 30 | 2.875 | 11.93 | 0.90 |
| EVPFE1836 | 246 | 268 | 18 | 36 | 2.875 | 13.39 | 1.08 |
| EVPFE1842 | 274 | 301 | 18 | 42 | 2.875 | 14.84 | 1.26 |
| EVPFE1848 | 298 | 328 | 18 | 48 | 2.875 | 16.29 | 1.44 |
| EVPFE1854 | 324 | 355 | 18 | 54 | 2.875 | 17.76 | 1.62 |
| EVPFE1860 | 352 | 382 | 18 | 60 | 2.875 | 19.21 | 1.80 |
| EVPFE2418 | 190 | 201 | 24 | 18 | 2.875 | 10.60 | 0.75 |
| EVPFE2424 | 197 | 212 | 24 | 24 | 2.875 | 12.32 | 1.00 |
| EVPFE2430 | 212 | 234 | 24 | 30 | 2.875 | 14.03 | 1.25 |
| EVPFE2436 | 246 | 268 | 24 | 36 | 2.875 | 15.75 | 1.50 |
| EVPFE2442 | 274 | 301 | 24 | 42 | 2.875 | 17.46 | 1.75 |
| EVPFE2448 | 298 | 328 | 24 | 48 | 2.875 | 19.17 | 2.00 |
| EVPFE2454 | 324 | 355 | 24 | 54 | 2.875 | 20.89 | 2.25 |
| EVPFE2460 | 352 | 391 | 24 | 60 | 2.875 | 22.60 | 2.50 |

EVPFPE • Panel Extension Module Premium

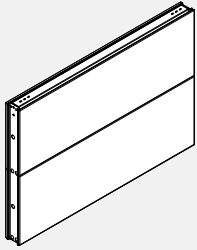

- Two 12" modules are incorporated into one 24" high metal frame.
- When ordering Panel Extension Module, additional connectors are required.

| PRODUCT CODE | PRICE | | SIZE/ INCHES | | | WEIGHT | | VOL FT ³ |
|--------------|-------|------|--------------|----|-------|--------|------|---------------------|
| | GR 1 | GR 2 | H | W | D | LBS | | |
| EVPFPE2418 | 260 | 270 | 24 | 18 | 2.875 | 13.90 | 1.02 | |
| EVPFPE2424 | 276 | 293 | 24 | 24 | 2.875 | 16.80 | 1.42 | |
| EVPFPE2430 | 307 | 328 | 24 | 30 | 2.875 | 19.58 | 1.75 | |
| EVPFPE2436 | 350 | 373 | 24 | 36 | 2.875 | 26.40 | 2.07 | |
| EVPFPE2442 | 391 | 418 | 24 | 42 | 2.875 | 31.04 | 2.40 | |
| EVPFPE2448 | 419 | 450 | 24 | 48 | 2.875 | 38.40 | 2.73 | |
| EVPFPE2454 | 464 | 499 | 24 | 54 | 2.875 | 30.90 | 2.25 | |
| EVPFPE2460 | 508 | 544 | 24 | 60 | 2.875 | 34.00 | 3.39 | |

EVPW1SE • Writeboard Extension Module - One Side

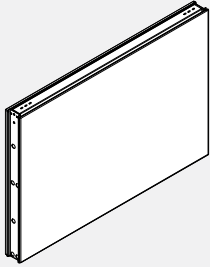

- Single 18" or 24" high module with Writeboard on one side and fabric on the other side.
- Use of erasable Writeboard markers only.
- When ordering Panel Extension Module, additional connectors are required.

| PRODUCT CODE | PRICE | | SIZE/ INCHES | | | WEIGHT | | VOL FT ³ |
|--------------|-------|------|--------------|----|-------|--------|------|---------------------|
| | GR 1 | GR 2 | H | W | D | LBS | | |
| EVPW1SE0618 | 212 | 217 | 06 | 18 | 3 | 2.77 | 0.25 | |
| EVPW1SE0624 | 247 | 259 | 06 | 24 | 3 | 3.20 | 0.35 | |
| EVPW1SE0630 | 280 | 284 | 06 | 30 | 3 | 3.63 | 0.43 | |
| EVPW1SE0636 | 319 | 327 | 06 | 36 | 3 | 4.06 | 0.51 | |
| EVPW1SE0642 | 361 | 367 | 06 | 42 | 3 | 4.49 | 0.60 | |
| EVPW1SE0648 | 394 | 404 | 06 | 48 | 3 | 4.91 | 0.68 | |
| EVPW1SE0654 | 446 | 454 | 06 | 54 | 3 | 5.34 | 0.76 | |
| EVPW1SE0660 | 469 | 477 | 06 | 60 | 3 | 5.77 | 0.84 | |
| EVPW1SE0666 | 488 | 500 | 06 | 66 | 3 | 6.17 | 0.91 | |
| EVPW1SE0672 | 542 | 550 | 06 | 72 | 3 | 6.57 | 0.99 | |
| EVPW1SE1218 | 212 | 217 | 12 | 18 | 3 | 5.55 | 0.51 | |
| EVPW1SE1224 | 247 | 259 | 12 | 24 | 3 | 6.41 | 0.71 | |
| EVPW1SE1230 | 280 | 284 | 12 | 30 | 3 | 7.26 | 0.87 | |
| EVPW1SE1236 | 319 | 327 | 12 | 36 | 3 | 8.12 | 1.03 | |
| EVPW1SE1242 | 361 | 367 | 12 | 42 | 3 | 8.98 | 1.20 | |
| EVPW1SE1248 | 394 | 404 | 12 | 48 | 3 | 9.83 | 1.36 | |
| EVPW1SE1254 | 446 | 454 | 12 | 54 | 3 | 10.69 | 1.53 | |
| EVPW1SE1260 | 469 | 477 | 12 | 60 | 3 | 11.55 | 1.69 | |
| EVPW1SE1266 | 488 | 500 | 12 | 66 | 3 | 12.41 | 1.85 | |
| EVPW1SE1272 | 542 | 550 | 12 | 72 | 3 | 13.27 | 1.99 | |
| EVPW1SE1818 | 233 | 237 | 18 | 18 | 2.875 | 9.44 | 0.54 | |
| EVPW1SE1824 | 263 | 270 | 18 | 24 | 2.875 | 10.90 | 0.72 | |
| EVPW1SE1830 | 293 | 303 | 18 | 30 | 2.875 | 12.35 | 0.90 | |
| EVPW1SE1836 | 344 | 355 | 18 | 36 | 2.875 | 13.81 | 1.08 | |
| EVPW1SE1842 | 389 | 405 | 18 | 42 | 2.875 | 15.27 | 1.26 | |
| EVPW1SE1848 | 430 | 448 | 18 | 48 | 2.875 | 16.72 | 1.44 | |
| EVPW1SE1854 | 465 | 483 | 18 | 54 | 2.875 | 18.18 | 1.62 | |
| EVPW1SE1860 | 503 | 520 | 18 | 60 | 2.875 | 19.64 | 1.80 | |
| EVPW1SE2418 | 233 | 237 | 24 | 18 | 2.875 | 11.10 | 1.02 | |
| EVPW1SE2424 | 263 | 271 | 24 | 24 | 2.875 | 12.82 | 2.07 | |
| EVPW1SE2430 | 293 | 304 | 24 | 30 | 2.875 | 14.53 | 2.17 | |
| EVPW1SE2436 | 344 | 355 | 24 | 36 | 2.875 | 16.25 | 2.27 | |
| EVPW1SE2442 | 389 | 405 | 24 | 42 | 2.875 | 17.96 | 2.37 | |
| EVPW1SE2448 | 430 | 443 | 24 | 48 | 2.875 | 19.67 | 2.47 | |
| EVPW1SE2454 | 465 | 483 | 24 | 54 | 2.875 | 21.39 | 2.25 | |
| EVPW1SE2460 | 503 | 520 | 24 | 60 | 2.875 | 23.10 | 3.47 | |

EVPW2SE • Writeboard Extension Module - Two Side

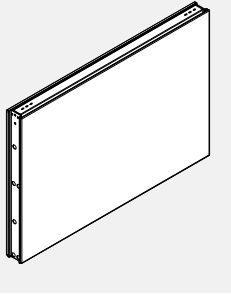

- Single 18" or 24" high module with Writeboard on both sides.
- Use of erasable Writeboard markers only.
- When ordering Panel Extension Module, additional connectors are required.

| PRODUCT CODE | PRICE | SIZE/ INCHES | | | WEIGHT VOL | |
|--------------|-------|--------------|----|-------|------------|------|
| | | H | W | D | LBS | FT³ |
| EVPW2SE0618 | 234 | 06 | 18 | 3 | 2.77 | 0.25 |
| EVPW2SE0624 | 274 | 06 | 24 | 3 | 3.20 | 0.35 |
| EVPW2SE0630 | 318 | 06 | 30 | 3 | 3.63 | 0.43 |
| EVPW2SE0636 | 364 | 06 | 36 | 3 | 4.06 | 0.51 |
| EVPW2SE0642 | 410 | 06 | 42 | 3 | 4.49 | 0.60 |
| EVPW2SE0648 | 460 | 06 | 48 | 3 | 4.91 | 0.68 |
| EVPW2SE0654 | 535 | 06 | 54 | 3 | 5.34 | 0.76 |
| EVPW2SE0660 | 544 | 06 | 60 | 3 | 5.77 | 0.84 |
| EVPW2SE0666 | 555 | 06 | 66 | 3 | 6.17 | 0.91 |
| EVPW2SE0672 | 627 | 06 | 72 | 3 | 6.57 | 0.99 |
| EVPW2SE1218 | 234 | 12 | 18 | 3 | 5.55 | 0.51 |
| EVPW2SE1224 | 274 | 12 | 24 | 3 | 6.41 | 0.71 |
| EVPW2SE1230 | 318 | 12 | 30 | 3 | 7.26 | 0.87 |
| EVPW2SE1236 | 364 | 12 | 36 | 3 | 8.12 | 1.03 |
| EVPW2SE1242 | 410 | 12 | 42 | 3 | 8.98 | 1.20 |
| EVPW2SE1248 | 460 | 12 | 48 | 3 | 9.83 | 1.36 |
| EVPW2SE1254 | 535 | 12 | 54 | 3 | 10.69 | 1.53 |
| EVPW2SE1260 | 544 | 12 | 60 | 3 | 11.55 | 1.69 |
| EVPW2SE1266 | 555 | 12 | 66 | 3 | 12.41 | 1.85 |
| EVPW2SE1272 | 627 | 12 | 72 | 3 | 13.27 | 1.99 |
| EVPW2SE1818 | 279 | 18 | 18 | 2.875 | 10.29 | 0.54 |
| EVPW2SE1824 | 328 | 18 | 24 | 2.875 | 11.75 | 0.72 |
| EVPW2SE1830 | 375 | 18 | 30 | 2.875 | 13.20 | 0.90 |
| EVPW2SE1836 | 446 | 18 | 36 | 2.875 | 14.66 | 1.08 |
| EVPW2SE1842 | 503 | 18 | 42 | 2.875 | 16.12 | 1.26 |
| EVPW2SE1848 | 562 | 18 | 48 | 2.875 | 17.57 | 1.44 |
| EVPW2SE1854 | 622 | 18 | 54 | 2.875 | 19.03 | 1.62 |
| EVPW2SE1860 | 678 | 18 | 60 | 2.875 | 20.49 | 1.80 |
| EVPW2SE2418 | 279 | 24 | 18 | 2.875 | 12.10 | 0.75 |
| EVPW2SE2424 | 328 | 24 | 24 | 2.875 | 13.82 | 2.07 |
| EVPW2SE2430 | 375 | 24 | 30 | 2.875 | 15.53 | 2.17 |
| EVPW2SE2436 | 446 | 24 | 36 | 2.875 | 17.25 | 2.27 |
| EVPW2SE2442 | 503 | 24 | 42 | 2.875 | 18.96 | 2.37 |
| EVPW2SE2448 | 562 | 24 | 48 | 2.875 | 20.67 | 2.73 |
| EVPW2SE2454 | 622 | 24 | 54 | 2.875 | 22.39 | 2.35 |
| EVPW2SE2460 | 678 | 24 | 60 | 2.875 | 24.10 | 3.39 |

EVPGTE • Tempered Glass Panel Extension Module

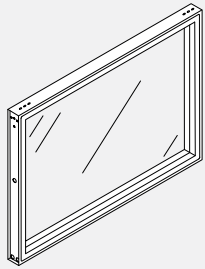

- Single 6", 12", 18" or 24" high module with glazing.
- When ordering Panel Extension Module, additional connectors are required.

| PRODUCT CODE | PRICE | SIZE/ INCHES | | | WEIGHT LBS | VOL FT ³ |
|--------------|-------|--------------|----|-------|------------|---------------------|
| | | H | W | D | | |
| EVPGTE0618 | 305 | 6 | 18 | 2.875 | 7.60 | 0.18 |
| EVPGTE0624 | 328 | 6 | 24 | 2.875 | 9.24 | 0.25 |
| EVPGTE0630 | 397 | 6 | 30 | 2.875 | 10.78 | 0.31 |
| EVPGTE0636 | 412 | 6 | 36 | 2.875 | 12.32 | 0.37 |
| EVPGTE0642 | 508 | 6 | 42 | 2.875 | 14.10 | 0.43 |
| EVPGTE0648 | 567 | 6 | 48 | 2.875 | 15.80 | 0.50 |
| EVPGTE0654 | 621 | 6 | 54 | 2.875 | 17.42 | 0.56 |
| EVPGTE0660 | 666 | 6 | 60 | 2.875 | 19.28 | 0.63 |
| EVPGTE1218 | 305 | 12 | 18 | 2.875 | 10.06 | 0.38 |
| EVPGTE1224 | 328 | 12 | 24 | 2.875 | 12.08 | 0.50 |
| EVPGTE1230 | 397 | 12 | 30 | 2.875 | 14.10 | 0.63 |
| EVPGTE1236 | 412 | 12 | 36 | 2.875 | 16.12 | 0.75 |
| EVPGTE1242 | 508 | 12 | 42 | 2.875 | 18.24 | 0.88 |
| EVPGTE1248 | 567 | 12 | 48 | 2.875 | 20.56 | 1.00 |
| EVPGTE1254 | 621 | 12 | 54 | 2.875 | 22.66 | 1.12 |
| EVPGTE1260 | 666 | 12 | 60 | 2.875 | 25.00 | 1.25 |
| EVPGTE1818 | 459 | 18 | 18 | 2.875 | 12.00 | 0.54 |
| EVPGTE1824 | 473 | 18 | 24 | 2.875 | 14.93 | 0.72 |
| EVPGTE1830 | 505 | 18 | 30 | 2.875 | 17.77 | 0.90 |
| EVPGTE1836 | 551 | 18 | 36 | 2.875 | 20.57 | 1.08 |
| EVPGTE1842 | 627 | 18 | 42 | 2.875 | 23.31 | 1.26 |
| EVPGTE1848 | 701 | 18 | 48 | 2.875 | 25.94 | 1.44 |
| EVPGTE1854 | 762 | 18 | 54 | 2.875 | 28.51 | 1.62 |
| EVPGTE1860 | 819 | 18 | 60 | 2.875 | 31.28 | 1.80 |
| EVPGTE2418 | 459 | 24 | 18 | 2.875 | 14.12 | 0.75 |
| EVPGTE2424 | 473 | 24 | 24 | 2.875 | 17.56 | 1.00 |
| EVPGTE2430 | 505 | 24 | 30 | 2.875 | 20.90 | 1.25 |
| EVPGTE2436 | 551 | 24 | 36 | 2.875 | 24.20 | 1.50 |
| EVPGTE2442 | 627 | 24 | 42 | 2.875 | 27.42 | 1.75 |
| EVPGTE2448 | 701 | 24 | 48 | 2.875 | 30.52 | 2.00 |
| EVPGTE2454 | 762 | 24 | 54 | 2.875 | 33.54 | 2.25 |
| EVPGTE2460 | 819 | 24 | 60 | 2.875 | 36.80 | 2.50 |

EVPGPTE • Tempered Glass Premium Panel Extension Module

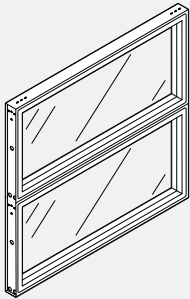

- Two 12" high glazed modules are incorporated into one 24" high metal frame.
- When ordering Panel Extension Module, additional connectors are required.

| PRODUCT CODE | PRICE | SIZE/ INCHES | | | WEIGHT LBS | VOL FT ³ |
|--------------|-------|--------------|----|-------|------------|---------------------|
| | | H | W | D | | |
| EVPGPTE2418 | 452 | 24 | 18 | 2.875 | 18.82 | 1.02 |
| EVPGPTE2424 | 503 | 24 | 24 | 2.875 | 22.96 | 1.42 |
| EVPGPTE2430 | 573 | 24 | 30 | 2.875 | 26.99 | 1.42 |
| EVPGPTE2436 | 655 | 24 | 36 | 2.875 | 31.04 | 1.54 |
| EVPGPTE2442 | 726 | 24 | 42 | 2.875 | 35.12 | 1.72 |
| EVPGPTE2448 | 816 | 24 | 48 | 2.875 | 39.99 | 2.73 |
| EVPGPTE2454 | 888 | 24 | 54 | 2.875 | 43.95 | 3.06 |
| EVPGPTE2460 | 962 | 24 | 60 | 2.875 | 48.40 | 3.39 |

EVPH1SE • Laminate Extension Module - One Side

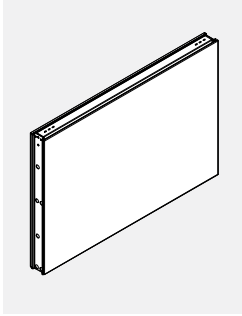

- Laminate face on one side of the module provides durable, washable surfaces. Opposite side is fabric.
- When ordering Panel Extension Module, additional connectors are required.

| PRODUCT CODE | PRICE | | SIZE/ INCHES | | | WEIGHT | | VOL FT ³ |
|--------------|-------|------|--------------|----|-------|--------|------|---------------------|
| | GR 1 | GR 2 | H | W | D | LBS | | |
| EVPH1SE0618 | 212 | 217 | 6 | 18 | 2.875 | 2.77 | 0.25 | |
| EVPH1SE0624 | 247 | 259 | 6 | 24 | 2.875 | 3.20 | 0.35 | |
| EVPH1SE0630 | 280 | 284 | 6 | 30 | 2.875 | 3.63 | 0.43 | |
| EVPH1SE0636 | 319 | 327 | 6 | 36 | 2.875 | 4.06 | 0.51 | |
| EVPH1SE0642 | 361 | 367 | 6 | 42 | 2.875 | 4.49 | 0.60 | |
| EVPH1SE0648 | 394 | 404 | 6 | 48 | 2.875 | 4.91 | 0.68 | |
| EVPH1SE0654 | 446 | 454 | 6 | 54 | 2.875 | 5.34 | 0.76 | |
| EVPH1SE0660 | 469 | 477 | 6 | 60 | 2.875 | 5.77 | 0.84 | |
| EVPH1SE1218 | 212 | 217 | 12 | 18 | 2.875 | 5.55 | 0.51 | |
| EVPH1SE1224 | 247 | 259 | 12 | 24 | 2.875 | 6.41 | 0.71 | |
| EVPH1SE1230 | 280 | 284 | 12 | 30 | 2.875 | 7.26 | 0.87 | |
| EVPH1SE1236 | 319 | 327 | 12 | 36 | 2.875 | 8.12 | 1.03 | |
| EVPH1SE1242 | 361 | 367 | 12 | 42 | 2.875 | 8.98 | 1.20 | |
| EVPH1SE1248 | 394 | 404 | 12 | 48 | 2.875 | 9.83 | 1.36 | |
| EVPH1SE1254 | 446 | 454 | 12 | 54 | 2.875 | 10.69 | 1.53 | |
| EVPH1SE1260 | 469 | 477 | 12 | 60 | 2.875 | 11.55 | 1.69 | |
| EVPH1SE1818 | 276 | 281 | 18 | 18 | 2.875 | 9.44 | 0.54 | |
| EVPH1SE1824 | 340 | 347 | 18 | 24 | 2.875 | 10.90 | 0.72 | |
| EVPH1SE1830 | 391 | 401 | 18 | 30 | 2.875 | 12.35 | 0.90 | |
| EVPH1SE1836 | 448 | 457 | 18 | 36 | 2.875 | 13.81 | 1.08 | |
| EVPH1SE1842 | 505 | 518 | 18 | 42 | 2.875 | 15.27 | 1.26 | |
| EVPH1SE1848 | 553 | 570 | 18 | 48 | 2.875 | 16.72 | 1.44 | |
| EVPH1SE1854 | 602 | 619 | 18 | 54 | 2.875 | 18.18 | 1.62 | |
| EVPH1SE1860 | 660 | 687 | 18 | 60 | 2.875 | 19.64 | 1.80 | |
| EVPH1SE2418 | 286 | 293 | 24 | 18 | 2.875 | 11.10 | 1.02 | |
| EVPH1SE2424 | 340 | 349 | 24 | 24 | 2.875 | 12.82 | 1.42 | |
| EVPH1SE2430 | 391 | 404 | 24 | 30 | 2.875 | 14.53 | 1.75 | |
| EVPH1SE2436 | 448 | 457 | 24 | 36 | 2.875 | 16.25 | 2.07 | |
| EVPH1SE2442 | 505 | 517 | 24 | 42 | 2.875 | 17.96 | 2.40 | |
| EVPH1SE2448 | 553 | 570 | 24 | 48 | 2.875 | 19.67 | 2.73 | |
| EVPH1SE2454 | 602 | 615 | 24 | 54 | 2.875 | 21.39 | 3.06 | |
| EVPH1SE2460 | 660 | 682 | 24 | 60 | 2.875 | 23.10 | 3.39 | |

EVPH2SE • Laminate Extension Module - Two Sides

- Laminate face on both sides of the module provides durable, washable surfaces.
- When ordering Panel Extension Module, additional connectors are required.

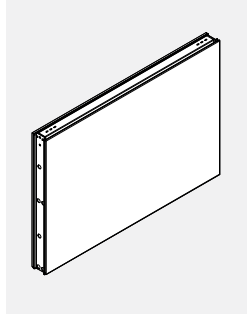

| PRODUCT CODE | PRICE | SIZE/ INCHES | | | WEIGHT LBS | VOL FT ³ |
|--------------|-------|--------------|----|-------|------------|---------------------|
| | | H | W | D | | |
| EVPH2SE0618 | 234 | 6 | 18 | 2.875 | 3.03 | 0.26 |
| EVPH2SE0624 | 274 | 6 | 24 | 2.875 | 3.46 | 0.36 |
| EVPH2SE0630 | 318 | 6 | 30 | 2.875 | 3.89 | 0.44 |
| EVPH2SE0636 | 364 | 6 | 36 | 2.875 | 4.32 | 0.52 |
| EVPH2SE0642 | 410 | 6 | 42 | 2.875 | 4.74 | 0.60 |
| EVPH2SE0648 | 460 | 6 | 48 | 2.875 | 5.17 | 0.69 |
| EVPH2SE0654 | 535 | 6 | 54 | 2.875 | 5.60 | 0.77 |
| EVPH2SE0660 | 544 | 6 | 60 | 2.875 | 6.03 | 0.85 |
| EVPH2SE1218 | 234 | 12 | 18 | 2.875 | 6.05 | 0.51 |
| EVPH2SE1224 | 274 | 12 | 24 | 2.875 | 6.91 | 0.71 |
| EVPH2SE1230 | 318 | 12 | 30 | 2.875 | 7.77 | 0.88 |
| EVPH2SE1236 | 364 | 12 | 36 | 2.875 | 8.63 | 1.04 |
| EVPH2SE1242 | 410 | 12 | 42 | 2.875 | 9.48 | 1.20 |
| EVPH2SE1248 | 460 | 12 | 48 | 2.875 | 10.34 | 1.37 |
| EVPH2SE1254 | 535 | 12 | 54 | 2.875 | 11.20 | 1.53 |
| EVPH2SE1260 | 544 | 12 | 60 | 2.875 | 12.05 | 1.70 |
| EVPH2SE1818 | 329 | 18 | 18 | 2.875 | 10.29 | 0.54 |
| EVPH2SE1824 | 404 | 18 | 24 | 2.875 | 11.75 | 0.72 |
| EVPH2SE1830 | 469 | 18 | 30 | 2.875 | 13.20 | 0.90 |
| EVPH2SE1836 | 542 | 18 | 36 | 2.875 | 14.66 | 1.08 |
| EVPH2SE1842 | 614 | 18 | 42 | 2.875 | 16.12 | 1.26 |
| EVPH2SE1848 | 694 | 18 | 48 | 2.875 | 17.57 | 1.44 |
| EVPH2SE1854 | 762 | 18 | 54 | 2.875 | 19.03 | 1.62 |
| EVPH2SE1860 | 823 | 18 | 60 | 2.875 | 20.49 | 1.80 |
| EVPH2SE2418 | 329 | 24 | 18 | 2.875 | 12.10 | 1.02 |
| EVPH2SE2424 | 404 | 24 | 24 | 2.875 | 13.82 | 1.42 |
| EVPH2SE2430 | 469 | 24 | 30 | 2.875 | 15.53 | 1.75 |
| EVPH2SE2436 | 542 | 24 | 36 | 2.875 | 17.25 | 2.07 |
| EVPH2SE2442 | 614 | 24 | 42 | 2.875 | 18.96 | 2.40 |
| EVPH2SE2448 | 694 | 24 | 48 | 2.875 | 20.67 | 2.73 |
| EVPH2SE2454 | 762 | 24 | 54 | 2.875 | 22.39 | 3.06 |
| EVPH2SE2460 | 823 | 24 | 60 | 2.875 | 24.10 | 3.39 |

EVPOE • Open Panel Extension Module

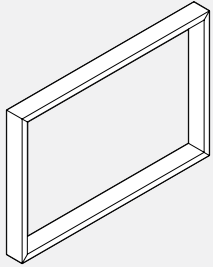

- Provides an opening within a run of panels at a desired location.
- When ordering Panel Extension Module, additional connectors are required.

| PRODUCT CODE | PRICE | SIZE/ INCHES | | | WEIGHT LBS | VOL FT ³ |
|--------------|-------|--------------|----|-------|------------|---------------------|
| | | H | W | D | | |
| EVPOE0618 | 246 | 6 | 18 | 2.875 | 6.22 | 0.26 |
| EVPOE0624 | 252 | 6 | 24 | 2.875 | 7.40 | 0.29 |
| EVPOE0630 | 307 | 6 | 30 | 2.875 | 8.48 | 0.36 |
| EVPOE0636 | 323 | 6 | 36 | 2.875 | 9.56 | 0.43 |
| EVPOE0642 | 392 | 6 | 42 | 2.875 | 10.88 | 0.51 |
| EVPOE0648 | 442 | 6 | 48 | 2.875 | 12.12 | 0.58 |
| EVPOE0654 | 483 | 6 | 54 | 2.875 | 13.25 | 0.65 |
| EVPOE0660 | 520 | 6 | 60 | 2.875 | 14.68 | 0.73 |
| EVPOE1218 | 246 | 12 | 18 | 2.875 | 7.30 | 0.51 |
| EVPOE1224 | 252 | 12 | 24 | 2.875 | 8.40 | 0.59 |
| EVPOE1230 | 307 | 12 | 30 | 2.875 | 9.50 | 0.82 |
| EVPOE1236 | 323 | 12 | 36 | 2.875 | 10.60 | 1.00 |
| EVPOE1242 | 392 | 12 | 42 | 2.875 | 11.84 | 1.00 |
| EVPOE1248 | 442 | 12 | 48 | 2.875 | 13.20 | 1.18 |
| EVPOE1254 | 483 | 12 | 54 | 2.875 | 14.38 | 1.25 |
| EVPOE1260 | 520 | 12 | 60 | 2.875 | 15.80 | 1.32 |
| EVPOE1818 | 329 | 18 | 18 | 2.875 | 7.74 | 0.54 |
| EVPOE1824 | 369 | 18 | 24 | 2.875 | 9.18 | 0.72 |
| EVPOE1830 | 392 | 18 | 30 | 2.875 | 10.53 | 0.90 |
| EVPOE1836 | 431 | 18 | 36 | 2.875 | 11.88 | 1.08 |
| EVPOE1842 | 485 | 18 | 42 | 2.875 | 13.09 | 1.26 |
| EVPOE1848 | 546 | 18 | 48 | 2.875 | 14.22 | 1.44 |
| EVPOE1854 | 592 | 18 | 54 | 2.875 | 15.28 | 1.62 |
| EVPOE1860 | 638 | 18 | 60 | 2.875 | 16.56 | 1.80 |
| EVPOE2418 | 329 | 24 | 18 | 2.875 | 8.60 | 1.02 |
| EVPOE2424 | 369 | 24 | 24 | 2.875 | 10.20 | 1.42 |
| EVPOE2430 | 392 | 24 | 30 | 2.875 | 11.70 | 1.75 |
| EVPOE2436 | 431 | 24 | 36 | 2.875 | 13.20 | 1.95 |
| EVPOE2442 | 485 | 24 | 42 | 2.875 | 14.54 | 2.40 |
| EVPOE2448 | 546 | 24 | 48 | 2.875 | 15.80 | 2.73 |
| EVPOE2454 | 592 | 24 | 54 | 2.875 | 16.98 | 3.06 |
| EVPOE2460 | 638 | 24 | 60 | 2.875 | 18.40 | 3.39 |

EVPAE • Air Flow Extension Module

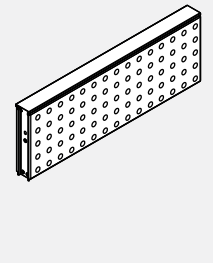

- Metal Air Flow Panel Extension
- Attaches to top of panel
- Panel Extension Modules are not load bearing above 66"
- When ordering Panel Extension Module, additional connectors are required.

| PRODUCT CODE | PRICE | SIZE/ INCHES | | | WEIGHT LBS | VOL FT ³ |
|--------------|-------|--------------|----|-------|------------|---------------------|
| | | H | W | D | | |
| EVPAE1224 | 270 | 12 | 24 | 2.875 | 9.66 | 0.59 |
| EVPAE1230 | 318 | 12 | 30 | 2.875 | 10.93 | 0.82 |
| EVPAE1236 | 363 | 12 | 36 | 2.875 | 12.19 | 1.00 |
| EVPAE1242 | 401 | 12 | 42 | 2.875 | 13.62 | 1.05 |
| EVPAE1248 | 452 | 12 | 48 | 2.875 | 15.18 | 1.18 |
| EVPAE1260 | 596 | 12 | 60 | 2.875 | 18.17 | 1.32 |
| EVPAE1824 | 339 | 18 | 24 | 2.875 | 10.56 | 0.72 |
| EVPAE1830 | 394 | 18 | 30 | 2.875 | 12.11 | 0.90 |
| EVPAE1836 | 435 | 18 | 36 | 2.875 | 13.66 | 1.08 |
| EVPAE1842 | 478 | 18 | 42 | 2.875 | 15.05 | 1.26 |
| EVPAE1848 | 547 | 18 | 48 | 2.875 | 16.35 | 1.44 |
| EVPAE1860 | 711 | 18 | 60 | 2.875 | 19.04 | 1.80 |
| EVPAE2424 | 339 | 24 | 24 | 2.875 | 11.73 | 1.42 |
| EVPAE2430 | 394 | 24 | 30 | 2.875 | 13.46 | 1.75 |
| EVPAE2436 | 435 | 24 | 36 | 2.875 | 15.18 | 1.95 |
| EVPAE2442 | 478 | 24 | 42 | 2.875 | 16.72 | 2.40 |
| EVPAE2448 | 547 | 24 | 48 | 2.875 | 18.17 | 2.73 |
| EVPAE2460 | 711 | 24 | 60 | 2.875 | 21.16 | 3.39 |

EVPSGE - Pass Thru Sliding Tempered Glass Extension Module

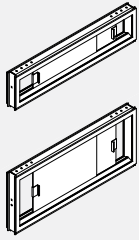

- Pass thru module with sliding tempered glass door.
- Attaches on top of a panel.
- Module can be stacked to add privacy or divide space.
- Panel extension module is not load bearing if installed higher than 66" High.
- When ordering panel extension modules, additional connectors are required.

| PRODUCT CODE | PRICE | | SIZE/ INCHES | | | WEIGHT LBS | VOL FT ³ |
|--------------|-------|--|--------------|----|-------|------------|---------------------|
| | CLR | | H | W | D | | |
| EVPSGE0636 | 297 | | 6 | 36 | 2.875 | 12.32 | 0.37 |
| EVPSGE0642 | 316 | | 6 | 42 | 2.875 | 14.1 | 0.43 |
| EVPSGE0648 | 384 | | 6 | 48 | 2.875 | 15.8 | 0.5 |
| EVPSGE1236 | 357 | | 12 | 36 | 2.875 | 16.12 | 0.75 |
| EVPSGE1242 | 378 | | 12 | 42 | 2.875 | 18.24 | 0.88 |
| EVPSGE1248 | 398 | | 12 | 48 | 2.875 | 20.56 | 1 |

EVPSGXE - Talk Thru Tempered Glass Extension Module

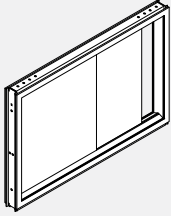

- Talk thru tempered glass module.
- Attaches on top of a panel.
- Module can be stacked to add privacy or divide space.
- Panel extension module is not load bearing if installed higher than 66" High.
- When ordering panel extension modules , additional connectors are required.

| PRODUCT CODE | PRICE | | SIZE/ INCHES | | | WEIGHT LBS | VOL FT ³ |
|--------------|-------|--|--------------|----|-------|------------|---------------------|
| | CLR | | H | W | D | | |
| EVPSGXE2436 | 460 | | 24 | 36 | 2.875 | 24.2 | 1.25 |
| EVPSGXE2442 | 509 | | 24 | 42 | 2.875 | 27.42 | 1.75 |
| EVPSGXE2448 | 553 | | 24 | 48 | 2.875 | 30.52 | 2 |
| EVPSGXE3036 | 503 | | 30 | 36 | 2.875 | 28.1 | 1.87 |
| EVPSGXE3042 | 567 | | 30 | 42 | 2.875 | 31.56 | 2.2 |
| EVPSGXE3048 | 613 | | 30 | 48 | 2.875 | 35.28 | 2.5 |

EVPFEB • Fabric Panel Bridge Module

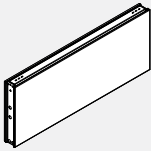

- Bridge modules connects two panels above an opening.
- Requires bridge extension connectors and connects with clamps on top and at bottom.
- Aluminum trim for bottom to be ordered separately.

| PRODUCT CODE | PRICE | | SIZE/INCHES | | | WEIGHT LBS | VOL FT ³ |
|--------------|-------|-----|-------------|----|------|------------|---------------------|
| | GR1 | GR2 | H | W | D | | |
| EVPFEB0618 | 153 | 160 | 6 | 18 | 2.88 | 4.80 | 0.21 |
| EVPFEB0624 | 159 | 169 | 6 | 24 | 2.88 | 6.40 | 0.29 |
| EVPFEB0630 | 174 | 183 | 6 | 30 | 2.88 | 7.40 | 0.36 |
| EVPFEB0636 | 195 | 207 | 6 | 36 | 2.88 | 8.20 | 0.43 |
| EVPFEB0642 | 217 | 233 | 6 | 42 | 2.88 | 9.40 | 0.51 |
| EVPFEB0648 | 235 | 248 | 6 | 48 | 2.88 | 10.20 | 0.58 |
| EVPFEB0654 | 253 | 271 | 6 | 54 | 2.88 | 14.40 | 0.65 |
| EVPFEB0660 | 276 | 295 | 6 | 60 | 2.88 | 16.00 | 0.73 |
| EVPFEB1218 | 153 | 160 | 12 | 18 | 2.88 | 7.40 | 0.38 |
| EVPFEB1224 | 159 | 168 | 12 | 24 | 2.88 | 8.60 | 0.50 |
| EVPFEB1230 | 174 | 183 | 12 | 30 | 2.88 | 9.60 | 0.63 |
| EVPFEB1236 | 195 | 207 | 12 | 36 | 2.88 | 12.80 | 0.75 |
| EVPFEB1242 | 217 | 231 | 12 | 42 | 2.88 | 14.80 | 0.88 |
| EVPFEB1248 | 235 | 248 | 12 | 48 | 2.88 | 15.00 | 1.00 |
| EVPFEB1254 | 253 | 271 | 12 | 54 | 2.88 | 16.20 | 1.12 |
| EVPFEB1260 | 276 | 295 | 12 | 60 | 2.88 | 17.80 | 1.25 |
| EVPFEB1818 | 190 | 201 | 18 | 18 | 2.88 | 9.01 | 0.54 |
| EVPFEB1824 | 197 | 211 | 18 | 24 | 2.88 | 10.47 | 0.72 |
| EVPFEB1830 | 212 | 234 | 18 | 30 | 2.88 | 11.93 | 0.90 |
| EVPFEB1836 | 246 | 268 | 18 | 36 | 2.88 | 13.39 | 1.08 |
| EVPFEB1842 | 274 | 301 | 18 | 42 | 2.88 | 14.84 | 1.26 |
| EVPFEB1848 | 298 | 328 | 18 | 48 | 2.88 | 16.29 | 1.44 |
| EVPFEB1854 | 324 | 355 | 18 | 54 | 2.88 | 17.76 | 1.62 |
| EVPFEB1860 | 352 | 382 | 18 | 60 | 2.88 | 19.21 | 1.80 |
| EVPFEB2418 | 190 | 201 | 24 | 18 | 2.88 | 10.60 | 0.75 |
| EVPFEB2424 | 197 | 212 | 24 | 24 | 2.88 | 12.32 | 1.00 |
| EVPFEB2430 | 212 | 234 | 24 | 30 | 2.88 | 14.03 | 1.25 |
| EVPFEB2436 | 246 | 268 | 24 | 36 | 2.88 | 15.75 | 1.50 |
| EVPFEB2442 | 274 | 301 | 24 | 42 | 2.88 | 17.46 | 1.75 |
| EVPFEB2448 | 298 | 328 | 24 | 48 | 2.88 | 19.17 | 2.00 |
| EVPFEB2454 | 324 | 355 | 24 | 54 | 2.88 | 20.89 | 2.25 |
| EVPFEB2460 | 352 | 391 | 24 | 60 | 2.88 | 22.60 | 2.50 |

EVPGTB • Tempered Glass Bridge Module

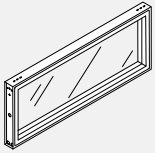

- Bridge modules connects two panels above an opening.
- Requires bridge extension connectors and connects with clamps at bottom.
- Standard in clear (CLR).
- Frosted glass available with a 40% upcharge.
- When ordering bridge modules, additional bridge connectors are required.
- Aluminum trim for bottom to be ordered separately.

| PRODUCT CODE | PRICE | SIZE/INCHES | | | WEIGHT LBS | VOL FT³ |
|--------------|-------|-------------|----|---|------------|---------|
| | | H | W | D | | |
| EVPGTB0618 | 263 | 6 | 18 | 3 | 7.60 | 0.18 |
| EVPGTB0624 | 281 | 6 | 24 | 3 | 9.24 | 0.25 |
| EVPGTB0630 | 342 | 6 | 30 | 3 | 10.78 | 0.31 |
| EVPGTB0636 | 355 | 6 | 36 | 3 | 12.32 | 0.37 |
| EVPGTB0642 | 437 | 6 | 42 | 3 | 14.10 | 0.43 |
| EVPGTB0648 | 488 | 6 | 48 | 3 | 15.80 | 0.50 |
| EVPGTB0654 | 535 | 6 | 54 | 3 | 17.42 | 0.56 |
| EVPGTB0660 | 574 | 6 | 60 | 3 | 19.28 | 0.63 |
| EVPGTB1218 | 263 | 12 | 18 | 3 | 10.06 | 0.38 |
| EVPGTB1224 | 281 | 12 | 24 | 3 | 12.08 | 0.50 |
| EVPGTB1230 | 342 | 12 | 30 | 3 | 14.10 | 0.63 |
| EVPGTB1236 | 355 | 12 | 36 | 3 | 16.12 | 0.75 |
| EVPGTB1242 | 437 | 12 | 42 | 3 | 18.24 | 0.88 |
| EVPGTB1248 | 488 | 12 | 48 | 3 | 20.56 | 1.00 |
| EVPGTB1254 | 535 | 12 | 54 | 3 | 22.66 | 1.12 |
| EVPGTB1260 | 574 | 12 | 60 | 3 | 25.00 | 1.25 |
| EVPGTB1818 | 396 | 18 | 18 | 3 | 12.00 | 0.54 |
| EVPGTB1824 | 407 | 18 | 24 | 3 | 14.93 | 0.72 |
| EVPGTB1830 | 435 | 18 | 30 | 3 | 17.77 | 0.90 |
| EVPGTB1836 | 475 | 18 | 36 | 3 | 20.57 | 1.08 |
| EVPGTB1842 | 541 | 18 | 42 | 3 | 23.31 | 1.26 |
| EVPGTB1848 | 605 | 18 | 48 | 3 | 25.94 | 1.44 |
| EVPGTB1854 | 657 | 18 | 54 | 3 | 28.51 | 1.62 |
| EVPGTB1860 | 706 | 18 | 60 | 3 | 31.28 | 1.80 |
| EVPGTB2418 | 396 | 24 | 18 | 3 | 14.12 | 0.75 |
| EVPGTB2424 | 407 | 24 | 24 | 3 | 17.56 | 1.00 |
| EVPGTB2430 | 435 | 24 | 30 | 3 | 20.90 | 1.25 |
| EVPGTB2436 | 475 | 24 | 36 | 3 | 24.20 | 1.50 |
| EVPGTB2442 | 541 | 24 | 42 | 3 | 27.42 | 1.75 |
| EVPGTB2448 | 605 | 24 | 48 | 3 | 30.52 | 2.00 |
| EVPGTB2454 | 657 | 24 | 54 | 3 | 33.54 | 2.25 |
| EVPGTB2460 | 706 | 24 | 60 | 3 | 36.80 | 2.50 |

EVPH1SEB • Laminate Bridge Module - Single Sided

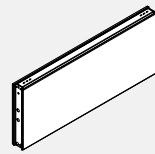

- Bridge modules connects two panels above an opening.
- Requires bridge extension connectors and connects with clamps at bottom.
- Laminate face on one side of module provides durable, washable surface.
- Panel extension module is not load bearing if installed higher than 66" high.
- When ordering bridge modules, additional bridge connectors are required.
- Aluminum trim for bottom to be ordered separately.

| PRODUCT CODE | PRICE | | SIZE/INCHES | | | WEIGHT LBS | VOL FT³ |
|--------------|-------|-----|-------------|----|---|------------|---------|
| | GR1 | GR2 | H | W | D | | |
| EVPH1SEB0618 | 182 | 187 | 6 | 18 | 3 | 2.77 | 0.25 |
| EVPH1SEB0624 | 213 | 221 | 6 | 24 | 3 | 3.20 | 0.35 |
| EVPH1SEB0630 | 242 | 245 | 6 | 30 | 3 | 3.63 | 0.43 |
| EVPH1SEB0636 | 276 | 280 | 6 | 36 | 3 | 4.06 | 0.51 |
| EVPH1SEB0642 | 310 | 316 | 6 | 42 | 3 | 4.49 | 0.60 |
| EVPH1SEB0648 | 339 | 346 | 6 | 48 | 3 | 4.91 | 0.68 |
| EVPH1SEB0654 | 384 | 391 | 6 | 54 | 3 | 5.34 | 0.76 |
| EVPH1SEB0660 | 403 | 411 | 6 | 60 | 3 | 5.77 | 0.84 |
| EVPH1SEB1218 | 182 | 187 | 12 | 18 | 3 | 5.55 | 0.51 |
| EVPH1SEB1224 | 213 | 221 | 12 | 24 | 3 | 6.41 | 0.71 |
| EVPH1SEB1230 | 242 | 245 | 12 | 30 | 3 | 7.26 | 0.87 |
| EVPH1SEB1236 | 276 | 280 | 12 | 36 | 3 | 8.12 | 1.03 |
| EVPH1SEB1242 | 310 | 316 | 12 | 42 | 3 | 8.98 | 1.20 |
| EVPH1SEB1248 | 339 | 346 | 12 | 48 | 3 | 9.83 | 1.36 |
| EVPH1SEB1254 | 384 | 391 | 12 | 54 | 3 | 10.69 | 1.53 |
| EVPH1SEB1260 | 403 | 411 | 12 | 60 | 3 | 11.55 | 1.69 |
| EVPH1SEB1818 | 238 | 243 | 18 | 18 | 3 | 9.44 | 0.54 |
| EVPH1SEB1824 | 293 | 300 | 18 | 24 | 3 | 10.90 | 0.72 |
| EVPH1SEB1830 | 337 | 345 | 18 | 30 | 3 | 12.35 | 0.90 |
| EVPH1SEB1836 | 385 | 394 | 18 | 36 | 3 | 13.81 | 1.08 |
| EVPH1SEB1842 | 435 | 447 | 18 | 42 | 3 | 15.27 | 1.26 |
| EVPH1SEB1848 | 477 | 491 | 18 | 48 | 3 | 16.72 | 1.44 |
| EVPH1SEB1854 | 517 | 534 | 18 | 54 | 3 | 18.18 | 1.62 |
| EVPH1SEB1860 | 571 | 591 | 18 | 60 | 3 | 19.64 | 1.80 |
| EVPH1SEB2418 | 238 | 243 | 24 | 18 | 3 | 11.10 | 1.02 |
| EVPH1SEB2424 | 293 | 300 | 24 | 24 | 3 | 12.82 | 1.42 |
| EVPH1SEB2430 | 337 | 345 | 24 | 30 | 3 | 14.53 | 1.75 |
| EVPH1SEB2436 | 385 | 394 | 24 | 36 | 3 | 16.25 | 2.07 |
| EVPH1SEB2442 | 435 | 447 | 24 | 42 | 3 | 17.96 | 2.40 |
| EVPH1SEB2448 | 477 | 491 | 24 | 48 | 3 | 19.67 | 2.73 |
| EVPH1SEB2454 | 517 | 534 | 24 | 54 | 3 | 21.39 | 3.06 |
| EVPH1SEB2460 | 571 | 591 | 24 | 60 | 3 | 23.10 | 3.39 |

EVPH2SEB • Laminate Bridge Module - Double Sided

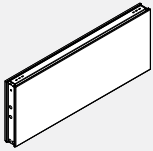

- Bridge modules connects two panels above an opening.
- Requires bridge extension connectors and connects with clamps at bottom.
- Laminate face on two sides of module provides durable, washable surface.
- Panel extension module is not load bearing if installed higher than 66" high.
- When ordering panel extension modules, additional connectors are required.
- Aluminum trim for bottom to be ordered separately.

| PRODUCT CODE | PRICE | SIZE/INCHES | | | WEIGHT LBS | VOL FT ³ |
|--------------|-------|-------------|----|---|------------|---------------------|
| | | H | W | D | | |
| EVPH2SEB0618 | 200 | 6 | 18 | 3 | 3.03 | 0.26 |
| EVPH2SEB0624 | 236 | 6 | 24 | 3 | 3.46 | 0.36 |
| EVPH2SEB0630 | 275 | 6 | 30 | 3 | 3.89 | 0.44 |
| EVPH2SEB0636 | 312 | 6 | 36 | 3 | 4.32 | 0.52 |
| EVPH2SEB0642 | 353 | 6 | 42 | 3 | 4.74 | 0.60 |
| EVPH2SEB0648 | 398 | 6 | 48 | 3 | 5.17 | 0.69 |
| EVPH2SEB0654 | 459 | 6 | 54 | 3 | 5.60 | 0.77 |
| EVPH2SEB0660 | 469 | 6 | 60 | 3 | 6.03 | 0.85 |
| EVPH2SEB1218 | 200 | 12 | 18 | 3 | 6.05 | 0.51 |
| EVPH2SEB1224 | 236 | 12 | 24 | 3 | 6.91 | 0.71 |
| EVPH2SEB1230 | 275 | 12 | 30 | 3 | 7.77 | 0.88 |
| EVPH2SEB1236 | 312 | 12 | 36 | 3 | 8.63 | 1.04 |
| EVPH2SEB1242 | 353 | 12 | 42 | 3 | 9.48 | 1.20 |
| EVPH2SEB1248 | 398 | 12 | 48 | 3 | 10.34 | 1.37 |
| EVPH2SEB1254 | 459 | 12 | 54 | 3 | 11.20 | 1.53 |
| EVPH2SEB1260 | 469 | 12 | 60 | 3 | 12.05 | 1.70 |
| EVPH2SEB1818 | 283 | 18 | 18 | 3 | 10.29 | 0.54 |
| EVPH2SEB1824 | 346 | 18 | 24 | 3 | 11.75 | 0.72 |
| EVPH2SEB1830 | 403 | 18 | 30 | 3 | 13.20 | 0.90 |
| EVPH2SEB1836 | 467 | 18 | 36 | 3 | 14.66 | 1.08 |
| EVPH2SEB1842 | 529 | 18 | 42 | 3 | 16.12 | 1.26 |
| EVPH2SEB1848 | 598 | 18 | 48 | 3 | 17.57 | 1.44 |
| EVPH2SEB1854 | 657 | 18 | 54 | 3 | 19.03 | 1.62 |
| EVPH2SEB1860 | 709 | 18 | 60 | 3 | 20.49 | 1.80 |
| EVPH2SEB2418 | 283 | 24 | 18 | 3 | 12.10 | 1.02 |
| EVPH2SEB2424 | 346 | 24 | 24 | 3 | 13.82 | 1.42 |
| EVPH2SEB2430 | 403 | 24 | 30 | 3 | 15.53 | 1.75 |
| EVPH2SEB2436 | 467 | 24 | 36 | 3 | 17.25 | 2.07 |
| EVPH2SEB2442 | 529 | 24 | 42 | 3 | 18.96 | 2.40 |
| EVPH2SEB2448 | 598 | 24 | 48 | 3 | 20.67 | 2.73 |
| EVPH2SEB2454 | 657 | 24 | 54 | 3 | 22.39 | 3.06 |
| EVPH2SEB2460 | 709 | 24 | 60 | 3 | 24.10 | 3.39 |

EVPMP-GI-P • Panel Mount Privacy Glass for U Channel, Extended at Both Ends

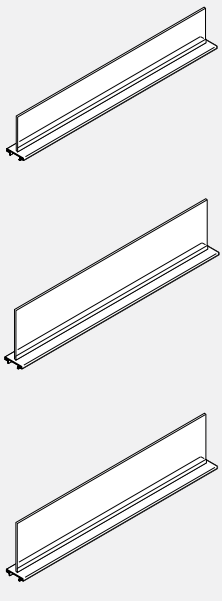

- Privacy Glass integrated with aluminum top trim.
- Attaches on top of panels to add privacy or divide space
- Includes aluminum trim with channel and glass tile.
- Standard in clear (CLR), frosted (FRST) or writeable (WRW) glass.
- Aluminum trim must be specified for entire station when ordering panel mount privacy glass.
- Glass and attachment hardware ship seperately.

| PRODUCT CODE | PRICE | | | SIZE/ INCHES | | | WEIGHT LBS | VOL FT ³ |
|--------------|-------|------|-----|--------------|----|-------|------------|---------------------|
| | CLR | FRST | WRW | H | W | D | | |
| EVPMP24GI6P | 201 | 251 | - | 6 | 24 | 2.875 | 2.39 | 0.25 |
| EVPMP30GI6P | 219 | 276 | - | 6 | 30 | 2.875 | 2.99 | 0.32 |
| EVPMP36GI6P | 235 | 291 | - | 6 | 36 | 2.875 | 3.58 | 0.37 |
| EVPMP42GI6P | 251 | 313 | - | 6 | 42 | 2.875 | 4.18 | 0.43 |
| EVPMP48GI6P | 262 | 327 | - | 6 | 48 | 2.875 | 4.78 | 0.50 |
| EVPMP54GI6P | 270 | 338 | - | 6 | 54 | 2.875 | 5.38 | 0.56 |
| EVPMP60GI6P | 276 | 343 | - | 6 | 60 | 2.875 | 5.97 | 0.63 |
| EVPMP66GI6P | 422 | 562 | - | 6 | 66 | 2.875 | 6.57 | 0.69 |
| EVPMP72GI6P | 450 | 587 | - | 6 | 72 | 2.875 | 7.16 | 0.76 |
| EVPMP24GI9P | 201 | 251 | - | 9 | 24 | 2.875 | 3.58 | 0.38 |
| EVPMP30GI9P | 219 | 276 | - | 9 | 30 | 2.875 | 4.48 | 0.47 |
| EVPMP36GI9P | 235 | 291 | - | 9 | 36 | 2.875 | 5.37 | 0.56 |
| EVPMP42GI9P | 251 | 313 | - | 9 | 42 | 2.875 | 6.26 | 0.65 |
| EVPMP48GI9P | 262 | 327 | - | 9 | 48 | 2.875 | 7.16 | 0.75 |
| EVPMP54GI9P | 270 | 338 | - | 9 | 54 | 2.875 | 8.06 | 0.84 |
| EVPMP60GI9P | 276 | 343 | - | 9 | 60 | 2.875 | 8.96 | 0.94 |
| EVPMP66GI9P | 422 | 562 | - | 9 | 66 | 2.875 | 9.85 | 1.04 |
| EVPMP72GI9P | 450 | 587 | - | 9 | 72 | 2.875 | 10.74 | 1.13 |
| EVPMP24GIP | 201 | 251 | 350 | 12 | 24 | 2.875 | 4.77 | 0.50 |
| EVPMP30GIP | 219 | 276 | 357 | 12 | 30 | 2.875 | 5.97 | 0.63 |
| EVPMP36GIP | 235 | 291 | 364 | 12 | 36 | 2.875 | 7.16 | 0.75 |
| EVPMP42GIP | 251 | 313 | 401 | 12 | 42 | 2.875 | 8.35 | 0.87 |
| EVPMP48GIP | 262 | 327 | 439 | 12 | 48 | 2.875 | 9.55 | 1.00 |
| EVPMP54GIP | 270 | 338 | 475 | 12 | 54 | 2.875 | 10.75 | 1.12 |
| EVPMP60GIP | 276 | 343 | 512 | 12 | 60 | 2.875 | 11.95 | 1.25 |
| EVPMP66GIP | 422 | 562 | 701 | 12 | 66 | 2.875 | 13.05 | 1.37 |
| EVPMP72GIP | 450 | 587 | 734 | 12 | 72 | 2.875 | 14.25 | 1.51 |

EVPMPN-GIP • 12" Integrated Panel Mounted Privacy Glass, 1 Notch

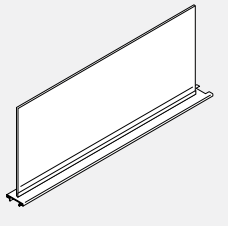

- Privacy Glass Integrated with aluminum top trim.
- Attaches on top of panels to add privacy or divide space.
- Includes aluminum top trim with channel with notched end and glass tile.
- Standard in clear (CLR) or frosted (FRST) glass
- Aluminum trim must be specified for entire station when ordering panel mount privacy glass.
- Glass and attachment hardware to ship separately.

| PRODUCT CODE | PRICE | | SIZE/ INCHES | | | WEIGHT LBS | VOL FT ³ |
|--------------|-------|------|--------------|----|-------|------------|---------------------|
| | CLR | FRST | H | W | D | | |
| EVPMPN24GIP | 201 | 251 | 12 | 24 | 2.875 | 4.77 | 0.50 |
| EVPMPN30GIP | 219 | 276 | 12 | 30 | 2.875 | 5.97 | 0.63 |
| EVPMPN36GIP | 235 | 291 | 12 | 36 | 2.875 | 7.16 | 0.75 |
| EVPMPN42GIP | 251 | 313 | 12 | 42 | 2.875 | 8.35 | 0.87 |
| EVPMPN48GIP | 262 | 327 | 12 | 48 | 2.875 | 9.55 | 1.00 |
| EVPMPN54GIP | 270 | 338 | 12 | 54 | 2.875 | 10.75 | 1.12 |
| EVPMPN60GIP | 276 | 343 | 12 | 60 | 2.875 | 11.95 | 1.25 |

EVPMPDN-GIP • 12" Integrated Panel Mounted Privacy Glass, 2 Notches

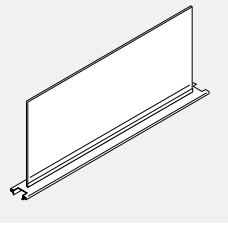

- Privacy Glass Integrated with aluminum top trim.
- Attaches on top of panels to add privacy or divide space.
- Includes aluminum top trim with channel with notched ends and glass tile.
- Standard in clear (CLR) or frosted (FRST) glass
- Aluminum trim must be specified for entire station when ordering panel mount privacy glass.
- Glass and attachment hardware to ship separately.

| PRODUCT CODE | PRICE | | SIZE/ INCHES | | | WEIGHT LBS | VOL FT ³ |
|--------------|-------|------|--------------|----|-------|------------|---------------------|
| | CLR | FRST | H | W | D | | |
| EVPMPDN24GIP | 201 | 251 | 12 | 24 | 2.875 | 4.77 | 0.50 |
| EVPMPDN30GIP | 219 | 276 | 12 | 30 | 2.875 | 5.97 | 0.63 |
| EVPMPDN36GIP | 235 | 291 | 12 | 36 | 2.875 | 7.16 | 0.75 |
| EVPMPDN42GIP | 251 | 313 | 12 | 42 | 2.875 | 8.35 | 0.87 |
| EVPMPDN48GIP | 262 | 327 | 12 | 48 | 2.875 | 9.55 | 1.00 |
| EVPMPDN54GIP | 270 | 338 | 12 | 54 | 2.875 | 10.75 | 1.12 |
| EVPMPDN60GIP | 276 | 343 | 12 | 60 | 2.875 | 11.95 | 1.25 |

EVPMP-GI-PDU • Panel Mount Privacy Glass for U Channel, Extended at Both Ends

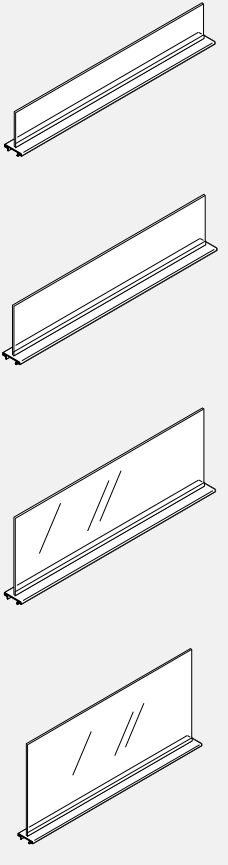

- Privacy glass integrated within aluminum top trim to be used with U channel, with connector for Gallery Panels.
- Attaches on top of panels to add privacy or divide space
- Includes aluminum trim with channel and glass tile
- Standard in clear (CLR) or frosted (FRST) glass
- Aluminum trim must be specified for entire station when ordering panel mount privacy glass.
- Glass and attachment hardware to ship separately
- Trim and glass extended for U channel from both ends.

| PRODUCT CODE | PRICE | | SIZE/ INCHES | | | WEIGHT LBS | VOL FT ³ |
|----------------|-------|------|--------------|-------|-------|------------|---------------------|
| | CLR | FRST | H | W | D | | |
| EVPMP24GI6PDU | 212 | 264 | 6 | 25.25 | 2.39 | 0.25 | |
| EVPMP30GI6PDU | 225 | 281 | 6 | 31.25 | 2.99 | 0.32 | |
| EVPMP36GI6PDU | 241 | 303 | 6 | 37.25 | 3.58 | 0.37 | |
| EVPMP42GI6PDU | 249 | 313 | 6 | 43.25 | 4.18 | 0.43 | |
| EVPMP48GI6PDU | 260 | 324 | 6 | 49.25 | 4.78 | 0.50 | |
| EVPMP54GI6PDU | 264 | 331 | 6 | 55.25 | 5.38 | 0.56 | |
| EVPMP60GI6PDU | 408 | 540 | 6 | 61.25 | 5.97 | 0.63 | |
| EVPMP66GI6PDU | 433 | 564 | 6 | 67.25 | 6.57 | 0.69 | |
| EVPMP72GI6PDU | 457 | 589 | 6 | 73.25 | 7.16 | 0.76 | |
| EVPMP24GI9PDU | 212 | 264 | 9 | 25.25 | 3.58 | 0.38 | |
| EVPMP30GI9PDU | 225 | 281 | 9 | 31.25 | 4.48 | 0.47 | |
| EVPMP36GI9PDU | 241 | 303 | 9 | 37.25 | 5.37 | 0.56 | |
| EVPMP42GI9PDU | 249 | 313 | 9 | 43.25 | 6.26 | 0.65 | |
| EVPMP48GI9PDU | 260 | 324 | 9 | 49.25 | 7.16 | 0.75 | |
| EVPMP54GI9PDU | 264 | 331 | 9 | 55.25 | 8.06 | 0.84 | |
| EVPMP60GI9PDU | 408 | 540 | 9 | 61.25 | 8.96 | 0.94 | |
| EVPMP66GI9PDU | 433 | 564 | 9 | 67.25 | 9.85 | 1.04 | |
| EVPMP72GI9PDU | 457 | 589 | 9 | 73.25 | 10.74 | 1.13 | |
| EVPMP24GIPDU | 212 | 264 | 12 | 25.25 | 4.77 | 0.50 | |
| EVPMP30GIPDU | 225 | 281 | 12 | 31.25 | 5.97 | 0.63 | |
| EVPMP36GIPDU | 241 | 303 | 12 | 37.25 | 7.16 | 0.75 | |
| EVPMP42GIPDU | 249 | 313 | 12 | 43.25 | 8.35 | 0.87 | |
| EVPMP48GIPDU | 260 | 324 | 12 | 49.25 | 9.55 | 1.00 | |
| EVPMP54GIPDU | 264 | 331 | 12 | 55.25 | 10.75 | 1.12 | |
| EVPMP60GIPDU | 408 | 540 | 12 | 61.25 | 11.94 | 1.25 | |
| EVPMP66GIPDU | 433 | 564 | 12 | 67.25 | 13.13 | 1.38 | |
| EVPMP72GIPDU | 457 | 589 | 12 | 73.25 | 14.32 | 1.51 | |
| EVPMP24GI18PDU | 392 | 450 | 18 | 25.25 | 7.16 | 0.75 | |
| EVPMP30GI18PDU | 418 | 457 | 18 | 31.25 | 8.96 | 0.94 | |
| EVPMP36GI18PDU | 435 | 505 | 18 | 37.25 | 10.74 | 1.13 | |
| EVPMP42GI18PDU | 461 | 551 | 18 | 43.25 | 12.53 | 1.31 | |
| EVPMP48GI18PDU | 478 | 596 | 18 | 49.25 | 14.33 | 1.50 | |
| EVPMP54GI18PDU | 494 | 645 | 18 | 55.25 | 16.13 | 1.69 | |
| EVPMP60GI18PDU | 553 | 733 | 18 | 61.25 | 17.91 | 1.88 | |
| EVPMP66GI18PDU | 587 | 766 | 18 | 67.25 | 19.70 | 2.06 | |
| EVPMP72GI18PDU | 621 | 800 | 18 | 73.25 | 21.48 | 2.25 | |

EVPMP-GI-PU • Panel Mount Privacy Glass for U Channel, Extended at One End

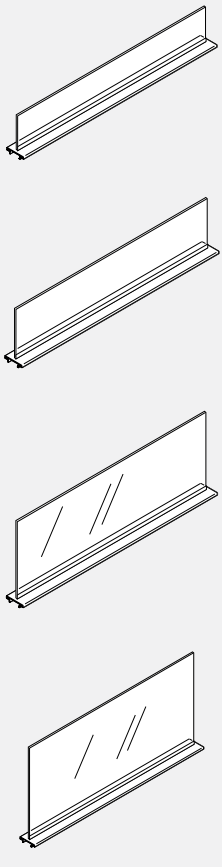

- Privacy glass integrated within aluminum top trim to be used with U channel, with connector for Gallery Panels.
- Attaches on top of panels to add privacy or divide space.
- Includes aluminum trim with channel and glass tile.
- Standard in clear (CLR) or frosted (FRST) glass.
- Aluminium trim must be specified for entire station when ordering panel mount privacy glass.
- Glass and attachment hardware to ship separately.
- Trim and glass extended for U channel on one end.

| PRODUCT CODE | PRICE | | SIZE/ H | INCHES | | WEIGHT VOL | |
|---------------|-------|------|---------|--------|---|------------|------|
| | CLR | FRST | | W | D | LBS | FT³ |
| EVPMP24GI6PU | 212 | 264 | 6 | 24.625 | | 2.39 | 0.25 |
| EVPMP30GI6PU | 225 | 281 | 6 | 30.625 | | 2.99 | 0.32 |
| EVPMP36GI6PU | 241 | 303 | 6 | 36.625 | | 3.58 | 0.37 |
| EVPMP42GI6PU | 249 | 313 | 6 | 42.625 | | 4.18 | 0.43 |
| EVPMP48GI6PU | 260 | 324 | 6 | 48.625 | | 4.78 | 0.50 |
| EVPMP54GI6PU | 264 | 331 | 6 | 54.625 | | 5.38 | 0.56 |
| EVPMP60GI6PU | 408 | 540 | 6 | 60.625 | | 5.97 | 0.63 |
| EVPMP66GI6PU | 433 | 564 | 6 | 66.625 | | 6.57 | 0.69 |
| EVPMP72GI6PU | 457 | 589 | 6 | 72.625 | | 7.16 | 0.76 |
| EVPMP24GI9PU | 212 | 264 | 9 | 24.625 | | 3.58 | 0.38 |
| EVPMP30GI9PU | 225 | 281 | 9 | 30.625 | | 4.48 | 0.47 |
| EVPMP36GI9PU | 241 | 303 | 9 | 36.625 | | 5.37 | 0.56 |
| EVPMP42GI9PU | 249 | 313 | 9 | 42.625 | | 6.26 | 0.65 |
| EVPMP48GI9PU | 260 | 324 | 9 | 48.625 | | 7.16 | 0.75 |
| EVPMP54GI9PU | 264 | 331 | 9 | 54.625 | | 8.06 | 0.84 |
| EVPMP60GI9PU | 408 | 540 | 9 | 60.625 | | 8.96 | 0.94 |
| EVPMP66GI9PU | 433 | 564 | 9 | 66.625 | | 9.85 | 1.04 |
| EVPMP72GI9PU | 457 | 589 | 9 | 72.625 | | 10.74 | 1.13 |
| EVPMP24GI18PU | 212 | 264 | 12 | 24.625 | | 4.77 | 0.50 |
| EVPMP30GI18PU | 225 | 281 | 12 | 30.625 | | 5.97 | 0.63 |
| EVPMP36GI18PU | 241 | 303 | 12 | 36.625 | | 7.16 | 0.75 |
| EVPMP42GI18PU | 249 | 313 | 12 | 42.625 | | 8.35 | 0.87 |
| EVPMP48GI18PU | 260 | 324 | 12 | 48.625 | | 9.55 | 1.00 |
| EVPMP54GI18PU | 264 | 331 | 12 | 54.625 | | 10.75 | 1.12 |
| EVPMP60GI18PU | 408 | 540 | 12 | 60.625 | | 11.94 | 1.25 |
| EVPMP66GI18PU | 433 | 564 | 12 | 66.625 | | 13.13 | 1.38 |
| EVPMP72GI18PU | 457 | 589 | 12 | 72.625 | | 14.32 | 1.51 |
| EVPMP24GI18PU | 392 | 450 | 18 | 24.625 | | 7.16 | 0.75 |
| EVPMP30GI18PU | 418 | 457 | 18 | 30.625 | | 8.96 | 0.94 |
| EVPMP36GI18PU | 435 | 505 | 18 | 36.625 | | 10.74 | 1.13 |
| EVPMP42GI18PU | 461 | 551 | 18 | 42.625 | | 12.53 | 1.31 |
| EVPMP48GI18PU | 478 | 596 | 18 | 48.625 | | 14.33 | 1.50 |
| EVPMP54GI18PU | 494 | 645 | 18 | 54.625 | | 16.13 | 1.69 |
| EVPMP60GI18PU | 553 | 733 | 18 | 60.625 | | 17.91 | 1.88 |
| EVPMP66GI18PU | 587 | 766 | 18 | 66.625 | | 19.70 | 2.06 |
| EVPMP72GI18PU | 621 | 800 | 18 | 72.625 | | 21.48 | 2.25 |

EVFDK-P • Panel Mount Privacy Felt

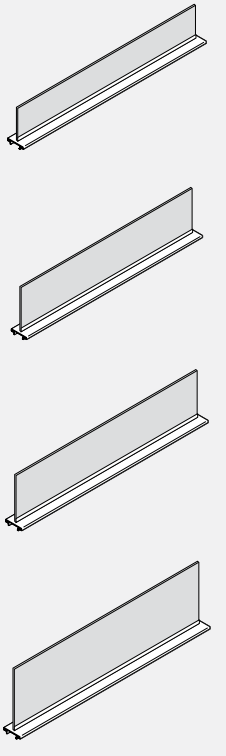

- Privacy felt panel intergrated within aluminum top trim.
- Attaches on top of panels to add privacy or divide space.
- Includes aluminum trim with channel and felt tile.
- Aluminum trim must be specified for entire station when ordering panel mount privacy felt.
- Felt and attachment hardware to ship seperately.
- 9mm Felt material is tackable and comes in 18 different colours. Please specify colour.

| PRODUCT CODE | PRICE | SIZE/ INCHES | | | WEIGHT LBS | VOL FT³ |
|--------------|-------|--------------|----|------|------------|---------|
| | | H | W | D | | |
| EVFDK0624P | 72 | 6 | 24 | 2.83 | 1.42 | 0.25 |
| EVFDK0630P | 88 | 6 | 30 | 2.83 | 1.73 | 0.32 |
| EVFDK0636P | 102 | 6 | 36 | 2.83 | 2.03 | 0.37 |
| EVFDK0642P | 113 | 6 | 42 | 2.83 | 2.34 | 0.43 |
| EVFDK0648P | 170 | 6 | 48 | 2.83 | 2.64 | 0.50 |
| EVFDK0654P | 183 | 6 | 54 | 2.83 | 2.95 | 0.56 |
| EVFDK0660P | 199 | 6 | 60 | 2.83 | 3.25 | 0.63 |
| EVFDK0666P | 210 | 6 | 66 | 2.83 | 3.56 | 0.69 |
| EVFDK0672P | 238 | 6 | 72 | 2.83 | 3.86 | 0.76 |
| EVFDK0924P | 72 | 9 | 24 | 2.83 | 1.63 | 0.38 |
| EVFDK0930P | 88 | 9 | 30 | 2.83 | 1.99 | 0.47 |
| EVFDK0936P | 102 | 9 | 36 | 2.83 | 2.35 | 0.56 |
| EVFDK0942P | 113 | 9 | 42 | 2.83 | 2.70 | 0.65 |
| EVFDK0948P | 170 | 9 | 48 | 2.83 | 3.06 | 0.75 |
| EVFDK0954P | 183 | 9 | 54 | 2.83 | 3.42 | 0.84 |
| EVFDK0960P | 199 | 9 | 60 | 2.83 | 3.78 | 0.94 |
| EVFDK0966P | 210 | 9 | 66 | 2.83 | 4.13 | 1.04 |
| EVFDK0972P | 238 | 9 | 72 | 2.83 | 4.49 | 1.13 |
| EVFDK1224P | 72 | 12 | 24 | 2.83 | 1.84 | 0.50 |
| EVFDK1230P | 88 | 12 | 30 | 2.83 | 2.25 | 0.63 |
| EVFDK1236P | 102 | 12 | 36 | 2.83 | 2.66 | 0.75 |
| EVFDK1242P | 113 | 12 | 42 | 2.83 | 3.07 | 0.87 |
| EVFDK1248P | 170 | 12 | 48 | 2.83 | 3.48 | 1.00 |
| EVFDK1254P | 183 | 12 | 54 | 2.83 | 3.89 | 1.12 |
| EVFDK1260P | 199 | 12 | 60 | 2.83 | 4.30 | 1.25 |
| EVFDK1266P | 210 | 12 | 66 | 2.83 | 5.12 | 1.38 |
| EVFDK1272P | 238 | 12 | 72 | 2.83 | 5.53 | 1.51 |
| EVFDK1824P | 92 | 18 | 24 | 2.83 | 2.26 | 0.75 |
| EVFDK1830P | 108 | 18 | 30 | 2.83 | 2.77 | 0.94 |
| EVFDK1836P | 128 | 18 | 36 | 2.83 | 3.29 | 1.13 |
| EVFDK1842P | 143 | 18 | 42 | 2.83 | 3.80 | 1.31 |
| EVFDK1848P | 212 | 18 | 48 | 2.83 | 4.32 | 1.50 |
| EVFDK1854P | 231 | 18 | 54 | 2.83 | 4.83 | 1.69 |
| EVFDK1860P | 248 | 18 | 60 | 2.83 | 5.35 | 1.88 |
| EVFDK1866P | 262 | 18 | 66 | 2.83 | 6.68 | 2.06 |
| EVFDK1872P | 298 | 18 | 72 | 2.83 | 7.20 | 2.25 |

EVFDK-PU • Panel Mount Privacy Divider for U Channel

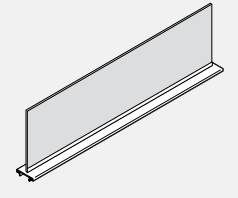

- Attaches on top of panels to add privacy or divide space.
- Privacy felt divider integrated within aluminum top trim to be used with U channel, with connector for Gallery Panels.
- Includes aluminum trim with channel and felt tile.
- Felt and attachment hardware ship separately.
- 9 mm felt material is tackable. Please specify felt finish.
- Aluminum top trim available in standard paint finishes.

| PRODUCT CODE | PRICE | SIZE / INCHES | | | WEIGHT LBS | VOL FT ³ |
|--------------|-------|---------------|-------|------|------------|---------------------|
| | | H | W | D | | |
| EVFDK0618PU | 72 | 6 | 18.62 | 2.83 | 1.42 | 0.25 |
| EVFDK0624PU | 87 | 6 | 24.62 | 2.83 | 1.73 | 0.32 |
| EVFDK0630PU | 101 | 6 | 30.62 | 2.83 | 2.03 | 0.37 |
| EVFDK0636PU | 113 | 6 | 36.62 | 2.83 | 2.34 | 0.43 |
| EVFDK0642PU | 170 | 6 | 42.62 | 2.83 | 2.64 | 0.50 |
| EVFDK0648PU | 184 | 6 | 48.62 | 2.83 | 2.95 | 0.56 |
| EVFDK0654PU | 199 | 6 | 54.62 | 2.83 | 3.25 | 0.63 |
| EVFDK0660PU | 211 | 6 | 60.62 | 2.83 | 3.56 | 0.69 |
| EVFDK0666PU | 238 | 6 | 66.62 | 2.83 | 3.86 | 0.76 |
| EVFDK0672PU | 267 | 6 | 72.62 | 2.83 | 4.16 | 0.83 |
| EVFDK0918PU | 72 | 9 | 18.62 | 2.83 | 1.63 | 0.38 |
| EVFDK0924PU | 87 | 9 | 24.62 | 2.83 | 1.99 | 0.47 |
| EVFDK0930PU | 101 | 9 | 30.62 | 2.83 | 2.35 | 0.56 |
| EVFDK0936PU | 113 | 9 | 36.62 | 2.83 | 2.70 | 0.65 |
| EVFDK0942PU | 170 | 9 | 42.62 | 2.83 | 3.06 | 0.75 |
| EVFDK0948PU | 184 | 9 | 48.62 | 2.83 | 3.42 | 0.84 |
| EVFDK0954PU | 199 | 9 | 54.62 | 2.83 | 3.78 | 0.94 |
| EVFDK0960PU | 211 | 9 | 60.62 | 2.83 | 4.13 | 1.04 |
| EVFDK0966PU | 238 | 9 | 66.62 | 2.83 | 4.49 | 1.13 |
| EVFDK0972PU | 267 | 9 | 72.62 | 2.83 | 4.85 | 1.22 |
| EVFDK1218PU | 72 | 12 | 18.62 | 2.83 | 1.84 | 0.50 |
| EVFDK1224PU | 87 | 12 | 24.62 | 2.83 | 2.25 | 0.63 |
| EVFDK1230PU | 101 | 12 | 30.62 | 2.83 | 2.66 | 0.75 |
| EVFDK1236PU | 113 | 12 | 36.62 | 2.83 | 3.07 | 0.87 |
| EVFDK1242PU | 170 | 12 | 42.62 | 2.83 | 3.48 | 1.00 |
| EVFDK1248PU | 184 | 12 | 48.62 | 2.83 | 3.89 | 1.12 |
| EVFDK1254PU | 199 | 12 | 54.62 | 2.83 | 4.30 | 1.25 |
| EVFDK1260PU | 211 | 12 | 60.62 | 2.83 | 5.12 | 1.38 |
| EVFDK1266PU | 238 | 12 | 66.62 | 2.83 | 5.53 | 1.51 |
| EVFDK1272PU | 267 | 12 | 72.62 | 2.83 | 5.94 | 1.64 |
| EVFDK1818PU | 92 | 18 | 18.62 | 2.83 | 2.83 | 0.75 |
| EVFDK1824PU | 109 | 18 | 24.62 | 2.83 | 2.77 | 0.94 |
| EVFDK1830PU | 128 | 18 | 30.62 | 2.83 | 3.29 | 1.13 |
| EVFDK1836PU | 143 | 18 | 36.62 | 2.83 | 3.80 | 1.31 |
| EVFDK1842PU | 213 | 18 | 42.62 | 2.83 | 4.32 | 1.50 |
| EVFDK1848PU | 231 | 18 | 48.62 | 2.83 | 4.83 | 1.69 |
| EVFDK1854PU | 250 | 18 | 54.62 | 2.83 | 5.35 | 1.88 |
| EVFDK1860PU | 263 | 18 | 60.62 | 2.83 | 6.68 | 2.06 |
| EVFDK1866PU | 298 | 18 | 66.62 | 2.83 | 7.20 | 2.25 |
| EVFDK1872PU | 335 | 18 | 72.62 | 2.83 | 7.72 | 2.44 |

EVFDK-PDU • Panel Mount Privacy Divider for U channel , Extended at Both Ends

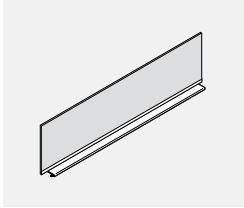

- Attaches on top of panels to add privacy or divide space.
- Privacy felt divider integrated within aluminum top trim to be used with U channel, with connector for Gallery Panels.
- Includes aluminum trim with channel and felt tile.
- Felt and attachment hardware ship separately.
- 9 mm felt material is tackable. Please specify felt finish.
- Aluminum top trim available in standard paint finishes.

| PRODUCT CODE | PRICE | SIZE / INCHES | | | WEIGHT LBS | VOL FT ³ |
|--------------|-------|---------------|-------|------|------------|---------------------|
| | | H | W | D | | |
| EVFDK0618PDU | 72 | 6 | 19.25 | 2.83 | 1.42 | 0.25 |
| EVFDK0624PDU | 87 | 6 | 25.25 | 2.83 | 1.73 | 0.32 |
| EVFDK0630PDU | 101 | 6 | 31.25 | 2.83 | 2.03 | 0.37 |
| EVFDK0636PDU | 113 | 6 | 37.25 | 2.83 | 2.34 | 0.43 |
| EVFDK0642PDU | 170 | 6 | 43.25 | 2.83 | 2.64 | 0.50 |
| EVFDK0648PDU | 184 | 6 | 49.25 | 2.83 | 2.95 | 0.56 |
| EVFDK0654PDU | 199 | 6 | 55.25 | 2.83 | 3.25 | 0.63 |
| EVFDK0660PDU | 211 | 6 | 61.25 | 2.83 | 3.56 | 0.69 |
| EVFDK0666PDU | 238 | 6 | 67.25 | 2.83 | 3.86 | 0.76 |
| EVFDK0672PDU | 267 | 6 | 73.25 | 2.83 | 4.16 | 0.83 |
| EVFDK0918PDU | 72 | 9 | 19.25 | 2.83 | 1.63 | 0.38 |
| EVFDK0924PDU | 87 | 9 | 25.25 | 2.83 | 1.99 | 0.47 |
| EVFDK0930PDU | 101 | 9 | 31.25 | 2.83 | 2.35 | 0.56 |
| EVFDK0936PDU | 113 | 9 | 37.25 | 2.83 | 2.70 | 0.65 |
| EVFDK0942PDU | 170 | 9 | 43.25 | 2.83 | 3.06 | 0.75 |
| EVFDK0948PDU | 184 | 9 | 49.25 | 2.83 | 3.42 | 0.84 |
| EVFDK0954PDU | 199 | 9 | 55.25 | 2.83 | 3.78 | 0.94 |
| EVFDK0960PDU | 211 | 9 | 61.25 | 2.83 | 4.13 | 1.04 |
| EVFDK0966PDU | 238 | 9 | 67.25 | 2.83 | 4.49 | 1.13 |
| EVFDK0972PDU | 267 | 9 | 73.25 | 2.83 | 4.85 | 1.22 |
| EVFDK1218PDU | 72 | 12 | 19.25 | 2.83 | 1.84 | 0.50 |
| EVFDK1224PDU | 87 | 12 | 25.25 | 2.83 | 2.25 | 0.63 |
| EVFDK1230PDU | 101 | 12 | 31.25 | 2.83 | 2.66 | 0.75 |
| EVFDK1236PDU | 113 | 12 | 37.25 | 2.83 | 3.07 | 0.87 |
| EVFDK1242PDU | 170 | 12 | 43.25 | 2.83 | 3.48 | 1.00 |
| EVFDK1248PDU | 184 | 12 | 49.25 | 2.83 | 3.89 | 1.12 |
| EVFDK1254PDU | 199 | 12 | 55.25 | 2.83 | 4.30 | 1.25 |
| EVFDK1260PDU | 211 | 12 | 61.25 | 2.83 | 5.12 | 1.38 |
| EVFDK1266PDU | 238 | 12 | 67.25 | 2.83 | 5.53 | 1.51 |
| EVFDK1272PDU | 267 | 12 | 73.25 | 2.83 | 5.94 | 1.64 |
| EVFDK1818PDU | 92 | 18 | 19.25 | 2.83 | 2.83 | 0.75 |
| EVFDK1824PDU | 109 | 18 | 25.25 | 2.83 | 2.77 | 0.94 |
| EVFDK1830PDU | 128 | 18 | 31.25 | 2.83 | 3.29 | 1.13 |
| EVFDK1836PDU | 143 | 18 | 37.25 | 2.83 | 3.80 | 1.31 |
| EVFDK1842PDU | 213 | 18 | 43.25 | 2.83 | 4.32 | 1.50 |
| EVFDK1848PDU | 231 | 18 | 49.25 | 2.83 | 4.83 | 1.69 |
| EVFDK1854PDU | 250 | 18 | 55.25 | 2.83 | 5.35 | 1.88 |
| EVFDK1860PDU | 263 | 18 | 61.25 | 2.83 | 6.68 | 2.06 |
| EVFDK1866PDU | 298 | 18 | 67.25 | 2.83 | 7.20 | 2.25 |
| EVFDK1872PDU | 335 | 18 | 73.25 | 2.83 | 7.72 | 2.44 |

EVFDK12-PN • 12" Panel Mount Privacy Felt 1 Notch

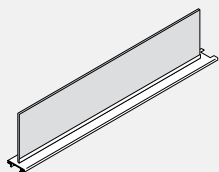

- Privacy felt panel intergrated within aluminum top trim.
- Attaches on top of panels to add privacy or divide space. Includes aluminum trim with channel and felt tile.
- Aluminum trim must be specified for entire station when ordering panel mount privacy felt.
- Felt and attachment hardware to ship seperately.
- 9mm Felt material is tackable. Please specify colour.

| PRODUCT CODE | PRICE | SIZE/ INCHES | | | WEIGHT LBS | VOL FT ³ |
|--------------|-------|--------------|----|------|------------|---------------------|
| | | H | W | D | | |
| EVFDK1224PN | 72 | 12 | 24 | 2.83 | 1.84 | 0.50 |
| EVFDK1230PN | 88 | 12 | 30 | 2.83 | 2.25 | 0.63 |
| EVFDK1236PN | 102 | 12 | 36 | 2.83 | 2.66 | 0.75 |
| EVFDK1242PN | 113 | 12 | 42 | 2.83 | 3.07 | 0.87 |
| EVFDK1248PN | 170 | 12 | 48 | 2.83 | 3.48 | 1.00 |
| EVFDK1254PN | 183 | 12 | 54 | 2.83 | 3.89 | 1.12 |
| EVFDK1260PN | 199 | 12 | 60 | 2.83 | 4.30 | 1.25 |

EVFDK12-PDN • 12" Panel Mount Privacy Felt 2 Notch

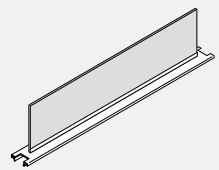

- Privacy felt panel intergrated within aluminum top trim.
- Attaches on top of panels to add privacy or divide space. Includes aluminum trim with channel and felt tile.
- Aluminum trim must be specified for entire station when ordering panel mount privacy felt.
- Felt and attachment hardware to ship seperately.
- 9mm Felt material is tackable. Please specify colour.

| PRODUCT CODE | PRICE | SIZE/ INCHES | | | WEIGHT LBS | VOL FT ³ |
|--------------|-------|--------------|----|------|------------|---------------------|
| | | H | W | D | | |
| EVFDK1224PDN | 72 | 12 | 24 | 2.83 | 1.84 | 0.50 |
| EVFDK1230PDN | 88 | 12 | 30 | 2.83 | 2.25 | 0.63 |
| EVFDK1236PDN | 102 | 12 | 36 | 2.83 | 2.66 | 0.75 |
| EVFDK1242PDN | 113 | 12 | 42 | 2.83 | 3.07 | 0.87 |
| EVFDK1248PDN | 170 | 12 | 48 | 2.83 | 3.48 | 1.00 |
| EVFDK1254PDN | 183 | 12 | 54 | 2.83 | 3.89 | 1.12 |
| EVFDK1260PDN | 199 | 12 | 60 | 2.83 | 4.30 | 1.25 |

EVFPDK06-PCF • 6" H Panel Mount Privacy Divider Ceiling Filler Kit

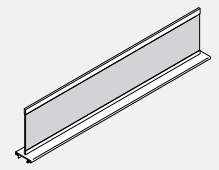

- Privacy Felt Divider integrated within aluminum top trim.
- Includes aluminum trim with channel and Felt tile.
- Felt tile and attachment hardware to ship separately.
- Please specify felt finish.
- Aluminum top trim available in standard paint finishes.
- PVC cap for closing gap at ceiling included.
- PVC cap available in white only.
- Felt ceiling filler should be used to close the gap between top of panel and ceiling.

| PRODUCT CODE | PRICE | SIZE/ INCHES | | | WEIGHT LBS | VOL FT ³ |
|---------------|-------|--------------|----|------|------------|---------------------|
| | | H | W | D | | |
| EVFPDK0618PCF | 75 | 6 | 18 | 2.83 | 1.11 | 0.20 |
| EVFPDK0624PCF | 82 | 6 | 24 | 2.83 | 1.42 | 0.26 |
| EVFPDK0630PCF | 100 | 6 | 30 | 2.83 | 1.73 | 0.32 |
| EVFPDK0636PCF | 115 | 6 | 36 | 2.83 | 2.03 | 0.37 |
| EVFPDK0642PCF | 131 | 6 | 42 | 2.83 | 2.34 | 0.43 |
| EVFPDK0648PCF | 196 | 6 | 48 | 2.83 | 2.64 | 0.43 |
| EVFPDK0654PCF | 212 | 6 | 54 | 2.83 | 2.95 | 0.56 |
| EVFPDK0660PCF | 229 | 6 | 60 | 2.83 | 3.25 | 0.63 |
| EVFPDK0666PCF | 240 | 6 | 66 | 2.83 | 3.56 | 0.69 |
| EVFPDK0672PCF | 274 | 6 | 72 | 2.83 | 3.86 | 0.76 |

EVFDK06-PCF • 6" H Panel Mount Privacy Divider Ceiling Filler Kit

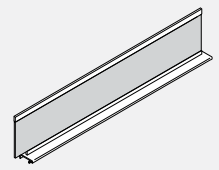

- Privacy Felt Divider integrated with aluminum top trim.
- Includes aluminum trim with channel and Felt tile.
- Felt tile and attachment hardware to ship separately.
- Please specify felt finish.
- Felt tile is longer and overhangs half of the width of post.
- Aluminum trim is width of panel.
- Aluminum top trim available in standard paint finishes.
- PVC cap for closing gap at ceiling included.
- PVC cap available in white only.
- Felt ceiling filler should be used to close the gap between top of panel and ceiling.

| PRODUCT CODE | PRICE | SIZE/ INCHES | | | WEIGHT LBS | VOL FT ³ |
|--------------|-------|--------------|-------|------|------------|---------------------|
| | | H | W | D | | |
| EVFDK0619PCF | 82 | 6 | 19.75 | 2.83 | 1.42 | 0.26 |
| EVFDK0625PCF | 100 | 6 | 25.75 | 2.83 | 1.73 | 0.32 |
| EVFDK0631PCF | 115 | 6 | 31.75 | 2.83 | 2.03 | 0.37 |
| EVFDK0637PCF | 131 | 6 | 37.75 | 2.83 | 2.34 | 0.43 |
| EVFDK0643PCF | 196 | 6 | 43.75 | 2.83 | 2.64 | 0.43 |
| EVFDK0649PCF | 212 | 6 | 49.75 | 2.83 | 2.95 | 0.56 |
| EVFDK0655PCF | 229 | 6 | 55.75 | 2.83 | 3.25 | 0.63 |
| EVFDK0661PCF | 240 | 6 | 61.75 | 2.83 | 3.56 | 0.69 |
| EVFDK0667PCF | 274 | 6 | 67.75 | 2.83 | 3.86 | 0.76 |
| EVFDK0673PCF | 306 | 6 | 73.75 | 2.83 | 4.16 | 0.83 |

POST CONFIGURATIONS • TECHNICAL INFORMATION

As illustrated in the example below, start with position "A" and continue clockwise specifying the height of each slotted connector.

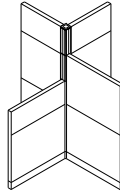
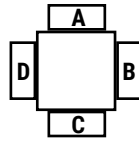
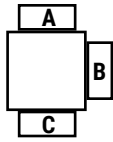
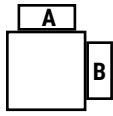

PANEL EXTENSION MODULES

When ordering Panel Extension Modules, Inline Panel Extension Connectors (EVPIEC) must be ordered separately.

Inline Panel Extension Connectors connect two panel extension modules of equal height in a straight run.

Extension connectors do not provide support for hang-on storage above 66".

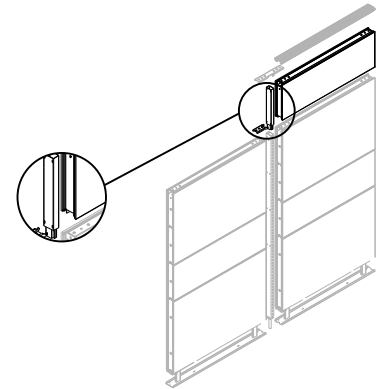
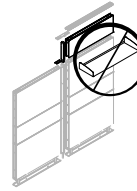

EVPIC • Inline Panel Connector

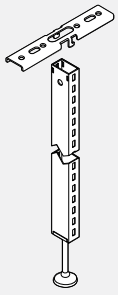

- Connects two panels of equal height in a straight run.
- Provides slotted support for worksurfaces and hang-on storage components.
- Includes slotted connectors with leveling glide and connection hardware.

| PRODUCT CODE | PRICE | SIZE/INCHES | | WEIGHT VOL | |
|--------------|-------|-------------|---|------------|-----------------|
| | | H | W | LBS | FT ³ |
| EVPIC30 | 63 | 30 | 2 | 3.30 | 0.50 |
| EVPIC42 | 67 | 42 | 2 | 4.60 | 0.07 |
| EVPIC48 | 69 | 48 | 2 | 5.25 | 0.07 |
| EVPIC54 | 74 | 54 | 2 | 5.90 | 0.09 |
| EVPIC66 | 83 | 66 | 2 | 7.20 | 0.10 |

EVPVC • Variable Height Connector

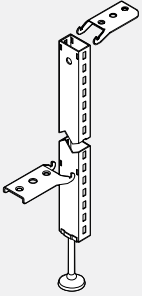

- Connects two panels of different heights in a straight run.
- Connector must reference taller panel.
- Can be used for any variation of panel heights.
- Provides slotted support for worksurfaces and hang-on storage components.
- Includes slotted connector with levelling glide and connection hardware.
- Variable-height trim must be ordered separately, see EVPTV or EVPTVA.

| PRODUCT CODE | PRICE | SIZE/INCHES | | WEIGHT VOL | |
|--------------|-------|-------------|---|------------|-----------------|
| | | H | W | LBS | FT ³ |
| EVPVC42 | 74 | 42 | 2 | 4.60 | 0.70 |
| EVPVC48 | 77 | 48 | 2 | 5.25 | 0.70 |
| EVPVC54 | 78 | 54 | 2 | 5.90 | 0.90 |
| EVPVC66 | 88 | 66 | 2 | 7.20 | 0.10 |

EVPERA • End of Run Kit (Wall Mount)

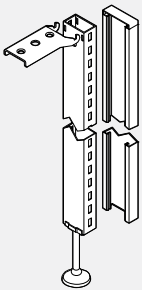

- Finishes the end of each panel run and can be used to attach a panel run to a fixed wall.
- Adds 1" to the width of a panel run.
- Provides slotted support for worksurfaces and hang-on storage components.
- Includes slotted connector with levelling glide, connection hardware and trim kit.
- Can be attached to face of another panel to provide off-modular panel connection by screwing the trim to the horizontals of the panel.

| PRODUCT CODE | PRICE | TYPE | SIZE/INCHES | | WEIGHT VOL | |
|--------------|-------|----------|-------------|-------|------------|-----------------|
| | | | H | W | LBS | FT ³ |
| EVPERA30 | 78 | Aluminum | 30 | 2.875 | 3.30 | 0.07 |
| EVPERA42 | 94 | Aluminum | 42 | 2.875 | 4.60 | 0.10 |
| EVPERA48 | 100 | Aluminum | 48 | 2.875 | 6.75 | 0.10 |
| EVPERA54 | 112 | Aluminum | 54 | 2.875 | 5.09 | 0.18 |
| EVPERA66 | 126 | Aluminum | 66 | 2.875 | 7.20 | 0.22 |

EVPUERA • Upmount End of Run Kit

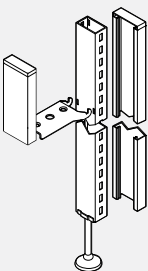

- Replaces the standard End-of-Run Kit EVPERA.
- Used at the end of a panel run to support worksurfaces and Upmount overhead storage.
- Can attach a panel run to a fixed wall.
- Adds 1" to the width of a panel run.
- Includes slotted connector with levelling glide, connection hardware, Upmount End-of-Run Trim EVPUET and one Upmount Extension Trim EVPUET12.

| PRODUCT CODE | PRICE | TYPE | SIZE/INCHES | | WEIGHT VOL | |
|--------------|-------|----------|-------------|-------|------------|-----------------|
| | | | H | W | LBS | FT ³ |
| EVPUERA66 | 138 | Aluminum | 66 | 2.875 | 7.20 | 0.22 |

EVPCPA1 • One Way Post

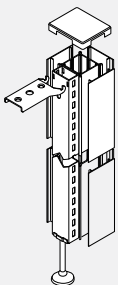

- Replaces an EVPERA End-of-Run Post Kit at the end of a run of panels.
- Used with EVDPE Post Extension to allow for ceiling entry at end of panel run.
- Adds 2 7/8" to the end of a run of panels.
- Provides slotted support for worksurfaces and hang-on storage components.
- Includes corner post, one slotted connector with levelling glides, attachment hardware and trim.

| PRODUCT CODE | PRICE | TYPE | SIZE/INCHES | | | WEIGHT VOL | |
|--------------|-------|----------|-------------|-------|---|------------|-----------------|
| | | | H | W | D | LBS | FT ³ |
| EVPCPA130 | 103 | Aluminum | 30 | 2.875 | | 4.97 | 0.24 |
| EVPCPA142 | 117 | Aluminum | 42 | 2.875 | | 6.93 | 0.33 |
| EVPCPA148 | 139 | Aluminum | 48 | 2.875 | | 7.93 | 0.38 |
| EVPCPA154 | 160 | Aluminum | 54 | 2.875 | | 8.93 | 0.43 |
| EVPCPA166 | 199 | Aluminum | 66 | 2.875 | | 10.87 | 0.53 |

EVPIPA2 • Inline Two Way Post

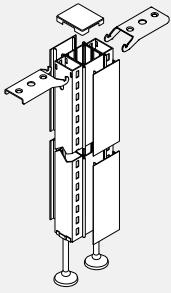

- Connects two panels of equal height in a straight line in place of an EVPIC Inline Panel Connector.
- Adds 2 7/8" to the end of a run of panels.
- Provides slotted support for worksurfaces and hang-on storage components.
- Includes corner post, two slotted connectors with levelling glides, attachment hardware and trim.

| PRODUCT CODE | PRICE | TYPE | SIZE/ INCHES | | WEIGHT VOL | |
|--------------|-------|----------|--------------|-------|------------|-----------------|
| | | | H | W | LBS | FT ³ |
| EVPIPA230 | 162 | Aluminum | 30 | 2.875 | 8.20 | 0.31 |
| EVPIPA242 | 207 | Aluminum | 42 | 2.875 | 11.50 | 0.43 |
| EVPIPA248 | 217 | Aluminum | 48 | 2.875 | 13.50 | 0.54 |
| EVPIPA254 | 251 | Aluminum | 54 | 2.875 | 15.00 | 0.61 |
| EVPIPA266 | 299 | Aluminum | 66 | 2.875 | 19.00 | 0.75 |

EVPCPA2 • Two Way Corner Post

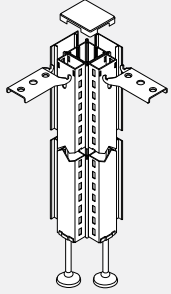

- Attaches two panels of equal height in 90° configuration.
- Provides slotted support for worksurfaces and hang-on storage components.
- Includes corner post, two slotted connectors with levelling glides, attachment hardware and trim.

| PRODUCT CODE | PRICE | TYPE | SIZE/ INCHES | | WEIGHT VOL | |
|--------------|-------|----------|--------------|-------|------------|-----------------|
| | | | H | W | LBS | FT ³ |
| EVPCPA230 | 162 | Aluminum | 30 | 2.875 | 8.50 | 0.31 |
| EVPCPA242 | 207 | Aluminum | 42 | 2.875 | 11.50 | 0.43 |
| EVPCPA248 | 217 | Aluminum | 48 | 2.875 | 11.50 | 0.43 |
| EVPCPA254 | 251 | Aluminum | 54 | 2.875 | 15.00 | 0.61 |
| EVPCPA266 | 299 | Aluminum | 66 | 2.875 | 19.00 | 0.75 |

EVPCPA3 • Three Way Corner Post

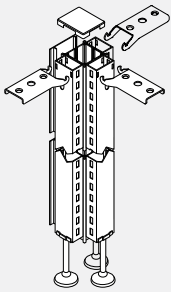

- Attaches three panels of equal height in a "T" configuration.
- Provides slotted support for worksurfaces and hang-on storage components.
- Includes corner post, three slotted connectors with levelling glides, attachment hardware top cap and trim.

| PRODUCT CODE | PRICE | TYPE | SIZE/ INCHES | | WEIGHT VOL | |
|--------------|-------|----------|--------------|-------|------------|-----------------|
| | | | H | W | LBS | FT ³ |
| EVPCPA330 | 195 | Aluminum | 30 | 2.875 | 11.80 | 0.36 |
| EVPCPA342 | 260 | Aluminum | 42 | 2.875 | 16.10 | 0.50 |
| EVPCPA348 | 286 | Aluminum | 48 | 2.875 | 18.75 | 0.61 |
| EVPCPA354 | 317 | Aluminum | 54 | 2.875 | 20.50 | 0.70 |
| EVPCPA366 | 373 | Aluminum | 66 | 2.875 | 26.20 | 0.85 |

EVPCP4 • Four Way Corner Post

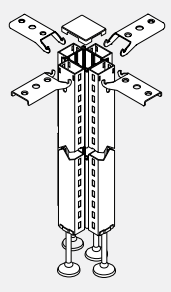

- Attaches four panels of equal height in an "X" configuration.
- Provides slotted support for worksurfaces and hang-on storage components.
- Includes corner post, four slotted connectors with levelling glides, attachment hardware and top cap.

| PRODUCT CODE | PRICE | TYPE | SIZE/ INCHES | | WEIGHT VOL | |
|--------------|-------|----------|--------------|-------|------------|-----------------|
| | | | H | W | LBS | FT ³ |
| EVPCP430 | 213 | Aluminum | 30 | 2.875 | 15.50 | 0.41 |
| EVPCP442 | 279 | Aluminum | 42 | 2.875 | 21.00 | 0.57 |
| EVPCP448 | 307 | Aluminum | 48 | 2.875 | 24.00 | 0.68 |
| EVPCP454 | 339 | Aluminum | 54 | 2.875 | 26.50 | 0.79 |
| EVPCP466 | 397 | Aluminum | 66 | 2.875 | 33.20 | 0.95 |

EVVPVA2 • Two Way Variable Height Corner Post

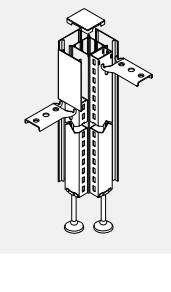

- Attaches two panels of different heights at a corner.
- Specify the corner post height that matches the tallest panel attached to the post face.
- Provides slotted support for worksurfaces and hang-on storage components.
- Includes corner post, two slotted connectors with levelling glides, attachment hardware and trim.
- Configuration of connecting panels must be specified. ie. 54/66. See Technical Information at the beginning of this section.

| PRODUCT CODE | PRICE | TYPE | SIZE/ INCHES | | WEIGHT VOL | |
|--------------|-------|----------|--------------|-------|------------|-----------------|
| | | | H | W | LBS | FT ³ |
| EVVPVA242 | 207 | Aluminum | 42 | 2.875 | 10.00 | 1.30 |
| EVVPVA248 | 229 | Aluminum | 48 | 2.875 | 13.50 | 1.50 |
| EVVPVA254 | 251 | Aluminum | 54 | 2.875 | 17.00 | 1.80 |
| EVVPVA266 | 299 | Aluminum | 66 | 2.875 | 20.50 | 2.10 |

EVPVPA3 • Three Way Variable Height Corner Post

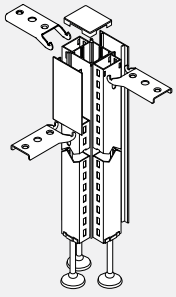

- Attaches three panels of different heights in a "T" configuration.
- Specify the corner post height that matches the tallest panel attached to the post face.
- Provides slotted support for worksurfaces and hang-on storage components.
- Includes corner post, three slotted connectors with levelling glides, attachment hardware and trim.
- Configuration of connecting panels must be specified. ie. 54/42/66. See Technical information page at the beginning of this section.

| PRODUCT CODE | PRICE | TYPE | SIZE/ H | INCHES W | WEIGHT LBS | VOL FT ³ |
|--------------|-------|----------|---------|----------|------------|---------------------|
| EVPVPA342 | 260 | Aluminum | 42 | 2.875 | 12.50 | 0.30 |
| EVPVPA348 | 286 | Aluminum | 48 | 2.875 | 15.50 | 0.66 |
| EVPVPA354 | 317 | Aluminum | 54 | 2.875 | 18.50 | 0.68 |
| EVPVPA366 | 373 | Aluminum | 66 | 2.875 | 24.20 | 0.90 |

EVPVPA4 • Four Way Variable Height Corner Post

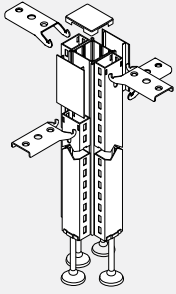

- Attaches four panels of different heights in an "X" configuration.
- Specify the corner post height that matches the tallest panel attached to the post face.
- Provides slotted support for worksurfaces and hang-on storage components.
- Includes corner post, four slotted connectors with levelling glides, attachment hardware and trim.
- Configuration of connecting panels must be specified. ie. 42/66/54/42. See Technical information page at the beginning of this section.

| PRODUCT CODE | PRICE | TYPE | SIZE/ H | INCHES W | WEIGHT LBS | VOL FT ³ |
|--------------|-------|----------|---------|----------|------------|---------------------|
| EVPVPA442 | 293 | Aluminum | 42 | 2.875 | 18.50 | 0.35 |
| EVPVPA448 | 323 | Aluminum | 48 | 2.875 | 20.50 | 0.70 |
| EVPVPA454 | 353 | Aluminum | 54 | 2.875 | 24.50 | 1.05 |
| EVPVPA466 | 417 | Aluminum | 66 | 2.875 | 30.20 | 1.40 |

EVPIEC • Inline Panel Extension Connector - Non Slotted

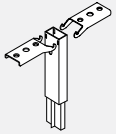

- Connects two panel extension modules of equal height in a straight run.
- Does not provide support for hang-on storage components.

| PRODUCT CODE | PRICE | SIZE/ H | INCHES W | WEIGHT LBS | VOL FT ³ |
|--------------|-------|---------|----------|------------|---------------------|
| EVPIEC06 | 30 | 6 | 2 | 1.00 | 0.06 |
| EVPIEC12 | 30 | 12 | 2 | 2.00 | 0.12 |
| EVPIEC18 | 36 | 18 | 2 | 3.00 | 0.18 |
| EVPIEC24 | 36 | 24 | 2 | 4.00 | 0.24 |

EVPIECS • Inline Panel Extension Connector - Slotted

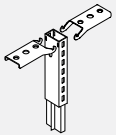

- Connects two panel extension modules of equal height in a straight run.
- Provides slotted support up to 66" high for worksurfaces and hang-on storage components.

| PRODUCT CODE | PRICE | SIZE/ H | INCHES W | WEIGHT LBS | VOL FT ³ |
|--------------|-------|---------|----------|------------|---------------------|
| EVPIECS06 | 37 | 6 | 2 | 1.00 | 0.06 |
| EVPIECS12 | 37 | 12 | 2 | 2.00 | 0.12 |
| EVPIECS18 | 43 | 18 | 2 | 3.00 | 0.18 |
| EVPIECS24 | 43 | 24 | 2 | 4.00 | 0.24 |

EVPEERA • End of Run Extension - Non Slotted

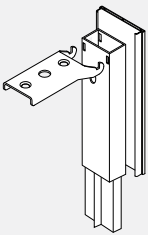

- Extends an End-of-Run Kit.
- Does not provide support for hang-on storage components.
- Includes Inline Panel Extension Connector (EVPIEC) and Panel Extension Trim (EVPTEA).

| PRODUCT CODE | PRICE | TYPE | SIZE/ H | INCHES W | WEIGHT LBS | VOL FT ³ |
|--------------|-------|----------|---------|----------|------------|---------------------|
| EVPEERA06 | 34 | Aluminum | 6 | 2.875 | 1.00 | 0.06 |
| EVPEERA12 | 34 | Aluminum | 12 | 2.875 | 2.00 | 0.12 |
| EVPEERA18 | 40 | Aluminum | 18 | 2.875 | 3.00 | 0.18 |
| EVPEERA24 | 40 | Aluminum | 24 | 2.875 | 4.00 | 0.24 |

EVPEERSA • End of Run Extension - Slotted

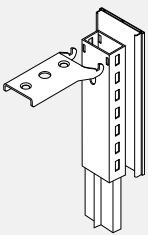

- Extends an End-of-Run Kit.
- Provides slotted support up to 66" high for worksurfaces and hang-on storage components.
- Includes Inline Panel Extension Connector (EVPIECS) and Panel Extension Trim (EVPTE or EVPTEA).

| PRODUCT CODE | PRICE | TYPE | SIZE/ H | INCHES W | WEIGHT LBS | VOL FT ³ |
|--------------|-------|----------|---------|----------|------------|---------------------|
| EVPEERSA06 | 40 | Aluminum | 6 | 2.875 | 1.00 | 0.06 |
| EVPEERSA12 | 40 | Aluminum | 12 | 2.875 | 2.00 | 0.12 |
| EVPEERSA18 | 61 | Aluminum | 18 | 2.875 | 3.00 | 0.18 |
| EVPEERSA24 | 61 | Aluminum | 24 | 2.875 | 4.00 | 0.24 |

EVPCEPA1 • One Way Post Extension - Non Slotted

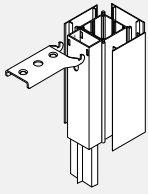

- Attaches to a corner post at the end of a run of panel extension modules.
- Includes corner extension post, one non-slotted connector, attachment hardware and trim.

| PRODUCT CODE | PRICE | TYPE | SIZE/ H | INCHES W | WEIGHT LBS | VOL FT ³ |
|--------------|-------|----------|---------|----------|------------|---------------------|
| EVPCEPA106 | 66 | Aluminum | 6 | 2.875 | 2.00 | 0.07 |
| EVPCEPA112 | 66 | Aluminum | 12 | 2.875 | 4.00 | 0.14 |
| EVPCEPA118 | 91 | Aluminum | 18 | 2.875 | 6.00 | 0.21 |
| EVPCEPA124 | 91 | Aluminum | 24 | 2.875 | 8.00 | 0.28 |

EVPCEPSA1 • One Way Post Extension - Slotted

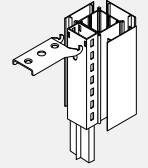

- Attaches to a corner post at the end of a run of panel extension modules.
- Provides slotted support up to 66" high for worksurfaces and hang-on storage components.
- Includes corner extension post, one slotted connector, attachment hardware and trim.

| PRODUCT CODE | PRICE | TYPE | SIZE/ H | INCHES W | WEIGHT LBS | VOL FT ³ |
|--------------|-------|----------|---------|----------|------------|---------------------|
| EVPCEPSA106 | 89 | Aluminum | 6 | 2.875 | 2.00 | 0.07 |
| EVPCEPSA112 | 89 | Aluminum | 12 | 2.875 | 4.00 | 0.14 |
| EVPCEPSA118 | 112 | Aluminum | 18 | 2.875 | 6.00 | 0.21 |
| EVPCEPSA124 | 112 | Aluminum | 24 | 2.875 | 8.00 | 0.28 |

EVPCEIPA2 • Inline Post Extension - Non Slotted

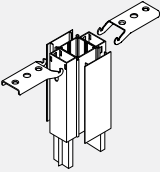

- Attaches to a corner post and connects two panel extension modules in a straight line.
- Includes corner extension post, two non-slotted connectors, attachment hardware and trim.

| PRODUCT CODE | PRICE | TYPE | SIZE/ H | INCHES W | WEIGHT LBS | VOL FT ³ |
|--------------|-------|----------|---------|----------|------------|---------------------|
| EVPCEIPA206 | 90 | Aluminum | 6 | 2.875 | 2.00 | 0.07 |
| EVPCEIPA212 | 90 | Aluminum | 12 | 2.875 | 4.00 | 0.14 |
| EVPCEIPA218 | 140 | Aluminum | 18 | 2.875 | 6.00 | 0.18 |
| EVPCEIPA224 | 140 | Aluminum | 24 | 2.875 | 8.00 | 0.28 |

EVPCEIPSA2 • Inline Post Extension - Slotted

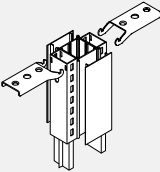

- Attaches to a corner post and connects two panel extension modules in a straight line.
- Provides slotted support up to 66" high for worksurfaces and hang-on storage components.
- Includes corner extension post, two slotted connectors, attachment hardware and trim.

| PRODUCT CODE | PRICE | TYPE | SIZE/ H | INCHES W | WEIGHT LBS | VOL FT ³ |
|--------------|-------|----------|---------|----------|------------|---------------------|
| EVPCEIPSA206 | 90 | Aluminum | 6 | 2.875 | 2.00 | 0.07 |
| EVPCEIPSA212 | 90 | Aluminum | 12 | 2.875 | 4.00 | 0.14 |
| EVPCEIPSA218 | 140 | Aluminum | 18 | 2.875 | 6.00 | 0.18 |
| EVPCEIPSA224 | 140 | Aluminum | 24 | 2.875 | 8.00 | 0.28 |

EVPCEPA2 • Two Way Post Extension - Non Slotted

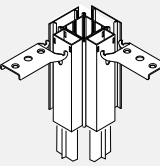

- Connects two panel extension modules of equal height in a corner "L" configuration.
- Includes corner extension post, two non-slotted connectors, attachment hardware and trim.

| PRODUCT CODE | PRICE | TYPE | SIZE/ H | INCHES W | WEIGHT LBS | VOL FT ³ |
|--------------|-------|----------|---------|----------|------------|---------------------|
| EVPCEPA206 | 72 | Aluminum | 6 | 2.875 | 2.00 | 0.07 |
| EVPCEPA212 | 72 | Aluminum | 12 | 2.875 | 4.00 | 0.14 |
| EVPCEPA218 | 122 | Aluminum | 18 | 2.875 | 6.00 | 0.21 |
| EVPCEPA224 | 122 | Aluminum | 24 | 2.875 | 8.00 | 0.28 |

EVPCEPSA2 • Two Way Post Extension - Slotted

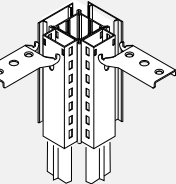

- Connects two panel extension modules of equal height in a 90° configuration.
- Includes corner extension post, two slotted connectors, attachment hardware and trim.

| PRODUCT CODE | PRICE | TYPE | SIZE/ H | INCHES W | WEIGHT LBS | VOL FT ³ |
|--------------|-------|----------|---------|----------|------------|---------------------|
| EVPCEPSA206 | 90 | Aluminum | 6 | 2.875 | 2.00 | 0.07 |
| EVPCEPSA212 | 90 | Aluminum | 12 | 2.875 | 4.00 | 0.14 |
| EVPCEPSA218 | 140 | Aluminum | 18 | 2.875 | 6.00 | 0.21 |
| EVPCEPSA224 | 140 | Aluminum | 24 | 2.875 | 8.00 | 0.28 |

EVPCEPA3 • Three Way Post Extension - Non Slotted

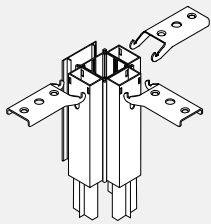

- Connects three panel extension modules of equal height in a corner "T" configuration.
- Includes corner extension post, three non-slotted connectors, attachment hardware and trim.

| PRODUCT CODE | PRICE | TYPE | SIZE/ H | INCHES W | WEIGHT LBS | VOL FT ³ |
|--------------|-------|----------|---------|----------|------------|---------------------|
| EVPCEPA306 | 80 | Aluminum | 6 | 2.875 | 3.00 | 0.08 |
| EVPCEPA312 | 80 | Aluminum | 12 | 2.875 | 6.00 | 0.16 |
| EVPCEPA318 | 133 | Aluminum | 18 | 2.875 | 9.00 | 0.24 |
| EVPCEPA324 | 133 | Aluminum | 24 | 2.875 | 12.00 | 0.32 |

EVPCEPSA3 • Three Way Post Extension - Slotted

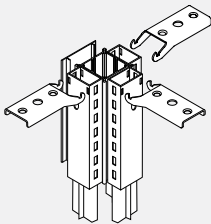

- Connects three panel extension modules of equal height in a corner "T" configuration.
- Includes corner extension post, three slotted connectors, attachment hardware and trim.

| PRODUCT CODE | PRICE | TYPE | SIZE/ H | INCHES W | WEIGHT LBS | VOL FT ³ |
|--------------|-------|----------|---------|----------|------------|---------------------|
| EVPCEPSA306 | 103 | Aluminum | 6 | 2.875 | 3.00 | 0.08 |
| EVPCEPSA312 | 103 | Aluminum | 12 | 2.875 | 6.00 | 0.16 |
| EVPCEPSA318 | 161 | Aluminum | 18 | 2.875 | 9.00 | 0.24 |
| EVPCEPSA324 | 161 | Aluminum | 24 | 2.875 | 12.00 | 0.32 |

EVPCEP4 • Four Way Post Extension - Non Slotted

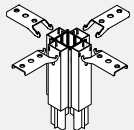

- Connects four panel extension modules of equal height in a corner "X" configuration.
- Includes corner extension post, four non-slotted connectors and attachment hardware.

| PRODUCT CODE | PRICE | SIZE/ H | INCHES W | WEIGHT LBS | VOL FT ³ |
|--------------|-------|---------|----------|------------|---------------------|
| EVPCEP406 | 74 | 6 | 2.875 | 4.00 | 0.09 |
| EVPCEP412 | 74 | 12 | 2.875 | 8.00 | 0.18 |
| EVPCEP418 | 117 | 18 | 2.875 | 12.00 | 0.27 |
| EVPCEP424 | 117 | 24 | 2.875 | 16.00 | 0.36 |

EVPCEPS4 • Four Way Extension Post - Slotted

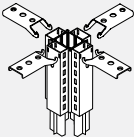

- Connects four panel extension modules of equal height in a corner "X" four-way configuration.
- Includes corner extension post, four slotted connectors and attachment hardware.

| PRODUCT CODE | PRICE | SIZE/ H | INCHES W | WEIGHT LBS | VOL FT ³ |
|--------------|-------|---------|----------|------------|---------------------|
| EVPCEPS406 | 106 | 6 | 2.875 | 4.00 | 0.09 |
| EVPCEPS412 | 106 | 12 | 2.875 | 8.00 | 0.18 |
| EVPCEPS418 | 145 | 18 | 2.875 | 12.00 | 0.27 |
| EVPCEPS424 | 159 | 24 | 2.875 | 16.00 | 0.36 |

EVP4PA • Two Way 45° Corner Post

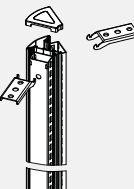

- Attaches two Panels of equal height in a 135° configuration.
- Provides slotted support for worksurfaces and hang-on storage components.
- Includes corner post, two slotted connectors with leveling glides and connecting hardware.
- Connectors available without slots as a special at no upcharge. Contact Customer Support.
- Does not allow to run wires under top trim.

| PRODUCT CODE | PRICE | SIZE/ H | INCHES W | WEIGHT LBS | VOL FT ³ |
|--------------|-------|---------|----------|------------|---------------------|
| EVP4PA230 | 147 | 30 | 3.65 | 8.50 | 0.310 |
| EVP4PA242 | 187 | 42 | 3.65 | 11.50 | 0.430 |
| EVP4PA248 | 197 | 48 | 3.65 | 13.50 | 0.540 |
| EVP4PA254 | 229 | 54 | 3.65 | 15.00 | 0.610 |
| EVP4PA266 | 271 | 66 | 3.65 | 19.00 | 0.750 |

EVP4VPA • Variable Height Two Way 45° Corner Post - Aluminum

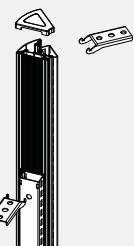

- Attaches two Panels of different height in a 135° configuration.
- Specify the corner post height that matches the tallest panel attached to the post face.
- Provides slotted support for worksurfaces and hang-on storage components.
- Includes corner post, two slotted connectors with leveling glides and connecting hardware.
- Connectors available without slots as a special at no upcharge. Contact Customer Support.
- Do not allow to run wires under the top trim.

| PRODUCT CODE | PRICE | SIZE/ H | INCHES W | WEIGHT LBS | VOL FT ³ |
|--------------|-------|---------|----------|------------|---------------------|
| EVP4VPA242 | 197 | 42 | 3.65 | 8.50 | 0.310 |
| EVP4VPA248 | 218 | 48 | 3.65 | 11.50 | 0.430 |
| EVP4VPA254 | 240 | 54 | 3.65 | 13.50 | 0.540 |
| EVP4VPA266 | 286 | 66 | 3.65 | 15.00 | 0.610 |

EVP4CEPSA • One Way 45° Corner Post Extension - Slotted - Aluminum

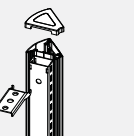

- Attached to a corner post at the end of run of panel extension modules.
- Provides slotted support up to 66" high for worksurfaces and hang-on storage components.
- Includes corner extension post, one slotted connectors, connecting hardware and trim kit.

| PRODUCT CODE | PRICE | SIZE/ H | INCHES W | WEIGHT LBS | VOL FT ³ |
|--------------|-------|---------|----------|------------|---------------------|
| EVP4CEPSA106 | 80 | 6 | 3.65 | 6 | 3.65 |
| EVP4CEPSA112 | 83 | 12 | 3.65 | 12 | 3.65 |
| EVP4CEPSA118 | 109 | 18 | 3.65 | 18 | 3.65 |
| EVP4CEPSA124 | 109 | 24 | 3.65 | 24 | 3.65 |

EVP4CEPA • One Way 45° Corner Post Extension - Non Slotted - Aluminum

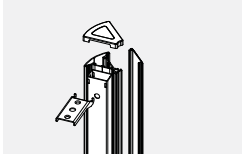

- Attached to a corner post at the end of run of panel extension modules.
- Includes corner extension post, one non-slotted connectors, connecting hardware and trim kit.

| PRODUCT CODE | PRICE | SIZE/ H | INCHES W | WEIGHT LBS | VOL FT ³ |
|--------------|-------|---------|----------|------------|---------------------|
| EVP4CEPA106 | 61 | 6 | 3.65 | 6 | 3.65 |
| EVP4CEPA112 | 65 | 12 | 3.65 | 12 | 3.65 |
| EVP4CEPA118 | 88 | 18 | 3.65 | 18 | 3.65 |
| EVP4CEPA124 | 88 | 24 | 3.65 | 24 | 3.65 |

EVP6PA2 • Two Way 60° Corner Post - Aluminum

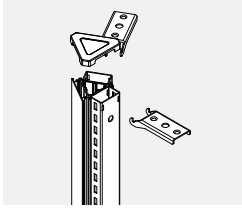

- Attaches two Panels of equal height in a 120° configuration.
- Provides slotted support for worksurfaces and hang-on storage components.
- Includes corner post, two slotted connectors with leveling glides, connecting hardware and trim kit.
- Connectors available without slots as a special at no upcharge. Contact Customer Support.

| PRODUCT CODE | PRICE | SIZE/ H | INCHES W | WEIGHT LBS | VOL FT ³ |
|--------------|-------|---------|----------|------------|---------------------|
| EVP6PA230 | 157 | 30 | 3.65 | 8.50 | 0.310 |
| EVP6PA242 | 195 | 42 | 3.65 | 11.50 | 0.430 |
| EVP6PA248 | 212 | 48 | 3.65 | 13.50 | 0.540 |
| EVP6PA254 | 241 | 54 | 3.65 | 15.00 | 0.610 |
| EVP6PA266 | 286 | 66 | 3.65 | 19.00 | 0.750 |

EVP6P3 • Three Way 60° Corner Post

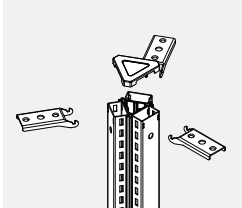

- Attaches three panels of equal height in a 120° configuration.
- Provides slotted support for worksurfaces and hang-on storage components.
- Includes corner post, two slotted connectors with leveling glides and connecting hardware.
- Connectors available without slots as a special at no upcharge. Contact Customer Support.

| PRODUCT CODE | PRICE | SIZE/ H | INCHES W | WEIGHT LBS | VOL FT ³ |
|--------------|-------|---------|----------|------------|---------------------|
| EVP6P330 | 169 | 30 | 3.65 | 11.90 | 0.360 |
| EVP6P342 | 227 | 42 | 3.65 | 16.10 | 0.500 |
| EVP6P348 | 249 | 48 | 3.65 | 18.75 | 0.610 |
| EVP6P354 | 276 | 54 | 3.65 | 20.50 | 0.700 |
| EVP6P366 | 327 | 66 | 3.65 | 26.20 | 0.850 |

EVP6VPA2 • Variable Height Two Way 60° Corner Post - Aluminum

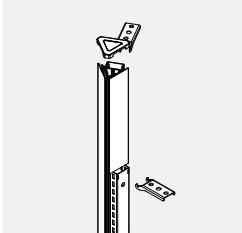

- Attaches two Panels of different height in a 120° configuration.
- Specify the corner post height that matches the tallest panel attached to the post face.
- Provides slotted support for worksurfaces and hang-on storage components.
- Includes corner post, two slotted connectors with leveling glides, connecting hardware and trim kit.
- Connectors available without slots as a special at no upcharge. Contact Customer Support

| PRODUCT CODE | PRICE | SIZE/ H | INCHES W | WEIGHT LBS | VOL FT ³ |
|--------------|-------|---------|----------|------------|---------------------|
| EVP6VPA242 | 197 | 30 | 3.65 | 12.50 | 0.490 |
| EVP6VPA248 | 218 | 42 | 3.65 | 15.40 | 0.660 |
| EVP6VPA254 | 240 | 48 | 3.65 | 19.00 | 0.700 |
| EVP6VPA266 | 286 | 54 | 3.65 | 22.50 | 0.750 |

EVP6VPA3 • Variable Height Three Way 60° Corner Post - Aluminum

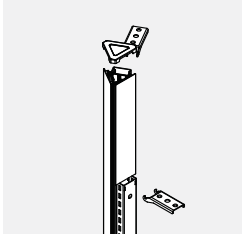

- Attaches two Panels of different height in a 120° configuration.
- Specify the corner post height that matches the tallest panel attached to the post face.
- Provides slotted support for worksurfaces and hang-on storage components.
- Includes corner post, two slotted connectors with leveling glides, connecting hardware and trim kit.
- Connectors available without slots as a special at no upcharge. Contact Customer Support

| PRODUCT CODE | PRICE | SIZE/ H | INCHES W | WEIGHT LBS | VOL FT ³ |
|--------------|-------|---------|----------|------------|---------------------|
| EVP6VPA342 | 247 | 30 | 3.65 | 18.50 | 0.550 |
| EVP6VPA348 | 276 | 42 | 3.65 | 20.50 | 0.700 |
| EVP6VPA354 | 313 | 48 | 3.65 | 24.50 | 1.050 |
| EVP6VPA366 | 361 | 54 | 3.65 | 30.20 | 1.400 |

EVP4CEPS2 • Two Way 45° Corner Post Extension - Slotted

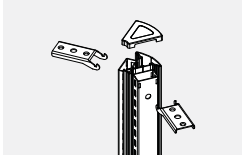

- Used to connect two panel extension modules of equal height.
- Provides slotted support up to 66" high for worksurfaces and hang-on storage components.
- Includes corner extension post, two slotted connectors and connecting hardware.

| PRODUCT CODE | PRICE | SIZE/ H | INCHES W | WEIGHT LBS | VOL FT ³ |
|--------------|-------|---------|----------|------------|---------------------|
| EVP4CEPS206 | 74 | 6 | 3.65 | 6 | 3.65 |
| EVP4CEPS212 | 74 | 12 | 3.65 | 12 | 3.65 |
| EVP4CEPS218 | 115 | 18 | 3.65 | 18 | 3.65 |
| EVP4CEPS224 | 115 | 24 | 3.65 | 24 | 3.65 |

EVP4CEP2 • Two Way 45° Corner Post Extension - Non Slotted

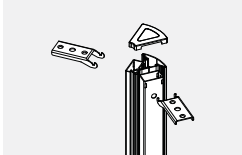

- Used to connect two panel extension modules of equal height.
- Includes corner extension post, two non-slotted connectors and connecting hardware.

| PRODUCT CODE | PRICE | SIZE/ H | INCHES W | WEIGHT LBS | VOL FT ³ |
|--------------|-------|---------|----------|------------|---------------------|
| EVP4CEP206 | 60 | 6 | 3.65 | 6 | 3.65 |
| EVP4CEP212 | 60 | 12 | 3.65 | 12 | 3.65 |
| EVP4CEP218 | 108 | 18 | 3.65 | 18 | 3.65 |
| EVP4CEP224 | 108 | 24 | 3.65 | 24 | 3.65 |

EVP6CEPSA • One Way 60° Corner Post Extension - Slotted - Aluminum

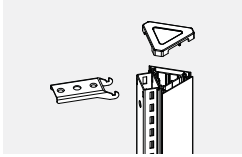

- Attached to a corner post at the end of run of panel extension modules.
- Provides slotted support up to 66" high for worksurfaces and hang-on storage components.
- Includes corner extension post, one slotted connectors, connecting hardware and trim kit.

| PRODUCT CODE | PRICE | SIZE/ H | INCHES W | WEIGHT LBS | VOL FT ³ |
|--------------|-------|---------|----------|------------|---------------------|
| EVP6CEPSA106 | 80 | 6 | 3.65 | 6 | 3.65 |
| EVP6CEPSA112 | 83 | 12 | 3.65 | 12 | 3.65 |
| EVP6CEPSA118 | 109 | 18 | 3.65 | 18 | 3.65 |
| EVP6CEPSA124 | 109 | 24 | 3.65 | 24 | 3.65 |

EVP6CEPA • One Way 60° Corner Post Extension - Non Slotted - Aluminum

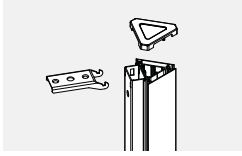

- Attached to a corner post at the end of run of panel extension modules.
- Includes corner extension post, one non-slotted connectors, connecting hardware and trim kit.

| PRODUCT CODE | PRICE | SIZE/ H | INCHES W | WEIGHT LBS | VOL FT ³ |
|--------------|-------|---------|----------|------------|---------------------|
| EVP6CEPA106 | 61 | 6 | 3.65 | 6 | 3.65 |
| EVP6CEPA112 | 65 | 12 | 3.65 | 12 | 3.65 |
| EVP6CEPA118 | 88 | 18 | 3.65 | 18 | 3.65 |
| EVP6CEPA124 | 88 | 24 | 3.65 | 24 | 3.65 |

EVP6CEPSA2 • Two Way 60° Corner Post Extension - Slotted - Aluminum

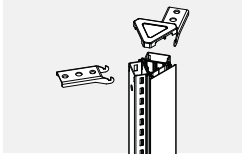

- Used to connect two panel extension modules of equal height.
- Provides slotted support up to 66" high for worksurfaces and hang-on storage components.
- Includes corner extension post, two non-slotted connectors, connecting hardware and trim kit.

| PRODUCT CODE | PRICE | SIZE/ H | INCHES W | WEIGHT LBS | VOL FT ³ |
|--------------|-------|---------|----------|------------|---------------------|
| EVP6CEPSA206 | 88 | 6 | 3.65 | 6 | 3.65 |
| EVP6CEPSA212 | 88 | 12 | 3.65 | 12 | 3.65 |
| EVP6CEPSA218 | 136 | 18 | 3.65 | 18 | 3.65 |
| EVP6CEPSA224 | 136 | 24 | 3.65 | 24 | 3.65 |

EVP6CEPA2 • Two Way 60° Corner Post Extension - Non Slotted - Aluminum

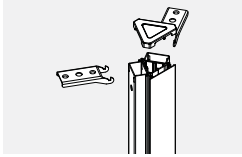

- Used to connect two panel extension modules of equal height.
- Includes corner extension post, two non-slotted connectors, connecting hardware and trim kit.

| PRODUCT CODE | PRICE | SIZE/ H | INCHES W | WEIGHT LBS | VOL FT ³ |
|--------------|-------|---------|----------|------------|---------------------|
| EVP6CEPA206 | 72 | 6 | 3.65 | 6 | 3.65 |
| EVP6CEPA212 | 81 | 12 | 3.65 | 12 | 3.65 |
| EVP6CEPA218 | 116 | 18 | 3.65 | 18 | 3.65 |
| EVP6CEPA224 | 116 | 24 | 3.65 | 24 | 3.65 |

EVP6CEPS3 • Three Way 60° Corner Post Extension - Slotted

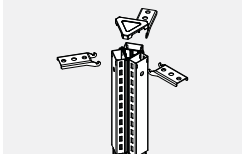

- Used to connect two panel extension modules of equal height.
- Provides slotted support up to 66" high for worksurfaces and hang-on storage components.
- Includes corner extension post, two slotted connectors and connecting hardware

| PRODUCT CODE | PRICE | SIZE/ H | INCHES W | WEIGHT LBS | VOL FT ³ |
|--------------|-------|---------|----------|------------|---------------------|
| EVP6CEPS306 | 89 | 6 | 3.65 | 6 | 3.65 |
| EVP6CEPS312 | 89 | 12 | 3.65 | 12 | 3.65 |
| EVP6CEPS318 | 139 | 18 | 3.65 | 18 | 3.65 |
| EVP6CEPS324 | 139 | 24 | 3.65 | 24 | 3.65 |

EVP6CEP3 • Three Way 60° Corner Post Extension - Non Slotted

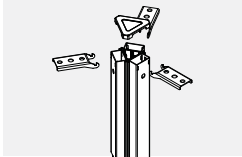

- Used to connect two panel extension modules of equal height.
- Includes corner extension post, two non-slotted connectors and connecting hardware.

| PRODUCT CODE | PRICE | SIZE/ H | INCHES W | WEIGHT LBS | VOL FT ³ |
|--------------|-------|---------|----------|------------|---------------------|
| EVP6CEP306 | 69 | 6 | 3.65 | 6 | 3.65 |
| EVP6CEP312 | 69 | 12 | 3.65 | 12 | 3.65 |
| EVP6CEP318 | 112 | 18 | 3.65 | 18 | 3.65 |
| EVP6CEP324 | 112 | 24 | 3.65 | 24 | 3.65 |

EVPVTFA • Flat Trim - Aluminum

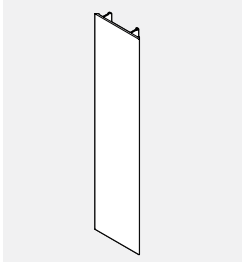

- Finishes exposed faces of one way, two way, three way and inline posts.
- For reconfiguration and replacement use only.

| PRODUCT CODE | PRICE | SIZE/ H | INCHES W | WEIGHT LBS | VOL FT ³ |
|--------------|-------|---------|----------|------------|---------------------|
| EVPVTFA30 | 16 | 29.125 | 2.875 | 0.39 | 0.05 |
| EVPVTFA36 | 16 | 35.125 | 2.875 | 0.44 | 0.06 |
| EVPVTFA42 | 23 | 41.125 | 2.875 | 0.56 | 0.07 |
| EVPVTFA48 | 24 | 47.125 | 2.875 | 0.62 | 0.08 |
| EVPVTFA54 | 25 | 53.125 | 2.875 | 0.75 | 0.09 |
| EVPVTFA66 | 27 | 65.125 | 2.875 | 0.86 | 0.12 |
| EVPVTFA72 | 29 | 71.125 | 2.875 | 0.92 | 0.12 |
| EVPVTFA78 | 30 | 77.125 | 2.875 | 0.97 | 0.12 |
| EVPVTFA84 | 31 | 83.125 | 2.875 | 1.09 | 0.14 |
| EVPVTFA90 | 31 | 89.125 | 2.875 | 1.14 | 0.15 |
| EVPVTFA96 | 33 | 95.125 | 2.875 | 1.19 | 0.21 |

EVPVTFEA • Flat Variable Height Extension Trim - Aluminum



- Finishes exposed faces of one way, two way, three way and inline post extensions.
- For reconfiguration and replacement use only.

| PRODUCT CODE | PRICE | SIZE/ H | INCHES W | WEIGHT LBS | VOL FT ³ |
|--------------|-------|---------|----------|------------|---------------------|
| EVPVTFEA06 | 12 | 6.375 | 2.875 | 0.12 | 0.01 |
| EVPVTFEA12 | 13 | 12.375 | 2.875 | 0.16 | 0.02 |
| EVPVTFEA18 | 14 | 18.375 | 2.875 | 0.28 | 0.03 |
| EVPVTFEA24 | 14 | 24.375 | 2.875 | 0.32 | 0.04 |
| EVPVTFEA30 | 16 | 30.375 | 2.875 | 0.36 | 0.05 |
| EVPVTFEA36 | 21 | 36.375 | 2.875 | 0.40 | 0.06 |
| EVPVTFEA42 | 23 | 42.375 | 2.875 | 0.44 | 0.07 |
| EVPVTFEA48 | 24 | 48.375 | 2.875 | 0.48 | 0.08 |
| EVPVTFEA54 | 25 | 54.375 | 2.875 | 0.52 | 0.09 |
| EVPVTFEA66 | 27 | 66.375 | 2.875 | 0.56 | 0.10 |
| EVPVTFEA78 | 30 | 78.375 | 2.875 | 0.64 | 0.12 |
| EVPVTFEA90 | 31 | 90.375 | 2.875 | 0.72 | 0.14 |

EVPTVA • Panel Trim Variable Height - Aluminum



- Attaches to the exposed end of the taller panel when 2 panels of different height meet in straight run.
- Must be ordered separately.

| PRODUCT CODE | PRICE | SIZE/ H | INCHES W | WEIGHT LBS | VOL FT ³ |
|--------------|-------|---------|----------|------------|---------------------|
| EVPTVA06 | 23 | 5.621 | 2.875 | 0.10 | 0.03 |
| EVPTVA12 | 26 | 11.621 | 2.875 | 0.20 | 0.03 |
| EVPTVA18 | 34 | 18.621 | 2.875 | 0.22 | 0.04 |
| EVPTVA24 | 40 | 23.621 | 2.875 | 0.20 | 0.10 |
| EVPTVA30 | 53 | 29.621 | 2.875 | 0.20 | 0.15 |
| EVPTVA36 | 61 | 35.621 | 2.875 | 0.30 | 0.20 |

EVPERTA • End of Run Trim - Aluminum



- Finishes the exposed connector at the end of a run of panels.
- Slotted connector not included.
- For reconfiguration and replacement use only.

| PRODUCT CODE | PRICE | SIZE/ H | INCHES W | WEIGHT LBS | VOL FT ³ |
|--------------|-------|---------|----------|------------|---------------------|
| EVPERTA30 | 54 | 28.815 | 2.875 | 1.00 | 0.65 |
| EVPERTA42 | 64 | 40.815 | 2.875 | 1.40 | 0.70 |
| EVPERTA48 | 68 | 46.815 | 2.875 | 1.60 | 0.90 |
| EVPERTA54 | 78 | 52.815 | 2.875 | 1.80 | 0.95 |
| EVPERTA66 | 90 | 64.815 | 2.875 | 2.20 | 0.98 |
| EVPERTA78 | 97 | 76.815 | 2.875 | 1.12 | 0.15 |
| EVPERTA84 | 106 | 82.815 | 2.875 | 1.20 | 0.16 |
| EVPERTA90 | 106 | 88.815 | 2.875 | 1.29 | 0.18 |

EVPTEA • Panel Extension Trim - Aluminum



- Attaches to bottom of exposed end of panel to provide extension for End-of-Run trim when using panel extensions.
- Does not include slotted connector or connecting hardware.

| PRODUCT CODE | PRICE | SIZE/ H | INCHES W | WEIGHT LBS | VOL FT ³ |
|--------------|-------|---------|----------|------------|---------------------|
| EVPTEA06 | 23 | 6 | 2.875 | 0.08 | 0.03 |
| EVPTEA12 | 26 | 12 | 2.875 | 0.10 | 0.03 |
| EVPTEA18 | 34 | 18 | 2.875 | 0.12 | 0.03 |
| EVPTEA24 | 40 | 24 | 2.875 | 0.20 | 0.60 |

EVPUETA12 • Upmount Extension Trim - Aluminum

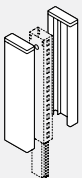

- Attaches to the Upmount Extension Connector EVPUECSA12 or to an Inline Connector EVPVC66 66" high.
- Used to finish the exposed Upmount Extension Connector on both sides.
- Priced in pairs.

| PRODUCT CODE | PRICE | SIZE/ H | INCHES W | WEIGHT LBS | VOL FT ³ |
|--------------|-------|---------|----------|------------|---------------------|
| EVPUETA12 | 40 | 12 | 2.875 | 0.20 | 0.03 |

EVPUETA66 • End of Line Trim for Raised Storage – Aluminum

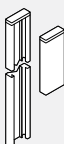

- Replaces 66" H end-of-stroke trim only.
- Includes EVPUETA12 Raised Storage Extension Trim and Raised Storage End Trim.
- Trim must be used in conjunction with slotted fittings.

| PRODUCT CODE | PRICE | SIZE/ H | INCHES W | WEIGHT LBS | VOL FT ³ |
|--------------|-------|---------|----------|------------|---------------------|
| EVPUETA66 | 102 | 66 | 2.875 | 0.55 | 0.08 |

EVPIECH • 12 "h Channel for Center Mount Overhead



- 12" channel to attaches panel to the side of a pre-installed center mount overhead with screws.
- Includes 12 "h channel and connecting hardware.

| PRODUCT CODE | PRICE | SIZE/INCHES | | | WEIGHT LBS | VOL FT ³ |
|--------------|-------|-------------|---|---|------------|---------------------|
| | | H | W | D | | |
| EVPIECH12 | 38 | 12 | 3 | | 1.32 | 0.12 |

EVPTTA • Panel Top Trim Aluminum

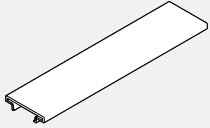

- Comes standard on all panels.
- Supplied at no charge.
- Field install no longer necessary.

| PRODUCT CODE | PRICE | SIZE/ INCHES | | WEIGHT LBS | VOL FT ³ |
|--------------|-------|--------------|-------|------------|---------------------|
| | | H | W | | |
| EVPTTA18 | 13 | 18 | 2.875 | 0.18 | 0.03 |
| EVPTTA24 | 16 | 24 | 2.875 | 0.22 | 0.04 |
| EVPTTA30 | 23 | 30 | 2.875 | 0.29 | 0.05 |
| EVPTTA36 | 25 | 36 | 2.875 | 0.30 | 0.06 |
| EVPTTA42 | 29 | 42 | 2.875 | 0.34 | 0.07 |
| EVPTTA48 | 34 | 48 | 2.875 | 0.38 | 0.08 |
| EVPTTA54 | 37 | 54 | 2.875 | 0.42 | 0.09 |
| EVPTTA60 | 43 | 60 | 2.875 | 0.46 | 0.10 |

EVPTNTA • Panel Top Notched Trim Aluminum

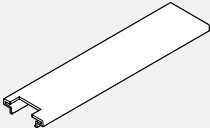

- Comes standard on all panels.
- Used when connecting a lower panel to a higher panel.
- To be used when shipping new panels with aluminum trim.
- Supplied at no charge when using panels in variable height configurations.
- Field install no longer necessary.

| PRODUCT CODE | PRICE | SIZE/ INCHES | | WEIGHT LBS | VOL FT ³ |
|--------------|-------|--------------|-------|------------|---------------------|
| | | H | W | | |
| EVPTNTA18 | 14 | 18 | 2.875 | 0.18 | 0.03 |
| EVPTNTA24 | 21 | 24 | 2.875 | 0.22 | 0.04 |
| EVPTNTA30 | 24 | 30 | 2.875 | 0.26 | 0.05 |
| EVPTNTA36 | 26 | 36 | 2.875 | 0.30 | 0.06 |
| EVPTNTA42 | 30 | 42 | 2.875 | 0.34 | 0.07 |
| EVPTNTA48 | 35 | 48 | 2.875 | 0.38 | 0.08 |
| EVPTNTA54 | 38 | 54 | 2.875 | 0.42 | 0.09 |
| EVPTNTA60 | 46 | 60 | 2.875 | 0.46 | 0.10 |

EVPTDNTA • Panel Top Double Notched Trim Aluminum

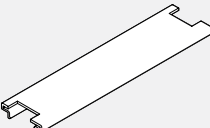

- Comes standard on all panels.
- Used when connecting a lower panel to two higher panels.
- To be used when shipping new panels with aluminum trim.
- Supplied at no charge when using panels in variable height configurations.
- Field install no longer necessary.

| PRODUCT CODE | PRICE | SIZE/ INCHES | | WEIGHT LBS | VOL FT ³ |
|--------------|-------|--------------|-------|------------|---------------------|
| | | H | W | | |
| EVPTDNTA18 | 16 | 18 | 2.875 | 0.18 | 0.03 |
| EVPTDNTA24 | 23 | 24 | 2.875 | 0.22 | 0.04 |
| EVPTDNTA30 | 25 | 30 | 2.875 | 0.26 | 0.05 |
| EVPTDNTA36 | 27 | 36 | 2.875 | 0.30 | 0.06 |
| EVPTDNTA42 | 31 | 42 | 2.875 | 0.34 | 0.07 |
| EVPTDNTA48 | 36 | 48 | 2.875 | 0.38 | 0.08 |
| EVPTDNTA54 | 40 | 54 | 2.875 | 0.42 | 0.09 |
| EVPTDNTA60 | 48 | 60 | 2.875 | 0.46 | 0.10 |

EVPTTCA - Aluminum Top Trim with Channel for Acoustic Grid

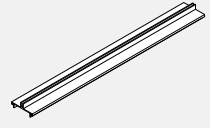

- Top trim with channel.
- Available in standard paint colors.
- Note: Trim can span inline connector, but not a post.

| PRODUCT CODE | PRICE | SIZE/INCHES | | | WEIGHT LBS | VOL FT ³ |
|--------------|-------|-------------|-------|------|------------|---------------------|
| | | H | W | D | | |
| EVPTTCA18 | 14 | 18 | 2 7/8 | 0.18 | 0.03 | |
| EVPTTCA24 | 17 | 24 | 2 7/8 | 0.22 | 0.04 | |
| EVPTTCA30 | 25 | 30 | 2 7/8 | 0.29 | 0.05 | |
| EVPTTCA36 | 28 | 36 | 2 7/8 | 0.30 | 0.06 | |
| EVPTTCA42 | 31 | 42 | 2 7/8 | 0.34 | 0.07 | |
| EVPTTCA48 | 36 | 48 | 2 7/8 | 0.38 | 0.08 | |
| EVPTTCA54 | 40 | 54 | 2 7/8 | 0.42 | 0.09 | |
| EVPTTCA60 | 47 | 60 | 2 7/8 | 0.46 | 0.10 | |
| EVPTTCA66 | 50 | 66 | 2 7/8 | 0.50 | 0.11 | |
| EVPTTCA72 | 54 | 72 | 2 7/8 | 0.54 | 0.12 | |
| EVPTTCA78 | 60 | 78 | 2 7/8 | 0.58 | 0.13 | |
| EVPTTCA84 | 65 | 84 | 2 7/8 | 0.62 | 0.14 | |
| EVPTTCA90 | 73 | 90 | 2 7/8 | 0.66 | 0.15 | |
| EVPTTCA96 | 84 | 96 | 2 7/8 | 0.70 | 0.16 | |

EVSC12 • Slot Cover



- Covers the slots of a slotted connector between panels as well as a corner post and end-of-run kit.
- Sold by the foot and cut on site by the installers.
- To order the required length, calculate the sum of the length of all inline connectors (including the posts and end-of-run kit) and multiply by 2.

| PRODUCT CODE | PRICE | SIZE/ INCHES | | WEIGHT VOL | |
|--------------|-------|--------------|---|------------|-----------------|
| | | H | W | LBS | FT ³ |
| EVSC12 | 5 | 12 | 1 | 0.01 | 0.01 |

EVECC310 • Wire Manager

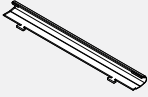

- Attaches to panels vertically between modules to provide enclosures for power or data cords.
- Sold in packages of 6.
- Can be overlapped to achieve required length.

| PRODUCT CODE | PRICE | SIZE/ INCHES | | WEIGHT VOL | |
|--------------|-------|--------------|---|------------|-----------------|
| | | H | W | LBS | FT ³ |
| EVECC310 | 40 | 10 | 1 | 0.01 | 0.01 |

EVHLPF01 • Low Profile Foot

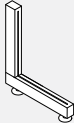

- Used to provide additional support to panel run without adding panels.
- Connects to inline connector or end of run at base of panels.

| PRODUCT CODE | PRICE | SIZE/ INCHES | | | WEIGHT VOL | |
|--------------|-------|--------------|----|---|------------|-----------------|
| | | H | W | D | LBS | FT ³ |
| EVHLPF01 | 100 | 11 | 11 | 1 | 2.6 | 0.07 |

EVCLVAR • Connector Variable Height Clamp

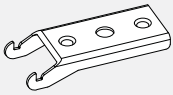

- Used for connecting two panels of variable height.

| PRODUCT CODE | PRICE | SIZE/ INCHES | | | WEIGHT VOL | |
|--------------|-------|--------------|---|---|------------|-----------------|
| | | H | W | D | LBS | FT ³ |
| EVCLVAR | 9 | | | | 0.5 | 0.01 |

EVPIECBS • Bridge Panel Inline Extension Connector



- Connects bridge panel to inline extension connector.
- Includes one bridge extension connector and connecting hardware.

| PRODUCT CODE | PRICE | SIZE/INCHES | | | WEIGHT VOL | | |
|--------------|-------|-------------|----|---|------------|-----------------|------|
| | | H | W | D | LBS | FT ³ | |
| EVPIECBS06 | 29 | 31 | 6 | 3 | 3 | 1.00 | 0.06 |
| EVPIECBS12 | 29 | 31 | 12 | 3 | 3 | 2.00 | 0.12 |
| EVPIECBS18 | 34 | 37 | 18 | 3 | 3 | 3.00 | 0.18 |
| EVPIECBS24 | 34 | 37 | 24 | 3 | 3 | 4.00 | 0.24 |

EVPEERBSA • Bridge Panel End of Run Extension Connector - Aluminum Trim



- Connects at end of run of bridge panel and can attach panel to fixed wall.
- Adds 1" to width of panel run.
- Provides slotted support for worksurfaces and hang on components up to 66" high.
- Includes one slotted bridge extension connector and connecting hardware and trim kit.

| PRODUCT CODE | PRICE | SIZE/INCHES | | | WEIGHT VOL | | |
|--------------|-------|-------------|----|---|------------|-----------------|------|
| | | H | W | D | LBS | FT ³ | |
| EVPEERBSA06 | 34 | | 6 | 3 | 3 | 1.00 | 0.06 |
| EVPEERBSA12 | 34 | | 12 | 3 | 3 | 2.00 | 0.12 |
| EVPEERBSA18 | 52 | | 18 | 3 | 3 | 3.00 | 0.18 |
| EVPEERBSA24 | 52 | | 24 | 3 | 3 | 4.00 | 0.24 |

EVPICBS • Bridge Panel Inline Connector without Aluminum Insert



- Connects two bridge panel to inline connector.
- Inline connector in middle between two bridge panels, above opening, using double clamp at bottom.
- Includes one bridge extension connector without aluminum insert and connecting hardware.

| PRODUCT CODE | PRICE | SIZE/INCHES | | | WEIGHT VOL | | |
|--------------|-------|-------------|----|---|------------|-----------------|------|
| | | H | W | D | LBS | FT ³ | |
| EVPICBS06 | 32 | | 6 | 3 | 3 | 1.00 | 0.06 |
| EVPICBS12 | 32 | | 12 | 3 | 3 | 2.00 | 0.12 |
| EVPICBS18 | 38 | | 18 | 3 | 3 | 3.00 | 0.18 |
| EVPICBS24 | 38 | | 24 | 3 | 3 | 4.00 | 0.24 |

EVPCEPB1 • Bridge Panel Corner Extension Post 1-way



- Connects at end of a run of extension modules.
- Post and connecting hardware add 3.25" to power beam run.
- Includes one extension post, one slotted extension connectors for bridge panel, connecting hardware and trim kit.

| PRODUCT CODE | PRICE | SIZE/INCHES | | | WEIGHT LBS | VOL FT ³ |
|--------------|-------|-------------|---|---|------------|---------------------|
| | | H | W | D | | |
| EVPCEPBSA106 | 75 | 6 | 3 | 3 | 2.00 | 0.07 |
| EVPCEPBSA112 | 75 | 12 | 3 | 3 | 4.00 | 0.14 |
| EVPCEPBSA118 | 97 | 18 | 3 | 3 | 6.00 | 0.21 |
| EVPCEPBSA124 | 97 | 24 | 3 | 3 | 8.00 | 0.14 |

EVPCEPB4 • Bridge Panel Corner Extension Post 4-way



- Connects four bridge panels in 90 degree configuration.
- Post and connecting hardware add 3.25" to power beam run.
- Includes one extension post, four one slotted extension connectors for bridge panel, connecting hardware and trim kit.

| PRODUCT CODE | PRICE | SIZE/INCHES | | | WEIGHT LBS | VOL FT ³ |
|--------------|-------|-------------|---|---|------------|---------------------|
| | | H | W | D | | |
| EVPCEPBS406 | 100 | 6 | 3 | 3 | 4.00 | 0.09 |
| EVPCEPBS412 | 100 | 12 | 3 | 3 | 8.00 | 0.18 |
| EVPCEPBS418 | 157 | 18 | 3 | 3 | 12.00 | 0.27 |
| EVPCEPBS424 | 157 | 24 | 3 | 3 | 16.00 | 0.36 |

EVPCEPB3 • Bridge Panel Corner Extension Post 3-way

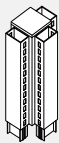

- Connects three bridge panels in 90 degree configuration.
- Post and connecting hardware add 3.25" to power beam run.
- Includes one extension post, three one slotted extension connectors for bridge panel, connecting hardware and trim kit.

| PRODUCT CODE | PRICE | SIZE/INCHES | | | WEIGHT LBS | VOL FT ³ |
|--------------|-------|-------------|---|---|------------|---------------------|
| | | H | W | D | | |
| EVPCEPBSA306 | 89 | 6 | 3 | 3 | 3.00 | 0.08 |
| EVPCEPBSA312 | 89 | 12 | 3 | 3 | 6.00 | 0.16 |
| EVPCEPBSA318 | 139 | 18 | 3 | 3 | 9.00 | 0.24 |
| EVPCEPBSA324 | 139 | 24 | 3 | 3 | 12.00 | 0.32 |

EVPCEPB2 • Bridge Panel Corner Extension Post 2-way

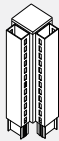

- Connects two bridge panels in 90 degree configuration.
- Post and connecting hardware add 3.25" to power beam run.
- Includes one extension post, two one slotted extension connectors for bridge panel, connecting hardware and trim kit.

| PRODUCT CODE | PRICE | SIZE/INCHES | | | WEIGHT LBS | VOL FT ³ |
|--------------|-------|-------------|---|---|------------|---------------------|
| | | H | W | D | | |
| EVPCEPBSA206 | 76 | 6 | 3 | 3 | 2.00 | 0.07 |
| EVPCEPBSA212 | 76 | 12 | 3 | 3 | 4.00 | 0.14 |
| EVPCEPBSA218 | 122 | 18 | 3 | 3 | 6.00 | 0.21 |
| EVPCEPBSA224 | 122 | 24 | 3 | 3 | 8.00 | 0.14 |

EVPCEIPBSA2 • Bridge Panel Inline 2-way Post Extension

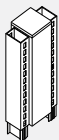

- Connects two bridge panels in straight run.
- Post and connecting hardware add 3.25" to power beam run.
- Includes one extension post, two slotted extension connectors for bridge panel, connecting hardware and trim kit.

| PRODUCT CODE | PRICE | SIZE/INCHES | | | WEIGHT LBS | VOL FT ³ |
|---------------|-------|-------------|---|---|------------|---------------------|
| | | H | W | D | | |
| EVPCEIPBSA206 | 76 | 6 | 3 | 3 | 2.00 | 0.07 |
| EVPCEIPBSA212 | 76 | 12 | 3 | 3 | 4.00 | 0.14 |
| EVPCEIPBSA218 | 122 | 18 | 3 | 3 | 6.00 | 0.21 |
| EVPCEIPBSA224 | 122 | 24 | 3 | 3 | 8.00 | 0.14 |

NO RACEWAY PANELS • TECHNICAL INFORMATION

- Evolve panels are 2 7/8" thick. They are available in four (5) basic heights: 30", 42", 48", 54" and 66" and eight (8) widths: 18" to 60" in 6" increments.
- Individual fabric covered acoustic modules incorporated into a rigid steel frame.
- Opposite side of each module may have a different fabric within the same grade at no upcharge.
- If different grades of fabric are used on one panel, the entire panel must be priced at highest grade.
- A low profile top cap is included.
- No panel creep.
- 12" high and 24" high modules of 2 types (fabric and laminate) are available for field installation. Contact your Customer Service Representative.
- Laminate for laminate panels cannot be replaced in the field, complete module must be ordered.

PANELS • GUIDELINES FOR ORDERING PRODUCT

The price list uses a numbering system with meaningful alphanumeric characters to create a simple-to-understand product number. This makes specifying the product much easier and more accurate.

EXAMPLE OF PANEL CODE

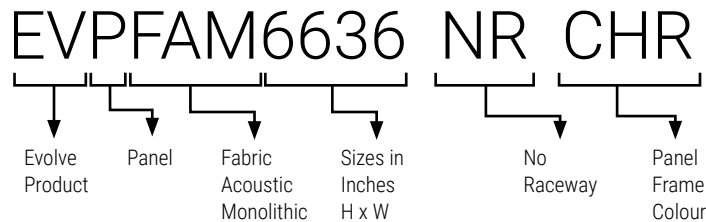

| | | |
|----|------|----------------------------|
| I1 | AN50 | Inside Fabric Position #1 |
| I2 | AN50 | Inside Fabric Position #2 |
| I3 | AN50 | Inside Fabric Position #3 |
| O1 | BE21 | Outside Fabric Position #1 |
| O2 | BE21 | Outside Fabric Position #2 |
| O3 | BE21 | Outside Fabric Position #3 |

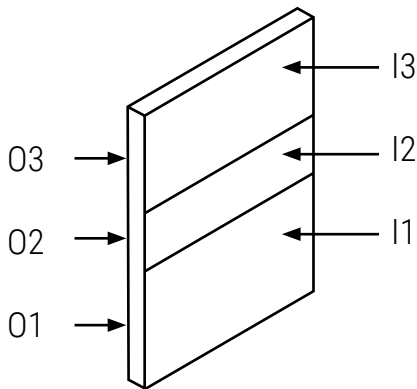

HOW TO SPECIFY

- Specify Evolve panel type and size by code.
- Specify panel frame finish - ie. CHR (Charcoal).
- Specify all necessary panel fabric options.

NOTE: If different grades of fabric are used on one panel, the entire panel must be priced out at the higher grade.

EVPFA-NR • Segmented (No Raceway) Panel

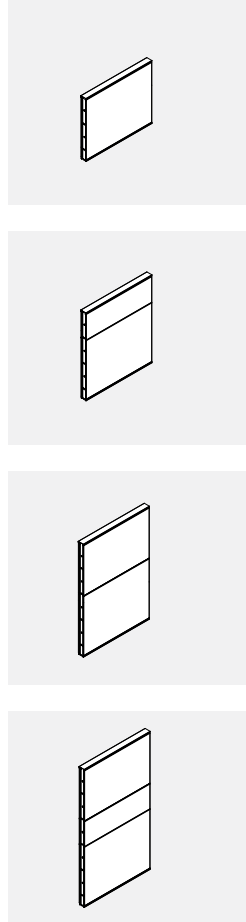

- Segmented (No Raceway) panel incorporates fabric modules within steel frame.
- There is no base raceway in No Raceway Panels to accommodate electric.
- **No Raceway connectors to be used.**
- Fabric covered modules are tackable and acoustical.
- Each side of fabric module may have different fabric within the same grade at no charge.
- If different grades of fabric are used, the entire module must be price at highest grade.
- Aluminum low profile top and bottom cap is included.
- Stackability: Evolve panels can be increased in height in 6", 12", 24" increments. See module listing for part numbers.

| PRODUCT CODE | PRICE | | SIZE/ INCHES | | | WEIGHT | VOL |
|--------------|-------|------|--------------|----|-------|--------|-----------------|
| | GR 1 | GR 2 | H | W | D | LBS | FT ³ |
| EVPFA3018NR | 305 | 317 | 30 | 18 | 2.875 | 15.38 | 1.23 |
| EVPFA3024NR | 318 | 372 | 30 | 24 | 2.875 | 18.20 | 1.63 |
| EVPFA3030NR | 352 | 372 | 30 | 30 | 2.875 | 21.76 | 2.00 |
| EVPFA3036NR | 378 | 401 | 30 | 36 | 2.875 | 24.80 | 2.38 |
| EVPFA3042NR | 408 | 434 | 30 | 42 | 2.875 | 26.49 | 2.76 |
| EVPFA3048NR | 451 | 482 | 30 | 48 | 2.875 | 32.00 | 3.13 |
| EVPFA3054NR | 486 | 520 | 30 | 54 | 2.875 | 35.31 | 3.51 |
| EVPFA3060NR | 522 | 562 | 30 | 60 | 2.875 | 38.20 | 3.89 |
| EVPFA4218NR | 338 | 354 | 42 | 18 | 2.875 | 20.58 | 1.71 |
| EVPFA4224NR | 354 | 382 | 42 | 24 | 2.875 | 24.60 | 2.31 |
| EVPFA4230NR | 412 | 443 | 42 | 30 | 2.875 | 29.35 | 2.81 |
| EVPFA4236NR | 446 | 482 | 42 | 36 | 2.875 | 35.60 | 3.38 |
| EVPFA4242NR | 509 | 548 | 42 | 42 | 2.875 | 39.29 | 3.92 |
| EVPFA4248NR | 548 | 593 | 42 | 48 | 2.875 | 43.20 | 4.45 |
| EVPFA4254NR | 607 | 657 | 42 | 54 | 2.875 | 47.52 | 4.98 |
| EVPFA4260NR | 665 | 721 | 42 | 60 | 2.875 | 51.60 | 5.52 |
| EVPFA4818NR | 363 | 385 | 48 | 18 | 2.875 | 23.98 | 2.19 |
| EVPFA4824NR | 397 | 431 | 48 | 24 | 2.875 | 27.80 | 2.94 |
| EVPFA4830NR | 452 | 490 | 48 | 30 | 2.875 | 33.15 | 3.62 |
| EVPFA4836NR | 505 | 550 | 48 | 36 | 2.875 | 37.40 | 4.31 |
| EVPFA4842NR | 570 | 625 | 48 | 42 | 2.875 | 40.69 | 4.99 |
| EVPFA4848NR | 634 | 694 | 48 | 48 | 2.875 | 48.20 | 5.67 |
| EVPFA4854NR | 691 | 758 | 48 | 54 | 2.875 | 52.92 | 6.35 |
| EVPFA4860NR | 740 | 814 | 48 | 60 | 2.875 | 57.40 | 7.03 |
| EVPFA5418NR | 363 | 385 | 54 | 18 | 2.875 | 23.98 | 2.19 |
| EVPFA5424NR | 397 | 431 | 54 | 24 | 2.875 | 27.80 | 2.94 |
| EVPFA5430NR | 452 | 490 | 54 | 30 | 2.875 | 33.15 | 3.62 |
| EVPFA5436NR | 505 | 550 | 54 | 36 | 2.875 | 37.40 | 4.31 |
| EVPFA5442NR | 570 | 625 | 54 | 42 | 2.875 | 40.69 | 4.99 |
| EVPFA5448NR | 634 | 694 | 54 | 48 | 2.875 | 48.20 | 5.67 |
| EVPFA5454NR | 691 | 758 | 54 | 54 | 2.875 | 52.92 | 6.35 |
| EVPFA5460NR | 740 | 814 | 54 | 60 | 2.875 | 57.40 | 7.03 |
| EVPFA6618NR | 455 | 486 | 66 | 18 | 2.875 | 29.98 | 2.68 |
| EVPFA6624NR | 353 | 536 | 66 | 24 | 2.875 | 35.00 | 3.58 |
| EVPFA6630NR | 544 | 593 | 66 | 30 | 2.875 | 41.54 | 4.40 |
| EVPFA6636NR | 638 | 697 | 66 | 36 | 2.875 | 49.00 | 5.23 |
| EVPFA6642NR | 722 | 790 | 66 | 42 | 2.875 | 54.29 | 6.06 |
| EVPFA6648NR | 774 | 850 | 66 | 48 | 2.875 | 60.20 | 6.08 |
| EVPFA6654NR | 842 | 926 | 66 | 54 | 2.875 | 65.93 | 7.70 |
| EVPFA6660NR | 909 | 1001 | 66 | 60 | 2.875 | 71.60 | 8.53 |

EVPFAM-NR • Monolithic (No Raceway) Panel

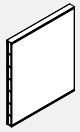

- Monolithic (No Raceway) panel incorporates fabric modules within steel frame.
- There is no base raceway in No Raceway Panels to accommodate electric.
- **No Raceway connectors to be used.**
- Fabric covered modules are tackable and acoustical.
- Each side of fabric module may have different fabric within the same grade at no charge.
- If different grades of fabric are used, the entire module must be price at highest grade.
- Aluminum low profile top and bottom cap is included.
- Stackability: Evolve panels can be increased in height in 6", 12", 24" increments. See module listing for part numbers.

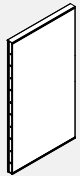
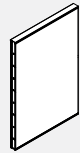
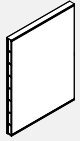

| PRODUCT CODE | PRICE | | SIZE/ INCHES | | | WEIGHT | VOL |
|--------------|-------|------|--------------|----|-------|--------|-----------------|
| | GR 1 | GR 2 | H | W | D | LBS | FT ³ |
| EVPFAM4218NR | 333 | 364 | 42 | 18 | 2.875 | 20.58 | 1.71 |
| EVPFAM4224NR | 355 | 394 | 42 | 24 | 2.875 | 23.40 | 2.31 |
| EVPFAM4230NR | 406 | 450 | 42 | 30 | 2.875 | 26.96 | 2.85 |
| EVPFAM4236NR | 436 | 487 | 42 | 36 | 2.875 | 30.00 | 3.38 |
| EVPFAM4242NR | 483 | 543 | 42 | 42 | 2.875 | 31.69 | 3.92 |
| EVPFAM4248NR | 525 | 593 | 42 | 48 | 2.875 | 37.20 | 4.45 |
| EVPFAM4254NR | 579 | 653 | 42 | 54 | 2.875 | 40.51 | 4.98 |
| EVPFAM4260NR | 629 | 711 | 42 | 60 | 2.875 | 43.40 | 5.52 |
| EVPFAM4818NR | 340 | 371 | 48 | 18 | 2.875 | 21.38 | 1.92 |
| EVPFAM4824NR | 374 | 410 | 48 | 24 | 2.875 | 24.40 | 2.62 |
| EVPFAM4830NR | 431 | 476 | 48 | 30 | 2.875 | 27.76 | 3.23 |
| EVPFAM4836NR | 469 | 520 | 48 | 36 | 2.875 | 30.80 | 3.85 |
| EVPFAM4842NR | 524 | 584 | 48 | 42 | 2.875 | 32.49 | 4.45 |
| EVPFAM4848NR | 572 | 637 | 48 | 48 | 2.875 | 37.80 | 5.06 |
| EVPFAM4854NR | 630 | 704 | 48 | 54 | 2.875 | 41.31 | 5.66 |
| EVPFAM4860NR | 684 | 767 | 48 | 60 | 2.875 | 44.20 | 6.27 |
| EVPFAM5418NR | 342 | 374 | 54 | 18 | 2.875 | 24.58 | 2.19 |
| EVPFAM5424NR | 376 | 415 | 54 | 24 | 2.875 | 27.40 | 2.94 |
| EVPFAM5430NR | 437 | 482 | 54 | 30 | 2.875 | 30.96 | 3.62 |
| EVPFAM5436NR | 486 | 541 | 54 | 36 | 2.875 | 34.00 | 4.31 |
| EVPFAM5442NR | 545 | 605 | 54 | 42 | 2.875 | 35.69 | 4.99 |
| EVPFAM5448NR | 591 | 661 | 54 | 48 | 2.875 | 41.20 | 5.67 |
| EVPFAM5454NR | 651 | 728 | 54 | 54 | 2.875 | 44.51 | 6.35 |
| EVPFAM5460NR | 712 | 796 | 54 | 60 | 2.875 | 47.40 | 7.03 |
| EVPFAM6618NR | 425 | 455 | 66 | 18 | 2.875 | 27.58 | 2.68 |
| EVPFAM6624NR | 463 | 503 | 66 | 24 | 2.875 | 30.40 | 3.58 |
| EVPFAM6630NR | 524 | 573 | 66 | 30 | 2.875 | 33.96 | 4.40 |
| EVPFAM6636NR | 608 | 663 | 66 | 36 | 2.875 | 37.00 | 5.23 |
| EVPFAM6642NR | 684 | 743 | 66 | 42 | 2.875 | 38.69 | 6.06 |
| EVPFAM6648NR | 743 | 811 | 66 | 48 | 2.875 | 44.20 | 6.88 |
| EVPFAM6654NR | 826 | 900 | 66 | 54 | 2.875 | 47.51 | 7.70 |
| EVPFAM6660NR | 909 | 991 | 66 | 60 | 2.875 | 50.40 | 8.53 |
| EVPFAM9018NR | 752 | 805 | 90 | 18 | 2.875 | 38.18 | 3.43 |
| EVPFAM9024NR | 810 | 873 | 90 | 24 | 2.875 | 42.72 | 4.58 |
| EVPFAM9030NR | 900 | 985 | 90 | 30 | 2.875 | 47.99 | 5.65 |
| EVPFAM9036NR | 1047 | 1139 | 90 | 36 | 2.875 | 52.75 | 6.73 |

EVPH1S-NR • Laminate (No Raceway) Panel Single Sided

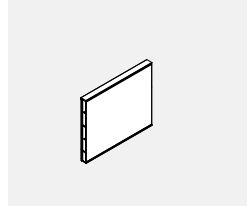

- Laminate (No Raceway) panel incorporates single sided laminate modules within steel frame.
- Opposite side is fabric covered.
- Laminate faces on all modules provide durable, washable surface on Single sided of the panel.
- Available in high pressure laminate only.
- If wood grain is selected, grain runs horizontally.
- There is no base raceway in No Raceway Panels to accommodate electric.

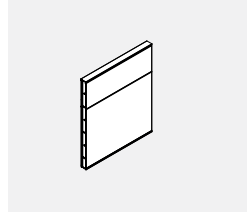

- **No Raceway connectors to be used.**
- If different grades of fabric are used, the entire module must be price at highest grade.
- Aluminum low profile top and bottom cap is included.
- Stackability: Evolve panels can be increased in height in 6", 12", 24" increments. See module listing for part numbers.

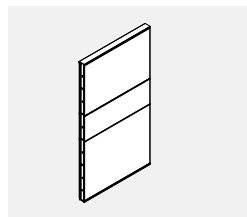
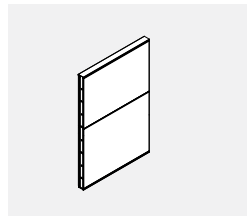

| PRODUCT CODE | PRICE | | SIZE/ INCHES | | | WEIGHT | VOL |
|--------------|-------|------|--------------|----|-------|--------|-----------------|
| | GR 1 | GR 2 | H | W | D | LBS | FT ³ |
| EVPH1S3018NR | 373 | 380 | 30 | 18 | 2.875 | 15.88 | 1.23 |
| EVPH1S3024NR | 448 | 456 | 30 | 24 | 2.875 | 18.70 | 1.63 |
| EVPH1S3030NR | 523 | 535 | 30 | 30 | 2.875 | 22.26 | 2.00 |
| EVPH1S3036NR | 593 | 610 | 30 | 36 | 2.875 | 24.85 | 2.38 |
| EVPH1S3042NR | 676 | 689 | 30 | 42 | 2.875 | 26.99 | 2.76 |
| EVPH1S3048NR | 732 | 747 | 30 | 48 | 2.875 | 32.05 | 3.13 |
| EVPH1S3054NR | 814 | 830 | 30 | 54 | 2.875 | 35.81 | 3.51 |
| EVPH1S3060NR | 891 | 908 | 30 | 60 | 2.875 | 38.07 | 3.89 |
| EVPH1S4218NR | 443 | 482 | 42 | 18 | 2.875 | 21.38 | 1.71 |
| EVPH1S4224NR | 530 | 546 | 42 | 24 | 2.875 | 22.13 | 2.31 |
| EVPH1S4230NR | 619 | 634 | 42 | 30 | 2.875 | 30.15 | 2.81 |
| EVPH1S4236NR | 713 | 733 | 42 | 36 | 2.875 | 36.40 | 3.38 |
| EVPH1S4242NR | 806 | 829 | 42 | 42 | 2.875 | 40.09 | 3.92 |
| EVPH1S4248NR | 879 | 903 | 42 | 48 | 2.875 | 44.00 | 4.45 |
| EVPH1S4254NR | 976 | 1001 | 42 | 54 | 2.875 | 48.32 | 4.98 |
| EVPH1S4260NR | 1068 | 1100 | 42 | 60 | 2.875 | 52.40 | 5.52 |
| EVPH1S5418NR | 522 | 537 | 54 | 18 | 2.875 | 24.98 | 2.19 |
| EVPH1S5424NR | 630 | 648 | 54 | 24 | 2.875 | 28.80 | 2.94 |
| EVPH1S5430NR | 741 | 761 | 54 | 30 | 2.875 | 34.15 | 3.62 |
| EVPH1S5436NR | 849 | 872 | 54 | 36 | 2.875 | 38.40 | 4.31 |
| EVPH1S5442NR | 960 | 987 | 54 | 42 | 2.875 | 41.69 | 4.99 |
| EVPH1S5448NR | 1050 | 1083 | 54 | 48 | 2.875 | 49.20 | 5.67 |
| EVPH1S5454NR | 1167 | 1201 | 54 | 54 | 2.875 | 53.92 | 6.35 |
| EVPH1S5460NR | 1284 | 1325 | 54 | 60 | 2.875 | 58.40 | 7.03 |
| EVPH1S6618NR | 648 | 665 | 66 | 18 | 2.875 | 31.29 | 2.68 |
| EVPH1S6624NR | 781 | 802 | 66 | 24 | 2.875 | 36.30 | 3.58 |
| EVPH1S6630NR | 911 | 937 | 66 | 30 | 2.875 | 42.84 | 4.40 |
| EVPH1S6636NR | 1052 | 1084 | 66 | 36 | 2.875 | 50.30 | 5.23 |
| EVPH1S6642NR | 1198 | 1233 | 66 | 42 | 2.875 | 55.59 | 6.06 |
| EVPH1S6648NR | 1303 | 1343 | 66 | 48 | 2.875 | 61.50 | 6.08 |
| EVPH1S6654NR | 1448 | 1494 | 66 | 54 | 2.875 | 67.23 | 7.70 |
| EVPH1S6660NR | 1595 | 1646 | 66 | 60 | 2.875 | 72.90 | 8.53 |

EVPH2S-NR • Laminate (No Raceway) Panel Double Sided

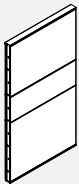
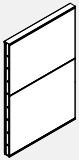
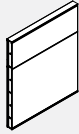
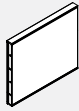

- Laminate (No Raceway) panel incorporates double sided laminate modules within steel frame
- Laminate faces on all modules provide durable, washable surface on both sides of the panel
- Available in high pressure laminate only
- If wood grain is selected, grain runs horizontally
- There is no base raceway in No Raceway Panels to accommodate electric
- **No Raceway connectors to be used.**
- Aluminum low profile top and bottom cap is included
- Stackability: Evolve panels can be increased in height in 6", 12", 24" increments. See module listing for part numbers.

| PRODUCT CODE | PRICE | SIZE/ INCHES | | | WEIGHT LBS | VOL FT ³ |
|--------------|-------|--------------|----|-------|------------|---------------------|
| | | H | W | D | | |
| EVPH2S3018NR | 417 | 30 | 18 | 2.875 | 16.38 | 1.23 |
| EVPH2S3024NR | 510 | 30 | 24 | 2.875 | 19.20 | 1.63 |
| EVPH2S3030NR | 604 | 30 | 30 | 2.875 | 22.76 | 2.00 |
| EVPH2S3036NR | 689 | 30 | 36 | 2.875 | 25.80 | 2.38 |
| EVPH2S3042NR | 785 | 30 | 42 | 2.875 | 27.49 | 2.76 |
| EVPH2S3048NR | 877 | 30 | 48 | 2.875 | 33.00 | 3.13 |
| EVPH2S3054NR | 972 | 30 | 54 | 2.875 | 36.31 | 3.51 |
| EVPH2S3060NR | 1052 | 30 | 60 | 2.875 | 39.20 | 3.89 |
| EVPH2S4218NR | 497 | 42 | 18 | 2.875 | 22.18 | 1.71 |
| EVPH2S4224NR | 604 | 42 | 24 | 2.875 | 26.20 | 2.31 |
| EVPH2S4230NR | 712 | 42 | 30 | 2.875 | 30.95 | 2.81 |
| EVPH2S4236NR | 827 | 42 | 36 | 2.875 | 37.20 | 3.38 |
| EVPH2S4242NR | 943 | 42 | 42 | 2.875 | 40.89 | 3.92 |
| EVPH2S4248NR | 1056 | 42 | 48 | 2.875 | 42.80 | 4.45 |
| EVPH2S4254NR | 1162 | 42 | 54 | 2.875 | 49.12 | 4.98 |
| EVPH2S4260NR | 1267 | 42 | 60 | 2.875 | 53.20 | 5.52 |
| EVPH2S5418NR | 581 | 54 | 18 | 2.875 | 25.98 | 2.19 |
| EVPH2S5424NR | 714 | 54 | 24 | 2.875 | 29.80 | 2.94 |
| EVPH2S5430NR | 849 | 54 | 30 | 2.875 | 35.15 | 3.62 |
| EVPH2S5436NR | 984 | 54 | 36 | 2.875 | 39.40 | 4.31 |
| EVPH2S5442NR | 1123 | 54 | 42 | 2.875 | 42.69 | 4.99 |
| EVPH2S5448NR | 1266 | 54 | 48 | 2.875 | 50.20 | 5.67 |
| EVPH2S5454NR | 1394 | 54 | 54 | 2.875 | 52.92 | 6.35 |
| EVPH2S5460NR | 1517 | 54 | 60 | 2.875 | 59.40 | 7.03 |
| EVPH2S6618NR | 732 | 66 | 18 | 2.875 | 32.58 | 2.68 |
| EVPH2S6624NR | 903 | 66 | 24 | 2.875 | 37.60 | 3.58 |
| EVPH2S6630NR | 1068 | 66 | 30 | 2.875 | 44.14 | 4.40 |
| EVPH2S6636NR | 1241 | 66 | 36 | 2.875 | 51.60 | 5.23 |
| EVPH2S6642NR | 1428 | 66 | 42 | 2.875 | 56.89 | 6.06 |
| EVPH2S6648NR | 1595 | 66 | 48 | 2.875 | 62.80 | 6.08 |
| EVPH2S6654NR | 1764 | 66 | 54 | 2.875 | 68.53 | 7.70 |
| EVPH2S6660NR | 1927 | 66 | 60 | 2.875 | 74.20 | 8.53 |

EVPXGT-NR • Fully Glazed (No Raceway) Panel

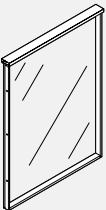

- **EVPXGTNR - Fully Glazed Monolithic No Raceway Panel.**
- There is no base raceway in No Raceway Panels to accommodate electric.
- No Raceway connectors to be used.
- Fully Glazed Monolithic No Raceway panel are incorporated in solid steel frame.
- Standard in clear (CLR).
- Frosted glass (FRST) 40% upcharge.
- Size 90"x36"W is maximum size allowed.
- Panel height to align with standard door height.
- Aluminum low profile top and bottom cap is included.

| PRODUCT CODE | PRICE | SIZE/ INCHES | | | WEIGHT LBS | VOL FT ³ |
|--------------|-------|--------------|----|-------|------------|---------------------|
| | | H | W | D | | |
| EVPXGT9018NR | 784 | 90 | 18 | 2.875 | 15.88 | 1.23 |
| EVPXGT9024NR | 895 | 90 | 24 | 2.875 | 18.70 | 1.63 |
| EVPXGT9030NR | 1016 | 90 | 30 | 2.875 | 22.26 | 2.00 |
| EVPXGT9036NR | 1100 | 90 | 36 | 2.875 | 24.85 | 2.38 |

EVPGTNR-NR • Fully Glazed Segmented (No Raceway) Panel

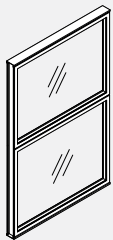

- **Fully Glazed Segmented No Raceway Panel with solid steel frame..**
- There is no base raceway in No Raceway Panels to accommodate electrical.
- No Raceway connectors to be used.
- Standard in clear (CLR).
- Frosted glass (FRST) 40% upcharge.
- Aluminum low profile top and bottom cap is included.

| PRODUCT CODE | PRICE | SIZE/ INCHES | | | WEIGHT LBS | VOL FT ³ |
|--------------|-------|--------------|----|-------|------------|---------------------|
| | | H | W | D | | |
| EVPGT4818NR | 625 | 48 | 18 | 2.875 | 35.19 | 2.19 |
| EVPGT4824NR | 765 | 48 | 24 | 2.875 | 49.76 | 2.94 |
| EVPGT4830NR | 846 | 48 | 30 | 2.875 | 52.08 | 3.62 |
| EVPGT4836NR | 925 | 48 | 36 | 2.875 | 64.54 | 4.31 |
| EVPGT4842NR | 1024 | 48 | 42 | 2.875 | 72.62 | 4.99 |
| EVPGT4848NR | 1143 | 48 | 48 | 2.875 | 78.11 | 5.67 |
| EVPGT4854NR | 1258 | 48 | 54 | 2.875 | 86.04 | 6.35 |
| EVPGT4860NR | 1372 | 48 | 60 | 2.875 | 94.09 | 7.03 |

EVPIC-NR • Inline Connector (No Raceway) Panel



- Connects two No Raceway panel in straight run.
- Provides slotted support for worksurfaces and hang on components.
- Includes one slotted connector with leveling glide and connecting hardware.
- Connectors available without slots, as a special at no extra charge. Contact customer support.

| PRODUCT CODE | PRICE | SIZE/INCHES | | | WEIGHT LBS | VOL FT ³ |
|--------------|-------|-------------|---|---|------------|---------------------|
| | | H | W | D | | |
| EVPIC30NR | 63 | 30 | 2 | | 3.30 | 0.05 |
| EVPIC42NR | 67 | 42 | 2 | | 4.60 | 0.07 |
| EVPIC48NR | 69 | 48 | 2 | | 5.25 | 0.07 |
| EVPIC54NR | 74 | 54 | 2 | | 5.90 | 0.09 |
| EVPIC66NR | 83 | 66 | 2 | | 7.20 | 0.10 |

EVVIC-NR • Inline Connector (No Raceway) Panel



- Connects two 90" H No Raceway panel in straight run.
- Includes one slotted connector with leveling glide and connecting hardware.
- Connectors are without slots.
- To be used only with 90" H NR Glazed Panels

| PRODUCT CODE | PRICE | SIZE/INCHES | | | WEIGHT LBS | VOL FT ³ |
|--------------|-------|-------------|---|---|------------|---------------------|
| | | H | W | D | | |
| EVVIC90NR | 117 | 90 | 2 | | 11.2 | 0.19 |

EVVVC-NR • Inline Variable Height Connector (No Raceway) Panel



- Connects two No Raceway panels of differing height in straight run.
- Connector must reference taller panel.
- Can be used for any variation of pane height.
- Variable height trim must be ordered separately (see EVPTVA).
- Provides slotted support for worksurfaces and hang on components.
- Includes one slotted connector with leveling glide and connecting hardware.
- Connectors available without slots, as a special at no extra charge. Contact customer support.

| PRODUCT CODE | PRICE | SIZE/INCHES | | | WEIGHT LBS | VOL FT ³ |
|--------------|-------|-------------|---|---|------------|---------------------|
| | | H | W | D | | |
| EVVVC42NR | 74 | 42 | 2 | | 4.60 | 0.07 |
| EVVVC48NR | 77 | 48 | 2 | | 5.25 | 0.07 |
| EVVVC54NR | 78 | 54 | 2 | | 5.90 | 0.09 |
| EVVVC66NR | 88 | 66 | 2 | | 7.20 | 0.10 |

EVPERA-NR • End of Run Post Kit for (No Raceway) Panel



- Connects at end of No Raceway panel and can attach to a panel to fixed wall.
- Adds 1" to width of panel run.
- Provides slotted support for worksurfaces and hang on components.
- Includes one slotted connector with leveling glide and connecting hardware and trim kit.
- Can be attached to face of another panel to provide off modular connection.
- Connectors available without slots, as a special at no extra charge. Contact customer support.

| PRODUCT CODE | PRICE | SIZE/INCHES | | | WEIGHT LBS | VOL FT ³ |
|--------------|-------|-------------|---|---|------------|---------------------|
| | | H | W | D | | |
| EVPERA30NR | 78 | 30 | 2 | | 3.30 | 0.07 |
| EVPERA42NR | 94 | 42 | 2 | | 4.60 | 0.10 |
| EVPERA48NR | 100 | 48 | 2 | | 5.25 | 0.10 |
| EVPERA54NR | 112 | 54 | 2 | | 5.90 | 0.18 |
| EVPERA66NR | 126 | 66 | 2 | | 7.20 | 0.22 |

EVPERA-NR • End of Run Post Kit for (No Raceway) Panel

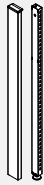

- Connects two 90" H No Raceway panel and can attach to a panel to fixed wall.
- Adds 1" width of panel run.
- Includes one slotted connector with leveling glide and connecting hardware and trim kit.
- Can be attached to face of another panel to provide off modular connection.
- Connectors are without slots.
- To be used only with 90" H NR Glazed Panels

| PRODUCT CODE | PRICE | SIZE/INCHES | | | WEIGHT LBS | VOL FT ³ |
|--------------|-------|-------------|---|---|------------|---------------------|
| | | H | W | D | | |
| EVPERA90NR | 162 | 90 | 2 | | 11.2 | 0.19 |

EVPCPA2-NR • Two Way Corner Post (No Raceway) Panel



- Connects two No Raceway panel of equal height in 90 degree configuration.
- Post and connecting hardware add 3.25" to power beam run.
- Provides slotted support for worksurfaces and hang on components.
- Includes post, panel connectors and power beam connectors, post with trim all around, levelling glide, hardware and trim kit.
- Connectors available without slots, as a special at no extra charge. Contact customer support.

| PRODUCT CODE | PRICE | SIZE/INCHES | | | WEIGHT LBS | VOL FT ³ |
|--------------|-------|-------------|-------|---|------------|---------------------|
| | | H | W | D | | |
| EVPCPA230NR | 162 | 30 | 2.875 | | 8.50 | 0.31 |
| EVPCPA242NR | 207 | 42 | 2.875 | | 11.50 | 0.43 |
| EVPCPA248NR | 217 | 48 | 2.875 | | 11.50 | 0.54 |
| EVPCPA254NR | 251 | 54 | 2.875 | | 15.00 | 0.61 |
| EVPCPA266NR | 299 | 66 | 2.875 | | 19.00 | 0.75 |

EVPCPA2-NR • Two Way Corner Post (No Raceway) Panel



- Connects two No Raceway panel of equal height in 90 degree configuration.
- Post and connecting hardware add 3.25" to power beam run.
- Includes post, panel connectors and power beam connectors, post with trim all around, levelling glide, hardware and trim kit.
- Connectors are without slots.
- To be used only with 90" H NR Glazed Panels

| PRODUCT CODE | PRICE | SIZE/INCHES | | | WEIGHT LBS | VOL FT ³ |
|--------------|-------|-------------|-------|---|------------|---------------------|
| | | H | W | D | | |
| EVPCPA290NR | 412 | 90 | 2.875 | | 27 | 1.03 |

EVPCPA3-NR • Three Way Corner Post (No Raceway) Panel



- Connects three No Raceway panel of equal height in "T" configuration.
- Post and connecting hardware add 3.25" to power beam run.
- Provides slotted support for worksurfaces and hang on components.
- Includes post, panel connectors and power beam connectors, post with trim all around, levelling glide, hardware and trim kit.
- Connectors available without slots, as a special at no extra charge. Contact customer support.

| PRODUCT CODE | PRICE | SIZE/INCHES | | | WEIGHT LBS | VOL FT ³ |
|--------------|-------|-------------|-------|---|------------|---------------------|
| | | H | W | D | | |
| EVPCPA330NR | 195 | 30 | 2.875 | | 11.80 | 0.36 |
| EVPCPA342NR | 260 | 42 | 2.875 | | 16.10 | 0.50 |
| EVPCPA348NR | 286 | 48 | 2.875 | | 18.75 | 0.61 |
| EVPCPA354NR | 317 | 54 | 2.875 | | 20.50 | 0.70 |
| EVPCPA366NR | 373 | 66 | 2.875 | | 26.20 | 0.85 |

EVPCPA3-NR • Three Way Corner Post (No Raceway) Panel



- Connects three No Raceway panel of equal height in "T" configuration.
- Post and connecting hardware add 3.25" to power beam run.
- Includes post, panel connectors and power beam connectors, post with trim all around, levelling glide, hardware and trim kit.
- Connectors are without slots.
- To be used only with 90" H NR Glazed Panels

| PRODUCT CODE | PRICE | SIZE/INCHES | | | WEIGHT LBS | VOL FT ³ |
|--------------|-------|-------------|-------|---|------------|---------------------|
| | | H | W | D | | |
| EVPCPA390NR | 500 | 90 | 2.875 | | 38.2 | 1.17 |

EVPCPA4-NR • Four Way Corner Post (No Raceway) Panel



- Connects four No Raceway panel of equal height in "+" configuration.
- Post and connecting hardware add 3.25" to power beam run.
- Provides slotted support for worksurfaces and hang on components.
- Includes post, panel connectors and power beam connectors, post with trim all around, levelling glide, hardware and trim kit.
- Connectors available without slots, as a special at no extra charge. Contact customer support.

| PRODUCT CODE | PRICE | SIZE/INCHES | | | WEIGHT LBS | VOL FT ³ |
|--------------|-------|-------------|-------|---|------------|---------------------|
| | | H | W | D | | |
| EVPCPA430NR | 213 | 30 | 2.875 | | 15.5 | 0.40 |
| EVPCPA442NR | 279 | 42 | 2.875 | | 21.00 | 0.57 |
| EVPCPA448NR | 307 | 48 | 2.875 | | 24.00 | 0.68 |
| EVPCPA454NR | 339 | 54 | 2.875 | | 26.50 | 0.79 |
| EVPCPA466NR | 397 | 66 | 2.875 | | 33.20 | 0.95 |

EVPCPA4-NR • Four Way Corner Post (No Raceway) Panel

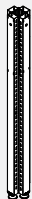

- Connects three No Raceway panel of equal height in "+" configuration.
- Post and connecting hardware add 3.25" to power beam run.
- Includes post, panel connectors and power beam connectors, post with trim all around, levelling glide, hardware and trim kit.
- Connectors are without slots.
- To be used only with 90" H NR Glazed Panels

| PRODUCT CODE | PRICE | SIZE/INCHES | | | WEIGHT LBS | VOL FT ³ |
|--------------|-------|-------------|-------|---|------------|---------------------|
| | | H | W | D | | |
| EVPCPA490NR | 510 | 90 | 2.875 | | 49.2 | 1.31 |

EVPIPA2-NR • Inline Two Way Corner Post (No Raceway Panel)



- Connects two No Raceway panel of equal height in straight run.
- Post and connecting hardware add 3.25" to power beam run.
- Provides slotted support for worksurfaces and hang on components.
- Includes post, panel connectors and power beam connectors, post with trim all around, levelling glide, hardware and trim kit.
- Connectors available without slots, as a special at no extra charge. Contact customer support.

| PRODUCT CODE | PRICE | SIZE/INCHES | | | WEIGHT LBS | VOL FT ³ |
|--------------|-------|-------------|-------|---|------------|---------------------|
| | | H | W | D | | |
| EVPIPA230NR | 162 | 30 | 2.875 | | 8.20 | 0.31 |
| EVPIPA242NR | 207 | 42 | 2.875 | | 11.50 | 0.43 |
| EVPIPA248NR | 217 | 48 | 2.875 | | 13.50 | 0.54 |
| EVPIPA254NR | 251 | 54 | 2.875 | | 15.00 | 0.61 |
| EVPIPA266NR | 299 | 66 | 2.875 | | 19.00 | 0.75 |

EVPIPA2-NR • Inline Two Way Corner Post (No Raceway Panel)



- Connects three No Raceway panel of equal height in a straight run.
- Post and connecting hardware add 3.25" to power beam run.
- Includes post, panel connectors and power beam connectors, post with trim all around, levelling glide, hardware and trim kit.
- Connectors are without slots.
- To be used only with 90" H NR Glazed Panels

| PRODUCT CODE | PRICE | SIZE/INCHES | | | WEIGHT LBS | VOL FT ³ |
|--------------|-------|-------------|-------|---|------------|---------------------|
| | | H | W | D | | |
| EVPIPA290NR | 433 | 90 | 2.875 | | 27 | 1.03 |

EVPCPA1-NR • One Way Corner Post (No Raceway Panel)



- Connects at end of No Raceway panel run in place of EVPERA-End of run post kit.
- Should not be used to attach pane to fixed wall.
- Post and connecting hardware add 3.25" to power beam run.
- Provides slotted support for worksurfaces and hang on components.
- Includes post, panel connectors and power beam connectors, post with trim all around, levelling glide, hardware and trim kit.
- Connectors available without slots, as a special at no extra charge. Contact customer support.

| PRODUCT CODE | PRICE | SIZE/INCHES | | | WEIGHT LBS | VOL FT ³ |
|--------------|-------|-------------|-------|---|------------|---------------------|
| | | H | W | D | | |
| EVPCPA130NR | 103 | 30 | 2.875 | | 4.97 | 0.24 |
| EVPCPA142NR | 117 | 42 | 2.875 | | 6.93 | 0.33 |
| EVPCPA148NR | 139 | 48 | 2.875 | | 7.93 | 0.38 |
| EVPCPA154NR | 160 | 54 | 2.875 | | 8.93 | 0.43 |
| EVPCPA166NR | 199 | 66 | 2.875 | | 10.87 | 0.53 |

EVPCPA1-NR • Inline One Way Corner Post (No Raceway Panel)



- Connects three No Raceway panel of equal height in a straight run.
- Should not be used to attach pane to fixed wall.
- Post and connecting hardware add 3.25" to power beam run.
- Includes post, panel connectors and power beam connectors, post with trim all around, levelling glide, hardware and trim kit.
- Connectors are without slots.
- To be used only with 90" H NR Glazed Panels

| PRODUCT CODE | PRICE | SIZE/INCHES | | | WEIGHT LBS | VOL FT ³ |
|--------------|-------|-------------|-------|---|------------|---------------------|
| | | H | W | D | | |
| EVPCPA190NR | 284 | 90 | 2.875 | | 14.87 | 0.67 |

EVVPC-PNR • Inline variable height connector Panel (No Raceway Panel)



- Connects Panel to No Raceway panels of differing height in straight run.
- Connector must reference taller panel.
- Can be used for any variation of panel height.
- Variable height trim must be ordered separately (see EVPTVA).
- Provides slotted support for worksurfaces and hang on components.
- Includes one slotted connector with leveling glide and connecting hardware.
- Connectors available without slots, as a special at no extra charge. Contact your Customer Service Representative.

| PRODUCT CODE | PRICE | SIZE/INCHES | | | WEIGHT LBS | VOL FT ³ |
|--------------|-------|-------------|---|---|------------|---------------------|
| | | H | W | D | | |
| EVVPC42PNR | 74 | 42 | 2 | | 4.60 | 0.07 |
| EVVPC48PNR | 77 | 48 | 2 | | 5.25 | 0.07 |
| EVVPC54PNR | 78 | 54 | 2 | | 5.90 | 0.09 |
| EVVPC66PNR | 88 | 66 | 2 | | 7.20 | 0.10 |

EVPCPA2-PNR • Two Way Corner Post (No Raceway Panel)



- Connects No Raceway panel and Panel of equal height in 90 degree configuration.
- Post and connecting hardware add 3.25" to power beam run.
- Provides slotted support for worksurfaces and hang on components.
- Includes post, panel connectors and power beam connectors, post with trim all around, levelling glide, hardware and trim kit.
- Connectors available without slots, as a special at no extra charge. Contact customer support.

| PRODUCT CODE | PRICE | SIZE/INCHES | | | WEIGHT LBS | VOL FT ³ |
|--------------|-------|-------------|-------|---|------------|---------------------|
| | | H | W | D | | |
| EVPCPA230PNR | 162 | 30 | 2.875 | | 8.50 | 0.31 |
| EVPCPA242PNR | 207 | 42 | 2.875 | | 11.50 | 0.43 |
| EVPCPA248PNR | 217 | 48 | 2.875 | | 11.50 | 0.54 |
| EVPCPA254PNR | 251 | 54 | 2.875 | | 15.00 | 0.61 |
| EVPCPA266PNR | 299 | 66 | 2.875 | | 19.00 | 0.75 |

EVPCPA3-NR • Three Way Corner Post (No Raceway Panel)



- Connects two No Raceway panel and Panel of equal height in "T" configuration.
- Post and connecting hardware add 3.25" to power beam run.
- Provides slotted support for worksurfaces and hang on components.
- Includes post, panel connectors and power beam connectors, post with trim all around, levelling glide, hardware and trim kit.
- Connectors available without slots, as a special at no extra charge. Contact customer support.

| PRODUCT CODE | PRICE | SIZE/INCHES | | | WEIGHT LBS | VOL FT³ |
|--------------|-------|-------------|-------|---|------------|---------|
| | | H | W | D | | |
| EVPCPA330PNR | 195 | 30 | 2.875 | | 11.80 | 0.36 |
| EVPCPA342PNR | 260 | 42 | 2.875 | | 16.10 | 0.50 |
| EVPCPA348PNR | 286 | 48 | 2.875 | | 18.75 | 0.61 |
| EVPCPA354PNR | 317 | 54 | 2.875 | | 20.50 | 0.70 |
| EVPCPA366PNR | 373 | 66 | 2.875 | | 26.20 | 0.85 |

EVPIC-PNR • Inline connector Panel (No Raceway Panel)



- Connects Panel to No Raceway panel in straight run
- Provides slotted support for worksurfaces and hang on components
- Includes one slotted connector with leveling glide and connecting hardware
- Connectors available without slots, as a special at no extra charge. Contact your Customer Service Representative.

| PRODUCT CODE | PRICE | SIZE/INCHES | | | WEIGHT LBS | VOL FT³ |
|--------------|-------|-------------|---|---|------------|---------|
| | | H | W | D | | |
| EVPIC30PNR | 63 | 30 | 2 | | 3.30 | 0.05 |
| EVPIC42PNR | 67 | 42 | 2 | | 4.60 | 0.07 |
| EVPIC48PNR | 69 | 48 | 2 | | 5.25 | 0.07 |
| EVPIC54PNR | 74 | 54 | 2 | | 5.90 | 0.09 |
| EVPIC66PNR | 83 | 66 | 2 | | 7.20 | 0.10 |

EVPIC-PNR • Inline connector Panel (No Raceway Panel)



- Connects 90" H No Raceway panel to 90" H door in straight run.
- Includes one non slotted connector with leveling glide and connecting hardware.
- Connectors are without slots.
- Note: To be used only with 90" H NR Glazed Panels and 90" H door.

| PRODUCT CODE | PRICE | SIZE/INCHES | | | WEIGHT LBS | VOL FT³ |
|--------------|-------|-------------|---|---|------------|---------|
| | | H | W | D | | |
| EVPIC90PNR | 117 | 90 | 2 | | 11.2 | 0.19 |

EVPCPA4-NR • Four Way Corner Post (No Raceway Panel)



- Connects two No Raceway panel and two Panel of equal height in "+" configuration.
- Post and connecting hardware add 3.25" to power beam run.
- Provides slotted support for worksurfaces and hang on components.
- Includes post, panel connectors and power beam connectors, post with trim all around, levelling glide, hardware and trim kit
- Connectors available without slots, as a special at no extra charge. Contact customer support.

| PRODUCT CODE | PRICE | SIZE/INCHES | | | WEIGHT LBS | VOL FT³ |
|--------------|-------|-------------|-------|---|------------|---------|
| | | H | W | D | | |
| EVPCPA430PNR | 213 | 30 | 2.875 | | 15.5 | 0.40 |
| EVPCPA442PNR | 279 | 42 | 2.875 | | 21.00 | 0.57 |
| EVPCPA448PNR | 307 | 48 | 2.875 | | 24.00 | 0.68 |
| EVPCPA454PNR | 339 | 54 | 2.875 | | 26.50 | 0.79 |
| EVPCPA466PNR | 397 | 66 | 2.875 | | 33.20 | 0.95 |

EVPIPA2-NR • Inline Two Way Corner Post (No Raceway Panel)

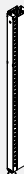

- Connects No Raceway panel and Panel of equal height in straight run.
- Post and connecting hardware add 3.25" to power beam run.
- Provides slotted support for worksurfaces and hang on components.
- Includes post, panel connectors and power beam connectors, post with trim all around, levelling glide, hardware and trim kit.
- Connectors available without slots, as a special at no extra charge. Contact customer support.
- Note: Inline two way post must be used when No Panel and Panel are next to each other in run

| PRODUCT CODE | PRICE | SIZE/INCHES | | | WEIGHT LBS | VOL FT³ |
|--------------|-------|-------------|-------|---|------------|---------|
| | | H | W | D | | |
| EVPIPA230PNR | 162 | 30 | 2.875 | | 8.20 | 0.31 |
| EVPIPA242PNR | 207 | 42 | 2.875 | | 11.50 | 0.43 |
| EVPIPA248PNR | 217 | 48 | 2.875 | | 13.50 | 0.54 |
| EVPIPA254PNR | 251 | 54 | 2.875 | | 15.00 | 0.61 |
| EVPIPA266PNR | 299 | 66 | 2.875 | | 19.00 | 0.75 |

EVPERCHxxNR • Laminate Panel Connector with U Channel (No Raceway Panel)



- U channel attaches with screws to laminate end panel or laminate middle panel.
- Evolve NO Raceway Panels attach to connector.
- U Channel is welded to a No Raceway Connector.
- Includes No Raceway connector with U channel and hardware.

| PRODUCT CODE | PRICE | SIZE/INCHES | | | WEIGHT LBS | VOL FT³ |
|--------------|-------|-------------|-------|---|------------|---------|
| | | H | W | D | | |
| EVPERCH42NR | 133 | 42 | 2.875 | | 4.60 | 0.14 |
| EVPERCH48NR | 140 | 48 | 2.875 | | 5.09 | 0.18 |
| EVPERCH54NR | 151 | 54 | 2.875 | | 6.75 | 0.22 |

EVPPXGT • Freestanding Glazed Monolithic Privacy Panel

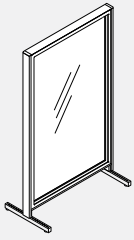

- Includes panel with two connectors with T legs with glides and end of run trims.
- Available in standard clear (CLR) tempered glass
- Available in standard frosted (FRST) tempered glass
- 22"d T-Legs (9.5" extension on each side of panel)
- Glazing is replaceable on site.

| PRODUCT CODE | PRICE | | SIZE/INCHES | | | WEIGHT LBS | VOL FT ³ |
|--------------|-------|------|-------------|----|-------|------------|---------------------|
| | CLR | FRST | H | W | D | | |
| EVPPXGT4218 | 590 | 711 | 42 | 18 | 2.875 | 50.53 | 2.46 |
| EVPPXGT4224 | 650 | 795 | 42 | 24 | 2.875 | 58.14 | 3.06 |
| EVPPXGT4230 | 704 | 873 | 42 | 30 | 2.875 | 65.96 | 3.6 |
| EVPPXGT4236 | 760 | 948 | 42 | 36 | 2.875 | 69.3 | 4.13 |
| EVPPXGT4242 | 820 | 1035 | 42 | 42 | 2.875 | 73.38 | 4.67 |
| EVPPXGT5418 | 688 | 836 | 54 | 18 | 2.875 | 56.19 | 2.99 |
| EVPPXGT5424 | 759 | 935 | 54 | 24 | 2.875 | 70.76 | 3.38 |
| EVPPXGT5430 | 825 | 1025 | 54 | 30 | 2.875 | 73.08 | 4.42 |
| EVPPXGT5436 | 887 | 1117 | 54 | 36 | 2.875 | 85.54 | 5.11 |
| EVPPXGT5442 | 958 | 1217 | 54 | 42 | 2.875 | 93.62 | 5.79 |
| EVPPXGT6618 | 794 | 970 | 66 | 18 | 2.875 | 62.74 | 3.48 |
| EVPPXGT6624 | 871 | 1080 | 66 | 24 | 2.875 | 70.81 | 4.38 |
| EVPPXGT6630 | 948 | 1189 | 66 | 30 | 2.875 | 78.63 | 4.79 |
| EVPPXGT6636 | 1021 | 1291 | 66 | 36 | 2.875 | 86.52 | 5.38 |
| EVPPXGT6642 | 1108 | 1410 | 66 | 42 | 2.875 | 92.66 | 6.38 |

EVPPXGT-F • Freestanding Glazed Monolithic Privacy Panel with Flat Foot

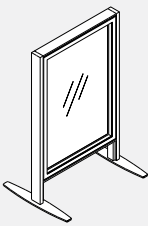

- Includes panel with two connectors with flat foot and end of run trims
- Available in standard clear (CLR) tempered glass
- Available in standard frosted (FRST) tempered glass
- Flat foot does not extend past end trim, no gaps between end trims
- 22"d T-Legs (9.5" extension on each side of panel)
- Glazing is replaceable on site.

| PRODUCT CODE | PRICE | | SIZE/INCHES | | | WEIGHT LBS | VOL FT ³ |
|--------------|-------|------|-------------|----|-------|------------|---------------------|
| | CLR | FRST | H | W | D | | |
| EVPPXGT4218F | 590 | 711 | 42 | 18 | 2.875 | 50.53 | 2.46 |
| EVPPXGT4224F | 650 | 795 | 42 | 24 | 2.875 | 58.14 | 3.06 |
| EVPPXGT4230F | 704 | 873 | 42 | 30 | 2.875 | 65.96 | 3.6 |
| EVPPXGT4236F | 760 | 948 | 42 | 36 | 2.875 | 69.3 | 4.13 |
| EVPPXGT4242F | 820 | 1035 | 42 | 42 | 2.875 | 73.38 | 4.67 |
| EVPPXGT5418F | 688 | 836 | 54 | 18 | 2.875 | 56.19 | 2.99 |
| EVPPXGT5424F | 759 | 935 | 54 | 24 | 2.875 | 70.76 | 3.38 |
| EVPPXGT5430F | 825 | 1025 | 54 | 30 | 2.875 | 73.08 | 4.42 |
| EVPPXGT5436F | 887 | 1117 | 54 | 36 | 2.875 | 85.54 | 5.11 |
| EVPPXGT5442F | 958 | 1217 | 54 | 42 | 2.875 | 93.62 | 5.79 |
| EVPPXGT6618F | 794 | 970 | 66 | 18 | 2.875 | 62.74 | 3.48 |
| EVPPXGT6624F | 871 | 1080 | 66 | 24 | 2.875 | 70.81 | 4.38 |
| EVPPXGT6630F | 948 | 1189 | 66 | 30 | 2.875 | 78.63 | 4.79 |
| EVPPXGT6636F | 1021 | 1291 | 66 | 36 | 2.875 | 86.52 | 5.38 |
| EVPPXGT6642F | 1108 | 1410 | 66 | 42 | 2.875 | 92.66 | 6.38 |

EVPPXGT-FS • Freestanding Glazed Monolithic Privacy Panel with Shared Flat Foot

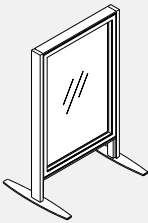

- Includes panel with two connectors with flat foot and end of run trims
- Available in standard clear (CLR) tempered glass
- Available in standard frosted (FRST) tempered glass
- Shared flat foot with connector in middle of flat foot
- 22"d T-Legs (9.5" extension on each side of panel)
- Glazing is replaceable on site.

| PRODUCT CODE | PRICE | | SIZE/INCHES | | | WEIGHT LBS | VOL FT ³ |
|---------------|-------|------|-------------|----|-------|------------|---------------------|
| | CLR | FRST | H | W | D | | |
| EVPPXGT4218FS | 590 | 711 | 42 | 18 | 2.875 | 50.53 | 2.46 |
| EVPPXGT4224FS | 650 | 795 | 42 | 24 | 2.875 | 58.14 | 3.06 |
| EVPPXGT4230FS | 704 | 873 | 42 | 30 | 2.875 | 65.96 | 3.6 |
| EVPPXGT4236FS | 760 | 948 | 42 | 36 | 2.875 | 69.3 | 4.13 |
| EVPPXGT4242FS | 820 | 1035 | 42 | 42 | 2.875 | 73.38 | 4.67 |
| EVPPXGT5418FS | 688 | 836 | 54 | 18 | 2.875 | 56.19 | 2.99 |
| EVPPXGT5424FS | 759 | 935 | 54 | 24 | 2.875 | 70.76 | 3.38 |
| EVPPXGT5430FS | 825 | 1025 | 54 | 30 | 2.875 | 73.08 | 4.42 |
| EVPPXGT5436FS | 887 | 1117 | 54 | 36 | 2.875 | 85.54 | 5.11 |
| EVPPXGT5442FS | 958 | 1217 | 54 | 42 | 2.875 | 93.62 | 5.79 |
| EVPPXGT6618FS | 794 | 970 | 66 | 18 | 2.875 | 62.74 | 3.48 |
| EVPPXGT6624FS | 871 | 1080 | 66 | 24 | 2.875 | 70.81 | 4.38 |
| EVPPXGT6630FS | 948 | 1189 | 66 | 30 | 2.875 | 78.63 | 4.79 |
| EVPPXGT6636FS | 1021 | 1291 | 66 | 36 | 2.875 | 86.52 | 5.38 |
| EVPPXGT6642FS | 1108 | 1410 | 66 | 42 | 2.875 | 92.66 | 6.38 |

EVPPXGT-M • Mobile Glazed Monolithic Panel

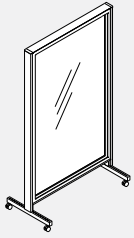

- Includes panel with two connectors with T legs with castors and end of run trims
- Available in standard clear (CLR) tempered glass
- Available in standard frosted (FRST) tempered glass
- Available in standard writeable (WRW) glass.
- 22"d T-Legs (9.5" extension on each side of panel)
- 1" locking casters
- Glazing is replaceable on site.

| PRODUCT CODE | PRICE | | | SIZE/INCHES | | | WEIGHT LBS | VOL FT ³ |
|--------------|-------|------|------|-------------|----|-------|------------|---------------------|
| | CLR | FRST | WRW | H | W | D | | |
| EVPPXGT4218M | 663 | 783 | - | 42 | 18 | 2.875 | 50.53 | 2.46 |
| EVPPXGT4224M | 724 | 868 | - | 42 | 24 | 2.875 | 58.14 | 3.06 |
| EVPPXGT4230M | 777 | 946 | - | 42 | 30 | 2.875 | 65.96 | 3.6 |
| EVPPXGT4236M | 833 | 1021 | - | 42 | 36 | 2.875 | 69.3 | 4.13 |
| EVPPXGT4242M | 894 | 1108 | - | 42 | 42 | 2.875 | 73.38 | 4.67 |
| EVPPXGT5418M | 760 | 909 | 1213 | 54 | 18 | 2.875 | 56.19 | 2.99 |
| EVPPXGT5424M | 832 | 1008 | 1398 | 54 | 24 | 2.875 | 70.76 | 3.38 |
| EVPPXGT5430M | 898 | 1098 | 1574 | 54 | 30 | 2.875 | 73.08 | 4.42 |
| EVPPXGT5436M | 959 | 1189 | 1749 | 54 | 36 | 2.875 | 85.54 | 5.11 |
| EVPPXGT5442M | 1032 | 1290 | 1933 | 54 | 42 | 2.875 | 93.62 | 5.79 |
| EVPPXGT6618M | 867 | 1043 | 1426 | 66 | 18 | 2.875 | 62.74 | 3.48 |
| EVPPXGT6624M | 944 | 1153 | 1641 | 66 | 24 | 2.875 | 70.81 | 4.38 |
| EVPPXGT6630M | 1021 | 1262 | 1854 | 66 | 30 | 2.875 | 78.63 | 4.79 |
| EVPPXGT6636M | 1093 | 1364 | 2060 | 66 | 36 | 2.875 | 86.52 | 5.38 |
| EVPPXGT6642M | 1180 | 1484 | 2287 | 66 | 42 | 2.875 | 92.66 | 6.38 |

EVPPGT • Freestanding Segmented Glazed Privacy Panels

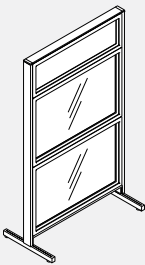

- Includes panel with two connectors with T legs with glides and end of run trims
- Available in standard clear (CLR) tempered glass
- Available in standard frosted (FRST) tempered glass
- 22"d T-Legs (9.5" extension on each side of panel)
- Glazing is replaceable on site.

| PRODUCT CODE | PRICE | | | SIZE/INCHES | | | WEIGHT LBS | VOL FT ³ |
|--------------|-------|------|-----|-------------|----|-------|------------|---------------------|
| | CLR | FRST | WRW | H | W | D | | |
| EVPPGT5424 | 733 | 909 | - | 54 | 24 | 2.875 | 70.8 | 3.38 |
| EVPPGT5430 | 805 | 1011 | - | 54 | 30 | 2.875 | 73.1 | 4.42 |
| EVPPGT5436 | 877 | 1109 | - | 54 | 36 | 2.875 | 85.5 | 5.11 |
| EVPPGT5442 | 954 | 1220 | - | 54 | 42 | 2.875 | 93.6 | 5.79 |
| EVPPGT5448 | 1029 | 1326 | - | 54 | 48 | 2.875 | 99.1 | 6.47 |
| EVPPGT5454 | 1109 | 1438 | - | 54 | 54 | 2.875 | 107 | 7.15 |
| EVPPGT5460 | 1178 | 1536 | - | 54 | 60 | 2.875 | 115.1 | 7.83 |
| EVPPGT6624 | 918 | 1156 | - | 66 | 24 | 2.875 | 78.63 | 4.38 |
| EVPPGT6630 | 1004 | 1279 | - | 66 | 30 | 2.875 | 86.52 | 4.79 |
| EVPPGT6636 | 1144 | 1475 | - | 66 | 36 | 2.875 | 92.66 | 5.38 |
| EVPPGT6642 | 1241 | 1611 | - | 66 | 42 | 2.875 | 98.19 | 6.38 |
| EVPPGT6648 | 1341 | 1751 | - | 66 | 48 | 2.875 | 105.48 | 7.68 |
| EVPPGT6654 | 1450 | 1904 | - | 66 | 54 | 2.875 | 112.52 | 8.5 |
| EVPPGT6660 | 1570 | 2069 | - | 66 | 60 | 2.875 | 129.3 | 9.33 |

EVPPGT-M • Mobile Segmented Glazed Privacy Panels

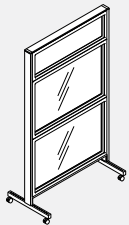

- Includes panel with two connectors with T legs with castors and end of run trims
- Available in standard clear (CLR) tempered glass
- Available in standard frosted (FRST) tempered glass
- 22"d T-Legs (9.5" extension on each side of panel)
- 1" locking casters
- Glazing is replaceable on site.

| PRODUCT CODE | PRICE | | | SIZE/INCHES | | | WEIGHT LBS | VOL FT ³ |
|--------------|-------|------|-----|-------------|----|-------|------------|---------------------|
| | CLR | FRST | WRW | H | W | D | | |
| EVPPGT5424M | 801 | 977 | - | 54 | 24 | 2.875 | 70.8 | 3.38 |
| EVPPGT5430M | 874 | 1079 | - | 54 | 30 | 2.875 | 73.1 | 4.42 |
| EVPPGT5436M | 947 | 1178 | - | 54 | 36 | 2.875 | 85.5 | 5.11 |
| EVPPGT5442M | 1022 | 1288 | - | 54 | 42 | 2.875 | 93.6 | 5.79 |
| EVPPGT5448M | 1099 | 1394 | - | 54 | 48 | 2.875 | 99.1 | 6.47 |
| EVPPGT5454M | 1178 | 1507 | - | 54 | 54 | 2.875 | 107 | 7.15 |
| EVPPGT5460M | 1246 | 1604 | - | 54 | 60 | 2.875 | 115.1 | 7.83 |
| EVPPGT6624M | 986 | 1224 | - | 66 | 24 | 2.875 | 78.63 | 4.38 |
| EVPPGT6630M | 1073 | 1348 | - | 66 | 30 | 2.875 | 86.52 | 4.79 |
| EVPPGT6636M | 1212 | 1543 | - | 66 | 36 | 2.875 | 92.66 | 5.38 |
| EVPPGT6642M | 1310 | 1679 | - | 66 | 42 | 2.875 | 98.19 | 6.38 |
| EVPPGT6648M | 1409 | 1819 | - | 66 | 48 | 2.875 | 105.48 | 7.68 |
| EVPPGT6654M | 1519 | 1972 | - | 66 | 54 | 2.875 | 112.52 | 8.5 |
| EVPPGT6660M | 1639 | 2138 | - | 66 | 60 | 2.875 | 129.3 | 9.33 |

EVPPHGT • Freestanding Segmented Glazed and Laminate Privacy Panels - Two Sides

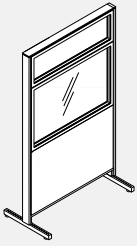

- 30" base panel with laminate faces both sides provides for durable and washable surfaces
- Available in standard clear (CLR) tempered glass
- Available in standard frosted (FRST) tempered glass
- 22"d T-Legs (9.5" extension on each side of panel)
- Glazing is replaceable on site.

| PRODUCT CODE | PRICE | | SIZE / INCHES | | | WEIGHT LBS | VOL FT ³ |
|--------------|-------|------|---------------|----|-------|------------|---------------------|
| | CLR | FRST | H | W | D | | |
| EVPPHGT5424 | 777 | 870 | 54 | 24 | 2.875 | 55.8 | 3.38 |
| EVPPHGT5430 | 862 | 975 | 54 | 30 | 2.875 | 62.8 | 4.42 |
| EVPPHGT5436 | 950 | 1083 | 54 | 36 | 2.875 | 69.3 | 5.11 |
| EVPPHGT5442 | 1037 | 1187 | 54 | 42 | 2.875 | 74.1 | 5.79 |
| EVPPHGT5448 | 1123 | 1289 | 54 | 48 | 2.875 | 83.1 | 6.47 |
| EVPPHGT5454 | 1216 | 1401 | 54 | 54 | 2.875 | 89.4 | 7.15 |
| EVPPHGT5460 | 1298 | 1498 | 54 | 60 | 2.875 | 95.5 | 7.83 |
| EVPPHGT6624 | 960 | 1088 | 66 | 24 | 2.875 | 70.81 | 4.38 |
| EVPPHGT6630 | 1062 | 1210 | 66 | 30 | 2.875 | 78.63 | 4.79 |
| EVPPHGT6636 | 1197 | 1372 | 66 | 36 | 2.875 | 86.52 | 5.38 |
| EVPPHGT6642 | 1300 | 1496 | 66 | 42 | 2.875 | 92.66 | 6.38 |
| EVPPHGT6648 | 1405 | 1621 | 66 | 48 | 2.875 | 98.19 | 7.68 |
| EVPPHGT6654 | 1524 | 1764 | 66 | 54 | 2.875 | 105.48 | 8.5 |
| EVPPHGT6660 | 1666 | 1933 | 66 | 60 | 2.875 | 116.2 | 9.33 |

EVPPHGT-M • Mobile Segmented Glazed and Laminate Privacy Panels - Two Sides

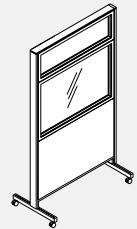

- 30" base panel with laminate faces both sides provides for durable and washable surfaces
- Available in standard clear (CLR) tempered glass
- Available in standard frosted (FRST) tempered glass
- 22"d T-Legs (9.5" extension on each side of panel)
- 1" locking casters
- Glazing is replaceable on site.

| PRODUCT CODE | PRICE | | SIZE / INCHES | | | WEIGHT LBS | VOL FT ³ |
|--------------|-------|------|---------------|----|-------|------------|---------------------|
| | CLR | FRST | H | W | D | | |
| EVPPHGT5424M | 845 | 938 | 54 | 24 | 2.875 | 55.8 | 3.38 |
| EVPPHGT5430M | 930 | 1043 | 54 | 30 | 2.875 | 62.8 | 4.42 |
| EVPPHGT5436M | 1018 | 1152 | 54 | 36 | 2.875 | 69.3 | 5.11 |
| EVPPHGT5442M | 1105 | 1255 | 54 | 42 | 2.875 | 74.1 | 5.79 |
| EVPPHGT5448M | 1192 | 1357 | 54 | 48 | 2.875 | 83.1 | 6.47 |
| EVPPHGT5454M | 1284 | 1470 | 54 | 54 | 2.875 | 89.4 | 7.15 |
| EVPPHGT5460M | 1366 | 1566 | 54 | 60 | 2.875 | 95.5 | 7.83 |
| EVPPHGT6624M | 1028 | 1156 | 66 | 24 | 2.875 | 70.81 | 4.38 |
| EVPPHGT6630M | 1130 | 1278 | 66 | 30 | 2.875 | 78.63 | 4.79 |
| EVPPHGT6636M | 1265 | 1441 | 66 | 36 | 2.875 | 86.52 | 5.38 |
| EVPPHGT6642M | 1368 | 1564 | 66 | 42 | 2.875 | 92.66 | 6.38 |
| EVPPHGT6648M | 1473 | 1690 | 66 | 48 | 2.875 | 98.19 | 7.68 |
| EVPPHGT6654M | 1592 | 1832 | 66 | 54 | 2.875 | 105.48 | 8.5 |
| EVPPHGT6660M | 1733 | 2001 | 66 | 60 | 2.875 | 116.2 | 9.33 |

EVPPHGTU • Freestanding Segmented Glazed and Laminate Privacy Panels - Two Sides

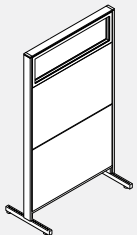

- Laminate faces both sides provides for durable and washable surfaces
- Available in standard clear (CLR) tempered glass
- Available in standard frosted (FRST) tempered glass
- 22"d T-Legs (9.5" extension on each side of panel)
- 12" Glazed segment
- Glazing is replaceable on site.

| PRODUCT CODE | PRICE | | SIZE / INCHES | | | WEIGHT LBS | VOL FT ³ |
|--------------|-------|------|---------------|----|-------|------------|---------------------|
| | CLR | FRST | H | W | D | | |
| EVPPHGTU5424 | 894 | 1017 | 54 | 24 | 2.875 | 49.2 | 3.38 |
| EVPPHGTU5430 | 994 | 1133 | 54 | 30 | 2.875 | 55.8 | 4.42 |
| EVPPHGTU5436 | 1094 | 1257 | 54 | 36 | 2.875 | 62.8 | 5.11 |
| EVPPHGTU5442 | 1194 | 1374 | 54 | 42 | 2.875 | 69.3 | 5.79 |
| EVPPHGTU5448 | 1294 | 1495 | 54 | 48 | 2.875 | 74.1 | 6.47 |
| EVPPHGTU5454 | 1403 | 1622 | 54 | 54 | 2.875 | 83.1 | 7.15 |
| EVPPHGTU5460 | 1502 | 1744 | 54 | 60 | 2.875 | 89.4 | 7.83 |
| EVPPHGTU6624 | 1001 | 1137 | 66 | 24 | 2.875 | 53.34 | 4.38 |
| EVPPHGTU6630 | 1118 | 1277 | 66 | 30 | 2.875 | 60.76 | 4.79 |
| EVPPHGTU6636 | 1259 | 1447 | 66 | 36 | 2.875 | 68.18 | 5.38 |
| EVPPHGTU6642 | 1372 | 1583 | 66 | 42 | 2.875 | 76.2 | 6.38 |
| EVPPHGTU6648 | 1485 | 1720 | 66 | 48 | 2.875 | 87.76 | 7.68 |
| EVPPHGTU6654 | 1616 | 1877 | 66 | 54 | 2.875 | 95.45 | 8.5 |
| EVPPHGTU6660 | 1757 | 2046 | 66 | 60 | 2.875 | 99.7 | 9.33 |

EVPPHGTU-M • Mobile Segmented Glazed and Laminate Privacy Panels - Two Sides

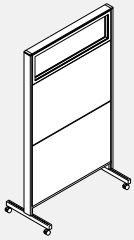

- Laminate faces both sides provides for durable and washable surfaces
- Available in standard clear (CLR) tempered glass
- Available in standard frosted (FRST) tempered glass
- 22"d T-Legs (9.5" extension on each side of panel)
- 1" locking casters
- 12" Glazed segment
- Glazing is replaceable on site.

| PRODUCT CODE | PRICE | | SIZE/INCHES | | | WEIGHT LBS | VOL FT ³ |
|---------------|-------|------|-------------|----|-------|------------|---------------------|
| | CLR | FRST | H | W | D | | |
| EVPPHGTU5424M | 962 | 1086 | 54 | 24 | 2.875 | 49.2 | 3.38 |
| EVPPHGTU5430M | 1062 | 1201 | 54 | 30 | 2.875 | 55.8 | 4.42 |
| EVPPHGTU5436M | 1162 | 1325 | 54 | 36 | 2.875 | 62.8 | 5.11 |
| EVPPHGTU5442M | 1262 | 1442 | 54 | 42 | 2.875 | 69.3 | 5.79 |
| EVPPHGTU5448M | 1363 | 1563 | 54 | 48 | 2.875 | 74.1 | 6.47 |
| EVPPHGTU5454M | 1471 | 1691 | 54 | 54 | 2.875 | 83.1 | 7.15 |
| EVPPHGTU5460M | 1570 | 1812 | 54 | 60 | 2.875 | 89.4 | 7.83 |
| EVPPHGTU6624M | 1069 | 1205 | 66 | 24 | 2.875 | 53.34 | 4.38 |
| EVPPHGTU6630M | 1187 | 1345 | 66 | 30 | 2.875 | 60.76 | 4.79 |
| EVPPHGTU6636M | 1327 | 1515 | 66 | 36 | 2.875 | 68.18 | 5.38 |
| EVPPHGTU6642M | 1441 | 1652 | 66 | 42 | 2.875 | 76.2 | 6.38 |
| EVPPHGTU6648M | 1554 | 1788 | 66 | 48 | 2.875 | 87.76 | 7.68 |
| EVPPHGTU6654M | 1684 | 1945 | 66 | 54 | 2.875 | 95.45 | 8.5 |
| EVPPHGTU6660M | 1825 | 2114 | 66 | 60 | 2.875 | 99.7 | 9.33 |

EVPPH2S • Freestanding Segmented Laminate Privacy Panels - Two Sides

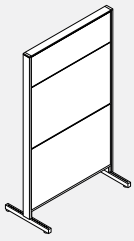

- All laminate faces both sides provides for durable and washable surfaces
- 22"d T-Legs (9.5" extension on each side of panel)

| PRODUCT CODE | PRICE | SIZE/INCHES | | | WEIGHT LBS | VOL FT ³ |
|--------------|-------|-------------|----|-------|------------|---------------------|
| | | H | W | D | | |
| EVPPH2S5424 | 818 | 54 | 24 | 2.875 | 50.8 | 3.38 |
| EVPPH2S5430 | 918 | 54 | 30 | 2.875 | 56.2 | 4.42 |
| EVPPH2S5436 | 1023 | 54 | 36 | 2.875 | 60.4 | 5.11 |
| EVPPH2S5442 | 1121 | 54 | 42 | 2.875 | 63.7 | 5.79 |
| EVPPH2S5448 | 1216 | 54 | 48 | 2.875 | 71.2 | 6.47 |
| EVPPH2S5454 | 1320 | 54 | 54 | 2.875 | 73.9 | 7.15 |
| EVPPH2S5460 | 1414 | 54 | 60 | 2.875 | 80.4 | 7.83 |
| EVPPH2S6624 | 990 | 66 | 24 | 2.875 | 62.8 | 4.38 |
| EVPPH2S6630 | 1121 | 66 | 30 | 2.875 | 69.3 | 4.79 |
| EVPPH2S6636 | 1267 | 66 | 36 | 2.875 | 76.8 | 5.38 |
| EVPPH2S6642 | 1394 | 66 | 42 | 2.875 | 82.1 | 6.38 |
| EVPPH2S6648 | 1516 | 66 | 48 | 2.875 | 88 | 7.68 |
| EVPPH2S6654 | 1645 | 66 | 54 | 2.875 | 93.7 | 8.5 |
| EVPPH2S6660 | 1782 | 66 | 60 | 2.875 | 95.2 | 9.33 |

EVPPH2S-M • Mobile Segmented Laminate Privacy Panels - Two Sides

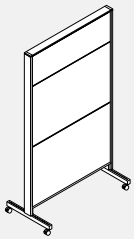

- All laminate faces both sides provides for durable and washable surfaces
- Includes panel with two connectors with T legs with castors and end of run trims
- 22"d T-Legs (9.5" extension on each side of panel)
- 1" locking casters

| PRODUCT CODE | PRICE | SIZE/INCHES | | | WEIGHT LBS | VOL FT ³ |
|--------------|-------|-------------|----|-------|------------|---------------------|
| | | H | W | D | | |
| EVPPH2S5424M | 886 | 54 | 24 | 2.875 | 50.8 | 3.38 |
| EVPPH2S5430M | 986 | 54 | 30 | 2.875 | 56.2 | 4.42 |
| EVPPH2S5436M | 1091 | 54 | 36 | 2.875 | 60.4 | 5.11 |
| EVPPH2S5442M | 1189 | 54 | 42 | 2.875 | 63.7 | 5.79 |
| EVPPH2S5448M | 1284 | 54 | 48 | 2.875 | 71.2 | 6.47 |
| EVPPH2S5454M | 1389 | 54 | 54 | 2.875 | 73.9 | 7.15 |
| EVPPH2S5460M | 1482 | 54 | 60 | 2.875 | 80.4 | 7.83 |
| EVPPH2S6624M | 1060 | 66 | 24 | 2.875 | 62.8 | 4.38 |
| EVPPH2S6630M | 1189 | 66 | 30 | 2.875 | 69.3 | 4.79 |
| EVPPH2S6636M | 1336 | 66 | 36 | 2.875 | 76.8 | 5.38 |
| EVPPH2S6642M | 1462 | 66 | 42 | 2.875 | 82.1 | 6.38 |
| EVPPH2S6648M | 1585 | 66 | 48 | 2.875 | 88 | 7.68 |
| EVPPH2S6654M | 1713 | 66 | 54 | 2.875 | 93.7 | 8.5 |
| EVPPH2S6660M | 1850 | 66 | 60 | 2.875 | 95.2 | 9.33 |

EVPPF2W • Freestanding Segmented Write Board Privacy Panels

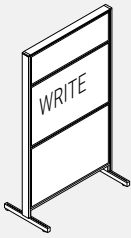

- Writing surface is built into the top module on both sides of the panel, alleviating the need for a panel-mounted Writeboard.
- Use of erasable Writeboard markers only.
- 22"d T-Legs (9.5" extension on each side of panel)

| PRODUCT CODE | PRICE | | SIZE/INCHES | | | WEIGHT LBS | VOL FT ³ |
|--------------|-------|------|-------------|----|-------|------------|---------------------|
| | GR1 | GR2 | H | W | D | | |
| EVPPF2W5424 | 790 | 805 | 54 | 24 | 2.875 | 49.8 | 3.38 |
| EVPPF2W5430 | 885 | 905 | 54 | 30 | 2.875 | 55.2 | 4.42 |
| EVPPF2W5436 | 981 | 1000 | 54 | 36 | 2.875 | 59.4 | 5.11 |
| EVPPF2W5442 | 1073 | 1100 | 54 | 42 | 2.875 | 62.7 | 5.79 |
| EVPPF2W5448 | 1181 | 1211 | 54 | 48 | 2.875 | 70.2 | 6.47 |
| EVPPF2W5454 | 1283 | 1329 | 54 | 54 | 2.875 | 74.9 | 7.15 |
| EVPPF2W5460 | 1375 | 1414 | 54 | 60 | 2.875 | 79.4 | 7.83 |
| EVPPF2W6624 | 955 | 970 | 66 | 24 | 2.875 | 57.8 | 4.38 |
| EVPPF2W6630 | 1119 | 1139 | 66 | 30 | 2.875 | 62.8 | 4.79 |
| EVPPF2W6636 | 1261 | 1283 | 66 | 36 | 2.875 | 69.3 | 5.38 |
| EVPPF2W6642 | 1393 | 1417 | 66 | 42 | 2.875 | 76.8 | 6.38 |
| EVPPF2W6648 | 1537 | 1566 | 66 | 48 | 2.875 | 82.1 | 7.68 |
| EVPPF2W6654 | 1669 | 1714 | 66 | 54 | 2.875 | 88 | 8.5 |
| EVPPF2W6660 | 1835 | 1867 | 66 | 60 | 2.875 | 98.3 | 9.33 |

EVPPF2W-M • Mobile Segmented Write Board Privacy Panels

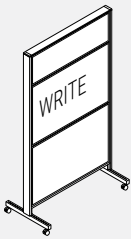

- Writing surface is built into the top module on both sides of the panel, alleviating the need for a panel-mounted Writeboard.
- Use of erasable Writeboard markers only.
- 22"d T-Legs (9.5" extension on each side of panel)
- 1" locking casters

| PRODUCT CODE | PRICE | | SIZE/INCHES | | | WEIGHT LBS | VOL FT ³ |
|--------------|-------|------|-------------|----|-------|------------|---------------------|
| | GR1 | GR2 | H | W | D | | |
| EVPPF2W5424M | 858 | 874 | 54 | 24 | 2.875 | 49.8 | 3.38 |
| EVPPF2W5430M | 954 | 973 | 54 | 30 | 2.875 | 55.2 | 4.42 |
| EVPPF2W5436M | 1049 | 1068 | 54 | 36 | 2.875 | 59.4 | 5.11 |
| EVPPF2W5442M | 1142 | 1168 | 54 | 42 | 2.875 | 62.7 | 5.79 |
| EVPPF2W5448M | 1250 | 1279 | 54 | 48 | 2.875 | 70.2 | 6.47 |
| EVPPF2W5454M | 1351 | 1397 | 54 | 54 | 2.875 | 74.9 | 7.15 |
| EVPPF2W5460M | 1443 | 1482 | 54 | 60 | 2.875 | 79.4 | 7.83 |
| EVPPF2W6624M | 1023 | 1038 | 66 | 24 | 2.875 | 57.8 | 4.38 |
| EVPPF2W6630M | 1188 | 1208 | 66 | 30 | 2.875 | 62.8 | 4.79 |
| EVPPF2W6636M | 1329 | 1351 | 66 | 36 | 2.875 | 69.3 | 5.38 |
| EVPPF2W6642M | 1461 | 1485 | 66 | 42 | 2.875 | 76.8 | 6.38 |
| EVPPF2W6648M | 1605 | 1634 | 66 | 48 | 2.875 | 82.1 | 7.68 |
| EVPPF2W6654M | 1737 | 1783 | 66 | 54 | 2.875 | 88 | 8.5 |
| EVPPF2W6660M | 1904 | 1935 | 66 | 60 | 2.875 | 98.3 | 9.33 |

EVPPH2W • Freestanding Segmented Write Board and Laminate Privacy Panels

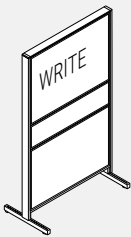

- 30" base panel with laminate faces both sides provides for durable and washable surfaces
- Writing surface is built into upper modules on both sides of the panel, alleviating the need for a panel-mounted Writeboard.
- Use of erasable Writeboard markers only.
- 22"d T-Legs (9.5" extension on each side of panel)

| PRODUCT CODE | PRICE | SIZE/INCHES | | | WEIGHT LBS | VOL FT ³ |
|--------------|-------|-------------|----|-------|------------|---------------------|
| | | H | W | D | | |
| EVPPH2W5424 | 868 | 54 | 24 | 2.875 | 50.8 | 3.38 |
| EVPPH2W5430 | 982 | 54 | 30 | 2.875 | 56.2 | 4.42 |
| EVPPH2W5436 | 1099 | 54 | 36 | 2.875 | 60.4 | 5.11 |
| EVPPH2W5442 | 1209 | 54 | 42 | 2.875 | 63.7 | 5.79 |
| EVPPH2W5448 | 1315 | 54 | 48 | 2.875 | 71.2 | 6.47 |
| EVPPH2W5454 | 1434 | 54 | 54 | 2.875 | 73.9 | 7.15 |
| EVPPH2W5460 | 1540 | 54 | 60 | 2.875 | 80.4 | 7.83 |
| EVPPH2W6624 | 1024 | 66 | 24 | 2.875 | 62.8 | 4.38 |
| EVPPH2W6630 | 1214 | 66 | 30 | 2.875 | 69.34 | 4.79 |
| EVPPH2W6636 | 1388 | 66 | 36 | 2.875 | 76.8 | 5.38 |
| EVPPH2W6642 | 1527 | 66 | 42 | 2.875 | 82.09 | 6.38 |
| EVPPH2W6648 | 1672 | 66 | 48 | 2.875 | 88 | 7.68 |
| EVPPH2W6654 | 1819 | 66 | 54 | 2.875 | 93.73 | 8.5 |
| EVPPH2W6660 | 1971 | 66 | 60 | 2.875 | 95.2 | 9.33 |

EVPPH2W-M • Mobile Segmented Write Board and Laminate Privacy Panels

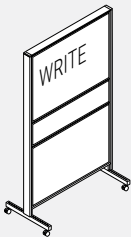

- 30" base panel with laminate faces both sides provides for durable and washable surfaces
- Writing surface is built into upper modules on both sides of the panel, alleviating the need for a panel-mounted Writeboard.
- Use of erasable Writeboard markers only.
- 22"d T-Legs (9.5" extension on each side of panel)

| PRODUCT CODE | PRICE | SIZE/INCHES | | | WEIGHT LBS | VOL FT ³ |
|--------------|-------|-------------|----|-------|------------|---------------------|
| | | H | W | D | | |
| EVPPH2W5424M | 936 | 54 | 24 | 2.875 | 50.8 | 3.38 |
| EVPPH2W5430M | 1050 | 54 | 30 | 2.875 | 56.2 | 4.42 |
| EVPPH2W5436M | 1167 | 54 | 36 | 2.875 | 60.4 | 5.11 |
| EVPPH2W5442M | 1277 | 54 | 42 | 2.875 | 63.7 | 5.79 |
| EVPPH2W5448M | 1383 | 54 | 48 | 2.875 | 71.2 | 6.47 |
| EVPPH2W5454M | 1502 | 54 | 54 | 2.875 | 73.9 | 7.15 |
| EVPPH2W5460M | 1608 | 54 | 60 | 2.875 | 80.4 | 7.83 |
| EVPPH2W6624M | 1092 | 66 | 24 | 2.875 | 62.8 | 4.38 |
| EVPPH2W6630M | 1283 | 66 | 30 | 2.875 | 69.34 | 4.79 |
| EVPPH2W6636M | 1456 | 66 | 36 | 2.875 | 76.8 | 5.38 |
| EVPPH2W6642M | 1595 | 66 | 42 | 2.875 | 82.09 | 6.38 |
| EVPPH2W6648M | 1740 | 66 | 48 | 2.875 | 88 | 7.68 |
| EVPPH2W6654M | 1888 | 66 | 54 | 2.875 | 93.73 | 8.5 |
| EVPPH2W6660M | 2039 | 66 | 60 | 2.875 | 95.2 | 9.33 |

EVPRGLA • Acoustic Grid - 60" wide

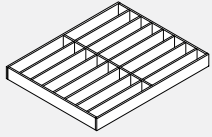

Configuration: 30" - 30"

- PET felt Acoustic Grid to be installed on top of Evolve panels.
- Acoustic Grid kit includes felt pieces, aluminum channel and all necessary hardware.
- PET felt slats run from side to side.
- PET felt pieces available in standard PET felt colours.
- Top trim with channel and beam above opening to be ordered separately.
- Shipped KD.
- For a different felt color for the outer PET frame, choose the code with a D at the end.

| PRODUCT CODE | PRICE | SIZE/INCHES | | | WEIGHT LBS | VOL FT ³ |
|--------------|-------|-------------|----|----|------------|---------------------|
| | | H | W | D | | |
| EVPRGLA4860 | 1976 | 5.5 | 60 | 48 | 18.25 | 9.2 |
| EVPRGLA6060 | 2342 | 5.5 | 60 | 60 | 19.02 | 11.5 |
| EVPRGLA7260 | 2709 | 5.5 | 60 | 72 | 22.04 | 13.8 |
| EVPRGLA8460 | 3074 | 5.5 | 60 | 84 | 25.06 | 16.0 |
| EVPRGLA9060 | 3258 | 5.5 | 60 | 90 | 26.57 | 17.2 |
| EVPRGLA9660 | 3468 | 5.5 | 60 | 96 | 28.29 | 18.3 |
| EVPRGLA4860D | 1976 | 5.5 | 60 | 48 | 18.25 | 9.2 |
| EVPRGLA6060D | 2342 | 5.5 | 60 | 60 | 19.02 | 11.5 |
| EVPRGLA7260D | 2709 | 5.5 | 60 | 72 | 22.04 | 13.8 |
| EVPRGLA8460D | 3074 | 5.5 | 60 | 84 | 25.06 | 16.0 |
| EVPRGLA9060D | 3258 | 5.5 | 60 | 90 | 26.57 | 17.2 |
| EVPRGLA9660D | 3468 | 5.5 | 60 | 96 | 28.29 | 18.3 |

EVPRGLA • Acoustic Grid - 72" wide

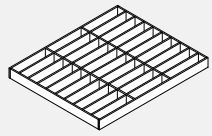

Configuration: 24" - 24" - 24"

- PET felt Acoustic Grid to be installed on top of Evolve panels.
- Acoustic Grid kit includes felt pieces, aluminum channel and all necessary hardware.
- PET felt slats run from side to side.
- PET felt pieces available in standard PET felt colours.
- Top trim with channel and beam above opening to be ordered separately.
- Shipped KD.
- For a different felt color for the outer PET frame, choose the code with a D at the end.

| PRODUCT CODE | PRICE | SIZE/INCHES | | | WEIGHT LBS | VOL FT ³ |
|--------------|-------|-------------|----|----|------------|---------------------|
| | | H | W | D | | |
| EVPRGLA4872 | 2378 | 5.5 | 72 | 48 | 20.10 | 11.0 |
| EVPRGLA6072 | 2821 | 5.5 | 72 | 60 | 23.96 | 13.8 |
| EVPRGLA7272 | 3263 | 5.5 | 72 | 72 | 27.81 | 16.5 |
| EVPRGLA8472 | 3705 | 5.5 | 72 | 84 | 31.67 | 19.3 |
| EVPRGLA9072 | 3927 | 5.5 | 72 | 90 | 33.60 | 20.6 |
| EVPRGLA9672 | 4176 | 5.5 | 72 | 96 | 35.75 | 22.0 |
| EVPRGLA4872D | 2378 | 5.5 | 72 | 48 | 20.10 | 11.0 |
| EVPRGLA6072D | 2821 | 5.5 | 72 | 60 | 23.96 | 13.8 |
| EVPRGLA7272D | 3263 | 5.5 | 72 | 72 | 27.81 | 16.5 |
| EVPRGLA8472D | 3705 | 5.5 | 72 | 84 | 31.67 | 19.3 |
| EVPRGLA9072D | 3927 | 5.5 | 72 | 90 | 33.60 | 20.6 |
| EVPRGLA9672D | 4176 | 5.5 | 72 | 96 | 35.75 | 22.0 |

EVPRGLA • Acoustic Grid - 84" wide

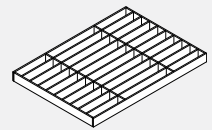

Configuration: 24" - 36" - 24"

- PET felt Acoustic Grid to be installed on top of Evolve panels.
- Acoustic Grid kit includes felt pieces, aluminum channel and all necessary hardware.
- PET felt slats run from side to side.
- PET felt pieces available in standard PET felt colours.
- Top trim with channel and beam above opening to be ordered separately.
- Shipped KD.
- For a different felt color for the outer PET frame, choose the code with a D at the end.

| PRODUCT CODE | PRICE | SIZE/INCHES | | | WEIGHT LBS | VOL FT ³ |
|--------------|-------|-------------|----|----|------------|---------------------|
| | | H | W | D | | |
| EVPRGLA4884 | 2657 | 5.5 | 84 | 48 | 22.15 | 12.8 |
| EVPRGLA6084 | 3147 | 5.5 | 84 | 60 | 26.35 | 16.0 |
| EVPRGLA7284 | 3636 | 5.5 | 84 | 72 | 30.54 | 19.3 |
| EVPRGLA8484 | 4124 | 5.5 | 84 | 84 | 34.74 | 22.5 |
| EVPRGLA9084 | 4368 | 5.5 | 84 | 90 | 36.83 | 24.1 |
| EVPRGLA9684 | 4640 | 5.5 | 84 | 96 | 39.14 | 25.7 |
| EVPRGLA4884D | 2657 | 5.5 | 84 | 48 | 22.15 | 12.8 |
| EVPRGLA6084D | 3147 | 5.5 | 84 | 60 | 26.35 | 16.0 |
| EVPRGLA7284D | 3636 | 5.5 | 84 | 72 | 30.54 | 19.3 |
| EVPRGLA8484D | 4124 | 5.5 | 84 | 84 | 34.74 | 22.5 |
| EVPRGLA9084D | 4368 | 5.5 | 84 | 90 | 36.83 | 24.1 |
| EVPRGLA9684D | 4640 | 5.5 | 84 | 96 | 39.14 | 25.7 |

EVPRGLA • Acoustic Grid - 90" wide

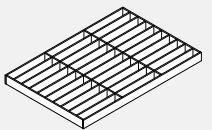

Configuration: 30" - 30" - 30"

- PET felt Acoustic Grid to be installed on top of Evolve panels.
- Acoustic Grid kit includes felt pieces, aluminum channel and all necessary hardware.
- PET felt slats run from side to side.
- PET felt pieces available in standard PET felt colours.
- Top trim with channel and beam above opening to be ordered separately.
- Shipped KD.
- For a different felt color for the outer PET frame, choose the code with a D at the end.

| PRODUCT CODE | PRICE | SIZE/INCHES | | | WEIGHT LBS | VOL FT ³ |
|--------------|-------|-------------|----|----|------------|---------------------|
| | | H | W | D | | |
| EVPRGLA4890 | 2759 | 5.5 | 90 | 48 | 23.27 | 13.8 |
| EVPRGLA6090 | 3271 | 5.5 | 90 | 60 | 27.65 | 17.2 |
| EVPRGLA7290 | 3784 | 5.5 | 90 | 72 | 30.04 | 20.6 |
| EVPRGLA8490 | 4296 | 5.5 | 90 | 84 | 36.42 | 24.1 |
| EVPRGLA9090 | 4553 | 5.5 | 90 | 90 | 38.62 | 25.8 |
| EVPRGLA9690 | 4837 | 5.5 | 90 | 96 | 41.01 | 27.5 |
| EVPRGLA4890D | 2759 | 5.5 | 90 | 48 | 23.27 | 13.8 |
| EVPRGLA6090D | 3271 | 5.5 | 90 | 60 | 27.65 | 17.2 |
| EVPRGLA7290D | 3784 | 5.5 | 90 | 72 | 30.04 | 20.6 |
| EVPRGLA8490D | 4296 | 5.5 | 90 | 84 | 36.42 | 24.1 |
| EVPRGLA9090D | 4553 | 5.5 | 90 | 90 | 38.62 | 25.8 |
| EVPRGLA9690D | 4837 | 5.5 | 90 | 96 | 41.01 | 27.5 |

EVPRGLA • Acoustic Grid - 96" wide

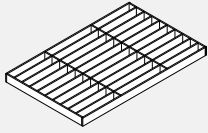

Configuration: 30"- 36"- 30"

- PET felt Acoustic Grid to be installed on top of Evolve panels.
- Acoustic Grid kit includes felt pieces, aluminum channel and all necessary hardware.
- PET felt slats run from side to side.
- PET felt pieces available in standard PET felt colours.
- Top trim with channel and beam above opening to be ordered separately.
- Shipped KD.
- For a different felt color for the outer PET frame, choose the code with a D at the end.

| PRODUCT CODE | PRICE | SIZE/INCHES | | | WEIGHT LBS | VOL FT ³ |
|--------------|-------|-------------|----|----|------------|---------------------|
| | | H | W | D | | |
| EVPRGLA4896 | 2963 | 5.5 | 96 | 48 | 24.47 | 14.7 |
| EVPRGLA6096 | 3500 | 5.5 | 96 | 60 | 29.02 | 18.3 |
| EVPRGLA7296 | 4036 | 5.5 | 96 | 72 | 33.56 | 22.0 |
| EVPRGLA8496 | 4570 | 5.5 | 96 | 84 | 38.11 | 25.7 |
| EVPRGLA9096 | 4839 | 5.5 | 96 | 90 | 40.38 | 27.5 |
| EVPRGLA9696 | 5132 | 5.5 | 96 | 96 | 42.86 | 29.3 |
| EVPRGLA4896D | 2963 | 5.5 | 96 | 48 | 24.47 | 14.7 |
| EVPRGLA6096D | 3500 | 5.5 | 96 | 60 | 29.02 | 18.3 |
| EVPRGLA7296D | 4036 | 5.5 | 96 | 72 | 33.56 | 22.0 |
| EVPRGLA8496D | 4570 | 5.5 | 96 | 84 | 38.11 | 25.7 |
| EVPRGLA9096D | 4839 | 5.5 | 96 | 90 | 40.38 | 27.5 |
| EVPRGLA9696D | 5132 | 5.5 | 96 | 96 | 42.86 | 29.3 |

EVPRGLA • Acoustic Grid - 144" wide

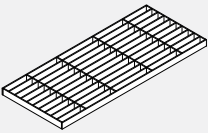

Configuration: 24"- 30"- 36"- 30"- 24"

- PET felt Acoustic Grid to be installed on top of Evolve panels.
- Acoustic Grid kit includes felt pieces, aluminum channel and all necessary hardware.
- PET felt slats run from side to side.
- PET felt pieces available in standard PET felt colours.
- Top trim with channel and beam above opening to be ordered separately.
- Shipped KD.
- For a different felt color for the outer PET frame, choose the code with a D at the end.

| PRODUCT CODE | PRICE | SIZE/INCHES | | | WEIGHT LBS | VOL FT ³ |
|----------------|-------|-------------|-----|-----|------------|---------------------|
| | | H | W | D | | |
| EVPRGLA120144 | 7655 | 6 | 144 | 120 | 73.86 | 55.0 |
| EVPRGLA120144D | 7655 | 6 | 144 | 120 | 73.86 | 55.0 |

STEP BY STEP SPECIFICATION • 8 WIRE ELECTRICAL SYSTEM

Step 1 Determine the location of the power source entering the panel run.

1. At the base of the panel.
 - a) Use EVE8FR Reversible Floor Power Entry (default to EVE8FR).
 - b) Select the panel to which the Floor Power Entry will be attached. This panel requires an EVE8PD Power Distribution Housing.
 - c) Select the side of the panel and the receptacle outlet to which the Floor Power Entry is to be attached.
2. From the ceiling.
 - a) Use EVE8EC1 Ceiling Power Entry.
 - b) Select the post through which to feed the Ceiling Power Entry.
 - c) One panel adjacent to the selected post requires an EVE8PD Power Distribution Housing.
 - d) Attach Ceiling Power entry to the nearest end of the Power Distribution Housing.

Step 2 Determine which panels are to be powered.

1. Use EVE8PD Power Distribution Housing that corresponds with the width of the panel.

Step 3 Connect power to the powered panels.

1. Use EVE8CP16 Jumper Cable between two adjacent powered panels.
2. Use EVE8CP20 Jumper Cable between two adjacent powered panels separated by a post.

3. Use EVE8CP Pass-Through Cables to connect powered panels that are separated by one or more non-powered panels (maximum distance between the powered panels is 12 feet).
 - a) The length of the Pass-Through Cable is calculated by adding together the widths of the non-powered panels that separate the two powered panels and applying an additional 16" to the total. (EVE8PD Power Distribution Housing is positioned 8" in from the ends of the powered panel.)
 - b) An additional 4" must be added to the Pass-Through Cable for each post that the cable passes through.
4. From the price list, select the EVE8CP Pass-Through Cable that matches the calculated length. If the length is between listed sizes, use the next size up.

Step 4 Determine the location and circuitry of the receptacles.

1. Each powered panel has four (4) potential locations for EVE8RD Duplex Receptacles – 2 per side. (Exception: 24" wide panel has only two potential locations – 1 per side, 18" wide panel has no locations for receptacles.)
2. At each receptacle location there is a choice of four (4) circuit options. Select a circuit option for each location. Circuits one and two are utility circuits; circuits A and B are dedicated circuits.

DEFINITION OF COMPONENTS**Power Distribution Housing**

Power Distribution Housing must be specified for each panel where power is required. Order a power kit for the panel width requiring power. The kit is field installed.

Jumper Cable

A Jumper Cable must be ordered to connect two powered panels. The EVE8CP16 connects two powered panels. The EVE8CP20 connects two powered panels with a 90° connector post between the panels (two-way, three-way, four-way configurations).

A Pass-Through Cable

A Pass-Through Cable allows cables to be passed from a powered panel through one or more non-powered panels (panels that do not require electrical outlets) to connect to another powered panel. (See Step-by-Step Specification for details.)

Duplex Receptacles

Duplex Receptacles snap into place in the power housing. Four circuits may be specified. Circuits A and B are dedicated. Up to two duplexes per side may be installed in a power way for panels 30" and wider. 24" panels will accept one Duplex Receptacle per side. 18" panels will not accept Duplex Receptacles.

Power Entry

To power an Evolve panel, order either a floor power entry or a ceiling power entry. A floor power entry module will take the place of a duplex receptacle by snapping into the base power way.

Desktop Data/Power Receptacle

This module is positioned in the scoop of an Evolve worksurface and provides two simplex plugs and two voice/data ports or two simplex plugs only and two voice data only. A 6 foot power cord can be plugged into a powered Evolve raceway.

WIRE SCHEMATIC

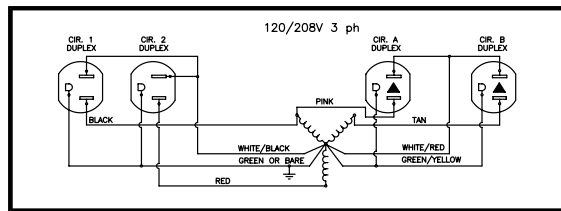
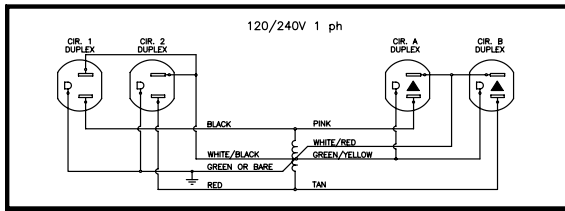

4-2-2 Wiring Schematic
 8-Wire Shared Neutral
 "2+2" - 2 Utility circuits, 2 dedicated

8 Wires
 4 Lines (12 ga.)
 2 Neutrals (10 ga.)
 2 Grounds (12 ga.)

4 Circuits
 2 Utility Circuits
 2 Dedicated Circuits

Receptacles
 Duplex - Up to 6 receptacles per circuit (Up to 48 infeed)

Specifications
 System rated for connection to a grounded 120/240 V, single phase, 20A, 60Hz or 120/208 V, 3 phase, 20A, 60Hz branch circuit for U.S. and 15A if product is marked with a C-UL Mark. Outlets rated 15A max.

UL RECOGNIZED AND CSA CERTIFIED

Warning: It is recommended that installation of the electrical harness be made under the supervision of a licensed electrician in accordance with applicable codes and regulations.

Special Note: Always determine that harness is electrically connected to only one power supply.

COMPONENTS REQUIRED

- a) EVE8PD42 • Power Distribution Housing
Note: 8 wire, 4 circuits (A and B circuits access dedicated circuits).
- b) EVE8CP16 • Jumper Cable
Note: EVE8CP16 connects two powered panels positioned side by side. EVE8CP20 connects two powered panels separated by a post.
- c) EVE8RD • Duplex Receptacle
Note: 1 and 2 access utility circuits.
- d) EVE8CP • Pass-Through Cable
Note: An "I" connector is available to connect 2 Pass-Through Cables.

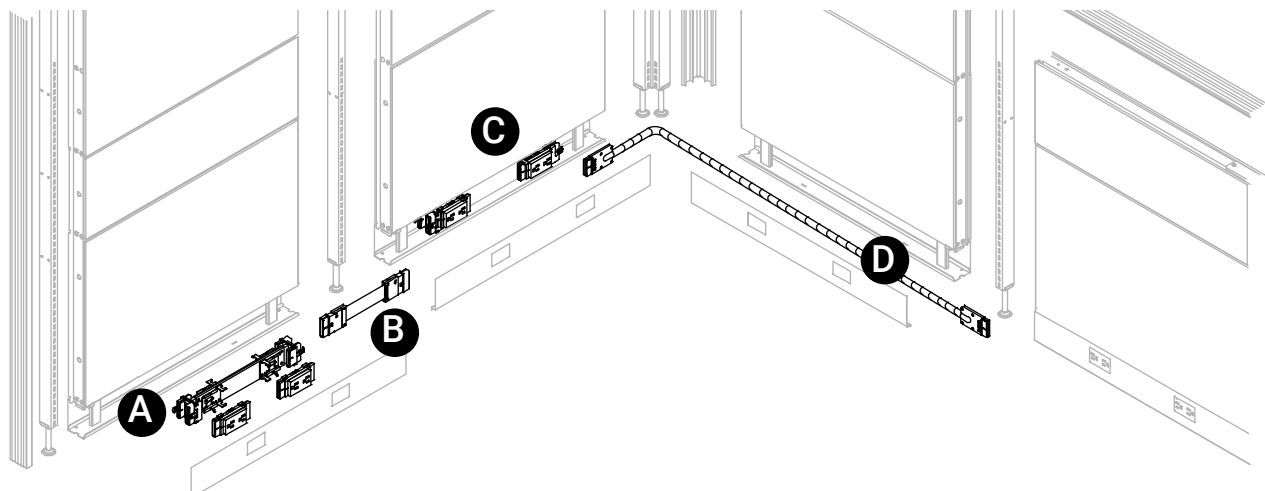

EVE8CI-1 • “I” Connector

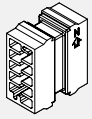

- Female - Female connector used to connect two Pass-Through Cables.

| PRODUCT CODE | PRICE | SIZE/ INCHES | | | WEIGHT VOL | |
|--------------|-------|--------------|----|------|------------|-----------------|
| | | H | W | D | LBS | FT ³ |
| EVE8CI-1 | 85 | 15 | 15 | 0.75 | 0.06 | 0.20 |

EVE8RD • Duplex Receptacles

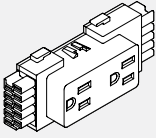

- Up to 6 duplex receptacles per circuit.
- EVE8RD1 = Circuit #1 (utility circuit)
- EVE8RD2 = Circuit #2 (utility circuit)
- EVE8RDA = Circuit #A (dedicated)
- EVE8RDB = Circuit #B (dedicated)

| PRODUCT CODE | PRICE | SIZE/ INCHES | | | WEIGHT VOL | |
|--------------|-------|--------------|-------|------|------------|-----------------|
| | | H | W | D | LBS | FT ³ |
| EVE8RD1 | 35 | 2 | 4.625 | 1.25 | 0.16 | 0.01 |
| EVE8RD2 | 35 | 2 | 4.625 | 1.25 | 0.16 | 0.01 |
| EVE8RDA | 35 | 2 | 4.625 | 1.25 | 0.16 | 0.01 |
| EVE8RDB | 35 | 2 | 4.625 | 1.25 | 0.16 | 0.01 |

EVEUSB01 • Duplex Receptacles

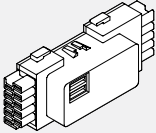

- The USB charging module provides convenient charging power access through dual ports on face of the receptacle.
- Two USB ports.
- 2 Amp output via two USB ports, considered as circuit #1.
- Available in white, black.

| PRODUCT CODE | PRICE | SIZE/ INCHES | | | WEIGHT VOL | |
|--------------|-------|--------------|-------|------|------------|-----------------|
| | | H | W | D | LBS | FT ³ |
| EVEUSB01WHT | 238 | 2 | 4.625 | 1.25 | 0.16 | 0.01 |
| EVEUSB01BLK | 238 | 2 | 4.625 | 1.25 | 0.16 | 0.01 |

EVE8RDx-20 • Duplex Receptacles, 20AMP

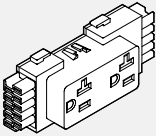

- Up to 6 receptacles per circuit (24 per infeed) not to exceed total 20 Amps per circuit.
- EVE8RD1 = Circuit #1 (utility circuit)
- EVE8RD2 = Circuit #2 (utility circuit)
- EVE8RDA = Circuit #A (dedicated)
- EVE8RDB = Circuit #B (dedicated)

| PRODUCT CODE | PRICE | SIZE/ INCHES | | | WEIGHT VOL | |
|--------------|-------|--------------|-------|-------|------------|-----------------|
| | | H | W | D | LBS | FT ³ |
| EVE8RD1-20 | 40 | 2 | 4.625 | 1.25 | 0.16 | 0.01 |
| EVE8RD2-20 | 40 | 2 | 4.625 | 1 1/4 | 0.16 | 0.01 |
| EVE8RDA-20 | 40 | 2 | 4.625 | 1 1/4 | 0.16 | 0.01 |
| EVE8RDB-20 | 40 | 2 | 4.625 | 1 1/4 | 0.16 | 0.01 |

EVE8FR1 • Reversible Floor Power Entry

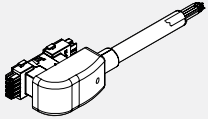

- Takes the place of a duplex receptacle by snapping into the base power way.
- Includes 72" long liquid-tight conduit.
- Must be hard wired to source power by a licenced electrician.

| PRODUCT CODE | PRICE | SIZE/ INCHES | WEIGHT VOL | |
|--------------|-------|--------------|------------|------|
| | | | L | LBS |
| EVE8FR1 | 353 | 72 | 3.82 | 2.00 |

EVE8FR2 • Reversible Floor Power Entry

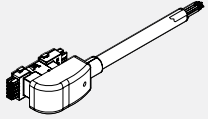

- Takes the place of a duplex receptacle by snapping into the base power way.
- Includes 144" long liquid-tight conduit.
- Must be hard wired to source power by a licenced electrician.

| PRODUCT CODE | PRICE | SIZE/ INCHES | WEIGHT VOL | |
|--------------|-------|--------------|------------|------|
| | | | L | LBS |
| EVE8FR2 | 454 | 144 | 6.98 | 2.00 |

EVE8FP • Floor Power Supply

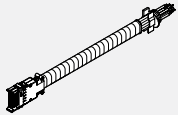

- Snaps in end of power distribution housing
- Includes flexible vinyl conduit
- Must be hard wired to source by licenced electrician
- Diameter is 0,85"

| PRODUCT CODE | PRICE | SIZE/ INCHES | WEIGHT VOL | |
|--------------|-------|--------------|------------|-----|
| | | | L | LBS |
| EVE8F1P | 353 | 72 | 3.82 | 2 |
| EVE8F2P | 454 | 144 | 6.98 | 2 |

EVE8PD • Power Distribution Housing

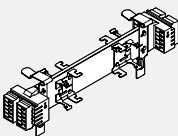

- Power housing is specified per panel size. eg. EVE8PD36 is for use with a 36" panel.
- 8 wire, 4 circuits (A and B circuits are dedicated).
- Provides two duplex receptacles per panel side on all panel widths above the 24" wide panel.
- 24" wide panel allows for only one (1) duplex receptacle per panel side.

| PRODUCT CODE | PRICE | SIZE/ INCHES | WEIGHT VOL | |
|--------------|-------|--------------|------------|------|
| | | | W | LBS |
| EVE8PD24 | 156 | 9.25 | 0.83 | 1.17 |
| EVE8PD30 | 208 | 15.25 | 1.28 | 1.17 |
| EVE8PD36 | 220 | 21.25 | 1.62 | 1.65 |
| EVE8PD42 | 226 | 27.25 | 2.00 | 2.00 |
| EVE8PD48 | 238 | 33.25 | 0.18 | 0.16 |
| EVE8PD54 | 242 | 39.25 | 2.66 | 3.20 |
| EVE8PD60 | 243 | 45.25 | 3.04 | 3.20 |
| EVE8PD66 | 253 | 51.25 | 3.49 | 3.25 |
| EVE8PD72 | 262 | 57.20 | 3.76 | 3.30 |

EVE8CT • Transition Cable

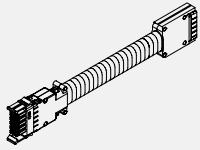

- The EVE8CT16 electrically connects an EVEPD Power Distribution Housing (pre-April 1, 2005) to an EVE8PD Power Distribution Housing when connecting powered panels that are positioned side by side.
- The EVE8CT20 electrically connects an EVEPD Power Distribution Housing (pre-April 1, 2005) to an EVE8PD Power Distribution Housing when connecting powered panels that are separated by a post.
- If there is one or more pass-through panels that contain the old Power Distribution Housing (pre-April 1, 2005) and a panel that contains the new Power Distribution Housing, then an EVE9CI-1 "I" Connector can be attached to the Transition Jumper Cable. This allows for the addition of an appropriate EVE8CP Pass-Through Cable to span the gap between the EVE8CT Transition Cable and the EVE8PD Power Distribution Housing.

| PRODUCT CODE | PRICE | SIZE/ INCHES | WEIGHT LBS | VOL FT ³ |
|--------------|-------|--------------|------------|---------------------|
| EVE8CT16 | 128 | 16 | 0.78 | 1.17 |
| EVE8CT20 | 147 | 20 | 0.92 | 1.17 |

EVE8CP • Jumper Cable

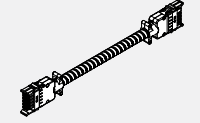

- The EVE8CP16 electrically connects two powered panels positioned side by side.
- The EVE8CP20 electrically connects two powered panels separated by a post.

| PRODUCT CODE | PRICE | SIZE/ INCHES | WEIGHT LBS | VOL FT ³ |
|--------------|-------|--------------|------------|---------------------|
| EVE8CP16 | 128 | 16 | 0.66 | 1.17 |
| EVE8CP20 | 147 | 20 | 0.78 | 1.17 |

EVE8CP-H • Hybrid Pass Through Cables with Wire Mesh

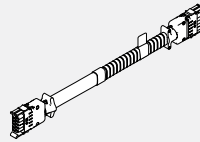

- Flexible metal conduit with wire mesh distributes electrical power through non powered panels.
- To calculate the length of Hybrid Pass Through Cable, add the width of non powered panels separating the powered panels. To this add 16" (distance from edge of the panels to power distribution housing x2).
- Please add an additional 3" when passing through a post. Please see the the beginning of this section.
- Hybrid Pass Through Cables with wire mesh allows connection at 90 degree post and one end for Power Beam.

| PRODUCT CODE | PRICE | SIZE/INCHES | | | WEIGHT LBS | VOL FT ³ |
|--------------|-------|-------------|-----|---|------------|---------------------|
| | | H | W | D | | |
| EVE8CP40-H | 196 | | 40 | | 1.44 | 1.17 |
| EVE8CP46-H | 204 | | 46 | | 1.71 | 1.17 |
| EVE8CP52-H | 212 | | 52 | | 1.95 | 1.17 |
| EVE8CP58-H | 226 | | 58 | | 2.21 | 1.17 |
| EVE8CP64-H | 235 | | 64 | | 2.37 | 1.17 |
| EVE8CP70-H | 240 | | 70 | | 2.60 | 1.17 |
| EVE8CP76-H | 244 | | 76 | | 2.81 | 1.17 |
| EVE8CP82-H | 255 | | 82 | | 3.03 | 1.17 |
| EVE8CP88-H | 264 | | 88 | | 3.05 | 1.17 |
| EVE8CP94-H | 273 | | 94 | | 3.42 | 1.17 |
| EVE8CP100-H | 281 | | 100 | | 3.47 | 1.17 |
| EVE8CP106-H | 292 | | 106 | | 3.87 | 1.17 |
| EVE8CP118-H | 309 | | 118 | | 4.08 | 1.17 |
| EVE8CP130-H | 337 | | 130 | | 4.73 | 1.17 |
| EVE8CP142-H | 351 | | 142 | | 4.89 | 1.17 |

EVE8CP • Pass Through Cable

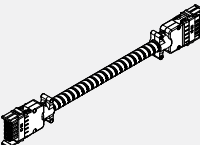

- Flexible metal conduit is used to distribute electrical power through non-powered panels.
- To calculate the length of a Pass-Through Cable, add the widths of the non-powered panels separating the powered panels (panels with distribution housing attached). To this, add 16" (distance from the edge of the panel to the distribution housing x 2). See Technical Information page at the beginning of this section.

| PRODUCT CODE | PRICE | SIZE/ INCHES | WEIGHT LBS | VOL FT ³ |
|--------------|-------|--------------|------------|---------------------|
| EVE8CP40 | 164 | 40 | 1.44 | 1.17 |
| EVE8CP46 | 169 | 46 | 1.71 | 1.17 |
| EVE8CP52 | 177 | 52 | 1.95 | 1.17 |
| EVE8CP58 | 188 | 58 | 2.21 | 1.17 |
| EVE8CP64 | 196 | 64 | 2.37 | 1.17 |
| EVE8CP70 | 200 | 70 | 2.60 | 1.17 |
| EVE8CP76 | 204 | 76 | 2.81 | 1.17 |
| EVE8CP82 | 213 | 82 | 3.03 | 1.17 |
| EVE8CP88 | 220 | 88 | 3.05 | 1.17 |
| EVE8CP94 | 228 | 94 | 3.92 | 1.17 |
| EVE8CP100 | 233 | 100 | 3.47 | 1.17 |
| EVE8CP106 | 243 | 106 | 3.87 | 1.17 |
| EVE8CP118 | 257 | 118 | 4.08 | 1.17 |
| EVE8CP130 | 281 | 185 | 4.73 | 1.17 |
| EVE8CP142 | 293 | 142 | 4.59 | 1.17 |

EVE8CP18 • Flexible Mesh Jumper Cable

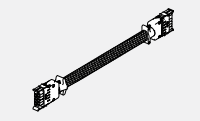

- Electrically connects two powered panels separated by post.
- Used to connect two power distribution housing in Power Beam at 90 degrees.

| PRODUCT CODE | PRICE | SIZE/INCHES | | | WEIGHT LBS | VOL FT ³ |
|--------------|-------|-------------|------|---|------------|---------------------|
| | | H | W | D | | |
| EVE8CP18 | 147 | | 18.5 | | 0.78 | 1.17 |

EVH8RC • Raceway Covers

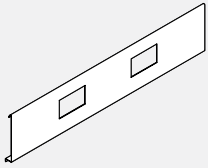

- Raceway Covers with 1.35 x 2.68" duplex receptacle openings.
- Includes 2 receptacle opening shields.
- Raceway Covers are sold individually.
- Used when adding to existing panel installation ordered prior to April 1, 2005.

| PRODUCT CODE | PRICE | SIZE/ INCHES | | WEIGHT VOL | |
|--------------|-------|--------------|----|------------|-----------------|
| | | H | W | LBS | FT ³ |
| EVH8RC24 | 30 | 6 | 24 | 1.00 | 0.11 |
| EVH8RC30 | 37 | 6 | 30 | 1.10 | 0.12 |
| EVH8RC36 | 41 | 6 | 36 | 1.20 | 0.13 |
| EVH8RC42 | 48 | 6 | 42 | 1.30 | 0.14 |
| EVH8RC48 | 58 | 6 | 48 | 1.40 | 0.15 |
| EVH8RC54 | 66 | 6 | 54 | 1.40 | 0.15 |
| EVH8RC60 | 68 | 6 | 60 | 1.50 | 0.16 |

EVH8RA • Raceway Opening Adapter

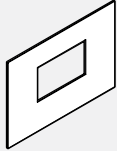

- Used when using new electrical and adding to existing panel installation ordered prior to April 1, 2005.
- PVC Adapter reduces the size of the Duplex Receptacle opening to accommodate the new style Duplex Receptacles.
- Pressure fits inside existing (old style) Raceway Cover.
- Opening size is 1.35" x 2.68".
- Sold in packs of 12, black only.

| PRODUCT CODE | PRICE | SIZE/ INCHES | | WEIGHT VOL | |
|--------------|-------|--------------|----|------------|-----------------|
| | | W | L | LBS | FT ³ |
| EVH8RA01 | 93 | 16 | 16 | 0.01 | 0.01 |

EVE8EC • Ceiling Power Entry

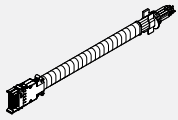

- Snaps into the end of Power Distribution Housing.
- Flexible metal conduit extends into the ceiling through a corner post and post extension (both ordered separately).
- Must be hard wired to source power by a licensed electrician.
- 4" Junction Box included.

| PRODUCT CODE | PRICE | SIZE/ L | INCHES | | WEIGHT VOL | |
|--------------|-------|---------|--------|------|------------|-----------------|
| | | | W | H | LBS | FT ³ |
| EVE8EC1 | 268 | 132 | 5.24 | 2.00 | | |
| EVE8EC2 | 479 | 144 | 5.96 | 2.00 | | |

EVDPE • Post Extension Data/Comm Lay-in

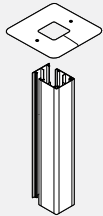

- Attaches to the top of a post to bring power and/or data cables from the ceiling to panel power way.
- Three-sided power pole with snap-on fourth side.
- Post extension can be opened on one side for lay-in for power and/or data cables.
- Made of aluminum and can be field cut.
- Accommodates up to 25 CAT5 cables with electric. Accommodates up to 45 CAT5 cables without electric.
- Ceiling infeed installed on one way post with T Leg requires securing post with two Floor mount plates.
- Post extension bigger than 82" is made of two parts.

| PRODUCT CODE | PRICE | SIZE/ H | INCHES | | WEIGHT VOL | |
|--------------|-------|---------|--------|------|------------|-----------------|
| | | | W | L | LBS | FT ³ |
| EVDPE64 | 160 | 64 | 2.875 | 3.00 | 0.70 | |
| EVDPE82 | 197 | 82 | 2.875 | 4.20 | 0.80 | |
| EVDPE88 | 302 | 88 | 2.875 | 4.50 | 0.85 | |
| EVDPE94 | 323 | 94 | 2.875 | 4.80 | 0.92 | |
| EVDPE100 | 344 | 100 | 2.875 | 5.12 | 0.97 | |

EVDP4E • 45° Post Extension Data/Comm Lay-in



- Attached to the top of the 45° Corner Post to bring power and/or data cables from the ceiling to the panel run through.
- Cable Capacity
 - 40 CAT5 cables without electric feed.
 - 10 CAT5 cables with electric feed.

| PRODUCT CODE | PRICE | SIZE/ H | INCHES | | WEIGHT VOL | |
|--------------|-------|---------|--------|------|------------|-----------------|
| | | | W | L | LBS | FT ³ |
| EVDP4E64 | 162 | 64 | 3.65 | 3.00 | 0.70 | |
| EVDP4E82 | 218 | 82 | 3.65 | 4.20 | 0.80 | |

EVDP6E • 60° Post Extension Data/Comm Lay-in



- Attached to the top of the 60° Corner Post to bring power and/or data cables from the ceiling to the panel run through.
- Post extension can be opened on one side for lay-in power and/or data cables.
- Made of aluminum and can be field cut.
- Two sided power pole with snap-on third side.
- Cable Capacity
 - 32 CAT5 cables without electric.
 - 15 CAT5 cables with electric

| PRODUCT CODE | PRICE | SIZE/ H | INCHES | | WEIGHT VOL | |
|--------------|-------|---------|--------|------|------------|-----------------|
| | | | W | L | LBS | FT ³ |
| EVDP6E64 | 157 | 64 | 2 | 3.00 | 0.70 | |
| EVDP6E82 | 192 | 82 | 2 | 4.20 | 0.80 | |

EVEJBC1 • Hardwire Junction Box

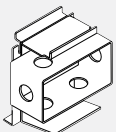

- Provides economical single circuit capability.
- Can be used in addition to 8 wire system to support isolated hospital power.
- Can be retrofitted in any size of panel at the receptacle location.
- Gives access from one side only at each location.
- Customer to supply conduit, wiring, receptacle, and face plate.
- A licensed electrician must provide hardwire connection with the junction box.

| PRODUCT CODE | PRICE | WEIGHT VOL | |
|--------------|-------|------------|-----------------|
| | | LBS | FT ³ |
| EVEJBC1 | 105 | 1.50 | 0.02 |

Power Beam

- All metal components are painted with environmentally friendly epoxy powder.
- Raceway interiors are coated with recycled epoxy powder.
- The entire Evolve Power Beam and the processes used to manufacture it are designed to save and protect the environment. Evolve panels are made from recycled materials and are 100% recyclable.
- Components conform to CGSB and ANSI/BIFMA Standards.
- The quality and performance level of these panels have been tested to equal or exceed the requirements of the U.S. Government.
- Power Beam has a steel frame and is 2 7/8" thick. Corner posts create a panel creep of 3 1/4".
- Leveling glides extend 1 1/2" high.

Power Beam Options

- Power Beams are available in the following heights: 24", 30", and 36".
- Module widths come in seven (7) sizes: 36", 42", 48", 54", 60", 66" and 72".
- Straight, 90 degree & 120 degree.

Extension Module Options

- Acoustic Fabric (Tackable), Glazed, Open, Laminate, Whiteboard, Air Flow.
- Attaches to the top of the Power Beam or another extension module (not to exceed 42" above finished floor).
- Offered in 6", 12", and 18" heights.
- Can be stacked up to 42" high above the finished floor (A.F.F.).

Beam Reconfiguration

- Extension Modules can be modified on site by replacing fabric modules with Glazed, Open, Laminate, Whiteboard or Air Flow at any time after the initial installation.
- Fabric can be replaced easily; using pre-cut segments of fabric, a drawstring (C-Jex) is sewn in around the edges. Then a rubber spline is used to 'screen' the fabric in place.

Voice/Data And Electrical Power

- NOTE: Panels and Electric components are CSA/UL approved. Tools are not required to install electrical in the Power Beam.

Electric Information

- Electric can be run in all three Power Beam heights (24" h, 30" h or 36" h).
 - 8-Wire, 4 circuit capability
 - 2 utility + 2 dedicated circuits
 - 10 gauge (oversized) neutrals
- All circuits can support up to 15 a max.
- Contact Evolve customer care for additional wiring options.

Raceway Information

- Raceway knockouts sizes conform to the ANSI/TIA/ EIA Furniture Opening Standard of 1.38" x 2.71".
- Power Beam raceway covers 36"-60" wide accommodate knockouts for two electrical duplexes and one communication face plate on each side. 66" wide beam accommodates 4 electrical duplexes and one communication face plate on each side. 72" wide beam accommodates 4 duplex receptacles and 2 communication face plates on each side.
- Standard data face mount plates can be used without the need of adapter plates (supplied by others).
- Cabling capacities (calculations below are based on .25" diameter communication cables.)
- Power Modules:
 - Without electric – 65 Cables
 - With electric – 54 Cables
- Panel Connectors - 90 Degree Connector Posts:
 - Without electric – 45 cables
 - With electric – 25 Cables

Work Tables

- Freestanding tables
 - Foli height adjustable (23" or 29"d)
 - Bungee (20", 24" or 30"d)
 - Junction (20", 24" or 30"d)
 - 2gether (18" or 24"d)

Power Beam is a freestanding beam system and does not support attachment of an Evolve brackets or overhead storage including cantilevers or other support brackets.

Features, Benefits & General Information

Technical Features of Power Beam:

- Evolve Power Beam is 2 7/8" thick.
- An aluminum low profile top cap is included with Power Beams.
- Power Beam will accommodate 65 x 0.25" diameter communication cables without electrical or 54 x 0.25" diameter communication cables with electrical.
- 90-degree post extension accommodates 45 x 0.25" diameter communication cables without electrical and 25 x 0.25" diameter communication cables with electric.
- Raceway knockout openings are 1.38" x 2.71".

Basic Features of Power Beam

- Power Beam is available in three (3) heights: 24" h, 30" h and 36" h; and seven (7) widths: 36" w, 42" w, 48" w, 54" w, 60" w, 66" w and 72" w.
- There is no panel creep in a straight Beam-to-Beam configuration; however, a corner post (2, 3, 4 way) will add 3.25" inches to a beam run.

Basic Features of Extension Modules

- Extension modules stack on the top of a Power Beam or another extension module (maximum height - 42" h, above finished floor).
- Fabric extension modules may have different fabrics on opposite sides within the same grade with no up-charge.
- If different grades of fabric are used on one module, the entire modules will be priced utilizing the fabric with the highest grade.

Power Beam Parts

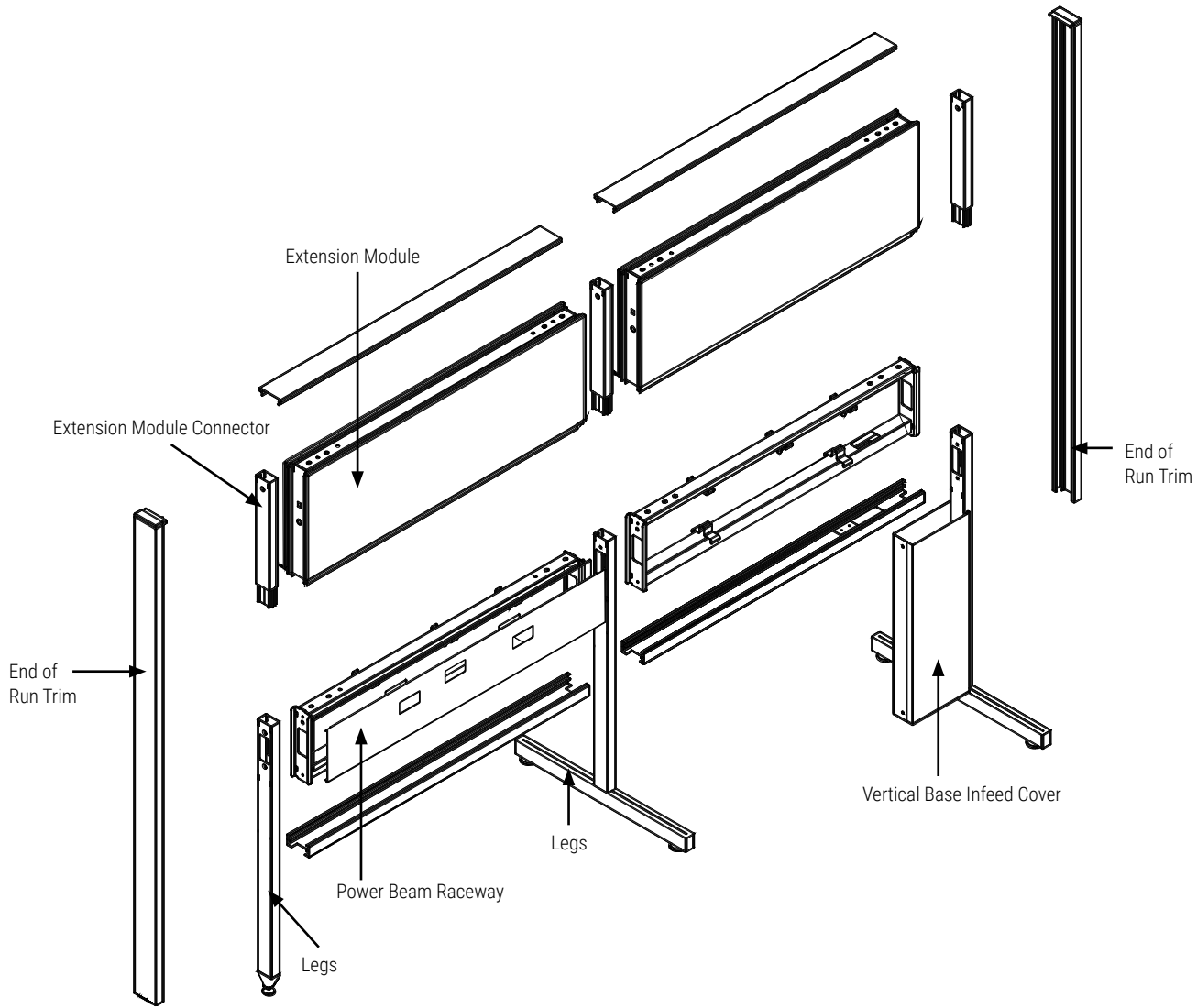

Extension Module Materials

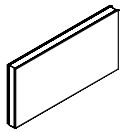

Fabric

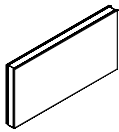

Laminate

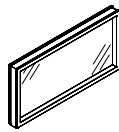

Glass



Write Board

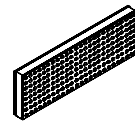

Airflow

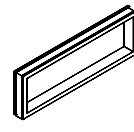

Open

EVPB • Power Beam

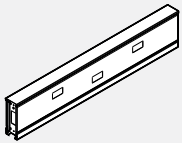

- Aluminum top trim and bottom trim included
- No access for base infeed
- Support legs ordered separately

| PRODUCT CODE | PRICE | SIZE/ INCHES | | | WEIGHT VOL | |
|--------------|-------|--------------|----|-------|------------|-----------------|
| | | H | W | D | LBS | FT ³ |
| EVPB36 | 215 | 6 | 36 | 2.875 | 15.5 | 0.48 |
| EVPB42 | 237 | 6 | 42 | 2.875 | 17.1 | 0.56 |
| EVPB48 | 256 | 6 | 48 | 2.875 | 18.6 | 0.64 |
| EVPB54 | 281 | 6 | 54 | 2.875 | 20.2 | 0.72 |
| EVPB60 | 306 | 6 | 60 | 2.875 | 21.8 | 0.80 |

EVPB • 6" High Power Beam

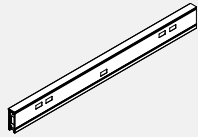

- One piece aluminum top trim and one piece aluminum bottom trim included.

| PRODUCT CODE | PRICE | SIZE/ INCHES | | | WEIGHT VOL | |
|--------------|-------|--------------|----|-------|------------|-----------------|
| | | H | W | D | LBS | FT ³ |
| EVPB66 | 479 | 6 | 66 | 2.875 | 31 | 0.91 |
| EVPB72 | 495 | 6 | 72 | 2.875 | 32 | 1.00 |

EVPBE • Power Beam with Electrical Cut-out for Base Feed

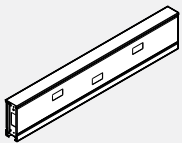

- Power beam with bottom cut out (on one end) for base infeed
- Aluminum top and bottom trims included
- Bottom trim has a cut out on one side for electrical access and a bracket to connect to the vertical base infeed cover (ordered separately)
- Vertical base infeed cover with support leg ordered separately

| PRODUCT CODE | PRICE | SIZE/ INCHES | | | WEIGHT VOL | |
|--------------|-------|--------------|----|-------|------------|-----------------|
| | | H | W | D | LBS | FT ³ |
| EVPBE36 | 227 | 6 | 36 | 2.875 | 15.5 | 0.48 |
| EVPBE42 | 252 | 6 | 42 | 2.875 | 17.1 | 0.56 |
| EVPBE48 | 276 | 6 | 48 | 2.875 | 18.6 | 0.64 |
| EVPBE54 | 297 | 6 | 54 | 2.875 | 20.2 | 0.72 |
| EVPBE60 | 325 | 6 | 60 | 2.875 | 21.8 | 0.80 |

EVPBE • Power Beam Kit with Electrical Cut-out for Base Feed

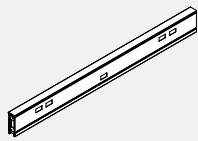

- 66" Power Beam Kit consists of (1) 30" Power Beam and (1) 36" Power Beam with bottom cut out on one side for a base infeed. Inline connector and hardware included.
- Vertical base infeed cover with support leg ordered separately.

| PRODUCT CODE | PRICE | SIZE/ INCHES | | | WEIGHT VOL | |
|--------------|-------|--------------|----|-------|------------|-----------------|
| | | H | W | D | LBS | FT ³ |
| EVPBE66 | 507 | 6 | 66 | 2.875 | 31 | 0.91 |
| EVPBE72 | 524 | 6 | 72 | 2.875 | 32 | 1.00 |

EVPBEP-KIT • Power Beam with Electrical Cut-out for Pass Through Cabinet

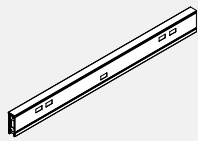

- Power beam with electrical cutout for base feed from pass through cabinet.
- Aluminum top trim included.
- 60" Power beam kit includes two 30" power distribution housing (EVE8PD30) and jumper cable (EVE8CP17).
- 72" Power beam kit includes two 36" power distribution housing (EVE8PD36) and jumper cable (EVE8CP17).
- Provides two duplex receptacle per panel side.
- Power beam base feed to be ordered separately.
- Power beam storage cabinet with pass through be ordered separately (EVPBSCGDP or EVPBSCP).
- Note: To be used with cable pass through cabinet EVPBSSCGDPR/L.

| PRODUCT CODE | PRICE | SIZE/ INCHES | | | WEIGHT VOL | |
|--------------|-------|--------------|----|-------|------------|-----------------|
| | | H | W | D | LBS | FT ³ |
| EVPBEP60KIT | 789 | 6 | 60 | 2.875 | 23.4 | 0.86 |
| EVPBEP72KIT | 1000 | 6 | 72 | 2.875 | 25.1 | 0.96 |

EVPBEP-KIT01 • Power Beam with Electrical Cut-out for Pass Through Cabinet with Two Raceway Covers per Side

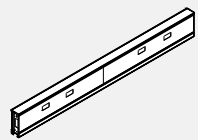

- Power beam with electrical cut out for base feed from pass through cabinet.
- Aluminum top trim included.
- 60" Power beam kit includes two 30" raceway covers per side.
- 72" Power beam kit includes two 36" raceway covers per side.
- 60" Power beam kit includes two 30" power distribution housing (EVE8PD30) and jumper cable (EVE8CP17).
- 72" Power beam kit includes two 36" power distribution housing (EVE8PD36) and jumper cable (EVE8CP17).
- Provides four duplex receptacle per panel side.
- Power beam base feed to be ordered separately.
- Power beam storage cabinet with pass through be ordered separately (EVPBSCGDP or EVPBSCP).
- Note: To be used with cable pass through cabinet EVPBSSCGDPR/L.

| PRODUCT CODE | PRICE | SIZE/ INCHES | | | WEIGHT VOL | |
|---------------|-------|--------------|----|-------|------------|-----------------|
| | | H | W | D | LBS | FT ³ |
| EVPBEP60KIT01 | 789 | 6 | 60 | 2.875 | 23.4 | 0.88 |
| EVPBEP72KIT01 | 1000 | 6 | 72 | 2.875 | 25.1 | 0.96 |

EVPBFCL • Vertical Base Power Feed Cover with Leg

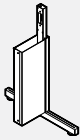

- Connects to Power Beam Kit with electrical cut out.
- Includes vertical cover and slotted connector support leg with foot.
- Power Beam kit with electrical cut out ordered separately.
- Base infeed ordered separately.

| PRODUCT CODE | PRICE | SIZE/ INCHES | | | WEIGHT VOL | |
|--------------|-------|--------------|---|----|------------|-----------------|
| | | H | W | D | LBS | FT ³ |
| EVPBFCL24 | 195 | 24 | 6 | 21 | 10.1 | 1.75 |
| EVPBFCL30 | 218 | 30 | 6 | 21 | 11.2 | 2.18 |
| EVPBFCL36 | 240 | 36 | 6 | 21 | 12.3 | 2.62 |

EVPBFCSL • Base Power Feed Cover with Single Leg

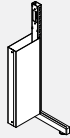

- Connects to Power Beam Kit with electrical cut out
- Includes vertical cover and slotted connector support with single leg.
- For one sided Power beam application.
- Laminate end panels must be attached to single leg at the end of power beam run for stability.
- Laminate end panels to be ordered separately.
- End of run trim below power beam included.
- Power beam with electrical cut out to be ordered separately.
- Note: Cannot be used with Power Beam storage or Power Beam overhead.

| PRODUCT CODE | PRICE | SIZE/ INCHES | | | WEIGHT VOL | |
|--------------|-------|--------------|---|----|------------|-----------------|
| | | H | W | D | LBS | FT ³ |
| EVPBFCSL24 | 186 | 24 | 6 | 21 | 10.10 | 1.75 |
| EVPBFCSL30 | 208 | 30 | 6 | 21 | 11.20 | 2.18 |
| EVPBFCSL36 | 228 | 36 | 6 | 21 | 12.30 | 2.62 |

EVPBFCLS • Vertical Base Power Feed Cover with Slotted Leg

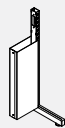

- Slotted connector allows for the attachment of brackets for worksurfaces.
- Connects two Power Beams on equal height.
- Includes vertical covers, slotted connector with leg and end of run trim below the Power Beam.
- Note: Power Beam must be installed in stable configuration using two way posts, three way posts or four way posts to provide support for worksurfaces.

| PRODUCT CODE | PRICE | SIZE/ INCHES | | | WEIGHT VOL | |
|--------------|-------|--------------|---|----|------------|-----------------|
| | | H | W | D | LBS | FT ³ |
| EVPBFCLS24 | 186 | 24 | 6 | 21 | 10.10 | 1.75 |
| EVPBFCLS30 | 208 | 30 | 6 | 21 | 11.20 | 2.18 |
| EVPBFCLS36 | 228 | 36 | 6 | 21 | 12.30 | 2.62 |

EVPBF CG • Vertical Base Power Feed Cover with Glide

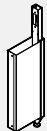

- Connects to Power Beam Kit with electrical cut out
- Includes vertical cover and slotted connector support leg with glide.
- Power Beam Kit with electrical cut out ordered separately.
- Base infeed ordered separately.

| PRODUCT CODE | PRICE | SIZE/ INCHES | | | WEIGHT VOL | |
|--------------|-------|--------------|---|---|------------|-----------------|
| | | H | W | D | LBS | FT ³ |
| EVPBF CG24 | 162 | 24 | 6 | 3 | 7.1 | 0.25 |
| EVPBF CG30 | 183 | 30 | 6 | 3 | 8.4 | 0.31 |
| EVPBF CG36 | 205 | 36 | 6 | 3 | 9.7 | 0.38 |

EVPBF CGS • Vertical Base Power Feed Cover with Glide and Slotted Connector

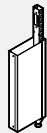

- Slotted connector allows for the attachment of brackets for worksurfaces.
- Connects two Power Beams on equal height.
- Includes vertical covers, slotted connector with glide base and end of run trim below Power Beam.
- Power Beam with electrical cut out to be ordered separately.
- Note: Power Beam must be installed in stable configuration using two way posts, three way posts or four way posts to provide support for worksurfaces.

| PRODUCT CODE | PRICE | SIZE/ INCHES | | | WEIGHT VOL | |
|--------------|-------|--------------|---|---|------------|-----------------|
| | | H | W | D | LBS | FT ³ |
| EVPBF CGS24 | 154 | 24 | 6 | 3 | 7.10 | 0.25 |
| EVPBF CGS30 | 173 | 30 | 6 | 3 | 8.40 | 0.31 |
| EVPBF CGS36 | 194 | 36 | 6 | 3 | 9.70 | 0.38 |

EVPBF CGS • Vertical Base Power Feed Cover with Glide



- 42" H Slotted connector allows to attached brackets for worksurfaces
- Connects to electrical cut out power beam
- Includes vertical covers and slotted connector with glide base
- End of run trim below power beam included
- Power beam with electrical cut out to be ordered separately
- Note: Power beam to be installed in stable configuration using two way posts, three way posts, four way posts to provide support for worksurfaces

| PRODUCT CODE | PRICE | SIZE/ INCHES | | | WEIGHT VOL | |
|--------------|-------|--------------|---|---|------------|-----------------|
| | | H | W | D | LBS | FT ³ |
| EVPB24FCGS42 | 190 | 42 | 6 | 3 | 10.40 | 0.43 |
| EVPB30FCGS42 | 204 | 42 | 6 | 3 | 10.40 | 0.43 |
| EVPB36FCGS42 | 224 | 42 | 6 | 3 | 10.40 | 0.43 |

EVPBGFC • Power Beam Gallery Base Feed Cover



- Connects to electrical cut out power beam attached to gallery panels.
- Includes vertical covers and slotted connector attaches to gallery panel.
- Power beam with electrical cut out to be ordered separately.

| PRODUCT CODE | PRICE | SIZE/ INCHES | | | WEIGHT VOL | |
|--------------|-------|--------------|---|---|------------|-----------------|
| | | H | W | D | LBS | FT ³ |
| EVPBGFC24 | 156 | 24 | 6 | 3 | 7.1 | 0.25 |
| EVPBGFC30 | 177 | 30 | 6 | 3 | 8.40 | 0.31 |
| EVPBGFC36 | 195 | 36 | 6 | 3 | 9.70 | 0.38 |

EVPBGDP • Power Beam Gallery Panel Data Post / Comm Lay-In



- Attaches to Power beam gallery end panel to bring power and/or data cables from ceiling to power beam.
- Three-sided power pole with snap-on fourth side.
- Made of aluminum and can be field cut.
- Standard data post extension used above.
- Accommodates up to 25 CAT 5 cables with electric, up to 45 CAT 5 cables without electric.
- Standard data post extension to be ordered separately.
- Standard code is for 24" H power beam. Please add at code end for option. B- 30" h Power beam. C- 36" h Power beam.

| PRODUCT CODE | PRICE | SIZE/ INCHES | | | WEIGHT VOL | |
|--------------|-------|--------------|---|---|------------|-----------------|
| | | H | W | D | LBS | FT ³ |
| EVPBGDP42 | 149 | 42 | 2 | 2 | 2.20 | 0.60 |
| EVPBGDP48 | 165 | 48 | 2 | 2 | 3.00 | 0.70 |
| EVPBGDP54 | 202 | 54 | 2 | 2 | 4.20 | 0.80 |

EVE8FR3PBD • Double Entry for Power Beam

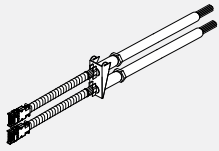

- Each power feed entry snaps into separate power distribution housing.
- Includes two 84" long flexible vinyl conduit.
- Includes double bracket to attach to Verticle base power feed cover leg.
- Must be installed in middle between two power beams, one base feed plugs to powerbeam on opposite side of leg than attached bracket.
- Vertical base power feed cover with leg to be ordered seperately.
- Must be hardwired to source by licenced electrician.
- Note: Always determine that harness is electrically connected to only one power supply.

| PRODUCT CODE | PRICE | SIZE/ H | INCHES W | D | WEIGHT LBS | VOL FT ³ |
|--------------|-------|---------|----------|---|------------|---------------------|
| EVE8FR3PBD | 661 | | 84 | | 7.64 | 2.00 |

EVHCBP01 • Ceiling Bracket for Post

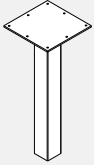

- Used to secure corner post to ceiling.
- 4.8"x4.8" top plate with 1.5x1.5 square tube 12" H , square tube fits inside aluminum corner post.
- Square tube can slide in post, bracket pushed to ceiling to be secured.

| PRODUCT CODE | PRICE | SIZE/ H | INCHES W | D | WEIGHT LBS | VOL FT ³ |
|--------------|-------|---------|----------|-----|------------|---------------------|
| EVHCBP01 | 60 | 12 | 4.8 | 4.8 | 3.2 | 0.18 |

EVHCBIC01 • Ceiling Bracket for Inline Connector

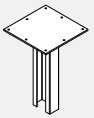

- Used to secure corner post to ceiling .
- 4.8"x4.8" top plate with 7.5" h insert in middle of plate, insert its inside connector.
- 7.5" H insert can slide in connector, bracket pushed to ceiling to secure.
- Note: Care should be taken to attach ceiling brackets to secure ceiling using correct fastners.
- Failure to do so may result in collapse of unit and subsequent possible injury.

| PRODUCT CODE | PRICE | SIZE/ H | INCHES W | D | WEIGHT LBS | VOL FT ³ |
|--------------|-------|---------|----------|-----|------------|---------------------|
| EVHCBIC01 | 60 | 7.5 | 4.8 | 4.8 | 3.2 | 0.18 |

EVHCBER01 • Ceiling Bracket for End of Run Connector

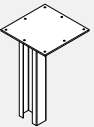

- Used to secure corner post to ceiling.
- 4.8"x4.8" top plate with 7.5" h insert in middle of plate, insert its inside connector.
- 7.5" H insert can slide in connector , bracket pushed to ceiling to secure.
- Note: Care should be taken to attach ceiling brackets to secure ceiling using correct fastners.
- Failure to do so may result in collapse of unit and subsequent possible injury.

| PRODUCT CODE | PRICE | SIZE/ H | INCHES W | D | WEIGHT LBS | VOL FT ³ |
|--------------|-------|---------|----------|-----|------------|---------------------|
| EVHCBIC01 | 80 | 7.5 | 4.8 | 4.8 | 3.2 | 0.18 |

EVPBL • Power Beam Connector with Leg

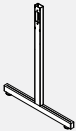

- Connects two Power Beams in a straight run.
- 24" h -- 18" open to floor.
- 30" h -- 24" open to floor.
- 36" h -- 30" open to floor.

| PRODUCT CODE | PRICE | SIZE/ H | INCHES W | D | WEIGHT LBS | VOL FT ³ |
|--------------|-------|---------|----------|---|------------|---------------------|
| EVPBL24 | 99 | 24 | 18 | 3 | 5.9 | 0.30 |
| EVPBL30 | 103 | 30 | 18 | 3 | 7.2 | 0.38 |
| EVPBL36 | 110 | 36 | 18 | 3 | 8.5 | 0.45 |

EVPBLS • Power Beam Slotted Connector with Leg

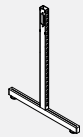

- Slotted connector allows for the attachment of brackets for worksurfaces.
- Connects two Power Beams on equal height.
- Includes slotted connector with leg, glides and connecting hardware.
- Note: Power Beam must be installed in stable configuration using two way posts, three way posts or four way posts to provide support for worksurfaces.

| PRODUCT CODE | PRICE | SIZE/ H | INCHES W | D | WEIGHT LBS | VOL FT ³ |
|--------------|-------|---------|----------|---|------------|---------------------|
| EVPBLS24 | 96 | 24 | 18 | 3 | 5.90 | 0.30 |
| EVPBLS30 | 99 | 30 | 18 | 3 | 7.20 | 0.38 |
| EVPBLS36 | 103 | 36 | 18 | 3 | 8.50 | 0.45 |

EVPBLFF • Power Beam Leg with Flat Foot

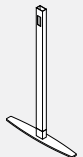

- Connects two power beams on equal height.
- Includes connector with flat foot, connecting hardware
- Note: Leg has to be used next to Post legs with glides.
- When specifying please keep sequence post leg with glide, leg with flat foot, post leg with glide.
- Only post legs with glide provides adjustment for levelling power beams run.

| PRODUCT CODE | PRICE | SIZE/ H | INCHES W | D | WEIGHT LBS | VOL FT ³ |
|--------------|-------|---------|----------|---|------------|---------------------|
| EVPBLFF24 | 116 | 24 | 21 | | 5.9 | 0.30 |
| EVPBLFF30 | 120 | 30 | 21 | | 7.2 | 0.38 |
| EVPBLFF36 | 125 | 36 | 21 | | 8.5 | 0.45 |

EVPBSL • Power Beam Single Leg

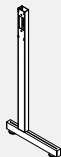

- Connects two Power Beams on equal height.
- Includes non slotted connector with leg, glides and connecting hardware.
- For one sided power beam application.
- Laminate end panels must be attached to single leg at end of power beam run for stability.
- Laminate end panels to be ordered seperately.
- Note: It can not be used with Power Beam storage or Power Beam overhead.

| PRODUCT CODE | PRICE | SIZE/ H | INCHES W | D | WEIGHT LBS | VOL FT ³ |
|--------------|-------|---------|----------|---|------------|---------------------|
| EVPBSL24 | 96 | 24 | 15 | 3 | 5.9 | 0.21 |
| EVPBSL30 | 99 | 30 | 15 | 3 | 7.2 | 0.26 |
| EVPBSL36 | 103 | 36 | 15 | 3 | 8.5 | 0.32 |

EVPBGICB • Power Beam Connector with Base for Glide



- Connects two Power Beams in a straight run.
- 24”h -- 18” open to floor.
- 30”h -- 24” open to floor.
- 36”h -- 30” open to floor.

| PRODUCT CODE | PRICE | SIZE/ INCHES | | | WEIGHT VOL | |
|--------------|-------|--------------|---|---|------------|-----------------|
| | | H | W | D | LBS | FT ³ |
| EVPBGICB24 | 67 | 24 | 2 | 3 | 3.30 | 0.03 |
| EVPBGICB30 | 69 | 30 | 2 | 3 | 4.60 | 0.04 |
| EVPBGICB36 | 72 | 36 | 2 | 3 | 5.90 | 0.04 |

EVPBGICBS • Power Beam Slotted Connector with Base for Glide



- Slotted connector allows for the attachment of brackets for worksurfaces.
- Connects two Power Beams of equal heights.
- Includes slotted connector with glide and connecting hardware.
- Note: Power Beam must be installed in stable configuration using two way posts, three way posts or four way posts to provide support for worksurfaces.

| PRODUCT CODE | PRICE | SIZE/ INCHES | | | WEIGHT VOL | |
|--------------|-------|--------------|---|---|------------|-----------------|
| | | H | W | D | LBS | FT ³ |
| EVPBGICBS24 | 63 | 24 | 2 | 3 | 3.30 | 0.03 |
| EVPBGICBS30 | 65 | 30 | 2 | 3 | 4.60 | 0.04 |
| EVPBGICBS36 | 68 | 36 | 2 | 3 | 5.90 | 0.04 |

EVPBGICBS • Power Beam Connector with Base for Glide



- 42” H Slotted connector allows to attached brackets for worksurfaces
- Connects two power beams on equal height and extension panel above
- Includes slotted connector with glide and connecting hardware
- Note: Power beam to be installed in stable configuration using two way posts, three way posts, four way posts to provide support for worksurfaces

| PRODUCT CODE | PRICE | SIZE/ INCHES | | | WEIGHT VOL | |
|---------------|-------|--------------|---|---|------------|-----------------|
| | | H | W | D | LBS | FT ³ |
| EVPB24GICBS42 | 99 | 42 | 2 | 3 | 6.60 | 0.16 |
| EVPB30GICBS42 | 99 | 42 | 2 | 3 | 6.60 | 0.16 |
| EVPB36GICBS42 | 99 | 42 | 2 | 3 | 6.60 | 0.16 |

EVPB24CPA • One Way Post with T Leg for 24” H Power Beam

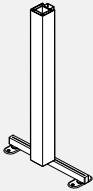

- One way post attaches to end of power beam run.
- Post and connecting hardware add 3.25 to power beam run.
- Includes post power beam T leg, post with trim all round, leveling glide, hardware and trim kit.
- Includes two floor mount plates to secure post to floor.

| PRODUCT CODE | PRICE | SIZE/ INCHES | | | WEIGHT VOL | |
|--------------|-------|--------------|---|---|------------|-----------------|
| | | H | W | D | LBS | FT ³ |
| EVPB24CPA124 | 271 | 24 | 3 | 3 | 5.5 | 0.75 |
| EVPB24CPA130 | 286 | 30 | 3 | 3 | 8.5 | 0.94 |
| EVPB24CPA136 | 298 | 36 | 3 | 3 | 11.5 | 1.12 |
| EVPB24CPA142 | 334 | 42 | 3 | 3 | 15 | 1.31 |

EVPB30CPA • One Way Post with T Leg for 30” H Power Beam

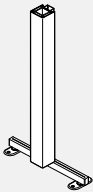

- One way post attaches to end of power beam run.
- Post and connecting hardware add 3.25 to power beam run.
- Includes post power beam T leg, post with trim all round, leveling glide, hardware and trim kit.
- Includes two floor mount plates to secure post to floor.

| PRODUCT CODE | PRICE | SIZE/ INCHES | | | WEIGHT VOL | |
|--------------|-------|--------------|---|---|------------|-----------------|
| | | H | W | D | LBS | FT ³ |
| EVPB30CPA130 | 286 | 30 | 3 | 3 | 8.5 | 0.94 |
| EVPB30CPA136 | 298 | 36 | 3 | 3 | 11.5 | 1.12 |
| EVPB30CPA142 | 334 | 42 | 3 | 3 | 15 | 1.31 |

EVPB36CPA • One Way Post with T Leg for 36” H Power Beam

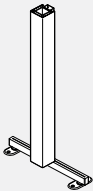

- One way post attaches to end of power beam run.
- Post and connecting hardware add 3.25 to power beam run.
- Includes post power beam T leg, post with trim all round, leveling glide, hardware and trim kit.
- Includes two floor mount plates to secure post to floor.

| PRODUCT CODE | PRICE | SIZE/ INCHES | | | WEIGHT VOL | |
|--------------|-------|--------------|---|---|------------|-----------------|
| | | H | W | D | LBS | FT ³ |
| EVPB36CPA136 | 298 | 36 | 3 | 3 | 11.5 | 1.12 |
| EVPB36CPA142 | 334 | 42 | 3 | 3 | 15 | 1.31 |

EVPBCEPLA4 • Power Beam 4-way Corner Post



- Connects four power beams of equal height in 90 degree configuration.
- Post and connecting hardware add 3.25” to power beam run.
- Includes one post, four nonslotted power beam connectors, post with trim all around, levelling glide, hardware and trim kit.

| PRODUCT CODE | PRICE | SIZE/ INCHES | | | WEIGHT VOL | |
|--------------|-------|--------------|---|---|------------|-----------------|
| | | H | W | D | LBS | FT ³ |
| EVPBCEPLA424 | 188 | 24 | 3 | 3 | 6.30 | 0.22 |
| EVPBCEPLA430 | 210 | 30 | 3 | 3 | 7.60 | 0.27 |
| EVPBCEPLA436 | 205 | 36 | 3 | 3 | 8.90 | 0.33 |

EVPBCEPLA3 • Power Beam 3-way Corner Post



- Connects three power beams of equal height in 90 degree configuration.
- Post and connecting hardware add 3.25" to power beam run.
- Includes one post, three nonslotted power beam connectors, post with trim all around, levelling glide, hardware and trim kit.

| PRODUCT CODE | PRICE | SIZE/ INCHES | | | WEIGHT VOL | |
|--------------|-------|--------------|---|---|------------|-----------------|
| | | H | W | D | LBS | FT ³ |
| EVPBCEPLA324 | 158 | 24 | 3 | 3 | 5.80 | 0.22 |
| EVPBCEPLA330 | 164 | 30 | 3 | 3 | 7.10 | 0.27 |
| EVPBCEPLA336 | 172 | 36 | 3 | 3 | 8.40 | 0.33 |

EVPBCEPLA2 • Power Beam 2-way Corner Post



- Includes one post, four nonslotted power beam connectors, post with trim all around, levelling glide, hardware and trim kit.
- Connects four power beams of equal height in 90 degree configuration.
- Post and connecting hardware add 3.25" to power beam run.

| PRODUCT CODE | PRICE | SIZE/ INCHES | | | WEIGHT VOL | |
|--------------|-------|--------------|---|---|------------|-----------------|
| | | H | W | D | LBS | FT ³ |
| EVPBCEPLA224 | 143 | 24 | 3 | 3 | 5.30 | 0.22 |
| EVPBCEPLA230 | 149 | 30 | 3 | 3 | 6.60 | 0.27 |
| EVPBCEPLA236 | 157 | 36 | 3 | 3 | 7.90 | 0.33 |

EVPBCIPLA2 • Power Beam In Line 2-way Corner Post



- Connects two power beams of equal height in inline configuration.
- Post and connecting hardware add 3.25" to power beam run.
- Includes one post, two nonslotted power beam connectors, post with trim all around, levelling glide, hardware and trim kit.

| PRODUCT CODE | PRICE | SIZE/ INCHES | | | WEIGHT VOL | |
|--------------|-------|--------------|---|---|------------|-----------------|
| | | H | W | D | LBS | FT ³ |
| EVPBCIPLA224 | 143 | 24 | 3 | 3 | 5.30 | 0.22 |
| EVPBCIPLA230 | 149 | 30 | 3 | 3 | 6.60 | 0.27 |
| EVPBCIPLA236 | 157 | 36 | 3 | 3 | 7.90 | 0.33 |

EVPB6CEPLA3 • Power Beam 3-way 120 Degree Corner Post



- Connects three power beams of equal height in 120 degree configuration.
- Includes one post, three nonslotted power beam connectors, post with trim all around, levelling glide, hardware and trim kit.

| PRODUCT CODE | PRICE | SIZE/ INCHES | | | WEIGHT VOL | |
|---------------|-------|--------------|---|---|------------|-----------------|
| | | H | W | D | LBS | FT ³ |
| EVPB6CEPLA324 | 183 | 24 | 3 | 3 | 5.30 | 0.22 |
| EVPB6CEPLA330 | 186 | 30 | 3 | 3 | 6.60 | 0.27 |
| EVPB6CEPLA336 | 195 | 36 | 3 | 3 | 7.90 | 0.33 |

EVPB6CEPLA2 - Power Beam 2-way 120 Degree Corner Post



- Connects three power beams of equal height in 120 degree configuration.
- Includes one post, three nonslotted power beam connectors, post with trim all around, levelling glide, hardware and trim kit.

| PRODUCT CODE | PRICE | SIZE/ INCHES | | | WEIGHT VOL | |
|---------------|-------|--------------|---|---|------------|-----------------|
| | | H | W | D | LBS | FT ³ |
| EVPB6CEPLA224 | 183 | 24 | 3 | 3 | 5.30 | 0.22 |
| EVPB6CEPLA230 | 186 | 30 | 3 | 3 | 6.60 | 0.27 |
| EVPB6CEPLA236 | 195 | 36 | 3 | 3 | 7.90 | 0.33 |

EVPBIEC • Extension Connector for Power Beam



- Attaches to power beam connector.
- Includes non slotted extension connector and connecting hardware.
- Must be attached to power beam connector with provided screw before installing power beam.

| PRODUCT CODE | PRICE | SIZE/ INCHES | | | WEIGHT VOL | |
|--------------|-------|--------------|-------|---|------------|-----------------|
| | | H | W | D | LBS | FT ³ |
| EVPBIEC06 | 32 | 6 | 2.875 | 3 | 1.0 | 0.06 |
| EVPBIEC12 | 32 | 12 | 2.875 | 3 | 2.0 | 0.12 |
| EVPBIEC18 | 39 | 18 | 2.875 | 3 | 3.0 | 0.18 |
| EVPBIEC24 | 39 | 24 | 2.875 | 3 | 4.0 | 0.24 |

EVPBIEC • Slotted Extension Connector for Power Beam



- Attaches to Power Beam connector.
- Includes slotted extension connector and connecting hardware.
- Must be attached to Power Beam connector with provided screw before installing Power Beam.

| PRODUCT CODE | PRICE | SIZE/ INCHES | | | WEIGHT VOL | |
|--------------|-------|--------------|-------|---|------------|-----------------|
| | | H | W | D | LBS | FT ³ |
| EVPBIECS06 | 32 | 6 | 2.875 | 3 | 1.00 | 0.06 |
| EVPBIECS12 | 32 | 12 | 2.875 | 3 | 2.00 | 0.12 |
| EVPBIECS18 | 39 | 18 | 2.875 | 3 | 3.00 | 0.18 |
| EVPBIECS24 | 39 | 24 | 2.875 | 3 | 4.00 | 0.24 |

EVPBCEP4 • Power Beam Corner Extension Post 4 Way

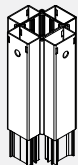

- Connects four extension modules in 90 degree configuration.
- Post and connecting hardware add 3.25" to power beam run.
- Includes one extension post, four non slotted extension connectors for power beam, connecting hardware and trim kit Power Beam.
- Corner Extension Post is not stackable.

| PRODUCT CODE | PRICE | SIZE/ INCHES | | | WEIGHT VOL | |
|--------------|-------|--------------|---|---|------------|-----------------|
| | | H | W | D | LBS | FT ³ |
| EVPBCEP406 | 79 | 6 | 3 | 3 | 4 | 0.09 |
| EVPBCEP412 | 79 | 12 | 3 | 3 | 8 | 0.18 |
| EVPBCEP418 | 125 | 18 | 3 | 3 | 12 | 0.27 |
| EVPBCEP424 | 125 | 24 | 3 | 3 | 16 | 0.36 |

EVPBCEPA3 • Power Beam Corner Extension Post 3 Way

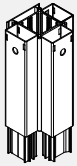

- Connects four extension modules in 90 degree configuration.
- Post and connecting hardware add 3.25" to power beam run.
- Includes one extension post, three non slotted extension connectors for power beam, connecting hardware and trim kit.
- Power Beam Corner Extension Post is not stackable.

| PRODUCT CODE | PRICE | SIZE/ INCHES | | | WEIGHT LBS | VOL FT ³ |
|--------------|-------|--------------|---|---|------------|---------------------|
| | | H | W | D | | |
| EVPBCEPA306 | 86 | 6 | 3 | 3 | 3 | 0.08 |
| EVPBCEPA312 | 86 | 12 | 3 | 3 | 6 | 0.16 |
| EVPBCEPA318 | 142 | 18 | 3 | 3 | 9 | 0.24 |
| EVPBCEPA324 | 142 | 24 | 3 | 3 | 12 | 0.32 |

EVPBCEPA2 • Power Beam Corner Extension Post 2 Way

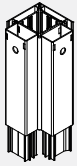

- Connects four extension modules in 90 degree configuration.
- Post and connecting hardware add 3.25" to power beam run.
- Includes one extension post, two non slotted extension connectors for power beam, connecting hardware and trim kit.
- Power Beam Corner Extension Post is not stackable.

| PRODUCT CODE | PRICE | SIZE/ INCHES | | | WEIGHT LBS | VOL FT ³ |
|--------------|-------|--------------|---|---|------------|---------------------|
| | | H | W | D | | |
| EVPBCEPA206 | 77 | 6 | 3 | 3 | 2 | 0.07 |
| EVPBCEPA212 | 77 | 12 | 3 | 3 | 4 | 0.14 |
| EVPBCEPA218 | 130 | 18 | 3 | 3 | 6 | 0.21 |
| EVPBCEPA224 | 130 | 24 | 3 | 3 | 8 | 0.28 |

EVPBCEIPA2 • Power Beam In Line Corner Extension Post 2 Way

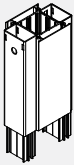

- Connects four extension modules in inline configuration.
- Post and connecting hardware add 3.25" to power beam run.
- Includes one extension post, two non slotted extension connectors for power beam, connecting hardware and trim kit.
- Power Beam Corner Extension Post is not stackable.

| PRODUCT CODE | PRICE | SIZE/ INCHES | | | WEIGHT LBS | VOL FT ³ |
|--------------|-------|--------------|---|---|------------|---------------------|
| | | H | W | D | | |
| EVPBCEIPA206 | 96 | 6 | 3 | 3 | 2 | 0.07 |
| EVPBCEIPA212 | 96 | 12 | 3 | 3 | 4 | 0.14 |
| EVPBCEIPA218 | 134 | 18 | 3 | 3 | 6 | 0.21 |
| EVPBCEIPA224 | 134 | 24 | 3 | 3 | 8 | 0.28 |

EVPBCEPA1 • Power Beam Corner Extension Post 1 Way

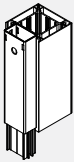

- Connects at end of run of extension modules.
- Post and connecting hardware add 3.25" to power beam run.
- Includes one extension post, one non slotted extension connectors for power beam, connecting hardware and trim kit.
- Power Beam Corner Extension Post is not stackable.

| PRODUCT CODE | PRICE | SIZE/ INCHES | | | WEIGHT LBS | VOL FT ³ |
|--------------|-------|--------------|---|---|------------|---------------------|
| | | H | W | D | | |
| EVPBCEPA106 | 70 | 6 | 3 | 3 | 2 | 0.07 |
| EVPBCEPA112 | 70 | 12 | 3 | 3 | 4 | 0.14 |
| EVPBCEPA118 | 97 | 18 | 3 | 3 | 6 | 0.21 |
| EVPBCEPA124 | 97 | 24 | 3 | 3 | 6 | 0.21 |

EVPB6CEP3 • Power Beam 120 Degree Corner Extension Post 3 Way



- Connects three extension modules in 120 degree configuration.
- Includes one extension post, three non slotted extension connectors for power beam, connecting hardware and trim kit.
- Power Beam Corner Extension Post is not stackable.

| PRODUCT CODE | PRICE | SIZE/ INCHES | | | WEIGHT LBS | VOL FT ³ |
|--------------|-------|--------------|---|---|------------|---------------------|
| | | H | W | D | | |
| EVPB6CEP306 | 116 | 6 | 3 | 3 | 3 | 0.08 |
| EVPB6CEP312 | 116 | 12 | 3 | 3 | 6 | 0.16 |
| EVPB6CEP318 | 183 | 18 | 3 | 3 | 9 | 0.24 |
| EVPB6CEP324 | 183 | 24 | 3 | 3 | 12 | 0.32 |

EVPB6CEPA2 • Power Beam 120 Degree Corner Extension Post 2 Way



- Connects two extension modules in 120 degree configuration.
- Includes one extension post, two non slotted extension connectors for power beam, connecting hardware and trim kit.
- Power Beam Corner Extension Post is not stackable.

| PRODUCT CODE | PRICE | SIZE/ INCHES | | | WEIGHT LBS | VOL FT ³ |
|--------------|-------|--------------|---|---|------------|---------------------|
| | | H | W | D | | |
| EVPB6CEPA206 | 98 | 6 | 3 | 3 | 2 | 0.07 |
| EVPB6CEPA212 | 98 | 12 | 3 | 3 | 4 | 0.14 |
| EVPB6CEPA218 | 153 | 18 | 3 | 3 | 6 | 0.21 |
| EVPB6CEPA224 | 153 | 24 | 3 | 3 | 8 | 0.28 |

EVPB6CEPA1 • Power Beam 60 Degree Corner Extension Post 1 Way



- Connects one extension module in 120 degree configuration.
- Includes one extension post, three non slotted extension connectors for power beam, connecting hardware and trim kit.
- Power Beam Corner Extension Post is not stackable.

| PRODUCT CODE | PRICE | SIZE/ INCHES | | | WEIGHT LBS | VOL FT ³ |
|--------------|-------|--------------|---|---|------------|---------------------|
| | | H | W | D | | |
| EVPB6CEPA106 | 65 | 6 | 3 | 3 | 2 | 0.07 |
| EVPB6CEPA112 | 69 | 12 | 3 | 3 | 4 | 0.14 |
| EVPB6CEPA118 | 94 | 18 | 3 | 3 | 6 | 0.21 |
| EVPB6CEPA124 | 94 | 24 | 3 | 3 | 8 | 0.28 |

EVPB24CPA • Panel to 24" H Power Beam 4 Way Corner Post



- Connects two panels and two 24" H power beams in 90 degree configuration.
- Post and connecting hardware add 3.25" to power beam run.
- Includes post, panel connectors and power beam connectors, post with trim all around, levelling glide, hardware and trim kit
- Pass thru only for power beam.

| PRODUCT CODE | PRICE | SIZE/ INCHES | | | WEIGHT LBS | VOL FT ³ |
|--------------|-------|--------------|---|---|------------|---------------------|
| | | H | W | D | | |
| EVPB24CPA430 | 240 | 30 | 3 | 3 | 15.5 | 0.41 |
| EVPB24CPA436 | 312 | 36 | 3 | 3 | 18 | 0.48 |
| EVPB24CPA442 | 312 | 42 | 3 | 3 | 21 | 0.57 |

EVPB30CPA • Panel to 30" H Power Beam 4 Way Corner Post



- Connects two panels and two 24" H power beams in 90 degree configuration.
- Post and connecting hardware add 3.25" to power beam run.
- Includes post, panel connectors and power beam connectors, post with trim all around, levelling glide, hardware and trim kit.
- Pass thru only for power beam.

| PRODUCT CODE | PRICE | SIZE/ INCHES | | | WEIGHT VOL | |
|--------------|-------|--------------|---|---|------------|-----------------|
| | | H | W | D | LBS | FT ³ |
| EVPB30CPA430 | 240 | 30 | 3 | 3 | 15.5 | 0.41 |
| EVPB30CPA436 | 312 | 36 | 3 | 3 | 18 | 0.48 |
| EVPB30CPA442 | 312 | 42 | 3 | 3 | 21 | 0.57 |

EVPB36CPA • Panel to 36" H Power Beam 4 Way Corner Post



- Connects two panels and two 24" H power beams in 90 degree configuration.
- Post and connecting hardware add 3.25" to power beam run.
- Includes post, panel connectors and power beam connectors, post with trim all around, levelling glide, hardware and trim kit.
- Pass thru only for power beam.

| PRODUCT CODE | PRICE | SIZE/ INCHES | | | WEIGHT VOL | |
|--------------|-------|--------------|---|---|------------|-----------------|
| | | H | W | D | LBS | FT ³ |
| EVPB36CPA436 | 312 | 36 | 3 | 3 | 18 | 0.48 |
| EVPB36CPA442 | 312 | 42 | 3 | 3 | 21 | 0.57 |

EVPB24CPSA4 • Panel to 24" H Power Beam 4 Way Corner Post - Slotted

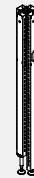

- Connects two panels and two 24" H power beams in a 90 degree configuration.
- Post and connecting hardware add 3.25" to the power beam run.
- Includes post, panel connectors, power beam connectors, post with trim all around, levelling glide, hardware and trim kit.
- Pass thru only for power beam, power beam leg slotted.

| PRODUCT CODE | PRICE | SIZE/ INCHES | | | WEIGHT VOL | |
|---------------|-------|--------------|---|---|------------|-----------------|
| | | H | W | D | LBS | FT ³ |
| EVPB24CPSA430 | 240 | 30 | 3 | 3 | 15.5 | 0.41 |
| EVPB24CPSA436 | 312 | 36 | 3 | 3 | 18 | 0.48 |
| EVPB24CPSA442 | 312 | 42 | 3 | 3 | 21 | 0.57 |

EVPB30CPSA4 • Panel to 30" H Power Beam 4 Way Corner Post - Slotted



- Connects two panels and two 30" H power beams in a 90 degree configuration.
- Post and connecting hardware add 3.25" to the power beam run.
- Includes post, panel connectors, power beam connectors, post with trim all around, levelling glide, hardware and trim kit.
- Pass thru only for power beam, power beam leg slotted.

| PRODUCT CODE | PRICE | SIZE/ INCHES | | | WEIGHT VOL | |
|---------------|-------|--------------|---|---|------------|-----------------|
| | | H | W | D | LBS | FT ³ |
| EVPB30CPSA430 | 240 | 30 | 3 | 3 | 15.5 | 0.41 |
| EVPB30CPSA436 | 312 | 36 | 3 | 3 | 18 | 0.48 |
| EVPB30CPSA442 | 312 | 42 | 3 | 3 | 21 | 0.57 |

EVPB36CPSA4 • Panel to 36" H Power Beam 4 Way Corner Post - Slotted



- Connects two panels and two 36" H power beams in a 90 degree configuration.
- Post and connecting hardware add 3.25" to the power beam run.
- Includes post, panel connectors, power beam connectors, post with trim all around, levelling glide, hardware and trim kit.
- Pass thru only for power beam, power beam leg slotted.

| PRODUCT CODE | PRICE | SIZE/ INCHES | | | WEIGHT VOL | |
|---------------|-------|--------------|---|---|------------|-----------------|
| | | H | W | D | LBS | FT ³ |
| EVPB36CPSA436 | 312 | 36 | 3 | 3 | 18 | 0.48 |
| EVPB36CPSA442 | 312 | 42 | 3 | 3 | 21 | 0.57 |

EVPB24CPA • Panel to 24" H Power Beam 3 Way Corner Post



- Connects panels and 24" H power beams in 90 degree configuration.
- Post and connecting hardware add 3.25" to power beam run.
- Includes post, panel connectors and power beam connectors, post with trim all around, levelling glide, hardware and trim kit.
- Pass thru only for power beam.

| PRODUCT CODE | PRICE | SIZE/ INCHES | | | WEIGHT VOL | |
|--------------|-------|--------------|---|---|------------|-----------------|
| | | H | W | D | LBS | FT ³ |
| EVPB24CPA330 | 218 | 30 | 3 | 3 | 11.8 | 0.36 |
| EVPB24CPA336 | 289 | 36 | 3 | 3 | 13 | 0.42 |
| EVPB24CPA342 | 289 | 42 | 3 | 3 | 16.1 | 0.50 |

EVPB30CPA • Panel to 30" H Power Beam 3 Way Corner Post



- Connects panels and 30" H power beams in 90 degree configuration.
- Post and connecting hardware add 3.25" to power beam run.
- Includes post, panel connectors and power beam connectors, post with trim all around, levelling glide, hardware and trim kit.
- Pass thru only for power beam.

| PRODUCT CODE | PRICE | SIZE/ INCHES | | | WEIGHT VOL | |
|--------------|-------|--------------|---|---|------------|-----------------|
| | | H | W | D | LBS | FT ³ |
| EVPB30CPA330 | 218 | 30 | 3 | 3 | 11.8 | 0.36 |
| EVPB30CPA336 | 289 | 36 | 3 | 3 | 13 | 0.42 |
| EVPB30CPA342 | 289 | 42 | 3 | 3 | 16.1 | 0.50 |

EVPB36CPA • Panel to 36" H Power Beam 3 Way Corner Post



- Connects panels and 36" H power beams in 90 degree configuration.
- Post and connecting hardware add 3.25" to power beam run.
- Includes post, panel connectors and power beam connectors, post with trim all around, levelling glide, hardware and trim kit.
- Pass thru only for power beam.

| PRODUCT CODE | PRICE | SIZE/ INCHES | | | WEIGHT LBS | VOL FT ³ |
|--------------|-------|--------------|---|---|------------|---------------------|
| | | H | W | D | | |
| EVPB36CPA336 | 289 | 36 | 3 | 3 | 13 | 0.42 |
| EVPB36CPA342 | 289 | 42 | 3 | 3 | 16.1 | 0.50 |

EVPB24CPSA3 • Panel to 24" H Power Beam 3 Way Corner Post - Slotted



- Connects panels and 24" H power beam in a 90 degree configuration.
- Post and connecting hardware add 3.25" to the power beam run.
- Includes post, panel connectors, power beam connectors, post with trim all around, levelling glide, hardware and trim kit.
- Pass thru only for power beam, power beam leg slotted.

| PRODUCT CODE | PRICE | SIZE/INCHES | | | WEIGHT LBS | VOL FT ³ |
|---------------|-------|-------------|---|---|------------|---------------------|
| | | H | W | D | | |
| EVPB24CPSA330 | 218 | 30 | 3 | 3 | 11.8 | 0.36 |
| EVPB24CPSA336 | 289 | 36 | 3 | 3 | 13 | 0.42 |
| EVPB24CPSA342 | 289 | 42 | 3 | 3 | 16.1 | 0.50 |

EVPB30CPSA3 • Panel to 30" H Power Beam 3 Way Corner Post - Slotted



- Connects panels and 30" H power beam in a 90 degree configuration.
- Post and connecting hardware add 3.25" to the power beam run.
- Includes post, panel connectors, power beam connectors, post with trim all around, levelling glide, hardware and trim kit.
- Pass thru only for power beam, power beam leg slotted.

| PRODUCT CODE | PRICE | SIZE/INCHES | | | WEIGHT LBS | VOL FT ³ |
|---------------|-------|-------------|---|---|------------|---------------------|
| | | H | W | D | | |
| EVPB30CPSA330 | 218 | 30 | 3 | 3 | 11.8 | 0.36 |
| EVPB30CPSA336 | 289 | 36 | 3 | 3 | 13 | 0.42 |
| EVPB30CPSA342 | 289 | 42 | 3 | 3 | 16.1 | 0.50 |

EVPB36CPSA3 • Panel to 36" H Power Beam 3 Way Corner Post - Slotted



- Connects panels and 36" H power beam in a 90 degree configuration.
- Post and connecting hardware add 3.25" to the power beam run.
- Includes post, panel connectors, power beam connectors, post with trim all around, levelling glide, hardware and trim kit.
- Pass thru only for power beam, power beam leg slotted.

| PRODUCT CODE | PRICE | SIZE/INCHES | | | WEIGHT LBS | VOL FT ³ |
|---------------|-------|-------------|---|---|------------|---------------------|
| | | H | W | D | | |
| EVPB36CPSA336 | 289 | 36 | 3 | 3 | 13 | 0.42 |
| EVPB36CPSA342 | 289 | 42 | 3 | 3 | 16.1 | 0.50 |

EVPB24CPA • Panel to 24" H Power Beam 2 Way Corner Post



- Connects one panels and one 24" H power beams in 90 degree configuration.
- Post and connecting hardware add 3.25" to power beam run.
- Includes post, panel connectors and power beam connectors, post with trim all around, levelling glide, hardware and trim kit.
- Pass thru only for power beam.

| PRODUCT CODE | PRICE | SIZE/ H | INCHES | | WEIGHT LBS | VOL FT ³ |
|--------------|-------|---------|--------|---|------------|---------------------|
| | | | W | D | | |
| EVPB24CPA230 | 183 | 30 | 3 | 3 | 8.5 | 0.31 |
| EVPB24CPA236 | 227 | 36 | 3 | 3 | 11.5 | 0.37 |
| EVPB24CPA242 | 227 | 42 | 3 | 3 | 15 | 0.43 |

EVPB30CPA • Panel to 30" H Power Beam 2 Way Corner Post



- Connects one panels and one 30" H power beams in 90 degree configuration.
- Post and connecting hardware add 3.25" to power beam run.
- Includes post, panel connectors and power beam connectors, post with trim all around, levelling glide, hardware and trim kit.
- Pass thru only for power beam.

| PRODUCT CODE | PRICE | SIZE/ H | INCHES | | WEIGHT LBS | VOL FT ³ |
|--------------|-------|---------|--------|---|------------|---------------------|
| | | | W | D | | |
| EVPB30CPA230 | 183 | 30 | 3 | 3 | 8.5 | 0.31 |
| EVPB30CPA236 | 227 | 36 | 3 | 3 | 11.5 | 0.37 |
| EVPB30CPA242 | 227 | 42 | 3 | 3 | 15 | 0.43 |

EVPB36CPA • Panel to 36" H Power Beam 2 Way Corner Post



- Connects one panels and one 36" H power beams in 90 degree configuration.
- Post and connecting hardware add 3.25" to power beam run.
- Includes post, panel connectors and power beam connectors, post with trim all around, levelling glide, hardware and trim kit.
- Pass thru only for power beam.

| PRODUCT CODE | PRICE | SIZE/ H | INCHES | | WEIGHT LBS | VOL FT ³ |
|--------------|-------|---------|--------|---|------------|---------------------|
| | | | W | D | | |
| EVPB36CPA236 | 227 | 36 | 3 | 3 | 11.5 | 0.37 |
| EVPB36CPA242 | 227 | 42 | 3 | 3 | 15 | 0.43 |

EVPB24CPSA2 • Panel to 24" H Power Beam 2 Way Corner Post - Slotted



- Connects one panels and one 24" H power beams in 90 degree configuration.
- Post and connecting hardware add 3.25" to the power beam run.
- Includes post, panel connectors, power beam connectors, post with trim all around, levelling glide, hardware and trim kit.
- Pass thru only for power beam, power beam leg slotted.

| PRODUCT CODE | PRICE | SIZE/INCHES | | | WEIGHT LBS | VOL FT ³ |
|---------------|-------|-------------|---|---|------------|---------------------|
| | | H | W | D | | |
| EVPB24CPSA230 | 183 | 30 | 3 | 3 | 8.5 | 0.31 |
| EVPB24CPSA236 | 227 | 36 | 3 | 3 | 11.5 | 0.37 |
| EVPB24CPSA242 | 227 | 42 | 3 | 3 | 15 | 0.43 |

EVPB30CPSA2 • Panel to 30" H Power Beam 2 Way Corner Post - Slotted



- Connects one panels and one 30" H power beams in 90 degree configuration.
- Post and connecting hardware add 3.25" to the power beam run.
- Includes post, panel connectors, power beam connectors, post with trim all around, levelling glide, hardware and trim kit.
- Pass thru only for power beam, power beam leg slotted.

| PRODUCT CODE | PRICE | SIZE/INCHES | | | WEIGHT LBS | VOL FT ³ |
|---------------|-------|-------------|---|---|------------|---------------------|
| | | H | W | D | | |
| EVPB30CPSA230 | 183 | 30 | 3 | 3 | 8.5 | 0.31 |
| EVPB30CPSA236 | 227 | 36 | 3 | 3 | 11.5 | 0.37 |
| EVPB30CPSA242 | 227 | 42 | 3 | 3 | 15 | 0.43 |

EVPB36CPSA2 • Panel to 36" H Power Beam 2 Way Corner Post - Slotted

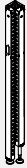

- Connects one panels and one 36" H power beams in 90 degree configuration.
- Post and connecting hardware add 3.25" to the power beam run.
- Includes post, panel connectors, power beam connectors, post with trim all around, levelling glide, hardware and trim kit.
- Pass thru only for power beam, power beam leg slotted.

| PRODUCT CODE | PRICE | SIZE/INCHES | | | WEIGHT LBS | VOL FT ³ |
|---------------|-------|-------------|---|---|------------|---------------------|
| | | H | W | D | | |
| EVPB36CPSA236 | 227 | 36 | 3 | 3 | 11.5 | 0.37 |
| EVPB36CPSA242 | 227 | 42 | 3 | 3 | 15 | 0.43 |

EVPB24CPA3-P • Panel to two 24" Power Beam 3 Way Corner Post



- Connects two 24" H power beams with panel in T configuration.
- Post and connecting hardware add 3.25" to power beam run.
- Includes post, panel connectors and power beam connectors, post with trim all around, levelling glide, hardware and trim kit.
- Pass thru only for power beam.

| PRODUCT CODE | PRICE | SIZE/ INCHES | | | WEIGHT LBS | VOL FT ³ |
|---------------|-------|--------------|---|---|------------|---------------------|
| | | H | W | D | | |
| EVPB24CPA330P | 208 | 30 | 3 | 3 | 11.8 | 0.36 |
| EVPB24CPA336P | 277 | 36 | 3 | 3 | 13 | 0.42 |
| EVPB24CPA342P | 277 | 42 | 3 | 3 | 16.1 | 0.5 |

EVPB30CPA3-P • Panel to two 30" Power Beam 3 Way Corner Post



- Connects two 24" H power beams with panel in T configuration.
- Post and connecting hardware add 3.25" to power beam run.
- Includes post, panel connectors and power beam connectors, post with trim all around, levelling glide, hardware and trim kit.
- Pass thru only for power beam.

| PRODUCT CODE | PRICE | SIZE/ INCHES | | | WEIGHT LBS | VOL FT ³ |
|---------------|-------|--------------|---|---|------------|---------------------|
| | | H | W | D | | |
| EVPB30CPA330P | 208 | 30 | 3 | 3 | 11.8 | 0.36 |
| EVPB30CPA336P | 277 | 36 | 3 | 3 | 13 | 0.42 |
| EVPB30CPA342P | 277 | 42 | 3 | 3 | 16.1 | 0.5 |

EVPB36CPA3-P • Panel to two 36" Power Beam 3 Way Corner Post



- Connects two 24" H power beams with panel in T configuration.
- Post and connecting hardware add 3.25" to power beam run.
- Includes post, panel connectors and power beam connectors, post with trim all around, levelling glide, hardware and trim kit.
- Pass thru only for power beam.

| PRODUCT CODE | PRICE | SIZE/ INCHES | | | WEIGHT LBS | VOL FT ³ |
|---------------|-------|--------------|---|---|------------|---------------------|
| | | H | W | D | | |
| EVPB36CPA336P | 277 | 36 | 3 | 3 | 13 | 0.42 |
| EVPB36CPA342P | 277 | 42 | 3 | 3 | 16.1 | 0.5 |

EVPB24CPSA3-P • Panel to two 24" H Power Beam 3 Way Corner Post



- Connects two 24" H power beams with panel in a T configuration.
- Post and connecting hardware add 3.25" to the power beam run.
- Includes post, panel connectors, power beam connectors, post with trim all around, levelling glide, hardware and trim kit.
- Pass thru only for power beam, power beam leg slotted.

| PRODUCT CODE | PRICE | SIZE/INCHES | | | WEIGHT LBS | VOL FT ³ |
|----------------|-------|-------------|---|---|------------|---------------------|
| | | H | W | D | | |
| EVPB24CPSA330P | 208 | 30 | 3 | 3 | 11.8 | 0.36 |
| EVPB24CPSA336P | 277 | 36 | 3 | 3 | 13 | 0.42 |
| EVPB24CPSA342P | 277 | 42 | 3 | 3 | 16.1 | 0.50 |

EVPB30CPSA3-P • Panel to two 30" H Power Beam 3 Way Corner Post



- Connects two 30" H power beams with panel in a T configuration.
- Post and connecting hardware add 3.25" to the power beam run.
- Includes post, panel connectors, power beam connectors, post with trim all around, levelling glide, hardware and trim kit.
- Pass thru only for power beam, power beam leg slotted.

| PRODUCT CODE | PRICE | SIZE/INCHES | | | WEIGHT LBS | VOL FT ³ |
|----------------|-------|-------------|---|---|------------|---------------------|
| | | H | W | D | | |
| EVPB30CPSA330P | 208 | 30 | 3 | 3 | 11.8 | 0.36 |
| EVPB30CPSA336P | 277 | 36 | 3 | 3 | 13 | 0.42 |
| EVPB30CPSA342P | 277 | 42 | 3 | 3 | 16.1 | 0.50 |

EVPB36CPSA3-P • Panel to two 36" H Power Beam 3 Way Corner Post



- Connects two 36" H power beams with panel in a T configuration.
- Post and connecting hardware add 3.25" to the power beam run.
- Includes post, panel connectors, power beam connectors, post with trim all around, levelling glide, hardware and trim kit.
- Pass thru only for power beam, power beam leg slotted.

| PRODUCT CODE | PRICE | SIZE/INCHES | | | WEIGHT LBS | VOL FT ³ |
|----------------|-------|-------------|---|---|------------|---------------------|
| | | H | W | D | | |
| EVPB36CPSA336P | 277 | 36 | 3 | 3 | 13 | 0.42 |
| EVPB36CPSA342P | 277 | 42 | 3 | 3 | 16.1 | 0.50 |

EVPFE • Fabric Panel Extension Module

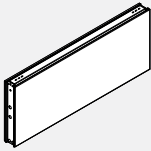

- Attaches on top of a panel.
- Module can be stacked to add privacy or divide space.
- Each side of fabric module may have different fabric within that same grade at no charge. If different grades of fabric are used, the entire module must be priced at highest grade.
- When ordering panel extension modules , additional connectors are required.
- Panel extension modules cannot be installed higher than 42" high above finished floor.

| PRODUCT CODE | PRICE | | SIZE/ INCHES | | | WEIGHT | | VOL FT ³ |
|--------------|-------|------|--------------|----|-------|--------|------|---------------------|
| | GR 1 | GR 2 | H | W | D | LBS | | |
| EVPFE0618 | 153 | 160 | 6 | 18 | 2.875 | 4.80 | 0.21 | |
| EVPFE0624 | 159 | 169 | 6 | 24 | 2.875 | 6.40 | 0.29 | |
| EVPFE0630 | 174 | 183 | 6 | 30 | 2.875 | 7.40 | 0.36 | |
| EVPFE0636 | 195 | 207 | 6 | 36 | 2.875 | 8.20 | 0.43 | |
| EVPFE0642 | 217 | 233 | 6 | 42 | 2.875 | 9.40 | 0.51 | |
| EVPFE0648 | 235 | 248 | 6 | 48 | 2.875 | 10.20 | 0.58 | |
| EVPFE0654 | 253 | 271 | 6 | 54 | 2.875 | 14.40 | 0.65 | |
| EVPFE0660 | 276 | 295 | 6 | 60 | 2.875 | 16.00 | 0.73 | |
| EVPFE0666 | 298 | 317 | 6 | 66 | 2.875 | 17.6 | 0.91 | |
| EVPFE0672 | 318 | 340 | 6 | 72 | 2.875 | 18.2 | 0.99 | |
| EVPFE1218 | 153 | 160 | 12 | 18 | 2.875 | 7.40 | 0.38 | |
| EVPFE1224 | 159 | 168 | 12 | 24 | 2.875 | 8.60 | 0.50 | |
| EVPFE1230 | 174 | 183 | 12 | 30 | 2.875 | 9.60 | 0.63 | |
| EVPFE1236 | 195 | 207 | 12 | 36 | 2.875 | 12.80 | 0.75 | |
| EVPFE1242 | 217 | 231 | 12 | 42 | 2.875 | 14.80 | 0.88 | |
| EVPFE1248 | 235 | 248 | 12 | 48 | 2.875 | 15.00 | 1.00 | |
| EVPFE1254 | 253 | 271 | 12 | 54 | 2.875 | 16.20 | 1.12 | |
| EVPFE1260 | 276 | 295 | 12 | 60 | 2.875 | 17.80 | 1.25 | |
| EVPFE1266 | 298 | 317 | 12 | 66 | 2.875 | 19.0 | 1.37 | |
| EVPFE1272 | 318 | 340 | 12 | 72 | 2.875 | 20.2 | 1.45 | |
| EVPFE1818 | 190 | 201 | 18 | 18 | 2.875 | 9.01 | 0.54 | |
| EVPFE1824 | 197 | 211 | 18 | 24 | 2.875 | 10.47 | 0.72 | |
| EVPFE1830 | 212 | 234 | 18 | 30 | 2.875 | 11.93 | 0.90 | |
| EVPFE1836 | 246 | 268 | 18 | 36 | 2.875 | 13.39 | 1.08 | |
| EVPFE1842 | 274 | 301 | 18 | 42 | 2.875 | 14.84 | 1.26 | |
| EVPFE1848 | 298 | 328 | 18 | 48 | 2.875 | 16.29 | 1.44 | |
| EVPFE1854 | 324 | 355 | 18 | 54 | 2.875 | 17.76 | 1.62 | |
| EVPFE1860 | 352 | 382 | 18 | 60 | 2.875 | 19.21 | 1.80 | |
| EVPFE1866 | 382 | 406 | 18 | 66 | 2.875 | 20.7 | 1.98 | |
| EVPFE1872 | 409 | 435 | 18 | 72 | 2.875 | 22.2 | 2.16 | |

EVPGTE • Tempered Glass Panel Extension Module

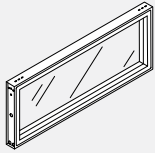

- Attaches on top of a panel.
- Module can be stacked to add privacy or divide space.
- Panel extension module is not load bearing above 66" high.
- Standard in lear (CLR).
- Frosted glass (FRST) upcharge varies. Contact Evolve customer service representative for details.
- When ordering panel extension modules, additional connectors are required.

| PRODUCT CODE | PRICE | SIZE/ INCHES | | | WEIGHT LBS | VOL FT ³ |
|--------------|-------|--------------|----|-------|------------|---------------------|
| | | H | W | D | | |
| EVPGTE0618 | 305 | 6 | 18 | 2.875 | 7.60 | 0.18 |
| EVPGTE0624 | 328 | 6 | 24 | 2.875 | 9.24 | 0.25 |
| EVPGTE0630 | 397 | 6 | 30 | 2.875 | 10.78 | 0.31 |
| EVPGTE0636 | 412 | 6 | 36 | 2.875 | 12.32 | 0.37 |
| EVPGTE0642 | 508 | 6 | 42 | 2.875 | 14.10 | 0.43 |
| EVPGTE0648 | 567 | 6 | 48 | 2.875 | 15.80 | 0.50 |
| EVPGTE0654 | 621 | 6 | 54 | 2.875 | 17.42 | 0.56 |
| EVPGTE0660 | 666 | 6 | 60 | 2.875 | 19.28 | 0.63 |
| EVPGTE0666 | 714 | 6 | 66 | 2.875 | 21.1 | 0.91 |
| EVPGTE0672 | 766 | 6 | 72 | 2.875 | 22.9 | 0.99 |
| EVPGTE1218 | 305 | 12 | 18 | 2.875 | 10.06 | 0.38 |
| EVPGTE1224 | 328 | 12 | 24 | 2.875 | 12.08 | 0.50 |
| EVPGTE1230 | 397 | 12 | 30 | 2.875 | 14.10 | 0.63 |
| EVPGTE1236 | 412 | 12 | 36 | 2.875 | 16.12 | 0.75 |
| EVPGTE1242 | 508 | 12 | 42 | 2.875 | 18.24 | 0.88 |
| EVPGTE1248 | 567 | 12 | 48 | 2.875 | 20.56 | 1.00 |
| EVPGTE1254 | 621 | 12 | 54 | 2.875 | 22.66 | 1.12 |
| EVPGTE1260 | 666 | 12 | 60 | 2.875 | 25.00 | 1.25 |
| EVPGTE1266 | 714 | 12 | 66 | 2.875 | 27.4 | 1.37 |
| EVPGTE1272 | 766 | 12 | 72 | 2.875 | 29.9 | 1.45 |
| EVPGTE1818 | 459 | 18 | 18 | 2.875 | 12.00 | 0.54 |
| EVPGTE1824 | 473 | 18 | 24 | 2.875 | 14.93 | 0.72 |
| EVPGTE1830 | 505 | 18 | 30 | 2.875 | 17.77 | 0.90 |
| EVPGTE1836 | 551 | 18 | 36 | 2.875 | 20.57 | 1.08 |
| EVPGTE1842 | 627 | 18 | 42 | 2.875 | 23.31 | 1.26 |
| EVPGTE1848 | 701 | 18 | 48 | 2.875 | 25.94 | 1.44 |
| EVPGTE1854 | 762 | 18 | 54 | 2.875 | 28.51 | 1.62 |
| EVPGTE1860 | 819 | 18 | 60 | 2.875 | 31.28 | 1.80 |
| EVPGTE1866 | 874 | 18 | 66 | 2.875 | 33.9 | 1.98 |
| EVPGTE1872 | 935 | 18 | 72 | 2.875 | 35.7 | 2.16 |

EVPW1SE • Write Board Extension Module - One Side

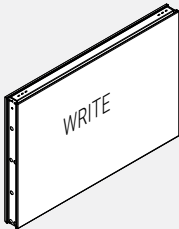

- Attaches on top of a beam.
- Provides writing surface on one side and fabric on the other side.
- Modules can be stacked to add privacy or to divide space.
- Panel Extension Modules cannot install higher than 42" high above finished floor.
- When ordering Beam Extension Modules, additional connectors are required.

| PRODUCT CODE | PRICE | | SIZE/ INCHES | | | WEIGHT LBS | VOL FT ³ |
|--------------|-------|-----|--------------|----|-------|------------|---------------------|
| | GR1 | GR2 | H | W | D | | |
| EVPW1SE1818 | 233 | 237 | 18 | 18 | 2.875 | 9.44 | 0.54 |
| EVPW1SE1824 | 263 | 270 | 18 | 24 | 2.875 | 10.90 | 0.72 |
| EVPW1SE1830 | 293 | 303 | 18 | 30 | 2.875 | 12.35 | 0.90 |
| EVPW1SE1836 | 344 | 355 | 18 | 36 | 2.875 | 13.81 | 1.08 |
| EVPW1SE1842 | 389 | 405 | 18 | 42 | 2.875 | 15.27 | 1.26 |
| EVPW1SE1848 | 430 | 448 | 18 | 48 | 2.875 | 16.72 | 1.44 |
| EVPW1SE1854 | 465 | 483 | 18 | 54 | 2.875 | 18.18 | 1.62 |
| EVPW1SE1860 | 503 | 520 | 18 | 60 | 2.875 | 19.64 | 1.80 |
| EVPW1SE1866 | 540 | 557 | 18 | 66 | 2.875 | 21.70 | 1.98 |
| EVPW1SE1872 | 577 | 593 | 18 | 72 | 2.875 | 23.30 | 2.16 |

EVPW2SE • Write Board Extension Module - Two Side

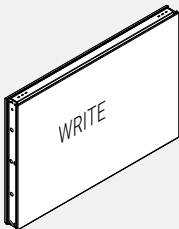

- Attaches on top of a panel.
- Provides writing surface on two sides.
- Modules can be stacked to add privacy or to divide space.
- Panel Extension Modules cannot install higher than 42" h above finished floor
- When ordering Panel Extension Modules, additional connectors are required.

| PRODUCT CODE | PRICE | SIZE/ INCHES | | | WEIGHT LBS | VOL FT ³ |
|--------------|-------|--------------|----|-------|------------|---------------------|
| | | H | W | D | | |
| EVPW2SE1818 | 279 | 18 | 18 | 2.875 | 10.29 | 0.54 |
| EVPW2SE1824 | 328 | 18 | 24 | 2.875 | 11.75 | 0.72 |
| EVPW2SE1830 | 375 | 18 | 30 | 2.875 | 13.20 | 0.90 |
| EVPW2SE1836 | 446 | 18 | 36 | 2.875 | 14.66 | 1.08 |
| EVPW2SE1842 | 503 | 18 | 42 | 2.875 | 16.12 | 1.26 |
| EVPW2SE1848 | 562 | 18 | 48 | 2.875 | 17.57 | 1.44 |
| EVPW2SE1854 | 622 | 18 | 54 | 2.875 | 19.03 | 1.62 |
| EVPW2SE1860 | 678 | 18 | 60 | 2.875 | 20.49 | 1.80 |
| EVPW2SE1866 | 733 | 18 | 66 | 2.875 | 21.70 | 1.98 |
| EVPW2SE1872 | 792 | 18 | 72 | 2.875 | 23.30 | 2.16 |

EVPH1SE • Laminate Extension Module - One Side

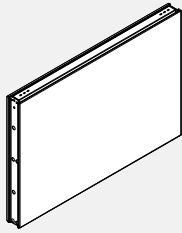

- Attaches on top of a beam.
- Laminate module provides a durable, washable surface on one side and fabric on the other side.
- Modules can be stacked to add privacy or to divide space.
- Panel Extension Modules cannot install higher than 42”h. above finished floor.
- When ordering Panel Extension Modules, additional connectors are required.
- Available in high pressure laminate finishes only.

| PRODUCT CODE | PRICE | | SIZE/ INCHES | | | WEIGHT LBS | VOL FT³ |
|--------------|-------|------|--------------|----|-------|------------|---------|
| | GR 1 | GR 2 | H | W | D | | |
| EVPH1SE0618 | 212 | 217 | 6 | 18 | 2.875 | 2.77 | 0.25 |
| EVPH1SE0624 | 247 | 259 | 6 | 24 | 2.875 | 3.20 | 0.35 |
| EVPH1SE0630 | 280 | 284 | 6 | 30 | 2.875 | 3.63 | 0.43 |
| EVPH1SE0636 | 319 | 327 | 6 | 36 | 2.875 | 4.06 | 0.51 |
| EVPH1SE0642 | 361 | 367 | 6 | 42 | 2.875 | 4.49 | 0.60 |
| EVPH1SE0648 | 394 | 404 | 6 | 48 | 2.875 | 4.91 | 0.68 |
| EVPH1SE0654 | 446 | 454 | 6 | 54 | 2.875 | 5.34 | 0.76 |
| EVPH1SE0660 | 469 | 477 | 6 | 60 | 2.875 | 5.77 | 0.84 |
| EVPH1SE0666 | 488 | 500 | 6 | 66 | 3 | 17.6 | 0.91 |
| EVPH1SE0672 | 542 | 550 | 6 | 72 | 3 | 18.2 | 0.99 |
| EVPH1SE1218 | 212 | 217 | 12 | 18 | 2.875 | 5.55 | 0.51 |
| EVPH1SE1224 | 247 | 259 | 12 | 24 | 2.875 | 6.41 | 0.71 |
| EVPH1SE1230 | 280 | 284 | 12 | 30 | 2.875 | 7.26 | 0.87 |
| EVPH1SE1236 | 319 | 327 | 12 | 36 | 2.875 | 8.12 | 1.03 |
| EVPH1SE1242 | 361 | 367 | 12 | 42 | 2.875 | 8.98 | 1.20 |
| EVPH1SE1248 | 394 | 404 | 12 | 48 | 2.875 | 9.83 | 1.36 |
| EVPH1SE1254 | 446 | 454 | 12 | 54 | 2.875 | 10.69 | 1.53 |
| EVPH1SE1260 | 469 | 477 | 12 | 60 | 2.875 | 11.55 | 1.69 |
| EVPH1SE1266 | 488 | 500 | 12 | 66 | 3 | 19.0 | 1.37 |
| EVPH1SE1272 | 542 | 550 | 12 | 72 | 3 | 20.2 | 1.45 |
| EVPH1SE1818 | 276 | 281 | 18 | 18 | 2.875 | 9.44 | 0.54 |
| EVPH1SE1824 | 340 | 347 | 18 | 24 | 2.875 | 10.90 | 0.72 |
| EVPH1SE1830 | 391 | 401 | 18 | 30 | 2.875 | 12.35 | 0.90 |
| EVPH1SE1836 | 448 | 457 | 18 | 36 | 2.875 | 13.81 | 1.08 |
| EVPH1SE1842 | 505 | 518 | 18 | 42 | 2.875 | 15.27 | 1.26 |
| EVPH1SE1848 | 553 | 570 | 18 | 48 | 2.875 | 16.72 | 1.44 |
| EVPH1SE1854 | 602 | 619 | 18 | 54 | 2.875 | 18.18 | 1.62 |
| EVPH1SE1860 | 660 | 687 | 18 | 60 | 2.875 | 19.64 | 1.80 |
| EVPH1SE1866 | 723 | 755 | 18 | 66 | 3 | 20.7 | 1.98 |
| EVPH1SE1872 | 770 | 802 | 18 | 72 | 3 | 22.2 | 2.16 |

EVPH2SE • Laminate Extension Module - Two Sides

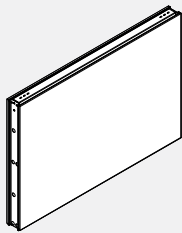

- Attaches on top of a beam.
- Laminate faces on both sides of the module provide durable, washable surfaces
- Modules can be stacked to add privacy or to divide space.
- Panel Extension Modules cannot install higher than 42”h. above finished floor.
- When ordering Panel Extension Modules, additional connectors are required.
- Available in high pressure laminate finishes only.

| PRODUCT CODE | PRICE | | SIZE/ INCHES | | | WEIGHT LBS | VOL FT³ |
|--------------|-------|------|--------------|----|-------|------------|---------|
| | GR 1 | GR 2 | H | W | D | | |
| EVPH2SE0618 | 234 | | 6 | 18 | 2.875 | 3.03 | 0.26 |
| EVPH2SE0624 | 274 | | 6 | 24 | 2.875 | 3.46 | 0.36 |
| EVPH2SE0630 | 318 | | 6 | 30 | 2.875 | 3.89 | 0.44 |
| EVPH2SE0636 | 364 | | 6 | 36 | 2.875 | 4.32 | 0.52 |
| EVPH2SE0642 | 410 | | 6 | 42 | 2.875 | 4.74 | 0.60 |
| EVPH2SE0648 | 460 | | 6 | 48 | 2.875 | 5.17 | 0.69 |
| EVPH2SE0654 | 535 | | 6 | 54 | 2.875 | 5.60 | 0.77 |
| EVPH2SE0660 | 544 | | 6 | 60 | 2.875 | 6.03 | 0.85 |
| EVPH2SE0666 | 555 | | 6 | 66 | 2.875 | 21.1 | 0.91 |
| EVPH2SE0672 | 627 | | 6 | 72 | 2.875 | 22.9 | 0.99 |
| EVPH2SE1218 | 234 | | 12 | 18 | 2.875 | 6.05 | 0.51 |
| EVPH2SE1224 | 274 | | 12 | 24 | 2.875 | 6.91 | 0.71 |
| EVPH2SE1230 | 318 | | 12 | 30 | 2.875 | 7.77 | 0.88 |
| EVPH2SE1236 | 364 | | 12 | 36 | 2.875 | 8.63 | 1.04 |
| EVPH2SE1242 | 410 | | 12 | 42 | 2.875 | 9.48 | 1.20 |
| EVPH2SE1248 | 460 | | 12 | 48 | 2.875 | 10.34 | 1.37 |
| EVPH2SE1254 | 535 | | 12 | 54 | 2.875 | 11.20 | 1.53 |
| EVPH2SE1260 | 544 | | 12 | 60 | 2.875 | 12.05 | 1.70 |
| EVPH2SE1266 | 555 | | 12 | 66 | 2.875 | 27.4 | 1.37 |
| EVPH2SE1272 | 627 | | 12 | 72 | 2.875 | 29.9 | 1.45 |
| EVPH2SE1818 | 329 | | 18 | 18 | 2.875 | 10.29 | 0.54 |
| EVPH2SE1824 | 404 | | 18 | 24 | 2.875 | 11.75 | 0.72 |
| EVPH2SE1830 | 469 | | 18 | 30 | 2.875 | 13.20 | 0.90 |
| EVPH2SE1836 | 542 | | 18 | 36 | 2.875 | 14.66 | 1.08 |
| EVPH2SE1842 | 614 | | 18 | 42 | 2.875 | 16.12 | 1.26 |
| EVPH2SE1848 | 694 | | 18 | 48 | 2.875 | 17.57 | 1.44 |
| EVPH2SE1854 | 762 | | 18 | 54 | 2.875 | 19.03 | 1.62 |
| EVPH2SE1860 | 823 | | 18 | 60 | 2.875 | 20.49 | 1.80 |
| EVPH2SE1866 | 882 | | 18 | 66 | 2.875 | 33.9 | 1.98 |
| EVPH2SE1872 | 949 | | 18 | 72 | 2.875 | 35.7 | 2.16 |

EVPAE • Air Flow Extension Module

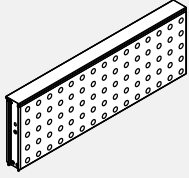

- Metal air flow panel extension.
- Attaches to top of beam.
- Modules can be stacked to add privacy or to divide space.
- Panel Extension Modules cannot install higher than 42”h. above finished floor.
- When ordering Panel Extension Modules, additional connectors are required.

| PRODUCT CODE | PRICE | SIZE/ INCHES | | | WEIGHT LBS | VOL FT ³ |
|--------------|-------|--------------|----|-------|------------|---------------------|
| | | H | W | D | | |
| EVPAE1224 | 270 | 12 | 24 | 2.875 | 9.66 | 0.59 |
| EVPAE1230 | 318 | 12 | 30 | 2.875 | 10.93 | 0.82 |
| EVPAE1236 | 363 | 12 | 36 | 2.875 | 12.19 | 1.00 |
| EVPAE1242 | 401 | 12 | 42 | 2.875 | 13.62 | 1.05 |
| EVPAE1248 | 452 | 12 | 48 | 2.875 | 15.18 | 1.18 |
| EVPAE1260 | 596 | 12 | 60 | 2.875 | 18.17 | 1.32 |
| EVPAE1824 | 339 | 18 | 24 | 2.875 | 10.56 | 0.72 |
| EVPAE1830 | 394 | 18 | 30 | 2.875 | 12.11 | 0.90 |
| EVPAE1836 | 435 | 18 | 36 | 2.875 | 13.66 | 1.08 |
| EVPAE1842 | 478 | 18 | 42 | 2.875 | 15.05 | 1.26 |
| EVPAE1848 | 547 | 18 | 48 | 2.875 | 16.35 | 1.44 |
| EVPAE1860 | 711 | 18 | 60 | 2.875 | 19.04 | 1.80 |

EVPOE • Open Panel Extension Module

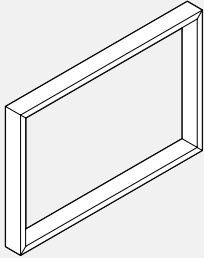

- Attaches to top portion of a beam.
- Modules can be stacked to add privacy or to divide space.
- Panel Extension Modules cannot install higher than 42”h above finished floor.
- When ordering Panel Extension Modules, additional connectors are required.

| PRODUCT CODE | PRICE | SIZE/ INCHES | | | WEIGHT LBS | VOL FT ³ |
|--------------|-------|--------------|----|-------|------------|---------------------|
| | | H | W | D | | |
| EVPOE0618 | 246 | 6 | 18 | 2.875 | 6.22 | 0.26 |
| EVPOE0624 | 252 | 6 | 24 | 2.875 | 7.40 | 0.29 |
| EVPOE0630 | 307 | 6 | 30 | 2.875 | 8.48 | 0.36 |
| EVPOE0636 | 323 | 6 | 36 | 2.875 | 9.56 | 0.43 |
| EVPOE0642 | 392 | 6 | 42 | 2.875 | 10.88 | 0.51 |
| EVPOE0648 | 442 | 6 | 48 | 2.875 | 12.12 | 0.58 |
| EVPOE0654 | 483 | 6 | 54 | 2.875 | 13.25 | 0.65 |
| EVPOE0660 | 520 | 6 | 60 | 2.875 | 14.68 | 0.73 |
| EVPOE1218 | 246 | 12 | 18 | 2.875 | 7.30 | 0.51 |
| EVPOE1224 | 252 | 12 | 24 | 2.875 | 8.40 | 0.59 |
| EVPOE1230 | 307 | 12 | 30 | 2.875 | 9.50 | 0.82 |
| EVPOE1236 | 323 | 12 | 36 | 2.875 | 10.60 | 1.00 |
| EVPOE1242 | 392 | 12 | 42 | 2.875 | 11.84 | 1.00 |
| EVPOE1248 | 442 | 12 | 48 | 2.875 | 13.20 | 1.18 |
| EVPOE1254 | 483 | 12 | 54 | 2.875 | 14.38 | 1.25 |
| EVPOE1260 | 520 | 12 | 60 | 2.875 | 15.80 | 1.32 |
| EVPOE1818 | 329 | 18 | 18 | 2.875 | 7.74 | 0.54 |
| EVPOE1824 | 369 | 18 | 24 | 2.875 | 9.18 | 0.72 |
| EVPOE1830 | 392 | 18 | 30 | 2.875 | 10.53 | 0.90 |
| EVPOE1836 | 431 | 18 | 36 | 2.875 | 11.88 | 1.08 |
| EVPOE1842 | 485 | 18 | 42 | 2.875 | 13.09 | 1.26 |
| EVPOE1848 | 546 | 18 | 48 | 2.875 | 14.22 | 1.44 |
| EVPOE1854 | 592 | 18 | 54 | 2.875 | 15.28 | 1.62 |
| EVPOE1860 | 638 | 18 | 60 | 2.875 | 16.56 | 1.80 |

EVPMP-GIP • Panel Mount Privacy Glass

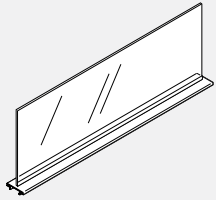

- Attaches on top of Power Beam or extension modules to add privacy or divide space.
- Privacy Glass is integrated into the aluminum top trim.
- Includes aluminum trim with channel and glass tile
- Glass and attachment hardware ship separately.
- Standard in clear (CLR), frosted (FRST) or writeable (WRW) glass.
- Privacy glass modules may stack on top of Power Beam or extension modules at 42" h. to achieve a height up to 54"h. above finished floor

| PRODUCT CODE | PRICE | | | SIZE/ INCHES | | | WEIGHT LBS | VOL FT³ |
|--------------|-------|------|-----|--------------|----|-------|------------|---------|
| | CLR | FRST | WRW | H | W | D | | |
| EVPMP24GI6P | 201 | 251 | - | 6 | 24 | 2.875 | 2.39 | 0.25 |
| EVPMP30GI6P | 219 | 276 | - | 6 | 30 | 2.875 | 2.99 | 0.32 |
| EVPMP36GI6P | 235 | 291 | - | 6 | 36 | 2.875 | 3.58 | 0.37 |
| EVPMP42GI6P | 251 | 313 | - | 6 | 42 | 2.875 | 4.18 | 0.43 |
| EVPMP48GI6P | 262 | 327 | - | 6 | 48 | 2.875 | 4.78 | 0.50 |
| EVPMP54GI6P | 270 | 338 | - | 6 | 54 | 2.875 | 5.38 | 0.56 |
| EVPMP60GI6P | 276 | 343 | - | 6 | 60 | 2.875 | 5.97 | 0.63 |
| EVPMP66GI6P | 422 | 562 | - | 6 | 66 | 2.875 | 6.57 | 0.69 |
| EVPMP72GI6P | 450 | 587 | - | 6 | 72 | 2.875 | 7.16 | 0.76 |
| EVPMP24GI9P | 201 | 251 | - | 9 | 24 | 2.875 | 3.58 | 0.38 |
| EVPMP30GI9P | 219 | 276 | - | 9 | 30 | 2.875 | 4.48 | 0.47 |
| EVPMP36GI9P | 235 | 291 | - | 9 | 36 | 2.875 | 5.37 | 0.56 |
| EVPMP42GI9P | 251 | 313 | - | 9 | 42 | 2.875 | 6.26 | 0.65 |
| EVPMP48GI9P | 262 | 327 | - | 9 | 48 | 2.875 | 7.16 | 0.75 |
| EVPMP54GI9P | 270 | 338 | - | 9 | 54 | 2.875 | 8.06 | 0.84 |
| EVPMP60GI9P | 276 | 343 | - | 9 | 60 | 2.875 | 8.96 | 0.94 |
| EVPMP66GI9P | 422 | 562 | - | 9 | 66 | 2.875 | 9.85 | 1.04 |
| EVPMP72GI9P | 450 | 587 | - | 9 | 72 | 2.875 | 10.74 | 1.13 |
| EVPMP24GIP | 201 | 251 | 350 | 12 | 24 | 2.875 | 4.77 | 0.50 |
| EVPMP30GIP | 219 | 276 | 357 | 12 | 30 | 2.875 | 5.97 | 0.63 |
| EVPMP36GIP | 235 | 291 | 364 | 12 | 36 | 2.875 | 7.16 | 0.75 |
| EVPMP42GIP | 251 | 313 | 401 | 12 | 42 | 2.875 | 8.35 | 0.87 |
| EVPMP48GIP | 262 | 327 | 439 | 12 | 48 | 2.875 | 9.55 | 1.00 |
| EVPMP54GIP | 270 | 338 | 475 | 12 | 54 | 2.875 | 10.75 | 1.12 |
| EVPMP60GIP | 276 | 343 | 512 | 12 | 60 | 2.875 | 11.95 | 1.25 |
| EVPMP66GIP | 422 | 562 | 701 | 12 | 66 | 2.875 | 13.05 | 1.37 |
| EVPMP72GIP | 450 | 587 | 734 | 12 | 72 | 2.875 | 14.25 | 1.51 |
| EVPMP24GI18P | 289 | 363 | - | 18 | 24 | 2.875 | 7.16 | 0.75 |
| EVPMP30GI18P | 317 | 397 | - | 18 | 30 | 2.875 | 8.96 | 0.94 |
| EVPMP36GI18P | 338 | 420 | - | 18 | 36 | 2.875 | 10.74 | 1.13 |
| EVPMP42GI18P | 363 | 453 | - | 18 | 42 | 2.875 | 12.53 | 1.31 |
| EVPMP48GI18P | 375 | 471 | - | 18 | 48 | 2.875 | 14.33 | 1.50 |
| EVPMP54GI18P | 388 | 485 | - | 18 | 54 | 2.875 | 16.13 | 1.69 |
| EVPMP60GI18P | 397 | 496 | - | 18 | 60 | 2.875 | 17.91 | 1.88 |
| EVPMP66GI18P | 553 | 733 | - | 18 | 66 | 2.875 | 19.70 | 2.06 |
| EVPMP72GI18P | 588 | 766 | - | 18 | 72 | 2.875 | 21.48 | 2.25 |

EVPBSCGD • Power Beam Shared Storage Cabinet with Sliding Glass Door

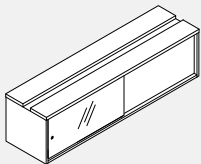

Left Hand Shown

- Inside dimensions 13"high x 13"deep.
- Laminate storage cabinet, available in standard Evolve laminate finishes.
- Available in Tempered frosted glass only, glass with handle.
- Tracks for sliding glass available in Tungsten only.
- To be installed under power beam between T legs.
- Power Beam Storage cabinet attaches to the bottom of the power beam with brackets.
- For ease of installation, levelers in middle included.
- **Note: To be used with 24"h. Power Beam only.**

| PRODUCT CODE | PRICE | SIZE/ INCHES | | | WEIGHT LBS | VOL FT³ |
|--------------|-------|--------------|-------|----|------------|---------|
| | | H | W | D | | |
| EVPBSCGDR60 | 1786 | 15 | 58.75 | 16 | 80.46 | 8.33 |
| EVPBSCGDR72 | 1950 | 15 | 70.75 | 16 | 96.60 | 10.00 |
| EVPBSCGDL60 | 1786 | 15 | 58.75 | 16 | 80.46 | 8.33 |
| EVPBSCGDL72 | 1950 | 15 | 70.75 | 16 | 96.60 | 10.00 |

EVPBSCGDP • Power Beam Shared Storage Cabinet with Sliding Glass Door and Cable Pass Through

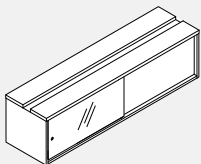

Left Hand Shown

- Inside dimensions 13"high x 13"deep.
- Laminate storage cabinet, available in standard Evolve laminate finishes.
- Available in Tempered frosted glass only, glass with handle.
- Tracks for sliding glass available in Tungsten only.
- To be installed under power beam between T legs.
- Power Beam Storage cabinet attaches to the bottom of the power beam with brackets.
- For ease of installation, levelers in middle included.
- **Note: To be used with 24"h. Power Beam only, EVPBEP-KIT and 60" and 72" widths only.**
- Cabinet with cable pass through in the middle to bring power to power beam above
- Includes metal cover for easy access to wires
- Electrics not included
- Power beam base feed to be ordered separately.
- Power beam kit with electrical cut out in middle to be ordered separately. (EVPBEP-KIT)

| PRODUCT CODE | PRICE | SIZE/ INCHES | | | WEIGHT LBS | VOL FT³ |
|--------------|-------|--------------|-------|----|------------|---------|
| | | H | W | D | | |
| EVPBSCGDPR60 | 2155 | 15 | 58.75 | 16 | 80.46 | 8.33 |
| EVPBSCGDPR72 | 2279 | 15 | 70.75 | 16 | 96.60 | 10.00 |
| EVPBSCGDPL60 | 2155 | 15 | 58.75 | 16 | 80.46 | 8.33 |
| EVPBSCGDPL72 | 2279 | 15 | 70.75 | 16 | 96.60 | 10.00 |

EVPBSC • Power Beam Shared Storage Cabinet, Open

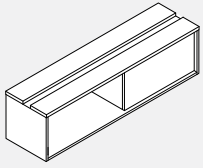

- Inside dimensions 13"high x 13"deep.
- Laminate storage cabinet, without doors, available in standard Evolve laminate finishes.
- To be installed under power beam between T legs.
- Power Beam Storage cabinet attaches to bottom of power beam with brackets.
- For ease of installation, levelers in middle included.
- Note: It can not be converted to cabinet with glass door.
- **Note: To be used with 24" h Power Beam only.**

| PRODUCT CODE | PRICE | SIZE/ INCHES | | | WEIGHT VOL | |
|--------------|-------|--------------|-------|----|------------|-----------------|
| | | H | W | D | LBS | FT ³ |
| EVPBSCR60 | 1143 | 15 | 58.75 | 16 | 80.46 | 8.33 |
| EVPBSCR72 | 1167 | 15 | 70.75 | 16 | 96.6 | 10.00 |
| EVPBSCCL60 | 1143 | 15 | 58.75 | 16 | 80.46 | 8.33 |
| EVPBSCCL72 | 1167 | 15 | 70.75 | 16 | 96.6 | 10.00 |

EVPBSCP • Power Beam Shared Storage Cabinet, Open and Cable Pass Through

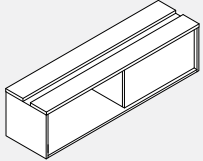

Left Hand Shown

- Inside dimensions 13"high x 13"deep.
- Laminate storage cabinet, without doors, available in standard Evolve laminate finishes.
- To be installed under power beam between T legs.
- Power Beam Storage cabinet attaches to bottom of power beam with brackets.
- For ease of installation, levelers in middle included.
- Note: It can not be converted to cabinet with glass door.
- **Note: To be used with 24" h Power Beam only, EVPBBEP-KIT.**
- Cabinet with cable pass through in the middle to bring power to power beam above.
- Includes metal cover for easy access to wires.
- Electrics not included.
- Power beam base feed to be ordered separately.
- Power beam kit with electrical cut out in middle to be ordered separately. (EVPBEP-KIT).

| PRODUCT CODE | PRICE | SIZE/ INCHES | | | WEIGHT VOL | |
|--------------|-------|--------------|-------|----|------------|-----------------|
| | | H | W | D | LBS | FT ³ |
| EVPBSCP60 | 1275 | 15 | 58.75 | 16 | 80.46 | 8.33 |
| EVPBSCP72 | 1345 | 15 | 70.75 | 16 | 96.6 | 10.00 |
| EVPBSCPL60 | 1275 | 15 | 58.75 | 16 | 80.46 | 8.33 |
| EVPBSCPL72 | 1345 | 15 | 70.75 | 16 | 96.6 | 10.00 |

EVSDAOH • Power Beam Dual Access Overhead

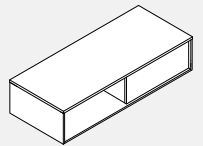

- Inside dimensions 6.5" high x 13"deep.
- Laminate Overhead.
- Available in standard Evolve laminate finishes.
- Power Beam storage cabinet must be installed at the bottom for stability.
- Top mount on power beam.
- Dual Access Overhead Support Brackets to be ordered separately.
- Power Beam legs for storage to be ordered separately.
- Power Beam legs for storage must be used.

| PRODUCT CODE | PRICE | SIZE/ INCHES | | | WEIGHT VOL | |
|--------------|-------|--------------|----|----|------------|-----------------|
| | | H | W | D | LBS | FT ³ |
| EVSDAOH60 | 1137 | 8.5 | 60 | 16 | 51.5 | 5.00 |
| EVSDAOH72 | 1160 | 8.6 | 72 | 16 | 60.2 | 6.00 |

EVSDAOHBRKIT • Brackets for Dual Access Overhead

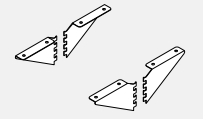

- Brackets support Dual access overhead
- To be used with Power Beam Channel
- Available in standard paint colors
- Brackets and screws included

| PRODUCT CODE | PRICE | SIZE/INCHES | | | WEIGHT LBS | VOL FT ³ |
|--------------|-------|-------------|---|-----|------------|---------------------|
| | | H | W | D | | |
| EVSDAOHBRKIT | 133 | 5 | 5 | 1.5 | 2.00 | 0.08 |

EVPBL • 36" Power Beam Connector with Leg for Storage



- Connects 24" h power beams on equal height.
- Includes non slotted connector with leg, glides and connecting hardware.
- Must be used with overhead.

| PRODUCT CODE | PRICE | SIZE/ INCHES | | | WEIGHT VOL | |
|--------------|-------|--------------|----|---|------------|-----------------|
| | | H | W | D | LBS | FT ³ |
| EVPBL36S | 112 | 36 | 18 | | 8.5 | 0.45 |

EVPBLERT • End of Run Trim for Connector

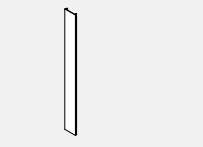

- Specify to match height of beam or total height with extension modules

| PRODUCT CODE | PRICE | SIZE/ INCHES | | | WEIGHT VOL | |
|--------------|-------|--------------|-------|---|------------|-----------------|
| | | H | W | D | LBS | FT ³ |
| EVPBLERT24 | 54 | 21.4 | 2.875 | 3 | 1.0 | 0.04 |
| EVPBLERT30 | 61 | 27.4 | 2.875 | 3 | 1.4 | 0.04 |
| EVPBLERT36 | 64 | 33.4 | 2.875 | 3 | 1.6 | 0.06 |
| EVPBLERT42 | 68 | 39.4 | 2.875 | 3 | 1.8 | 0.07 |
| EVPBLERT48 | 71 | 45.4 | 2.875 | 3 | 2.00 | 0.08 |
| EVPBLERT54 | 74 | 51.4 | 2.875 | 3 | 2.20 | 0.09 |
| EVPBLERT66 | 85 | 63.4 | 2.875 | 3 | 2.60 | 1.10 |

EVPBLEP • Laminate End Panel for Power Beam

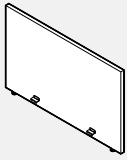

- Connects to a power beam support leg with foot at the end of a run
- Includes brackets to attach to support leg with foot
- Finished in thermally fused laminate. If wood grain is selected, grain runs horizontally
- Laminate End Panel height is inclusive of panel glides extended to their full height
- Laminate end panel must connect to a support leg with foot and will not connect to a support leg with glide
- Must be used with Connectors with T-Leg

| PRODUCT CODE | PRICE | SIZE/ INCHES | | | WEIGHT VOL | |
|--------------|-------|--------------|----|---|------------|-----------------|
| | | H | W | D | LBS | FT ³ |
| EVPBLEP2451 | 327 | 24 | 51 | 1 | 32.81 | 0.73 |
| EVPBLEP3051 | 408 | 30 | 51 | 1 | 39.38 | 0.88 |
| EVPBLEP3651 | 487 | 36 | 51 | 1 | 45.94 | 1.02 |
| EVPBLEP4251 | 731 | 42 | 51 | 1 | 52.50 | 1.24 |
| EVPBLEP2463 | 370 | 24 | 63 | 1 | 37.50 | 0.83 |
| EVPBLEP3063 | 465 | 30 | 63 | 1 | 45.00 | 1.00 |
| EVPBLEP3663 | 557 | 36 | 63 | 1 | 52.50 | 1.17 |
| EVPBLEP4263 | 816 | 42 | 63 | 1 | 60.00 | 1.53 |

EVPBLEP • Laminate End Panel for Power Beam, Single Leg

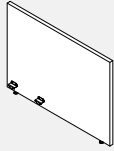

- EVPBLEP - Laminate End Panel for Power Beam.
- Attaches to power beam connector with single leg.
- For one sided Power beam application.
- Includes brackets to attached to attached to leg.
- Finished in thermally fused laminate, if wood grain is selected, grain runs horizontally.
- Laminate End Panel height is inclusive of panel glides extended to their full height.
- EVPBLEP-30 to be used for 24" deep worksurface.
- EVPBLEP-36 to be used for 30" deep worksurfaces

| PRODUCT CODE | PRICE | SIZE/ INCHES | | | WEIGHT VOL | |
|--------------|-------|--------------|----|---|------------|-----------------|
| | | H | W | D | LBS | FT ³ |
| EVPBLEP2430 | 265 | 24 | 30 | 1 | 19.30 | 0.42 |
| EVPBLEP3030 | 287 | 30 | 30 | 1 | 23.16 | 0.52 |
| EVPBLEP3630 | 309 | 36 | 30 | 1 | 27.02 | 0.64 |
| EVPBLEP4230 | 388 | 42 | 30 | 1 | 30.88 | 0.74 |
| EVPBLEP2436 | 312 | 24 | 36 | 1 | 21.43 | 0.55 |
| EVPBLEP3036 | 323 | 30 | 36 | 1 | 25.71 | 0.64 |
| EVPBLEP3636 | 364 | 36 | 36 | 1 | 30.00 | 0.75 |
| EVPBLEP4236 | 465 | 42 | 36 | 1 | 34.29 | 0.90 |

EVE8PD • Power Distribution Housing

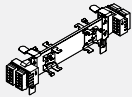

- Power housing is specified per beam size (e.g. EVE8PD36 is for use in a 36" beam).
- 8 wire, 4 circuits (2+2 configuration).
- Accommodates two duplex receptacles per panel side.

| PRODUCT CODE | PRICE | SIZE/ INCHES | | WEIGHT VOL | |
|--------------|-------|--------------|-------|------------|-----------------|
| | | W | D | LBS | FT ³ |
| EVE8PD24 | 156 | 24 | 9.25 | 0.83 | 1.17 |
| EVE8PD30 | 208 | 30 | 15.25 | 1.28 | 1.17 |
| EVE8PD36 | 220 | 36 | 21.25 | 1.62 | 1.65 |
| EVE8PD42 | 226 | 42 | 27.25 | 2.00 | 2.00 |
| EVE8PD48 | 238 | 48 | 33.25 | 0.18 | 0.16 |
| EVE8PD54 | 242 | 54 | 39.25 | 2.66 | 3.20 |
| EVE8PD60 | 243 | 60 | 45.25 | 3.04 | 3.20 |

EVE8PD • Power Distribution Housing

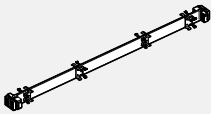

- Power housing is specified per beam size (e.g. EVE8PD72 is for use in a 72" beam).
- 8 wire, 4 circuits (2+2 configuration).
- Provides two duplex receptacle to be plugged directly to power distribution housing and then as option additional two duplex receptacle to be connected to it with "I" connector, per panel size.
- Both duplex receptacles connected by "I" connector must be same circuit.
- Each power distribution housing supports 15-20 amps.
- Duplex receptacles and "I" connectors to be ordered separately.

| PRODUCT CODE | PRICE | SIZE/ INCHES | | WEIGHT VOL | |
|--------------|-------|--------------|------|------------|-----------------|
| | | W | D | LBS | FT ³ |
| EVE8PD66 | 253 | 66 | 43.5 | 3.44 | 3.30 |
| EVE8PD72 | 262 | 72 | 45.5 | 3.84 | 3.40 |

EVE8CP • Jumper Cable

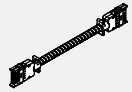

- The EVE8CP16 electrically connects two powered panels positioned side by side.
- The EVE8CP20 electrically connects two powered panels separated by a post.

| PRODUCT CODE | PRICE | SIZE/ INCHES | WEIGHT VOL | |
|--------------|-------|--------------|------------|---------------------|
| | | | L | LBS FT ³ |
| EVE8CP16 | 121 | 16 | 0.66 | 1.17 |
| EVE8CP20 | 142 | 20 | 0.78 | 1.17 |

EVE8CP18 • Flexible Mesh Jumper Cable

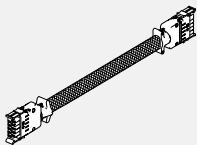

- Electrically connects two powered panels separated by post.
- Used to connect two power distribution housing in Power Beam at 90 degrees.

| PRODUCT CODE | PRICE | SIZE/INCHES | | | WEIGHT | VOL |
|--------------|-------|-------------|---|------|--------|------|
| | | H | W | D | | |
| EVE8CP18 | 147 | | | 18.5 | 0.78 | 1.17 |

EVE8CP • Pass Through Cable

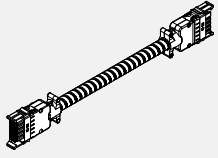

- Flexible metal conduit is used to distribute electrical power through non-powered panels.
- To calculate the length of a Pass-Through Cable, add the widths of the non-powered panels separating the powered panels (panels with distribution housing attached). To this, add 16" (distance from the edge of the panel to the distribution housing x 2). See Technical Information page at the beginning of this section.

| PRODUCT CODE | PRICE | SIZE/ INCHES | | | WEIGHT VOL | |
|--------------|-------|--------------|--|--|------------|-----------------|
| | | L | | | LBS | FT ³ |
| EVE8CP40 | 164 | 40 | | | 1.44 | 1.17 |
| EVE8CP46 | 169 | 46 | | | 1.71 | 1.17 |
| EVE8CP52 | 177 | 52 | | | 1.95 | 1.17 |
| EVE8CP58 | 188 | 58 | | | 2.21 | 1.17 |
| EVE8CP64 | 196 | 64 | | | 2.37 | 1.17 |
| EVE8CP70 | 200 | 70 | | | 2.60 | 1.17 |
| EVE8CP76 | 204 | 76 | | | 2.81 | 1.17 |
| EVE8CP82 | 213 | 82 | | | 3.03 | 1.17 |
| EVE8CP88 | 220 | 88 | | | 3.05 | 1.17 |
| EVE8CP94 | 228 | 94 | | | 3.92 | 1.17 |
| EVE8CP100 | 233 | 100 | | | 3.47 | 1.17 |
| EVE8CP106 | 243 | 106 | | | 3.87 | 1.17 |
| EVE8CP118 | 257 | 118 | | | 4.08 | 1.17 |
| EVE8CP130 | 281 | 185 | | | 4.73 | 1.17 |
| EVE8CP142 | 293 | 142 | | | 4.59 | 1.17 |

EVE8CPxx-H • Hybrid Pass Through Cables with Wire Mesh

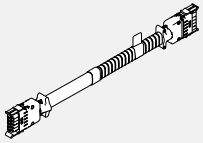

- Flexible metal conduit with wire mesh distributes electrical power through non powered panels.
- To calculate the length of Hybrid Pass Through Cable, add the width of non powered panels separating the powered panels. To this add 16" (distance from edge of the panels to power distribution housing x2).
- Please add an additional 3" when passing through a post. Please see the the beginning of this section.
- Hybrid Pass Through Cables with wire mesh allows connection at 90 degree post and one end for Power Beam.

| PRODUCT CODE | PRICE | SIZE/INCHES | | | WEIGHT VOL | |
|--------------|-------|-------------|---|---|------------|-----------------|
| | | H | W | D | LBS | FT ³ |
| EVE8CP40-H | 196 | 40 | | | 1.44 | 1.17 |
| EVE8CP46-H | 204 | 46 | | | 1.71 | 1.17 |
| EVE8CP52-H | 212 | 52 | | | 1.95 | 1.17 |
| EVE8CP58-H | 226 | 58 | | | 2.21 | 1.17 |
| EVE8CP64-H | 235 | 64 | | | 2.37 | 1.17 |
| EVE8CP70-H | 240 | 70 | | | 2.60 | 1.17 |
| EVE8CP76-H | 244 | 76 | | | 2.81 | 1.17 |
| EVE8CP82-H | 255 | 82 | | | 3.03 | 1.17 |
| EVE8CP88-H | 264 | 88 | | | 3.05 | 1.17 |
| EVE8CP94-H | 273 | 94 | | | 3.42 | 1.17 |
| EVE8CP100-H | 281 | 100 | | | 3.47 | 1.17 |
| EVE8CP106-H | 292 | 106 | | | 3.87 | 1.17 |
| EVE8CP118-H | 309 | 118 | | | 4.08 | 1.17 |
| EVE8CP130-H | 337 | 130 | | | 4.73 | 1.17 |
| EVE8CP142-H | 351 | 142 | | | 4.89 | 1.17 |

EVE8CI-1 • "I" Connector



- Female - Female connector used to connect two Pass-Through Cables.

| PRODUCT CODE | PRICE | SIZE/ INCHES | | | WEIGHT VOL | |
|--------------|-------|--------------|----|------|------------|-----------------|
| | | H | W | D | LBS | FT ³ |
| EVE8CI-1 | 85 | 15 | 15 | 0.75 | 0.06 | 0.20 |

EVE8RD • Duplex Receptacles

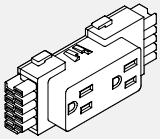

- Up to 6 duplex receptacles per circuit.
- EVE8RD1 = Circuit #1 (utility circuit)
- EVE8RD1 = Circuit #2 (utility circuit)
- EVE8RDA = Circuit #A (dedicated)
- EVE8RDB = Circuit #B (dedicated)

| PRODUCT CODE | PRICE | SIZE/ INCHES | | | WEIGHT VOL | |
|--------------|-------|--------------|-------|------|------------|-----------------|
| | | H | W | D | LBS | FT ³ |
| EVE8RD1 | 35 | 2 | 4.625 | 1.25 | 0.16 | 0.01 |
| EVE8RD2 | 35 | 2 | 4.625 | 1.25 | 0.16 | 0.01 |
| EVE8RDA | 35 | 2 | 4.625 | 1.25 | 0.16 | 0.01 |
| EVE8RDB | 35 | 2 | 4.625 | 1.25 | 0.16 | 0.01 |

EVEUSB01 • Duplex Receptacles

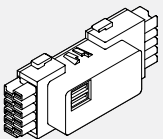

- The USB charging module provides convenient charging power access through dual ports on face of the receptacle.
- Two USB ports.
- 2 Amp output via two USB ports, considered as circuit #1.
- Available in white, black.

| PRODUCT CODE | PRICE | SIZE/ INCHES | | | WEIGHT VOL | |
|--------------|-------|--------------|-------|------|------------|-----------------|
| | | H | W | D | LBS | FT ³ |
| EVEUSB01WHT | 238 | 2 | 4.625 | 1.25 | 0.16 | 0.01 |
| EVEUSB01BLK | 238 | 2 | 4.625 | 1.25 | 0.16 | 0.01 |

EVE8FR3PB • Floor Power Entry for Power Beam

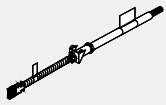

- Snaps into the power distribution housing.
- Includes 84" long flexible vinyl conduit.
- Includes bracket to attach to vertical raceway panel.
- Must be hard wire to source by licenced electrician.

| PRODUCT CODE | PRICE | SIZE/ INCHES | | | WEIGHT VOL | |
|--------------|-------|--------------|----|---|------------|-----------------|
| | | H | W | D | LBS | FT ³ |
| EVE8FR3PB | 435 | 3 | 84 | 2 | 3.82 | 2.00 |

EVE8EC • Ceiling Power Entry

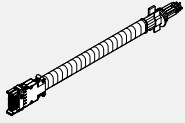

- Snaps into the end of the Power Distribution Housing.
- Flexible metal conduit extends into the ceiling through a corner post and post extension (both ordered separately).
- Must be hard wired to source power by a licensed electrician.
- 4" Junction Box included.

| PRODUCT CODE | PRICE | SIZE/ INCHES | | | WEIGHT VOL | |
|--------------|-------|--------------|------|-----------------|------------|-----------------|
| | | L | LBS | FT ³ | LBS | FT ³ |
| EVE8EC1 | 268 | 132 | 5.24 | 2.00 | | |
| EVE8EC2 | 479 | 144 | 5.96 | 2.00 | | |

EVE8FR3PBP • Power Entry for Power Beam for Wall Plate Infeed

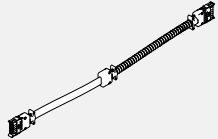

- Snaps into power distribution housing.
- Includes 48" long flexible vinyl conduit with connector.
- Includes bracket to attach to vertical raceway panel
- Power Beam with electrical cut out must be ordered.
- 71" long base feed will work with 24" and 36" H Power Beam.
- Note: EVE8FR3PBP will only work with Wall Plate Infeed EVE8WPIPB.

| PRODUCT CODE | PRICE | SIZE/INCHES | | | WEIGHT VOL | |
|--------------|-------|-------------|----|---|------------|-----------------|
| | | H | W | D | LBS | FT ³ |
| EVE8FR3PBP | 373 | 3 | 71 | 2 | 3.82 | 2.00 |

EVE8WPIPB • Wall Plate Infeed for Power Beam

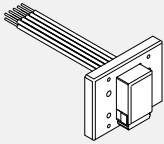

- Wall plate infeed must be installed and hardwired to source by licensed electrician.
- Note: EVE8FR3PBP will only work with Wall Plate Infeed EVE8WPIPB.

| PRODUCT CODE | PRICE | SIZE/INCHES | | | WEIGHT VOL | |
|--------------|-------|-------------|------|------|------------|-----------------|
| | | H | W | D | LBS | FT ³ |
| EVE8WPIPB | 607 | 5.25 | 5.25 | 1.75 | 1.00 | 0.10 |

EVEJBC1PB • Hardwire Junction Box for Power Beam

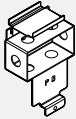

- Can be retrofitted in any size of panel at the receptacle location.
- Gives access from one side only at each location.
- Customer to supply conduit, wiring, receptacle, and face plate 2 per Power Beam.
- A licensed electrician must provide hard wire connection with the junction box.
- For use with Power Beam only.

| PRODUCT CODE | PRICE | WEIGHT VOL | |
|--------------|-------|------------|-----------------|
| | | LBS | FT ³ |
| EVEJBC1PB | 105 | 1.50 | 0.02 |

EVDPE • Post Extension Data/Comm Lay-in

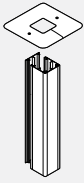

- Attaches to the top of a post to bring power and/or data cables from the ceiling to panel power way.
- Three-sided power pole with snap-on fourth side.
- Post extension can be opened on one side for lay-in for power and/or data cables.
- Made of aluminum and can be field cut.
- Accommodates up to 25 CAT5 cables with electric. Accommodates up to 45 CAT5 cables without electric.

| PRODUCT CODE | PRICE | SIZE/ INCHES | | WEIGHT LBS | VOL FT ³ |
|--------------|-------|--------------|-------|------------|---------------------|
| | | H | W | | |
| EVDPE64 | 160 | 64 | 2.875 | 3.00 | 0.70 |
| EVDPE82 | 197 | 82 | 2.875 | 4.20 | 0.80 |
| EVDPE88 | 302 | 88 | 2.875 | 4.50 | 0.85 |
| EVDPE94 | 323 | 94 | 2.875 | 4.80 | 0.92 |
| EVDPE100 | 344 | 100 | 2.875 | 5.12 | 0.97 |

EVDP4E • 45° Post Extension Data/Comm Lay-in

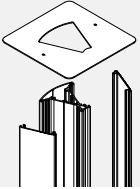

- Attached to the top of the 45° Corner Post to bring power and/or data cables from the ceiling to the panel run through.
- Cable capacity
 - 40 CAT5 cables without electric feed.
 - 10 CAT5 cables with electric feed.

| PRODUCT CODE | PRICE | SIZE/ INCHES | | WEIGHT LBS | VOL FT ³ |
|--------------|-------|--------------|------|------------|---------------------|
| | | H | W | | |
| EVDP4E64 | 162 | 64 | 3.65 | 3.00 | 0.70 |
| EVDP4E82 | 218 | 82 | 3.65 | 4.20 | 0.80 |

EVDP6E • 60° Post Extension Data/Comm Lay-in

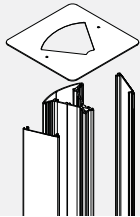

- Attached to the top of the 60° Corner Post to bring power and/or data cables from the ceiling to the panel run through.
- Post extension can be opened on one side for lay-in power and/or data cables.
- Made of aluminum and can be field cut.
- Two sided power pole with snap-on third side.
- Cable capacity
 - 32 CAT5 cables without electric.
 - 15 CAT5 cables with electric

| PRODUCT CODE | PRICE | SIZE/ INCHES | | WEIGHT LBS | VOL FT ³ |
|--------------|-------|--------------|---|------------|---------------------|
| | | H | W | | |
| EVDP6E64 | 157 | 64 | 2 | 3.00 | 0.70 |
| EVDP6E82 | 192 | 82 | 2 | 4.20 | 0.80 |

EVPBECH34 • Wire Manager Kit



- Provides cable management from Power Beam to Height Adjustable Table.
- Includes bracket to attach to bottom trim of Power Beam.
- Cables fit easily.
- Includes a neoprene wire manager sock, bracket and screws.
- Neoprene available in black only.
- Specify bracket paint finish.

| PRODUCT CODE | PRICE | SIZE/ INCHES | | | WEIGHT LBS | VOL FT ³ |
|--------------|-------|--------------|----|---|------------|---------------------|
| | | H | W | D | | |
| EVPBECH34 | 421 | 1 | 41 | 2 | 0.60 | 0.04 |

EVPBT01 • Power Beam Tray

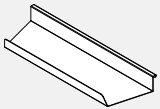

- Power beam tray provides support for wires.
- Can be used with power beam only.
- Available in standard and premium paint finishes.

| PRODUCT CODE | PRICE | SIZE/ INCHES | | | WEIGHT LBS | VOL FT ³ |
|--------------|-------|--------------|------|-----|------------|---------------------|
| | | H | W | D | | |
| EVPBT01 | 32 | 12 | 1.25 | 3.5 | 0.60 | 0.04 |

EVAFMB01 • Floor Mount Plate

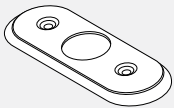

- Attached to floor.
- Secures panel to floor.
- Attachment screws not included.
- Care should be taken to use correct fasteners for type of floor.
- Available in chrome finish only.

| PRODUCT CODE | PRICE | SIZE/ INCHES | | | WEIGHT LBS | VOL FT ³ |
|--------------|-------|--------------|---|-----|------------|---------------------|
| | | H | W | D | | |
| EVAFMB01 | 72 | 0.25 | 5 | 2.5 | 0.2 | 0.02 |

WORKSURFACES • TECHNICAL INFORMATION

- All worksurfaces have threaded inserts for metal-to-metal connection of support hardware.
- Back edge features scoop detail and sits 3/8" away from the face of a panel for wire management. Scoop depth is 3/4" at centre.
- Communication and electrical wires are routed through the cable scoop at the back of the worksurface.
- Straight or Curvilinear Worksurfaces 48" or less have one scoop while those that are 54" or more have two scoops. All other worksurface shapes have one scoop.

- LP and HP worksurfaces are 3.5 mm edge banded.
- LP worksurfaces are 1" thick particle board with laminate finish.
- HP worksurfaces are 1 1/16" thick particle board with laminate finish overall.
- All support hardware must be ordered separately.
- Wood grain laminates on corner worksurfaces may run diagonal to the adjacent worksurfaces. Specify "WG" at the end of the worksurface code.
- Please use "Wood Grain Direction" chart at the beginning of the price list.

WORKSURFACES • GUIDELINE FOR ORDERING PRODUCT

The price list uses a numbering system with meaningful alphanumeric characters to create a simple-to-understand product number. This makes specifying the product much easier and more accurate.

EXAMPLE OF WORKSURFACE CODE

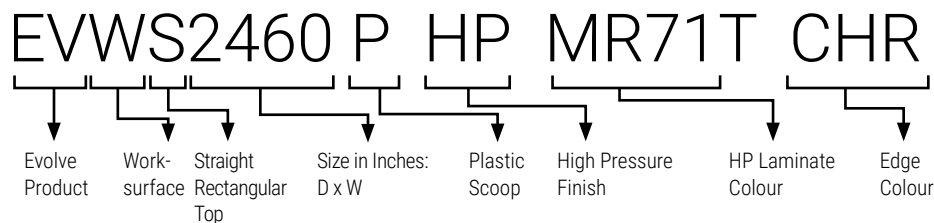

HOW TO SPECIFY

- Specify Evolve worksurface type and size by code.
- Specify type of finish.
- Specify High or LOW Pressure Laminate Colour.
- Specify PVC edge colour.

EVWS • Straight Worksurface

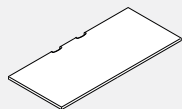

- Straight rectangular worksurfaces are non-handed and can be interchanged on site.
- Please choose from DWT - Designer White, SIL - Silver or BLK - Black for scoop covers.

| PRODUCT CODE | PRICE | | SIZE/ INCHES | | | WEIGHT VOL | |
|--------------|-------|------|--------------|----|----|------------|------|
| | LP | HP | H | W | D | LBS | FT³ |
| EVWS1818P | 127 | 161 | 1 | 18 | 18 | 12.50 | 0.37 |
| EVWS1824P | 131 | 174 | 1 | 24 | 18 | 13.50 | 0.40 |
| EVWS1830P | 138 | 183 | 1 | 30 | 18 | 16.50 | 0.54 |
| EVWS1836P | 159 | 210 | 1 | 36 | 18 | 19.50 | 0.63 |
| EVWS1842P | 208 | 278 | 1 | 42 | 18 | 23.25 | 0.73 |
| EVWS1848P | 249 | 328 | 1 | 48 | 18 | 26.25 | 0.83 |
| EVWS1854P | 293 | 385 | 1 | 54 | 18 | 29.25 | 0.93 |
| EVWS1860P | 329 | 422 | 1 | 60 | 18 | 33.00 | 1.02 |
| EVWS1866P | 344 | 452 | 1 | 66 | 18 | 36.75 | 1.12 |
| EVWS1872P | 363 | 478 | 1 | 72 | 18 | 39.75 | 1.21 |
| EVWS1878P | 380 | 503 | 1 | 78 | 18 | 38.50 | 1.23 |
| EVWS1884P | 417 | 546 | 1 | 84 | 18 | 39.75 | 1.21 |
| EVWS1890P | 542 | 797 | 1 | 90 | 18 | 48.75 | 1.53 |
| EVWS1896P | 578 | 852 | 1 | 96 | 18 | 51.75 | 1.73 |
| EVWS2418P | 131 | 168 | 1 | 18 | 24 | 12.00 | 0.50 |
| EVWS2424P | 133 | 178 | 1 | 24 | 24 | 18.00 | 0.60 |
| EVWS2430P | 145 | 190 | 1 | 30 | 24 | 22.00 | 0.72 |
| EVWS2436P | 161 | 213 | 1 | 36 | 24 | 26.00 | 0.85 |
| EVWS2442P | 211 | 280 | 1 | 42 | 24 | 31.00 | 0.98 |
| EVWS2448P | 252 | 339 | 1 | 48 | 24 | 35.00 | 1.11 |
| EVWS2454P | 299 | 394 | 1 | 54 | 24 | 39.00 | 1.23 |
| EVWS2460P | 336 | 443 | 1 | 60 | 24 | 44.00 | 1.36 |
| EVWS2466P | 350 | 462 | 1 | 66 | 24 | 49.00 | 1.49 |
| EVWS2472P | 366 | 484 | 1 | 72 | 24 | 53.00 | 1.62 |
| EVWS2478P | 392 | 516 | 1 | 78 | 24 | 57.18 | 2.16 |
| EVWS2484P | 422 | 553 | 1 | 84 | 24 | 61.50 | 2.33 |
| EVWS2490P | 542 | 797 | 1 | 90 | 24 | 64.50 | 2.53 |
| EVWS2496P | 578 | 852 | 1 | 96 | 24 | 68.50 | 2.73 |
| EVWS3018P | 149 | 192 | 1 | 18 | 30 | 15.30 | 0.63 |
| EVWS3024P | 159 | 208 | 1 | 24 | 30 | 22.00 | 0.74 |
| EVWS3030P | 170 | 225 | 1 | 30 | 30 | 28.00 | 0.90 |
| EVWS3036P | 200 | 264 | 1 | 36 | 30 | 33.00 | 1.06 |
| EVWS3042P | 283 | 373 | 1 | 42 | 30 | 38.00 | 1.22 |
| EVWS3048P | 299 | 394 | 1 | 48 | 30 | 44.00 | 1.38 |
| EVWS3054P | 327 | 420 | 1 | 54 | 30 | 49.00 | 1.54 |
| EVWS3060P | 350 | 462 | 1 | 60 | 30 | 55.00 | 1.69 |
| EVWS3066P | 364 | 483 | 1 | 66 | 30 | 60.00 | 1.85 |
| EVWS3072P | 385 | 510 | 1 | 72 | 30 | 66.00 | 2.01 |
| EVWS3078P | 410 | 540 | 1 | 78 | 30 | 71.48 | 2.70 |
| EVWS3084P | 456 | 596 | 1 | 84 | 30 | 76.98 | 2.92 |
| EVWS3090P | 676 | 998 | 1 | 90 | 30 | 81.98 | 3.12 |
| EVWS3096P | 722 | 1064 | 1 | 96 | 30 | 68.50 | 3.32 |
| EVWS3672P | 544 | 712 | 1 | 72 | 36 | 79.20 | 2.42 |

EVWS • Straight Worksurface to Span a Post

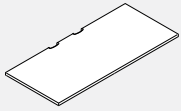

- Straight rectangular worksurfaces are non-handed and can be interchanged on site.
- Worksurface will span the width of a post eliminating a gap between standard sizes.
- Please choose from DWT - Designer White, SIL - Silver or BLK - Black for scoop covers.

| PRODUCT CODE | PRICE | | SIZE/ INCHES | | | WEIGHT VOL | |
|--------------|-------|-----|--------------|----|----|------------|-----------------|
| | LP | HP | H | W | D | LBS | FT ³ |
| EVWSP1827P | 138 | 183 | 1 | 27 | 18 | 16.50 | 0.54 |
| EVWSP1833P | 174 | 210 | 1 | 33 | 18 | 19.50 | 0.53 |
| EVWSP1839P | 208 | 278 | 1 | 39 | 18 | 23.25 | 0.73 |
| EVWSP1845P | 249 | 328 | 1 | 45 | 18 | 26.25 | 0.83 |
| EVWSP1851P | 293 | 385 | 1 | 51 | 18 | 29.25 | 0.93 |
| EVWSP1857P | 329 | 422 | 1 | 57 | 18 | 33.00 | 1.02 |
| EVWSP1863P | 344 | 452 | 1 | 63 | 18 | 36.75 | 1.12 |
| EVWSP1869P | 363 | 478 | 1 | 69 | 18 | 39.75 | 1.21 |
| EVWSP1875P | 380 | 503 | 1 | 75 | 18 | 42.75 | 1.33 |
| EVWSP1881P | 417 | 546 | 1 | 81 | 18 | 45.75 | 1.43 |
| EVWSP2427P | 145 | 190 | 1 | 27 | 24 | 22.00 | 0.72 |
| EVWSP2433P | 161 | 213 | 1 | 33 | 24 | 26.00 | 0.85 |
| EVWSP2439P | 211 | 280 | 1 | 39 | 24 | 31.00 | 0.98 |
| EVWSP2445P | 252 | 339 | 1 | 45 | 24 | 35.00 | 1.11 |
| EVWSP2451P | 299 | 394 | 1 | 51 | 24 | 39.00 | 1.23 |
| EVWSP2457P | 336 | 443 | 1 | 57 | 24 | 44.00 | 1.36 |
| EVWSP2463P | 350 | 462 | 1 | 63 | 24 | 49.00 | 1.49 |
| EVWSP2469P | 366 | 484 | 1 | 69 | 24 | 53.00 | 1.62 |
| EVWSP2475P | 392 | 516 | 1 | 75 | 24 | 57.18 | 2.16 |
| EVWSP2481P | 422 | 553 | 1 | 81 | 24 | 61.50 | 2.33 |
| EVWSP3027P | 170 | 225 | 1 | 27 | 30 | 28.00 | 0.90 |
| EVWSP3033P | 200 | 264 | 1 | 33 | 30 | 33.00 | 1.06 |
| EVWSP3039P | 283 | 373 | 1 | 39 | 30 | 38.00 | 1.22 |
| EVWSP3045P | 299 | 394 | 1 | 45 | 30 | 44.00 | 1.38 |
| EVWSP3051P | 327 | 420 | 1 | 51 | 30 | 49.00 | 1.54 |
| EVWSP3057P | 350 | 462 | 1 | 57 | 30 | 55.00 | 1.69 |
| EVWSP3063P | 364 | 483 | 1 | 63 | 30 | 60.00 | 1.85 |
| EVWSP3069P | 385 | 510 | 1 | 69 | 30 | 66.00 | 2.01 |
| EVWSP3075P | 410 | 540 | 1 | 75 | 30 | 71.48 | 2.70 |
| EVWSP3081P | 456 | 596 | 1 | 81 | 30 | 76.98 | 2.92 |

EVWVL • Curvilinear Worksurface Left

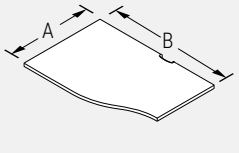

- When deepest end equals 24", the opposite depth is 18".
- When deepest end equals 30", the opposite depth is 24".
- Please choose from DWT - Designer White, SIL - Silver or BLK - Black for scoop covers.

NOTE: EVWV

| | |
|-------|-------|
| 24 | 36 |
| A | B |
| DEPTH | WIDTH |

| PRODUCT CODE | PRICE | | SIZE/ INCHES | | | WEIGHT VOL | |
|--------------|-------|-----|--------------|----|----|------------|-----------------|
| | LP | HP | H | W | D | LBS | FT ³ |
| EVWVL2424P | 172 | 233 | 1 | 24 | 24 | 15.00 | 0.59 |
| EVWVL2430P | 182 | 240 | 1 | 30 | 24 | 19.00 | 0.72 |
| EVWVL2436P | 217 | 289 | 1 | 36 | 24 | 23.00 | 0.85 |
| EVWVL2442P | 252 | 339 | 1 | 42 | 24 | 27.00 | 0.98 |
| EVWVL2448P | 289 | 385 | 1 | 48 | 24 | 31.00 | 1.11 |
| EVWVL2454P | 327 | 433 | 1 | 54 | 24 | 35.00 | 1.23 |
| EVWVL2460P | 354 | 483 | 1 | 60 | 24 | 39.00 | 1.36 |
| EVWVL2466P | 392 | 528 | 1 | 66 | 24 | 43.00 | 1.49 |
| EVWVL2472P | 420 | 578 | 1 | 72 | 24 | 47.00 | 1.62 |
| EVWVL3024P | 174 | 239 | 1 | 24 | 30 | 19.00 | 0.74 |
| EVWVL3030P | 192 | 251 | 1 | 30 | 30 | 24.00 | 0.90 |
| EVWVL3036P | 229 | 289 | 1 | 36 | 30 | 29.00 | 1.06 |
| EVWVL3042P | 312 | 412 | 1 | 42 | 30 | 34.00 | 1.22 |
| EVWVL3048P | 327 | 433 | 1 | 48 | 30 | 39.00 | 1.38 |
| EVWVL3054P | 364 | 483 | 1 | 54 | 30 | 44.00 | 1.54 |
| EVWVL3060P | 391 | 528 | 1 | 60 | 30 | 49.00 | 1.69 |
| EVWVL3066P | 420 | 578 | 1 | 66 | 30 | 54.00 | 1.85 |
| EVWVL3072P | 451 | 626 | 1 | 72 | 30 | 59.00 | 2.01 |
| EVWVL3078P | 653 | 833 | 1 | 78 | 30 | 71.48 | 2.71 |
| EVWVL3084P | 833 | 850 | 1 | 84 | 30 | 76.98 | 2.91 |

EVWVR • Curvilinear Worksurface Right

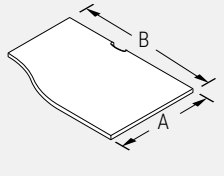

- When deepest end equals 24", the opposite depth is 18".
- When deepest end equals 30", the opposite depth is 24".
- Please choose from DWT - Designer White, SIL - Silver or BLK - Black for scoop covers.

NOTE: EVWV

| | |
|-------|-------|
| 24 | 36 |
| A | B |
| DEPTH | WIDTH |

| PRODUCT CODE | PRICE | | SIZE/ INCHES | | | WEIGHT VOL | |
|--------------|-------|-----|--------------|----|----|------------|-----------------|
| | LP | HP | H | W | D | LBS | FT ³ |
| EVWVR2424P | 172 | 233 | 1 | 24 | 24 | 15.00 | 0.59 |
| EVWVR2430P | 182 | 240 | 1 | 30 | 24 | 19.00 | 0.72 |
| EVWVR2436P | 217 | 289 | 1 | 36 | 24 | 23.00 | 0.85 |
| EVWVR2442P | 252 | 339 | 1 | 42 | 24 | 27.00 | 0.98 |
| EVWVR2448P | 289 | 385 | 1 | 48 | 24 | 31.00 | 1.11 |
| EVWVR2454P | 327 | 433 | 1 | 54 | 24 | 35.00 | 1.23 |
| EVWVR2460P | 354 | 483 | 1 | 60 | 24 | 39.00 | 1.36 |
| EVWVR2466P | 392 | 528 | 1 | 66 | 24 | 43.00 | 1.49 |
| EVWVR2472P | 420 | 578 | 1 | 72 | 24 | 47.00 | 1.62 |
| EVWVR3024P | 174 | 239 | 1 | 24 | 30 | 19.00 | 0.74 |
| EVWVR3030P | 192 | 251 | 1 | 30 | 30 | 24.00 | 0.90 |
| EVWVR3036P | 229 | 289 | 1 | 36 | 30 | 29.00 | 1.06 |
| EVWVR3042P | 312 | 412 | 1 | 42 | 30 | 34.00 | 1.22 |
| EVWVR3048P | 327 | 433 | 1 | 48 | 30 | 39.00 | 1.38 |
| EVWVR3054P | 364 | 483 | 1 | 54 | 30 | 44.00 | 1.54 |
| EVWVR3060P | 391 | 528 | 1 | 60 | 30 | 49.00 | 1.69 |
| EVWVR3066P | 420 | 578 | 1 | 66 | 30 | 54.00 | 1.85 |
| EVWVR3072P | 451 | 626 | 1 | 72 | 30 | 59.00 | 2.01 |
| EVWVR3078P | 653 | 833 | 1 | 78 | 30 | 71.48 | 2.71 |
| EVWVR3084P | 757 | 850 | 1 | 84 | 30 | 76.98 | 2.71 |

EVWNL • Notched Worksurface Left

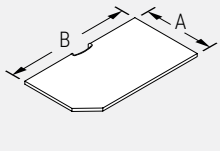

- When deepest end equals 24", the opposite depth is 18".
- When deepest end equals 30", the opposite depth is 24".
- The user edge is 6" shorter than the overall length.
- Please choose from DWT - Designer White, SIL - Silver or BLK - Black for scoop covers.

NOTE: EVWN

| | |
|-------|-------|
| 24 | 36 |
| A | B |
| DEPTH | WIDTH |

| PRODUCT CODE | PRICE | | SIZE/ INCHES | | | WEIGHT VOL | |
|--------------|-------|-----|--------------|----|----|------------|-----------------|
| | LP | HP | H | W | D | LBS | FT ³ |
| EVWNL2424P | 172 | 233 | 1 | 24 | 24 | 15.00 | 0.59 |
| EVWNL2430P | 182 | 240 | 1 | 30 | 24 | 19.00 | 0.72 |
| EVWNL2436P | 217 | 289 | 1 | 36 | 24 | 23.00 | 0.85 |
| EVWNL2442P | 252 | 339 | 1 | 42 | 24 | 27.00 | 0.98 |
| EVWNL2448P | 289 | 385 | 1 | 48 | 24 | 31.00 | 1.11 |
| EVWNL2454P | 327 | 433 | 1 | 54 | 24 | 35.00 | 1.23 |
| EVWNL2460P | 354 | 483 | 1 | 60 | 24 | 39.00 | 1.36 |
| EVWNL2466P | 392 | 528 | 1 | 66 | 24 | 43.00 | 1.49 |
| EVWNL2472P | 420 | 578 | 1 | 72 | 24 | 47.00 | 1.62 |
| EVWNL3024P | 174 | 239 | 1 | 24 | 30 | 19.00 | 0.74 |
| EVWNL3030P | 192 | 251 | 1 | 30 | 30 | 24.00 | 0.90 |
| EVWNL3036P | 229 | 289 | 1 | 36 | 30 | 29.00 | 1.06 |
| EVWNL3042P | 312 | 412 | 1 | 42 | 30 | 34.00 | 1.22 |
| EVWNL3048P | 327 | 433 | 1 | 48 | 30 | 39.00 | 1.38 |
| EVWNL3054P | 364 | 483 | 1 | 54 | 30 | 44.00 | 1.54 |
| EVWNL3060P | 391 | 528 | 1 | 60 | 30 | 49.00 | 1.69 |
| EVWNL3066P | 420 | 578 | 1 | 66 | 30 | 54.00 | 1.85 |
| EVWNL3072P | 451 | 626 | 1 | 72 | 30 | 59.00 | 2.01 |
| EVWNL3078P | 653 | 833 | 1 | 78 | 30 | 71.48 | 2.70 |
| EVWNL3084P | 833 | 850 | 1 | 84 | 30 | 76.98 | 2.92 |

EVWNR • Notched Worksurface Right

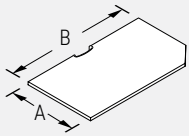

- When deepest end equals 24", the opposite depth is 18".
- When deepest end equals 30", the opposite depth is 24".
- The user edge is 6" shorter than the overall length.
- Please choose from DWT - Designer White, SIL - Silver or BLK - Black for scoop covers.

NOTE: EVWN

| | |
|-------|-------|
| 24 | 36 |
| A | B |
| DEPTH | WIDTH |

| PRODUCT CODE | PRICE | | SIZE/ INCHES | | | WEIGHT VOL | |
|--------------|-------|-----|--------------|----|----|------------|-----------------|
| | LP | HP | H | W | D | LBS | FT ³ |
| EVWNR2424P | 172 | 233 | 1 | 24 | 24 | 15.00 | 0.59 |
| EVWNR2430P | 182 | 240 | 1 | 30 | 24 | 19.00 | 0.72 |
| EVWNR2436P | 217 | 289 | 1 | 36 | 24 | 23.00 | 0.85 |
| EVWNR2442P | 252 | 339 | 1 | 42 | 24 | 27.00 | 0.98 |
| EVWNR2448P | 289 | 385 | 1 | 48 | 24 | 31.00 | 1.11 |
| EVWNR2454P | 327 | 433 | 1 | 54 | 24 | 35.00 | 1.23 |
| EVWNR2460P | 354 | 483 | 1 | 60 | 24 | 39.00 | 1.36 |
| EVWNR2466P | 392 | 528 | 1 | 66 | 24 | 43.00 | 1.49 |
| EVWNR2472P | 420 | 578 | 1 | 72 | 24 | 27.00 | 1.62 |
| EVWNR3024P | 174 | 239 | 1 | 24 | 24 | 19.00 | 0.74 |
| EVWNR3030P | 192 | 251 | 1 | 30 | 30 | 24.00 | 0.90 |
| EVWNR3036P | 229 | 289 | 1 | 36 | 30 | 29.00 | 1.06 |
| EVWNR3042P | 312 | 412 | 1 | 42 | 30 | 34.00 | 1.22 |
| EVWNR3048P | 327 | 433 | 1 | 48 | 30 | 39.00 | 1.38 |
| EVWNR3054P | 364 | 483 | 1 | 54 | 30 | 44.00 | 1.54 |
| EVWNR3060P | 391 | 528 | 1 | 60 | 30 | 49.00 | 1.69 |
| EVWNR3066P | 420 | 578 | 1 | 66 | 30 | 54.00 | 1.85 |
| EVWNR3072P | 451 | 626 | 1 | 72 | 30 | 59.00 | 2.01 |
| EVWNR3078P | 653 | 833 | 1 | 78 | 30 | 71.48 | 2.70 |
| EVWNR3084P | 833 | 850 | 1 | 84 | 30 | 76.98 | 2.92 |

EVWC4C • Corner Curved Worksurface For 45° Post

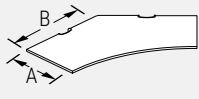

NOTE:
A= 18, 24, 30
B= 24, 30, 36, 42, 48

- "WG" at the end of the code indicates wood grain laminate on the diagonal.
- "WG" worksurface over 42" cannot be done on the diagonal.
- Support hardware must be ordered separately. See the listing in this section.
- Please choose from DWT - Designer White, SIL - Silver or BLK - Black for scoop covers.

| PRODUCT CODE | PRICE | | SIZE/ INCHES | INCHES | | WEIGHT VOL | |
|---------------|-------|------|--------------|--------|----|------------|------|
| | LP | HP | | H | W | D | LBS |
| EVWC4C1824P | 397 | 495 | 1 | 24 | 18 | 19.38 | 0.43 |
| EVWC4C1830P | 512 | 638 | 1 | 30 | 18 | 24.87 | 0.55 |
| EVWC4C1836P | 720 | 895 | 1 | 36 | 18 | 30.36 | 0.67 |
| EVWC4C1842P | 1166 | 1456 | 1 | 42 | 18 | 35.78 | 0.80 |
| EVWC4C1848P | 1358 | 1697 | 1 | 48 | 18 | 41.28 | 0.92 |
| EVWC4C2424P | 411 | 516 | 1 | 24 | 24 | 24.04 | 0.53 |
| EVWC4C2430P | 578 | 723 | 1 | 30 | 24 | 31.38 | 0.70 |
| EVWC4C2436P | 797 | 998 | 1 | 36 | 24 | 38.72 | 0.86 |
| EVWC4C2442P | 1166 | 1456 | 1 | 42 | 24 | 46.07 | 1.02 |
| EVWC4C2448P | 1527 | 1907 | 1 | 48 | 24 | 53.41 | 1.19 |
| EVWC4C3024P | 431 | 537 | 1 | 24 | 30 | 27.94 | 0.62 |
| EVWC4C3030P | 641 | 802 | 1 | 30 | 30 | 37.16 | 0.83 |
| EVWC4C3036P | 877 | 1094 | 1 | 36 | 30 | 46.38 | 1.03 |
| EVWC4C3042P | 1306 | 1638 | 1 | 42 | 30 | 55.60 | 1.24 |
| EVWC4C3048P | 1697 | 2121 | 1 | 48 | 30 | 64.82 | 1.44 |
| EVWC4C1824WGP | 595 | 743 | 1 | 24 | 18 | 19.38 | 0.43 |
| EVWC4C1830WGP | 768 | 957 | 1 | 30 | 18 | 24.87 | 0.55 |
| EVWC4C1836WGP | 1079 | 1343 | 1 | 36 | 18 | 30.36 | 0.67 |
| EVWC4C1842WGP | 1749 | 2184 | 1 | 42 | 18 | 35.78 | 0.80 |
| EVWC4C2424WGP | 617 | 774 | 1 | 24 | 24 | 24.04 | 0.53 |
| EVWC4C2430WGP | 867 | 1085 | 1 | 30 | 24 | 31.38 | 0.70 |
| EVWC4C2436WGP | 1197 | 1498 | 1 | 36 | 24 | 38.72 | 0.86 |
| EVWC4C2442WGP | 1749 | 2184 | 1 | 42 | 24 | 46.07 | 1.02 |
| EVWC4C3024WGP | 646 | 805 | 1 | 24 | 30 | 27.94 | 0.62 |
| EVWC4C3030WGP | 960 | 1203 | 1 | 30 | 30 | 37.16 | 0.83 |
| EVWC4C3036WGP | 1315 | 1640 | 1 | 36 | 30 | 46.38 | 1.03 |
| EVWC4C3042WGP | 1959 | 2456 | 1 | 42 | 30 | 55.60 | 1.24 |

EVWC4K • Keyboard Corner Worksurface For 45° Post

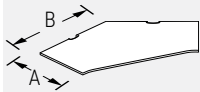

NOTE:
A= 18, 24, 30
B= 24, 30, 36, 42, 48

- "WG" at the end of the code indicates wood grain laminate on the diagonal.
- "WG" worksurface over 42" cannot be done on the diagonal.
- Support hardware must be ordered separately. See the listing in this section.
- Please choose from DWT - Designer White, SIL - Silver or BLK - Black for scoop covers.

| PRODUCT CODE | PRICE | | SIZE/ INCHES | INCHES | | WEIGHT VOL | |
|---------------|-------|------|--------------|--------|----|------------|------|
| | LP | HP | | H | W | D | LBS |
| EVWC4K1824P | 422 | 534 | 1 | 24 | 18 | 19.38 | 0.43 |
| EVWC4K1830P | 656 | 819 | 1 | 30 | 18 | 24.87 | 0.55 |
| EVWC4K1836P | 931 | 1168 | 1 | 36 | 18 | 30.36 | 0.67 |
| EVWC4K1842P | 1166 | 1456 | 1 | 42 | 18 | 35.78 | 0.80 |
| EVWC4K1848P | 1358 | 1697 | 1 | 48 | 18 | 41.28 | 0.92 |
| EVWC4K2424P | 509 | 636 | 1 | 24 | 24 | 24.04 | 0.53 |
| EVWC4K2430P | 762 | 955 | 1 | 30 | 24 | 31.38 | 0.70 |
| EVWC4K2436P | 1066 | 1332 | 1 | 36 | 24 | 38.72 | 0.86 |
| EVWC4K2442P | 1166 | 1456 | 1 | 42 | 24 | 46.07 | 1.02 |
| EVWC4K2448P | 1527 | 1907 | 1 | 48 | 24 | 53.41 | 1.19 |
| EVWC4K3024P | 593 | 744 | 1 | 24 | 30 | 27.94 | 0.62 |
| EVWC4K3030P | 942 | 1090 | 1 | 30 | 30 | 37.16 | 0.83 |
| EVWC4K3036P | 1066 | 1332 | 1 | 36 | 30 | 46.38 | 1.03 |
| EVWC4K3042P | 1306 | 1638 | 1 | 42 | 30 | 55.60 | 1.24 |
| EVWC4K3048P | 1697 | 2121 | 1 | 48 | 30 | 64.82 | 1.44 |
| EVWC4K1824WGP | 633 | 800 | 1 | 24 | 18 | 19.38 | 0.43 |
| EVWC4K1830WGP | 984 | 1229 | 1 | 30 | 18 | 24.87 | 0.55 |
| EVWC4K1836WGP | 1397 | 1752 | 1 | 36 | 18 | 30.36 | 0.67 |
| EVWC4K1842WGP | 1749 | 2184 | 1 | 42 | 18 | 35.78 | 0.80 |
| EVWC4K2424WGP | 763 | 954 | 1 | 24 | 24 | 24.04 | 0.53 |
| EVWC4K2430WGP | 1143 | 1433 | 1 | 30 | 24 | 31.38 | 0.70 |
| EVWC4K2436WGP | 1600 | 1997 | 1 | 36 | 24 | 38.72 | 0.86 |
| EVWC4K2442WGP | 1749 | 2184 | 1 | 42 | 24 | 46.07 | 1.02 |
| EVWC4K3024WGP | 891 | 1114 | 1 | 24 | 30 | 27.94 | 0.62 |
| EVWC4K3030WGP | 1414 | 1635 | 1 | 30 | 30 | 37.16 | 0.83 |
| EVWC4K3036WGP | 1600 | 1997 | 1 | 36 | 30 | 46.38 | 1.03 |
| EVWC4K3042WGP | 1959 | 2456 | 1 | 42 | 30 | 55.60 | 1.24 |

EVW4T • Corner Transaction Surface For 45° Post

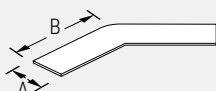

- Support hardware must be ordered separately. See the listing in this section.
- For use with laminate end and middle panels.

NOTE:
A= 15
B= 24, 30, 36, 42, 48

| PRODUCT CODE | PRICE | | SIZE/ INCHES | INCHES | | WEIGHT VOL | |
|--------------|-------|------|--------------|--------|----|------------|------|
| | LP | HP | | H | W | D | LBS |
| EVW4T1524 | 582 | 726 | 1 | 24 | 15 | 19.14 | 0.43 |
| EVW4T1530 | 726 | 909 | 1 | 30 | 15 | 23.78 | 0.53 |
| EVW4T1536 | 1018 | 1272 | 1 | 36 | 15 | 28.39 | 0.63 |
| EVW4T1542 | 1358 | 1697 | 1 | 42 | 15 | 32.99 | 0.73 |
| EVW4T1548 | 1456 | 1817 | 1 | 48 | 15 | 37.58 | 0.84 |

EVWC6C • Corner Curved Worksurface For 60° Post



- "WG" at the end of the code indicates wood grain laminate on the diagonal.
- "WG" worksurface over 42" cannot be done on the diagonal.
- Support hardware must be ordered separately. See the listing in this section.
- Please choose from DWT - Designer White, SIL - Silver or BLK - Black for scoop covers.

NOTE:

A= 18, 24, 30
B= 24, 30, 36, 42, 48

| PRODUCT CODE | PRICE | | SIZE/ INCHES | | | WEIGHT VOL | |
|---------------|-------|------|--------------|----|----|------------|-----------------|
| | LP | HP | H | W | D | LBS | FT ³ |
| EVWC6C1824P | 341 | 425 | 1 | 24 | 18 | 17.76 | 0.39 |
| EVWC6C1830P | 465 | 581 | 1 | 30 | 18 | 23.26 | 0.52 |
| EVWC6C1836P | 661 | 829 | 1 | 36 | 18 | 28.75 | 0.64 |
| EVWC6C1842P | 975 | 1073 | 1 | 42 | 18 | 34.17 | 0.76 |
| EVWC6C1848P | 1330 | 1464 | 1 | 48 | 18 | 39.66 | 0.88 |
| EVWC6C2424P | 354 | 446 | 1 | 24 | 24 | 21.25 | 0.47 |
| EVWC6C2430P | 508 | 631 | 1 | 30 | 24 | 28.59 | 0.64 |
| EVWC6C2436P | 712 | 892 | 1 | 36 | 24 | 35.94 | 0.80 |
| EVWC6C2442P | 1223 | 1340 | 1 | 42 | 24 | 43.28 | 0.96 |
| EVWC6C2448P | 1330 | 1464 | 1 | 48 | 24 | 50.63 | 1.13 |
| EVWC6C3024P | 372 | 465 | 1 | 24 | 30 | 23.72 | 0.53 |
| EVWC6C3030P | 544 | 683 | 1 | 30 | 30 | 32.94 | 0.73 |
| EVWC6C3036P | 762 | 954 | 1 | 36 | 30 | 42.16 | 0.94 |
| EVWC6C3042P | 1223 | 1340 | 1 | 42 | 30 | 51.38 | 1.14 |
| EVWC6C3048P | 1330 | 1464 | 1 | 48 | 30 | 60.60 | 1.35 |
| EVWC6C1824WGP | 512 | 638 | 1 | 24 | 18 | 17.76 | 0.39 |
| EVWC6C1830WGP | 697 | 871 | 1 | 30 | 18 | 23.26 | 0.52 |
| EVWC6C1836WGP | 993 | 1244 | 1 | 36 | 18 | 28.75 | 0.64 |
| EVWC6C1842WGP | 1464 | 1610 | 1 | 42 | 18 | 34.17 | 0.76 |
| EVWC6C2424WGP | 531 | 670 | 1 | 30 | 24 | 28.59 | 0.64 |
| EVWC6C2430WGP | 761 | 947 | 1 | 36 | 24 | 35.94 | 0.80 |
| EVWC6C2436WGP | 1067 | 1338 | 1 | 42 | 24 | 43.28 | 0.96 |
| EVWC6C2442WGP | 1833 | 2011 | 1 | 48 | 24 | 50.63 | 1.13 |
| EVWC6C3024WGP | 557 | 697 | 1 | 24 | 30 | 23.72 | 0.53 |
| EVWC6C3030WGP | 816 | 1025 | 1 | 30 | 30 | 32.94 | 0.73 |
| EVWC6C3036WGP | 1143 | 1431 | 1 | 36 | 30 | 42.16 | 0.94 |
| EVWC6C3042WGP | 1833 | 2011 | 1 | 42 | 30 | 51.38 | 1.14 |

EVWC6K • Keyboard Corner Worksurface For 60° Post

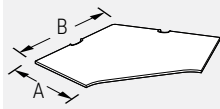

- "WG" at the end of the code indicates wood grain laminate on the diagonal.
- "WG" worksurface over 42" cannot be done on the diagonal.
- Support hardware must be ordered separately. See the listing in this section.
- Please choose from DWT - Designer White, SIL - Silver or BLK - Black for scoop covers.

NOTE:

A= 18, 24, 30
B= 24, 30, 36, 42, 48

| PRODUCT CODE | PRICE | | SIZE/ INCHES | | | WEIGHT VOL | |
|---------------|-------|------|--------------|----|----|------------|-----------------|
| | LP | HP | H | W | D | LBS | FT ³ |
| EVWC6K1824P | 333 | 367 | 1 | 24 | 18 | 17.76 | 0.39 |
| EVWC6K1830P | 535 | 586 | 1 | 30 | 18 | 23.26 | 0.52 |
| EVWC6K1836P | 800 | 879 | 1 | 36 | 18 | 28.75 | 0.64 |
| EVWC6K1842P | 975 | 1073 | 1 | 42 | 18 | 34.17 | 0.76 |
| EVWC6K1848P | 1330 | 1464 | 1 | 48 | 18 | 39.66 | 0.88 |
| EVWC6K2430P | 709 | 783 | 1 | 30 | 24 | 28.59 | 0.64 |
| EVWC6K2436P | 800 | 879 | 1 | 36 | 24 | 35.94 | 0.80 |
| EVWC6K2442P | 975 | 1073 | 1 | 42 | 24 | 43.28 | 0.96 |
| EVWC6K2448P | 1330 | 1464 | 1 | 48 | 24 | 50.63 | 1.13 |
| EVWC6K3030P | 709 | 783 | 1 | 30 | 30 | 32.94 | 0.73 |
| EVWC6K3036P | 796 | 1029 | 1 | 36 | 30 | 42.16 | 0.94 |
| EVWC6K3042P | 1089 | 1411 | 1 | 42 | 30 | 51.38 | 1.14 |
| EVWC6K3048P | 1323 | 1719 | 1 | 48 | 30 | 60.60 | 1.35 |
| EVWC6K1824WGP | 500 | 551 | 1 | 24 | 18 | 17.76 | 0.39 |
| EVWC6K1830WGP | 802 | 879 | 1 | 30 | 18 | 23.26 | 0.52 |
| EVWC6K1836WGP | 1200 | 1317 | 1 | 36 | 18 | 28.75 | 0.64 |
| EVWC6K1842WGP | 1464 | 1610 | 1 | 42 | 18 | 34.17 | 0.76 |
| EVWC6K2430WGP | 1062 | 1174 | 1 | 30 | 24 | 28.59 | 0.64 |
| EVWC6K2436WGP | 1200 | 1317 | 1 | 36 | 24 | 35.94 | 0.80 |
| EVWC6K2442WGP | 1464 | 1610 | 1 | 42 | 24 | 43.28 | 0.96 |
| EVWC6K3030WGP | 1062 | 1174 | 1 | 30 | 30 | 32.94 | 0.73 |
| EVWC6K3036WGP | 1195 | 1543 | 1 | 36 | 30 | 42.16 | 0.94 |
| EVWC6K3042WGP | 1634 | 2116 | 1 | 42 | 30 | 51.38 | 1.14 |

EVW6T • Corner Transaction Surface For 60° Post

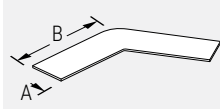

- Support hardware must be ordered separately. See the listing in this section.
- For use with laminate end and middle panels.

NOTE:

A= 15
B= 24, 30, 36, 42, 48

| PRODUCT CODE | PRICE | | SIZE/ INCHES | | | WEIGHT VOL | |
|--------------|-------|------|--------------|----|----|------------|-----------------|
| | LP | HP | H | W | D | LBS | FT ³ |
| EVW6T1518 | 340 | 435 | 1 | 18 | 15 | 14.53 | 0.32 |
| EVW6T1524 | 536 | 691 | 1 | 24 | 15 | 19.17 | 0.43 |
| EVW6T1530 | 694 | 898 | 1 | 30 | 15 | 23.78 | 0.53 |
| EVW6T1536 | 969 | 1257 | 1 | 36 | 15 | 28.39 | 0.63 |
| EVW6T1542 | 1055 | 1366 | 1 | 42 | 15 | 32.97 | 0.73 |
| EVW6T1548 | 1378 | 1785 | 1 | 48 | 15 | 34.17 | 0.76 |

EVWCC • Corner Curved Worksurface

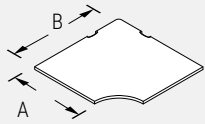

- "WG" at the end of the code indicates wood grain laminate on the diagonal.
- "WG" worksurface over 42" cannot be done on the diagonal.
- Please choose from DWT - Designer White, SIL - Silver or BLK - Black for scoop covers.

NOTE: EVWCC

| | |
|-------|-------|
| 18 | 36 |
| A | B |
| DEPTH | WIDTH |

| PRODUCT CODE | PRICE | | SIZE/ H | INCHES | | | WEIGHT VOL | |
|--------------|-------|-----|---------|--------|----|-------|-----------------|--|
| | LP | HP | | W | D | LBS | FT ³ | |
| EVWCC3618P | 397 | 495 | 1 | 36 | 18 | 24.00 | 1.27 | |
| EVWCC3624P | 439 | 548 | 1 | 36 | 24 | 30.00 | 1.47 | |
| EVWCC4224P | 591 | 736 | 1 | 42 | 24 | 47.00 | 1.70 | |
| EVWCC4230P | 607 | 759 | 1 | 42 | 30 | 53.00 | 1.98 | |
| EVWCC4824P | 688 | 857 | 1 | 48 | 24 | 53.00 | 2.67 | |
| EVWCC4830P | 688 | 857 | 1 | 48 | 30 | 55.00 | 2.67 | |
| EVWCC3618WGP | 441 | 567 | 1 | 36 | 18 | 19.80 | 0.75 | |
| EVWCC3624WGP | 485 | 625 | 1 | 36 | 24 | 30.00 | 1.47 | |
| EVWCC4224WGP | 657 | 845 | 1 | 42 | 24 | 47.00 | 1.70 | |
| EVWCC4230WGP | 712 | 916 | 1 | 42 | 30 | 53.00 | 1.96 | |

EVWCKK • Corner Worksurface with Curved Keyboard Support

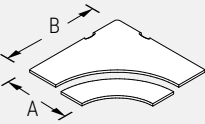

- Keyboard mechanism is included.
- Must be supported with two 24" Cantilevers and 2 Flat Brackets (ordered separately).
- "WG" worksurface over 42" cannot be done on the diagonal.
- "WG" at the end of the code indicates wood grain laminate on the diagonal.
- Keyboard Support is 11" deep, adjusts 6" above and 6" below surface with a positive/negative tilt (+15° to -15°).
- Please choose from DWT - Designer White, SIL - Silver or BLK - Black for scoop covers.

NOTE: EVWCC

| | |
|-------|-------|
| 24 | 42 |
| A | B |
| DEPTH | WIDTH |

| PRODUCT CODE | PRICE | | SIZE/ H | INCHES | | | WEIGHT VOL | |
|---------------|-------|------|---------|--------|----|-------|-----------------|--|
| | LP | HP | | W | D | LBS | FT ³ | |
| EVWCKK4224P | 1238 | 1374 | 1 | 42 | 24 | 38.00 | 0.95 | |
| EVWCKK4230P | 1315 | 1466 | 1 | 42 | 30 | 42.00 | 1.15 | |
| EVWCKK4824P | 1389 | 1560 | 1 | 48 | 24 | 48.00 | 1.55 | |
| EVWCKK4830P | 1424 | 1605 | 1 | 48 | 30 | 50.00 | 1.65 | |
| EVWCKK4224WGP | 1329 | 1502 | 1 | 42 | 24 | 38.00 | 0.95 | |
| EVWCKK4230WGP | 1422 | 1606 | 1 | 42 | 30 | 42.00 | 1.15 | |

EVWCK • Corner Keyboard Worksurface

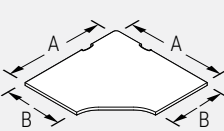

- "WG" at the end of the code indicates wood grain laminate on the diagonal.
- "WG" worksurface over 42" cannot be done on the diagonal.
- Please choose from DWT - Designer White, SIL - Silver or BLK - Black for scoop covers.

NOTE: EVWC

| | |
|-------|-------|
| 24 | 36 |
| A | B |
| DEPTH | WIDTH |

| PRODUCT CODE | PRICE | | SIZE/ H | INCHES | | | WEIGHT VOL | |
|--------------|-------|-----|---------|--------|----|-------|-----------------|--|
| | LP | HP | | W | D | LBS | FT ³ | |
| EVWCK3618P | 388 | 484 | 1 | 36 | 18 | 39.59 | 1.50 | |
| EVWCK3624P | 430 | 536 | 1 | 36 | 24 | 39.59 | 1.50 | |
| EVWCK4224P | 570 | 714 | 1 | 42 | 24 | 53.89 | 2.04 | |
| EVWCK4230P | 589 | 734 | 1 | 42 | 30 | 53.89 | 2.04 | |
| EVWCK4824P | 660 | 827 | 1 | 48 | 24 | 70.39 | 2.67 | |
| EVWCK4830P | 660 | 827 | 1 | 48 | 30 | 70.39 | 2.67 | |
| EVWCK3618WGP | 441 | 550 | 1 | 36 | 18 | 34.00 | 1.27 | |
| EVWCK3624WGP | 484 | 605 | 1 | 36 | 24 | 45.00 | 1.69 | |
| EVWCK4224WGP | 655 | 817 | 1 | 42 | 24 | 47.00 | 1.70 | |
| EVWCK4230WGP | 707 | 884 | 1 | 42 | 30 | 58.00 | 2.12 | |

EVWCF • Five Sided Worksurface

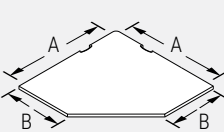

- "WG" at the end of the code indicates wood grain laminate on the diagonal.
- "WG" worksurface over 42" cannot be done on the diagonal.
- Please choose from DWT - Designer White, SIL - Silver or BLK - Black for scoop covers.

NOTE: EVWC

| | |
|-------|-------|
| 24 | 36 |
| A | B |
| DEPTH | WIDTH |

| PRODUCT CODE | PRICE | | SIZE/ H | INCHES | | | WEIGHT VOL | |
|--------------|-------|-----|---------|--------|----|-------|-----------------|--|
| | LP | HP | | W | D | LBS | FT ³ | |
| EVWCF3012P | 259 | 320 | 1 | 30 | 24 | 11.00 | 0.42 | |
| EVWCF3612P | 341 | 425 | 1 | 36 | 24 | 13.20 | 0.50 | |
| EVWCF3618P | 341 | 425 | 1 | 36 | 18 | 19.80 | 0.75 | |
| EVWCF3624P | 354 | 446 | 1 | 36 | 24 | 26.40 | 1.00 | |
| EVWCF4224P | 503 | 627 | 1 | 42 | 24 | 30.79 | 1.17 | |
| EVWCF4230P | 517 | 652 | 1 | 42 | 30 | 38.49 | 1.46 | |
| EVWCF4824P | 567 | 707 | 1 | 48 | 24 | 35.19 | 1.33 | |
| EVWCF4830P | 596 | 747 | 1 | 48 | 30 | 43.99 | 1.67 | |
| EVWCF3618WGP | 441 | 567 | 1 | 36 | 18 | 34.00 | 1.27 | |
| EVWCF3624WGP | 485 | 625 | 1 | 36 | 24 | 45.00 | 1.69 | |
| EVWCF4224WGP | 657 | 845 | 1 | 42 | 24 | 47.00 | 1.70 | |
| EVWCF4230WGP | 712 | 916 | 1 | 42 | 30 | 58.75 | 2.12 | |

EVWKKR • Angle Front Edge Worksurface

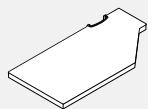

- To be used with EVWCF3012SCP & EVWCF3612SCP Corner Worksurface
- Creates efficient, compact keyboard corner workstation
- For use with flat screen monitors
- Please choose from DWT - Designer White, SIL - Silver or BLK - Black for scoop covers.

| PRODUCT CODE | PRICE | | SIZE/ INCHES | | | WEIGHT VOL | |
|--------------|-------|-----|--------------|----|----|------------|-----------------|
| | LP | HP | H | W | D | LBS | FT ³ |
| EVWKKR2448P | 251 | 313 | 1 | 48 | 24 | 35.00 | 1.11 |
| EVWKKL2448P | 251 | 313 | 1 | 48 | 24 | 35.00 | 1.11 |
| EVWKKR2442P | 219 | 275 | 1 | 42 | 24 | 31.00 | 0.98 |
| EVWKKL2442P | 219 | 275 | 1 | 42 | 24 | 31.00 | 0.98 |
| EVWKKR2436P | 190 | 236 | 1 | 36 | 24 | 26.00 | 0.85 |
| EVWKKL2436P | 190 | 236 | 1 | 36 | 24 | 26.00 | 0.85 |

EVWCC • Non-Symmetrical Corner Curved Worksurface

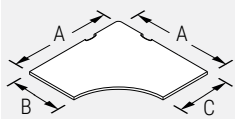

- Please specify starting at the first "A" on the left side and then continuing clockwise.
- "WG" worksurface over 42" cannot be done on the diagonal.
- Please choose from DWT - Designer White, SIL - Silver or BLK - Black for scoop covers.

NOTE: EVWCC

| | | | |
|-------|-------|-------|-------|
| 36 | 36 | 18 | 24 |
| A | A | B | C |
| WIDTH | WIDTH | DEPTH | DEPTH |

| PRODUCT CODE | PRICE | | SIZE/ INCHES | | | WEIGHT VOL | |
|------------------|-------|-----|--------------|------|------|------------|-----------------|
| | LP | HP | W(A) | D(B) | D(C) | LBS | FT ³ |
| EVWCC36361824P | 439 | 665 | 36 | 18 | 24 | 30.00 | 1.47 |
| EVWCC36362418P | 439 | 665 | 36 | 24 | 18 | 30.00 | 1.47 |
| EVWCC36362430P | 516 | 699 | 36 | 24 | 30 | 30.00 | 1.47 |
| EVWCC36363024P | 516 | 699 | 36 | 30 | 24 | 30.00 | 1.47 |
| EVWCC42421824P | 591 | 736 | 42 | 18 | 24 | 53.89 | 2.04 |
| EVWCC42422418P | 591 | 736 | 42 | 24 | 18 | 53.89 | 2.04 |
| EVWCC42422430P | 607 | 759 | 42 | 24 | 30 | 53.89 | 2.04 |
| EVWCC42423024P | 607 | 759 | 42 | 30 | 24 | 53.89 | 2.04 |
| EVWCC48482430P | 688 | 857 | 48 | 24 | 30 | 70.38 | 2.66 |
| EVWCC48483024P | 688 | 857 | 48 | 30 | 24 | 70.38 | 2.66 |
| EVWCC36361824WGP | 548 | 697 | 36 | 18 | 24 | 30.00 | 1.47 |
| EVWCC36362418WGP | 548 | 697 | 36 | 24 | 18 | 30.00 | 1.47 |
| EVWCC36362430WGP | 579 | 736 | 36 | 24 | 30 | 30.00 | 1.47 |
| EVWCC36363024WGP | 579 | 736 | 36 | 30 | 24 | 30.00 | 1.47 |
| EVWCC42421824WGP | 666 | 865 | 42 | 18 | 24 | 53.89 | 2.04 |
| EVWCC42422418WGP | 666 | 865 | 42 | 24 | 18 | 53.89 | 2.04 |
| EVWCC42422430WGP | 722 | 928 | 42 | 24 | 30 | 53.89 | 2.04 |
| EVWCC42423024WGP | 722 | 928 | 42 | 30 | 24 | 53.89 | 2.04 |

EVWCK • Non-Symmetrical Corner Keyboard Worksurface

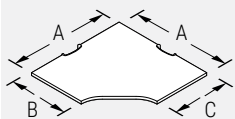

- Please specify starting at the first "A" on the left side and then continuing clockwise
- "WG" worksurface over 42" cannot be done on the diagonal.
- Please choose from DWT - Designer White, SIL - Silver or BLK - Black for scoop covers.

NOTE: EVWCC

| | | | |
|-------|-------|-------|-------|
| 36 | 36 | 18 | 24 |
| A | A | B | C |
| WIDTH | WIDTH | DEPTH | DEPTH |

| PRODUCT CODE | PRICE | | SIZE/INCHES | | | WEIGHT VOL | |
|------------------|-------|-----|-------------|------|------|------------|-----------------|
| | LP | HP | W(A) | D(B) | D(C) | LBS | FT ³ |
| EVWCK36361824P | 450 | 683 | 36 | 18 | 24 | 39.59 | 1.50 |
| EVWCK36362418P | 450 | 683 | 36 | 24 | 24 | 39.59 | 1.50 |
| EVWCK42421824P | 600 | 749 | 42 | 18 | 24 | 53.89 | 2.04 |
| EVWCK42422418P | 600 | 749 | 42 | 24 | 18 | 53.89 | 2.04 |
| EVWCK42422430P | 619 | 773 | 42 | 24 | 30 | 53.89 | 2.04 |
| EVWCK42423024P | 619 | 773 | 42 | 30 | 24 | 53.89 | 2.04 |
| EVWCK48482430P | 694 | 868 | 48 | 24 | 30 | 70.38 | 2.66 |
| EVWCK48483024P | 694 | 868 | 48 | 30 | 24 | 70.38 | 2.66 |
| EVWCK36361824WGP | 537 | 755 | 36 | 18 | 24 | 39.59 | 1.50 |
| EVWCK36362418WGP | 537 | 755 | 36 | 24 | 24 | 39.59 | 1.50 |
| EVWCK42421824WGP | 666 | 865 | 42 | 18 | 24 | 53.89 | 2.04 |
| EVWCK42422418WGP | 666 | 865 | 42 | 24 | 18 | 53.89 | 2.04 |
| EVWCK42422430WGP | 733 | 952 | 42 | 24 | 30 | 53.89 | 2.04 |
| EVWCK42423024WGP | 733 | 952 | 42 | 30 | 24 | 53.89 | 2.04 |

EVWCF • Non-Symmetrical Five Sided Worksurface

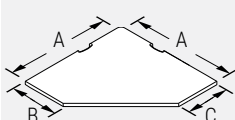

- Please specify starting at the first "A" on the left side and then continuing clockwise.
- "WG" worksurface over 42" cannot be done on the diagonal.
- Please choose from DWT - Designer White, SIL - Silver or BLK - Black for scoop covers.

NOTE: EVWCC

| | | | |
|-------|-------|-------|-------|
| 36 | 36 | 18 | 24 |
| A | A | B | C |
| WIDTH | WIDTH | DEPTH | DEPTH |

| PRODUCT CODE | PRICE | | SIZE/INCHES | | | WEIGHT VOL | |
|------------------|-------|-----|-------------|------|------|------------|-----------------|
| | LP | HP | W(A) | D(B) | D(C) | LBS | FT ³ |
| EVWCF36361824P | 418 | 638 | 36 | 18 | 24 | 30.00 | 1.47 |
| EVWCF36362418P | 418 | 638 | 36 | 24 | 18 | 30.00 | 1.47 |
| EVWCF36362430P | 439 | 665 | 36 | 24 | 30 | 30.00 | 1.47 |
| EVWCF36363024P | 439 | 665 | 36 | 30 | 24 | 30.00 | 1.47 |
| EVWCF42421824P | 503 | 692 | 42 | 18 | 24 | 53.89 | 2.04 |
| EVWCF42422418P | 503 | 692 | 42 | 24 | 18 | 53.89 | 2.04 |
| EVWCF42422430P | 577 | 754 | 42 | 24 | 30 | 53.89 | 2.04 |
| EVWCF42423024P | 577 | 754 | 42 | 30 | 24 | 53.89 | 2.04 |
| EVWCF48482430P | 629 | 837 | 48 | 24 | 30 | 70.38 | 2.66 |
| EVWCF48483024P | 629 | 837 | 48 | 30 | 24 | 70.38 | 2.66 |
| EVWCF36361824WGP | 557 | 723 | 36 | 18 | 24 | 30.00 | 1.47 |
| EVWCF36362418WGP | 557 | 723 | 36 | 24 | 18 | 30.00 | 1.47 |
| EVWCF36362430WGP | 592 | 780 | 36 | 24 | 30 | 30.00 | 1.47 |
| EVWCF36363024WGP | 592 | 780 | 36 | 30 | 24 | 30.00 | 1.47 |
| EVWCF42421824WGP | 602 | 779 | 42 | 18 | 24 | 53.89 | 2.04 |
| EVWCF42422418WGP | 602 | 779 | 42 | 24 | 18 | 53.89 | 2.04 |
| EVWCF42422430WGP | 629 | 817 | 42 | 24 | 30 | 53.89 | 2.04 |
| EVWCF42423024WGP | 629 | 817 | 42 | 30 | 24 | 53.89 | 2.04 |

EVWL • “L” Worksurface

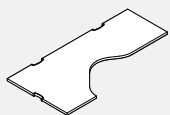

- There are three cable scoops on this worksurface.
- Wood grain laminate not available on the diagonal.
- Must be specified either left or right.
- Please choose from DWT - Designer White, SIL - Silver or BLK - Black for scoop covers.

| PRODUCT CODE | PRICE | | SIZE/INCHES | | | WEIGHT VOL | |
|--------------|-------|-----|-------------|----|----|------------|-----------------|
| | LP | HP | H | W | D | LBS | FT ³ |
| EVWLL2472P | 737 | 922 | 1 | 72 | 24 | 73.00 | 2.70 |
| EVWLR2472P | 737 | 922 | 1 | 72 | 24 | 73.00 | 2.70 |

EVWBTL • Transition Worksurface

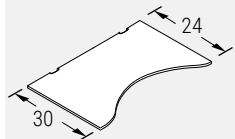

Left Hand Shown

- Support hardware must be ordered separately. See the listing in this section of the price list.
- Opposing side of 30" deep Transition Worksurface has depth of 24".
- Scoops located on back edge only.
- Must be specified as right or left handed.
- Please choose from DWT - Designer White, SIL - Silver or BLK - Black for scoop covers.

| PRODUCT CODE | PRICE | | SIZE/INCHES | | | WEIGHT VOL | |
|--------------|-------|-----|-------------|----|----|------------|-----------------|
| | LP | HP | W | D | D2 | LBS | FT ³ |
| EVWBTL3060P | 561 | 698 | 60 | 30 | 24 | 54.99 | 2.08 |
| EVWBTL3066P | 619 | 770 | 66 | 30 | 24 | 60.49 | 2.29 |
| EVWBTL3072P | 671 | 842 | 72 | 30 | 24 | 65.99 | 2.50 |
| EVWBTR3060P | 561 | 698 | 60 | 30 | 24 | 54.99 | 2.08 |
| EVWBTR3066P | 614 | 770 | 66 | 30 | 24 | 60.49 | 2.29 |
| EVWBTR3072P | 671 | 842 | 72 | 30 | 24 | 60.49 | 2.29 |

EVWBTL • Transition Worksurface

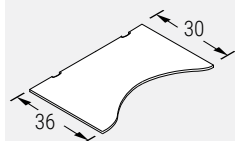

Left Hand Shown

- Support hardware must be ordered separately. See the listing in this section of the price list.
- Opposing side of 36" deep Transition Worksurface has depth of 30".
- Scoops located on back edge only.
- Must be specified as right or left handed.
- Please choose from DWT - Designer White, SIL - Silver or BLK - Black for scoop covers.

| PRODUCT CODE | PRICE | | SIZE/ INCHES | | | WEIGHT VOL | |
|--------------|-------|------|--------------|----|----|------------|-----------------|
| | LP | HP | W | D | D2 | LBS | FT ³ |
| EVWBTL3660P | 671 | 857 | 60 | 36 | 30 | 65.99 | 2.50 |
| EVWBTL3666P | 737 | 925 | 66 | 36 | 30 | 72.59 | 2.75 |
| EVWBTL3672P | 805 | 1007 | 72 | 36 | 30 | 79.19 | 3.00 |
| EVWBTR3660P | 671 | 842 | 60 | 36 | 30 | 65.99 | 2.50 |
| EVWBTR3666P | 737 | 925 | 66 | 36 | 30 | 72.59 | 2.75 |
| EVWBTR3672P | 805 | 1007 | 72 | 36 | 30 | 79.19 | 3.00 |

EVWCEL • Extended Curved Corner - Left

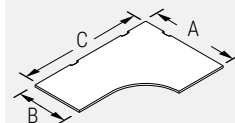

- For 48" wide ("C" dimension) worksurfaces, there are two cable scoops, all others have three.
- Wood grain laminate not available on the diagonal.
- Please choose from DWT - Designer White, SIL - Silver or BLK - Black for scoop covers.

NOTE: EVWCE

| | | |
|-------|-------|-------|
| 36 | 24 | 72 |
| A | B | C |
| DEPTH | DEPTH | WIDTH |

| PRODUCT CODE | PRICE | | SIZE/ INCHES | | | WEIGHT VOL | |
|---------------|-------|------|--------------|----|----|------------|-----------------|
| | LP | HP | A | B | C | LBS | FT ³ |
| EVWCEL362448P | 600 | 744 | 36 | 24 | 48 | 43.92 | 1.25 |
| EVWCEL362460P | 655 | 816 | 36 | 24 | 60 | 52.79 | 1.50 |
| EVWCEL362466P | 721 | 895 | 36 | 24 | 66 | 57.18 | 1.62 |
| EVWCEL362472P | 796 | 994 | 36 | 24 | 72 | 61.58 | 1.75 |
| EVWCEL362478P | 850 | 1062 | 36 | 24 | 78 | 65.98 | 1.87 |
| EVWCEL362484P | 917 | 1143 | 36 | 24 | 84 | 70.38 | 2.00 |
| EVWCEL422460P | 688 | 857 | 42 | 24 | 60 | 57.18 | 1.63 |
| EVWCEL422466P | 758 | 947 | 42 | 24 | 66 | 61.58 | 1.57 |
| EVWCEL422472P | 835 | 1045 | 42 | 24 | 72 | 65.98 | 1.87 |
| EVWCEL422478P | 893 | 1117 | 42 | 24 | 78 | 70.38 | 2.00 |
| EVWCEL422484P | 962 | 1201 | 42 | 24 | 84 | 74.78 | 2.00 |
| EVWCEL423060P | 775 | 970 | 42 | 30 | 60 | 63.78 | 1.82 |
| EVWCEL423066P | 850 | 1062 | 42 | 30 | 66 | 69.28 | 1.96 |
| EVWCEL423072P | 929 | 1160 | 42 | 30 | 72 | 74.78 | 2.12 |
| EVWCEL423078P | 996 | 1243 | 42 | 30 | 78 | 80.28 | 2.28 |
| EVWCEL423084P | 1062 | 1326 | 42 | 30 | 84 | 85.78 | 2.43 |
| EVWCEL482460P | 786 | 984 | 48 | 24 | 60 | 65.18 | 1.90 |
| EVWCEL482466P | 874 | 1092 | 48 | 24 | 66 | 69.78 | 3.66 |
| EVWCEL482472P | 956 | 1197 | 48 | 24 | 72 | 76.18 | 1.95 |
| EVWCEL482478P | 1021 | 1273 | 48 | 24 | 78 | 74.78 | 1.20 |
| EVWCEL482484P | 1083 | 1352 | 48 | 24 | 84 | 123.17 | 4.66 |
| EVWCEL483060P | 874 | 1092 | 48 | 30 | 60 | 68.18 | 1.93 |
| EVWCEL483066P | 956 | 1197 | 48 | 30 | 66 | 73.68 | 2.09 |
| EVWCEL483072P | 1021 | 1273 | 48 | 30 | 72 | 79.18 | 2.25 |
| EVWCEL483078P | 1083 | 1352 | 48 | 30 | 78 | 84.68 | 2.40 |
| EVWCEL483084P | 1158 | 1450 | 48 | 30 | 84 | 90.18 | 2.56 |

EVWCER • Extended Curved Corner - Right

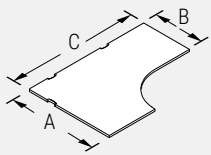

- For 48" wide ("C" dimension) worksurfaces, there are two cable scoops, all others have three finishes.
- Wood grain laminate not available on the diagonal.
- Please choose from DWT - Designer White, SIL - Silver or BLK - Black for scoop covers.

NOTE: EVWCE

| | | |
|-------|-------|-------|
| 36 | 24 | 72 |
| A | B | C |
| DEPTH | DEPTH | WIDTH |

| PRODUCT CODE | PRICE | | SIZE/ INCHES | | | WEIGHT VOL | |
|---------------|-------|------|--------------|----|----|------------|-----------------|
| | LP | HP | A | B | C | LBS | FT ³ |
| EVWCER362448P | 600 | 744 | 36 | 24 | 48 | 43.92 | 1.25 |
| EVWCER362460P | 655 | 816 | 36 | 24 | 60 | 52.79 | 1.50 |
| EVWCER362466P | 721 | 895 | 36 | 24 | 66 | 57.18 | 1.62 |
| EVWCER362472P | 796 | 994 | 36 | 24 | 72 | 61.58 | 1.75 |
| EVWCER362478P | 850 | 1062 | 36 | 24 | 78 | 65.98 | 1.87 |
| EVWCER362484P | 917 | 1143 | 36 | 24 | 84 | 70.38 | 2.00 |
| EVWCER422460P | 688 | 857 | 42 | 24 | 60 | 57.18 | 1.63 |
| EVWCER422466P | 758 | 947 | 42 | 24 | 66 | 61.58 | 1.57 |
| EVWCER422472P | 835 | 1045 | 42 | 24 | 72 | 65.98 | 1.87 |
| EVWCER422478P | 893 | 1117 | 42 | 24 | 78 | 70.38 | 2.00 |
| EVWCER422484P | 962 | 1201 | 42 | 24 | 84 | 74.78 | 2.00 |
| EVWCER423060P | 775 | 970 | 42 | 30 | 60 | 63.78 | 1.82 |
| EVWCER423066P | 850 | 1062 | 42 | 30 | 66 | 69.28 | 1.96 |
| EVWCER423072P | 929 | 1160 | 42 | 30 | 72 | 74.78 | 2.12 |
| EVWCER423078P | 996 | 1243 | 42 | 30 | 78 | 80.28 | 2.28 |
| EVWCER423084P | 1062 | 1326 | 42 | 30 | 84 | 85.78 | 2.43 |
| EVWCER482460P | 786 | 984 | 48 | 24 | 60 | 65.18 | 1.90 |
| EVWCER482466P | 874 | 1092 | 48 | 24 | 66 | 96.78 | 3.66 |
| EVWCER482472P | 956 | 1197 | 48 | 24 | 72 | 76.18 | 1.95 |
| EVWCER482478P | 1021 | 1273 | 48 | 24 | 78 | 74.78 | 1.20 |
| EVWCER482484P | 1083 | 1352 | 48 | 24 | 84 | 123.17 | 4.66 |
| EVWCER483060P | 874 | 1092 | 48 | 30 | 60 | 68.18 | 1.93 |
| EVWCER483066P | 956 | 1197 | 48 | 30 | 66 | 73.68 | 2.09 |
| EVWCER483072P | 1021 | 1273 | 48 | 30 | 72 | 79.18 | 2.25 |
| EVWCER483078P | 1083 | 1352 | 48 | 30 | 78 | 84.68 | 2.40 |
| EVWCER483084P | 1158 | 1450 | 48 | 30 | 84 | 90.18 | 2.56 |

EVWH • Hatchet Worksurface

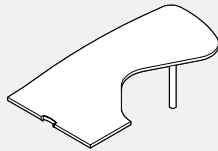

- Cable scoop is in the middle of the 36" wide edge.
- Wood grain laminate not available on the diagonal.
- Must be specified either left or right.
- Includes monoleg.
- Please choose from DWT - Designer White, SIL - Silver or BLK - Black for scoop covers.

Right Hand Shown

| PRODUCT CODE | PRICE | | SIZE/ INCHES | | | WEIGHT VOL | |
|--------------|-------|------|--------------|----|----|------------|-----------------|
| | LP | HP | H | W | D | LBS | FT ³ |
| EVWHL3672P | 1079 | 1299 | 1 | 72 | 30 | 73.00 | 2.70 |
| EVWHR3672P | 1079 | 1299 | 1 | 72 | 30 | 73.00 | 2.70 |

EVWSH • Hatchet Worksurface - Straight Front

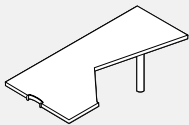

- Cable scoop is in the middle of the 36" wide edge.
- Wood grain laminate not available on the diagonal.
- Support hardware must be ordered separately.
- Must be specified either left or right.
- Includes monoleg.
- Please choose from DWT - Designer White, SIL - Silver or BLK - Black for scoop covers.

Right Hand Shown

| PRODUCT CODE | PRICE | | SIZE/ INCHES | | | WEIGHT VOL | |
|--------------|-------|------|--------------|----|----|------------|-----------------|
| | LP | HP | H | W | D | LBS | FT ³ |
| EVWSHL3672P | 1027 | 1236 | 1 | 72 | 30 | 73.00 | 2.70 |
| EVWSHR3672P | 1027 | 1236 | 1 | 72 | 30 | 73.00 | 2.70 |

EVWD • "D" Worksurface

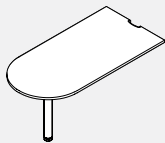

- Cable scoop is at the centre of the end.
- Includes monoleg.
- Please choose from DWT - Designer White, SIL - Silver or BLK - Black for scoop covers.

| PRODUCT CODE | PRICE | | SIZE/ INCHES | | | WEIGHT VOL | |
|--------------|-------|-----|--------------|----|----|------------|-----------------|
| | LP | HP | H | W | D | LBS | FT ³ |
| EVWD2442P | 569 | 659 | 1 | 42 | 24 | 28.00 | 0.98 |
| EVWD2448P | 593 | 693 | 1 | 48 | 24 | 32.00 | 1.11 |
| EVWD2460P | 623 | 725 | 1 | 60 | 24 | 40.00 | 1.36 |
| EVWD2472P | 661 | 779 | 1 | 72 | 24 | 48.00 | 1.61 |
| EVWD3048P | 596 | 695 | 1 | 48 | 30 | 39.00 | 1.37 |
| EVWD3060P | 665 | 780 | 1 | 60 | 30 | 49.00 | 1.69 |
| EVWD3072P | 731 | 864 | 1 | 72 | 30 | 59.00 | 2.01 |

EVWPT • “P” Top Worksurface

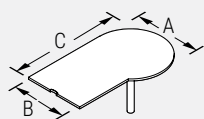

Left Hand Shown

- Cable scoop is at the center of the panel with edge.
- Must be specified either left or right.
- Includes monoleg.
- Please choose from DWT - Designer White, SIL - Silver or BLK - Black for scoop covers.

NOTE: EVWCE

| | | |
|-------|-------|-------|
| 24 | 60 | 30 |
| A | B | C |
| DEPTH | DEPTH | WIDTH |

| PRODUCT CODE | PRICE | | SIZE/ INCHES | | | WEIGHT VOL | |
|---------------|-------|------|--------------|----|----|------------|-----------------|
| | LP | HP | H | W | D | LBS | FT ³ |
| EVWPTL245430P | 773 | 938 | 1 | 54 | 24 | 39.50 | 1.50 |
| EVWPTL246030P | 829 | 992 | 1 | 60 | 24 | 54.99 | 2.08 |
| EVWPTL246630P | 846 | 1074 | 1 | 66 | 24 | 60.48 | 2.29 |
| EVWPTL247230P | 894 | 1121 | 1 | 72 | 24 | 65.98 | 2.50 |
| EVWPTL306036P | 916 | 1140 | 1 | 60 | 30 | 65.98 | 2.50 |
| EVWPTL306636P | 992 | 1182 | 1 | 66 | 30 | 72.58 | 2.75 |
| EVWPTL307236P | 1034 | 1236 | 1 | 72 | 30 | 79.00 | 2.41 |
| EVWPTR245430P | 773 | 938 | 1 | 54 | 24 | 39.50 | 1.50 |
| EVWPTR246030P | 829 | 992 | 1 | 60 | 24 | 54.99 | 2.08 |
| EVWPTR246630P | 846 | 1074 | 1 | 66 | 24 | 60.48 | 2.29 |
| EVWPTR247230P | 894 | 1121 | 1 | 72 | 24 | 65.98 | 2.50 |
| EVWPTR306036P | 916 | 1140 | 1 | 60 | 30 | 65.98 | 2.50 |
| EVWPTR306636P | 992 | 1182 | 1 | 66 | 30 | 72.58 | 2.75 |
| EVWPTR307236P | 1034 | 1236 | 1 | 72 | 30 | 79.00 | 2.41 |

EVWW • Wedge Worksurface

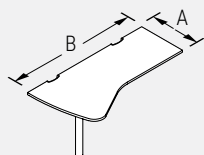

Left Hand Shown

- Two cable scoops on the back side of worksurface.
- Must be specified either left or right.
- Includes monoleg.
- Conference end is 10" wider than "A".
- Please choose from DWT - Designer White, SIL - Silver or BLK - Black for scoop covers.

NOTE: EVWC

| | |
|-------|-------|
| 18 | 48 |
| A | B |
| DEPTH | WIDTH |

| PRODUCT CODE | PRICE | | SIZE/ INCHES | | | WEIGHT VOL | |
|--------------|-------|------|--------------|----|----|------------|-----------------|
| | LP | HP | H | W | D | LBS | FT ³ |
| EVWWL2460P | 653 | 761 | 1 | 60 | 24 | 51.99 | 1.81 |
| EVWWL2466P | 691 | 812 | 1 | 66 | 24 | 56.39 | 1.98 |
| EVWWL2472P | 727 | 863 | 1 | 72 | 24 | 60.79 | 2.15 |
| EVWWL2478P | 817 | 1022 | 1 | 78 | 24 | 65.18 | 2.31 |
| EVWWL2484P | 829 | 1035 | 1 | 84 | 24 | 69.58 | 2.48 |
| EVWWL3060P | 752 | 886 | 1 | 60 | 30 | 62.99 | 2.23 |
| EVWWL3066P | 800 | 951 | 1 | 66 | 30 | 68.44 | 2.44 |
| EVWWL3072P | 851 | 1012 | 1 | 72 | 30 | 73.98 | 2.65 |
| EVWWR2460P | 653 | 761 | 1 | 60 | 24 | 51.99 | 1.81 |
| EVWWR2466P | 691 | 812 | 1 | 66 | 24 | 56.39 | 1.98 |
| EVWWR2472P | 727 | 863 | 1 | 72 | 24 | 60.79 | 2.15 |
| EVWWR2478P | 817 | 1022 | 1 | 78 | 24 | 65.18 | 2.31 |
| EVWWR2484P | 829 | 1035 | 1 | 84 | 24 | 69.58 | 2.48 |
| EVWWR3060P | 752 | 886 | 1 | 60 | 30 | 62.99 | 2.23 |
| EVWWR3066P | 800 | 951 | 1 | 66 | 30 | 68.44 | 2.44 |
| EVWWR3072P | 851 | 1012 | 1 | 72 | 30 | 73.98 | 2.65 |

EVWPL • Piano Top Worksurface Left

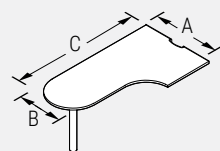

Left Hand Shown

- Cable scoop is at the center of the panel with edge.
- Must be specified either left or right.
- Includes monoleg.
- Works with EVWMP modesty.
- Please choose from DWT - Designer White, SIL - Silver or BLK - Black for scoop covers.

NOTE: EVWP

| | | |
|-------|-------|-------|
| 36 | 18 | 48 |
| A | B | C |
| DEPTH | DEPTH | WIDTH |

| PRODUCT CODE | PRICE | | SIZE/ INCHES | | | WEIGHT VOL | |
|--------------|-------|------|--------------|----|----|------------|-----------------|
| | LP | HP | H | W | D | LBS | FT ³ |
| EVWPL361848P | 727 | 863 | 1 | 48 | 36 | 52.79 | 2.00 |
| EVWPL361854P | 773 | 916 | 1 | 54 | 36 | 59.39 | 2.25 |
| EVWPL361860P | 813 | 969 | 1 | 60 | 36 | 65.99 | 2.50 |
| EVWPL361866P | 857 | 1022 | 1 | 66 | 36 | 72.59 | 2.75 |
| EVWPL361872P | 896 | 1072 | 1 | 72 | 36 | 79.18 | 3.00 |
| EVWPL362448P | 736 | 868 | 1 | 48 | 24 | 52.79 | 2.75 |
| EVWPL362454P | 778 | 920 | 1 | 54 | 24 | 59.39 | 2.25 |
| EVWPL362460P | 823 | 973 | 1 | 60 | 24 | 65.58 | 1.68 |
| EVWPL362466P | 863 | 1026 | 1 | 66 | 24 | 73.00 | 2.23 |
| EVWPL362472P | 903 | 1078 | 1 | 72 | 24 | 79.18 | 3.00 |
| EVWPL422454P | 833 | 992 | 1 | 54 | 42 | 69.29 | 2.63 |
| EVWPL422460P | 883 | 1052 | 1 | 60 | 42 | 75.58 | 1.88 |
| EVWPL422466P | 930 | 1112 | 1 | 66 | 42 | 85.68 | 3.21 |
| EVWPL422472P | 975 | 1170 | 1 | 72 | 42 | 92.38 | 3.51 |
| EVWPL423060P | 897 | 1073 | 1 | 60 | 42 | 76.99 | 2.92 |
| EVWPL423066P | 952 | 1139 | 1 | 66 | 42 | 84.68 | 3.21 |
| EVWPL423072P | 1000 | 1199 | 1 | 72 | 42 | 92.38 | 3.50 |
| EVWPL482460P | 1001 | 1201 | 1 | 60 | 48 | 87.98 | 3.33 |
| EVWPL482466P | 1062 | 1275 | 1 | 66 | 48 | 87.98 | 3.33 |
| EVWPL482472P | 1121 | 1351 | 1 | 72 | 48 | 105.58 | 4.00 |
| EVWPL483066P | 1065 | 1284 | 1 | 66 | 48 | 96.78 | 3.66 |
| EVWPL483072P | 1125 | 1355 | 1 | 72 | 48 | 105.58 | 4.00 |

EVWPR • Piano Top Worksurface Right

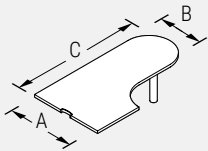

Right Hand Shown

- Cable scoop is at the center of the panel with edge.
- Must be specified either left or right.
- Includes monoleg.
- Works with EVWMP modesty.
- Please choose from DWT - Designer White, SIL - Silver or BLK - Black for scoop covers.

NOTE: EVWP

| | | |
|-------|-------|-------|
| 36 | 18 | 48 |
| A | B | C |
| DEPTH | DEPTH | WIDTH |

| PRODUCT CODE | PRICE | | SIZE/ INCHES | | | WEIGHT LBS | VOL FT ³ |
|--------------|-------|------|--------------|----|----|------------|---------------------|
| | LP | HP | H | W | D | | |
| EVWPR361848P | 727 | 863 | 1 | 48 | 36 | 52.79 | 2.00 |
| EVWPR361854P | 773 | 916 | 1 | 54 | 36 | 59.39 | 2.25 |
| EVWPR361860P | 813 | 969 | 1 | 60 | 36 | 65.99 | 2.50 |
| EVWPR361866P | 857 | 1022 | 1 | 66 | 36 | 72.59 | 2.75 |
| EVWPR361872P | 896 | 1072 | 1 | 72 | 36 | 79.18 | 3.00 |
| EVWPR362448P | 736 | 868 | 1 | 48 | 24 | 52.79 | 2.75 |
| EVWPR362454P | 778 | 920 | 1 | 54 | 24 | 59.39 | 2.25 |
| EVWPR362460P | 823 | 973 | 1 | 60 | 24 | 65.58 | 1.68 |
| EVWPR362466P | 863 | 1026 | 1 | 66 | 24 | 73.00 | 2.23 |
| EVWPR362472P | 903 | 1078 | 1 | 72 | 24 | 79.18 | 3.00 |
| EVWPR422454P | 833 | 992 | 1 | 54 | 42 | 69.29 | 2.63 |
| EVWPR422460P | 883 | 1052 | 1 | 60 | 42 | 75.58 | 1.88 |
| EVWPR422466P | 930 | 1112 | 1 | 66 | 42 | 85.68 | 3.21 |
| EVWPR422472P | 975 | 1170 | 1 | 72 | 42 | 92.38 | 2.27 |
| EVWPR423060P | 897 | 1073 | 1 | 60 | 42 | 76.99 | 2.92 |
| EVWPR423066P | 952 | 1139 | 1 | 66 | 42 | 84.68 | 3.21 |
| EVWPR423072P | 1000 | 1199 | 1 | 72 | 42 | 92.38 | 3.50 |
| EVWPR482460P | 1001 | 1201 | 1 | 60 | 48 | 87.98 | 2.25 |
| EVWPR482466P | 1062 | 1275 | 1 | 66 | 48 | 78.00 | 3.66 |
| EVWPR482472P | 1121 | 1351 | 1 | 72 | 48 | 105.58 | 4.00 |
| EVWPR483066P | 1065 | 1284 | 1 | 66 | 48 | 96.78 | 3.66 |
| EVWPR483072P | 1125 | 1355 | 1 | 72 | 48 | 105.58 | 4.00 |

EVWQR/L • Quarter Round Panel Worksurface

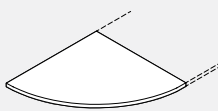

Left Hand Shown

- The worksurface edge running along the panel face is a slightly different length than that of the worksurface end, causing the surface to be handed.
- The user edge abutting the adjacent worksurface runs straight for 3" before starting to curve.

| PRODUCT CODE | PRICE | | SIZE/ INCHES | | | WEIGHT LBS | VOL FT ³ |
|--------------|-------|-----|--------------|----|----|------------|---------------------|
| | LP | HP | H | W | D | | |
| EVWQRL1818 | 139 | 174 | 1 | 18 | 18 | 9 | 0.30 |
| EVWQRL2424 | 200 | 247 | 1 | 24 | 24 | 16 | 0.52 |
| EVWQRL3030 | 259 | 320 | 1 | 30 | 30 | 25 | 0.81 |
| EVWQRR1818 | 139 | 174 | 1 | 18 | 18 | 9 | 0.30 |
| EVWQRR2424 | 200 | 247 | 1 | 24 | 24 | 16 | 0.52 |
| EVWQRR3030 | 259 | 320 | 1 | 30 | 30 | 25 | 0.81 |

EVWQRC • Quarter Round Panel Corner Worksurface



- Wraps around a 90° corner post.
- Putting the adjacent worksurface runs straight for 3" before starting to curve.

| PRODUCT CODE | PRICE | | SIZE/ INCHES | | | WEIGHT LBS | VOL FT ³ |
|--------------|-------|-----|--------------|----|----|------------|---------------------|
| | LP | HP | H | W | D | | |
| EVWQRC1818 | 162 | 202 | 1 | 21 | 21 | 12.00 | 0.38 |
| EVWQRC2424 | 235 | 293 | 1 | 27 | 27 | 17.00 | 0.58 |
| EVWQRC3030 | 289 | 364 | 1 | 33 | 33 | 25.50 | 0.86 |

EVWMP • Worksurface Modesty Panel

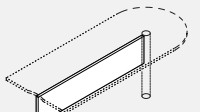

- Modesty panel fastens to the worksurface and Monoleg to provide additional privacy and support.
- Made of cold rolled steel and is epoxy powder coated.
- For "D", Hatchet and Piano Top Worksurfaces only (ordered separately).

| PRODUCT CODE | PRICE | | SIZE/ INCHES | | | WEIGHT LBS | VOL FT ³ |
|--------------|-------|----|--------------|----|---|------------|---------------------|
| | LP | HP | H | W | D | | |
| EVWMP1242 | 134 | | 13 | 26 | 1 | 4.00 | 0.22 |
| EVWMP1248 | 151 | | 13 | 32 | 1 | 5.00 | 0.25 |
| EVWMP1260 | 174 | | 13 | 44 | 1 | 6.00 | 0.30 |
| EVWMP1272 | 225 | | 13 | 56 | 1 | 8.00 | 2.00 |

EVWR • Radius Worksurface

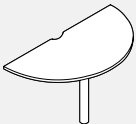

- Rounded worksurface for conferencing provides a radius corner from a worksurface to worksurface.
- 18" and 24" come with one monoleg and 30" comes with two monolegs.
- Radius cut out on the straight edge allows space for trims.
- Please choose from DWT - Designer White, SIL - Silver or BLK - Black for scoop covers.

| PRODUCT CODE | PRICE | | SIZE/ INCHES | | | WEIGHT LBS | VOL FT ³ |
|--------------|-------|------|--------------|----|------|------------|---------------------|
| | LP | HP | H | W | D | | |
| EVWR18P | 503 | 578 | 29 | 39 | 19.5 | 24.00 | 0.74 |
| EVWR24P | 577 | 668 | 29 | 51 | 25.5 | 34.00 | 1.16 |
| EVWR30P | 969 | 1108 | 29 | 63 | 31.5 | 51.00 | 1.76 |

EVTTE • Teardrop Extension Table



- Stand-alone mobile table.

| PRODUCT CODE | PRICE | | SIZE/ INCHES | | | WEIGHT LBS | VOL FT ³ |
|--------------|-------|-----|--------------|----|----|------------|---------------------|
| | LP | HP | H | W | D | | |
| EVTTE29247 | 494 | 579 | 27 | 29 | 29 | 30.00 | 15.00 |
| EVTTE34307 | 542 | 636 | 27 | 34 | 34 | 35.00 | 18.00 |
| EVTTE29249 | 581 | 666 | 29 | 29 | 29 | 30.00 | 19.00 |
| EVTTE34309 | 629 | 724 | 29 | 34 | 34 | 35.00 | 19.00 |

EVWT • Straight Transaction Surface

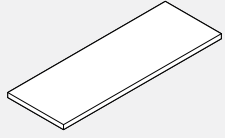

- Support hardware must be ordered separately.
- All tops are thermally fused 1" thick with pilot holes to enable proper alignment with worksurface supports. Wood screws must be used.
- Evolve worksurfaces feature a 3mm edge.

| PRODUCT CODE | PRICE | | SIZE/ INCHES | | | WEIGHT VOL | |
|--------------|-------|-----|--------------|----|----|------------|-----------------|
| | LP | HP | H | W | D | LBS | FT ³ |
| EVWT1512 | 60 | 77 | 1 | 12 | 15 | 6.00 | 0.22 |
| EVWT1518 | 74 | 102 | 1 | 18 | 15 | 8.00 | 0.30 |
| EVWT1524 | 93 | 124 | 1 | 24 | 15 | 10.00 | 0.38 |
| EVWT1530 | 112 | 146 | 1 | 30 | 15 | 13.00 | 0.46 |
| EVWT1536 | 128 | 170 | 1 | 36 | 15 | 15.00 | 0.54 |
| EVWT1542 | 146 | 194 | 1 | 42 | 15 | 18.00 | 0.62 |
| EVWT1548 | 166 | 217 | 1 | 48 | 15 | 20.00 | 0.70 |
| EVWT1554 | 178 | 239 | 1 | 54 | 15 | 23.00 | 0.78 |
| EVWT1560 | 199 | 263 | 1 | 60 | 15 | 25.00 | 0.86 |
| EVWT1566 | 213 | 284 | 1 | 66 | 15 | 29.00 | 0.94 |
| EVWT1572 | 234 | 307 | 1 | 72 | 15 | 30.00 | 1.02 |
| EVWT1578 | 249 | 333 | 1 | 78 | 15 | 32.00 | 1.10 |
| EVWT1584 | 267 | 353 | 1 | 84 | 15 | 35.00 | 1.18 |

EVWTV • Straight Transaction Surface with Cut-out

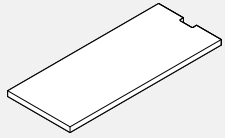

- Used where a transaction surface butts up against a taller panel

| PRODUCT CODE | PRICE | | SIZE/ INCHES | | | WEIGHT VOL | |
|--------------|-------|-----|--------------|----|----|------------|-----------------|
| | LP | HP | H | W | D | LBS | FT ³ |
| EVWTV1524 | 104 | 134 | 1 | 24 | 15 | 10.00 | 0.38 |
| EVWTV1530 | 126 | 160 | 1 | 30 | 15 | 13.00 | 0.46 |
| EVWTV1536 | 139 | 180 | 1 | 36 | 15 | 15.00 | 0.54 |
| EVWTV1542 | 160 | 204 | 1 | 42 | 15 | 18.00 | 0.62 |
| EVWTV1548 | 176 | 231 | 1 | 48 | 15 | 20.57 | 0.70 |
| EVWTV1554 | 192 | 251 | 1 | 54 | 15 | 22.57 | 0.75 |
| EVWTV1560 | 210 | 275 | 1 | 60 | 15 | 26.00 | 0.92 |
| EVWTV1566 | 229 | 298 | 1 | 66 | 15 | 28.00 | 1.00 |
| EVWTV1572 | 245 | 319 | 1 | 72 | 15 | 30.00 | 1.08 |

EVWTCL • "L" Corner Transaction Surface

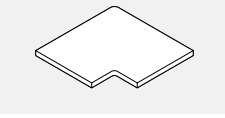

- Used where two panels meet at a 90° angle.
- For Wood Grain Laminate, use code ending with "WG".

| PRODUCT CODE | PRICE | | SIZE/ INCHES | | | WEIGHT VOL | |
|--------------|-------|-----|--------------|----|----|------------|-----------------|
| | LP | HP | H | W | D | LBS | FT ³ |
| EVWTCL90 | 171 | 212 | 1 | 21 | 15 | 12.00 | 0.75 |
| EVWTCL90WG | 208 | 261 | 1 | 21 | 15 | 12.00 | 0.75 |

EVWTCT • "T" Corner Transaction Surface

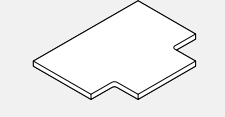

- Used where three panels meet.
- For Wood Grain Laminate, use code ending with "WG".

| PRODUCT CODE | PRICE | | SIZE/ INCHES | | | WEIGHT VOL | |
|--------------|-------|-----|--------------|----|----|------------|-----------------|
| | LP | HP | H | W | D | LBS | FT ³ |
| EVWTCT90 | 171 | 212 | 1 | 27 | 15 | 16.00 | 1.00 |

EVWTE • End Transaction Surface

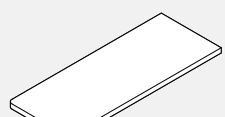

- Surface has rounded corners at one end.

| PRODUCT CODE | PRICE | | SIZE/ INCHES | | | WEIGHT VOL | |
|--------------|-------|-----|--------------|----|----|------------|-----------------|
| | LP | HP | H | W | D | LBS | FT ³ |
| EVWTE1512 | 60 | 77 | 1 | 14 | 15 | 12.00 | 0.54 |
| EVWTE1518 | 74 | 102 | 1 | 20 | 15 | 14.00 | 0.58 |
| EVWTE1524 | 104 | 134 | 1 | 26 | 15 | 16.00 | 0.61 |
| EVWTE1530 | 126 | 160 | 1 | 32 | 15 | 20.00 | 0.69 |
| EVWTE1536 | 139 | 180 | 1 | 38 | 15 | 20.00 | 0.70 |
| EVWTE1542 | 160 | 204 | 1 | 44 | 15 | 23.00 | 0.74 |
| EVWTE1548 | 176 | 231 | 1 | 50 | 15 | 26.00 | 0.77 |
| EVWTE1554 | 192 | 251 | 1 | 56 | 15 | 28.00 | 0.85 |
| EVWTE1560 | 210 | 275 | 1 | 62 | 15 | 31.00 | 0.94 |
| EVWTE1566 | 229 | 298 | 1 | 68 | 15 | 34.00 | 1.02 |
| EVWTE1572 | 245 | 319 | 1 | 74 | 15 | 36.00 | 1.10 |

EVWTEV • End Transaction Surface with Cut-out

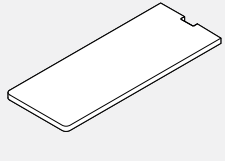

- Used at the end of a panel run where the surface butts up against a taller panel.
- Surface has rounded corners at one end.

| PRODUCT CODE | PRICE | | SIZE/ INCHES | | | WEIGHT VOL | |
|--------------|-------|-----|--------------|----|----|------------|-----------------|
| | LP | HP | H | W | D | LBS | FT ³ |
| EVWTEV1524 | 116 | 146 | 1 | 26 | 15 | 16.00 | 0.61 |
| EVWTEV1530 | 136 | 171 | 1 | 32 | 15 | 18.00 | 0.65 |
| EVWTEV1536 | 151 | 195 | 1 | 38 | 15 | 20.00 | 0.69 |
| EVWTEV1542 | 171 | 217 | 1 | 44 | 15 | 23.00 | 0.74 |
| EVWTEV1548 | 190 | 240 | 1 | 50 | 15 | 32.00 | 1.22 |
| EVWTEV1554 | 202 | 264 | 1 | 56 | 15 | 36.00 | 1.32 |
| EVWTEV1560 | 221 | 286 | 1 | 62 | 15 | 36.00 | 1.30 |
| EVWTEV1566 | 239 | 309 | 1 | 68 | 15 | 30.24 | 1.14 |
| EVWTEV1572 | 259 | 333 | 1 | 74 | 15 | 40.00 | 1.38 |

EVW9TL • Corner Transaction Top for 90 degree Left

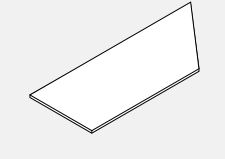

| PRODUCT CODE | PRICE | | SIZE/ INCHES | | | WEIGHT VOL | |
|--------------|-------|------|--------------|----|----|------------|-----------------|
| | LP | HP | H | W | D | LBS | FT ³ |
| EVW9TL1524 | 394 | 581 | 1 | 33 | 15 | 15.00 | 0.54 |
| EVW9TL1530 | 475 | 705 | 1 | 39 | 15 | 18.00 | 0.62 |
| EVW9TL1536 | 551 | 816 | 1 | 45 | 15 | 20.00 | 0.70 |
| EVW9TL1542 | 631 | 930 | 1 | 51 | 15 | 23.00 | 0.78 |
| EVW9TL1548 | 712 | 1050 | 1 | 57 | 15 | 25.00 | 0.86 |

EVW9TR • Corner Transaction Top for 90 degree Right

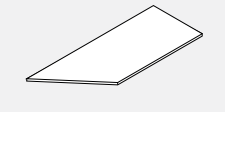

| PRODUCT CODE | PRICE | | SIZE/ INCHES | | | WEIGHT VOL | |
|--------------|-------|------|--------------|----|----|------------|-----------------|
| | LP | HP | H | W | D | LBS | FT ³ |
| EVW9TR1524 | 394 | 581 | 1 | 33 | 15 | 15.00 | 0.54 |
| EVW9TR1530 | 475 | 705 | 1 | 39 | 15 | 18.00 | 0.62 |
| EVW9TR1536 | 551 | 816 | 1 | 45 | 15 | 20.00 | 0.70 |
| EVW9TR1542 | 631 | 930 | 1 | 51 | 15 | 23.00 | 0.78 |
| EVW9TR1548 | 712 | 1050 | 1 | 57 | 15 | 25.00 | 0.86 |

EVWTD • End “D” Transaction Surface

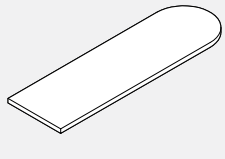

- Used at the end of a panel run where surface can overhang.

| PRODUCT CODE | PRICE | | SIZE/ INCHES | | | WEIGHT VOL | |
|--------------|-------|-----|--------------|----|----|------------|-----------------|
| | LP | HP | H | W | D | LBS | FT ³ |
| EVWTD1530 | 145 | 190 | 1 | 37 | 15 | 18.00 | 0.65 |
| EVWTD1536 | 153 | 204 | 1 | 43 | 15 | 20.00 | 0.69 |
| EVWTD1542 | 171 | 229 | 1 | 49 | 15 | 23.00 | 0.74 |
| EVWTD1548 | 192 | 251 | 1 | 55 | 15 | 26.00 | 0.77 |
| EVWTD1554 | 207 | 274 | 1 | 61 | 15 | 28.00 | 0.85 |
| EVWTD1560 | 229 | 303 | 1 | 67 | 15 | 31.00 | 0.94 |
| EVWTD1566 | 245 | 323 | 1 | 73 | 15 | 34.00 | 1.02 |
| EVWTD1572 | 265 | 351 | 1 | 79 | 15 | 36.00 | 1.10 |

EVWTDV • End “D” Transaction Surface with Cut-out

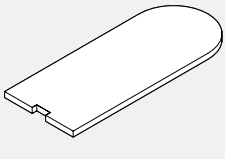

- Used at the end of a panel run where the surface butts up against a taller panel on one end and can overhang at the other.

| PRODUCT CODE | PRICE | | SIZE/ INCHES | | | WEIGHT VOL | |
|--------------|-------|-----|--------------|----|----|------------|-----------------|
| | LP | HP | H | W | D | LBS | FT ³ |
| EVWTDV1530 | 149 | 201 | 1 | 37 | 15 | 18.00 | 0.65 |
| EVWTDV1536 | 162 | 217 | 1 | 43 | 15 | 20.00 | 0.69 |
| EVWTDV1542 | 179 | 239 | 1 | 49 | 15 | 23.00 | 0.74 |
| EVWTDV1548 | 199 | 264 | 1 | 55 | 15 | 26.00 | 0.77 |
| EVWTDV1554 | 212 | 284 | 1 | 61 | 15 | 28.00 | 0.85 |
| EVWTDV1560 | 235 | 312 | 1 | 67 | 15 | 31.00 | 0.94 |

EVWTD • Double “D” Transaction Surface

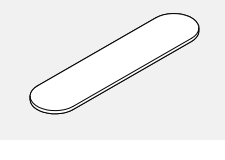

- Support hardware must be ordered separately.
- All tops are thermally fused 1” thick with pilot holes to enable proper alignment with worksurface supports. Wood screws must be used.
- Evolve worksurfaces feature a 3mm edge.

| PRODUCT CODE | PRICE | | SIZE/ INCHES | | | WEIGHT VOL | |
|--------------|-------|-----|--------------|----|----|------------|-----------------|
| | LP | HP | H | W | D | LBS | FT ³ |
| EVWTD1548 | 213 | 284 | 1 | 62 | 15 | 28.00 | 0.85 |
| EVWTD1560 | 249 | 333 | 1 | 74 | 15 | 31.00 | 0.94 |
| EVWTD1572 | 289 | 385 | 1 | 86 | 15 | 36.00 | 1.10 |

EVHEP • End Panel

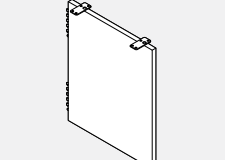

- Attaches a worksurface to a panel connector.
- Provides solid support at the end of a run of worksurfaces.
- Shipped with pedestal brackets and flat brackets.
- Glides are installed.
- Please specify metal colour for brackets.

| PRODUCT CODE | PRICE | SIZE/ INCHES | | | WEIGHT VOL | |
|--------------|-------|--------------|---|----|------------|-----------------|
| | | H | W | D | LBS | FT ³ |
| EVHEP2618 | 187 | 26 | 1 | 18 | 15.00 | 0.30 |
| EVHEP2624 | 239 | 25 | 1 | 24 | 16.00 | 0.35 |
| EVHEP2630 | 280 | 25 | 1 | 30 | 20.00 | 0.45 |
| EVHEP2918 | 197 | 28 | 1 | 18 | 18.00 | 0.40 |
| EVHEP2924 | 239 | 28 | 1 | 24 | 18.00 | 0.40 |
| EVHEP2930 | 280 | 28 | 1 | 30 | 22.00 | 0.50 |

EVHS • Support Leg

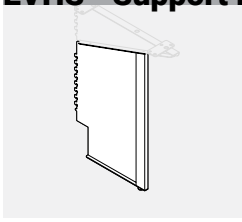

- Used in conjunction with an EVHC Cantilever of the same hand.
- Attaches a worksurface to a panel connector.
- Provides extra support where needed.
- May be used to support two convergent worksurfaces.
- Available in BLK (Black) only.

| PRODUCT CODE | PRICE | SIZE/ INCHES | | | WEIGHT VOL | |
|--------------|-------|--------------|---|----|------------|-----------------|
| | | H | W | D | LBS | FT ³ |
| EVHSL2618 | 126 | 22 | 1 | 10 | 6.00 | 0.24 |
| EVHSL2624 | 126 | 22 | 1 | 10 | 6.00 | 0.31 |
| EVHSL2918 | 133 | 25 | 1 | 10 | 7.00 | 0.30 |
| EVHSL2924 | 133 | 25 | 1 | 10 | 7.00 | 0.33 |
| EVHSR2618 | 126 | 22 | 1 | 10 | 6.00 | 0.24 |
| EVHSR2624 | 126 | 22 | 1 | 10 | 6.00 | 0.31 |
| EVHSR2918 | 133 | 25 | 1 | 10 | 7.00 | 0.30 |
| EVHSR2924 | 133 | 25 | 1 | 10 | 7.00 | 0.33 |

EVHC • Cantilever

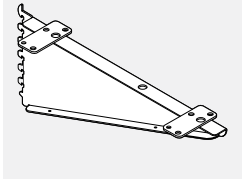

- Attaches a worksurface to a panel connector.
- May be used to support two convergent worksurfaces.
- Priced individually.
- Available in BLK (Black) only.

| PRODUCT CODE | PRICE | SIZE/ INCHES | | | WEIGHT VOL | |
|--------------|-------|--------------|---|----|------------|-----------------|
| | | H | W | D | LBS | FT ³ |
| EVHC12L | 93 | 8 | 1 | 12 | 2.00 | 0.04 |
| EVHC18L | 93 | 8 | 1 | 18 | 2.00 | 0.04 |
| EVHC24L | 104 | 8 | 1 | 24 | 3.00 | 0.05 |
| EVHC12R | 93 | 8 | 1 | 12 | 2.00 | 0.04 |
| EVHC18R | 93 | 8 | 1 | 18 | 2.00 | 0.04 |
| EVHC24R | 104 | 8 | 1 | 24 | 3.00 | 0.50 |

EVHMSL1 • Mid Support Leg

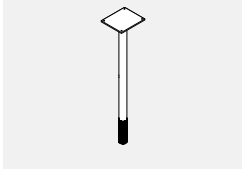

- Provides additional support for worksurface.
- Includes leveling glide, PVC Sleeve and 4.8" x 4.8" attachment plate.
- 1.5 diameter tube.
- Available in standard paint colours.

| PRODUCT CODE | PRICE | SIZE/ H | INCHES | WEIGHT VOL | |
|--------------|-------|---------|--------|------------|-----------------|
| | | | | LBS | FT ³ |
| EVHMSL1 | 77 | 28 | | 3.20 | 0.37 |

EVHMSL2 • Mid Support Leg

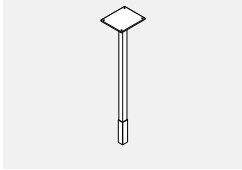

- Provides additional support for worksurface.
- Includes leveling glide, PVC Sleeve and 4.8" x 4.8" attachment plate.
- 1.5" square tube.
- Available in standard paint colours.

| PRODUCT CODE | PRICE | SIZE/ H | INCHES | WEIGHT VOL | |
|--------------|-------|---------|--------|------------|-----------------|
| | | | | LBS | FT ³ |
| EVHMSL2 | 77 | 28 | | 3.20 | 0.37 |

EVHMSCL18 • Mid Support Leg with Cantilever Bracket

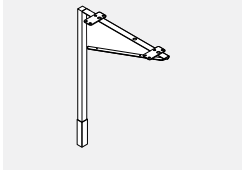

- Provides additional support for worksurface.
- Includes leveling glide, PVC Sleeve and 4.8" x 4.8" attachment plate.
- 1.5" square tube.
- Available in standard paint colours.

| PRODUCT CODE | PRICE | SIZE/ INCHES | | | WEIGHT VOL | |
|--------------|-------|--------------|----|-----|------------|-----------------|
| | | H | W | D | LBS | FT ³ |
| EVHMSCL18 | 115 | 28 | 18 | 1.5 | 5.2 | 0.55 |

EVHMEGR - Metal End Gable Round Leg, Non-handed

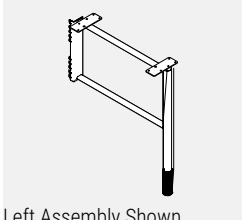

Left Assembly Shown

- **Metal End Gable Leg supports the worksurface and enhances the stability of connected panels.**
- Includes a leveling glide and decorative PVC sleeve to cover the glide.
- Attached to Evolve panel connectors. The mounting bracke is universal and attaches with screws to the back of the leg.
- Please specify standard paint finish.
- NOTE: Cannot be used to support worksurfaces side by side. Please use EVHMSRL12 for supporting adjoining worksurfaces.

| PRODUCT CODE | PRICE | SIZE/INCHES | | | WEIGHT VOL | |
|--------------|-------|-------------|---|----|------------|-----------------|
| | | H | W | D | LBS | FT ³ |
| EVHMEGR24 | 173 | 29 | 2 | 23 | 6.00 | 0.73 |
| EVHMEGR30 | 185 | 29 | 2 | 29 | 6.80 | 0.90 |

EVHMSRL - Metal Mid Support Round Leg

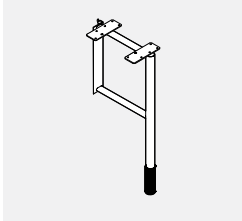

- **Metal Mid Support Leg supports two adjoining worksurfaces and enhances the stability of connected panels.**
- Includes a leveling glide and decorative PVC sleeve to cover the glide.
- Attached to Evolve Panels.
- Please specify standard paint finish.

| PRODUCT CODE | PRICE | SIZE/INCHES | | | WEIGHT VOL | |
|--------------|-------|-------------|---|----|------------|-----------------|
| | | H | W | D | LBS | FT ³ |
| EVHMSRL12 | 149 | 29 | 2 | 11 | 4.60 | 0.36 |

EVHMEGS - Metal End Gable Square Leg, Non-handed

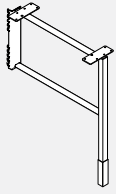

Left Assembly Shown

- **Metal End Gable Leg supports the worksurface and enhances the stability of connected panels.**
- Includes a leveling glide and decorative PVC sleeve to cover the glide.
- Attached to Evolve panel connectors. The mounting bracke is universal and attaches with screws to the back of the leg.
- Please specify standard paint finish.
- NOTE: Cannot be used to support worksurfaces side by side. Please use EVHMSSL12 for supporting adjoining worksurfaces.

| PRODUCT CODE | PRICE | SIZE/INCHES | | | WEIGHT LBS | VOL FT ³ |
|--------------|-------|-------------|---|----|------------|---------------------|
| | | H | W | D | | |
| EVHMEGS24 | 177 | 29 | 2 | 23 | 6.00 | 0.73 |
| EVHMEGS30 | 188 | 29 | 2 | 29 | 6.80 | 0.90 |

EVHMSSL - Metal Mid Support Square Leg

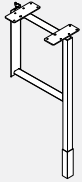

- **Metal Mid Support Leg supports two adjoining worksurfaces and enhances the stability of connected panels.**
- Includes a leveling glide and decorative PVC sleeve to cover the glide.
- Attached to Evolve Panels.
- Please specify standard paint finish.

| PRODUCT CODE | PRICE | SIZE/INCHES | | | WEIGHT LBS | VOL FT ³ |
|--------------|-------|-------------|---|----|------------|---------------------|
| | | H | W | D | | |
| EVHMSSL12 | 152 | 29 | 2 | 11 | 4.60 | 0.36 |

EVRTHLEG • Evolve Bridges Leg

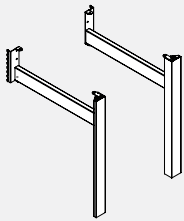

- Leg assembly attaches to panel for application which requires functionality of panels with open enviroment of Bridges tables.
- One leg with horizontal member connects to 1" increment slots in connector.
- Provides support to panel and panel connected 24" & 30" worksurface at end of run-design coordinated with Bridges freestanding tables.
- One leg can support 2 adjoining worksurface by specifying 2 flat brackets.
- Leveling glide is standard.
- Panel cantilever and storage must be for worksurface support.
- One aluminum leg with steel structure - specify left or right and 24" or 30" deep for corresponding worksurface depth.
- Panel bracket, dislodgment clip and worksurface hardware included.
- Anodized aluminum upcharge \$37.
- Please specify paint finish for support.

| PRODUCT CODE | PRICE | SIZE/ | INCHES | | WEIGHT LBS | VOL FT ³ |
|--------------|-------|-------|--------|----|------------|---------------------|
| | | H | W | D | | |
| EVRTHLEG24LL | 353 | 28 | 2.5 | 24 | 9 | 1.25 |
| EVRTHLEG24RL | 353 | 28 | 2.5 | 24 | 9 | 1.25 |
| EVRTHLEG30LL | 372 | 28 | 2.5 | 30 | 11 | 1.45 |
| EVRTHLEG30RL | 372 | 28 | 2.5 | 30 | 11 | 1.45 |

EVHH • High Profile Foot

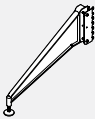

- Provides added support to a panel or worksurface under load.
- Two leveling glides included to adapt to different panel clearances.

| PRODUCT CODE | PRICE | SIZE/ | INCHES | | WEIGHT LBS | VOL FT ³ |
|--------------|-------|-------|--------|----|------------|---------------------|
| | | H | W | D | | |
| EVHHF01 | 249 | 6 | 1 | 21 | 2.80 | 0.15 |

EVHML • Monoleg



- Provides support for a worksurface.
- Includes an adjustable foot and an attachment plate.
- 3" diameter.
- 1" Height adjustment range.

| PRODUCT CODE | PRICE | SIZE/ INCHES | | | WEIGHT VOL | |
|--------------|-------|--------------|---|---|------------|-----------------|
| | | H | W | D | LBS | FT ³ |
| EVHML1 | 194 | 28 | 8 | 8 | 8.00 | 0.15 |

EVHCB • Corner Bracket

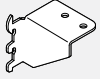

- Attaches the corner of any worksurface to a panel connector.
- Priced per pair.
- Available in BLK (Black) only.

| PRODUCT CODE | PRICE | SIZE/ INCHES | | | WEIGHT VOL | |
|--------------|-------|--------------|-----|-----|------------|-----------------|
| | | H | W | D | LBS | FT ³ |
| EVHCB2 | 26 | 2 | 3.5 | 2.5 | 0.50 | 0.02 |

EVHTB • Transaction Bracket



- Securely attaches a transaction surface to the top of a panel.
- Priced per pair.

| PRODUCT CODE | PRICE | SIZE/ INCHES | | | WEIGHT VOL | |
|--------------|-------|--------------|-----|-----|------------|-----------------|
| | | H | W | D | LBS | FT ³ |
| EVHTB2 | 26 | 3.5 | 3.5 | 2.5 | 0.50 | 0.02 |

EVHFB • Flat Bracket

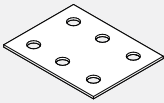

- Must be used in conjunction with cantilevers or transaction brackets to ensure alignment of neighbouring surfaces.

| PRODUCT CODE | PRICE | SIZE/ INCHES | | | WEIGHT VOL | |
|--------------|-------|--------------|---|---|------------|-----------------|
| | | H | W | D | LBS | FT ³ |
| EVHFB1 | 21 | 0.125 | 3 | 4 | 0.50 | 0.01 |

EVHZZB • "Z" Bracket



- Used to attach two different worksurface heights with a 3" difference.
- Must be used in conjunction with a cantilever.
- Available in BLK (Black) only.

| PRODUCT CODE | PRICE | SIZE/ INCHES | | | WEIGHT VOL | |
|--------------|-------|--------------|----|---|------------|-----------------|
| | | H | W | D | LBS | FT ³ |
| EVHZZB1 | 54 | 3 | 17 | 4 | 2.00 | 0.19 |

EVHPB • Pedestal Bracket



- Attaches to back edge of a pedestal and connects pedestal to panel connector.

| PRODUCT CODE | PRICE | SIZE/ INCHES | | | WEIGHT VOL | |
|--------------|-------|--------------|---|---|------------|-----------------|
| | | H | W | D | LBS | FT ³ |
| EVHPB1 | 29 | 12 | 1 | 1 | 0.50 | 0.50 |

EVHWSC • Worksurface Support Channel

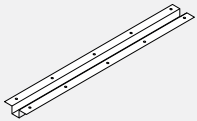

- EVHWSC40 for table 54" wide.
- EVHWSC46 for table 60" wide.
- EVHWSC52 for table 66" wide.
- EVHWSC58 for table 72" wide.
- EVHWSC64 for table 78" wide.
- EVHWSC70 for table 84" wide.
- Tops with post legs should be specified with support channel for structural reinforcement.
- Support channel attaches to underside of worksurface with screws.
- Support channel should be 14" shorter than top length.
- Screws included.
- Painted Black.

| PRODUCT CODE | PRICE | SIZE/ INCHES | | | WEIGHT VOL | |
|--------------|-------|--------------|---|----|------------|-----------------|
| | | H | W | D | LBS | FT ³ |
| EVHWSC40 | 58 | 40 | 5 | 4 | 0.20 | |
| EVHWSC46 | 64 | 46 | 5 | 6 | 0.22 | |
| EVHWSC52 | 68 | 52 | 5 | 7 | 0.25 | |
| EVHWSC58 | 78 | 58 | 5 | 8 | 0.28 | |
| EVHWSC64 | 88 | 64 | 5 | 9 | 0.31 | |
| EVHWSC70 | 94 | 70 | 5 | 10 | 0.33 | |

EVHV • Wall Adapter



- A "U" shaped channel used to attach system components to a fixed wall.
- Slots are 1" on centre.
- Sold per pair.
- Care should be taken to mount adapters only to wall studs using correct fasteners.
- Failure to do this may result in collapse of the unit and subsequent possible personal injury.
- Mounting hardware is not included.
- Mounting hardware selection to be based on wall material

| PRODUCT CODE | PRICE | SIZE/ INCHES | | | WEIGHT VOL | |
|--------------|-------|--------------|-----|-----|------------|-----------------|
| | | H | W | D | LBS | FT ³ |
| EVHV01 | 74 | 60 | 0.5 | 0.5 | 4.00 | 0.01 |

EVHOMB • Off Module Worksurface Bracket

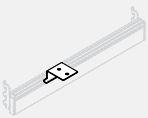

- Supports the worksurface in the work station corner in the case where an adjoining panel is wider than the worksurface.
- Enhances the stability of the worksurface.
- Can be used only in conjunction with the Top Load Bar (EVALB2xx - xx being the panel width - ordered separately)

| PRODUCT CODE | PRICE | SIZE/ INCHES | | | WEIGHT VOL | |
|--------------|-------|--------------|---|------|------------|-----------------|
| | | H | W | D | LBS | FT ³ |
| EVHOMB1 | 16 | 1.6 | 3 | 2.73 | 0.50 | 0.02 |

EVLEP • Laminate End Panel

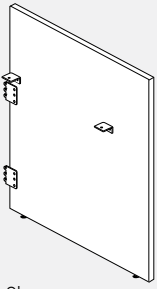

Right Shown

- Attaches to end of run connector.
- Finished in thermally fused laminate.
- Includes attachment flat brackets.
- Includes support brackets to attach worksurface.
- Laminate End Panel height is inclusive of panel glides extended to their full height.
- If wood grain is selected, grain runs vertically.
- Three sides are PVC edged while fourth edge is self-edge. Please choose a PVC edge colour.

| PRODUCT CODE | PRICE LP | SIZE/ INCHES | | WEIGHT VOL | |
|--------------|----------|--------------|----|------------|-----------------|
| | | H | W | LBS | FT ³ |
| EVLEPR4224 | 327 | 42 | 24 | 26.25 | 0.58 |
| EVLEPR4230 | 408 | 42 | 30 | 32.81 | 0.73 |
| EVLEPR4236 | 487 | 42 | 36 | 39.38 | 0.88 |
| EVLEPR4242 | 569 | 42 | 42 | 45.94 | 1.02 |
| EVLEPR4248 | 654 | 42 | 48 | 52.50 | 1.17 |
| EVLEPL4224 | 327 | 42 | 24 | 30.00 | 0.67 |
| EVLEPL4230 | 408 | 42 | 30 | 37.50 | 0.83 |
| EVLEPL4236 | 487 | 42 | 36 | 45.00 | 1.00 |
| EVLEPL4242 | 569 | 42 | 42 | 52.50 | 1.17 |
| EVLEPL4248 | 654 | 42 | 48 | 60.00 | 1.33 |
| EVLEPR4824 | 370 | 48 | 24 | 26.25 | 0.58 |
| EVLEPR4830 | 465 | 48 | 30 | 32.81 | 0.73 |
| EVLEPR4836 | 557 | 48 | 36 | 39.38 | 0.88 |
| EVLEPR4842 | 652 | 48 | 42 | 45.94 | 1.02 |
| EVLEPR4848 | 744 | 48 | 48 | 52.50 | 1.17 |
| EVLEPL4824 | 370 | 48 | 24 | 30.00 | 0.67 |
| EVLEPL4830 | 465 | 48 | 30 | 37.50 | 0.83 |
| EVLEPL4836 | 557 | 48 | 36 | 45.00 | 1.00 |
| EVLEPL4842 | 652 | 48 | 42 | 52.50 | 1.17 |
| EVLEPL4848 | 744 | 48 | 48 | 60.00 | 1.33 |

EVLMP • Laminate Middle Panel

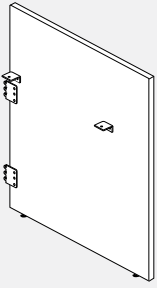

- Attaches to double inline connector.
- Finished in thermally fused laminate.
- Includes attachment flat brackets.
- Includes support brackets to attach worksurfaces on both sides on middle panel.
- Laminate Middle Panel height is inclusive of panel glides extended to their full height.
- If wood grain is selected, grain runs vertically.
- Three sides are PVC edged while fourth edge is self-edge. Please choose a PVC edge colour.

| PRODUCT CODE | PRICE LP | SIZE/ INCHES | | WEIGHT VOL | |
|--------------|----------|--------------|----|------------|-----------------|
| | | H | W | LBS | FT ³ |
| EVLMP4224 | 364 | 42 | 24 | 26.25 | 0.58 |
| EVLMP4230 | 442 | 42 | 30 | 32.81 | 0.73 |
| EVLMP4236 | 524 | 42 | 36 | 39.38 | 0.88 |
| EVLMP4242 | 608 | 42 | 42 | 45.94 | 1.02 |
| EVLMP4248 | 694 | 42 | 48 | 52.50 | 1.17 |
| EVLMP4824 | 406 | 48 | 24 | 30.00 | 0.67 |
| EVLMP4830 | 503 | 48 | 30 | 37.50 | 0.83 |
| EVLMP4836 | 595 | 48 | 36 | 45.00 | 1.00 |
| EVLMP4842 | 689 | 48 | 42 | 52.50 | 1.17 |
| EVLMP4848 | 783 | 48 | 48 | 60.00 | 1.33 |

EVLEP-A • Laminate End Panel with Accessory Rail

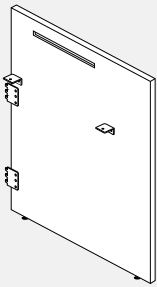

Right Shown

- Attaches to end of run connector.
- Finished in thermally fused laminate.
- Includes attachment flat brackets and accessory rail on inside.
- Includes support brackets to attach worksurface.
- Laminate End Panel height is inclusive of panel glides extended to their full height.
- If wood grain is selected, grain runs vertically.
- Three sides are PVC edged while fourth edge is self-edge. Please choose a PVC edge colour.

| PRODUCT CODE | PRICE LP | SIZE/ INCHES | | WEIGHT VOL | |
|--------------|----------|--------------|----|------------|-----------------|
| | | H | W | LBS | FT ³ |
| EVLEPR4224A | 370 | 42 | 24 | 26.25 | 0.58 |
| EVLEPR4230A | 450 | 42 | 30 | 32.81 | 0.73 |
| EVLEPR4236A | 535 | 42 | 36 | 39.38 | 0.88 |
| EVLEPR4242A | 614 | 42 | 42 | 45.94 | 1.02 |
| EVLEPR4248A | 699 | 42 | 48 | 52.50 | 1.17 |
| EVLEPL4224A | 370 | 42 | 24 | 30.00 | 0.67 |
| EVLEPL4230A | 450 | 42 | 30 | 37.50 | 0.83 |
| EVLEPL4236A | 535 | 42 | 36 | 45.00 | 1.00 |
| EVLEPL4242A | 614 | 42 | 42 | 52.50 | 1.17 |
| EVLEPL4248A | 699 | 42 | 48 | 60.00 | 1.33 |
| EVLEPR4824A | 411 | 48 | 24 | 26.25 | 0.58 |
| EVLEPR4830A | 501 | 48 | 30 | 32.81 | 0.73 |
| EVLEPR4836A | 565 | 48 | 36 | 39.38 | 0.88 |
| EVLEPR4842A | 644 | 48 | 42 | 45.94 | 1.02 |
| EVLEPR4848A | 790 | 48 | 48 | 52.50 | 1.17 |
| EVLEPL4824A | 411 | 48 | 24 | 30.00 | 0.67 |
| EVLEPL4830A | 501 | 48 | 30 | 37.50 | 0.83 |
| EVLEPL4836A | 565 | 48 | 36 | 45.00 | 1.00 |
| EVLEPL4842A | 644 | 48 | 42 | 52.50 | 1.17 |
| EVLEPL4848A | 790 | 48 | 48 | 60.00 | 1.33 |

EVLMP-A • Laminate Middle Panel with Accessory Rail

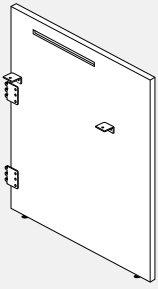

- Attaches to double inline connector.
- Finished in thermally fused laminate.
- Includes accessory rail on both sides of middle panel.
- Includes attachment flat brackets and accessory rail on both sides.
- Includes support brackets to attach worksurfaces on both sides on middle panel.
- Laminate Middle Panel height is inclusive of panel glides extended to their full height.
- If wood grain is selected, grain runs vertically.
- Three sides are PVC edged while fourth edge is self-edge. Please choose a PVC edge colour.

| PRODUCT CODE | PRICE LP | SIZE / INCHES | | WEIGHT VOL | |
|--------------|----------|---------------|----|------------|-----------------|
| | | H | W | LBS | FT ³ |
| EVLMP4224A | 417 | 42 | 24 | 26.25 | 0.58 |
| EVLMP4230A | 499 | 42 | 30 | 32.81 | 0.73 |
| EVLMP4236A | 582 | 42 | 36 | 39.38 | 0.88 |
| EVLMP4242A | 661 | 42 | 42 | 45.94 | 1.02 |
| EVLMP4248A | 751 | 42 | 48 | 52.50 | 1.17 |
| EVLMP4824A | 456 | 48 | 24 | 30.00 | 0.67 |
| EVLMP4830A | 557 | 48 | 30 | 37.50 | 0.83 |
| EVLMP4836A | 652 | 48 | 36 | 45.00 | 1.00 |
| EVLMP4842A | 744 | 48 | 42 | 52.50 | 1.17 |
| EVLMP4848A | 837 | 48 | 48 | 60.00 | 1.33 |

EV4LXP • Laminate Panel Four Way

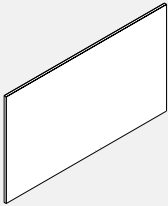

- Panel connects "+" configuration with extension panel
- Finished in thermally fused laminate
- Laminate extension Panel height is inclusive of panel glides extended to their full height
- If wood grain is selected, grain runs horizontally
- Corner connecting brackets to be ordered separately

| PRODUCT CODE | PRICE LP | SIZE / INCHES | | WEIGHT VOL | |
|--------------|----------|---------------|----|------------|-----------------|
| | | H | W | LBS | FT ³ |
| EV4LXP4249 | 535 | 42 | 49 | 53.59 | 1.19 |
| EV4LXP4261 | 638 | 42 | 61 | 66.72 | 1.48 |
| EV4LXP4273 | 740 | 42 | 73 | 79.84 | 1.77 |
| EV4LXP4849 | 607 | 48 | 49 | 61.25 | 1.36 |
| EV4LXP4861 | 745 | 48 | 61 | 76.25 | 1.69 |
| EV4LXP4873 | 885 | 48 | 73 | 91.25 | 2.03 |
| EV4LXP5449 | 678 | 54 | 49 | 68.91 | 1.53 |
| EV4LXP5461 | 885 | 54 | 61 | 85.78 | 1.91 |
| EV4LXP5473 | 1023 | 54 | 73 | 102.66 | 2.28 |

EVLXPML • Laminate Extension Panel

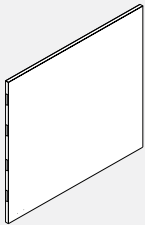

- Locking connection on both sides
- Finished in thermally fused laminate
- Laminate extension Panel height is inclusive of panel glides extended to their full height
- If wood grain is selected, grain runs horizontally
- Bottom connecting brackets to be ordered separately

| PRODUCT CODE | PRICE LP | SIZE / INCHES | | WEIGHT VOL | |
|--------------|----------|---------------|----|------------|-----------------|
| | | H | W | LBS | FT ³ |
| EVLXPML4224 | 284 | 42 | 24 | 26.25 | 0.58 |
| EVLXPML4230 | 346 | 42 | 30 | 32.81 | 0.73 |
| EVLXPML4236 | 386 | 42 | 36 | 39.38 | 0.88 |
| EVLXPML4242 | 435 | 42 | 42 | 45.94 | 1.02 |
| EVLXPML4248 | 499 | 42 | 48 | 52.50 | 1.17 |
| EVLXPMR4224 | 284 | 42 | 24 | 26.25 | 0.58 |
| EVLXPMR4230 | 346 | 42 | 30 | 32.81 | 0.73 |
| EVLXPMR4236 | 386 | 42 | 36 | 39.38 | 0.88 |
| EVLXPMR4242 | 435 | 42 | 42 | 45.94 | 1.02 |
| EVLXPMR4248 | 499 | 42 | 48 | 52.50 | 1.17 |
| EVLXPML4824 | 328 | 48 | 24 | 30.00 | 0.67 |
| EVLXPML4830 | 378 | 48 | 30 | 37.50 | 0.83 |
| EVLXPML4836 | 432 | 48 | 36 | 45.00 | 1.00 |
| EVLXPML4842 | 483 | 48 | 42 | 52.50 | 1.17 |
| EVLXPML4848 | 535 | 48 | 48 | 60.00 | 1.33 |
| EVLXPMR4824 | 328 | 48 | 24 | 30.00 | 0.67 |
| EVLXPMR4830 | 378 | 48 | 30 | 37.50 | 0.83 |
| EVLXPMR4836 | 432 | 48 | 36 | 45.00 | 1.00 |
| EVLXPMR4842 | 483 | 48 | 42 | 52.50 | 1.17 |
| EVLXPMR4848 | 535 | 48 | 48 | 60.00 | 1.33 |
| EVLXPML5424 | 355 | 54 | 24 | 33.75 | 0.75 |
| EVLXPML5430 | 417 | 54 | 30 | 42.19 | 0.94 |
| EVLXPML5436 | 477 | 54 | 36 | 50.63 | 1.13 |
| EVLXPML5442 | 543 | 54 | 42 | 59.06 | 1.31 |
| EVLXPML5448 | 638 | 54 | 48 | 67.50 | 1.50 |
| EVLXPMR5424 | 355 | 54 | 24 | 33.75 | 0.75 |
| EVLXPMR5430 | 417 | 54 | 30 | 42.19 | 0.94 |
| EVLXPMR5436 | 477 | 54 | 36 | 50.63 | 1.13 |
| EVLXPMR5442 | 543 | 54 | 42 | 59.06 | 1.31 |
| EVLXPMR5448 | 638 | 54 | 48 | 67.50 | 1.50 |

EV2LXP • Laminate Extension Panel Two Way

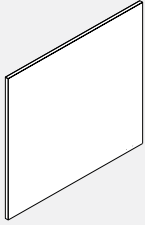

- Panel connects at 90 degree with extension panel
- Finished in thermally fused laminate
- Laminate extension Panel height is inclusive of panel glides extGalleryed to their full height
- If wood grain is selected, grain runs horizontally
- Corner connecting brackets to be ordered separately

| PRODUCT CODE | PRICE LP | SIZE / INCHES | | WEIGHT LBS | VOL FT ³ |
|--------------|----------|---------------|----|------------|---------------------|
| | | H | W | | |
| EV2LXPL4225 | 284 | 42 | 25 | 27.34 | 0.61 |
| EV2LXPL4231 | 346 | 42 | 31 | 33.91 | 0.75 |
| EV2LXPL4237 | 386 | 42 | 37 | 40.47 | 0.90 |
| EV2LXPL4243 | 435 | 42 | 43 | 47.03 | 1.05 |
| EV2LXPL4249 | 499 | 42 | 49 | 53.59 | 1.19 |
| EV2LXPR4225 | 284 | 42 | 25 | 27.34 | 0.61 |
| EV2LXPR4231 | 346 | 42 | 31 | 33.91 | 0.75 |
| EV2LXPR4237 | 386 | 42 | 37 | 40.47 | 0.90 |
| EV2LXPR4243 | 435 | 42 | 43 | 47.03 | 1.05 |
| EV2LXPR4249 | 499 | 42 | 49 | 53.59 | 1.19 |
| EV2LXPL4825 | 328 | 48 | 25 | 31.25 | 0.69 |
| EV2LXPL4831 | 378 | 48 | 31 | 38.75 | 0.86 |
| EV2LXPL4837 | 432 | 48 | 37 | 46.25 | 1.03 |
| EV2LXPL4843 | 483 | 48 | 43 | 53.75 | 1.19 |
| EV2LXPL4849 | 535 | 48 | 49 | 61.25 | 1.36 |
| EV2LXPR4825 | 328 | 48 | 25 | 31.25 | 0.69 |
| EV2LXPR4831 | 378 | 48 | 31 | 38.75 | 0.86 |
| EV2LXPR4837 | 432 | 48 | 37 | 46.25 | 1.03 |
| EV2LXPR4843 | 483 | 48 | 43 | 53.75 | 1.19 |
| EV2LXPR4849 | 535 | 48 | 49 | 61.25 | 1.36 |
| EV2LXPL5425 | 383 | 54 | 25 | 35.16 | 0.78 |
| EV2LXPL5431 | 438 | 54 | 31 | 43.59 | 0.97 |
| EV2LXPL5437 | 494 | 54 | 37 | 52.03 | 1.16 |
| EV2LXPL5443 | 600 | 54 | 43 | 60.47 | 1.34 |
| EV2LXPL5449 | 678 | 54 | 49 | 68.91 | 1.53 |
| EV2LXPR5425 | 383 | 54 | 25 | 35.16 | 0.78 |
| EV2LXPR5431 | 438 | 54 | 31 | 43.59 | 0.97 |
| EV2LXPR5437 | 494 | 54 | 37 | 52.03 | 1.16 |
| EV2LXPR5443 | 600 | 54 | 43 | 60.47 | 1.34 |
| EV2LXPR5449 | 678 | 54 | 49 | 68.91 | 1.53 |

EV3LXP • Laminate Extension Panel Three Way

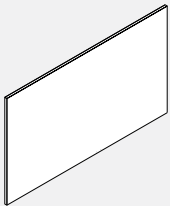

- Panel connects "T" configuration with extension panel
- Finished in thermally fused laminate
- Laminate extension Panel height is inclusive of panel glides extended to their full height
- If wood grain is selected, grain runs horizontally
- Corner connecting brackets to be ordered separately

| PRODUCT CODE | PRICE LP | SIZE / INCHES | | WEIGHT LBS | VOL FT ³ |
|--------------|----------|---------------|----|------------|---------------------|
| | | H | W | | |
| EV3LXPL4249 | 535 | 42 | 49 | 53.59 | 1.19 |
| EV3LXPL4261 | 638 | 42 | 61 | 66.72 | 1.48 |
| EV3LXPL4273 | 740 | 42 | 73 | 79.84 | 1.77 |
| EV3LXPR4249 | 535 | 42 | 49 | 53.59 | 1.19 |
| EV3LXPR4261 | 638 | 42 | 61 | 66.72 | 1.48 |
| EV3LXPR4273 | 740 | 42 | 73 | 79.84 | 1.77 |
| EV3LXPL4849 | 607 | 48 | 49 | 61.25 | 1.36 |
| EV3LXPL4861 | 745 | 48 | 61 | 76.25 | 1.69 |
| EV3LXPL4873 | 885 | 48 | 73 | 91.25 | 2.03 |
| EV3LXPR4849 | 607 | 48 | 49 | 61.25 | 1.36 |
| EV3LXPR4861 | 745 | 48 | 61 | 76.25 | 1.69 |
| EV3LXPR4873 | 885 | 48 | 73 | 91.25 | 2.03 |
| EV3LXPL5449 | 678 | 54 | 49 | 68.91 | 1.53 |
| EV3LXPL5461 | 885 | 54 | 61 | 85.78 | 1.91 |
| EV3LXPL5473 | 1023 | 54 | 73 | 102.66 | 2.28 |
| EV3LXPR5449 | 678 | 54 | 49 | 68.91 | 1.53 |
| EV3LXPR5461 | 885 | 54 | 61 | 85.78 | 1.91 |
| EV3LXPR5473 | 1023 | 54 | 73 | 102.66 | 2.28 |

EV4LXPM • Laminate Extension Panel for Four Way Configuration

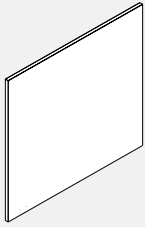

- Locking connection on one side only for four way panel
- Finished in thermally fused laminate
- Universal to be used on both sides of four way laminate panel
- Laminate extension Panel height is inclusive of panel glides extended to their full height
- If wood grain is selected, grain runs horizontally
- Bottom connecting brackets to be ordered separately

| PRODUCT CODE | PRICE LP | SIZE / INCHES | | WEIGHT LBS | VOL FT ³ |
|--------------|----------|---------------|----|------------|---------------------|
| | | H | W | | |
| EV4LXPM4224 | 284 | 42 | 24 | 26.25 | 0.58 |
| EV4LXPM4230 | 346 | 42 | 30 | 32.81 | 0.73 |
| EV4LXPM4236 | 386 | 42 | 36 | 39.38 | 0.88 |
| EV4LXPM4242 | 435 | 42 | 42 | 45.94 | 1.02 |
| EV4LXPM4248 | 499 | 42 | 48 | 52.50 | 1.17 |
| EV4LXPM4824 | 328 | 48 | 24 | 30.00 | 0.67 |
| EV4LXPM4830 | 378 | 48 | 30 | 37.50 | 0.83 |
| EV4LXPM4836 | 432 | 48 | 36 | 45.00 | 1.00 |
| EV4LXPM4842 | 483 | 48 | 42 | 52.50 | 1.17 |
| EV4LXPM4848 | 535 | 48 | 48 | 60.00 | 1.33 |
| EV4LXPM5424 | 355 | 54 | 24 | 33.75 | 0.75 |
| EV4LXPM5430 | 417 | 54 | 30 | 42.19 | 0.94 |
| EV4LXPM5436 | 477 | 54 | 36 | 50.63 | 1.13 |
| EV4LXPM5442 | 543 | 54 | 42 | 59.06 | 1.31 |
| EV4LXPM5448 | 638 | 54 | 48 | 67.50 | 1.50 |

EVLXPML-NC - Laminate Extension Panel, No End Connection

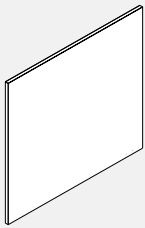

- Locking connection on one sides, no connection at end
- Finished in thermally fused laminate
- Laminate extension Panel height is inclusive of panel glides extended to their full height
- If wood grain is selected, grain runs horizontally
- Bottom connecting brackets to be ordered separately

| PRODUCT CODE | PRICE LP | SIZE / INCHES | | WEIGHT LBS | VOL FT ³ |
|---------------|----------|---------------|----|------------|---------------------|
| | | H | W | | |
| EVLXPML4224NC | 284 | 42 | 24 | 26.25 | 0.58 |
| EVLXPML4230NC | 346 | 42 | 30 | 32.81 | 0.73 |
| EVLXPML4236NC | 386 | 42 | 36 | 39.38 | 0.88 |
| EVLXPML4242NC | 435 | 42 | 42 | 45.94 | 1.02 |
| EVLXPML4248NC | 499 | 42 | 48 | 52.50 | 1.17 |
| EVLXPMR4224NC | 284 | 42 | 24 | 26.25 | 0.58 |
| EVLXPMR4230NC | 346 | 42 | 30 | 32.81 | 0.73 |
| EVLXPMR4236NC | 386 | 42 | 36 | 39.38 | 0.88 |
| EVLXPMR4242NC | 435 | 42 | 42 | 45.94 | 1.02 |
| EVLXPMR4248NC | 499 | 42 | 48 | 52.50 | 1.17 |
| EVLXPML4824NC | 328 | 48 | 24 | 30.00 | 0.67 |
| EVLXPML4830NC | 378 | 48 | 30 | 37.50 | 0.83 |
| EVLXPML4836NC | 432 | 48 | 36 | 45.00 | 1.00 |
| EVLXPML4842NC | 483 | 48 | 42 | 52.50 | 1.17 |
| EVLXPML4848NC | 535 | 48 | 48 | 60.00 | 1.33 |
| EVLXPMR4824NC | 328 | 48 | 24 | 30.00 | 0.67 |
| EVLXPMR4830NC | 378 | 48 | 30 | 37.50 | 0.83 |
| EVLXPMR4836NC | 432 | 48 | 36 | 45.00 | 1.00 |
| EVLXPMR4842NC | 483 | 48 | 42 | 52.50 | 1.17 |
| EVLXPMR4848NC | 535 | 48 | 48 | 60.00 | 1.33 |
| EVLXPML5424NC | 355 | 54 | 24 | 33.75 | 0.75 |
| EVLXPML5430NC | 417 | 54 | 30 | 42.19 | 0.94 |
| EVLXPML5436NC | 477 | 54 | 36 | 50.63 | 1.13 |
| EVLXPML5442NC | 543 | 54 | 42 | 59.06 | 1.31 |
| EVLXPML5448NC | 638 | 54 | 48 | 67.50 | 1.50 |
| EVLXPMR5424NC | 355 | 54 | 24 | 33.75 | 0.75 |
| EVLXPMR5430NC | 417 | 54 | 30 | 42.19 | 0.94 |
| EVLXPMR5436NC | 477 | 54 | 36 | 50.63 | 1.13 |
| EVLXPMR5442NC | 543 | 54 | 42 | 59.06 | 1.31 |
| EVLXPMR5448NC | 638 | 54 | 48 | 67.50 | 1.50 |

EVLEPDS • Laminate Gallery Panel

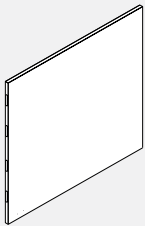

- Attaches to end of run connector with "U" channel
- To be installed at end of panel run
- Finished in thermally fused laminate
- Locking connection both sides
- Laminate Gallery Panel height is inclusive of panel glides extended to their full height
- If wood grain is selected, grain runs horizontally
- End of run connector with "U" channel and bottom connecting brackets to be ordered separately

| PRODUCT CODE | PRICE LP | SIZE / INCHES | | WEIGHT LBS | VOL FT ³ |
|--------------|----------|---------------|----|------------|---------------------|
| | | H | W | | |
| EVLEPDS4251 | 535 | 42 | 51 | 55.78 | 1.24 |
| EVLEPDS4263 | 695 | 42 | 63 | 68.91 | 1.53 |
| EVLEPDS4275 | 857 | 42 | 75 | 82.03 | 1.82 |
| EVLEPDS4851 | 607 | 48 | 51 | 63.75 | 1.42 |
| EVLEPDS4863 | 773 | 48 | 63 | 78.75 | 1.75 |
| EVLEPDS4875 | 937 | 48 | 75 | 93.75 | 2.08 |
| EVLEPDS5451 | 678 | 54 | 51 | 71.72 | 1.59 |
| EVLEPDS5463 | 885 | 54 | 63 | 88.59 | 1.97 |
| EVLEPDS5475 | 1023 | 54 | 75 | 105.47 | 2.34 |

EVLEPDC • Laminate Gallery Panel

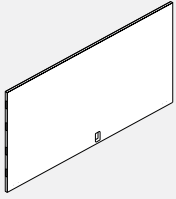

- Attaches in middle of panel run with connector with "U" channel
- To be installed in middle between two panels in straight run
- Finished in thermally fused laminate
- Locking connection both sides
- Laminate Gallery Panel height is inclusive of panel glides extended to their full height
- If wood grain is selected, grain runs horizontally
- End of run connector with "U" channel and bottom connecting brackets to be ordered separately

| PRODUCT CODE | PRICE LP | SIZE / INCHES | | WEIGHT LBS | VOL FT ³ |
|--------------|----------|---------------|----|------------|---------------------|
| | | H | W | | |
| EVLEPDC4251 | 535 | 42 | 51 | 55.78 | 1.24 |
| EVLEPDC4263 | 695 | 42 | 63 | 68.91 | 1.53 |
| EVLEPDC4275 | 857 | 42 | 75 | 82.03 | 1.82 |
| EVLEPDC4851 | 607 | 48 | 51 | 63.75 | 1.42 |
| EVLEPDC4863 | 773 | 48 | 63 | 78.75 | 1.75 |
| EVLEPDC4875 | 937 | 48 | 75 | 93.75 | 2.08 |
| EVLEPDC5451 | 678 | 54 | 51 | 71.72 | 1.59 |
| EVLEPDC5463 | 885 | 54 | 63 | 88.59 | 1.97 |
| EVLEPDC5475 | 1023 | 54 | 75 | 105.47 | 2.34 |

EVLEPSSL/R • Laminate Gallery Panel, End Connection on One Side

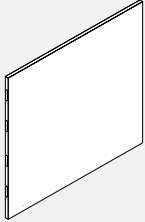

- Attaches to end of run connector with "U" channel
- To be installed at end of panel run on one side
- Finished in thermally fused laminate
- Locking connection on one side
- Laminate Gallery Panel height is inclusive of panel glides extended to their full height
- If wood grain is selected, grain runs horizontally
- End of run connector with "U" channel and bottom connecting brackets to be ordered separately

| PRODUCT CODE | PRICE LP | SIZE / INCHES | | WEIGHT LBS | VOL FT ³ |
|--------------|----------|---------------|----|------------|---------------------|
| | | H | W | | |
| EVLEPSSL4227 | 346 | 42 | 27 | 29.53 | 0.66 |
| EVLEPSSL4233 | 386 | 42 | 33 | 36.09 | 0.80 |
| EVLEPSSL4239 | 435 | 42 | 39 | 42.66 | 0.95 |
| EVLEPSSL4245 | 499 | 42 | 45 | 49.22 | 1.09 |
| EVLEPSSL4251 | 535 | 42 | 51 | 55.78 | 1.24 |
| EVLEPSSL4827 | 378 | 48 | 27 | 33.75 | 0.75 |
| EVLEPSSL4833 | 432 | 48 | 33 | 41.25 | 0.92 |
| EVLEPSSL4839 | 483 | 48 | 39 | 48.75 | 1.08 |
| EVLEPSSL4845 | 535 | 48 | 45 | 56.25 | 1.25 |
| EVLEPSSL4851 | 607 | 48 | 51 | 63.75 | 1.42 |
| EVLEPSSL5427 | 417 | 54 | 27 | 37.97 | 0.84 |
| EVLEPSSL5433 | 477 | 54 | 33 | 46.41 | 1.03 |
| EVLEPSSL5439 | 543 | 54 | 39 | 54.84 | 1.22 |
| EVLEPSSL5445 | 638 | 54 | 45 | 63.28 | 1.41 |
| EVLEPSSL5451 | 678 | 54 | 51 | 71.72 | 1.59 |
| EVLEPSSR4227 | 346 | 42 | 27 | 29.53 | 0.66 |
| EVLEPSSR4233 | 386 | 42 | 33 | 36.09 | 0.80 |
| EVLEPSSR4239 | 435 | 42 | 39 | 42.66 | 0.95 |
| EVLEPSSR4245 | 499 | 42 | 45 | 49.22 | 1.09 |
| EVLEPSSR4251 | 535 | 42 | 51 | 55.78 | 1.24 |
| EVLEPSSR4827 | 378 | 48 | 27 | 33.75 | 0.75 |
| EVLEPSSR4833 | 432 | 48 | 33 | 41.25 | 0.92 |
| EVLEPSSR4839 | 483 | 48 | 39 | 48.75 | 1.08 |
| EVLEPSSR4845 | 535 | 48 | 45 | 56.25 | 1.25 |
| EVLEPSSR4851 | 607 | 48 | 51 | 63.75 | 1.42 |
| EVLEPSSR5427 | 417 | 54 | 27 | 37.97 | 0.84 |
| EVLEPSSR5433 | 477 | 54 | 33 | 46.41 | 1.03 |
| EVLEPSSR5439 | 543 | 54 | 39 | 54.84 | 1.22 |
| EVLEPSSR5445 | 638 | 54 | 45 | 63.28 | 1.41 |
| EVLEPSSR5451 | 678 | 54 | 51 | 71.72 | 1.59 |

EVLEPSC • Laminate Gallery Panel

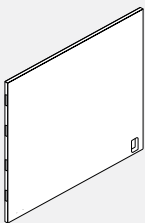

- Attaches in middle of panel run with connector with "U" channel
- To be installed in middle between two panels in straight run on one side
- Cut out for electrics at power beam height
- Finished in thermally fused laminate
- Locking connection on one side
- Laminate Gallery Panel height is inclusive of panel glides extended to their full height
- If wood grain is selected, grain runs horizontally
- End of run connector with "U" channel and bottom connecting brackets to be ordered separately

| PRODUCT CODE | PRICE LP | SIZE / INCHES | | WEIGHT LBS | VOL FT ³ |
|--------------|----------|---------------|----|------------|---------------------|
| | | H | W | | |
| EVLEPSC4227 | 346 | 42 | 27 | 29.53 | 0.66 |
| EVLEPSC4233 | 386 | 42 | 33 | 36.09 | 0.80 |
| EVLEPSC4239 | 435 | 42 | 39 | 42.66 | 0.95 |
| EVLEPSC4245 | 499 | 42 | 45 | 49.22 | 1.09 |
| EVLEPSC4251 | 535 | 42 | 51 | 55.78 | 1.24 |
| EVLEPSC4827 | 378 | 48 | 27 | 33.75 | 0.75 |
| EVLEPSC4833 | 432 | 48 | 33 | 41.25 | 0.92 |
| EVLEPSC4839 | 483 | 48 | 39 | 48.75 | 1.08 |
| EVLEPSC4845 | 535 | 48 | 45 | 56.25 | 1.25 |
| EVLEPSC4851 | 607 | 48 | 51 | 63.75 | 1.42 |
| EVLEPSC5427 | 417 | 54 | 27 | 37.97 | 0.84 |
| EVLEPSC5433 | 477 | 54 | 33 | 46.41 | 1.03 |
| EVLEPSC5439 | 543 | 54 | 39 | 54.84 | 1.22 |
| EVLEPSC5445 | 638 | 54 | 45 | 63.28 | 1.41 |
| EVLEPSC5451 | 678 | 54 | 51 | 71.72 | 1.59 |

EVLEPDS-NC • Laminate Gallery Panel, No End Connection at Both Sides

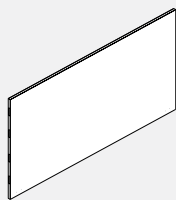

- Attaches to end of run connector with "U" channel
- To be installed at end of panel run
- Finished in thermally fused laminate
- Locking connection both sides
- Laminate Gallery Panel height is inclusive of panel glides extended to their full height
- If wood grain is selected, grain runs horizontally
- End of run connector with "U" channel and bottom connecting brackets to be ordered separately

| PRODUCT CODE | PRICE LP | SIZE / INCHES | | WEIGHT LBS | VOL FT ³ |
|---------------|----------|---------------|----|------------|---------------------|
| | | H | W | | |
| EVLEPDS4251NC | 535 | 42 | 51 | 55.78 | 1.24 |
| EVLEPDS4263NC | 695 | 42 | 63 | 68.91 | 1.53 |
| EVLEPDS4275NC | 857 | 42 | 75 | 82.03 | 1.82 |
| EVLEPDS4851NC | 607 | 48 | 51 | 63.75 | 1.42 |
| EVLEPDS4863NC | 773 | 48 | 63 | 78.75 | 1.75 |
| EVLEPDS4875NC | 937 | 48 | 75 | 93.75 | 2.08 |
| EVLEPDS5451NC | 678 | 54 | 51 | 71.72 | 1.59 |
| EVLEPDS5463NC | 885 | 54 | 63 | 88.59 | 1.97 |
| EVLEPDS5475NC | 1023 | 54 | 75 | 105.47 | 2.34 |

EVLEPDC-NC • Laminate Gallery Middle Panel, No End Connection at Both Sides

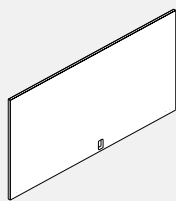

- Attaches in middle of panel run with connector with "U" channel
- To be installed in middle between two panels in straight run
- Finished in thermally fused laminate
- No connection both sides
- Laminate Gallery Panel height is inclusive of panel glides extended to their full height
- If wood grain is selected, grain runs horizontally
- End of run connector with "U" channel and bottom connecting brackets to be ordered separately

| PRODUCT CODE | PRICE LP | SIZE / INCHES | | WEIGHT LBS | VOL FT ³ |
|---------------|----------|---------------|----|------------|---------------------|
| | | H | W | | |
| EVLEPDC4251NC | 535 | 42 | 51 | 55.78 | 1.24 |
| EVLEPDC4263NC | 695 | 42 | 63 | 68.91 | 1.53 |
| EVLEPDC4275NC | 857 | 42 | 75 | 82.03 | 1.82 |
| EVLEPDC4851NC | 607 | 48 | 51 | 63.75 | 1.42 |
| EVLEPDC4863NC | 773 | 48 | 63 | 78.75 | 1.75 |
| EVLEPDC4875NC | 937 | 48 | 75 | 93.75 | 2.08 |
| EVLEPDC5451NC | 678 | 54 | 51 | 71.72 | 1.59 |
| EVLEPDC5463NC | 885 | 54 | 63 | 88.59 | 1.97 |
| EVLEPDC5475NC | 1023 | 54 | 75 | 105.47 | 2.34 |

EVLEPSS-NC • Laminate Gallery End Panel, No End Connection at Both Sides

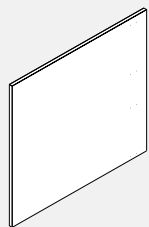

- Attaches in middle of panel run with connector with "U" channel
- To be installed in middle between two panels in straight run
- Finished in thermally fused laminate
- No connection both sides
- Laminate Gallery Panel height is inclusive of panel glides extended to their full height
- If wood grain is selected, grain runs horizontally
- End of run connector with "U" channel and bottom connecting brackets to be ordered separately

| PRODUCT CODE | PRICE LP | SIZE / INCHES | | WEIGHT LBS | VOL FT ³ |
|----------------|----------|---------------|----|------------|---------------------|
| | | H | W | | |
| EVLEPSSL4227NC | 346 | 42 | 27 | 29.53 | 0.66 |
| EVLEPSSL4233NC | 386 | 42 | 33 | 36.09 | 0.80 |
| EVLEPSSL4239NC | 435 | 42 | 39 | 42.66 | 0.95 |
| EVLEPSSL4245NC | 499 | 42 | 45 | 49.22 | 1.09 |
| EVLEPSSL4251NC | 535 | 42 | 51 | 55.78 | 1.24 |
| EVLEPSSL4827NC | 378 | 48 | 27 | 33.75 | 0.75 |
| EVLEPSSL4833NC | 432 | 48 | 33 | 41.25 | 0.92 |
| EVLEPSSL4839NC | 483 | 48 | 39 | 48.75 | 1.08 |
| EVLEPSSL4845NC | 535 | 48 | 45 | 56.25 | 1.25 |
| EVLEPSSL4851NC | 607 | 48 | 51 | 63.75 | 1.42 |
| EVLEPSSL5427NC | 417 | 54 | 27 | 37.97 | 0.84 |
| EVLEPSSL5433NC | 477 | 54 | 33 | 46.41 | 1.03 |
| EVLEPSSL5439NC | 543 | 54 | 39 | 54.84 | 1.22 |
| EVLEPSSL5445NC | 638 | 54 | 45 | 63.28 | 1.41 |
| EVLEPSSL5451NC | 678 | 54 | 51 | 71.72 | 1.59 |
| EVLEPSSR4227NC | 346 | 42 | 27 | 29.53 | 0.66 |
| EVLEPSSR4233NC | 386 | 42 | 33 | 36.09 | 0.80 |
| EVLEPSSR4239NC | 435 | 42 | 39 | 42.66 | 0.95 |
| EVLEPSSR4245NC | 499 | 42 | 45 | 49.22 | 1.09 |
| EVLEPSSR4251NC | 535 | 42 | 51 | 55.78 | 1.24 |
| EVLEPSSR4827NC | 378 | 48 | 27 | 33.75 | 0.75 |
| EVLEPSSR4833NC | 432 | 48 | 33 | 41.25 | 0.92 |
| EVLEPSSR4839NC | 483 | 48 | 39 | 48.75 | 1.08 |
| EVLEPSSR4845NC | 535 | 48 | 45 | 56.25 | 1.25 |
| EVLEPSSR4851NC | 607 | 48 | 51 | 63.75 | 1.42 |
| EVLEPSSR5427NC | 417 | 54 | 27 | 37.97 | 0.84 |
| EVLEPSSR5433NC | 477 | 54 | 33 | 46.41 | 1.03 |
| EVLEPSSR5439NC | 543 | 54 | 39 | 54.84 | 1.22 |
| EVLEPSSR5445NC | 638 | 54 | 45 | 63.28 | 1.41 |
| EVLEPSSR5451NC | 678 | 54 | 51 | 71.72 | 1.59 |

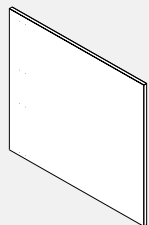

EVLEPSC-NC • Laminate Gallery Middle One Side Panel, No End Connection at Both Sides

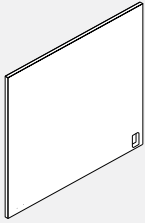

- Attaches in middle of panel run with connector with "U" channel
- To be installed in middle between two panels in straight run on one side
- Cut out for electrics at power beam height
- Finished in thermally fused laminate
- No connection both sides
- Laminate Gallery Panel height is inclusive of panel glides extended to their full height
- If wood grain is selected, grain runs horizontally
- End of run connector with "U" channel and bottom connecting brackets to be ordered separately

| PRODUCT CODE | PRICE LP | SIZE / INCHES | | WEIGHT LBS | VOL FT ³ |
|---------------|----------|---------------|----|------------|---------------------|
| | | H | W | | |
| EVLEPSC4227NC | 346 | 42 | 27 | 29.53 | 0.66 |
| EVLEPSC4233NC | 386 | 42 | 33 | 36.09 | 0.80 |
| EVLEPSC4239NC | 435 | 42 | 39 | 42.66 | 0.95 |
| EVLEPSC4245NC | 499 | 42 | 45 | 49.22 | 1.09 |
| EVLEPSC4251NC | 535 | 42 | 51 | 55.78 | 1.24 |
| EVLEPSC4827NC | 378 | 48 | 27 | 33.75 | 0.75 |
| EVLEPSC4833NC | 432 | 48 | 33 | 41.25 | 0.92 |
| EVLEPSC4839NC | 483 | 48 | 39 | 48.75 | 1.08 |
| EVLEPSC4845NC | 535 | 48 | 45 | 56.25 | 1.25 |
| EVLEPSC4851NC | 607 | 48 | 51 | 63.75 | 1.42 |
| EVLEPSC5427NC | 417 | 54 | 27 | 37.97 | 0.84 |
| EVLEPSC5433NC | 477 | 54 | 33 | 46.41 | 1.03 |
| EVLEPSC5439NC | 543 | 54 | 39 | 54.84 | 1.22 |
| EVLEPSC5445NC | 638 | 54 | 45 | 63.28 | 1.41 |
| EVLEPSC5451NC | 678 | 54 | 51 | 71.72 | 1.59 |

EVPBLEPDS • Laminate Gallery Panel for Power Beam, End Connection

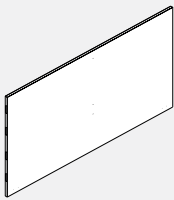

- Attaches to power beam channel
- To be installed at end of power beam run
- Finished in thermally fused laminate
- Locking connection both sides
- Laminate Gallery Panel height is inclusive of panel glides extended to their full height
- If wood grain is selected, grain runs horizontally
- Power beam channel and bottom connecting bracket to be ordered separately

| PRODUCT CODE | PRICE LP | SIZE / INCHES | | WEIGHT LBS | VOL FT ³ |
|---------------|----------|---------------|----|------------|---------------------|
| | | H | W | | |
| EVPBLEPDS4251 | 535 | 42 | 51 | 55.78 | 1.24 |
| EVPBLEPDS4263 | 695 | 42 | 63 | 68.91 | 1.53 |
| EVPBLEPDS4275 | 857 | 42 | 75 | 82.03 | 1.82 |
| EVPBLEPDS4851 | 607 | 48 | 51 | 63.75 | 1.42 |
| EVPBLEPDS4863 | 773 | 48 | 63 | 78.75 | 1.75 |
| EVPBLEPDS4875 | 937 | 48 | 75 | 93.75 | 2.08 |
| EVPBLEPDS5451 | 678 | 54 | 51 | 71.72 | 1.59 |
| EVPBLEPDS5463 | 885 | 54 | 63 | 88.59 | 1.97 |
| EVPBLEPDS5475 | 1023 | 54 | 75 | 105.47 | 2.34 |

EVPBLEPDC • Laminate Gallery Panel for Power Beam, Middle Connection

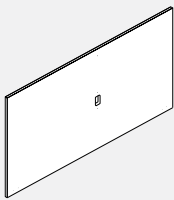

- Attaches to power beam channel
- To be installed in middle between two power beam in straight run
- Cut out for electrics at power beam height
- Finished in thermally fused laminate
- Locking connection both sides
- Laminate Gallery Panel height is inclusive of panel glides extended to their full height
- If wood grain is selected, grain runs horizontally
- Power beam channel and bottom connecting bracket to be ordered separately
- Standard code is for 24" H Power Beam
- Please add at code end "B" for 30"h Power Beam or "C" for 36"h Power Beam

| PRODUCT CODE | PRICE LP | SIZE / INCHES | | WEIGHT LBS | VOL FT ³ |
|---------------|----------|---------------|----|------------|---------------------|
| | | H | W | | |
| EVPBLEPDC4251 | 535 | 42 | 51 | 55.78 | 1.24 |
| EVPBLEPDC4263 | 695 | 42 | 63 | 68.91 | 1.53 |
| EVPBLEPDC4275 | 857 | 42 | 75 | 82.03 | 1.82 |
| EVPBLEPDC4851 | 607 | 48 | 51 | 63.75 | 1.42 |
| EVPBLEPDC4863 | 773 | 48 | 63 | 78.75 | 1.75 |
| EVPBLEPDC4875 | 937 | 48 | 75 | 93.75 | 2.08 |
| EVPBLEPDC5451 | 678 | 48 | 51 | 63.75 | 1.42 |
| EVPBLEPDC5463 | 885 | 48 | 63 | 78.75 | 1.75 |
| EVPBLEPDC5475 | 1023 | 48 | 75 | 93.75 | 2.08 |

EVPBLEPSSL/R • Laminate Gallery Panel for Power Beam, End Connection on One Side

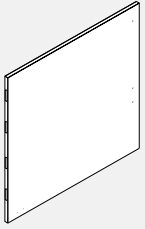

- Attaches to power beam channel
- To be installed at end of power beam run on one side
- Finished in thermally fused laminate
- Locking connection on one side
- Laminate Gallery Panel height is inclusive of panel glides extended to their full height
- If wood grain is selected, grain runs horizontally
- Power beam channel and bottom connecting bracket to be ordered separately

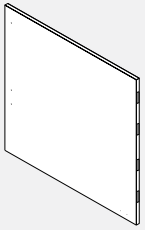

| PRODUCT CODE | PRICE LP | SIZE/INCHES | | WEIGHT LBS | VOL FT ³ |
|----------------|----------|-------------|----|------------|---------------------|
| | | H | W | | |
| EVPBLEPSSL4227 | 346 | 42 | 27 | 29.53 | 0.66 |
| EVPBLEPSSL4233 | 386 | 42 | 33 | 36.09 | 0.80 |
| EVPBLEPSSL4239 | 435 | 42 | 39 | 42.66 | 0.95 |
| EVPBLEPSSL4245 | 499 | 42 | 45 | 49.22 | 1.09 |
| EVPBLEPSSL4251 | 535 | 42 | 51 | 55.78 | 1.24 |
| EVPBLEPSSL4827 | 378 | 48 | 27 | 33.75 | 0.75 |
| EVPBLEPSSL4833 | 432 | 48 | 33 | 41.25 | 0.92 |
| EVPBLEPSSL4839 | 483 | 48 | 39 | 48.75 | 1.08 |
| EVPBLEPSSL4845 | 535 | 48 | 45 | 56.25 | 1.25 |
| EVPBLEPSSL4851 | 607 | 48 | 51 | 63.75 | 1.42 |
| EVPBLEPSSL5427 | 417 | 54 | 27 | 37.97 | 0.84 |
| EVPBLEPSSL5433 | 477 | 54 | 33 | 46.41 | 1.03 |
| EVPBLEPSSL5439 | 543 | 54 | 39 | 54.84 | 1.22 |
| EVPBLEPSSL5445 | 638 | 54 | 45 | 63.28 | 1.41 |
| EVPBLEPSSL5451 | 678 | 54 | 51 | 71.72 | 1.59 |
| EVPBLEPSSR4227 | 346 | 42 | 27 | 29.53 | 0.66 |
| EVPBLEPSSR4233 | 386 | 42 | 33 | 36.09 | 0.80 |
| EVPBLEPSSR4239 | 435 | 42 | 39 | 42.66 | 0.95 |
| EVPBLEPSSR4245 | 499 | 42 | 45 | 49.22 | 1.09 |
| EVPBLEPSSR4251 | 535 | 42 | 51 | 55.78 | 1.24 |
| EVPBLEPSSR4827 | 378 | 48 | 27 | 33.75 | 0.75 |
| EVPBLEPSSR4833 | 432 | 48 | 33 | 41.25 | 0.92 |
| EVPBLEPSSR4839 | 483 | 48 | 39 | 48.75 | 1.08 |
| EVPBLEPSSR4845 | 535 | 48 | 45 | 56.25 | 1.25 |
| EVPBLEPSSR4851 | 607 | 48 | 51 | 63.75 | 1.42 |
| EVPBLEPSSR5427 | 417 | 54 | 27 | 37.97 | 0.84 |
| EVPBLEPSSR5433 | 477 | 54 | 33 | 46.41 | 1.03 |
| EVPBLEPSSR5439 | 543 | 54 | 39 | 54.84 | 1.22 |
| EVPBLEPSSR5445 | 638 | 54 | 45 | 63.28 | 1.41 |
| EVPBLEPSSR5451 | 678 | 54 | 51 | 71.72 | 1.59 |

EVPBLEPSC • Laminate Gallery Panel for Power Beam, Middle Connection on One Side

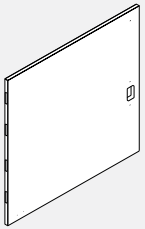

- Attaches to power beam channel
- To be installed in middle between two power beam in straight run on one side
- Cut out for electrics at power beam height
- Finished in thermally fused laminate
- Locking connection on one side
- Laminate Gallery Panel height is inclusive of panel glides extended to their full height
- If wood grain is selected, grain runs horizontally
- Power beam channel and bottom connecting bracket to be ordered separately
- Standard code is for 24" H Power Beam
- Please add at code end "B" for 30"h Power Beam or "C" for 36"h Power Beam

| PRODUCT CODE | PRICE LP | SIZE/INCHES | | WEIGHT LBS | VOL FT ³ |
|---------------|----------|-------------|----|------------|---------------------|
| | | H | W | | |
| EVPBLEPSC4227 | 346 | 42 | 27 | 29.53 | 0.66 |
| EVPBLEPSC4233 | 386 | 42 | 33 | 36.09 | 0.80 |
| EVPBLEPSC4239 | 435 | 42 | 39 | 42.66 | 0.95 |
| EVPBLEPSC4245 | 499 | 42 | 45 | 49.22 | 1.09 |
| EVPBLEPSC4251 | 535 | 42 | 51 | 55.78 | 1.24 |
| EVPBLEPSC4827 | 378 | 48 | 27 | 33.75 | 0.75 |
| EVPBLEPSC4833 | 432 | 48 | 33 | 41.25 | 0.92 |
| EVPBLEPSC4839 | 483 | 48 | 39 | 48.75 | 1.08 |
| EVPBLEPSC4845 | 535 | 48 | 45 | 56.25 | 1.25 |
| EVPBLEPSC4851 | 607 | 48 | 51 | 63.75 | 1.42 |
| EVPBLEPSC5427 | 417 | 54 | 27 | 37.97 | 0.84 |
| EVPBLEPSC5433 | 477 | 54 | 33 | 46.41 | 1.03 |
| EVPBLEPSC5439 | 543 | 54 | 39 | 54.84 | 1.22 |
| EVPBLEPSC5445 | 638 | 54 | 45 | 63.28 | 1.41 |
| EVPBLEPSC5451 | 678 | 54 | 51 | 71.72 | 1.59 |

EVPBLEPDS-NC • Laminate Gallery Panel for Power Beam, No End Connection

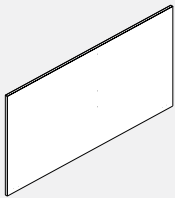

- Attaches to power beam channel
- To be installed at end of power beam run
- Finished in thermally fused laminate
- No connection both sides
- Laminate Gallery Panel height is inclusive of panel glides extended to their full height
- If wood grain is selected, grain runs horizontally
- Power beam channel and bottom connecting bracket to be ordered separately

| PRODUCT CODE | PRICE LP | SIZE/INCHES | | WEIGHT LBS | VOL FT ³ |
|-----------------|----------|-------------|----|------------|---------------------|
| | | H | W | | |
| EVPBLEPDS4251NC | 535 | 42 | 51 | 55.78 | 1.24 |
| EVPBLEPDS4263NC | 695 | 42 | 63 | 68.91 | 1.53 |
| EVPBLEPDS4275NC | 857 | 42 | 75 | 82.03 | 1.82 |
| EVPBLEPDS4851NC | 607 | 48 | 51 | 63.75 | 1.42 |
| EVPBLEPDS4863NC | 773 | 48 | 63 | 78.75 | 1.75 |
| EVPBLEPDS4875NC | 937 | 48 | 75 | 93.75 | 2.08 |
| EVPBLEPDS5451NC | 678 | 54 | 51 | 71.72 | 1.59 |
| EVPBLEPDS5463NC | 885 | 54 | 63 | 88.59 | 1.97 |
| EVPBLEPDS5475NC | 1023 | 54 | 75 | 105.47 | 2.34 |

EVPBLEPDC-NC • Laminate Gallery Middle Panel for Power Beam, No End Connection at Both Sides

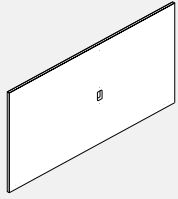

- Attaches to power beam channel
- To be installed in middle between two power beam in straight run
- Cut out for electrics at power beam height
- Finished in thermally fused laminate
- No connection both sides
- Laminate Gallery Panel height is inclusive of panel glides extended to their full height
- If wood grain is selected, grain runs horizontally
- Power beam channel and bottom connecting bracket to be ordered separately
- Standard code is for 24" H Power Beam
- Please add at code end "B" for 30"h Power Beam or "C" for 36"h Power Beam

| PRODUCT CODE | PRICE LP | SIZE/INCHES | | WEIGHT LBS | VOL FT ³ |
|-----------------|----------|-------------|----|------------|---------------------|
| | | H | W | | |
| EVPBLEPDC4251NC | 535 | 42 | 51 | 55.78 | 1.24 |
| EVPBLEPDC4263NC | 695 | 42 | 63 | 68.91 | 1.53 |
| EVPBLEPDC4275NC | 857 | 42 | 75 | 82.03 | 1.82 |
| EVPBLEPDC4851NC | 607 | 48 | 51 | 63.75 | 1.42 |
| EVPBLEPDC4863NC | 773 | 48 | 63 | 78.75 | 1.75 |
| EVPBLEPDC4875NC | 937 | 48 | 75 | 93.75 | 2.08 |
| EVPBLEPDC5451NC | 678 | 48 | 51 | 63.75 | 1.42 |
| EVPBLEPDC5463NC | 885 | 48 | 63 | 78.75 | 1.75 |
| EVPBLEPDC5475NC | 1023 | 48 | 75 | 93.75 | 2.08 |

EVPBLEPSS-NC • Laminate Gallery End Panel for Power Beam, No End Connection at Both Sides

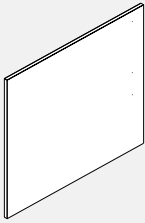

- Attaches to power beam channel
- To be installed at end of power beam run on one side
- Finished in thermally fused laminate
- No connection both sides
- Laminate Gallery Panel height is inclusive of panel glides extended to their full height
- If wood grain is selected, grain runs horizontally
- Power beam channel and bottom connecting bracket to be ordered separately

| PRODUCT CODE | PRICE LP | SIZE/INCHES | | WEIGHT LBS | VOL FT ³ |
|------------------|----------|-------------|----|------------|---------------------|
| | | H | W | | |
| EVPBLEPSSL4227NC | 346 | 42 | 27 | 29.53 | 0.66 |
| EVPBLEPSSL4233NC | 386 | 42 | 33 | 36.09 | 0.80 |
| EVPBLEPSSL4239NC | 435 | 42 | 39 | 42.66 | 0.95 |
| EVPBLEPSSL4245NC | 499 | 42 | 45 | 49.22 | 1.09 |
| EVPBLEPSSL4251NC | 535 | 42 | 51 | 55.78 | 1.24 |
| EVPBLEPSSL4827NC | 378 | 48 | 27 | 33.75 | 0.75 |
| EVPBLEPSSL4833NC | 432 | 48 | 33 | 41.25 | 0.92 |
| EVPBLEPSSL4839NC | 483 | 48 | 39 | 48.75 | 1.08 |
| EVPBLEPSSL4845NC | 535 | 48 | 45 | 56.25 | 1.25 |
| EVPBLEPSSL4851NC | 607 | 48 | 51 | 63.75 | 1.42 |
| EVPBLEPSSL5427NC | 417 | 54 | 27 | 37.97 | 0.84 |
| EVPBLEPSSL5433NC | 477 | 54 | 33 | 46.41 | 1.03 |
| EVPBLEPSSL5439NC | 543 | 54 | 39 | 54.84 | 1.22 |
| EVPBLEPSSL5445NC | 638 | 54 | 45 | 63.28 | 1.41 |
| EVPBLEPSSL5451NC | 678 | 54 | 51 | 71.72 | 1.59 |
| EVPBLEPSSR4227NC | 346 | 42 | 27 | 29.53 | 0.66 |
| EVPBLEPSSR4233NC | 386 | 42 | 33 | 36.09 | 0.80 |
| EVPBLEPSSR4239NC | 435 | 42 | 39 | 42.66 | 0.95 |
| EVPBLEPSSR4245NC | 499 | 42 | 45 | 49.22 | 1.09 |
| EVPBLEPSSR4251NC | 535 | 42 | 51 | 55.78 | 1.24 |
| EVPBLEPSSR4827NC | 378 | 48 | 27 | 33.75 | 0.75 |
| EVPBLEPSSR4833NC | 432 | 48 | 33 | 41.25 | 0.92 |
| EVPBLEPSSR4839NC | 483 | 48 | 39 | 48.75 | 1.08 |
| EVPBLEPSSR4845NC | 535 | 48 | 45 | 56.25 | 1.25 |
| EVPBLEPSSR4851NC | 607 | 48 | 51 | 63.75 | 1.42 |
| EVPBLEPSSR5427NC | 417 | 54 | 27 | 37.97 | 0.84 |
| EVPBLEPSSR5433NC | 477 | 54 | 33 | 46.41 | 1.03 |
| EVPBLEPSSR5439NC | 543 | 54 | 39 | 54.84 | 1.22 |
| EVPBLEPSSR5445NC | 638 | 54 | 45 | 63.28 | 1.41 |
| EVPBLEPSSR5451NC | 678 | 54 | 51 | 71.72 | 1.59 |

EVPBLEPSC-NC • Laminate Gallery Middle One Side Panel for Power Beam, No End Connection at Both Sides

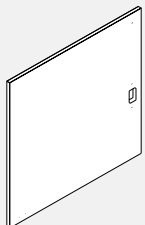

- Attaches to power beam channel
- To be installed in middle between two power beam in straight run on one side
- Cut out for electrics at power beam height
- Finished in thermally fused laminate
- No connection both sides
- Laminate Gallery Panel height is inclusive of panel glides extended to their full height
- If wood grain is selected, grain runs horizontally
- Power beam channel and bottom connecting bracket to be ordered separately
- Standard code is for 24" H Power Beam
- Please add at code end "B" for 30"h Power Beam or "C" for 36"h Power Beam

| PRODUCT CODE | PRICE LP | SIZE/INCHES | | WEIGHT LBS | VOL FT ³ |
|-----------------|----------|-------------|----|------------|---------------------|
| | | H | W | | |
| EVPBLEPSC4227NC | 346 | 42 | 27 | 29.53 | 0.66 |
| EVPBLEPSC4233NC | 386 | 42 | 33 | 36.09 | 0.80 |
| EVPBLEPSC4239NC | 435 | 42 | 39 | 42.66 | 0.95 |
| EVPBLEPSC4245NC | 499 | 42 | 45 | 49.22 | 1.09 |
| EVPBLEPSC4251NC | 535 | 42 | 51 | 55.78 | 1.24 |
| EVPBLEPSC4827NC | 378 | 48 | 27 | 33.75 | 0.75 |
| EVPBLEPSC4833NC | 432 | 48 | 33 | 41.25 | 0.92 |
| EVPBLEPSC4839NC | 483 | 48 | 39 | 48.75 | 1.08 |
| EVPBLEPSC4845NC | 535 | 48 | 45 | 56.25 | 1.25 |
| EVPBLEPSC4851NC | 607 | 48 | 51 | 63.75 | 1.42 |
| EVPBLEPSC5427NC | 417 | 54 | 27 | 37.97 | 0.84 |
| EVPBLEPSC5433NC | 477 | 54 | 33 | 46.41 | 1.03 |
| EVPBLEPSC5439NC | 543 | 54 | 39 | 54.84 | 1.22 |
| EVPBLEPSC5445NC | 638 | 54 | 45 | 63.28 | 1.41 |
| EVPBLEPSC5451NC | 678 | 54 | 51 | 71.72 | 1.59 |

EVHLPBB01 • Laminate Panel Bracket

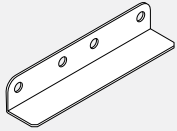

- Laminate panel bottom bracket connects two laminate end panels at bottom with screws
- Available in standard paint colors
- Bracket and screws included

| PRODUCT CODE | PRICE | SIZE/INCHES | | | WEIGHT LBS | VOL FT ³ |
|--------------|-------|-------------|---|---|------------|---------------------|
| | | H | W | D | | |
| EVHLPBB01 | 35 | 1.5 | 8 | 1 | 0.50 | 0.11 |

EVHLPB01 • Laminate Panel Corner Bracket

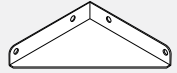

- Laminate panel corner bottom bracket connects two laminate panels at 90 degree
- Available in standard paint colors
- Bracket and screws included

| PRODUCT CODE | PRICE | SIZE/INCHES | | | WEIGHT LBS | VOL FT ³ |
|--------------|-------|-------------|---|---|------------|---------------------|
| | | H | W | D | | |
| EVHLPB01 | 34 | 1.5 | 4 | 4 | 0.50 | 0.11 |

EVPERCH • Connector with U Channel



- U channel attaches with screws to laminate end panel or laminate middle panel
- Evolve panels attaches to connector
- Pass thru at bottom and beltline location for power/data
- U channel is welded to connector
- Includes connector with U channel and hardware

| PRODUCT CODE | PRICE | SIZE/INCHES | | WEIGHT LBS | VOL FT ³ |
|--------------|-------|-------------|-------|------------|---------------------|
| | | H | W | | |
| EVPERCH42 | 133 | 42 | 2.875 | 4.60 | 0.14 |
| EVPERCH48 | 140 | 48 | 2.875 | 5.09 | 0.18 |
| EVPERCH54 | 151 | 54 | 2.875 | 6.75 | 0.22 |

EVPBIECH • Power Beam Channel



- One piece channel for power beam and extension module above, attaches to laminate panels with screws
- Power beam attaches to channel with clamps and extension module attaches above
- Channel has cut out for power beam electrics to run thru laminate panel

Note

- It is not stackable.
- It can not be stacked with standard extension connector above it.

| PRODUCT CODE | PRICE | SIZE/INCHES | | WEIGHT LBS | VOL FT ³ |
|--------------|-------|-------------|-------|------------|---------------------|
| | | H | W | | |
| EVPBIECH12 | 38 | 12 | 2.875 | 1.32 | 0.12 |
| EVPBIECH18 | 42 | 18 | 2.875 | 1.94 | 0.18 |
| EVPBIECH24 | 53 | 24 | 2.875 | 2.60 | 0.24 |
| EVPBIECH30 | 56 | 30 | 2.875 | 3.30 | 0.30 |
| EVPBIECH36 | 61 | 36 | 2.875 | 4.60 | 0.36 |

EVSL12 • Laminated Shelf for Reception Panels

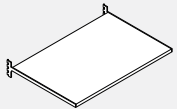

- Laminated Wood Shelf Panel Mounted
- Shelf thickness 1"
- Available in LP
- Includes attachment hardware

| PRODUCT CODE | PRICE | SIZE/INCHES | | | WEIGHT LBS | VOL FT ³ |
|--------------|-------|-------------|----|----|------------|---------------------|
| | | H | W | D | | |
| EVSL1218 | 197 | 1.125 | 18 | 12 | 4.98 | 0.13 |
| EVSL1224 | 212 | 1.125 | 24 | 12 | 6.64 | 0.17 |
| EVSL1230 | 226 | 1.125 | 30 | 12 | 8.3 | 0.21 |
| EVSL1236 | 239 | 1.125 | 36 | 12 | 9.96 | 0.25 |
| EVSL1242 | 253 | 1.125 | 42 | 12 | 11.63 | 0.29 |
| EVSL1248 | 268 | 1.125 | 48 | 12 | 13.29 | 0.33 |

EVPTTAU • Connector with U Channel Top Trim Aluminum

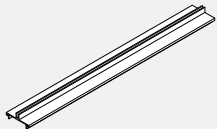

- Aluminum top trim longer by 0.625" to cover width of connector with U channel
- Trim can not span a post
- Available in standard paint colors

| PRODUCT CODE | PRICE | SIZE/INCHES | | WEIGHT LBS | VOL FT ³ |
|--------------|-------|-------------|------|------------|---------------------|
| | | W | D | | |
| EVPTTAU24 | 19 | 24.625 | 0.19 | 0.04 | |
| EVPTTAU30 | 24 | 30.625 | 0.24 | 0.05 | |
| EVPTTAU36 | 27 | 36.625 | 0.28 | 0.06 | |
| EVPTTAU42 | 30 | 42.625 | 0.33 | 0.07 | |
| EVPTTAU48 | 35 | 48.625 | 0.37 | 0.08 | |
| EVPTTAU54 | 38 | 54.625 | 0.42 | 0.09 | |
| EVPTTAU60 | 46 | 60.625 | 0.46 | 0.10 | |
| EVPTTAU66 | 48 | 66.625 | 0.51 | 0.11 | |
| EVPTTAU72 | 49 | 72.625 | 0.56 | 0.12 | |
| EVPTTAU78 | 57 | 78.625 | 0.60 | 0.13 | |
| EVPTTAU84 | 60 | 84.625 | 0.65 | 0.14 | |

EVPTTA • Aluminum Top Trim for Double Inline Connector (for use with laminate end and middle panels)

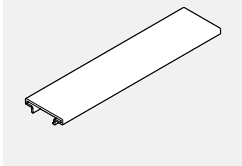

- Used for panels in middle of run of panels with Double Inline Connector.
- Aluminum Top Trim covers panel and one Double Inline Connector.
- Available in standard paint colours.
- Note: Trim can not span a Post Connector.

| PRODUCT CODE | PRICE | SIZE/ | INCHES | | WEIGHT VOL | |
|--------------|-------|-------|--------|------|-----------------|--|
| | | | W | LBS | FT ³ | |
| EVPTTA25 | 19 | | 25.125 | 0.19 | 0.04 | |
| EVPTTA31 | 24 | | 31.125 | 0.24 | 0.05 | |
| EVPTTA37 | 27 | | 37.125 | 0.28 | 0.06 | |
| EVPTTA43 | 30 | | 43.125 | 0.33 | 0.07 | |
| EVPTTA49 | 35 | | 49.125 | 0.37 | 0.08 | |
| EVPTTA55 | 38 | | 55.125 | 0.42 | 0.09 | |
| EVPTTA61 | 46 | | 61.125 | 0.46 | 0.10 | |
| EVPTTA67 | 48 | | 67.125 | 0.51 | 0.11 | |
| EVPTTA73 | 49 | | 73.125 | 0.56 | 0.12 | |
| EVPTTA79 | 57 | | 79.125 | 0.60 | 0.13 | |
| EVPTTA85 | 60 | | 83.125 | 0.65 | 0.14 | |

EVPTTA • Aluminum Top Trim for Double Inline Connector (for use with laminate end and middle panels)

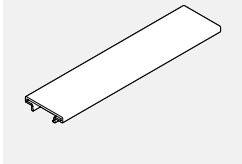

- Used for panels next to end of run trim in run of panels with Double Inline Connector.
- Available in standard paint colours.
- Note: Trim can not span a Post Connector.

| PRODUCT CODE | PRICE | SIZE/ | INCHES | | WEIGHT VOL | |
|--------------|-------|-------|--------|------|-----------------|--|
| | | | W | LBS | FT ³ | |
| EVPTTA24 | 16 | | 24 | 0.22 | 0.04 | |
| EVPTTA30 | 23 | | 30 | 0.29 | 0.05 | |
| EVPTTA36 | 25 | | 36 | 0.30 | 0.06 | |
| EVPTTA42 | 29 | | 42 | 0.34 | 0.07 | |
| EVPTTA48 | 34 | | 48 | 0.38 | 0.08 | |
| EVPTTA54 | 37 | | 54 | 0.42 | 0.09 | |
| EVPTTA60 | 43 | | 60 | 0.46 | 0.10 | |
| EVPTTA66 | 46 | | 66 | 0.50 | 0.11 | |
| EVPTTA72 | 48 | | 72 | 0.55 | 0.12 | |
| EVPTTA78 | 56 | | 78 | 0.59 | 0.12 | |
| EVPTTA84 | 60 | | 84 | 0.64 | 0.13 | |

EVPGDCP • Gallery panel data post

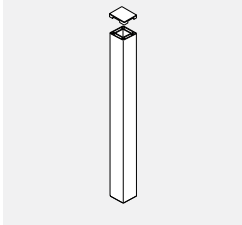

- One way post attaches to Gallery Panel at the end to bring power and/or data cables from ceiling to Evolve panels.
- Accommodates up to 25 CAT 5 cables with electric. Accommodates up to 45 CAT 5 cables without electric.
- Middle Gallery panel with bottom cut out for electrics must be ordered.
- Standard data post extension used above.
- Standard data post extension to be ordered separately.
- Choose standard paint finish.

| PRODUCT CODE | PRICE | SIZE/ | INCHES | | WEIGHT VOL | |
|--------------|-------|-------|--------|---|------------|-----------------|
| | | | H | W | LBS | FT ³ |
| EVPGDCP42 | 176 | 42 | 3 | | | |
| EVPGDCP48 | 208 | 48 | 3 | | | |
| EVPGDCP54 | 227 | 54 | 3 | | | |

EVPMP-GI6W • Privacy Glass for 1" Laminate Panels

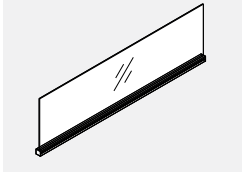

- Privacy glass integrated with aluminum trim.
- Attaches on top of 1" laminate panels to add privacy or divide space.
- Includes aluminum trim with end caps and glass tile.
- Aluminum trim has rail for accessories.
- Standard in clear (CLR), frosted (FRST) or writeable (WRW) glass.
- Glass and attachment hardware to ship separately.

| PRODUCT CODE | PRICE | | | SIZE/INCHES | | | WEIGHT VOL | |
|--------------|-------|------|-----|-------------|----|---|------------|-----------------|
| | CL` | FRST | WRW | H | W | D | LBS | FT ³ |
| EVPMP24GI6W | 201 | 251 | - | 6 | 24 | 1 | 2.39 | 0.25 |
| EVPMP30GI6W | 219 | 276 | - | 6 | 30 | 1 | 2.99 | 0.32 |
| EVPMP36GI6W | 235 | 291 | - | 6 | 36 | 1 | 3.58 | 0.37 |
| EVPMP42GI6W | 251 | 313 | - | 6 | 42 | 1 | 4.18 | 0.43 |
| EVPMP48GI6W | 262 | 327 | - | 6 | 48 | 1 | 4.78 | 0.50 |
| EVPMP24GI9W | 201 | 251 | - | 9 | 24 | 1 | 3.58 | 0.25 |
| EVPMP30GI9W | 219 | 276 | - | 9 | 30 | 1 | 4.48 | 0.32 |
| EVPMP36GI9W | 235 | 291 | - | 9 | 36 | 1 | 5.37 | 0.37 |
| EVPMP42GI9W | 251 | 313 | - | 9 | 42 | 1 | 6.26 | 0.43 |
| EVPMP48GI9W | 262 | 327 | - | 9 | 48 | 1 | 7.16 | 0.50 |
| EVPMP24GIW | 201 | 251 | 350 | 12 | 24 | 1 | 4.77 | 0.50 |
| EVPMP30GIW | 219 | 276 | 357 | 12 | 30 | 1 | 5.97 | 0.63 |
| EVPMP36GIW | 235 | 291 | 364 | 12 | 36 | 1 | 7.16 | 0.75 |
| EVPMP42GIW | 251 | 313 | 401 | 12 | 42 | 1 | 8.35 | 0.87 |
| EVPMP48GIW | 262 | 327 | 439 | 12 | 48 | 1 | 9.55 | 1.00 |

EVPFDW • Felt divider for 1" Laminate Panels

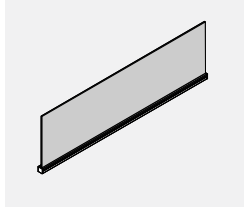

- Privacy Felt Divider integrated with aluminum top trim. Attaches on top of laminate panels to add privacy or divide space.
- Includes aluminum trim with channel and felt tile.
- Felt and attachment hardware to ship separately.
- 9 mm felt material is tackable and comes in 18 different colors. Please specify felt finish.
- Aluminum top trim available in standard paint finishes.

| PRODUCT CODE | PRICE | SIZE/INCHES | | | WEIGHT VOL | |
|--------------|-------|-------------|----|---|------------|-----------------|
| | | H | W | D | LBS | FT ³ |
| EVPFD0624W | 72 | 6 | 24 | 1 | 1.42 | 0.26 |
| EVPFD0630W | 88 | 6 | 30 | 1 | 1.73 | 0.32 |
| EVPFD0636W | 102 | 6 | 36 | 1 | 2.03 | 0.37 |
| EVPFD0642W | 114 | 6 | 42 | 1 | 2.34 | 0.43 |
| EVPFD0648W | 170 | 6 | 48 | 1 | 2.64 | 0.50 |
| EVPFD0654W | 183 | 6 | 54 | 1 | 2.95 | 0.56 |
| EVPFD0660W | 199 | 6 | 60 | 1 | 3.25 | 0.63 |
| EVPFD0666W | 210 | 6 | 66 | 1 | 3.56 | 0.69 |
| EVPFD0672W | 238 | 6 | 72 | 1 | 3.86 | 0.76 |
| EVPFD0924W | 72 | 9 | 24 | 1 | 1.63 | 0.38 |
| EVPFD0930W | 88 | 9 | 30 | 1 | 1.99 | 0.47 |
| EVPFD0936W | 102 | 9 | 36 | 1 | 2.35 | 0.56 |
| EVPFD0942W | 114 | 9 | 42 | 1 | 2.70 | 0.65 |
| EVPFD0948W | 170 | 9 | 48 | 1 | 3.06 | 0.75 |
| EVPFD0954W | 183 | 9 | 54 | 1 | 3.42 | 0.84 |
| EVPFD0960W | 199 | 9 | 60 | 1 | 3.78 | 0.94 |
| EVPFD0966W | 210 | 9 | 66 | 1 | 4.13 | 1.04 |
| EVPFD0972W | 238 | 9 | 72 | 1 | 4.49 | 1.13 |
| EVPFD1224W | 72 | 12 | 24 | 1 | 1.84 | 0.50 |
| EVPFD1230W | 88 | 12 | 30 | 1 | 2.25 | 0.63 |
| EVPFD1236W | 102 | 12 | 36 | 1 | 2.66 | 0.75 |
| EVPFD1242W | 114 | 12 | 42 | 1 | 3.07 | 0.87 |
| EVPFD1248W | 170 | 12 | 48 | 1 | 3.48 | 1.00 |
| EVPFD1254W | 183 | 12 | 54 | 1 | 3.89 | 1.12 |
| EVPFD1260W | 199 | 12 | 60 | 1 | 4.30 | 1.25 |
| EVPFD1266W | 210 | 12 | 66 | 1 | 5.12 | 1.38 |
| EVPFD1272W | 238 | 12 | 72 | 1 | 5.53 | 1.51 |
| EVPFD1824W | 92 | 18 | 24 | 1 | 2.26 | 0.75 |
| EVPFD1830W | 108 | 18 | 30 | 1 | 2.77 | 0.94 |
| EVPFD1836W | 128 | 18 | 36 | 1 | 3.29 | 1.13 |
| EVPFD1842W | 143 | 18 | 42 | 1 | 3.80 | 1.31 |
| EVPFD1848W | 212 | 18 | 48 | 1 | 4.32 | 1.50 |
| EVPFD1854W | 231 | 18 | 54 | 1 | 4.83 | 1.69 |
| EVPFD1860W | 248 | 18 | 60 | 1 | 5.35 | 1.88 |
| EVPFD1866W | 262 | 18 | 66 | 1 | 6.68 | 2.06 |
| EVPFD1872W | 298 | 18 | 72 | 1 | 7.20 | 2.25 |

EVPDIC • Double Inline Panel Connector (for use with Laminate Middle Panels)

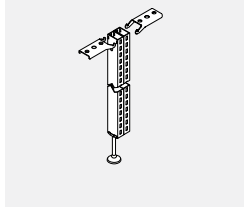

- Used to connect Laminate Middle Panel to panels of equal height in straight run.
- Aluminum Top Trim for Double Inline Connector must be used.
- Provides slotted support for worksurfaces and hang on storage compartments. Includes two slotted post with levelling glide and connection hardware.
- Connectors available without clots as special at no charge. Contact Customer Service.

| PRODUCT CODE | PRICE | SIZE/ INCHES | | WEIGHT VOL | |
|--------------|-------|--------------|---|------------|-----------------|
| | | H | W | LBS | FT ³ |
| EVPDIC42 | 136 | 42 | 2 | 9.20 | 0.14 |
| EVPDIC48 | 144 | 48 | 2 | 10.50 | 0.14 |

EVPDVTF • Double Connector Trim (for use with Laminate Middle Panels)

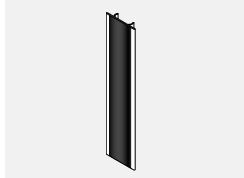

- Attaches to exposed side of double Inline Connector
- Must be ordered separately when Laminate Middle Panel is attached only to one side of Double Inline Connector.

| PRODUCT CODE | PRICE | SIZE/ INCHES | | WEIGHT VOL | |
|--------------|-------|--------------|---|------------|-----------------|
| | | H | W | LBS | FT ³ |
| EVPDVTF42 | 13 | 42 | 2 | 0.52 | 0.07 |
| EVPDVTF48 | 21 | 48 | 2 | 0.75 | 0.09 |

Technical Information for 9300 Series Pedestals

General Information:

9300 Series Pedestals feature center pull handles (models ending in "C") and full pull handles (models ending in "P"). Freestanding, mobile, and worksurface supporting options available. Quality steel construction. File drawers hold letter or A4 front to back and legal side to side configurations. Products are finished in a highly durable dry epoxy powder coating and drawer body interiors are finished with 100% recycled paint. Counterweights are included in freestanding and mobile pedestals to meet applicable ANSI/BIFMA X5.9.

Features:

- Cold rolled steel construction consisting of 16 ga front and back base with 22 ga case
- Reinforced welded construction
- Inset drawer fronts and flush base
- Double wall construction on all drawer fronts
- Full extension ball bearing slides on file drawers and $\frac{3}{4}$ extension on box drawers
- Rubber bumpers on slides for quietness
- Worksurface supporting option available (includes mounting holes at top of unit)
- 1 pencil tray and 1 drawer divider are included with each unit containing a box drawer
- Each file drawer includes a hanging file bar
- Levelers provide 1" height adjustment
- Counterweights included for freestanding and mobile pedestals
- Includes lock with 2 keys
- Lock is located at the top right of the case above the top drawer
- Keyed alike option available and can be keyed alike to other storage components

Technical Information for Prime Series

General Information:

Prime premium filing and storage products pre-configured to suit your needs; featuring fixed front or receding doors with full pull handles and fully welded seamless tops to deliver strength and clean aesthetics. Premium quality steel construction. File drawers accommodate legal, letter or A4 sizes in back-to-front and side-to-side configurations. Products are finished in a highly durable dry epoxy powder coating and drawer body interiors are finished with 100% recycled paint.

Counterweights are recommended for use in all laterals, pedestals and freestanding files of all widths and heights to meet applicable ANSI/BIFMA X5.9. (Counterweights are offered as an option on all products where required to meet applicable ANSI/BIFMA standard)

Features

- Premium steel construction, 18-22 gauge steel components
- Full welded and reinforced case construction
- Interlock system allows only one drawer to open at a time for safety
- Most products feature full overlay fronts, with some exceptions such as units with receding doors where the front is inset in the case
- Double wall construction on all drawer and door fronts
- Full extension roller bearing glides on all drawers
- Anti-bounce-back safety feature prevents drawers from sliding open
- Receding doors slide into the cabinet and allow the shelf to be pulled out
- All pedestals are equipped with four levelling glides, providing 1.5" of height adjustment
- All other units equipped with four levelling glides providing 1" height adjustment and can be accessed from the interior of the cabinets for ease of adjustment
- On units with drawers and hinged doors, locks are located at the center of the case above the top opening
- Lock position on towers with wardrobes is below the handle when center pull is selected
- Each lock includes 2 keys; locks are standard with removable cores
- Key assignment is random or can be specified for specific key number for key alike applications

Overhead Storage:

- Overhead cabinets - 7 widths in 6" increments
- 14 5/8" high cases with interior clear height of 12"
- 13" deep units have interior clear dimension of 12.7"
- 16" deep units have interior clear dimension of 15.7"
- Open shelves - 7 widths in 6" increments
- Shelves are 12 1/2" deep with 7 1/2" high side gables

Sizes:

- 15" width
- 19", 23", 29" depths
- Interior drawer depths:

19" Deep pedestals
17 1/4" deep box drawers
16 1/16" deep file drawers

23" deep pedestals
20 3/16" deep box drawers
19 7/16" deep file drawers

29" deep pedestals
26 5/16" deep box drawers
26 1/16" deep file drawers

Drawer Heights:

Box drawer fronts are 6"H with 5" interior height
File drawer fronts are 12"H with 10 9/16" interior height

Pedestals:

- Freestanding and worksurface supporting options available
- Worksurface supporting includes mounting holes at top of unit
- 1 pencil tray and 1 drawer divider are included with each unit containing a box drawer
- File drawers hold legal, letter or A4 sizes in back-to-front and side-to-side configurations
- Each file drawer includes a hanging file bar and conversion rails
- Freestanding units BSPF can be specified with optional non-locking casters to convert to a mobile unit
- 15" width x 18", 22", 28" depths

Interior drawer depth is as follows:

- 15" deep drawers for 18" deep pedestals
- 19" deep drawers for 22" deep pedestals
- 25" deep drawers for 28" deep pedestals

File drawer capacity:

- 14 3/8" filing capacity for file drawers in 18" pedestal
- 18 3/8" filing capacity for file drawers in 22" pedestal
- 24 3/8" filing capacity for file drawers in 28" pedestal

Laterals:

- 18" depth with interior depth of 16"
- 30", 36", 42" widths
- Available in 2 to 6 drawer high (28"h - 77.6"h)

File Drawer Capacity:

- 30" wide units
- Letter & legal side-to-side = 26 5/8"
 - Letter front-to-back = 30 1/2"
 - Legal front-to-back = 15 1/4" + 10" side space
- 36" wide units
- Letter & legal side-to-side = 32 5/8"
 - Letter front-to-back = 30 1/2" + 6 1/2" side space
 - Legal front-to-back = 30 1/2"
- 42" wide units
- Letter & legal side-to-side = 58 5/8"
 - Letter front-to-back = 45 3/4"
 - Legal front-to-back = 30 1/2" + 6 1/2" side space

Technical Information for Prime Series

Storage Cabinets:

- 18" depth
- 30", 36", 42" widths
- Available in 2 to 5 high configurations (28"h – 65.6"h)

Towers:

- Include coat rod and shelf to accommodate personal items
- The top of the storage compartment is perforated for ventilation
- Includes locks with 2 keys each
 - Closed storage comes with 3 locks – one of the drawers, one for the cupboard, and one for the wardrobe
 - Side open storage comes with 2 locks – one of the drawers and one for the ward-

robe

- 24" depth
- 24" width
- 50", 54", and 66" nominal heights available to coordinate with Global's panel systems

STORAGE COMPONENTS - GUIDELINES FOR ORDERING PRODUCT

Codes

The price list uses a numbering system with meaningful alphanumeric characters to create a simple-to-understand product number. This makes specifying the product much easier and more accurate.

How to Specify

- Specify storage pedestal type and size by code, including depth.
- Specify metal color (eg. BLK for Black)
- Specify key random, key list provided, or key number (eg. 401)
- Specify worksurface supporting (1 = Yes, 2 = No)
- Specify counterweight if pedestal is not worksurface supporting (NN = No Counterweight)

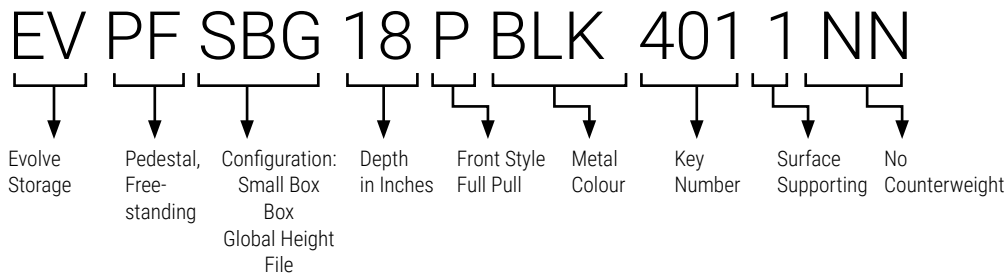

EVSLs • Low Profile Shelf

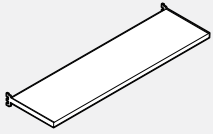

- Laminated Wood Shelf Panel Mounted
- Shelf thickness 1.125".
- Available in LP only.
- Includes attachment hardware.

| PRODUCT CODE | PRICE | SIZE/ INCHES | | | WEIGHT VOL | |
|--------------|-------|--------------|----|-----|------------|-----------------|
| | | H | W | D | LBS | FT ³ |
| EVSLs0818 | 210 | 1.125 | 18 | 8.5 | 3.98 | 0.09 |
| EVSLs0824 | 229 | 1.125 | 24 | 8.5 | 5.31 | 0.12 |
| EVSLs0830 | 248 | 1.125 | 30 | 8.5 | 6.64 | 0.15 |
| EVSLs0836 | 264 | 1.125 | 36 | 8.5 | 7.97 | 0.18 |
| EVSLs0842 | 284 | 1.125 | 42 | 8.5 | 9.30 | 0.21 |
| EVSLs0848 | 301 | 1.125 | 48 | 8.5 | 10.63 | 0.24 |

EVKSS • Panel Mount Shelf

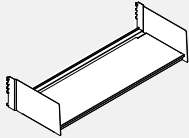

- 14" deep panel mounted storage shelf with backlip.
- Mounting brackets are included.

| PRODUCT CODE | PRICE | SIZE/ INCHES | | | WEIGHT VOL | |
|--------------|-------|--------------|-------|-------|------------|-----------------|
| | | H | W | D | LBS | FT ³ |
| EVKSS24 | 220 | 7.45 | 23.44 | 14.73 | 12.8 | 1.5 |
| EVKSS30 | 229 | 7.45 | 29.44 | 14.73 | 14.8 | 1.9 |
| EVKSS36 | 244 | 7.45 | 35.44 | 14.73 | 16.8 | 2.3 |
| EVKSS42 | 254 | 7.45 | 41.44 | 14.73 | 18.8 | 2.6 |
| EVKSS48 | 259 | 7.45 | 47.44 | 14.73 | 20.8 | 3.0 |
| EVKSS54 | 293 | 7.45 | 53.44 | 14.73 | 22.8 | 3.4 |
| EVKSS60 | 322 | 7.45 | 59.44 | 14.73 | 24.8 | 3.8 |

EVLSF • Flush Front Overhead Cabinet

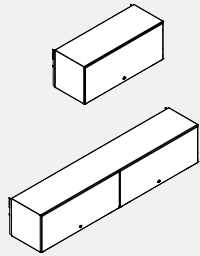

Cabinets 54" and 60" wide come with two doors

- Flush Front Overhead Cabinet is panel mounted lockable storage unit.
- The door retracts inside/within the overhead cabinet.
- Locks can be keyed alike to match other lockable storage components or keyed random to provide a dedicated lock.
- Available in 13" and 16" depths, 24" to 60" widths at 6" increments.
- Cabinets 54" and 60" wide come with two doors.
- Includes mounting hardware as specified, lock and keys.
- Lock secures into bottom shelf.
- Can be mounted at any height, however 66"h panels are recommended.
- Shipped assembled.

| PRODUCT CODE | PRICE | SIZE/ INCHES | | | WEIGHT VOL | |
|--------------|-------|--------------|-------|------|------------|-----------------|
| | | H | W | D | LBS | FT ³ |
| EVLSF1324MN | 869 | 14.62 | 23.87 | 13.5 | 39.30 | 2.7 |
| EVLSF1330MN | 947 | 14.62 | 29.87 | 13.5 | 44.3 | 3.4 |
| EVLSF1336MN | 1044 | 14.62 | 35.87 | 13.5 | 49.3 | 4.1 |
| EVLSF1342MN | 1147 | 14.62 | 41.87 | 13.5 | 54.3 | 4.8 |
| EVLSF1348MN | 1244 | 14.62 | 47.87 | 13.5 | 59.3 | 5.5 |
| EVLSF1354MN | 1324 | 14.62 | 53.87 | 13.5 | 64.3 | 6.2 |
| EVLSF1360MN | 1449 | 14.62 | 59.87 | 13.5 | 69.3 | 6.8 |
| EVLSF1624MN | 966 | 14.62 | 23.87 | 16.5 | 38.6 | 3.4 |
| EVLSF1630MN | 1044 | 14.62 | 29.87 | 16.5 | 43.9 | 4.2 |
| EVLSF1636MN | 1147 | 14.62 | 35.87 | 16.5 | 49.2 | 5.0 |
| EVLSF1642MN | 1244 | 14.62 | 41.87 | 16.5 | 54.5 | 5.8 |
| EVLSF1648MN | 1342 | 14.62 | 47.87 | 16.5 | 59.8 | 6.7 |
| EVLSF1654MN | 1449 | 14.62 | 53.87 | 16.5 | 65.1 | 7.5 |
| EVLSF1660MN | 1547 | 14.62 | 59.87 | 16.5 | 70.4 | 8.4 |

EVADA-PM • Easy-Up Panel Mounted Overhead Storage Unit - AODA Compliant

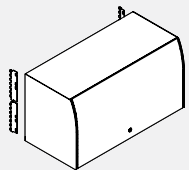

- Meets CSA B651 Barrier Free Design & AODA (Accessibility for Ontarians with Disabilities Act).
- 16" high units accept standard and A4 binders.
- All shelves are reinforced for proper weight distribution.
- Inside dimensions: 14.25" high x 13.4" deep.
- Unit includes attachment hardware, lock and mounting brackets. Back not included.
- Not recommended for use with wall rails.
- Shipped partially assembled.
- Unit can be converted to an Up-Mount Overhead Storage in the field by adding EVADA-KIT.

| PRODUCT CODE | PRICE | SIZE/ INCHES | | | WEIGHT VOL | |
|--------------|-------|--------------|----|------|------------|-----------------|
| | | H | W | D | LBS | FT ³ |
| EVADA30PM | 839 | 16 | 30 | 14.2 | 27.00 | 5.30 |
| EVADA36PM | 906 | 16 | 36 | 14.2 | 32.00 | 6.30 |
| EVADA42PM | 970 | 16 | 42 | 14.2 | 37.00 | 7.30 |
| EVADA48PM | 1037 | 16 | 48 | 14.2 | 42.00 | 8.30 |
| EVADA54PM | 1101 | 16 | 54 | 14.2 | 47.00 | 9.30 |
| EVADA60PM | 1167 | 16 | 60 | 14.2 | 53.00 | 10.30 |

With opaque acrylic door. The mechanism lifts the door up and stores it out of the way, above the storage unit.

EVADAPMKIT • Panel Mount Conversion Kit



- Converts an existing Up-Mount Overhead Storage Unit EVADA-UM to a Panel Mounted Overhead Storage Unit EVADA-PM.
- Kit includes panel mounting brackets.

| PRODUCT CODE | PRICE | SIZE/ INCHES | | | WEIGHT VOL | |
|--------------|-------|--------------|-----|---|------------|-----------------|
| | | H | W | D | LBS | FT ³ |
| EVADAPMKIT | 40 | 16 | 0.5 | 2 | 2.00 | 0.01 |

EVADA-UM • Easy-Up Up-Mount Overhead Storage Unit - AODA Compliant

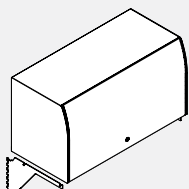

- Meets CSA B651 Barrier Free Design & AODA (Accessibility for Ontarians with Disabilities Act).
- 16" high units accept standard and A4 binders.
- All shelves are reinforced for proper weight distribution.
- Inside dimensions: 14.25" high x 13.4" deep.
- Unit includes attachment hardware, lock, mounting cantilevers and has a finished back.
- Unit can be converted to an Panel Mounted Overhead Storage Unit in the field by adding EVADAPM-KIT.
- Shipped partially assembled.

| PRODUCT CODE | PRICE | SIZE/ INCHES | | | WEIGHT VOL | |
|--------------|-------|--------------|----|------|------------|-----------------|
| | | H | W | D | LBS | FT ³ |
| EVADA30UM | 999 | 16 | 30 | 14.2 | 33.00 | 5.30 |
| EVADA36UM | 1046 | 16 | 36 | 14.2 | 40.00 | 6.30 |
| EVADA42UM | 1105 | 16 | 42 | 14.2 | 46.00 | 7.30 |
| EVADA48UM | 1166 | 16 | 48 | 14.2 | 53.00 | 8.30 |
| EVADA54UM | 1222 | 16 | 54 | 14.2 | 59.00 | 9.30 |
| EVADA60UM | 1293 | 16 | 60 | 14.2 | 66.00 | 10.30 |

Up-mounted storage can reduce furniture costs by reducing the height of all panels to 54". Complete 54" panel installations simplify cable routing at one level, below the top cap. Up-mounted cantilevers maintain accessibility and functionality of the panels' top lay-in channel below the top cap.

EVADA-KIT • Up-Mount Conversion Kit

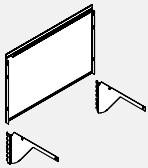

- Converts an existing Panel Mounted Overhead Storage Unit EVADA-PM to an Up-Mounted Overhead Storage Unit EVADA-UM.
- When used on a 54" high panel, the top of the overhead can match the height of 66" high panels.
- Kit includes a back panel for the Overhead and Up-Mount Cantilevers.

| PRODUCT CODE | PRICE | SIZE/ INCHES | | | WEIGHT VOL | |
|--------------|-------|--------------|----|---|------------|-----------------|
| | | H | W | D | LBS | FT ³ |
| EVADA30KIT | 201 | 16 | 30 | 2 | 8.00 | 0.60 |
| EVADA36KIT | 210 | 16 | 36 | 2 | 10.00 | 0.70 |
| EVADA42KIT | 225 | 16 | 42 | 2 | 11.00 | 0.80 |
| EVADA48KIT | 235 | 16 | 48 | 2 | 13.00 | 0.90 |
| EVADA54KIT | 247 | 16 | 54 | 2 | 14.00 | 1.00 |
| EVADA60KIT | 261 | 16 | 60 | 2 | 15.00 | 1.10 |

EVSDAOHL36 • Dual Access Overhead Left

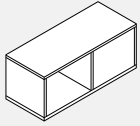

- Inside dimensions 13" high x 13" deep.
- Laminate Overhead.
- Available in standard Evolve laminate finishes.
- Top mount on panels.
- Dual Access Overhead Support Brackets to be ordered separately.

| PRODUCT CODE | PRICE | SIZE/ INCHES | | | WEIGHT VOL | |
|--------------|-------|--------------|----|-------|------------|-----------------|
| | | H | W | D | LBS | FT ³ |
| EVSDAOHL36 | 1037 | 15 | 36 | 14.12 | 46.97 | 4.40 |
| EVSDAOHL42 | 1118 | 15 | 42 | 14.12 | 52.84 | 5.13 |
| EVSDAOHL48 | 1164 | 15 | 48 | 14.12 | 58.90 | 5.87 |
| EVSDAOHL54 | 1246 | 15 | 54 | 14.12 | 64.97 | 6.61 |
| EVSDAOHL60 | 1294 | 15 | 60 | 14.12 | 71.03 | 7.35 |

EVSDAOHR36 • Dual Access Overhead Right

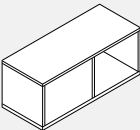

- Inside dimensions 13" high x 13" deep.
- Laminate Overhead.
- Available in standard Evolve laminate finishes.
- Top mount on panels.
- Dual Access Overhead Support Brackets to be ordered separately.

| PRODUCT CODE | PRICE | SIZE/ INCHES | | | WEIGHT VOL | |
|--------------|-------|--------------|----|-------|------------|-----------------|
| | | H | W | D | LBS | FT ³ |
| EVSDAOHR36 | 1037 | 15 | 36 | 14.12 | 46.97 | 4.40 |
| EVSDAOHR42 | 1118 | 15 | 42 | 14.12 | 52.84 | 5.13 |
| EVSDAOHR48 | 1164 | 15 | 48 | 14.12 | 58.90 | 5.87 |
| EVSDAOHR54 | 1246 | 15 | 54 | 14.12 | 64.97 | 6.61 |
| EVSDAOHR60 | 1294 | 15 | 60 | 14.12 | 71.03 | 7.35 |

EVSDAOHBKTE • End of run Bracket

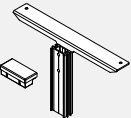

- Bracket supports dual access overhead on one side only.
- Includes one bracket, aluminum insert and end of run plastic cap.
- End of run plastic cap attaches to end of run trim.
- Bracket available in standard Evolve paint finishes.

| PRODUCT CODE | PRICE | SIZE/ INCHES | | | WEIGHT VOL | |
|--------------|-------|--------------|---|----|------------|-----------------|
| | | H | W | D | LBS | FT ³ |
| EVSDAOHBKTE | 91 | 6.5 | 2 | 12 | 1 | 0.09 |

EVSDAOHBKTS • Inline Single Bracket

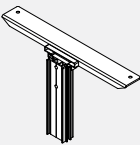

- Bracket supports dual access overhead on one side only.
- Includes one bracket, aluminum insert and inline plastic cap.
- Inline plastic cap and top trim align.
- Bracket available in standard Evolve paint finishes.
- Note: Single clamps must be used when inline single bracket is used.

| PRODUCT CODE | PRICE | SIZE/ INCHES | | | WEIGHT VOL | |
|--------------|-------|--------------|---|----|------------|-----------------|
| | | H | W | D | LBS | FT ³ |
| EVSDAOHBKTS | 91 | 6.5 | 4 | 12 | 1.6 | 0.09 |

EVSDAOHBKTD • Double Bracket

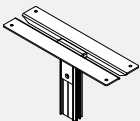

- Double Bracket supports sides of dual access overheads when overhead are side by side.
- Includes two brackets, aluminum insert and plastic caps.
- Plastic caps installed between bracket.
- Brackets available in standard Evolve paint finishes.
- **Note:** Single clamps must be used when double bracket is used.

| PRODUCT CODE | PRICE | SIZE/ INCHES | | | WEIGHT VOL | |
|--------------|-------|--------------|---|----|------------|-----------------|
| | | H | W | D | LBS | FT ³ |
| EVSDAOHBKTD | 181 | 6.5 | 4 | 12 | 1.6 | 0.18 |

EVSSOHL • Top Mount KD Overhead with Sliding Glass Door Left

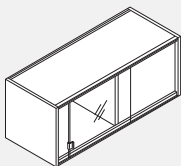

- Inside dimensions 13" high x 13" deep
- Laminate side walls and divider, available in standard laminate finishes
- Metal shelves and back wall, available in standard paint finishes
- Available in tempered frosted glass only
- Tracks for sliding glass available in Tungsten only
- Top mount on panels
- Ready for quick assembly on site
- Top Mount Overhead Support Brackets to be ordered separately.

| PRODUCT CODE | PRICE | SIZE/ INCHES | | | WEIGHT VOL | |
|--------------|-------|--------------|----|----|------------|-----------------|
| | | H | W | D | LBS | FT ³ |
| EVSSOHL30 | 1049 | 15 | 30 | 15 | 63.00 | 3.66 |
| EVSSOHL36 | 1158 | 15 | 36 | 15 | 64.00 | 4.40 |
| EVSSOHL42 | 1276 | 15 | 42 | 15 | 66.00 | 5.13 |
| EVSSOHL48 | 1359 | 15 | 48 | 15 | 68.00 | 5.87 |
| EVSSOHL54 | 1438 | 15 | 54 | 15 | 70.00 | 6.61 |
| EVSSOHL60 | 1571 | 15 | 60 | 15 | 72.00 | 7.35 |

EVSSOHR • Top Mount KD Overhead with Sliding Glass Door Right

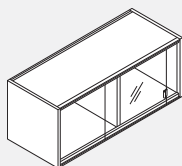

- Inside dimensions 13" high x 13" deep.
- Laminate side walls and divider, available in standard laminate finishes.
- Metal shelves and back wall, available in standard paint finishes.
- Available in tempered frosted glass only.
- Tracks for sliding glass available in Tungsten only.
- Top mount on panels.
- Ready for quick assembly on site .
- Top Mount Overhead Support Brackets to be ordered separately.

| PRODUCT CODE | PRICE | SIZE/ H | INCHES W | D | WEIGHT LBS | VOL FT ³ |
|--------------|-------|---------|----------|----|------------|---------------------|
| EVSSOHR30 | 1049 | 15 | 30 | 15 | 63.00 | 3.66 |
| EVSSOHR36 | 1158 | 15 | 36 | 15 | 64.00 | 4.40 |
| EVSSOHR42 | 1276 | 15 | 42 | 15 | 66.00 | 5.13 |
| EVSSOHR48 | 1359 | 15 | 48 | 15 | 68.00 | 5.87 |
| EVSSOHR54 | 1438 | 15 | 54 | 15 | 70.00 | 6.61 |
| EVSSOHR60 | 1571 | 15 | 60 | 15 | 72.00 | 7.35 |

EVSSOHBKTE • End of run Top Mount Overhead Bracket

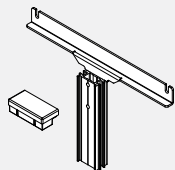

- Bracket supports Top Mount KD overhead on one side only.
- Includes one bracket , aluminum insert and end of run plastic cap.
- End of run plastic cap attaches to end of run trim.
- Bracket available in standard Evolve paint finishes.

| PRODUCT CODE | PRICE | SIZE/ H | INCHES W | D | WEIGHT LBS | VOL FT ³ |
|--------------|-------|---------|----------|----|------------|---------------------|
| EVSSOHBKTE | 91 | 6 | 2 | 12 | 1 | 0.07 |

EVSSOHBKTS • Inline Single Top Mount Overhead Bracket

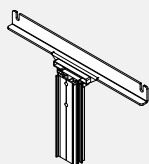

- Bracket supports Top Mount KD overhead on one side only.
- Includes one bracket , aluminum insert and inline plastic cap.
- Inline plastic cap and top trim align.
- Bracket available in standard Evolve paint finishes.
- **Note:** Single clamps must be used when inline single bracket is used.

| PRODUCT CODE | PRICE | SIZE/ H | INCHES W | D | WEIGHT LBS | VOL FT ³ |
|--------------|-------|---------|----------|----|------------|---------------------|
| EVSSOHBKTS | 91 | 15 | 36 | 12 | 1 | 0.07 |

EVSSOHBKTD • Double Top Mount Overhead Bracket

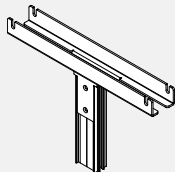

- Double Bracket supports sides of Top Mount KD overheads when overhead are side by side.
- Includes two brackets, aluminum insert and plastic caps.
- Plastic caps installed between brackets.
- Brackets available in standard Evolve paint finishes.
- **Note:** Single clamps must be used when double bracket is used.

| PRODUCT CODE | PRICE | SIZE/ H | INCHES W | D | WEIGHT LBS | VOL FT ³ |
|--------------|-------|---------|----------|----|------------|---------------------|
| EVSSOHBKTD | 91 | 15 | 36 | 12 | 1.6 | 0.09 |

EVSODOMB • Overhead Off Module Mount Conversion Kit

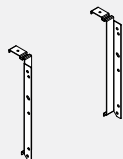

- Converts any existing EVADA overheads to off module installed.
- Allows to install overhead of different widths of Premium Panel.
- Attaches to top horizontal tube of Premium Fabric Panel.
- Brackets allow to install Double Wall Overhead or AODA overhead.
- Kit includes pair of brackets.
- Available in standard paint finishes.

| PRODUCT CODE | PRICE | SIZE/ H | INCHES W | D | WEIGHT LBS | VOL FT ³ |
|--------------|-------|---------|----------|------|------------|---------------------|
| EVSODOMB | 95 | 12.37 | 1 | 4.37 | 0.25 | 0.09 |

EV93FPxxBFP • 9300 Series Freestanding Box File Pedestal

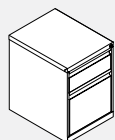

- One box and one file drawer pedestal.
- Freestanding, counterweight included.
- All drawers are locking.
- Box drawer includes pencil tray.

| PRODUCT CODE | PRICE | SIZE/ H | INCHES W | D | WEIGHT LBS | VOL FT ³ |
|--------------|-------|---------|----------|----|------------|---------------------|
| EV93FP19BFP | 559 | 21.31 | 15 | 19 | 50 | 5.1 |
| EV93FP23BFP | 566 | 21.31 | 15 | 23 | 55 | 6.0 |
| EV93FP29BFP | 678 | 21.31 | 15 | 29 | 64 | 7.5 |

EV93FPxxBBFP • 9300 Series Freestanding Box Box File Pedestal

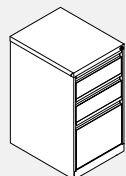

- Two box and one file drawer pedestal.
- Freestanding, counterweight included.
- All drawers are locking.
- Top box drawer includes pencil tray.

| PRODUCT CODE | PRICE | SIZE/ H | INCHES W | D | WEIGHT LBS | VOL FT ³ |
|--------------|-------|---------|----------|----|------------|---------------------|
| EV93FP19BBFP | 617 | 27.87 | 15 | 19 | 55 | 6.5 |
| EV93FP23BBFP | 628 | 27.87 | 15 | 23 | 68 | 7.7 |
| EV93FP29BBFP | 741 | 27.87 | 15 | 29 | 78 | 9.6 |

EV93FPxxFFP • 9300 Series Freestanding File File Pedestal

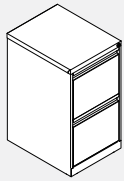

- Two file drawer pedestal.
- Freestanding, counterweight included.
- All drawers are locking.

| PRODUCT CODE | PRICE | SIZE/ INCHES | | | WEIGHT VOL | |
|--------------|-------|--------------|----|----|------------|-----------------|
| | | H | W | D | LBS | FT ³ |
| EV93FP19FFP | 589 | 27.87 | 15 | 19 | 53 | 6.5 |
| EV93FP23FFP | 597 | 27.87 | 15 | 23 | 60 | 7.7 |
| EV93FP29FFP | 699 | 27.87 | 15 | 29 | 70 | 9.6 |

EV93WPxxBBFP • 9300 Series Worksurface Supporting Box Box File Pedestal

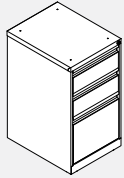

- Two box and one file drawer pedestal.
- Worksurface supporting, includes mounting holes in the top.
- All drawers are locking.
- Top box drawer includes pencil tray.
- To use as a worksurface supporting pedestal, please specify EVHPB6 separately.

| PRODUCT CODE | PRICE | SIZE/ INCHES | | | WEIGHT VOL | |
|--------------|-------|--------------|----|----|------------|-----------------|
| | | H | W | D | LBS | FT ³ |
| EV93WP19BBFP | 613 | 27.87 | 15 | 19 | 55 | 6.5 |
| EV93WP23BBFP | 621 | 27.87 | 15 | 23 | 68 | 7.7 |
| EV93WP29BBFP | 711 | 27.87 | 15 | 29 | 78 | 9.6 |

EV93WPxxFFP • 9300 Series Worksurface Supporting File File Pedestal

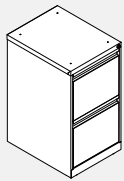

- Two file drawer pedestal.
- Worksurface supporting, includes mounting holes in the top.
- All drawers are locking.
- To use as a worksurface supporting pedestal, please specify EVHPB6 separately.

| PRODUCT CODE | PRICE | SIZE/ INCHES | | | WEIGHT VOL | |
|--------------|-------|--------------|----|----|------------|-----------------|
| | | H | W | D | LBS | FT ³ |
| EV93WP19FFP | 582 | 27.87 | 15 | 19 | 53 | 6.5 |
| EV93WP23FFP | 587 | 27.87 | 15 | 23 | 60 | 7.7 |
| EV93WP29FFP | 700 | 27.87 | 15 | 29 | 70 | 9.6 |

EV93MPxxBFP • 9300 Series Mobile Box File Pedestal

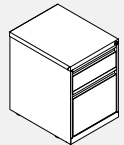

- One box and one file drawer mobile pedestal.
- Casters preinstalled, casters non-locking.
- Counterweight included.
- All drawers locking.
- Box drawer includes pencil tray.
- NOTE: Cannot be used as guest seating.

| PRODUCT CODE | PRICE | SIZE/ INCHES | | | WEIGHT VOL | |
|--------------|-------|--------------|----|----|------------|-----------------|
| | | H | W | D | LBS | FT ³ |
| EV93MP19BFP | 659 | 21.87 | 15 | 19 | 66 | 5.2 |
| EV93MP23BFP | 681 | 21.87 | 15 | 23 | 72 | 6.2 |
| EV93MP29BFP | 730 | 21.87 | 15 | 29 | 92 | 7.6 |

EV93MPxxBBFP • 9300 Series Mobile Box Box File Pedestal

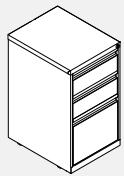

- Two box and one file drawer mobile pedestal.
- Casters preinstalled, casters non-locking.
- Counterweight included.
- All drawers locking.
- Top box drawer includes pencil tray.
- NOTE: Cannot be used as guest seating.

| PRODUCT CODE | PRICE | SIZE/ INCHES | | | WEIGHT VOL | |
|--------------|-------|--------------|----|----|------------|-----------------|
| | | H | W | D | LBS | FT ³ |
| EV93MP19BBFP | 695 | 27.93 | 15 | 19 | 76 | 6.5 |
| EV93MP23BBFP | 702 | 27.93 | 15 | 23 | 85 | 7.7 |
| EV93MP29BBFP | 757 | 27.93 | 15 | 29 | 94 | 9.6 |

EV93MPxxFFP • 9300 Series Mobile File File Pedestal

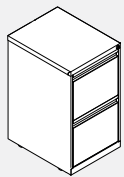

- Two file drawer pedestal.
- Casters preinstalled, casters non-locking.
- Counterweight included.
- All drawers locking.
- NOTE: Cannot be used as guest seating.

| PRODUCT CODE | PRICE | SIZE/ INCHES | | | WEIGHT VOL | |
|--------------|-------|--------------|----|----|------------|-----------------|
| | | H | W | D | LBS | FT ³ |
| EV93MP19FFP | 654 | 27.93 | 15 | 19 | 73 | 6.5 |
| EV93MP23FFP | 681 | 27.93 | 15 | 23 | 81 | 7.7 |
| EV93MP29FFP | 748 | 27.93 | 15 | 29 | 90 | 9.6 |

EVPFOBFxxP • Prime Freestanding Box File Pedestal

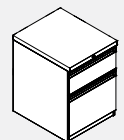

- One box and one file drawer pedestal.
- All drawers are locking.
- Box drawer includes pencil tray.
- For freestanding, to add counterweight (W2 option), add \$50 list.
- For mobile to add casters and counterweight (W1 option), add \$75 list. Adds 0.5" to height.
- NOTE: Cannot be used as guest seating.

| PRODUCT CODE | PRICE | SIZE/ INCHES | | | WEIGHT VOL | |
|--------------|-------|--------------|----|----|------------|-----------------|
| | | H | W | D | LBS | FT ³ |
| EVPFOBF18P | 722 | 20.8 | 15 | 18 | 52.4 | 4.2 |
| EVPFOBF22P | 756 | 20.8 | 15 | 22 | 58.8 | 5.0 |
| EVPFOBF28P | 791 | 20.8 | 15 | 28 | 68.7 | 6.3 |

EVPFSBGxxP • Prime Box Box File Pedestal

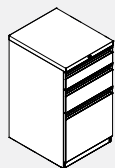

- Two box and one file drawer pedestal.
- All drawers are locking.
- Top box drawer includes pencil tray.
- For freestanding, to add counterweight (W2 option), add \$50 list.
- For mobile to add casters and counterweight (W1 option), add \$75 list. Adds 0.5" to height.
- Top box drawer 4.8"h; middle box drawer 6.4"h; bottom file drawer 13.6"h (interior 12.5"h).
- When worksurface supporting option selected, unit includes pre-drilled top holes for attaching.
- To use as a worksurface supporting pedestal, please specify EVHPB5 separately.

| PRODUCT CODE | PRICE | SIZE/ INCHES | | | WEIGHT VOL | |
|--------------|-------|--------------|----|----|------------|-----------------|
| | | H | W | D | LBS | FT ³ |
| EVPFSBG18P | 834 | 28 | 15 | 18 | 67.5 | 5.5 |
| EVPFSBG22P | 874 | 28 | 15 | 22 | 75 | 6.6 |
| EVPFSBG28P | 913 | 28 | 15 | 28 | 86.8 | 8.3 |

EVPFOFGxxP • Prime File File Pedestal

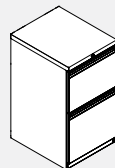

- Two file drawer pedestal.
- All drawers are locking.
- For freestanding, to add counterweight (W2 option), add \$50 list.
- For mobile to add casters and counterweight (W1 option), add \$75 list. Adds 0.5" to height.
- Top file drawer 11.2"h (interior 10.6"h); bottom file drawer 13.6"h (interior 12.5"h).
- When worksurface supporting option selected, unit includes pre-drilled top holes for attaching.
- To use as a worksurface supporting pedestal, please specify EVHPB5 separately.

| PRODUCT CODE | PRICE | SIZE/ INCHES | | | WEIGHT VOL | |
|--------------|-------|--------------|----|----|------------|-----------------|
| | | H | W | D | LBS | FT ³ |
| EVPFOFG18P | 761 | 28 | 15 | 18 | 67.5 | 5.5 |
| EVPFOFG22P | 791 | 28 | 15 | 22 | 75 | 6.6 |
| EVPFOFG28P | 825 | 28 | 15 | 28 | 86.8 | 8.3 |

EVPWOBFxxP • Prime Mobile Box File Pedestal

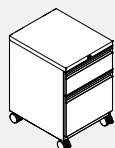

- Mobile one box and one file drawer pedestal.
- All drawers are locking.
- 60mm casters.
- Front casters are locking.

| PRODUCT CODE | PRICE | SIZE/ INCHES | | | WEIGHT VOL | |
|--------------|-------|--------------|----|----|------------|-----------------|
| | | H | W | D | LBS | FT ³ |
| EVPWOBF18P | 888 | 23.3 | 15 | 18 | 73.5 | 4.6 |
| EVPWOBF22P | 917 | 23.3 | 15 | 22 | 79.1 | 5.6 |
| EVPWOBF28P | 947 | 23.3 | 15 | 28 | 87.7 | 7.0 |

EVPWSSFxxP • Prime Mobile Box Box File Pedestal

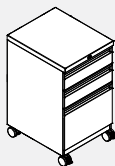

- Mobile two box and one file drawer pedestal.
- All drawers are locking.
- 60mm casters.
- Front casters are locking.

| PRODUCT CODE | PRICE | SIZE/ INCHES | | | WEIGHT VOL | |
|--------------|-------|--------------|----|----|------------|-----------------|
| | | H | W | D | LBS | FT ³ |
| EVPWSSF18P | 1005 | 26.5 | 15 | 18 | 82.9 | 5.2 |
| EVPWSSF22P | 1044 | 26.5 | 15 | 22 | 89.3 | 6.3 |
| EVPWSSF28P | 1059 | 26.5 | 15 | 28 | 99.2 | 7.9 |

EVSTC • Pedestal/Lateral Seat Cushion

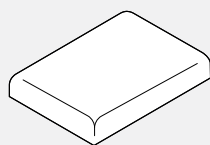

| PRODUCT CODE | YRDS | SIZE/ INCHES | | | WEIGHT VOL | |
|--------------|------|--------------|----|----|------------|-----------------|
| | | H | W | D | LBS | FT ³ |
| EVSTCL1830 | 1.00 | 2 | 18 | 30 | 6.00 | 0.55 |
| EVSTCL1836 | 1.25 | 2 | 18 | 36 | 6.00 | 0.65 |
| EVSTCP1518 | 0.75 | 2 | 15 | 18 | 5.00 | 0.41 |
| EVSTCP1522 | 1.00 | 2 | 15 | 22 | 5.25 | 0.45 |
| EVSTCP1528 | 1.00 | 2 | 15 | 28 | 5.50 | 0.55 |

• C.O.M. Fabrics are priced as Grade 3.

| PRODUCT CODE | PRICE | | | | | | | | | | | | | | | | | | | |
|--------------|-------|-----|-----|-----|-----|-----|-----|-----|-----|------|------|------|------|------|------|------|------|------|------|------|
| | GR1 | GR2 | GR3 | GR4 | GR5 | GR6 | GR7 | GR8 | GR9 | GR10 | GR11 | GR12 | GR13 | GR14 | GR15 | GR16 | GR17 | GR18 | GR19 | GR20 |
| EVSTCL1830 | 289 | 328 | 355 | 394 | 450 | 503 | 552 | 603 | 655 | 712 | 783 | 886 | 987 | 1089 | 1317 | 1541 | 1772 | 1996 | 2221 | 2471 |
| EVSTCL1836 | 343 | 391 | 430 | 475 | 543 | 608 | 673 | 733 | 801 | 869 | 960 | 1089 | 1214 | 1343 | 1628 | 1908 | 2194 | 2474 | 2757 | 3070 |
| EVSTCP1518 | 202 | 233 | 252 | 280 | 323 | 364 | 401 | 435 | 477 | 518 | 574 | 652 | 724 | 802 | 972 | 1142 | 1312 | 1482 | 1652 | 1839 |
| EVSTCP1522 | 212 | 240 | 264 | 291 | 333 | 372 | 411 | 448 | 486 | 528 | 582 | 659 | 736 | 813 | 984 | 1153 | 1324 | 1495 | 1661 | 1848 |
| EVSTCP1528 | 267 | 305 | 336 | 371 | 426 | 480 | 534 | 579 | 631 | 688 | 759 | 864 | 964 | 1065 | 1294 | 1517 | 1747 | 1973 | 2198 | 2448 |

EVFELT03BC - Felt Shelf Liner for Cube Pedestals

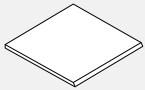

- Felt shelf liner can be added to any closed back shelf.
- Front edge is cut at 45 degree.

| PRODUCT CODE | PRICE | SIZE/ H | INCHES W | D | WEIGHT LBS | VOL FT³ |
|--------------|-------|---------|----------|------|------------|---------|
| EVFTFELT03BC | 23 | 12 | 12 | 0.38 | 0.1 | 0.03 |

EVSSPH12BFB • Cube Hanging Pedestal, One File Box and Two Open Boxes

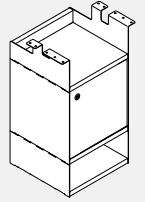

- Hanging pedestal with one file box in the middle and two open boxes, one at the top and one at the bottom.
- Attaches to the underside of a worksurface with supplied screws.
- File box interior dimensions: 11 7/8" h x 11 13/16" w x 10 7/16" d.
- Includes chrome wire divider and optional lock.
- Metal wire divider is chrome and sits 3 7/16" from either side and is interchangeable.
- File door lock, if specified is located on the top right corner for the right pedestal and top left corner for the left pedestal.
- Bottom, middle and top shelves, front door and back are made of 3/4" low pressure laminate.
- Sides are made of powder coated metal.
- Ships knocked-down.

| PRODUCT CODE | PRICE | SIZE/ H | INCHES W | D | WEIGHT LBS | VOL FT³ |
|---------------------|-------|---------|----------|----|------------|---------|
| Without Lock | | | | | | |
| EVSSPH12BFBR | 444 | 24 | 12 | 12 | 26 | 2.33 |
| EVSSPH12BFBL | 444 | 24 | 12 | 12 | 26 | 2.33 |
| With Lock | | | | | | |
| EVSSPH12BFBKR | 457 | 24 | 12 | 12 | 26 | 2.33 |
| EVSSPH12BFBKL | 457 | 24 | 12 | 12 | 26 | 2.33 |

EVSSPH12BF • Cube Hanging Pedestal, One File Box

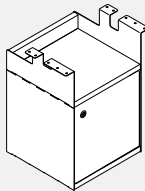

- Hanging pedestal with one file box at the bottom and one open box at the top.
- Attaches to the underside of a worksurface with supplied screws.
- File box interior dimensions: 11 7/8" h x 11 13/16" w x 10 7/16" d.
- Includes chrome wire divider and optional lock.
- Metal wire divider is chrome and sits 3 7/16" from either side and is interchangeable.
- File door lock, if specified is located on the top right corner for the right pedestal and top left corner for the left pedestal.
- Bottom, middle and top shelves, front door and back are made of 3/4" low pressure laminate.
- Sides are made of powder coated metal.
- Ships knocked-down.

| PRODUCT CODE | PRICE | SIZE/ H | INCHES W | D | WEIGHT LBS | VOL FT³ |
|---------------------|-------|---------|----------|----|------------|---------|
| Without Lock | | | | | | |
| EVSSPH12BFR | 334 | 18.5 | 12 | 12 | 20 | 1.83 |
| EVSSPH12BFL | 334 | 18.5 | 12 | 12 | 20 | 1.83 |
| With Lock | | | | | | |
| EVSSPH12BFKR | 347 | 18.5 | 12 | 12 | 20 | 1.83 |
| EVSSPH12BFKL | 347 | 18.5 | 12 | 12 | 20 | 1.83 |

EVSSPH12B • Cube Hanging Pedestal Box

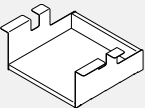

- Hanging pedestal open box.
- Attaches to the underside of a worksurface with supplied screws to create an open box.
- Bottom, middle and top shelves, front door and back are made of 3/4" low pressure laminate.
- Sides are made of powder coated metal.
- Ships knocked-down.

| PRODUCT CODE | PRICE | SIZE/ H | INCHES W | D | WEIGHT LBS | VOL FT³ |
|--------------|-------|---------|----------|----|------------|---------|
| EVSSPH12B | 136 | 6 | 12 | 12 | 6 | 0.96 |

EVSSPH12BB • Cube Hanging Pedestal, Two Open Boxes

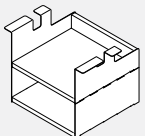

- Hanging pedestal with two open boxes.
- Attaches to the underside of a worksurface with supplied screws.
- Bottom, middle and top shelves, front door and back are made of 3/4" low pressure laminate.
- Sides are made of powder coated metal.
- Ships knocked-down.

| PRODUCT CODE | PRICE | SIZE/ H | INCHES W | D | WEIGHT LBS | VOL FT³ |
|--------------|-------|---------|----------|----|------------|---------|
| EVSSPH12BB | 251 | 11.5 | 12 | 12 | 12 | 1.42 |

EVT • Lateral File Tops

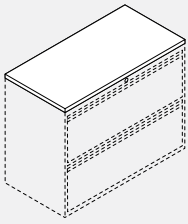

- Made of 1" or 1/16" thick particle board with laminate finish and edged in 3.0 mm edge banding.

| PRODUCT CODE | PRICE | | SIZE/INCHES | | | WEIGHT VOL | |
|--------------|-------|-----|-------------|-----|----|------------|-----------------|
| | LP | HP | H | W | D | LBS | FT ³ |
| EVT1830 | 151 | 213 | 1.0625 | 30 | 18 | 18.00 | 0.70 |
| EVT1836 | 177 | 239 | 1.0625 | 36 | 18 | 22.00 | 0.82 |
| EVT1842 | 207 | 318 | 1.0625 | 42 | 18 | 26.00 | 0.92 |
| EVT1860 | 286 | 486 | 1.0625 | 60 | 18 | 37.00 | 1.27 |
| EVT1872 | 340 | 550 | 1.0625 | 72 | 18 | 44.00 | 1.50 |
| EVT1884 | 464 | 625 | 1.0625 | 84 | 18 | 52.00 | 1.85 |
| EVT1890 | 502 | 682 | 1.0625 | 90 | 18 | 56.00 | 1.85 |
| EVT18108 | 624 | 853 | 1.0625 | 108 | 18 | 67.00 | 2.20 |

EVLPS0BF18xxP • Prime Box File Lateral

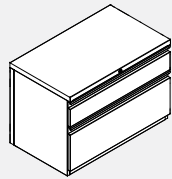

- One and a half height lateral filing cabinet.
- Fixed front drawers, top box drawer front 4.8" bottom file drawer front 13.6" (interior 12.5").
- Locking.
- Side to side hanging bars included.
- To add counterweight (W2 option), add \$410 list.

| PRODUCT CODE | PRICE | SIZE/INCHES | | | WEIGHT VOL | |
|---------------|-------|-------------|----|-------|------------|-----------------|
| | | H | W | D | LBS | FT ³ |
| EVLPS0BF1830P | 1191 | 20.98 | 30 | 18.06 | 119.96 | 8.0 |
| EVLPS0BF1836P | 1283 | 20.98 | 36 | 18.06 | 129.86 | 9.5 |
| EVLPS0BF1842P | 1371 | 20.98 | 42 | 18.06 | 165.45 | 11.1 |

EVL20G18xxP • Prime 2 High Lateral File

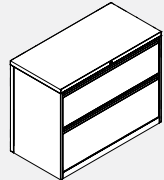

- Two high lateral filing cabinet.
- Fixed front file drawers, top drawer front 11.2" (interior 10.6") bottom drawer front 13.6" (interior 12.5").
- Locking.
- Side to side hanging bars included.
- To add counterweight (W2 option), add \$200 list.

| PRODUCT CODE | PRICE | SIZE/INCHES | | | WEIGHT VOL | |
|--------------|-------|-------------|----|----|------------|-----------------|
| | | H | W | D | LBS | FT ³ |
| EVL20G1830P | 1279 | 28 | 30 | 18 | 98.7 | 10.5 |
| EVL20G1836P | 1366 | 28 | 36 | 18 | 114.4 | 12.5 |
| EVL20G1842P | 1454 | 28 | 42 | 18 | 129.4 | 14.5 |

EVL30G18xxP • Prime 3 High Lateral File

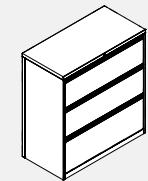

- Three high lateral filing cabinet.
- Fixed front file drawers, top & middle drawer front 11.2" (interior 10.6") bottom drawer front 13.6" (interior 12.5").
- Locking.
- Side to side hanging bars included.
- Will not line up with 42" high panels.
- To add counterweight (W2 option), add \$200 list.

| PRODUCT CODE | PRICE | SIZE/INCHES | | | WEIGHT VOL | |
|--------------|-------|-------------|----|----|------------|-----------------|
| | | H | W | D | LBS | FT ³ |
| EVL30G1830P | 1747 | 39.2 | 30 | 18 | 127.9 | 14.5 |
| EVL30G1836P | 1869 | 39.2 | 36 | 18 | 147.6 | 17.2 |
| EVL30G1842P | 1991 | 39.2 | 42 | 18 | 167.5 | 20.0 |

EVL40H18xxP • Prime 4 High RFFF Lateral File

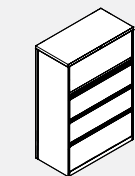

- Four high receding top door and remaining fixed front lateral filing cabinet.
- Top opening receding door + roll out shelf 14.4" front, accepts binder height; fixed front drawers second and third drawers 11.2" (interior 10.6") bottom drawer front 13.6" (interior 12.5").
- Locking.
- Side to side hanging bars included.
- To add counterweight (W2 option), add \$200 list.

| PRODUCT CODE | PRICE | SIZE/INCHES | | | WEIGHT VOL | |
|--------------|-------|-------------|----|----|------------|-----------------|
| | | H | W | D | LBS | FT ³ |
| EVL40H1830P | 2323 | 53.6 | 30 | 18 | 171.9 | 19.6 |
| EVL40H1836P | 2474 | 53.6 | 36 | 18 | 198.2 | 23.3 |
| EVL40H1842P | 2630 | 53.6 | 42 | 18 | 225.3 | 27.0 |

EVL50P18xxP • Prime 5 High RFFFF Lateral File

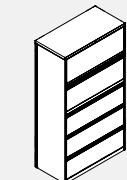

- Five high receding top door and remaining fixed front lateral filing cabinet.
- 13.6" (interior 12.5").
- Locking.
- Side to side hanging bars included.
- Top opening receding door + Roll out shelf 14.4" front, accepts binder height; fixed front drawers below - second and third 11.2" (interior 10.6") bottom drawer front
- To add counterweight (W2 option), add \$200 list.

| PRODUCT CODE | PRICE | SIZE/INCHES | | | WEIGHT VOL | |
|--------------|-------|-------------|----|----|------------|-----------------|
| | | H | W | D | LBS | FT ³ |
| EVL50P1830P | 2860 | 65.6 | 30 | 18 | 208.9 | 23.9 |
| EVL50P1836P | 3035 | 65.6 | 36 | 18 | 239.9 | 28.4 |
| EVL50P1842P | 3221 | 65.6 | 42 | 18 | 272.7 | 32.9 |

EVSC21G18xxP • Prime 2 High Storage Cabinet

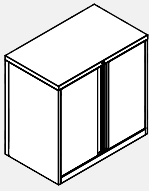

- Two high storage cabinet.
- One adjustable shelf + fixed bottom shelf.
- Locking.

| PRODUCT CODE | PRICE | SIZE/INCHES | | | WEIGHT LBS | VOL FT ³ |
|--------------|-------|-------------|----|----|------------|---------------------|
| | | H | W | D | | |
| EVSC21G1830P | 1005 | 28 | 30 | 18 | 75.08 | 10.5 |
| EVSC21G1836P | 1074 | 28 | 36 | 18 | 86.48 | 12.5 |
| EVSC21G1842P | 1142 | 28 | 42 | 18 | 95.78 | 14.5 |

EVSC31G18xxP • Prime 3 High Storage Cabinet

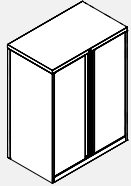

- Three high storage cabinet.
- Two adjustable shelves + fixed bottom shelf.
- Will not line up to 42" high panels.
- Locking.

| PRODUCT CODE | PRICE | SIZE/INCHES | | | WEIGHT LBS | VOL FT ³ |
|--------------|-------|-------------|----|----|------------|---------------------|
| | | H | W | D | | |
| EVSC31G1830P | 1401 | 39.2 | 30 | 18 | 96.69 | 14.5 |
| EVSC31G1836P | 1493 | 39.2 | 36 | 18 | 111.59 | 17.2 |
| EVSC31G1842P | 1571 | 39.2 | 42 | 18 | 124.49 | 20.0 |

EVSC41H18xxP • Prime 4 High Storage Cabinet

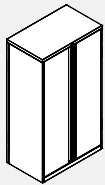

- Four high storage cabinet.
- Three adjustable shelves + fixed bottom shelf.
- Locking.

| PRODUCT CODE | PRICE | SIZE/INCHES | | | WEIGHT LBS | VOL FT ³ |
|--------------|-------|-------------|----|----|------------|---------------------|
| | | H | W | D | | |
| EVSC41H1830P | 1713 | 53.6 | 30 | 18 | 120.17 | 19.6 |
| EVSC41H1836P | 1825 | 53.6 | 36 | 18 | 138.27 | 23.3 |
| EVSC41H1842P | 1913 | 53.6 | 42 | 18 | 154.37 | 27.0 |

EVSC51C18xxP • Prime 5 High Storage Cabinet

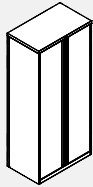

- Five high storage cabinet.
- Four adjustable shelves + fixed bottom shelf.
- Locking.

| PRODUCT CODE | PRICE | SIZE/INCHES | | | WEIGHT LBS | VOL FT ³ |
|--------------|-------|-------------|----|----|------------|---------------------|
| | | H | W | D | | |
| EVSC51C1830P | 1947 | 65.6 | 30 | 18 | 138.5 | 23.9 |
| EVSC51C1836P | 2069 | 65.6 | 36 | 18 | 160.4 | 28.4 |
| EVSC51C1842P | 2162 | 65.6 | 42 | 18 | 180.4 | 32.9 |

EVSLFxx24BCPL • Prime Tower, Left Wardrobe, Half Height Door, Box Box File Drawers

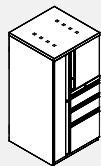

- Left wardrobe tower with half height door and box box file drawers.
- Wardrobe section includes top shelf and coat bar.
- Hinged door compartment of 50"h and 54"h includes one adjustable shelf; 66"h includes two adjustable open shelves.
- Wardrobe section includes top perforations for ventilation.
- Three locks included - wardrobe door, hinged door shelving compartment and drawers.
- To add counterweight (W2 option), add \$105 list.

| PRODUCT CODE | PRICE | SIZE/INCHES | | | WEIGHT LBS | VOL FT ³ |
|---------------|-------|-------------|----|----|------------|---------------------|
| | | H | W | D | | |
| EVSLF4G24BCPL | 3348 | 49.6 | 24 | 24 | 176.71 | 19.23 |
| EVSLF4H24BCPL | 3348 | 53.6 | 24 | 24 | 181.63 | 19.83 |
| EVSLF5024BCPL | 3514 | 65.6 | 24 | 24 | 204.52 | 25.25 |

*4G' Tower Shown

EVSLFxx24BCPR • Prime Tower, Right Wardrobe, Half Height Door, Box Box File Drawers

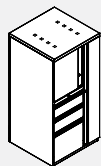

- Right wardrobe tower with half height door and box box file drawers.
- Wardrobe section includes top shelf and coat bar.
- Hinged door compartment of 50"h and 54"h includes one adjustable shelf; 66"h includes two adjustable open shelves.
- Wardrobe section includes top perforations for ventilation.
- Three locks included - wardrobe door, hinged door shelving compartment and drawers.
- To add counterweight (W2 option), add \$105 list.

| PRODUCT CODE | PRICE | SIZE/INCHES | | | WEIGHT LBS | VOL FT ³ |
|---------------|-------|-------------|----|----|------------|---------------------|
| | | H | W | D | | |
| EVSLF4G24BCPR | 3348 | 49.6 | 24 | 24 | 176.71 | 19.23 |
| EVSLF4H24BCPR | 3348 | 53.6 | 24 | 24 | 181.63 | 19.83 |
| EVSLF5024BCPR | 3514 | 65.6 | 24 | 24 | 204.52 | 25.25 |

*4G' Tower Shown

EVSLFxx24FCPL • Prime Tower, Left Wardrobe, Half Height Door, File File Drawers

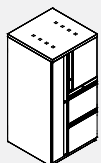

- Left wardrobe tower with half height door and file file drawers.
- Wardrobe section includes top shelf and coat bar.
- Hinged door compartment of 50"h and 54"h includes one adjustable shelf; 66"h includes two adjustable open shelves.
- Wardrobe section includes top perforations for ventilation.
- Three locks included - wardrobe door, hinged door shelving compartment and drawers.
- To add counterweight (W2 option), add \$105 list.

| PRODUCT CODE | PRICE | SIZE/INCHES | | | WEIGHT LBS | VOL FT ³ |
|---------------|-------|-------------|----|----|------------|---------------------|
| | | H | W | D | | |
| EVSLF4G24FCPL | 3260 | 49.6 | 24 | 24 | 181.05 | 19.23 |
| EVSLF4H24FCPL | 3260 | 53.6 | 24 | 24 | 186.43 | 19.83 |
| EVSLF5024FCPL | 3431 | 65.6 | 24 | 24 | 231.53 | 25.25 |

*4G' Tower Shown

EVSLFxx24FCPR • Prime Tower, Right Wardrobe, Half Height Door, File File Drawers

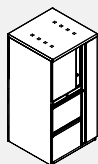

*4G' Tower Shown

- Right wardrobe tower with half height door and file file drawers.
- Wardrobe section includes top shelf and coat bar.
- Hinged door compartment of 50" h and 54" h includes one adjustable shelf; 66" h includes two adjustable open shelves.
- Wardrobe section includes top perforations for ventilation.
- Three locks included - wardrobe door, hinged door shelving compartment and drawers.
- To add counterweight (W2 option), add \$105 list.

| PRODUCT CODE | PRICE | SIZE/INCHES | | | WEIGHT LBS | VOL FT ³ |
|---------------|-------|-------------|----|----|------------|---------------------|
| | | H | W | D | | |
| EVSLF4G24FCPR | 3260 | 49.6 | 24 | 24 | 181.05 | 19.23 |
| EVSLF4H24FCPR | 3260 | 53.6 | 24 | 24 | 186.43 | 19.83 |
| EVSLF5024FCPR | 3431 | 65.6 | 24 | 24 | 231.53 | 25.25 |

EVSLSxx2424BOPL • Prime Tower, Left Wardrobe, Side Open Shelf, Box Box File Drawers

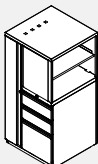

*4G' Tower Shown

- Left wardrobe tower with side open shelving and box box file drawers.
- Wardrobe section includes top shelf and coat bar.
- 50" h and 54" h include open side shelf with one adjustable shelf; 66" h includes open side shelf with two adjustable shelves.
- Wardrobe section includes top perforations for ventilation.
- Two locks included - wardrobe door and drawers.

| PRODUCT CODE | PRICE | SIZE/INCHES | | | WEIGHT LBS | VOL FT ³ |
|-----------------|-------|-------------|----|----|------------|---------------------|
| | | H | W | D | | |
| EVSLS4G2424BOPL | 3475 | 49.6 | 24 | 24 | 186.18 | 19.23 |
| EVSLS4H2424BOPL | 3475 | 53.6 | 24 | 24 | 186.91 | 19.83 |
| EVSLS502424BOPL | 3684 | 65.6 | 24 | 24 | 236.34 | 25.25 |

EVSLSxx2424BOPR • Prime Tower, Right Wardrobe, Side Open Shelf, Box Box File Drawers

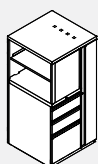

*4G' Tower Shown

- Right wardrobe tower with side open shelving and box box file drawers.
- Wardrobe section includes top shelf and coat bar.
- 50" h and 54" h include open side shelf with one adjustable shelf; 66" h includes open side shelf with two adjustable shelves.
- Wardrobe section includes top perforations for ventilation.
- Two locks included - wardrobe door and drawers.

| PRODUCT CODE | PRICE | SIZE/INCHES | | | WEIGHT LBS | VOL FT ³ |
|-----------------|-------|-------------|----|----|------------|---------------------|
| | | H | W | D | | |
| EVSLS4G2424BOPR | 3475 | 49.6 | 24 | 24 | 186.18 | 19.23 |
| EVSLS4H2424BOPR | 3475 | 53.6 | 24 | 24 | 186.91 | 19.83 |
| EVSLS502424BOPR | 3684 | 65.6 | 24 | 24 | 236.34 | 25.25 |

EVSLSxx2424FOPL • Prime Tower, Left Wardrobe, Side Open Shelf, File File Drawers

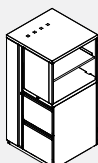

*4G' Tower Shown

- Left wardrobe tower with side open shelving and file file drawers.
- Wardrobe section includes top shelf and coat bar.
- 50" h and 54" h include open side shelf with one adjustable shelf; 66" h includes open side shelf with two adjustable shelves.
- Wardrobe section includes top perforations for ventilation.
- Two locks included - wardrobe door and drawers.

| PRODUCT CODE | PRICE | SIZE/INCHES | | | WEIGHT LBS | VOL FT ³ |
|-----------------|-------|-------------|----|----|------------|---------------------|
| | | H | W | D | | |
| EVSLS4G2424FOPL | 3392 | 49.6 | 24 | 24 | 179.54 | 19.23 |
| EVSLS4H2424FOPL | 3392 | 53.6 | 24 | 24 | 180.26 | 19.83 |
| EVSLS502424FOPL | 3601 | 65.6 | 24 | 24 | 232.55 | 25.25 |

EVSLSxx2424FOPR • Prime Tower, Right Wardrobe, Side Open Shelf, File File Drawers

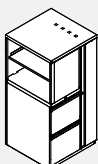

*4G' Tower Shown

- Right wardrobe tower with side open shelving and file file drawers.
- Wardrobe section includes top shelf and coat bar.
- 50" h and 54" h include open side shelf with one adjustable shelf; 66" h includes open side shelf with two adjustable shelves.
- Wardrobe section includes top perforations for ventilation.
- Two locks included - wardrobe door and drawers.

| PRODUCT CODE | PRICE | SIZE/INCHES | | | WEIGHT LBS | VOL FT ³ |
|-----------------|-------|-------------|----|----|------------|---------------------|
| | | H | W | D | | |
| EVSLS4G2424FOPR | 3392 | 49.6 | 24 | 24 | 179.54 | 19.23 |
| EVSLS4H2424FOPR | 3392 | 53.6 | 24 | 24 | 180.26 | 19.83 |
| EVSLS502424FOPR | 3601 | 65.6 | 24 | 24 | 232.55 | 25.25 |

EVWC51C18xxP • Prime Wardrobe

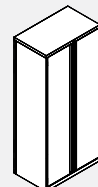

- Wardrobe cabinet.
- 30"W includes full width shelf and side to side coat rod.
- 36" and 42"W are split with shelving on left side, wardrobe on the other.

| PRODUCT CODE | PRICE | SIZE/INCHES | | | WEIGHT LBS | VOL FT ³ |
|--------------|-------|-------------|----|----|------------|---------------------|
| | | H | W | D | | |
| EVWC51C1830P | 1874 | 65.6 | 30 | 18 | 125.26 | 23.85 |
| EVWC51C1836P | 2294 | 65.6 | 36 | 18 | 164.97 | 28.40 |
| EVWC51C1842P | 2499 | 65.6 | 42 | 18 | 180.59 | 32.94 |

EVCC31G18xxP • Prime Three High Combination Cabinet

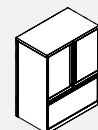

- Multi stor cabinet including hinged door upper section with one adjustable shelf; one fixed front file drawers below.
- Will not line up to 42" high panels.
- Locking.

| PRODUCT CODE | PRICE | SIZE/INCHES | | | WEIGHT LBS | VOL FT ³ |
|--------------|-------|-------------|----|----|------------|---------------------|
| | | H | W | D | | |
| EVCC31G1830P | 1664 | 39.2 | 30 | 18 | 117.3 | 14.5 |
| EVCC31G1836P | 1767 | 39.2 | 36 | 18 | 135.5 | 17.2 |
| EVCC31G1842P | 1869 | 39.2 | 42 | 18 | 152.5 | 20.0 |

EVCC41G18xxP • Prime Four High Combination Cabinet

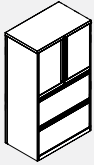

- Multi stor cabinet including hinged door upper section with one adjustable shelf; two fixed front file drawers below, lines up to 50" high panels.
- Locking.
- To add counterweight (W2 option), add \$195 list.

| PRODUCT CODE | PRICE | SIZE/INCHES | | | WEIGHT LBS | VOL FT ³ |
|--------------|-------|-------------|----|----|------------|---------------------|
| | | H | W | D | | |
| EVCC41G1830P | 2064 | 49.6 | 30 | 18 | 149.96 | 18.2 |
| EVCC41G1836P | 2201 | 49.6 | 36 | 18 | 172.96 | 21.6 |
| EVCC41G1842P | 2333 | 49.6 | 42 | 18 | 195.36 | 25.1 |

EVCC41H18xxP • Prime Four High Combination Cabinet

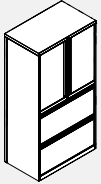

- Multi stor cabinet including hinged door upper section with one adjustable shelf; two fixed front file drawers below, lines up to 54" high panels.
- Locking.
- To add counterweight (W2 option), add \$195 list.

| PRODUCT CODE | PRICE | SIZE/INCHES | | | WEIGHT LBS | VOL FT ³ |
|--------------|-------|-------------|----|----|------------|---------------------|
| | | H | W | D | | |
| EVCC41H1830P | 2133 | 53.6 | 30 | 18 | 154.54 | 19.6 |
| EVCC41H1836P | 2264 | 53.6 | 36 | 18 | 178.54 | 23.3 |
| EVCC41H1842P | 2396 | 53.6 | 42 | 18 | 202.04 | 27.0 |

EVCC31C18xxP • Prime Five High Combination Cabinet

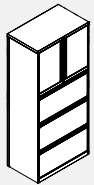

- Multi stor cabinet including hinged door upper section with one adjustable shelf; three fixed front file drawers below.
- Locking.
- To add counterweight (W2 option), add \$195 list.

| PRODUCT CODE | PRICE | SIZE/INCHES | | | WEIGHT LBS | VOL FT ³ |
|--------------|-------|-------------|----|----|------------|---------------------|
| | | H | W | D | | |
| EVCC51C1830P | 2518 | 65.6 | 30 | 18 | 188.5 | 23.9 |
| EVCC51C1836P | 2679 | 65.6 | 36 | 18 | 216.9 | 28.4 |
| EVCC51C1842P | 2840 | 65.6 | 42 | 18 | 245.5 | 32.9 |

EVLFA0718 • Prime Front to Back File Bars

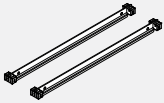

- Package of two, grey finish.

| PRODUCT CODE | PRICE | SIZE/INCHES | | | WEIGHT LBS | VOL FT ³ |
|--------------|-------|-------------|------|---|------------|---------------------|
| | | H | W | D | | |
| EVLFA0718 | 45 | 1 | 17.3 | 1 | 1 | 0.04 |

EVLFS • Prime Hanging File Bars

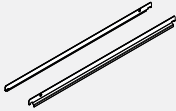

- Package of two, grey finish.

| PRODUCT CODE | PRICE | SIZE/INCHES | | | WEIGHT LBS | VOL FT ³ |
|--------------|-------|-------------|------|-----|------------|---------------------|
| | | H | W | D | | |
| EVLFA01 | 48 | 1.3 | 27.5 | 0.5 | 2 | 0.03 |
| EVLFA02 | 48 | 1.3 | 33.5 | 0.5 | 2.4 | 0.04 |
| EVLFA03 | 48 | 1.3 | 39.5 | 0.5 | 2.8 | 0.05 |

EVLFA1018 • Prime Plate Dividers

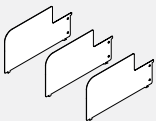

- Package of three, grey finish.

| PRODUCT CODE | PRICE | SIZE/INCHES | | | WEIGHT LBS | VOL FT ³ |
|--------------|-------|-------------|------|-----|------------|---------------------|
| | | H | W | D | | |
| EVLFA1018 | 49 | 7.25 | 13.5 | 0.2 | 4 | 0.07 |

EVLFA2418 • Prime Half Height Plate Dividers

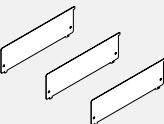

- Package of three, grey finish.

| PRODUCT CODE | PRICE | SIZE/INCHES | | | WEIGHT LBS | VOL FT ³ |
|--------------|-------|-------------|------|-----|------------|---------------------|
| | | H | W | D | | |
| EVLFA2418 | 49 | 3.95 | 13.5 | 0.2 | 2.2 | 0.04 |

EVLFA2018 • Prime EDP Adapters

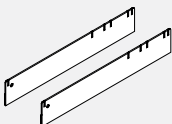

| PRODUCT CODE | PRICE | SIZE/INCHES | | | WEIGHT LBS | VOL FT ³ |
|--------------|-------|-------------|------|------|------------|---------------------|
| | | H | W | D | | |
| EVLFA2018 | 49 | 2.6 | 16.5 | 0.15 | 2.5 | 0.02 |

EVEK93/ EVCK093 • Keys and Replacement Lock Core (Profile 9300 Series)

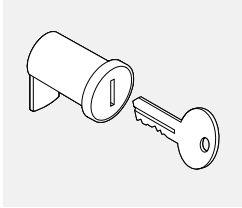

- EVEK93 - Set of two extra keys for existing 9300 Series storage. Specify core #. Key range W401-W550.
- EVCK093 - Includes one lock core and a set of two keys for 9300 Series storage. Specify core #. Key range W401-W550.

| PRODUCT CODE | PRICE | SIZE/INCHES | | | WEIGHT LBS | VOL FT ³ |
|-------------------------|-------|-------------|------|-----|------------|---------------------|
| | | H | W | D | | |
| EVEK93 EXTRA KEY | 19 | 1.75 | 0.75 | 0.2 | 0.2 | 0.01 |
| EVCK093 LOCK CORE & KEY | 31 | 2 | 1 | 0.5 | 0.4 | 0.01 |

EVKY/EVKC • Keys and Replacement Lock Core (Fileco Prime Series)

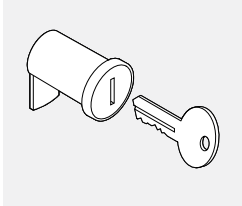

- EVKY - Set of two extra keys for existing Prime storage. Specify core #. Key range W401-W550.
- EVKC - Includes one lock core and a set of two keys for Prime storage. Specify core #. Key range W401-W550.

| PRODUCT CODE | PRICE | SIZE/INCHES | | | WEIGHT LBS | VOL FT ³ |
|----------------------|-------|-------------|------|-----|------------|---------------------|
| | | H | W | D | | |
| ESKY EXTRA KEY | 13 | 1.75 | 0.75 | 0.2 | 0.2 | 0.01 |
| ESKC LOCK CORE & KEY | 30 | 2 | 1 | 0.5 | 0.4 | 0.01 |

EVSA • Prime Extra Cabinet Shelves

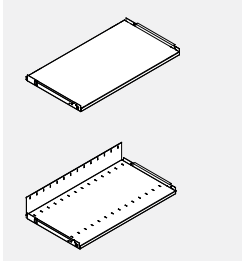

- Shelf, non-slotted.
- Shelf, slotted.

| PRODUCT CODE | PRICE | SIZE/INCHES | | | WEIGHT LBS | VOL FT ³ |
|---------------------|-------|-------------|------|----|------------|---------------------|
| | | H | W | D | | |
| Shelf, non-slotted. | | | | | | |
| EVSA011830 | 83 | 0.8 | 28.4 | 16 | 7.2 | 0.4 |
| EVSA011836 | 93 | 0.8 | 34.4 | 16 | 8.4 | 0.5 |
| EVSA011842 | 98 | 0.8 | 40.4 | 16 | 9.5 | 0.6 |
| Shelf, slotted. | | | | | | |
| EVSA021830 | 98 | 5.25 | 28.4 | 16 | 8.2 | 1.8 |
| EVSA021836 | 114 | 5.25 | 34.4 | 16 | 9.6 | 2.2 |
| EVSA021842 | 120 | 5.25 | 40.4 | 16 | 10.8 | 2.6 |

EVHPB6 - Worksurface Supporting 9300 Pedestal Bracket

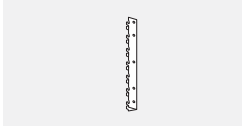

- Attaches to back edge of a pedestal and connects pedestal to panel connector.

| PRODUCT CODE | PRICE | SIZE/ H | INCHES | | WEIGHT LBS | VOL FT ³ |
|--------------|-------|---------|--------|---|------------|---------------------|
| | | | W | D | | |
| EVHPB6 | 28 | 13.5 | 1 | 1 | 0.5 | 0.5 |

EVHPB5 - Worksurface Supporting Pedestal Bracket and Filler For Prime

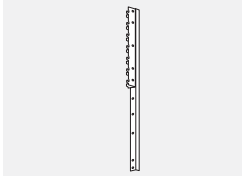

- Attaches to back edge of a pedestal and connects pedestal to panel connector.

| PRODUCT CODE | PRICE | SIZE/ H | INCHES | | WEIGHT LBS | VOL FT ³ |
|--------------|-------|---------|--------|---|------------|---------------------|
| | | | W | D | | |
| EVHPB5 | 28 | 28 | 1 | 2 | 0.5 | 0.5 |

EVALB • Load Bar

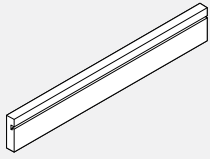

- Enables accessory items to be hung from a panel or wall.
- Includes end caps and mounting brackets.

| PRODUCT CODE | PRICE | SIZE/ INCHES | | |
|--------------|-------|--------------|----|---|
| | | H | W | D |
| EVALB24 | 133 | 2.25 | 24 | 1 |
| EVALB30 | 146 | 2.25 | 30 | 1 |
| EVALB36 | 161 | 2.25 | 36 | 1 |
| EVALB42 | 187 | 2.25 | 42 | 1 |
| EVALB48 | 213 | 2.25 | 48 | 1 |
| EVALB54 | 234 | 2.25 | 54 | 1 |
| EVALB60 | 247 | 2.25 | 60 | 1 |

EVALB2 • Ganging Load Bar - Top

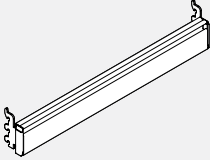

- Enables accessory items to be hung from a panel or wall
- Includes end caps and mounting brackets.
- Can connect to EVALB2-2 and/or EVALB2-3 Load Bars to create a multi-level bar or "Slat Wall" or can be used on its own.

| PRODUCT CODE | PRICE | SIZE/ INCHES | | |
|--------------|-------|--------------|----|---|
| | | H | W | D |
| EVALB224 | 104 | 2.25 | 24 | 1 |
| EVALB230 | 112 | 2.25 | 30 | 1 |
| EVALB236 | 116 | 2.25 | 36 | 1 |
| EVALB242 | 124 | 2.25 | 42 | 1 |
| EVALB248 | 131 | 2.25 | 48 | 1 |
| EVALB254 | 134 | 2.25 | 54 | 1 |
| EVALB260 | 139 | 2.25 | 60 | 1 |

EVALB22 • Ganging Load Bar - Middle

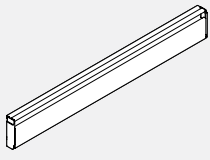

- Enables accessory items to be hung from a panel or wall.
- Includes end caps and is to be used in conjunction with the Ganging Load Bar-Top (EVALB) mounting brackets NOT included.
- Can connect to EVALB2 and/or EVALB2-3 Load Bars to create a multi-level bar or "Slat Wall". Multiples of EVALB2-2 can be joined one below the other to create the "Slat Wall".
- Must be used on conjunction with an EVALB2 or a combination of EVALB2 and EVALB2-3.

| PRODUCT CODE | PRICE | SIZE/ INCHES | | |
|--------------|-------|--------------|----|---|
| | | H | W | D |
| EVALB2-224 | 69 | 2.25 | 24 | 1 |
| EVALB2-230 | 77 | 2.25 | 30 | 1 |
| EVALB2-236 | 81 | 2.25 | 36 | 1 |
| EVALB2-242 | 90 | 2.25 | 42 | 1 |
| EVALB2-248 | 94 | 2.25 | 48 | 1 |
| EVALB2-254 | 102 | 2.25 | 54 | 1 |
| EVALB2-260 | 106 | 2.25 | 60 | 1 |

EVALB23 • Ganging Load Bar - Bottom

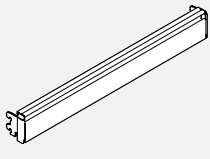

- Enables accessory items to be hung from a panel or wall.
- Includes end caps and mounting brackets.
- Must connect to EVALB2 and/or EVALB2-3 Load Bars to create a multi-level bar or "Slat Wall".
- Must be used on conjunction with an EVALB2 or a combination of EVALB2 and EVALB2-3.

| PRODUCT CODE | PRICE | SIZE/ INCHES | | |
|--------------|-------|--------------|----|---|
| | | H | W | D |
| EVALB2-324 | 102 | 2.25 | 24 | 1 |
| EVALB2-330 | 106 | 2.25 | 30 | 1 |
| EVALB2-336 | 112 | 2.25 | 36 | 1 |
| EVALB2-342 | 116 | 2.25 | 42 | 1 |
| EVALB2-348 | 126 | 2.25 | 48 | 1 |
| EVALB2-354 | 132 | 2.25 | 54 | 1 |
| EVALB2-360 | 136 | 2.25 | 60 | 1 |

EVACH01 • Coat Hook

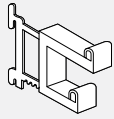

- Panel mounted coat hook.**
- Panel frame finish
 - Not available in Fog (FOG)
 - Not available in Metal Paper Accessory Colours

| PRODUCT CODE | PRICE | SIZE/ INCHES | | | WEIGHT VOL | |
|--------------|-------|--------------|------|---|------------|-----------------|
| | | H | W | D | LBS | FT ³ |
| EVACH01 | 69 | 3 | 0.75 | 3 | 0.2 | 0.001 |

EVACH02 • Panel Coat Hook

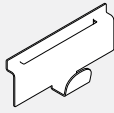

- Panel mounted coat hook.**
- Installed at panel top in groove between module and top trim.
 - Available in standard and premium paint colors.
 - Priced per six piece package.

| PRODUCT CODE | PRICE | SIZE/ INCHES | | | WEIGHT VOL | |
|--------------|-------|--------------|-----|-------|------------|-----------------|
| | | H | W | D | LBS | FT ³ |
| EVACH02 | 92 | 1 | 2.5 | 0.625 | 0.8 | 0.01 |

EVANP02 • Name Plate

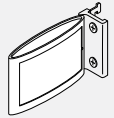

- **Name plate attaches to 1" increment slots of Evolve. It can be set either as a single-sided (parallel to panel surface) or double-sided (perpendicular to panel surface - for isle applications, displaying name on both sides).**
- Injection molded frame and die-cast base with **black rubberized finish.**
- Steel bracket and fasteners included
- Includes two slide-in name cards.

| PRODUCT CODE | PRICE | SIZE/ INCHES | | | WEIGHT VOL | |
|--------------|-------|--------------|-----|------|------------|-----------------|
| | | H | W | D | LBS | FT ³ |
| EVANP02 | 89 | 3.3 | 5.3 | 1.25 | 0.3 | 0.013 |

EVATB • Fabric Tackboard

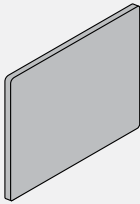

- To provide a tackable surface for notes and memos in a work area. Panel mounted.**
- Includes set of 4 mounting brackets.
 - Class "A" Fire Rated Fabric.

| PRODUCT CODE | PRICE | | SIZE/ INCHES | | | WEIGHT VOL | |
|--------------|-------|-----|--------------|----|------|------------|-----------------|
| | GR1 | GR2 | H | W | D | LBS | FT ³ |
| EVATB1730 | 261 | 274 | 17 | 30 | 0.25 | 3 | 0.416 |
| EVATB1736 | 298 | 312 | 17 | 36 | 0.25 | 4 | 0.500 |
| EVATB1742 | 340 | 353 | 17 | 42 | 0.25 | 4 | 0.583 |
| EVATB1748 | 378 | 397 | 17 | 48 | 0.25 | 5 | 0.666 |
| EVATB1754 | 419 | 441 | 17 | 54 | 0.25 | 5 | 0.750 |
| EVATB1760 | 460 | 483 | 17 | 60 | 0.25 | 6 | 0.833 |
| EVATB2130 | 261 | 270 | 21 | 30 | 0.25 | 3 | 0.416 |
| EVATB2136 | 298 | 307 | 21 | 36 | 0.25 | 4 | 0.500 |
| EVATB2142 | 340 | 351 | 21 | 42 | 0.25 | 4 | 0.583 |
| EVATB2148 | 378 | 392 | 21 | 48 | 0.25 | 5 | 0.666 |
| EVATB2154 | 419 | 439 | 21 | 54 | 0.25 | 5 | 0.750 |
| EVATB2160 | 460 | 482 | 21 | 60 | 0.25 | 6 | 0.833 |
| EVATB2430 | 261 | 271 | 24 | 30 | 0.25 | 3 | 0.416 |
| EVATB2436 | 298 | 312 | 24 | 36 | 0.25 | 4 | 0.500 |
| EVATB2442 | 352 | 378 | 24 | 42 | 0.25 | 4 | 0.583 |
| EVATB2448 | 394 | 419 | 24 | 48 | 0.25 | 5 | 0.666 |
| EVATB2454 | 441 | 509 | 24 | 52 | 0.25 | 5 | 0.750 |
| EVATB2460 | 460 | 482 | 24 | 60 | 0.25 | 6 | 0.833 |

EVHTVM • TV Mount

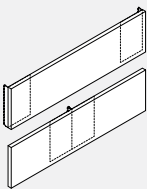

- Laminate panel with two mounting brackets to be installed on Evolve panels.
- TV Mount can be installed on panel of equal width or both brackets can be attached in middle for installing on single connector.
- TV frame not included, TV frame to be ordered separately.
- Note: TV frame must be securely attach to laminate panel. Care should be taken to attach TV frame using correct fasteners.
- Failure to do so may result in collapse of unit and subsequent possible injury.

| PRODUCT CODE | PRICE | SIZE/INCHES | | | WEIGHT LBS | VOL FT ³ |
|--------------|-------|-------------|----|-----|------------|---------------------|
| | | H | W | D | | |
| EVHTVM24 | 173 | 11 | 24 | 1.0 | 14.00 | 0.46 |
| EVHTVM30 | 190 | 11 | 30 | 1.0 | 17.00 | 0.52 |
| EVHTVM36 | 204 | 11 | 36 | 1.0 | 19.00 | 0.60 |
| EVHTVM42 | 219 | 11 | 42 | 1.0 | 22.00 | 0.68 |

EVPMP542 • Privacy Mesh Divider

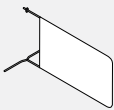

- **Divider attaches to connector.**
- Available with Visionknit mesh only.
- Current available (others available upon request)
 - GRY Grey
 - BOR Burnt Orange
- Wire frame upholstered in Visionknit mesh.
- Visionknit mesh easy to replace.
- Wire frame painted in standard paint finishes.
- For each mesh colour ordered, minimum order must be 25 pcs.
- If mesh colour ordered is less than 25 pcs, there will be upcharge fee \$132 net per each mesh colour.
- Note: Divider can be only used with 42"h. segmented panels (24" bottom and 12" top module configuration only).
- Divider attaches to top 12" module.

| PRODUCT CODE | PRICE | SIZE/ INCHES | | | WEIGHT VOL | |
|--------------|-------|--------------|----|-------|------------|-----------------|
| | | H | W | D | LBS | FT ³ |
| EVPMP542 | 157 | 12 | 24 | 0.250 | 5 | 0.416 |

EVAWB • Write Board

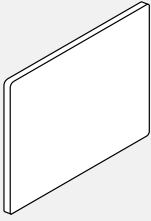

- To provide a writing surface in a work area. Panel mounted.
- Includes set of 4 mounting brackets.
- Black trim only

| PRODUCT CODE | PRICE | SIZE/ H | INCHES W | WEIGHT LBS | VOL FT ³ |
|--------------|-------|---------|----------|------------|---------------------|
| EVAWB2130 | 293 | 21 | 30 | 3 | 0.416 |
| EVAWB2136 | 333 | 21 | 36 | 4 | 0.500 |
| EVAWB2142 | 372 | 21 | 42 | 4 | 0.588 |
| EVAWB2148 | 433 | 21 | 48 | 5 | 0.833 |
| EVAWB2430 | 293 | 24 | 30 | 3 | 0.416 |
| EVAWB2436 | 333 | 24 | 36 | 4 | 0.500 |
| EVAWB2442 | 372 | 24 | 42 | 4 | 0.588 |
| EVAWB2448 | 433 | 24 | 48 | 5 | 0.833 |

EVAMT • Marker Tray



- Provides a tray for storage of markers, erasers. etc.
- Attaches to the bottom of the White Marker Board.

| PRODUCT CODE | PRICE | SIZE/ H | INCHES W | WEIGHT LBS | VOL FT ³ |
|--------------|-------|---------|----------|------------|---------------------|
| EVAMT12 | 16 | | 12 | 0.5 | 0.01 |

EVSOFD • Overhead Divider

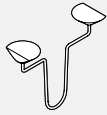

- Attaches to EVS0F12 or EVS0F13 Overhead top shelf inside the overhead.
- Provides a rigid division for books and binders.
- Sold per pair.

| PRODUCT CODE | PRICE | SIZE/ H | INCHES W | WEIGHT LBS | VOL FT ³ |
|--------------|-------|---------|----------|------------|---------------------|
| EVSOFD01 | 58 | 10 | 0.1875 | 0.8 | 0.02 |

EVAOMFD • Dry Erase Marker Board

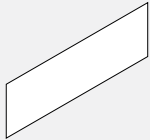

- Adheres magnetically to the door fo a flipper door overhead.

| PRODUCT CODE | PRICE | SIZE/ H | INCHES W | D |
|--------------|-------|---------|----------|------|
| EVAOMFD24 | 227 | 14.4 | 22.8 | 0.05 |
| EVAOMFD30 | 261 | 14.4 | 28.8 | 0.05 |
| EVAOMFD36 | 299 | 14.4 | 34.8 | 0.05 |
| EVAOMFD42 | 341 | 14.4 | 40.8 | 0.05 |
| EVAOMFD48 | 373 | 14.4 | 46.8 | 0.05 |
| EVAOMFD54 | 391 | 14.4 | 52.8 | 0.05 |
| EVAOMFD60 | 422 | 14.4 | 58.8 | 0.05 |

EVAOMBW • Dry Erase Marker Board

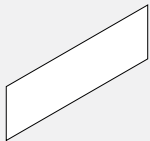

- Adheres magnetically to the back wall of the AODA Overhead.

| PRODUCT CODE | PRICE | SIZE/ H | INCHES W | D |
|--------------|-------|---------|----------|------|
| EVAOMBW30 | 261 | 14.4 | 29.2 | 0.05 |
| EVAOMBW36 | 299 | 14.4 | 35.5 | 0.05 |
| EVAOMBW42 | 341 | 14.4 | 41.2 | 0.05 |
| EVAOMBW48 | 373 | 14.4 | 47.2 | 0.05 |
| EVAOMBW54 | 391 | 14.4 | 53.2 | 0.05 |
| EVAOMBW60 | 422 | 14.4 | 59.2 | 0.05 |

EVED50AC • Duo Module with A+C

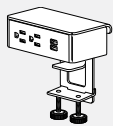

- The Duo power module is completely integrated with a mounting clamp to attach to the edge of a worksurface.
- Provides two 15 Amp 120 Volt AC Receptacles; 2.4 amp USB-A port and 60 watt USB-C power delivery port.
- 10' long three-prong cord.
- Available in W - White or B - Black as indicated by last letter of model number.

| PRODUIT CODE | PRIX | TAILLE/ H | POUCES L | P | POIDS LB | VOLUME PI ³ |
|--------------|------|-----------|----------|-----|----------|------------------------|
| EVED50ACW | 695 | 3 | 5.5 | 3.2 | 3 | 0.2 |
| EVED50ACB | 695 | 3 | 5.5 | 3.2 | 3 | 0.2 |

EVEDU51AC • Duo Under Module

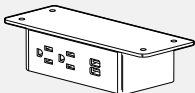

- The Duo under power module comes with a thin flush mounting bracket to attach to the underside of a work surface or above work surface shelves.
- Provides two 15 Amp 120 Volt AC Receptacles; 2.4 amp USB-A port and 60 watt USB-C power delivery port.
- 10' long three-prong cord.
- Available in W - White or B - Black as indicated by last letter of model number.

| PRODUIT CODE | PRIX | TAILLE/ H | POUCES L | P | POIDS LB | VOLUME PI ³ |
|--------------|------|-----------|----------|-----|----------|------------------------|
| EVEDU51ACW | 695 | 1.8 | 5.5 | 2.8 | 3 | 0.2 |
| EVEDU51ACB | 695 | 1.8 | 5.5 | 2.8 | 3 | 0.2 |

EVEDB52AC • Duo Under Module with A+C



- The Duo bezel power module is embedded and flush-mounted in a piece of furniture or a work surface.
- Provides two 15 Amp 120 Volt AC Receptacles; 2.4 amp USB-A port and 60 watt USB-C power delivery port.
- 10' long three-prong cord, silver trim.
- Available in W - White or B - Black as indicated by last letter of model number.
- Will not work on W thick worksurfaces, please contact your Customer Service Representative for specific surface applications.

| PRODUCT CODE | PRICE | SIZE/ H | INCHES W | D | WEIGHT LBS | VOL FT ³ |
|--------------|-------|---------|----------|-----|------------|---------------------|
| EVEDB52ACW | 695 | 4 | 6.5 | 3.2 | 3 | 0.2 |
| EVEDB52ACB | 695 | 4 | 6.5 | 3.2 | 3 | 0.2 |

EVETP53AC • Trio Module with A+C



- The Trio plus power module is completely integrated with a mounting clamp to attach to the edge of a work surface or above work surface shelves.
- Provides two 15 Amp 120 Volt AC Receptacles; 2.4 amp USB-A port and 60 watt USB-C power delivery port and an adapter kit containing blank cover, HDMI, RJ45 or VGA adapter brackets. Note: HDMI, RJ45 and VGA connectors are not included.
- 10' long three-prong cord, silver trim.
- Available in W - White or B - Black as indicated by last letter of model number.

| PRODUCT CODE | PRICE | SIZE/ INCHES | | | WEIGHT VOL | |
|--------------|-------|--------------|---|-----|------------|-----------------|
| | | H | W | D | LBS | FT ³ |
| EVETP53ACW | 735 | 3 | 8 | 3.2 | 2.5 | 0.14 |
| EVETP53ACB | 735 | 3 | 8 | 3.2 | 2.5 | 0.14 |

EVETB55AC • Trio Plus Module with A+C



- The Trio plus bezel power module is embedded and flush-mounted in a piece of furniture or a work surface.
- Provides two 15 Amp 120 Volt AC Receptacles; 2.4 amp USB-A port and 60 watt USB-C power delivery port and an adapter kit containing blank cover, HDMI, RJ45 or VGA adapter brackets. Note: HDMI, RJ45 and VGA connectors are not included.
- 10' long three-prong cord, silver trim.
- Available in W - White or B - Black as indicated by last letter of model number.
- Will not work on W thick worksurfaces, please contact your Customer Service Representative for specific surface applications.

| PRODUCT CODE | PRICE | SIZE/ INCHES | | | WEIGHT VOL | |
|--------------|-------|--------------|---|-----|------------|-----------------|
| | | H | W | D | LBS | FT ³ |
| EVETB55ACW | 752 | 4 | 9 | 3.2 | 2.5 | 0.14 |
| EVETPB55ACB | 752 | 4 | 9 | 3.2 | 2.5 | 0.14 |

EVMA1 • Single Clamp Mount Monitor Arm

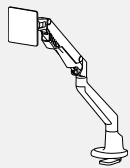

- Finger touch dynamic height adjustment, 12" height range. 4.4 to 19.8 lbs. per monitor loading capacity; accepts screen size 17"-30".
- Maximum monitor width of 34".
- Maximum of 20.5" extension from rear of desk to back of monitor, folds to 4.5".
- Tilt, pan and landscape to portrait rotation; quick release VESA plate, 180 degree lock out.
- Clamp mount and grommet mount options included, accommodates 0.5" to 2" thick tops.
- Accepts mini slide arm GAMS.
- Available in TUN - Tungsten only.

| PRODUCT CODE | PRICE | SIZE/ INCHES | | | WEIGHT VOL | |
|--------------|-------|--------------|---|-----|------------|-----------------|
| | | H | W | D | LBS | FT ³ |
| EVMA1 | 418 | 21 | | 5.5 | 6.6 | 0.4 |

EVMA2 • Double Clamp Mount Monitor Arm

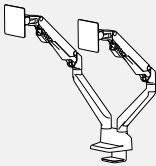

- Finger touch dynamic height adjustment, 12" height range.
- 4.4 to 19.8 lbs. per monitor loading capacity; accepts screen size 17"-30".
- Maximum monitor width of 34".
- Maximum of 20.5" extension from rear of desk to back of monitor, folds to 4.5".
- Tilt, pan and landscape to portrait rotation; quick release VESA plate, 180 degree lock out.
- Clamp mount and grommet mount options included, accommodates 0.5" to 2" thick tops.
- Accepts mini slide arm GAMS.
- Available in TUN - Tungsten only.

| PRODUCT CODE | PRICE | SIZE/ INCHES | | | WEIGHT VOL | |
|--------------|-------|--------------|---|-----|------------|-----------------|
| | | H | W | D | LBS | FT ³ |
| EVMA2 | 734 | 21 | | 5.5 | 12.8 | 1 |

EVAMS • Mini Slide Monitor Arm

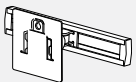

- Works with EVMA1 and EVMA2 monitor arms.
- 9" slide, loading capacity 13.2lbs.
- Quick release VESA plate.
- Available in TUN - Tungsten only.

| PRODUCT CODE | PRICE | SIZE/ INCHES | | | WEIGHT VOL | |
|--------------|-------|--------------|----|---|------------|-----------------|
| | | H | W | D | LBS | FT ³ |
| EVAMS | 145 | 4.5 | 11 | 6 | 3.3 | 0.3 |

EVELEDVS • LED Single Arm Lamp

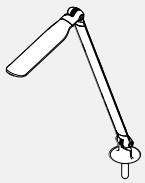

- 7 System watts, 18-fractional LEDs.
- 3500K 250 lumens, 84CRI.
- Soft touch - instant on, fade to off.
- Infinite dimming 100% down to 15%, last state memory.
- Standard 10 hours turn off (ATO).
- 50,000 hour life LEDs.
- 15 watt, 24 volt wall transformer, 6' cord.
- White (WHT)or Black (BLK) - Must specify colour choice.

| PRODUCT CODE | PRICE | SIZE/ INCHES | | | WEIGHT VOL | |
|------------------------------|-------|--------------|---|----|------------|-----------------|
| | | H | W | D | LBS | FT ³ |
| EVELEDVS | 616 | 8 | 7 | 33 | 7.3 | 0.98 |
| With occupancy sensor | | | | | | |
| EVELEDVSO | 920 | 10 | 9 | 35 | 8.3 | 1.51 |

- UL, CUL and CSA compliant, ETL Listed.
- Base not included.

EVELEDVD • LED Double Arm Lamp

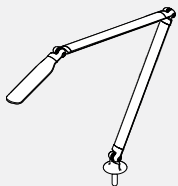

- 7 System watts, 18-fractional LEDs.
- 3500K 250 lumens, 84CRI.
- Double arm articulation with 20" base to head reaches.
- Soft touch - instant on, fade to off.
- Infinite dimming 100% down to 15%, last state memory.
- Standard 10 hours turn off (ATO).
- 50,000 hour life LEDs.
- 15 watt, 24 volt wall transformer, 6' cord.
- White (WHT)or Black (BLK) - Must specify colour choice.

| PRODUCT CODE | PRICE | SIZE/ INCHES | | | WEIGHT VOL | |
|------------------------------|-------|--------------|---|----|------------|-----------------|
| | | H | W | D | LBS | FT ³ |
| EVELEDVD | 633 | 8 | 7 | 33 | 7.6 | 1.02 |
| With occupancy sensor | | | | | | |
| EVELEDVDO | 931 | 10 | 9 | 35 | 8.6 | 1.57 |

- UL, CUL and CSA compliant, ETL Listed.
- Base not included.

EVELEDRS • LED Single Arm Lamp

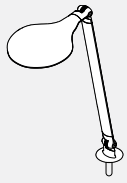

- 7 System watts, 18-fractional LEDs.
- 3500K 250 lumens, 84CRI.
- Soft touch - instant on, fade to off.
- Infinite dimming 100% down to 15%, last state memory.
- Standard 10 hours turn off (ATO).
- 50,000 hour life LEDs.
- 15 watt, 24 volt wall transformer, 6' cord.
- White (WHT) or Black (BLK) - Must specify colour choice.

| PRODUCT CODE | PRICE | SIZE/ H | INCHES W | D | WEIGHT LBS | VOL FT ³ |
|------------------------------|-------|---------|----------|----|------------|---------------------|
| EVELEDRS | 616 | 8 | 7 | 33 | 7.3 | 0.98 |
| With occupancy sensor | | | | | | |
| EVELEDRSO | 920 | 10 | 9 | 35 | 8.3 | 1.51 |

- UL, CUL and CSA compliant, ETL Listed.
- Base not included.

EVELEDRD • LED Double Arm Lamp

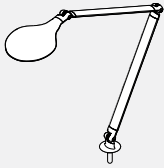

- 7 System watts, 18-fractional LEDs.
- 3500K 250 lumens, 84CRI.
- Double arm articulation with 20" base to head reaches.
- Soft touch - instant on, fade to off.
- Infinite dimming 100% down to 15%, last state memory.
- Standard 10 hours turn off (ATO).
- 50,000 hour life LEDs.
- 15 watt, 24volt wall transformer, 6' cord.
- White (WHT) or Black (BLK) - Must specify colour choice.

| PRODUCT CODE | PRICE | SIZE/ H | INCHES W | D | WEIGHT LBS | VOL FT ³ |
|------------------------------|-------|---------|----------|----|------------|---------------------|
| EVELEDRD | 633 | 8 | 7 | 33 | 7.6 | 1.02 |
| With occupancy sensor | | | | | | |
| EVELEDRDO | 931 | 10 | 9 | 35 | 8.6 | 1.57 |

- UL, CUL and CSA compliant, ETL Listed.
- Base not included.

Lamp Mounting Options



Grommet Mount

| PRODUCT CODE | PRICE | SIZE/ H | INCHES W | D | WEIGHT LBS | VOL FT ³ |
|--------------|-------|---------|----------|---|------------|---------------------|
| EVELEDASM | 155 | 3 | 6 | 6 | 3 | 0.06 |



Worksurface Mount

| PRODUCT CODE | PRICE | SIZE/ H | INCHES W | D | WEIGHT LBS | VOL FT ³ |
|--------------|-------|---------|----------|---|------------|---------------------|
| EVELEDACM | 155 | 3 | 6 | 6 | 2 | 0.04 |



Slatwall Mount

| PRODUCT CODE | PRICE | SIZE/ H | INCHES W | D | WEIGHT LBS | VOL FT ³ |
|--------------|-------|---------|----------|---|------------|---------------------|
| EVELEDASW | 155 | 3 | 6 | 6 | 3 | 0.06 |



Panel Mount

| PRODUCT CODE | PRICE | SIZE/ H | INCHES W | D | WEIGHT LBS | VOL FT ³ |
|--------------|-------|---------|----------|---|------------|---------------------|
| EVELEDAPM | 155 | 3 | 6 | 6 | 3 | 0.06 |

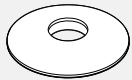

Weighted Base

| PRODUCT CODE | PRICE | SIZE/ H | INCHES W | D | WEIGHT LBS | VOL FT ³ |
|--------------|-------|---------|----------|----|------------|---------------------|
| EVELEDAFS | 173 | 4 | 12 | 12 | 6 | 0.50 |

EVABB01 • Binder Bin



- Load bar/accessory rail mounted metal binder bin.
- Panel frame finish

| PRODUCT CODE | PRICE | SIZE/ H | INCHES W | D | WEIGHT LBS | VOL FT ³ |
|--------------|-------|---------|----------|------|------------|---------------------|
| EVABB01 | 58 | 9 | 5.75 | 9.25 | 1.85 | 0.21 |

EVAFS01 • Flip Sorter

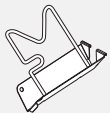

- Load bar/accessory rail mounted metal flip sorter. Comes with nickel plated wire.
- Panel frame finish

| PRODUCT CODE | PRICE | SIZE/ H | INCHES W | D | WEIGHT LBS | VOL FT ³ |
|--------------|-------|---------|----------|---|------------|---------------------|
| EVAFS01 | 40 | 9 | 3 | 9 | 0.6 | 0.14 |

EVASS01 • Slant Sorter



- Load bar/accessory rail mounted metal slant sorter.
- Panel frame finish

| PRODUCT CODE | PRICE | SIZE/ H | INCHES W | D | WEIGHT LBS | VOL FT ³ |
|--------------|-------|---------|----------|---|------------|---------------------|
| EVASS01R | 35 | 9.25 | 2.75 | 9 | 1 | 0.28 |
| EVASS01L | 35 | 9.25 | 2.75 | 9 | 1 | 0.28 |

Right hand Shown

EVALT01 • Letter Tray

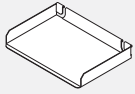

- Load bar/accessory rail mounted metal letter tray.
- Panel frame finish

| PRODUCT CODE | PRICE | SIZE/ H | INCHES W | D | WEIGHT LBS | VOL FT ³ |
|--------------|-------|---------|----------|------|------------|---------------------|
| EVALT01 | 43 | 1.75 | 12 | 8.75 | 0.5 | 0.15 |

EVALT02 • Legal Tray

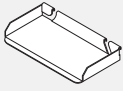

- Load bar/accessory rail mounted metal legal tray.
- Panel frame finish

| PRODUCT CODE | PRICE | SIZE/ H | INCHES W | D | WEIGHT LBS | VOL FT ³ |
|--------------|-------|---------|----------|------|------------|---------------------|
| EVALT02 | 58 | 1.75 | 14.7 | 8.75 | 0.5 | 0.15 |

EVAMB01 • Media Bin

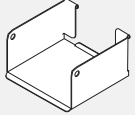

- Load bar/accessory rail mounted.
- Panel frame finish

| PRODUCT CODE | PRICE | SIZE/ H | INCHES W | D | WEIGHT LBS | VOL FT ³ |
|--------------|-------|---------|----------|------|------------|---------------------|
| EVAMB01 | 43 | 3 | 5.75 | 5.25 | 0.8 | 0.05 |

EVAUT01 • Utility Tray

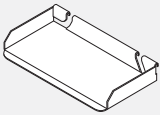

- Load bar/accessory rail mounted metal utility tray.
- Panel frame finish

| PRODUCT CODE | PRICE | SIZE/ H | INCHES W | D | WEIGHT LBS | VOL FT ³ |
|--------------|-------|---------|----------|------|------------|---------------------|
| EVAUT01 | 30 | 1 | 7.5 | 3.75 | 0.5 | 0.02 |

EVAPP01 • Mail Box

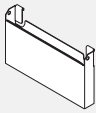

- Load bar/accessory rail mounted.
- Panel frame finish

| PRODUCT CODE | PRICE | SIZE/ H | INCHES W | D | WEIGHT LBS | VOL FT ³ |
|--------------|-------|---------|----------|------|------------|---------------------|
| EVAPP01 | 72 | 7 | 12 | 1.75 | 2 | 0.25 |

EVATH01 • Telephone Holder

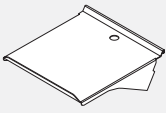

- Load bar/rail mounted telephone holder.
- Panel frame finish

| PRODUCT CODE | PRICE | SIZE/ H | INCHES W | D | WEIGHT LBS | VOL FT ³ |
|--------------|-------|---------|----------|----|------------|---------------------|
| EVATH01 | 68 | 2 | 8 | 10 | 2 | 0.26 |

EVSPD1921 • Pencil Drawer

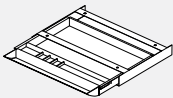

- Provides accommodation for writing instruments and small items at the workspace.
- Attaches to the underside of worksurface with drawer slides.
- Available in Black ABS Only

| PRODUCT CODE | PRICE | TAILLE/ H | POUCES L | P | POIDS LB | VOLUME PI ³ |
|--------------|-------|-----------|----------|------|----------|------------------------|
| EVSPD1921 | 125 | 1.9 | 21.2 | 16.1 | 0.5 | 0.3 |

EVFPD-WS • Worksurface Felt Divider

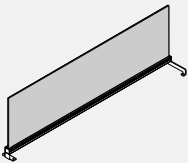

- Privacy felt divider integrated into an aluminum top trim.
- Attaches on top of a worksurface to add privacy or divide space.
- Must be used at connector location.
- Includes aluminum trim with channel, felt tile and brackets.
- 9 mm felt material is tackable and comes in 18 different colors. Please specify felt finish.
- Aluminum extrusion and brackets available in standard paint finishes.
- Felt tile and attachment hardware to ship separately.

| PRODUCT CODE | PRICE | SIZE/ H | INCHES W | D | WEIGHT LBS | VOL FT ³ |
|--------------|-------|---------|----------|---|------------|---------------------|
| EVFPD1818WS | 158 | 18 | 18 | 1 | 2.26 | 0.75 |
| EVFPD1824WS | 177 | 18 | 24 | 1 | 2.77 | 0.94 |
| EVFPD1830WS | 199 | 18 | 30 | 1 | 3.29 | 1.13 |
| EVFPD1836WS | 216 | 18 | 36 | 1 | 3.8 | 1.31 |

PRIVA NOTES

GENERAL INFORMATION

- Priva™ acoustic pods provide a place for personal privacy, focus and online collaboration, away from the commotion of the open office.
- Integrated ventilation (55 cubic feet per minute) and low-voltage LED lighting are motion-sensor activated to reduce energy consumption while providing a comfortable environment for short or longer stays.
- The tempered glass entrance door, in combination with an optional glass back panel, reduces the sense of confinement.

CONSTRUCTION

- Assembles in less than 90 minutes. Once complete, simply plug in and get to work!
- Priva has been tested and complies with all BIFMA mechanical tests.
- Exterior is clad in 3/4" thermally fused laminate with a 10mm tempered glass door and glass (POD1G, POD2G, POD3G) or laminate back panel (POD1L).
- Exterior corner details are made of extruded aluminum
- Internal frame is comprised of 14 gauge steel beams
- Interior is clad in PET (recommended for greater acoustic properties)
- Laminate interior is optional.
- Pod ceiling is Designer White laminate
- Interior carpet flooring is comprised of eco-friendly Nylon fiber, solution dyed with a polypropylene backing.
- Laminate touch-down shelf is standard in Designer White (DWT) laminate.

DIMENSIONS

- Door: 32" w x 88" h
- Shelf: 24" w x 8" d x 40" h
- Electrical cord is 10' long.

Exterior Laminate Finishes

| | |
|-----------------|-----|
| Absolute Acajou | ACJ |
| Asian Night | ASN |
| Black | BLK |
| Brushed Cobalt | BRC |
| Clear Maple | CMB |
| Dark Espresso | DES |
| Designer White | DWT |
| Noce Biondo | NBL |
| Noce Grigio | NGL |
| Noce Leggero | NEL |
| Noce Medio | NML |
| Storm Grey | SOG |
| Walnut Heights | WHE |
| White Chocolate | WHC |
| Winter Cherry | WCR |

Exterior Frame Finishes

| | |
|----------------|-----|
| Black | BLK |
| Charcoal | CHR |
| Designer White | DWT |
| Tungsten | TUN |

Hardware Finishes (Handle + Hinge)

| | |
|--------|----|
| Black | BK |
| Silver | SI |

Interior Finishes - Select Laminate or PET

PET

| | |
|----------|-----|
| Graphite | GPH |
| Pewter | PWT |
| Mist | MTS |

Laminate

| | |
|----------------|-----|
| Black | BLK |
| Designer White | DWT |
| Storm Grey | SOG |

Interior Finish (Laminate or PET)

Always Designers White (DWT) laminate

Hardware Finishes

Exterior Laminate

Exterior Frame

Glass front is standard with Black painted frame

Exterior Dimensions

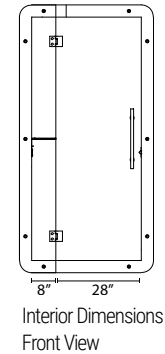
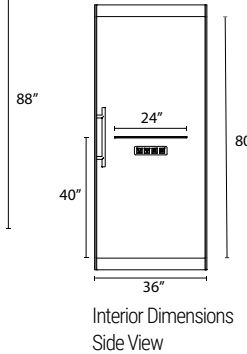
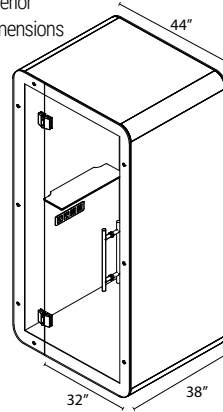

Exterior Dimensions

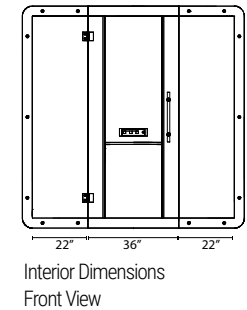
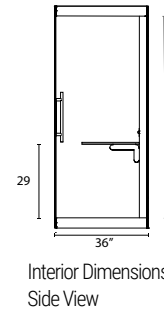
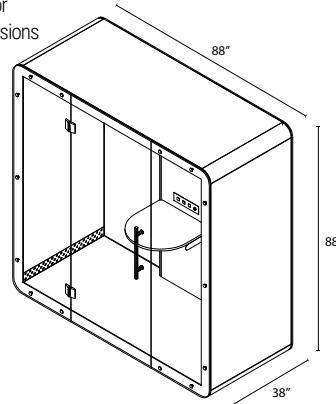

Exterior Dimensions

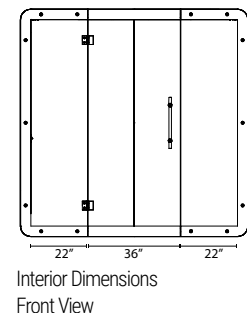
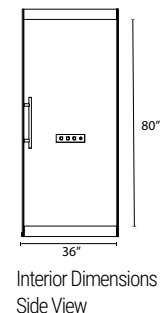
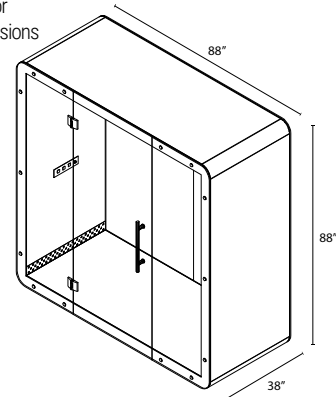

POD1G • Single User Pod - Glass Back Panel

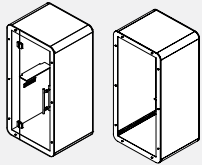

Front View/Rear View

- Acoustic Pod includes laminate exterior with aluminum frame. PET interior provides acoustic privacy.
- Laminate interior optional for easy cleaning. Door is 10mm tempered glass with a glass back panel.
- Power + Connectivity: 2 AC outlets and 2 charging USB-A ports coupled with an occupancy sensor controlling two 12V DC fans and an LED light circuit, ensuring comfort in even the smallest of enclosed spaces, while keeping power consumption at a minimum.
- Acoustic Ratings: NIC-36, STI .07
- Airflow Specifications: CFM 55

| PRODUCT CODE | PRICE | SIZE/INCHES | | | WEIGHT LBS | VOL FT ³ |
|--------------|-------|-------------|----|----|------------|---------------------|
| | | H | W | D | | |
| POD1G | 25852 | 88 | 44 | 38 | 800 | 85 |

POD1L • Single User Pod - Laminate Back Panel

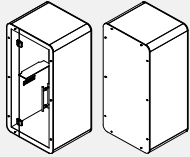

Front View/Rear View

- Acoustic Pod includes laminate exterior with aluminum frame. PET interior provides acoustic privacy.
- Laminate interior optional for easy cleaning. Door is 10mm tempered glass with a laminate back panel.
- Power + Connectivity: 2 AC outlets and 2 charging USB-A ports coupled with an occupancy sensor controlling two 12V DC fans and an LED light circuit, ensuring comfort in even the smallest of enclosed spaces, while keeping power consumption at a minimum.
- Acoustic Ratings: NIC-36, STI .07
- Airflow Specifications: CFM 55

| PRODUCT CODE | PRICE | SIZE/INCHES | | | WEIGHT LBS | VOL FT ³ |
|--------------|-------|-------------|----|----|------------|---------------------|
| | | H | W | D | | |
| POD1L | 25852 | 88 | 44 | 38 | 800 | 85 |

POD2G • Two Person Meeting Pod - Glass/Laminate Back Panel

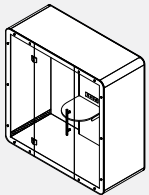

- Acoustic Meeting Pod includes laminate exterior with aluminum frame. PET interior provides acoustic privacy
- Includes D-Shaped Table 22.75" w x 22.75" d x 1" thick.
- Table can be installed at 26h, 28h or 30h
- Door is 10mm tempered glass
- Interior dimensions: 80" w x 36" d x 80" h
- Power + Connectivity: 2 AC outlets, USB-C and USB-A ports coupled with an occupancy sensor controlling two 12V DC fans and two LED lights, ensuring comfort in even the smallest of enclosed spaces, while keeping power consumption at a minimum.
- Acoustic Ratings: NIC-36, STI .07
- Airflow Specifications: CFM 55

| PRODUCT CODE | PRICE | SIZE/INCHES | | | WEIGHT LBS | VOL FT ³ |
|--------------|-------|-------------|----|----|------------|---------------------|
| | | H | W | D | | |
| POD2G | 46522 | 88 | 88 | 38 | 1200 | 170 |

POD3G • Office Pod - Glass Back Panel

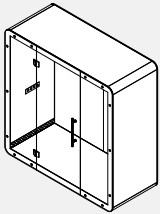

- Acoustic Office Pod includes laminate exterior with aluminum frame. PET interior provides acoustic privacy.
- Full tempered glass back
- Can accommodate a single task chair and small desk 36w x 24d (sold separately)
- Door is 10mm tempered glass
- Interior dimensions: 80" w x 36" d x 80" h
- Power + Connectivity: 2 AC outlets, USB-C and USB-A ports coupled with an occupancy sensor controlling two 12V DC fans and two LED lights, ensuring comfort in even the smallest of enclosed spaces, while keeping power consumption at a minimum.
- Acoustic Ratings: NIC-36, STI .07
- Airflow Specifications: CFM 55

| PRODUCT CODE | PRICE | SIZE/INCHES | | | WEIGHT LBS | VOL FT ³ |
|--------------|-------|-------------|----|----|------------|---------------------|
| | | H | W | D | | |
| POD3G | 43102 | 88 | 88 | 38 | 1200 | 170 |

Why Softpod?

Softpod is where flexibility meets focus bringing a new work style option to the Global family of products. This sleek privacy pod is a cozy, secluded space dedicated to focus. Its multi segmented dividers and hexagon shape offer flexibility for both privacy and space planning.

Divider:

- PET Felt / aluminum composition 1 3/8" thick
- Channel edge allows for add-on privacy
- Acoustic rating of .60 NRC and 13 STC

PET Felt features:

- Tackable acoustic material
- Soft form capability

Electrical:

- Simple interconnect / direct plug-in or
- Hard wire formats

Storage:

- Solution based

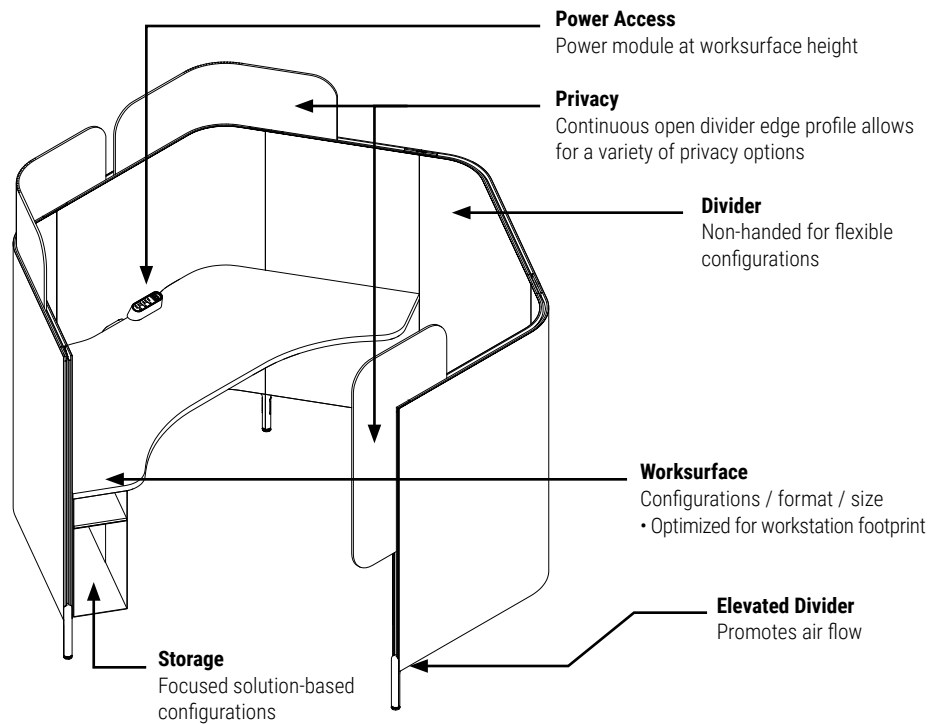

Height Adjustable Pod

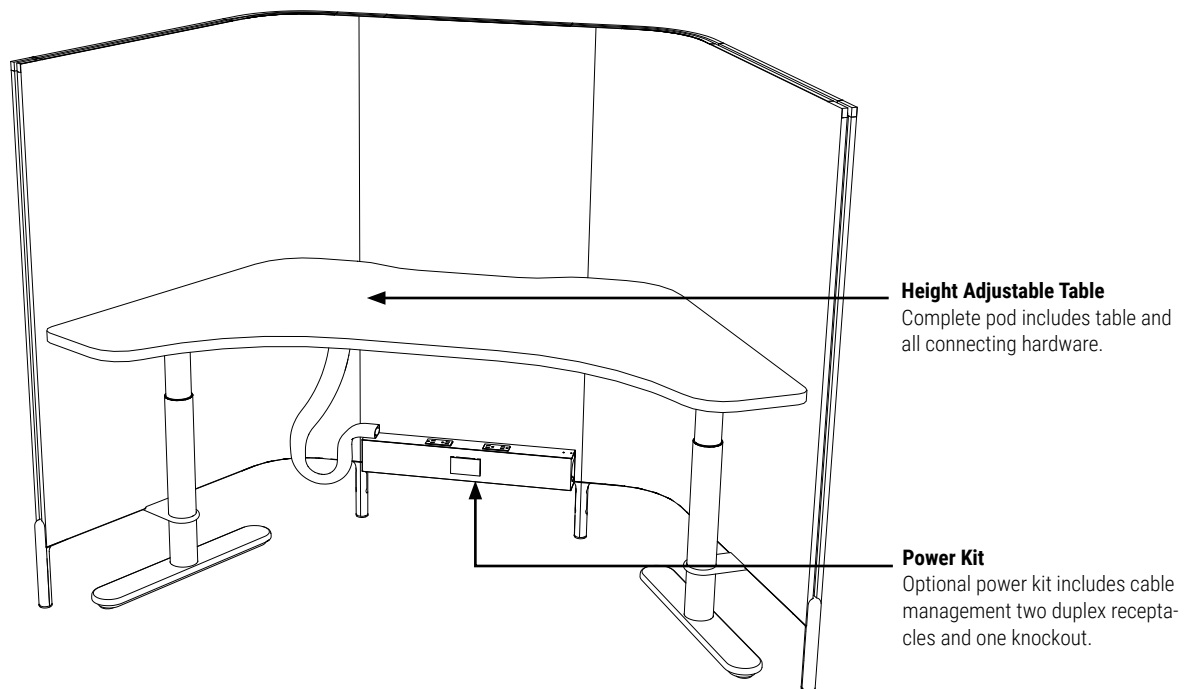

Why Softpod?

Freestanding Lounge Pods

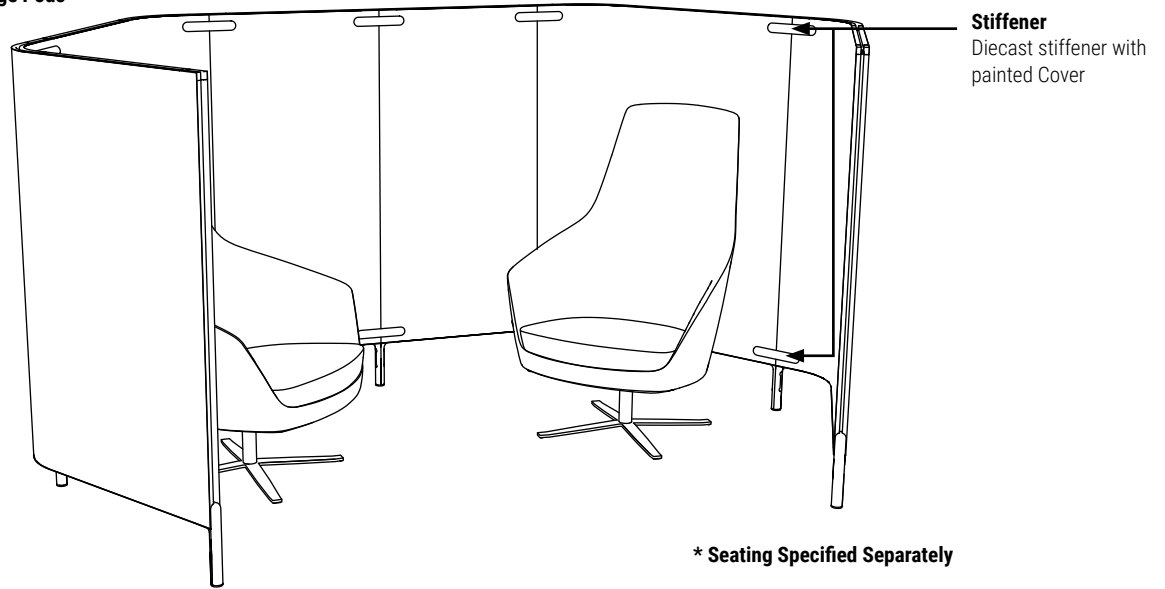

Meeting Pods

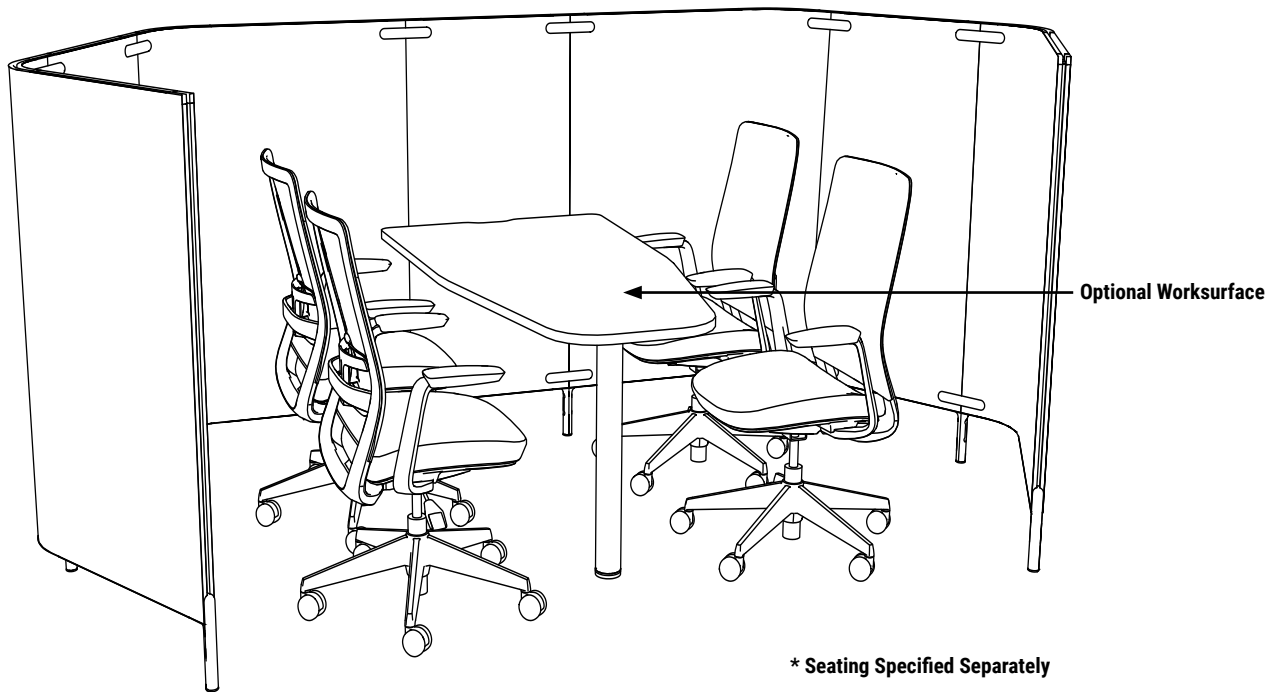

Statement Of Line

Softpods

HX2P5452SW
Softpod with 2 Dividers
and Worksurface

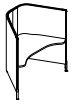

HX2PM5452SW
Mobile Softpod
with 2 Dividers and
Worksurface

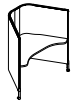

HX3PM5472SW
Mobile Softpod
with 3 Dividers and
Worksurface

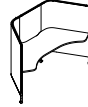

HX3P5472SW
Softpod with
3 Dividers and
Worksurface

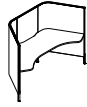

HX4PM5472SW
Mobile Softpod
with 4 Dividers and
Worksurface



HX4P5472R/LW
Softpod with 4 Dividers
and Wrap Around
Worksurface

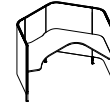

HX4PM5472LW/RW
Mobile Softpod with
4 Dividers and Wrap
Around Worksurface

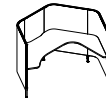

HX5P5472SW
Softpod with 5 Dividers
and Worksurface



HX5P5472R/LW
Softpod with 5 Dividers and
Wrap Around Worksurface

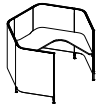

HXP5430
Single J-divider

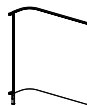

Height Adjustable Tables

HX3PH5472SW
Softpod with 3 Dividers
and Height Adjustable
Worksurface



Freestanding Pods

HX3PF
Freestanding Softpod
with 3 Dividers



HX3PFM
Freestanding Mobile
Softpod with 3 Dividers

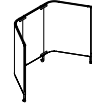

HX4PF
Freestanding Softpod
with 4 Dividers



HX4PFM
Freestanding Mobile
Softpod with 4 Dividers



HX5PF
Freestanding Softpod
with 5 Dividers



HX5PFM
Freestanding Mobile
Softpod with 5 Dividers



HX6PF
Freestanding Softpod
with 6 Dividers



HX7PF
Freestanding Softpod
with 7 Dividers

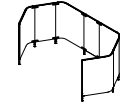

Meeting Pods

HX6PFD
Meeting Pod with 6 Dividers
with D Top Worksurface



HX7PFD
Meeting Pod with 7 Dividers
with D Top Worksurface

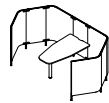

Extensions

HXPAEFE
End PET Felt Extension
Divider Add-on



HXPACFE
Corner PET Felt Extension
Divider Add-on



HXPATCFE
Top Corner PET Felt Extension
Divider Add-on

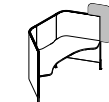

HXPATCFE
PET Felt Extension Divider Add-
on for Softpod with 2 Dividers

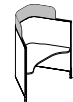

HXPATCFE
PET Felt Extension Divider Add-
on for Softpod with 3 Dividers

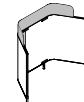

HXPACFEH
PET Felt Extension Panel Add-on for
Softpod Height Adjustable Table

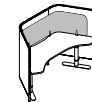

HXPACFES
Corner Semitransparent
Extension Panel Add-on



Statement Of Line

Electrical

BRED50AC
Duo Module



HXEUWC
Under Worksurface/
Edge USB
Charger

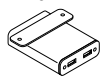

GAADG
Access Door
Module

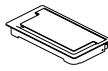

GAADCT
Access Door Module
with Cable Tray

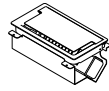

GMSA10
ModPower Starter
Mounted Unit

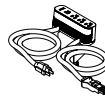

GMDCA3
ModPower Middle
Mounted Unit

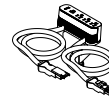

GMDEA3
ModPower End
Mounted Unit

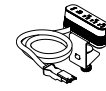

GMSF10
ModPower In Surface
Starter Unit



GMDCF3
ModPower In
Surface Middle Unit



GMDEF3
ModPower In
Surface End Unit

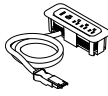

GMDCLIPS
ModPower Man-
agement Clips



GMDJ36BK
ModPower Intercon-
necting Jumper

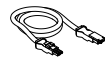

GMDPC22W
Slim Desktop Power
Module, 2 Duplex



GMDPC32W
Slim Desktop Power
Module, 3 Duplex



HXEPK
Station 2-Circuit
Power Kit



HXECS
Cable Shroud



HXEHP
Height Adjustable
Power Kit



HXEPPJ
Station to Station
Jumper Kit

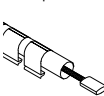

HXEPPJ
Station to Station
Jumper

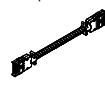

HXECF
Ceiling Feed

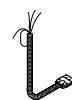

HXEBF
Base Feed



HXECFP
Ceiling Feed Pole



HXEPPGK
Divider Grommet
Kit



HXEPPGCS
Divider Grommet
Connector / Spacer



Accessories

BLVELEDVS
LED Single Arm
Lamp



BLVELEDVD
LED Double Arm
Lamp



BLVELEDRS
LED Single Arm
Lamp



BLVELEDRD
LED Double Arm
Lamp



BLVELEDASC
Lamp Mounting
Options



BLVELEDAFS
Lamp Mounting
Options



HXAHS
Hanging Shelf



HXAHSWB
Hanging Shelf with
Dry Erase Board



HXARWS
Rear Wall Shelf



HXACHS
Coat/Bag Hook
for Dividers



HXACTH
Coat/Bag Hook
for Dividers Edge



HXABH
Under Surface
Bag Hook



HXNP
Name Plate



HXPCKIT
Connection Kit

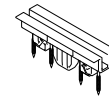

Storage

HXSCSO
Under Work-
surface Casual
Storage Unit

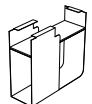

HXSCSO
Under Work-
surface Casual
Storage Unit

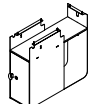

L2PO
Pantry Storage

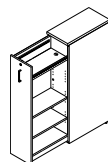

Footprint

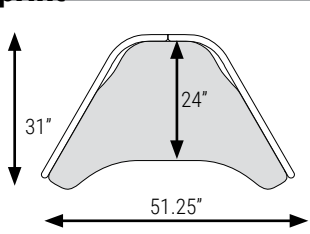

HX2P5452SW
Softpod with 2 Dividers

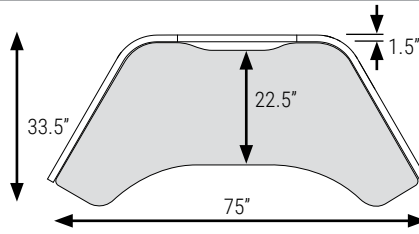

HX3P5472SW
Softpod with 3 Dividers

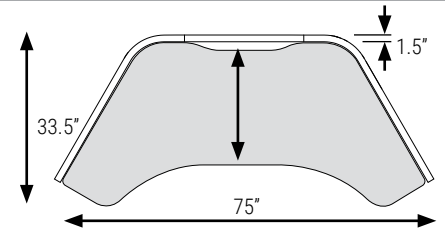

HX3PH5472SW
Height Adjustable Softpod

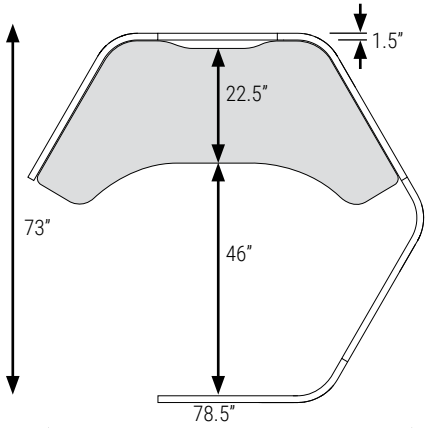

HX5P5472SW Softpod with 5 Dividers

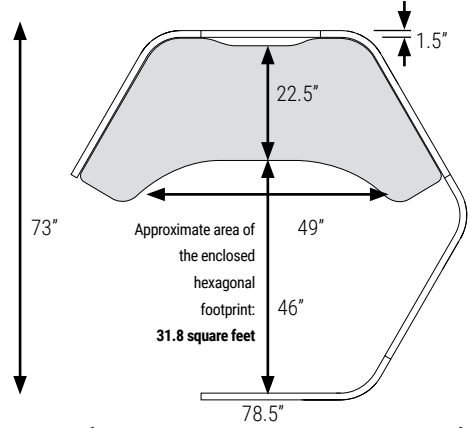

Single Softpod with 5 Dividers

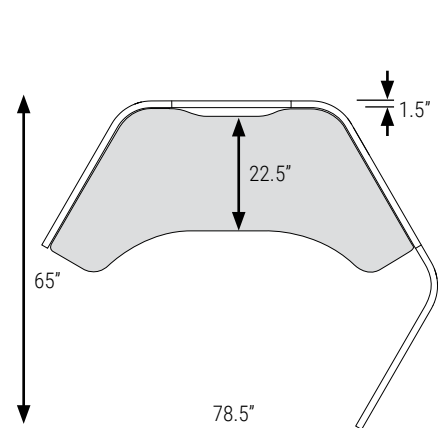

HX4P5472SW
Softpod with 4 Dividers

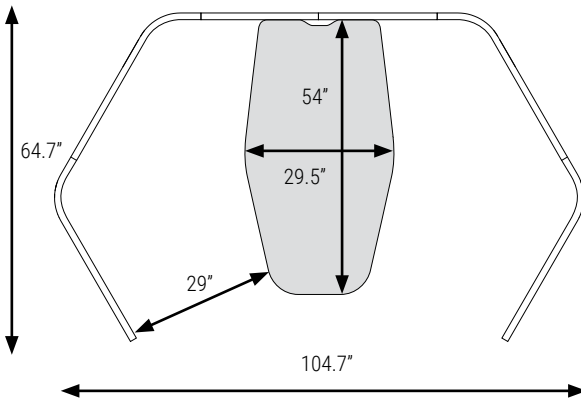

HX6PFD
Softpod with 6 Dividers and D Top Worksurface

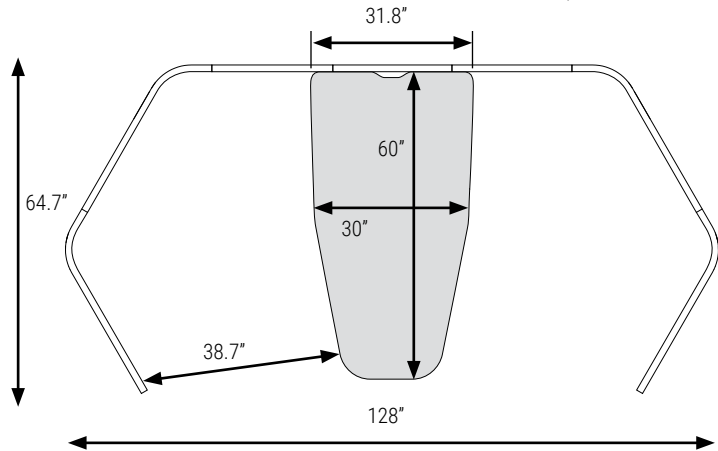

HX7PFD
Softpod with 7 Dividers and D Top Worksurface

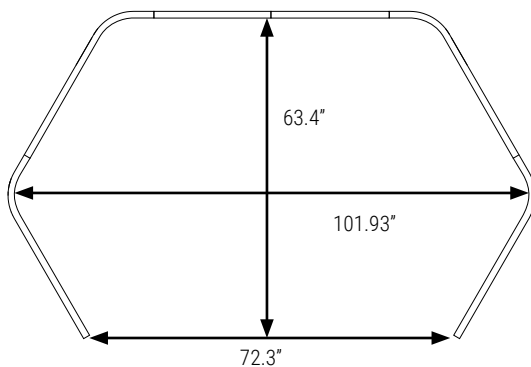

HX6PFD
Softpod with 6 Dividers and D Top Worksurface

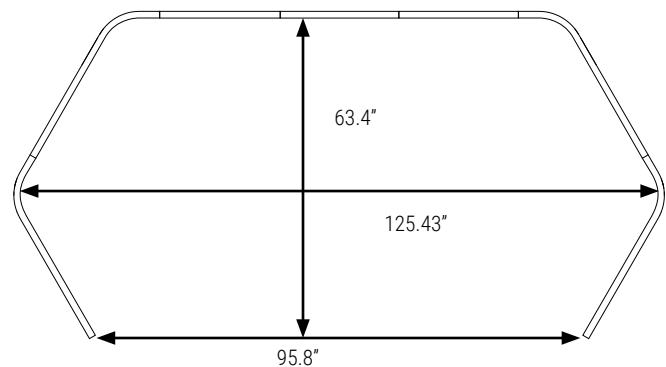

HX7PFD
Softpod with 7 Dividers and D Top Worksurface

Off Grid Planning

The flexible format of Softpod offers a variety of planning options and encourages both on and off grid layouts. From a single or cluster of Softpods this versatile system adapts to your needs.

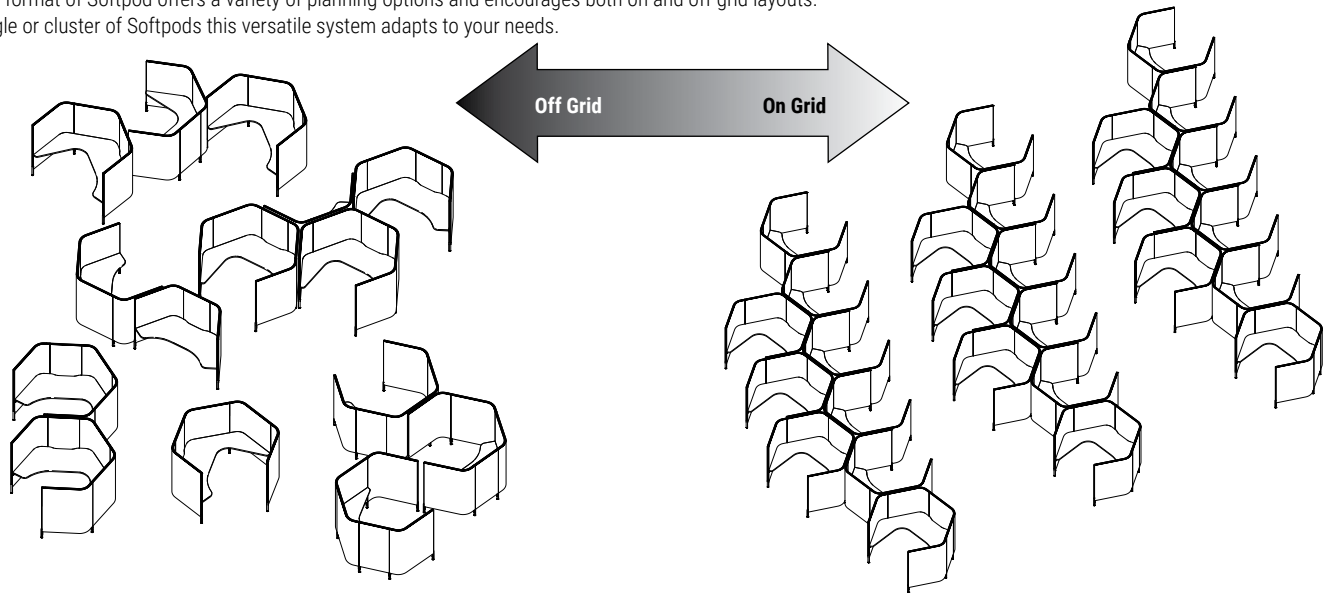

Off Grid Planning

Agile
The freestanding, single Softpod can flex to support any number of employees in a hybrid work environment. The pods can be easily reconfigured and adjusted as needs change. Its small kit of parts and thoughtfully designed features make it easy to specify and keep inventory counts low.

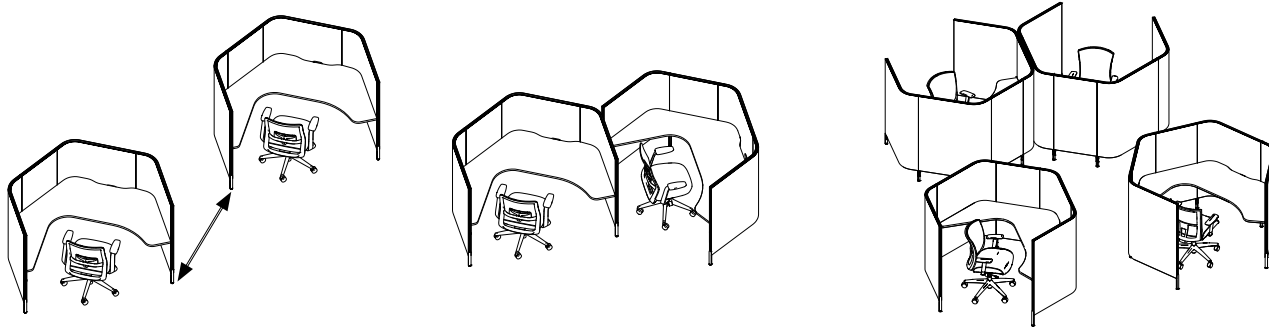

Scalable

The adaptable dividers give the ability to address the level of privacy needed on a station by station basis.

Softpod PRIVACY

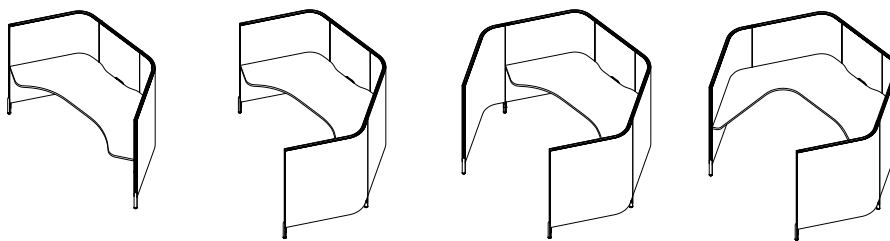

Extensions - PRIVACY

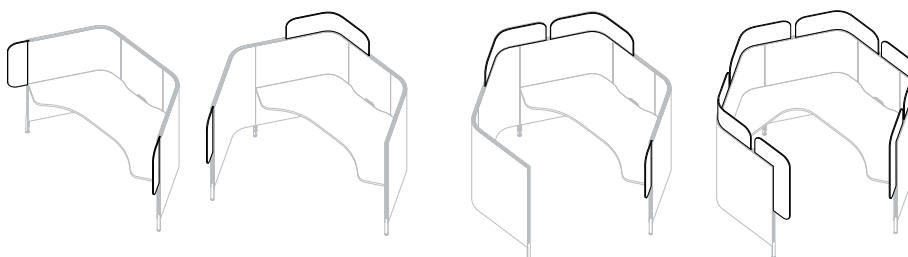

Quick Specification

Softpod's small and complete kits allows for quick and efficient movement of product from time of specification to installation.

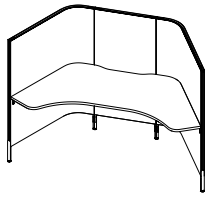

Single Pod with 3 Dividers

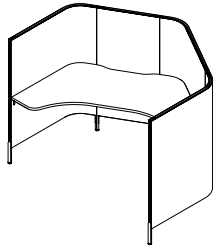

Single Pod with 4 Dividers

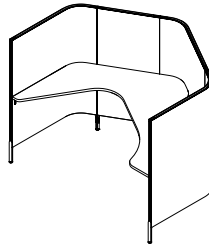

Single Pod with 4 Dividers and Wrap Around Surface

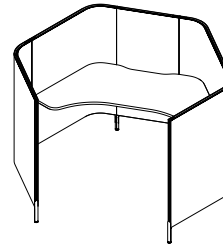

Single Pod with 5 Dividers

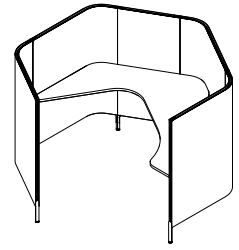

Single Pod with 5 Dividers and Wrap Around Surface

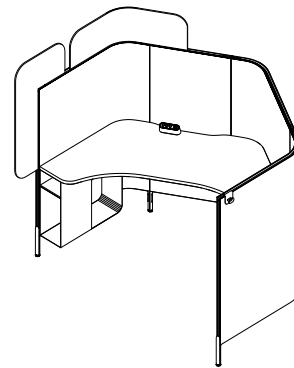
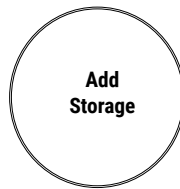
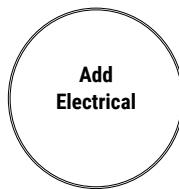

Power Connections

Plug In

Simple casual wire - Direct plug-in or hard wired.

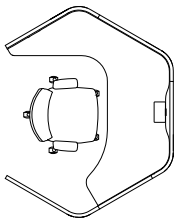

Daisy Chain Interconnect System

Plug-in power supply and interlinked, pre-determined, universal modules. If specified, one module is shipped with the station and interconnected on site.

Integrating additional station (C) requires disconnecting A from B and plugging in the C on site.

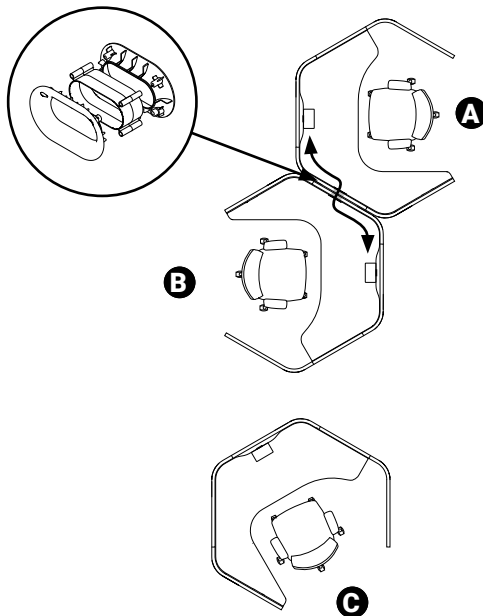

Dual Circuit Power

Outlets mounted below worksurfaces.

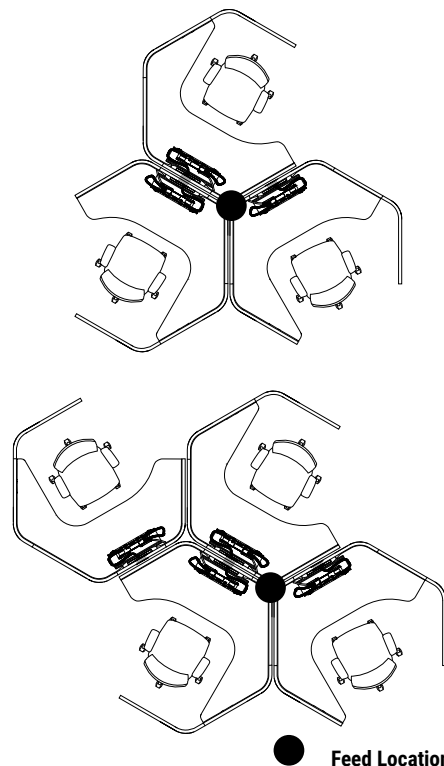

Space Planning

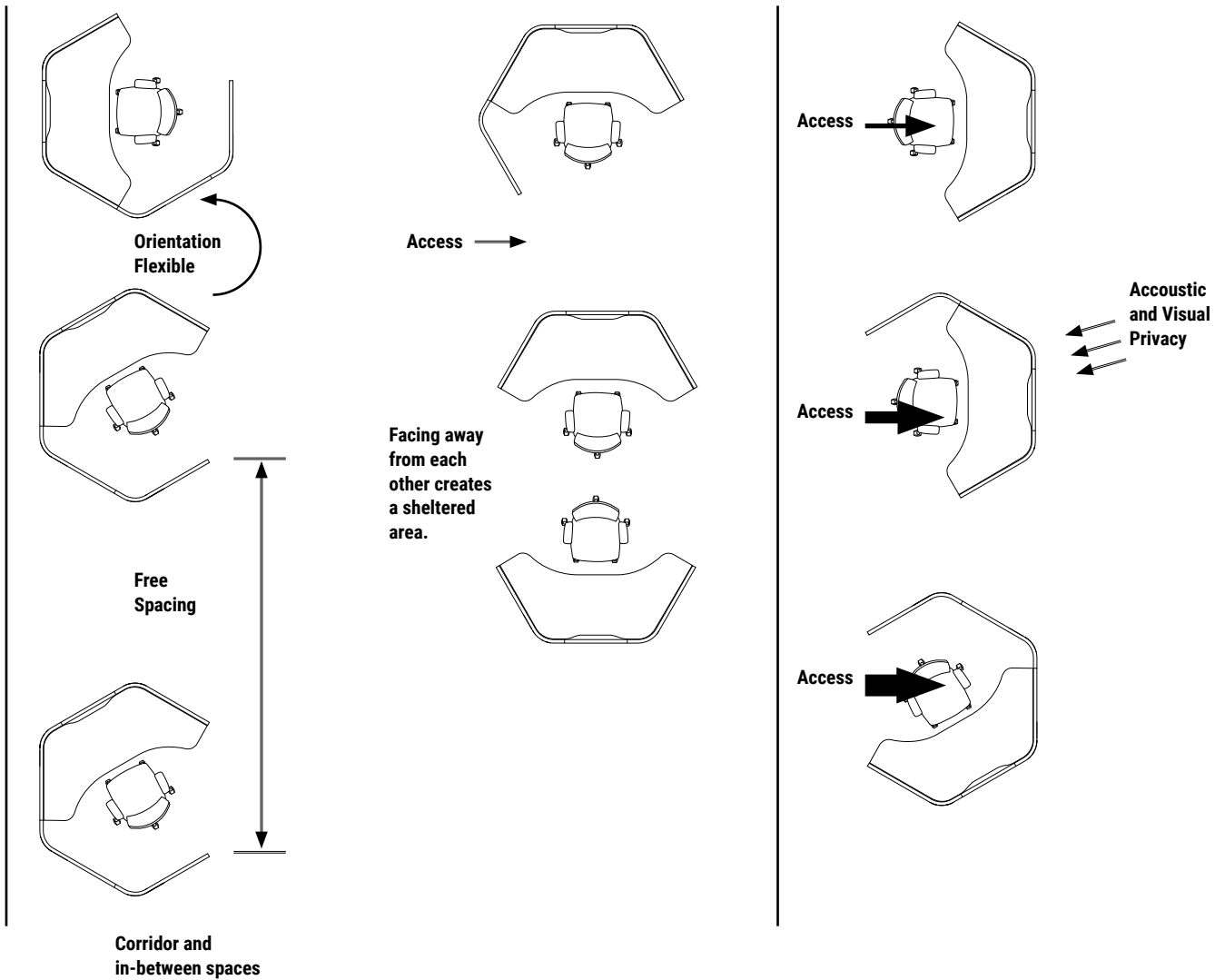

Pod Formats

Align units in cluster plan
Option unit type and orientation

(A) Worksurfaces must have opposing alignment

Flat and curved dividers are non-handed and symmetrical. The addition of the legs determines if the j-dividers becomes LEFT handed or RIGHT handed. Any j-divider can be configured and re-configured LEFT or RIGHT.

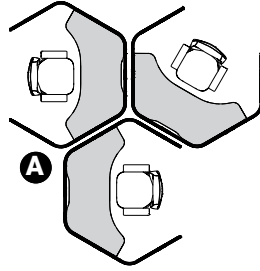

Power/ data is delivered through divider via grommet

Grommet tethers units together

Maximum 4 unit cluster per 2 circuits

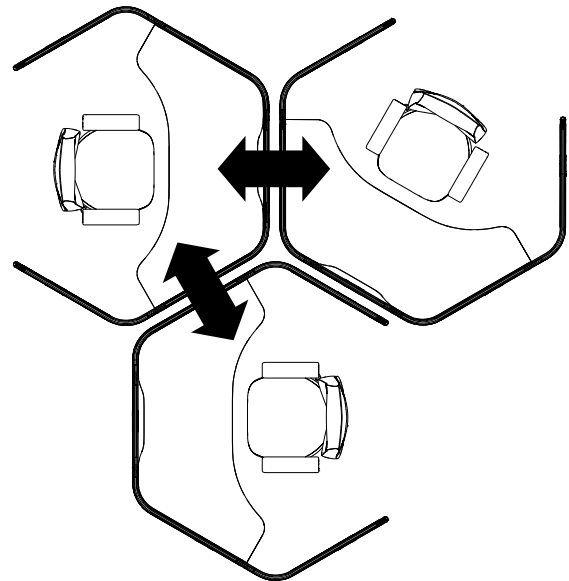
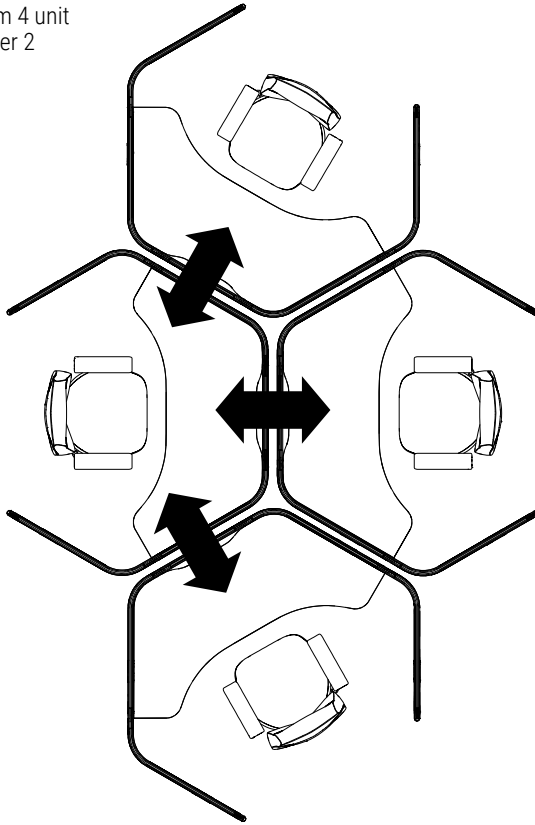

Planning for Single Softpod with 2 Dividers

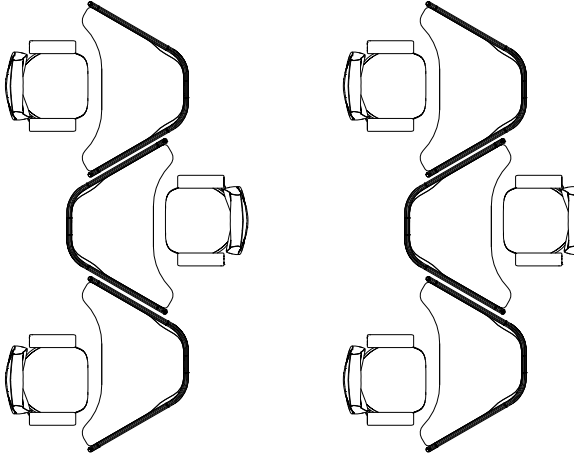

Touchdown

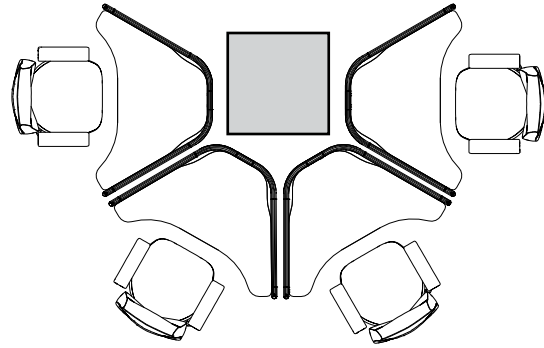

Around Column

Planning for Single Softpod with 3 Dividers

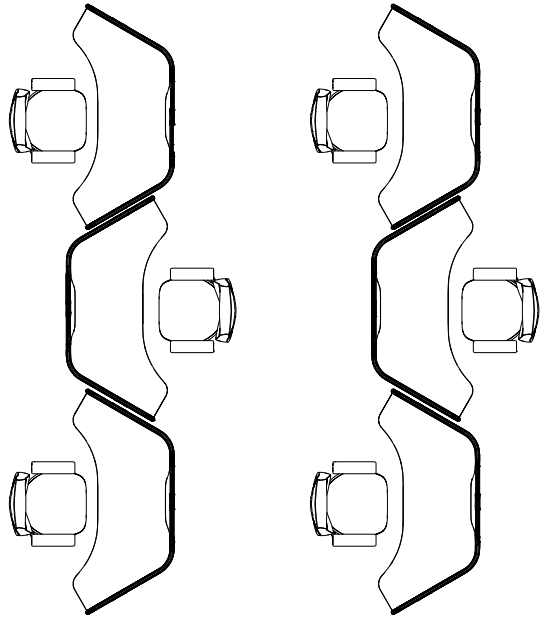

Touchdown

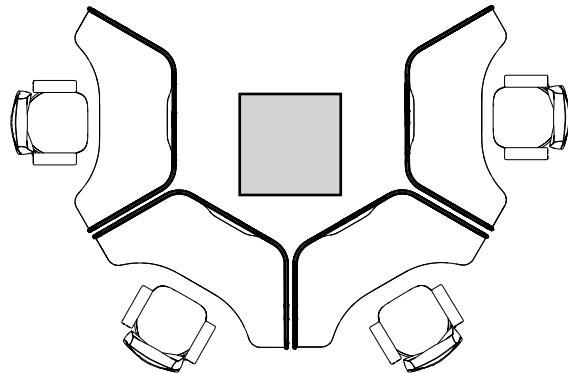

Around Column

Planning for Single Softpod with 4 Dividers

Cluster of 2 Softpods

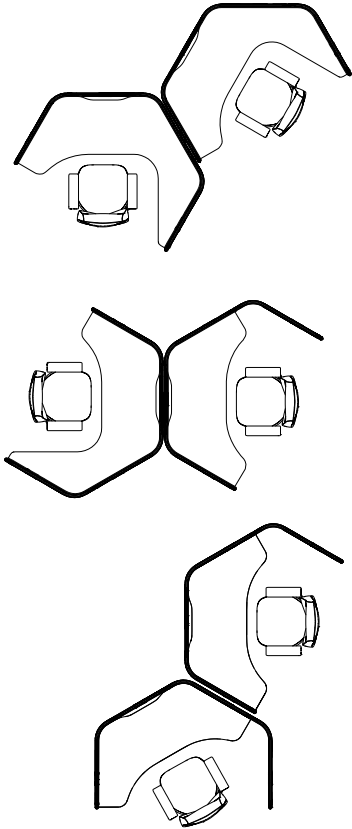

Cluster of 3 Softpods

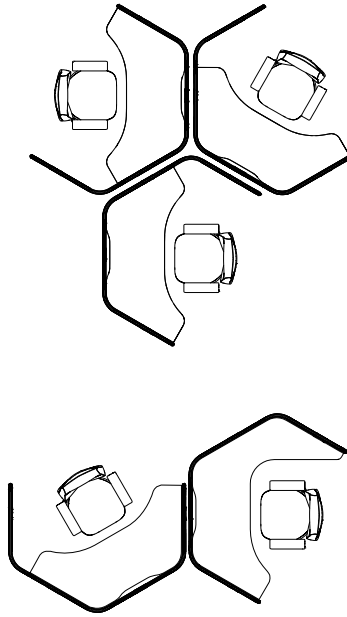

Cluster of 4 Softpods

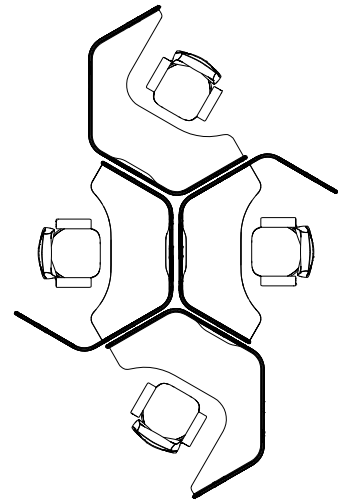

Planning for Single Softpod with 5 Dividers - Center

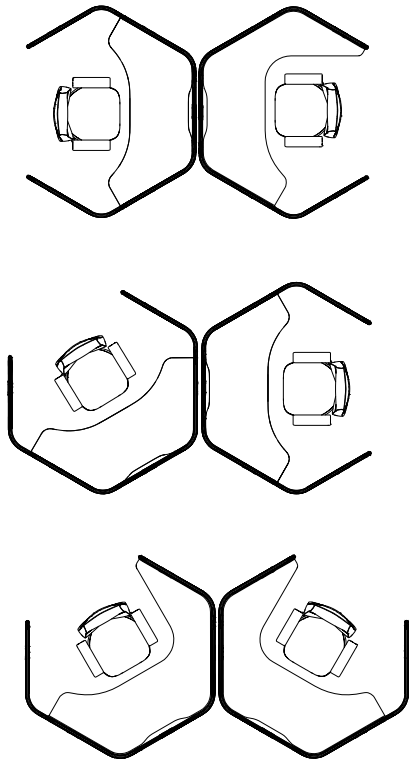

Cluster of 2 Softpods

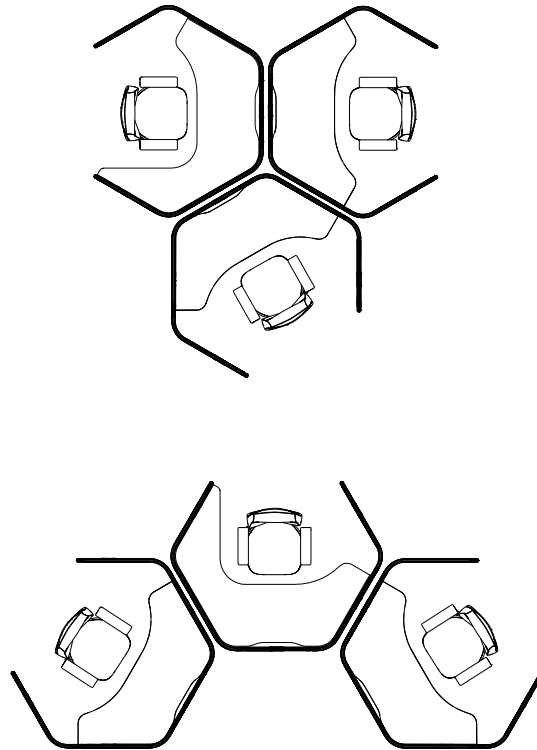

Cluster of 3 Softpods

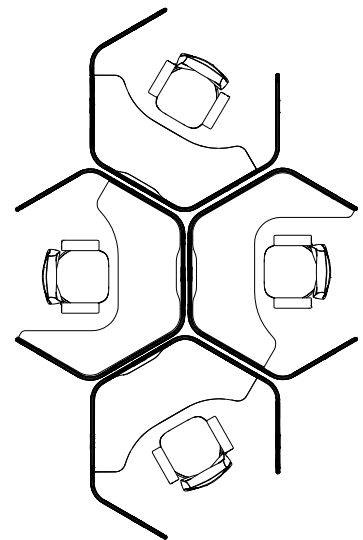

Cluster of 4 Softpods

Planning for Single Softpod with 5 Dividers Left/Right

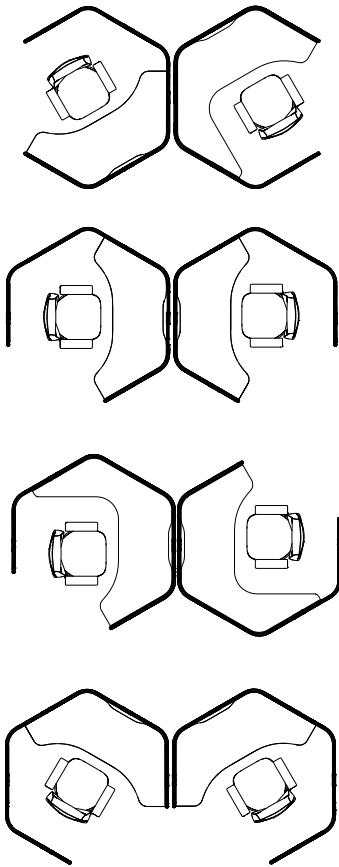

Cluster of 2 Softpods

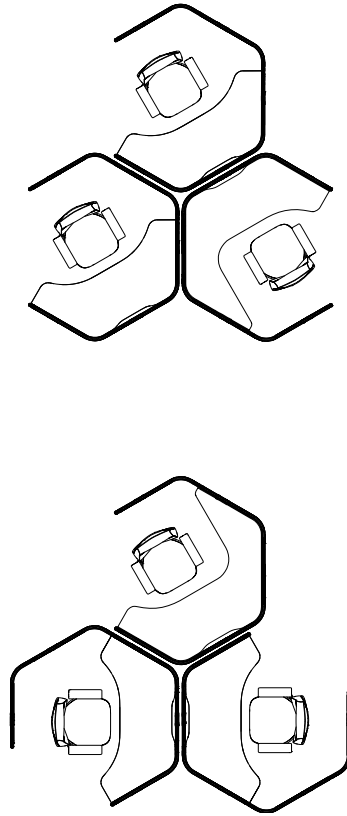

Cluster of 3 Softpods

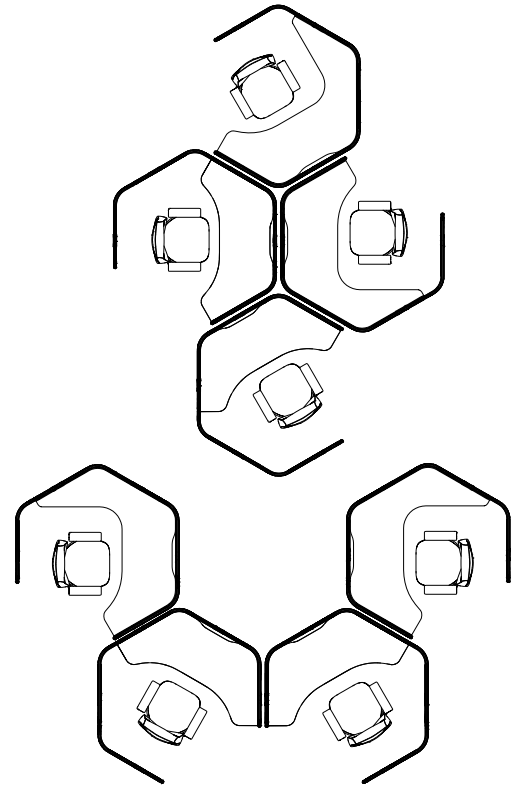

Cluster of 4 Softpods

Planning with Collaboration Pod for Meeting and Lounge Settings

* Seating specified separately

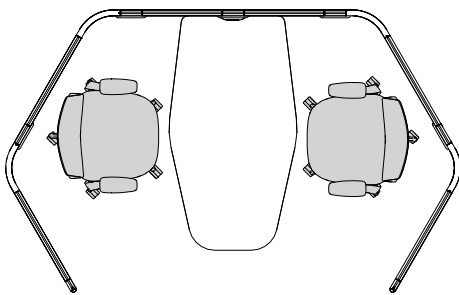

Meeting with D Worksurface

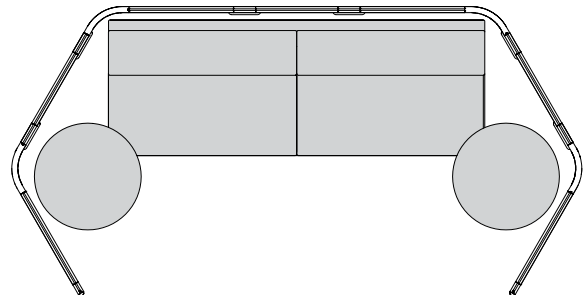

Freestanding Pods for Lounge Settings

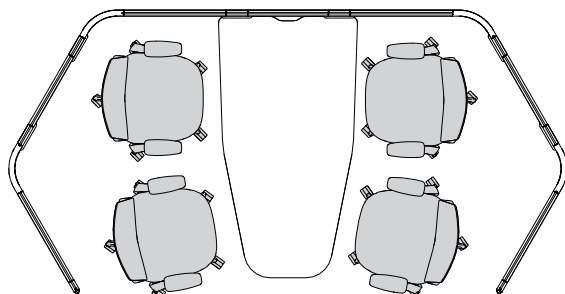

Meeting with D Worksurface

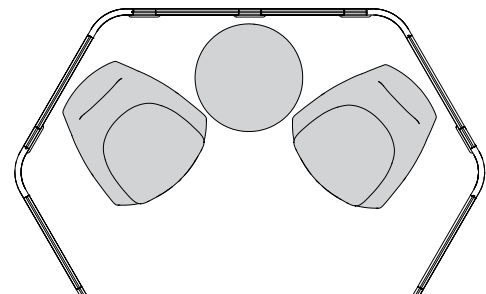

Freestanding Pods for Lounge Settings

End to end connections

Softpod allows for end to end connection to meet a variety of planning needs:

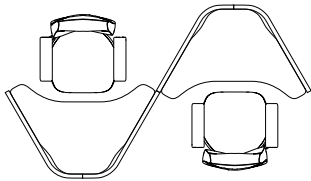

Softpod with 2 Dividers

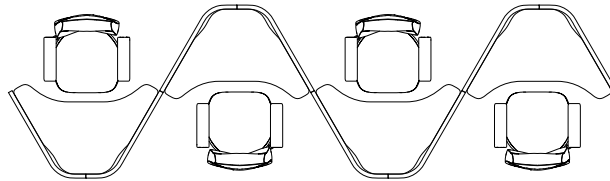

Softpod with 2 Dividers

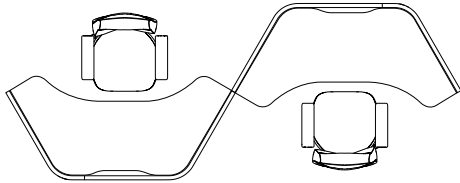

Softpod with 3 Dividers

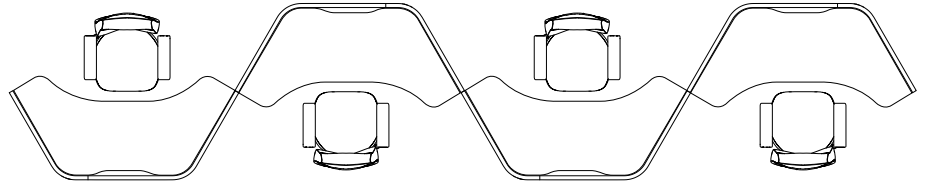

Softpod with 3 Dividers

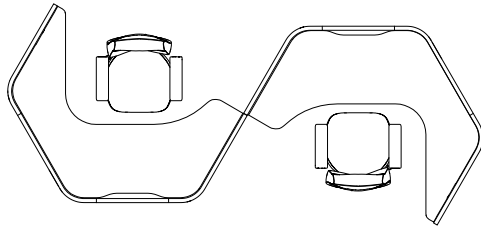

Softpod with 4 Dividers

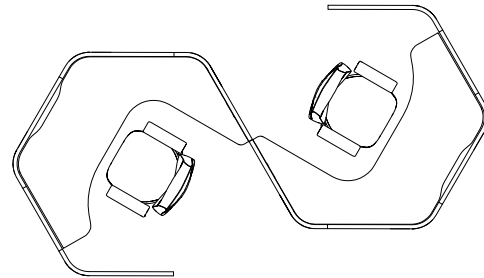

Softpod with 5 Dividers

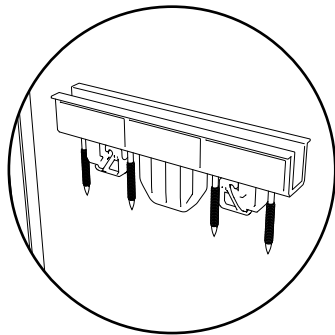

HXPCKIT

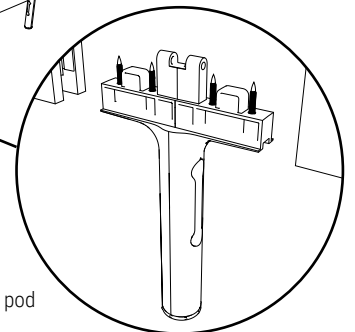
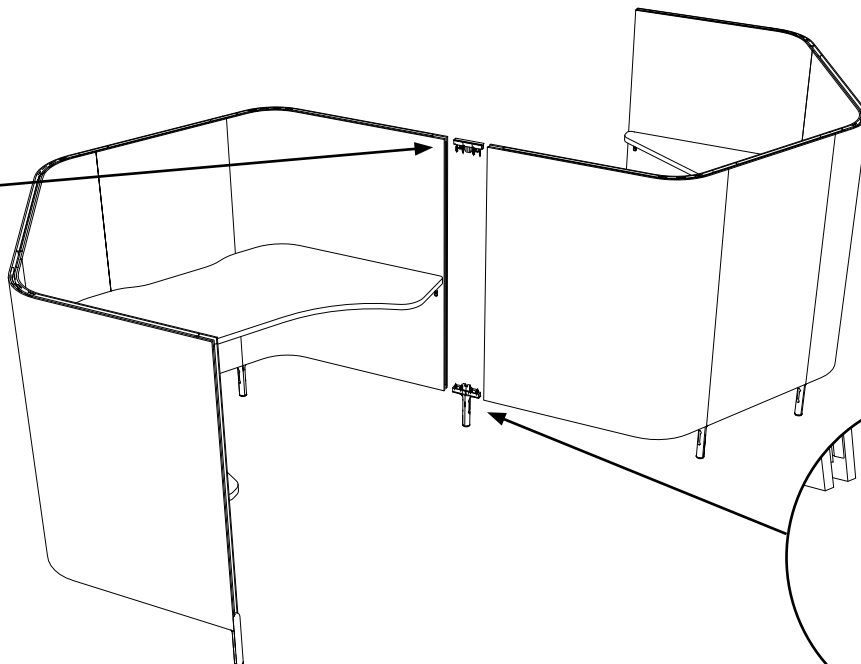

* Reuse leg from existing pod

Privacy Extensions

Flexible privacy extensions can be added to any Softpod workstation to adjust the level of privacy based on the user's needs.

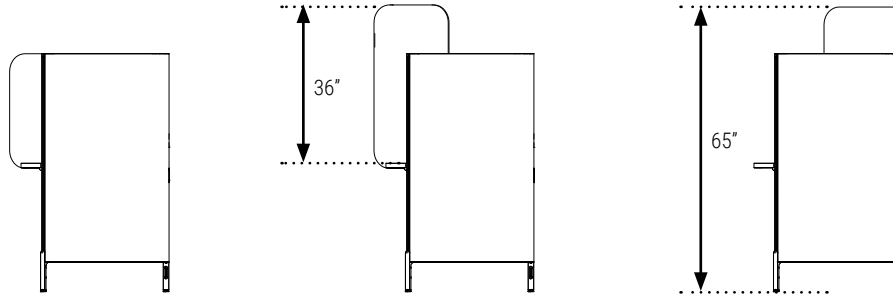
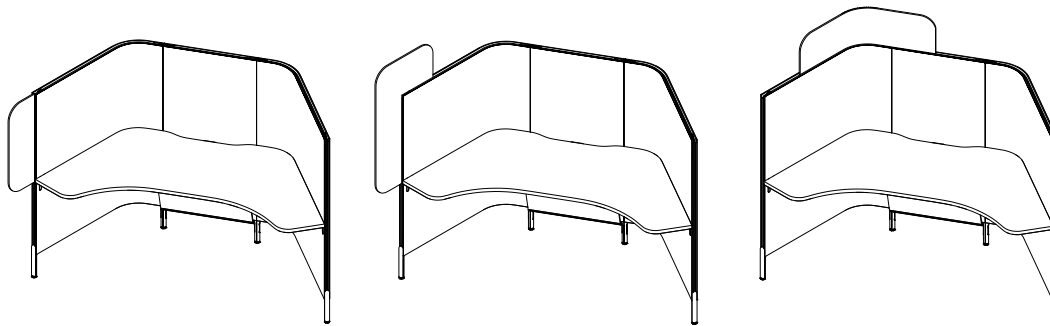

End PET Felt Extension Divider Add-on
 Height: 25.5"
 Depth: 9mm
 Width: 9.5"
 PET Felt
 - solid

Top Corner PET Felt Extension Divider Add-on
 Height: 37"
 Depth: 9mm
 Width: 19.5"
 PET Felt
 - solid
 - perforated

Corner PET Felt Extension Divider Add-on
 Height: 11.5"
 Depth: 9mm
 Width: 38.5"
 PET Felt
 - solid
 - perforated

Corner Semitransparent Extension Panel Add-on
 height: 11.5"
 Depth: 9mm
 Width: 29.5"
 Acrylic
 - Semitransparent

Top PET Felt Extension Divider Add-on for Softpod with 2 Dividers
 Height: 11.5"
 Depth: 9mm
 Width: 55.5"
 PET Felt
 - solid
 - perforated

Top PET Felt Extension Divider Add-on for Softpod with 3 Dividers
 Height: 11.5"
 Depth: 9mm
 Width: 78.3"
 PET Felt
 - solid
 - perforated

Privacy Extensions

PET Felt - Solid

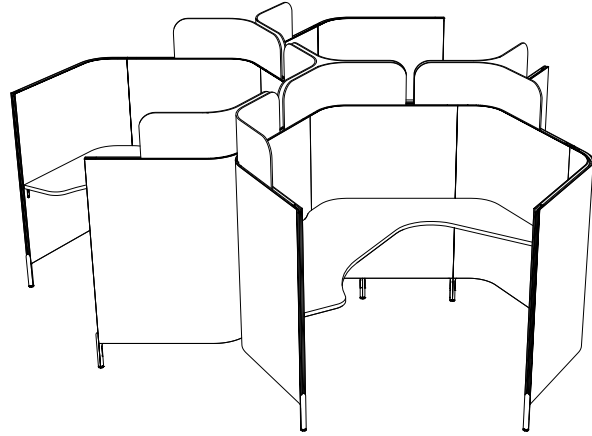
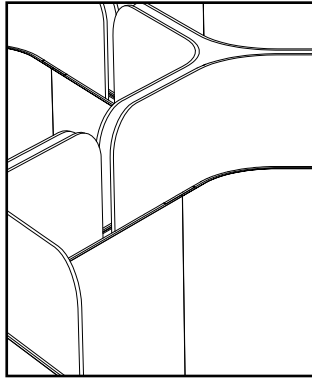

PET Felt - Perforated

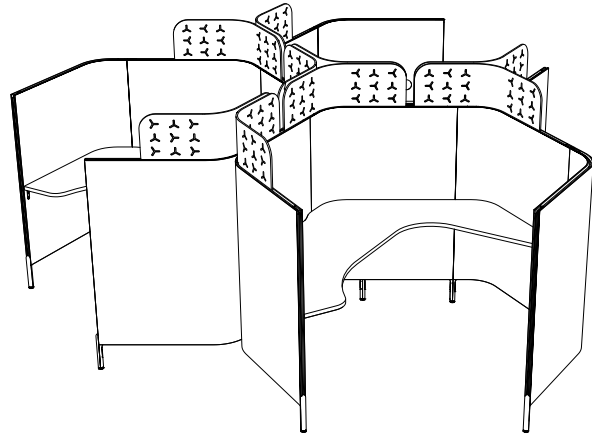
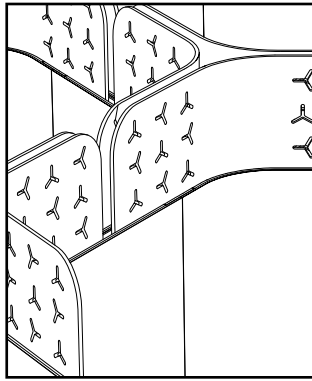

PET Felt Colour Programming

PET Felt finishes may be the same or different for the interior and exterior of the Softpod. Only one finish may be applied to either the interior or exterior of each divider within each Softpod. Extensions may be in any single PET Felt colour to compliment or contrast. Due to variation in the color of felt, we recommend a contrasting or complimentary colour.

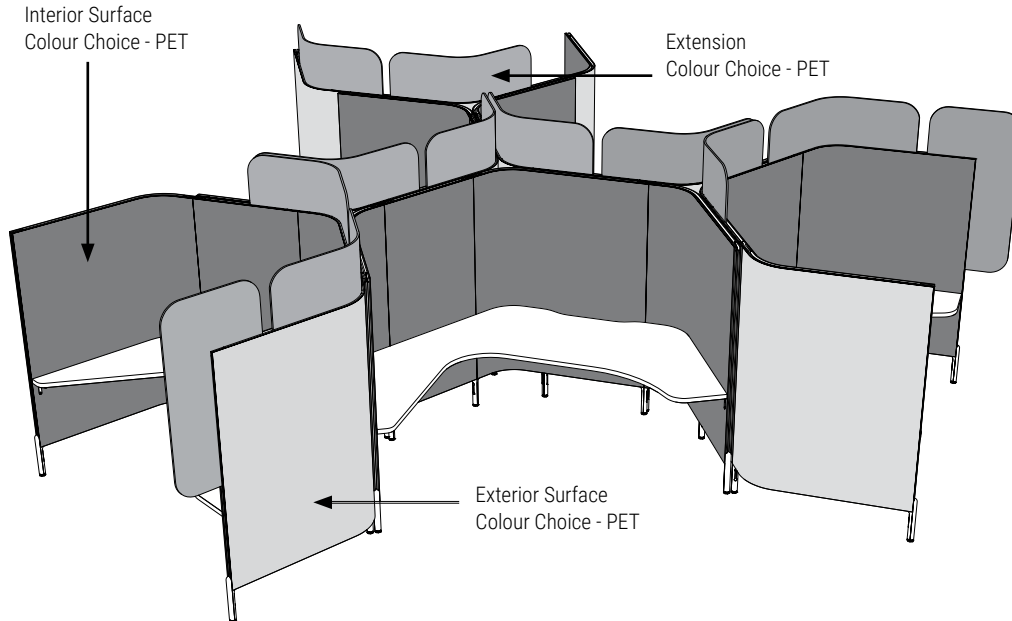

Worksurface Dimensions and Grain Direction

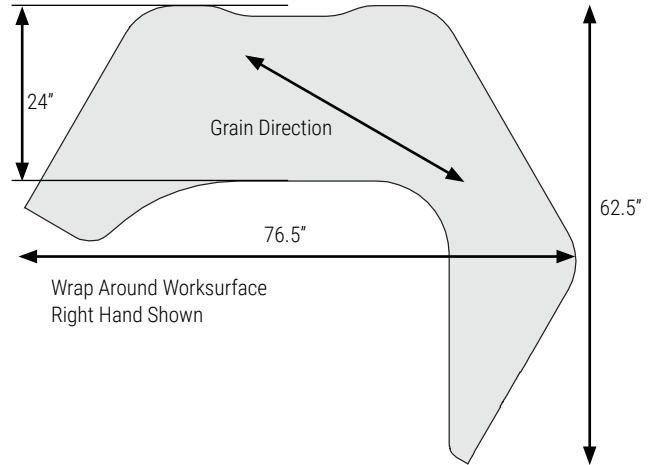
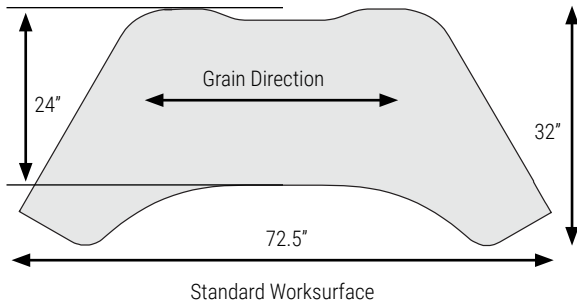

- A single worksurface to be used within Softpod dividers.
- The surface is non handed with pre-determined mounting points.
- Choose from either standard LP - low pressure laminate or HP - high pressure laminate, with PVC edge.

- A single wrap around worksurface to be used within Softpod dividers.
- The surface is handed L -left or R -right with pre-determined mounting points.
- Compatible only with 4 or 5 divider station configurations.
- Choose from either standard LP - low pressure laminate or HP - high pressure laminate, with PVC edge.

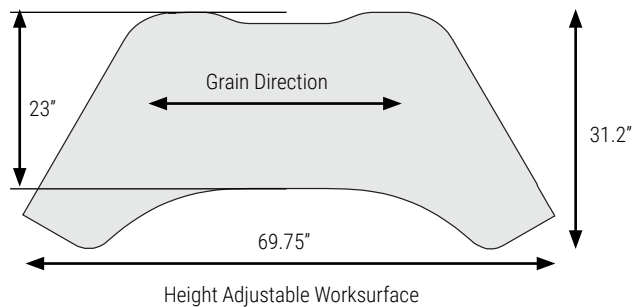
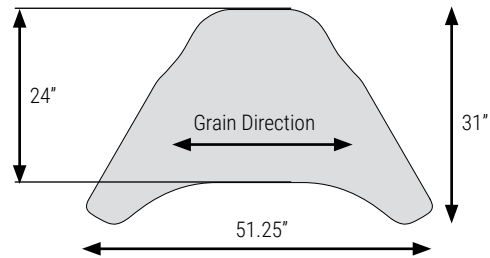
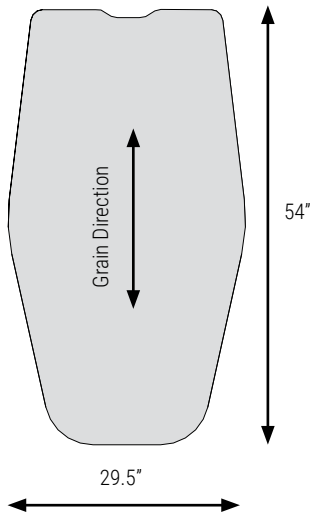
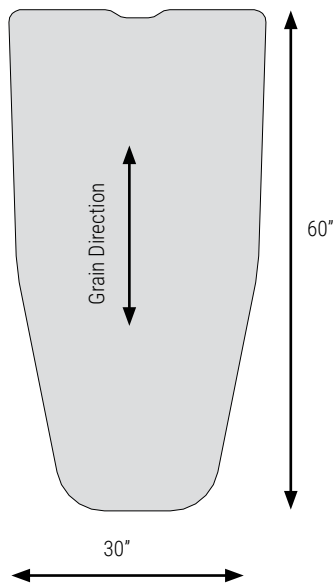

Grommet Location

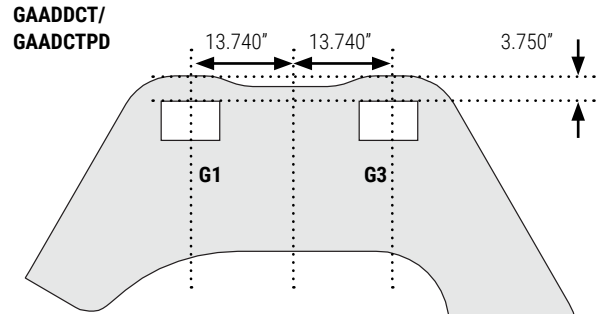
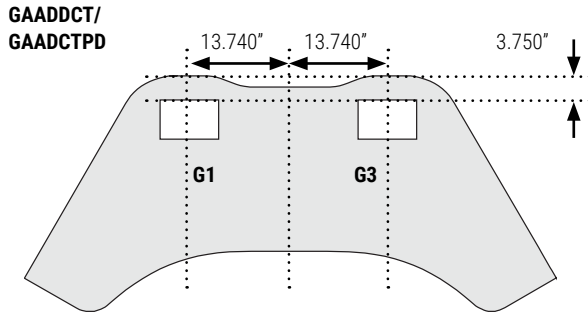

Right Hand Shown

- Grommets must be ordered separately.
- GAAD grommet is not available in combination with HXECS (Cable Shroud) and HXEPK (2 Circuit Power Kit).

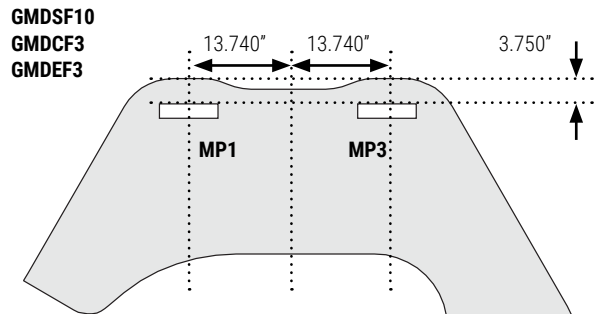
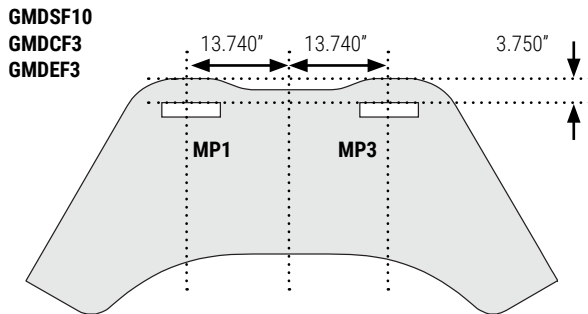
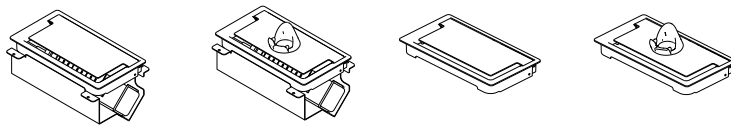

Right Hand Shown

- Grommets must be ordered separately.
- GAAD grommet is not available in combination with HXECS (Cable Shroud) and HXEPK (2 Circuit Power Kit).

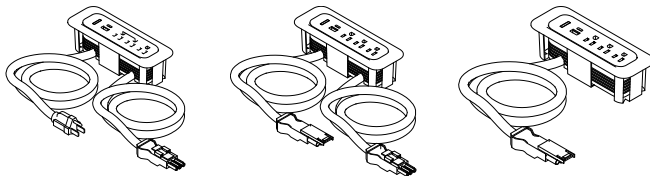

Electrical

Power and data lines can enter Softpod via floor, ceiling, or through grommet in the divider. The grommet opening is built-into every Softpod divider at a specific location, but it is covered by an on-site removable PET plug.

A grommet on a single Softpod can also facilitate cable access to a wall outlet.

Grommets installed on specific dividers facilitate passage of wires through Softpod dividers into adjacent Softpods.

Orientation of worksurfaces plays important role when planning Softpod cluster layouts with the need to pass cables between individual Softpods as the cables are best hidden underneath.

Worksurfaces must have opposing alignment.

Align units in cluster plan option unit type & orientation.

(A) Worksurfaces must have opposing alignment.

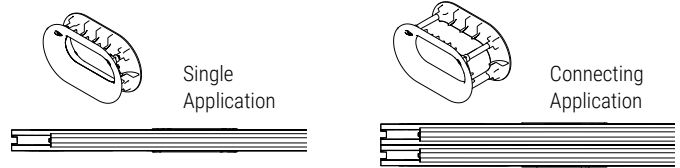
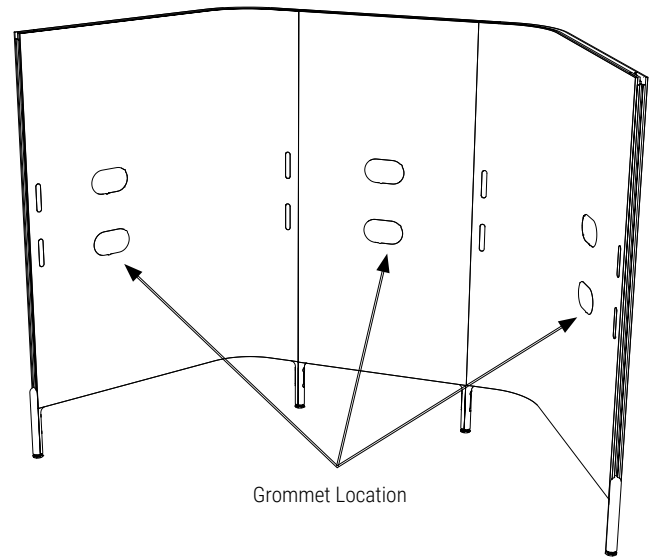
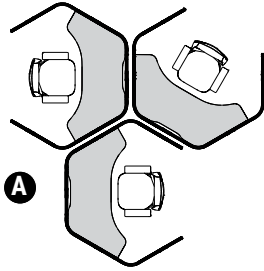

Ceiling pole attaches to the divider grommet under worksurface.

Location of the Ceiling pole on the inside of the Softpod is determined by the contoured recess at the back of worksurface.

White dots below indicate possible ceiling feed pole location within the Pod (must be at the same location as worksurface contoured recess).

Grey dots indicate possible Ceiling fee pole location outside of the POD (because cables pass through the divider grommets and under the worksurface).

Black arrows indicate possible power and data cable passage between Softpods (because cables pass through the divider grommet under the worksurface, through the second divider grommet and into the adjacent Softpod, under worksurface).

In either case, the cables enter or exit the Softpod through the divider grommet.

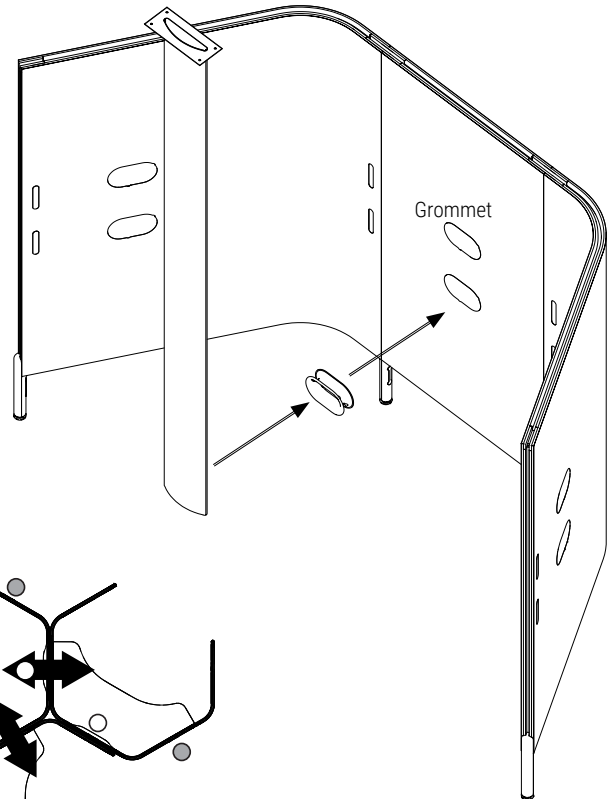

Recommended Maximum 4 unit cluster per 2 circuits.

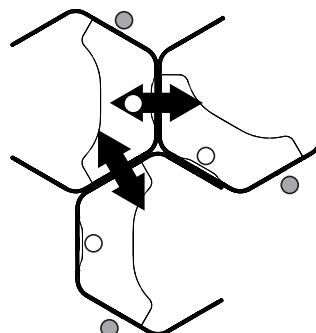
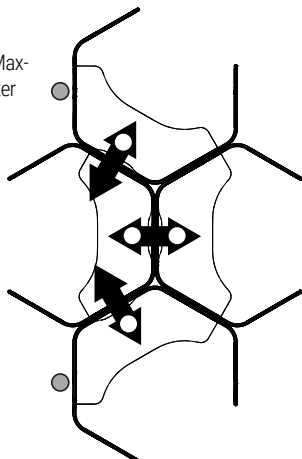

● Ceiling Feed Pole Location

Electrical Options

Direct Plug In

- Direct or floor monument outlet plug-in.

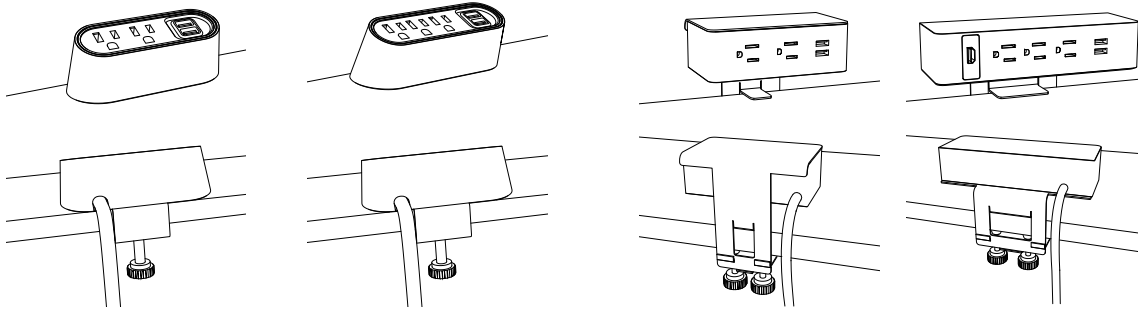

Grommet Application

- In surface.

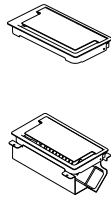
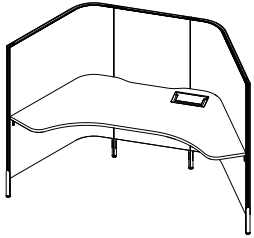

Grommet Application

- In surface Daisy Chain.

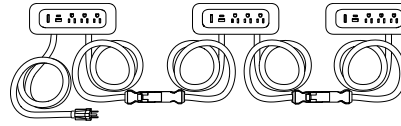
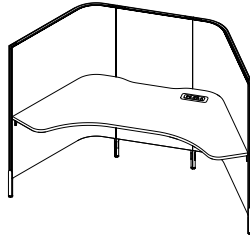

Daisy Chain Interconnect System

- Direct or floor monument outlet plug-in.

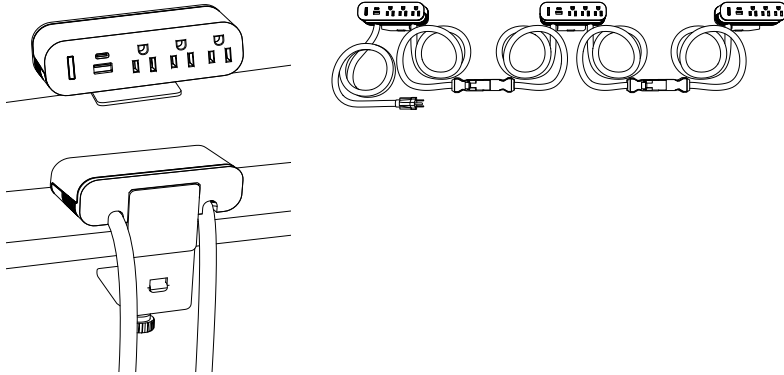

Dual Circuit Power

- Hardwired

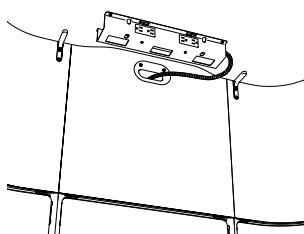
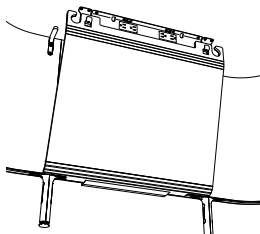

Floor Feed

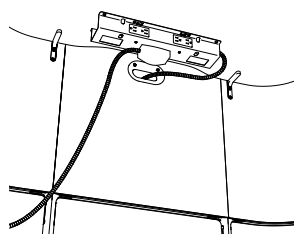

Ceiling Feed

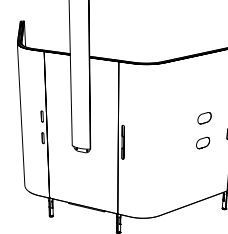

Electrical

2 Circuit, 4 Wire Power Distribution

The 2-circuit, 4-wire electrical components are housed in a metal trough, mounted under worksurface, immediately adjacent to the worksurface contoured recess.

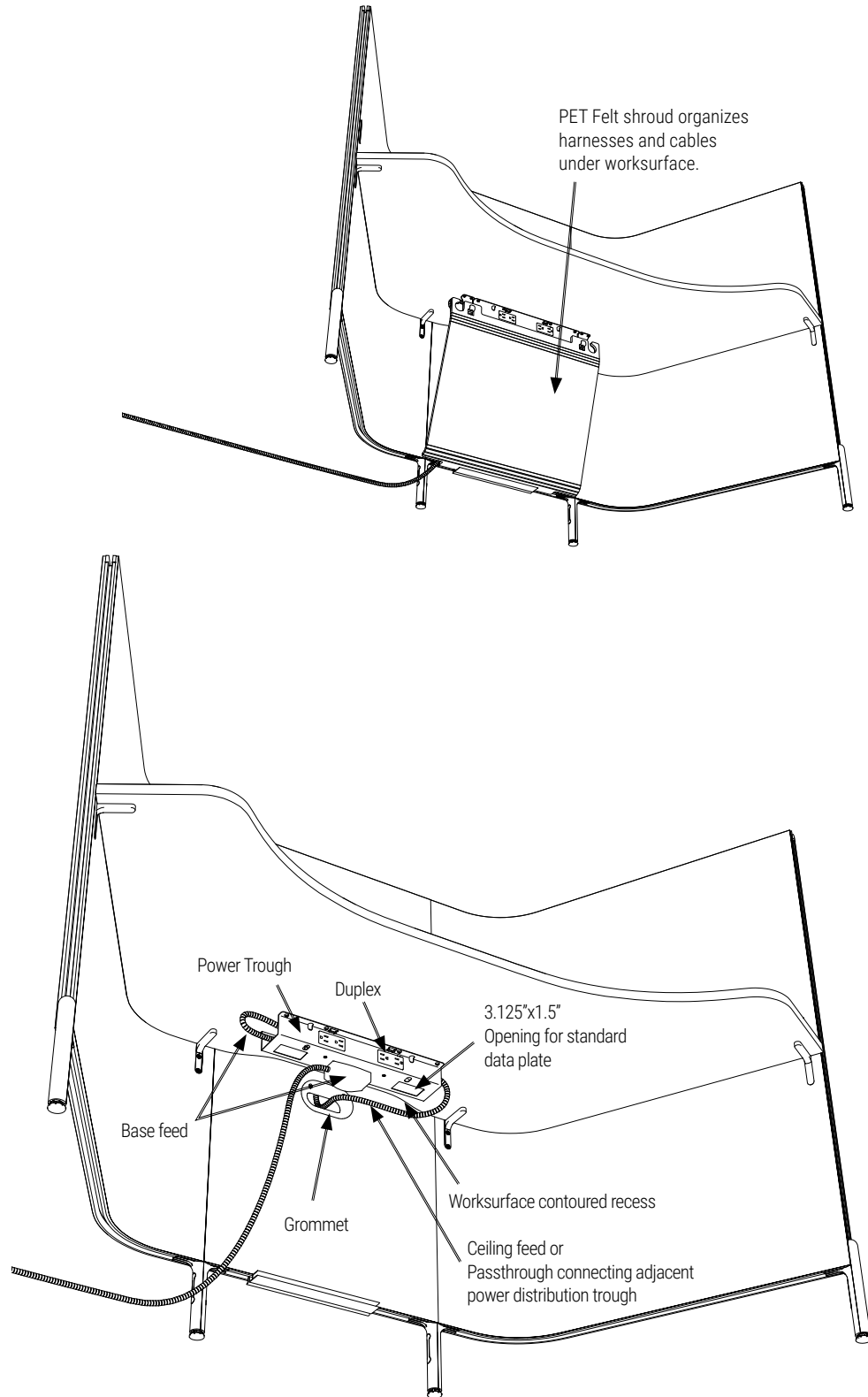

Height Adjustable

HX3PH5472SW

Softpod with 3 Dividers and Height Adjustable Worksurface Complete 3 divider pod consisting of one straight back divider, two side j-dividers and one height adjustable worksurface. Includes all connecting hardware, tubular legs and supporting brackets.

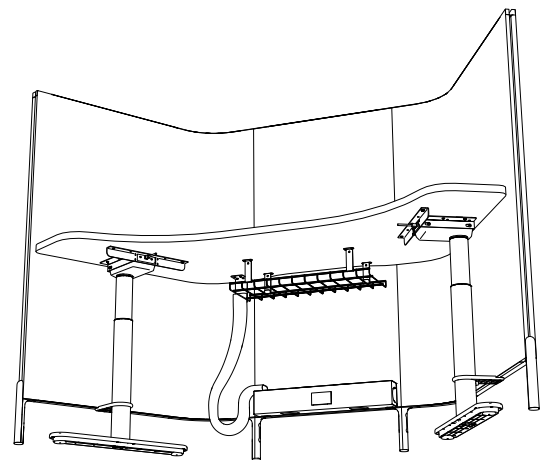
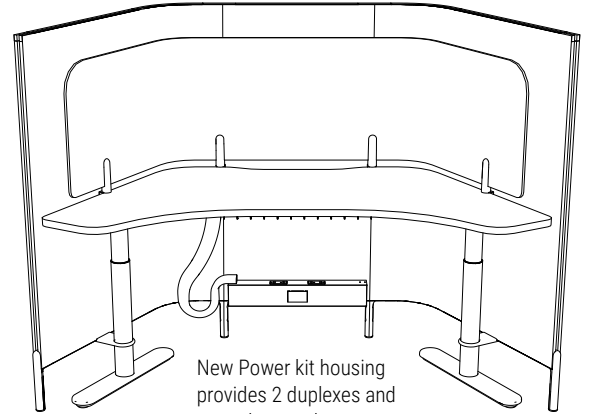
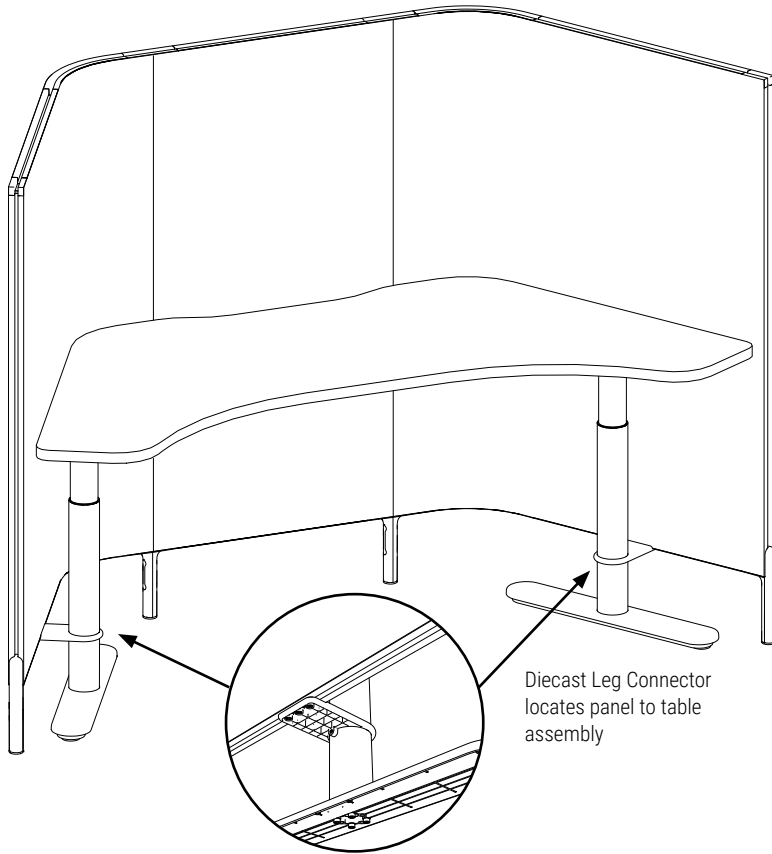

HXEHP

Optional electrical kit for use with height adjustable Softpod, includes electrical housing with receptacles, under worksurface cable basket, and black neoprene sock for wire management

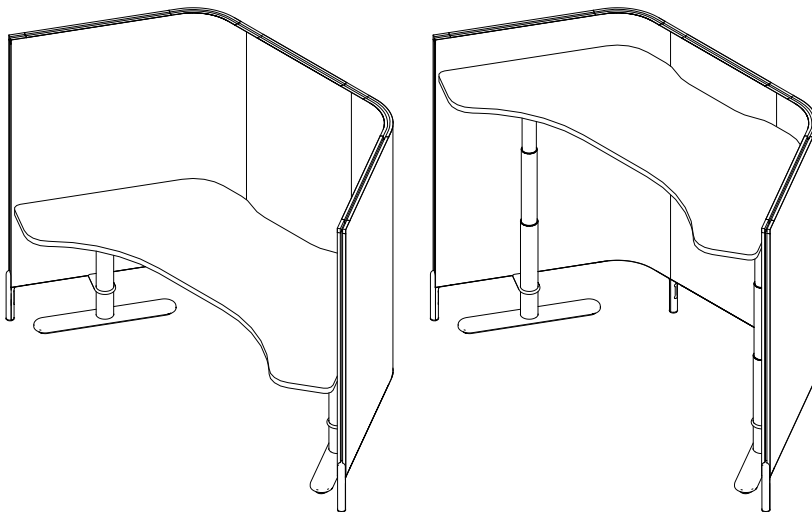

Height Range of 22.5" - 48.9" (Top of Surface)

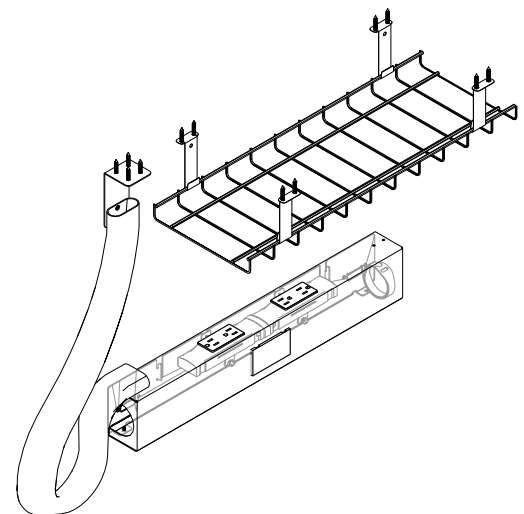

Height Adjustable Base Specification

Construction:

- Leg column size – 70mm
- Leg and foot materials - Steel
- Glide adjustment range – 18mm
- Weight capacity – 1200N/leg
- Operation speed – 35mm/sec
- Anti collision if existent – 6-axis Gyro built into control box
- Warranty – 5-year on electrical/ 10-year on steel
- Certifications - ANSI/BIFMA Compliant. UL component level certification.

Three stage leg design:

- Guide / actuator / motor housing design – Steel/Aluminum/Plastic
- Max. thrust – 800N/leg
- Max. speed – 38mm/sec
- Noise level - <50dB

Control box specs "NE2/N3":

- Voltage – 120V
- Control box specs NE2:
- Size - 11 5/8 x 1 7/8 x 3 3/4
- Weight- 1.14 lbs

Control box specs N3:

- Size - 12 5/8" x 1 15/16" x 3 11/16"
- Weight- 1.54 lbs
- Temperatures - Below 70°C.
- Colour - Black
- Overload protection – Work duty: 2min operation, request 18min rest, otherwise code H01 will show. Current limitations: single port not larger than 7A, total port not larger than 15A.
- Type of plug (two prong / three prong) - Three prong
- Cord length – 1 meter

Handset "K50C":

- Colour - Black
- PVC or PVC-Free – PVC
- Plug style and cord length – RJ45
- Power consumption – < 0.1W
- Certifications – UL component level certification

Height Adjustable Power

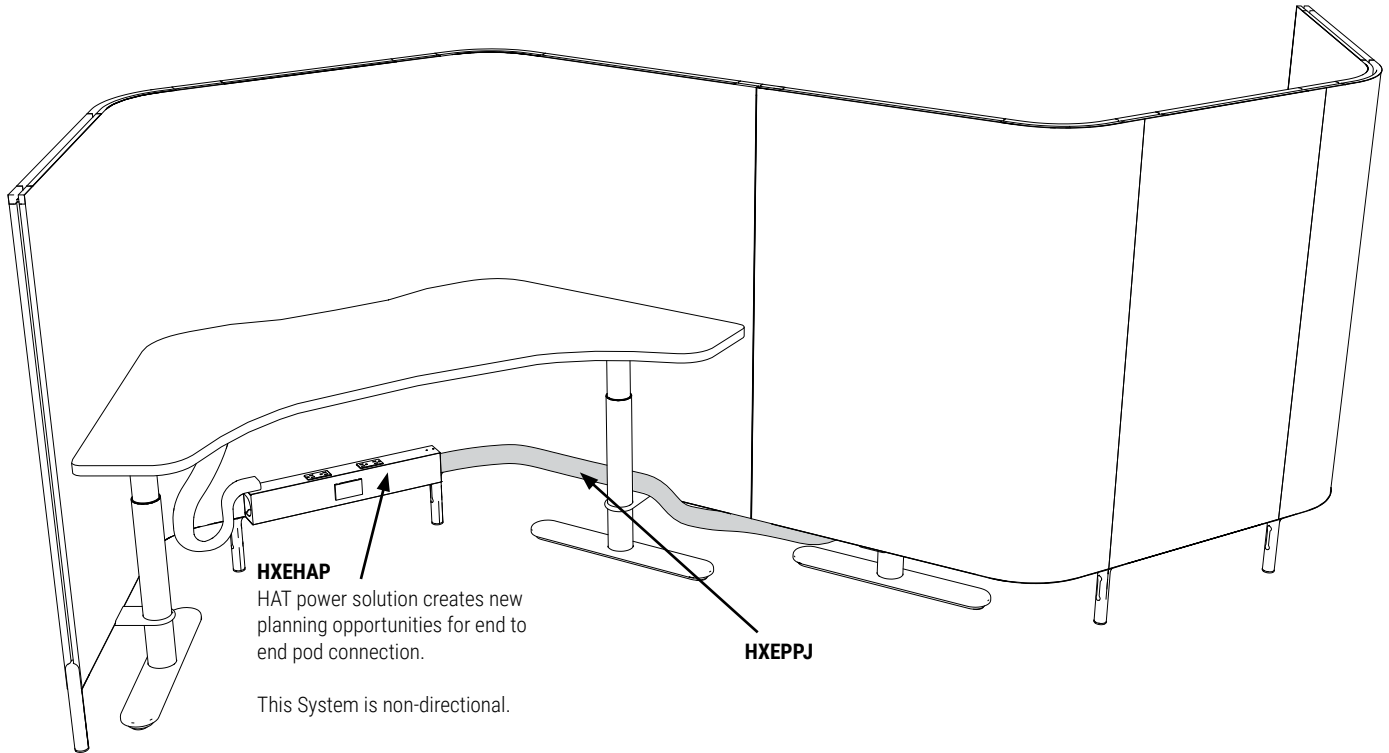

Side to side

Required jumper length - 36"
HXEPPJ36

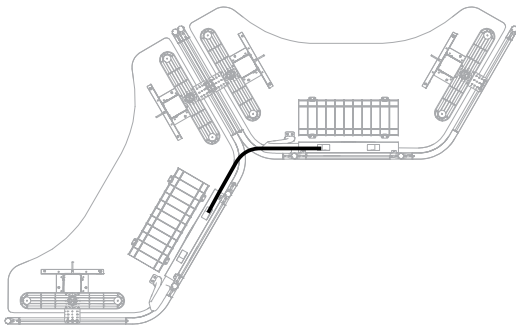

End to end

Required jumper length - 90"
HXEPPJ72
HXEPPJ18
BE8C11

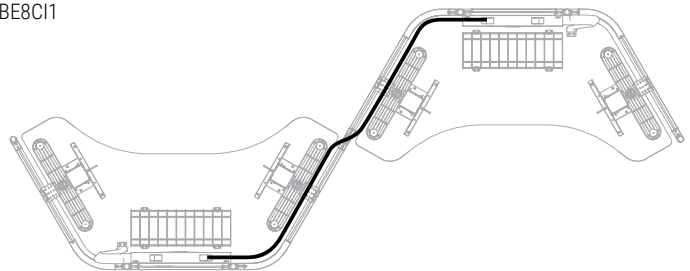

Back to back

Required jumper length - 24"
HXEPPJ24

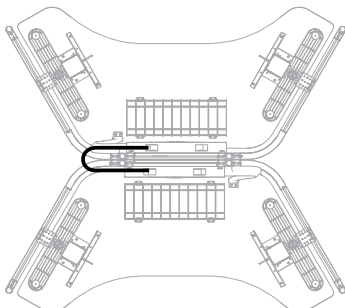

Line

Required jumper length - 72"
HXEPPJ72

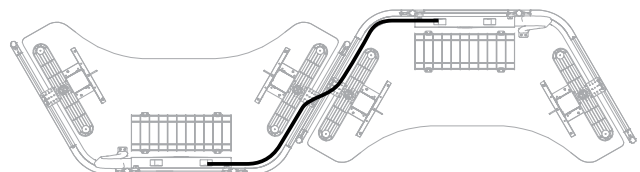

Storage

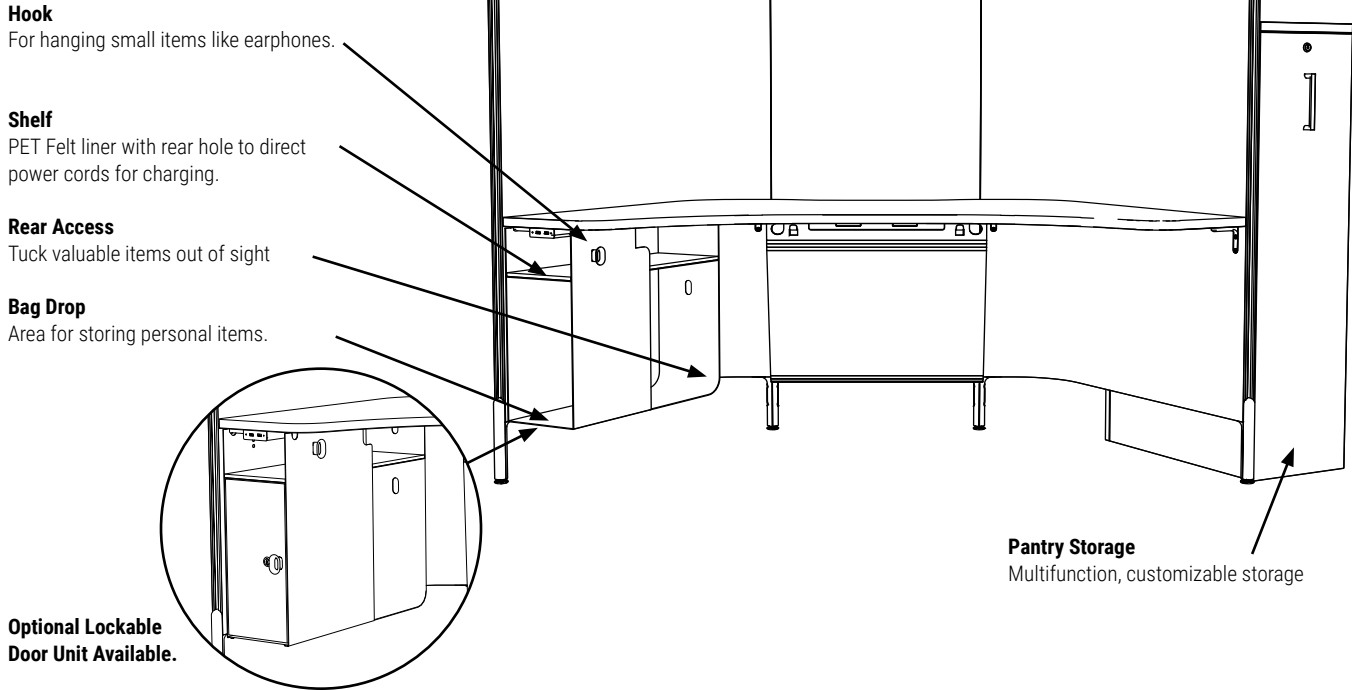

Accessories

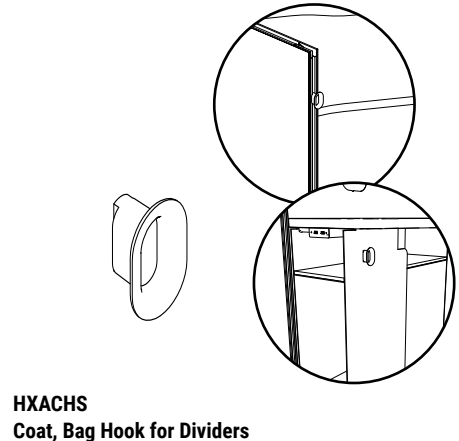
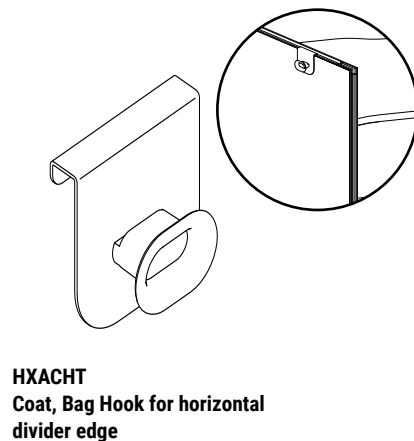
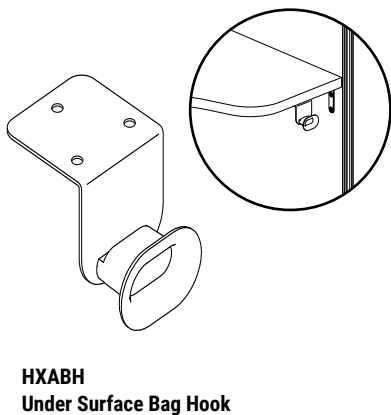
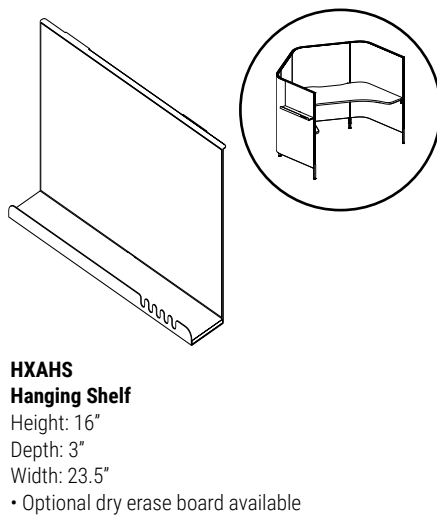
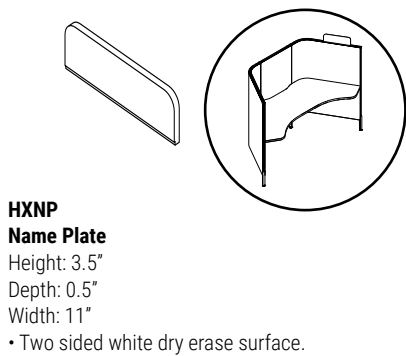

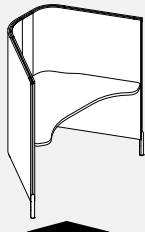
HX2P5452SW • Softpod with 2 Dividers and Worksurface**NEW!**

- Complete 2 divider pod consisting of two j-dividers and one standard worksurface.
- Installed pod measures 54"h from the floor, 25" from top of surface and has a clearance of 6 3/8" at floor level.
- Dividers are surfaced with tackable PET Felt. Please choose any standard PET Felt color. Interior PET Felt color may be different than the outer.
- The divider perimeter reveal trim accepts privacy extensions and is made of polypropylene available only in CHR - Charcoal.
- Surface choice of LP - low pressure or HP - high pressure laminate with PVC edge. Please choose any standard laminate and PVC edge.
- Metal legs are powder coated paint. Please specify standard paint finish.
- Complete pod includes all connecting hardware, tubular legs and supporting brackets.
- Extensions, electrical, storage and accessories are specified separately.

| PRODUCT CODE | PRICE | | SIZE/INCHES | | | WEIGHT LBS | VOL FT ³ |
|-----------------|-------|------|-------------|----|----|---------------|------------------------|
| | LP | HP | H | W | D | | |
| HX2P5452SW | 2018 | 2230 | 54 | 49 | 30 | 86 | 17.87 |

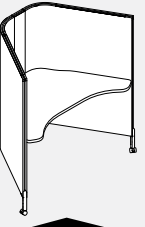
HX2PM5452SW • Mobile Softpod with 2 Dividers and Worksurface**NEW!**

- Complete 2 divider pod consisting of two j-dividers and one standard worksurface.
- Installed pod measures 54"h from the floor, 25" from top of surface and has a clearance of 6 3/8" at floor level.
- Dividers are surfaced with tackable PET Felt. Please choose any standard PET Felt color. Interior PET Felt color may be different than the outer.
- The divider perimeter reveal trim accepts privacy extensions and is made of polypropylene available only in CHR - Charcoal.
- Surface choice of LP - low pressure or HP - high pressure laminate with PVC edge. Please choose any standard laminate and PVC edge.
- Metal legs with casters are powder coated paint. Please specify standard paint finish.
- Complete pod includes all connecting hardware, tubular legs, casters and supporting brackets.
- Extensions, electrical, storage and accessories are specified separately.

| PRODUCT CODE | PRICE | | SIZE/INCHES | | | WEIGHT LBS | VOL FT ³ |
|-----------------|-------|------|-------------|----|----|---------------|------------------------|
| | LP | HP | H | W | D | | |
| HX2PM5452SW | 2039 | 2250 | 54 | 49 | 30 | 87 | 17.87 |

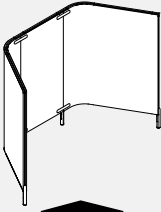
HX3PF • Freestanding Softpod with 3 Dividers**NEW!**

- Complete 3 divider pod consisting of one straight back divider, and two side j-dividers.
- Installed pod measures 54"h from the floor, and has a clearance of 6 3/8" at floor level.
- Dividers are surfaced with tackable PET Felt. Please choose any standard PET Felt color. Interior PET Felt color may be different than the outer.
- The divider perimeter reveal trim accepts privacy extensions and is made of polypropylene available only in CHR - Charcoal.
- Metal legs and stiffeners are powder coated paint. Please specify standard paint finish.
- Complete pod includes all connecting hardware, tubular legs and supporting brackets.
- Extensions, electrical, storage and accessories are specified separately.

| PRODUCT CODE | PRICE | SIZE/INCHES | | | WEIGHT LBS | VOL FT ³ |
|-----------------|-------|-------------|----|----|---------------|------------------------|
| | | H | W | D | | |
| HX3PF | 2174 | 54 | 72 | 30 | 85 | 14.10 |

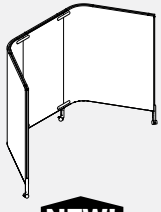
HX3PFM • Freestanding Mobile Softpod with 3 Dividers**NEW!**

- Complete 3 divider pod consisting of one straight back divider, and two side j-dividers.
- Installed pod measures 54"h from the floor, and has a clearance of 6 3/8" at floor level.
- Dividers are surfaced with tackable PET Felt. Please choose any standard PET Felt color. Interior PET Felt color may be different than the outer.
- The divider perimeter reveal trim accepts privacy extensions and is made of polypropylene available only in CHR - Charcoal.
- Metal legs with casters and stiffeners are powder coated paint. Please specify standard paint finish.
- Complete pod includes all connecting hardware, tubular legs, casters and supporting brackets.
- Extensions, electrical, storage and accessories are specified separately.

| PRODUCT CODE | PRICE | SIZE/INCHES | | | WEIGHT LBS | VOL FT ³ |
|-----------------|-------|-------------|----|----|---------------|------------------------|
| | | H | W | D | | |
| HX3PFM | 2204 | 54 | 72 | 30 | 85 | 14.10 |

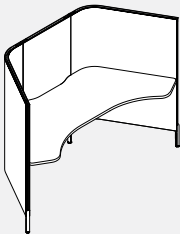
HX3P5472SW • Softpod with 3 Dividers and Worksurface

- Complete 3 divider pod consisting of one straight back divider, two side j-dividers and one standard worksurface.
- Installed pod measures 54"h from the floor, 25" from top of surface and has a clearance of 6 3/8" at floor level.
- Dividers are surfaced with tackable PET Felt. Please choose any standard PET Felt color. Interior PET Felt color may be different than the outer.
- The divider perimeter reveal trim accepts privacy extensions and is made of polypropylene available only in CHR - Charcoal.
- Surface choice of LP - low pressure or HP - high pressure laminate with PVC edge. Please choose any standard laminate and PVC edge.
- Metal legs are powder coated paint. Please specify standard paint finish.
- Complete pod includes all connecting hardware, tubular legs and supporting brackets.
- Extensions, electrical, storage and accessories are specified separately.

| PRODUCT CODE | PRICE | | SIZE/INCHES | | | WEIGHT LBS | VOL FT ³ |
|-----------------|-------|------|-------------|----|----|---------------|------------------------|
| | LP | HP | H | W | D | | |
| HX3P5472SW | 2910 | 3293 | 54 | 72 | 30 | 127 | 22.92 |

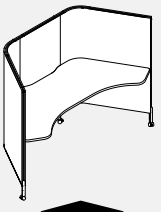
HX3PM5472SW • Mobile Softpod with 3 Dividers and Worksurface**NEW!**

- Complete 3 divider pod consisting of one straight back divider, two side j-dividers and worksurface.
- Installed pod measures 54"h from the floor, 25" from top of surface and has a clearance of 6 3/8" at floor level.
- Dividers are surfaced with tackable PET Felt. Please choose any standard PET Felt color. Interior PET Felt color may be different than the outer.
- The divider perimeter reveal trim accepts privacy extensions and is made of polypropylene available only in CHR - Charcoal.
- Surface choice of LP - low pressure or HP - high pressure laminate with PVC edge. Please choose any standard laminate and PVC edge.
- Metal legs with casters and stiffeners are powder coated paint. Please specify standard paint finish.
- Complete pod includes all connecting hardware, tubular legs, casters and supporting brackets.

| PRODUCT CODE | PRICE | | SIZE/INCHES | | | WEIGHT LBS | VOL FT ³ |
|-----------------|-------|------|-------------|----|----|---------------|------------------------|
| | LP | HP | H | W | D | | |
| HX3PM5472SW | 2970 | 3408 | 54 | 72 | 30 | 127 | 22.92 |

HX3PH5472SW • Softpod with 3 Dividers and Height Adjustable Worksurface

- Complete 3 divider pod consisting of one straight back divider, two side j-dividers and one height adjustable worksurface.
- Installed pod measures 54"h from the floor and has a clearance of 6 3/8" at floor level.
- Dividers are surfaced with tackable PET Felt. Please choose any standard PET Felt color. Interior PET Felt color may be different than the outer.
- The divider perimeter reveal trim accepts privacy extensions and is made of polypropylene available only in CHR - Charcoal.
- Surface choice of LP - low pressure or HP - high pressure laminate with PVC edge. Please choose any standard laminate and PVC edge.
- Panel legs are powder coated paint. Please specify standard paint finish.
- Height adjustable legs are powder coated. Choose from BLK -Black, DWT -Designer White, SIL - Silver . Additional finishes available at an additional 200\$ upcharge. (BZD -Blizzard, CHR -Charcoal, NEV -Nevada, SDT -Stonedust, TPE -Taupe TIN -Ink, TUN - Tungsten)
- Complete pod includes all connecting hardware, tubular legs and supporting brackets.
- Extensions, electrical, storage and accessories are specified separately.

| PRODUCT CODE | PRICE | | SIZE/INCHES | | | WEIGHT LBS | VOL FT ³ |
|--------------|-------|------|-------------|----|----|------------|---------------------|
| | LP | HP | H | W | D | | |
| HX3PH5472SW | 4463 | 4901 | 54 | 72 | 30 | 133 | 23.48 |

HX4PF • Freestanding Softpod with 4 Dividers

- Complete 4 divider pod consisting of one straight back divider, and three side j-dividers.
- Installed pod measures 54"h from the floor, 25" from top of surface and has a clearance of 6 3/8" at floor level.
- Dividers are surfaced with tackable PET Felt. Please choose any standard PET Felt color. Interior PET Felt color may be different than the outer.
- The divider perimeter reveal trim accepts privacy extensions and is made of polypropylene available only in CHR - Charcoal.
- Metal legs and stiffeners are powder coated paint. Please specify standard paint finish.
- Complete pod includes all connecting hardware, tubular legs and supporting brackets.
- Extensions, electrical, storage and accessories are specified separately.

| PRODUCT CODE | PRICE | SIZE/INCHES | | | WEIGHT LBS | VOL FT ³ |
|--------------|-------|-------------|----|----|------------|---------------------|
| | | H | W | D | | |
| HX4PF | 2971 | 54 | 72 | 30 | 117 | 14.10 |

HX4PFM • Freestanding Mobile Softpod with 4 Dividers

- Complete 4 divider pod consisting of one straight back divider, and three side j-dividers.
- Installed pod measures 54"h from the floor, 25" from top of surface and has a clearance of 6 3/8" at floor level.
- Dividers are surfaced with tackable PET Felt. Please choose any standard PET Felt color. Interior PET Felt color may be different than the outer.
- The divider perimeter reveal trim accepts privacy extensions and is made of polypropylene available only in CHR - Charcoal.
- Metal legs with casters and stiffeners are powder coated paint. Please specify standard paint finish.
- Complete pod includes all connecting hardware, tubular legs, casters and supporting brackets.
- Extensions, electrical, storage and accessories are specified separately.

| PRODUCT CODE | PRICE | SIZE/INCHES | | | WEIGHT LBS | VOL FT ³ |
|--------------|-------|-------------|----|----|------------|---------------------|
| | | H | W | D | | |
| HX4PFM | 3009 | 54 | 72 | 30 | 117 | 14.10 |

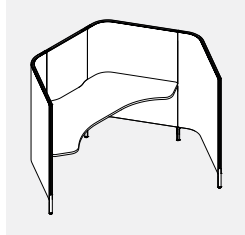
HX4P5472SW • Softpod with 4 Dividers and Worksurface

- Complete 4 divider pod consisting of one straight back divider, three side j-dividers and one standard worksurface.
- Installed pod measures 54"h from the floor, 25" from top of surface and has a clearance of 6 3/8" at floor level.
- Dividers are surfaced with tackable PET Felt. Please choose any standard PET Felt color. Interior PET Felt color may be different than the outer.
- The divider perimeter reveal trim accepts privacy extensions and is made of polypropylene available only in CHR - Charcoal.
- Surface choice of LP - low pressure or HP - high pressure laminate with PVC edge. Please choose any standard laminate and PVC edge.
- Metal legs are powder coated paint. Please specify standard paint finish.
- Complete pod includes all connecting hardware, tubular legs and supporting brackets.
- Wing divider can be installed left or right.
- Extensions, electrical, storage and accessories are specified separately.

| PRODUCT CODE | PRICE | | SIZE/INCHES | | | WEIGHT LBS | VOL FT ³ |
|--------------|-------|------|-------------|----|----|------------|---------------------|
| | LP | HP | H | W | D | | |
| HX4P5472SW | 3654 | 4036 | 54 | 72 | 65 | 170 | 25.41 |

HX4P5472R/LW • Softpod with 4 Dividers and Wrap Around Worksurface

- Complete 4 divider pod consisting of one straight back divider, three side j-dividers and one standard wrap around worksurface.
- Installed pod measures 54"h from the floor, 25" from top of surface and has a clearance of 6 3/8" at floor level.
- Dividers are surfaced with tackable PET Felt. Please choose any standard PET Felt color. Interior PET Felt color may be different than the outer.
- The divider perimeter reveal trim accepts privacy extensions and is made of polypropylene available only in CHR - Charcoal.
- Surface choice of LP - low pressure or HP - high pressure laminate with PVC edge. Please choose any standard laminate and PVC edge.
- Metal legs are powder coated paint. Please specify standard paint finish.
- Complete pod includes all connecting hardware, tubular legs and supporting brackets.
- Extensions, electrical, storage and accessories are specified separately.

| PRODUCT CODE | PRICE | | SIZE/INCHES | | | WEIGHT LBS | VOL FT ³ |
|--------------|-------|------|-------------|----|----|------------|---------------------|
| | LP | HP | H | W | D | | |
| HX4P5472RW | 3977 | 4516 | 54 | 72 | 65 | 185 | 25.41 |
| HX4P5472LW | 3977 | 4516 | 54 | 72 | 65 | 185 | 25.41 |

Right Hand Shown

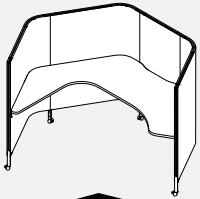
HX4PM5472R/LW • Mobile Softpod with 4 Dividers and Worksurface**NEW!**

- Complete 4 divider pod consisting of one straight back divider, three side j-dividers and one work surface.
- Installed pod measures 54"h from the floor, 25" from top of surface and has a clearance of 6 3/8" at floor level.
- Dividers are surfaced with tackable PET Felt. Please choose any standard PET Felt color. Interior PET Felt color may be different than the outer.
- The divider perimeter reveal trim accepts privacy extensions and is made of polypropylene available only in CHR - Charcoal.
- Surface choice of LP - low pressure or HP - high pressure laminate with PVC edge. Please choose any standard laminate and PVC edge.
- Metal legs with casters and stiffeners are powder coated paint. Please specify standard paint finish.
- Complete pod includes all connecting hardware, tubular legs, casters and supporting brackets.

| PRODUCT CODE | PRICE | | SIZE/INCHES | | | WEIGHT | | VOL FT ³ |
|--------------|-------|------|-------------|----|----|--------|-------|---------------------|
| | LP | HP | H | W | D | LBS | | |
| HX4PM5472LW | 4028 | 4644 | 54 | 72 | 65 | 168 | 25.41 | |
| HX4PM5472RW | 4028 | 4644 | 54 | 72 | 65 | 168 | 25.41 | |

HX5PF • Freestanding Softpod with 5 Dividers**NEW!**

- Complete 5 divider pod consisting of one straight back divider, four side j-dividers.
- Installed pod measures 54"h from the floor and has a clearance of 6 3/8" at floor level.
- Dividers are surfaced with tackable PET Felt. Please choose any standard PET Felt color. Interior PET Felt color may be different than the outer.
- The divider perimeter reveal trim accepts privacy extensions and is made of polypropylene available only in CHR - Charcoal.
- Metal legs and stiffeners are powder coated paint. Please specify standard paint finish.
- Complete pod includes all connecting hardware, tubular legs and supporting brackets.
- Extensions, electrical, storage and accessories are specified separately.

| PRODUCT CODE | PRICE | SIZE/INCHES | | | WEIGHT | | VOL FT ³ |
|--------------|-------|-------------|----|----|--------|-------|---------------------|
| | | H | W | D | LBS | | |
| HX5PF | 3767 | 54 | 72 | 65 | 148 | 28.24 | |

HX5PFM • Freestanding Mobile Softpod with 5 Dividers**NEW!**

- Complete 5 divider pod consisting of one straight back divider, four side j-dividers.
- Installed pod measures 54"h from the floor and has a clearance of 6 3/8" at floor level.
- Dividers are surfaced with tackable PET Felt. Please choose any standard PET Felt color. Interior PET Felt color may be different than the outer.
- The divider perimeter reveal trim accepts privacy extensions and is made of polypropylene available only in CHR - Charcoal.
- Metal legs with casters and stiffeners are powder coated paint. Please specify standard paint finish.
- Complete pod includes all connecting hardware, tubular legs, casters and supporting brackets.
- Extensions, electrical, storage and accessories are specified separately.

| PRODUCT CODE | PRICE | SIZE/INCHES | | | WEIGHT | | VOL FT ³ |
|--------------|-------|-------------|----|----|--------|-------|---------------------|
| | | H | W | D | LBS | | |
| HX5PFM | 3814 | 54 | 72 | 65 | 148 | 28.24 | |

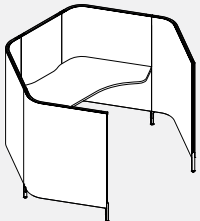
HX5P5472SW • Softpod with 5 Dividers and Worksurface

- Complete 5 divider pod consisting of one straight back divider, four side j-dividers and one standard work surface.
- Installed pod measures 54"h from the floor, 25" from top of surface and has a clearance of 6 3/8" at floor level.
- Dividers are surfaced with tackable PET Felt. Please choose any standard PET Felt color. Interior PET Felt color may be different than the outer.
- The divider perimeter reveal trim accepts privacy extensions and is made of polypropylene available only in CHR - Charcoal.
- Surface choice of LP - low pressure or HP - high pressure laminate with PVC edge. Please choose any standard laminate and PVC edge.
- Metal legs are powder coated paint. Please specify standard paint finish.
- Complete pod includes all connecting hardware, tubular legs and supporting brackets.
- Wing dividers can be installed both on left or right side or one on each side.
- Extensions, electrical, storage and accessories are specified separately.

| PRODUCT CODE | PRICE | | SIZE/INCHES | | | WEIGHT | | VOL FT ³ |
|--------------|-------|------|-------------|----|----|--------|-------|---------------------|
| | LP | HP | H | W | D | LBS | | |
| HX5P5472SW | 4462 | 4845 | 54 | 72 | 65 | 198 | 32.41 | |

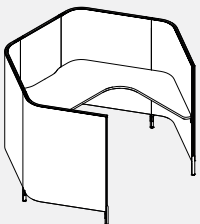
HX5P5472R/LW • Softpod with 5 Dividers and Wrap Around Worksurface

Right Hand Shown

- Complete 5 divider pod consisting of one straight back divider, four side j-dividers and one standard wrap around work surface.
- Installed pod measures 54"h from the floor, 25" from top of surface and has a clearance of 6 3/8" at floor level.
- Dividers are surfaced with tackable PET Felt. Please choose any standard PET Felt color. Interior PET Felt color may be different than the outer.
- The divider perimeter reveal trim accepts privacy extensions and is made of polypropylene available only in CHR - Charcoal.
- Surface choice of LP - low pressure or HP - high pressure laminate with PVC edge. Please choose any standard laminate and PVC edge.
- Metal legs are powder coated paint. Please specify standard paint finish.
- Complete pod includes all connecting hardware, tubular legs and supporting brackets.
- Extra wing divider can be installed on left or right side.
- Extensions, electrical, storage and accessories are specified separately.

| PRODUCT CODE | PRICE | | SIZE/INCHES | | | WEIGHT | | VOL FT ³ |
|--------------|-------|------|-------------|----|----|--------|-------|---------------------|
| | LP | HP | H | W | D | LBS | | |
| HX5P5472RW | 4739 | 5277 | 54 | 72 | 65 | 213 | 32.41 | |
| HX5P5472LW | 4739 | 5277 | 54 | 72 | 65 | 213 | 32.41 | |

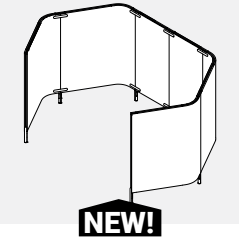
HX6PF • Freestanding Softpod with 6 Dividers**NEW!**

- Complete 6 divider pod consisting of two straight back dividers, and four side j-dividers.
- Installed pod measures 54"h from the floor and has a clearance of 6 3/8" at floor level.
- Dividers are surfaced with tackable PET Felt. Please choose any standard PET Felt color. Interior PET Felt color may be different than the outer.
- The divider perimeter reveal trim accepts privacy extensions and is made of polypropylene available only in CHR - Charcoal.
- Metal legs and stiffeners are powder coated paint. Please choose CHR - Charcoal or DWT - Designer White.
- Complete pod includes all connecting hardware, tubular legs and supporting brackets.
- Extensions, electrical, storage and accessories are specified separately.

| PRODUCT CODE | PRICE | SIZE/INCHES | | | WEIGHT LBS | VOL FT ³ |
|--------------|-------|-------------|----|----|------------|---------------------|
| | | H | W | D | | |
| HX6PF | 4559 | 54 | 96 | 65 | 171 | 28.24 |

HX6PFD • Softpod with 6 Dividers with D Top Worksurface**NEW!**

- Complete 6 divider pod consisting of two straight back dividers, four side j-dividers, and one collaborative worksurface.
- Installed pod measures 54"h from the floor and has a clearance of 6 3/8" at floor level.
- Dividers are surfaced with tackable PET Felt. Please choose any standard PET Felt color. Interior PET Felt color may be different than the outer.
- The divider perimeter reveal trim accepts privacy extensions and is made of polypropylene available only in CHR - Charcoal.
- Metal legs and stiffeners are powder coated paint. Please specify standard paint finish.
- Worksurface features a scoop to pass through wires.
- Surface choice of LP - low pressure or HP - high pressure laminate with PVC edge. Please choose any standard laminate and PVC edge.
- Complete pod includes all connecting hardware, tubular legs and supporting brackets.
- Extensions, electrical, storage and accessories are specified separately.

| PRODUCT CODE | PRICE | | SIZE/INCHES | | | WEIGHT LBS | VOL FT ³ |
|--------------|-------|------|-------------|----|----|------------|---------------------|
| | LP | HP | H | W | D | | |
| HX6PFD | 5190 | 5426 | 54 | 96 | 65 | 218 | 30.76 |

HX7PF • Freestanding Softpod with 7 Dividers**NEW!**

- Complete 7 divider pod consisting of two straight back dividers, and four side j-dividers.
- Installed pod measures 54"h from the floor and has a clearance of 6 3/8" at floor level.
- Dividers are surfaced with tackable PET Felt. Please choose any standard PET Felt color. Interior PET Felt color may be different than the outer.
- The divider perimeter reveal trim accepts privacy extensions and is made of polypropylene available only in CHR - Charcoal.
- Metal legs and stiffeners are powder coated paint. Please specify standard paint finish.
- Complete pod includes all connecting hardware, tubular legs and supporting brackets.
- Extensions, electrical, storage and accessories are specified separately.

| PRODUCT CODE | PRICE | SIZE/INCHES | | | WEIGHT LBS | VOL FT ³ |
|--------------|-------|-------------|-----|----|------------|---------------------|
| | | H | W | D | | |
| HX7PF | 5127 | 54 | 119 | 65 | 194 | 28.24 |

HX7PFD • Softpod with 7 Dividers with D Top Worksurface**NEW!**

- Complete 7 divider pod consisting of two straight back dividers, four side j-dividers, and one collaborative worksurface.
- Installed pod measures 54"h from the floor and has a clearance of 6 3/8" at floor level.
- Dividers are surfaced with tackable PET Felt. Please choose any standard PET Felt color. Interior PET Felt color may be different than the outer.
- The divider perimeter reveal trim accepts privacy extensions and is made of polypropylene available only in CHR - Charcoal.
- Metal legs and stiffeners are powder coated paint. Please specify standard paint finish.
- Worksurface features a scoop to pass through wires.
- Surface choice of LP - low pressure or HP - high pressure laminate with PVC edge. Please choose any standard laminate and PVC edge.
- Complete pod includes all connecting hardware, tubular legs and supporting brackets.
- Extensions, electrical, storage and accessories are specified separately.

| PRODUCT CODE | PRICE | | SIZE/INCHES | | | WEIGHT LBS | VOL FT ³ |
|--------------|-------|------|-------------|-----|----|------------|---------------------|
| | LP | HP | H | W | D | | |
| HX7PFD | 5889 | 6125 | 54 | 119 | 65 | 25 | 30.76 |

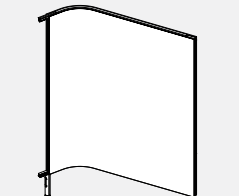
HXP5430 • Single J-divider**NEW!**

- A single divider is curved; non-handed symmetrical along the horizontal axis.
- J-dividers are surfaced with tackable PET Felt. Please choose any standard PET Felt color. Interior PET Felt color may be different than the outer.
- Installed pod measures 54"h from the floor, 25" from top of surface and has a clearance of 6 3/8" at floor level.
- The divider perimeter reveal trim accepts privacy extensions and is made of polypropylene available only in CHR - Charcoal.
- J-divider comes complete with top connector kit, shared leg kit and trim.
- If a Single J-divider is ordered as an add-on to a previous order, the PET Felt finish may or may not match based on dyelot and fading.
- Single J-divider is not intended to be used alone without a complete kit including a work surface due to stability and connectivity constraints.

| PRODUCT CODE | PRICE | SIZE/INCHES | | | WEIGHT LBS | VOL FT ³ |
|--------------|-------|-------------|----|---|------------|---------------------|
| | | H | W | D | | |
| HXP5430AP | 833 | 54 | 30 | 6 | 28 | 16.17 |

HXPCKIT • Connection Kit**NEW!**

- Kit consists of all hardware required to connect two Softpods end-to-end.
- For use in special configurations when a customer wants to link several Softpods together.

| PRODUCT CODE | PRICE | SIZE/INCHES | | | WEIGHT LBS | VOL FT ³ |
|--------------|-------|-------------|------|------|------------|---------------------|
| | | H | W | D | | |
| HXPCKIT | 29 | 1.81 | 5.00 | 0.86 | 0.18 | 0.004 |

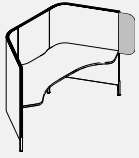
HXPAEFE • End PET Felt Extension Divider Add-on

- Designed to add 8.7" of additional privacy at the end of the divider.
- Fits into the base divider perimeter reveal and placement is user oriented.
- PET Felt divider surface is tackable. Choose from standard PET finishes.
- NOTE : Not available with a perforated pattern.

| PRODUCT CODE | PRICE | SIZE/INCHES | | | WEIGHT LBS | VOL FT ³ |
|-----------------|-------|-------------|-----|------|---------------|------------------------|
| | | H | W | D | | |
| HXPAEFE | 40 | 25.4 | 9.3 | 0.35 | 0.63 | 0.05 |

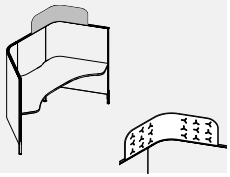
HXPACFE • Corner PET Felt Extension Divider Add-on

- Designed to add 11.1" of additional privacy at the top corner of the divider.
- Fits into the base divider perimeter reveal and placement is user oriented.
- Installed station with Corner PET Felt Extension Divider Add-on installed measures 65" from floor, 36" from top of worksurface.
- PET Felt divider surface is tackable. Choose from standard PET finishes.
- Perforated pattern option available, shown with "P" at the end of the code.

| PRODUCT CODE | PRICE | SIZE/INCHES | | | WEIGHT LBS | VOL FT ³ |
|-----------------|-------|-------------|------|------|---------------|------------------------|
| | | H | W | D | | |
| HXPACFE | 71 | 11.687 | 38.3 | 0.35 | 1.16 | 0.09 |
| HXPACFEP | 142 | 11.687 | 38.3 | 0.35 | 1.16 | 0.09 |

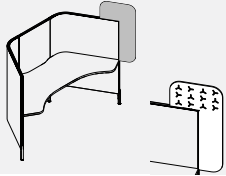
HXPATCFE • Top Corner PET Felt Extension Divider Add-on

- Designed to add 8.7" of additional privacy to the top of the divider and 11.1" at the end of the divider.
- Fits into the base divider perimeter reveal and placement is user oriented.
- Installed station with Corner PET Felt Extension Divider Add-on installed measures 65" from floor, 36" from top of worksurface.
- PET Felt divider surface is tackable. Choose from standard PET finishes.
- Perforated pattern option available, shown with "P" at the end of the code.

| PRODUCT CODE | PRICE | SIZE/INCHES | | | WEIGHT LBS | VOL FT ³ |
|-----------------|-------|-------------|------|------|---------------|------------------------|
| | | H | W | D | | |
| HXPATCFE | 77 | 37.1 | 19.5 | 0.35 | 1.25 | 0.15 |
| HXPATCFEP | 154 | 37.1 | 19.5 | 0.35 | 1.25 | 0.15 |

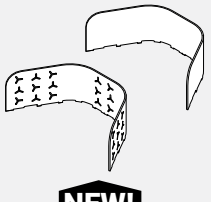
HXPA1CFE • PET Felt Extension Divider Add-on for Softpod with 2 Dividers**NEW!**

- Designed to add 11.1" of additional privacy at the top of the divider assembly.
- Fits into the base divider perimeter reveal and placement is user oriented.
- Installed station with PET Felt Extension Divider Add-on installed measures 65" from floor, 36" from top of worksurface.
- PET Felt divider surface is tackable. Choose from standard PET finishes.
- Perforated option available, shown with "P" at the end of the code.

| PRODUCT CODE | PRICE | SIZE/INCHES | | | WEIGHT LBS | VOL FT ³ |
|-----------------|-------|-------------|-------|------|---------------|------------------------|
| | | H | W | D | | |
| HXPA1CFE | 132 | 11.687 | 55.51 | 0.35 | 2.30 | 0.13 |
| HXPA1CFEP | 265 | 11.687 | 55.51 | 0.35 | 2.30 | 0.13 |

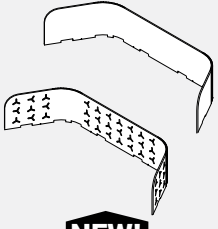
HXPA2CFE • PET Felt Extension Divider Add-on for Softpod with 3 Dividers**NEW!**

- Designed to add 11.1" of additional privacy at the top of the divider assembly.
- Fits into the base divider perimeter reveal and placement is user oriented.
- Installed station with PET Felt Extension Divider Add-on installed measures 65" from floor, 36" from top of worksurface.
- PET Felt divider surface is tackable. Choose from standard PET finishes.
- Perforated option available, shown with "P" at the end of the code.

| PRODUCT CODE | PRICE | SIZE/INCHES | | | WEIGHT LBS | VOL FT ³ |
|-----------------|-------|-------------|-------|------|---------------|------------------------|
| | | H | W | D | | |
| HXPA2CFE | 150 | 11.687 | 78.28 | 0.35 | 2.60 | 0.19 |
| HXPA2CFEP | 300 | 11.687 | 78.28 | 0.35 | 2.60 | 0.19 |

HXPACFES • Corner Semitransparent Extension Panel Add-on**NEW!**

- Designed to add 11" of additional privacy on top of the height adjustable worksurface.
- Fits into the base divider perimeter reveal and placement is user oriented.
- Installed station with Extension Divider Add-on installed measures 65" from floor, 36" from top of worksurface.
- Divider is frosted for added privacy.
- Choose from 3 colours: TNC - Translucent, TNB - Blue, TNY - Yellow.

| PRODUCT CODE | PRICE | SIZE/INCHES | | | WEIGHT LBS | VOL FT ³ |
|-----------------|-------|-------------|-------|------|---------------|------------------------|
| | | H | W | D | | |
| HXPACFES | 723 | 11.687 | 29.50 | 16.8 | 1.11 | 3.35 |

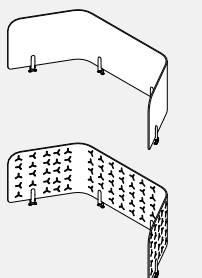
HXPACFEHP • PET Felt Extension Panel Add-on for Softpod Height Adjustable Table**NEW!**

- Designed to add 20" of additional privacy on top of the height adjustable worksurface.
- Aluminum mounting brackets fasten to underside of worksurface.
- Curved PET fits into aluminum mounting brackets.
- Installed station with PET Privacy Screen Add-on installed measures 69" from floor at maximum height, 20" from top of worksurface.
- PET Felt privacy screen surface is tackable. Choose from standard PET finishes.
- Perforated option available, shown with "P" at the end of the code.

| PRODUCT CODE | PRICE | SIZE/INCHES | | | WEIGHT LBS | VOL FT ³ |
|-----------------|-------|-------------|-------|-------|---------------|------------------------|
| | | H | W | D | | |
| HXPACFEH | 303 | 19 | 63.50 | 21.70 | 1.65 | 5.94 |
| HXPACFEHP | 607 | 19 | 63.50 | 21.70 | 1.65 | 5.94 |

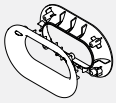
HXEPGK • Divider Grommet Kit

- Divider Grommet Kit facilitates passage of wires through any Softpod divider.
- Can be located either below or above the worksurface.
- Installed on site; no need to order special dividers.
- Powder coated die-cast aluminum divider grommet - specify CHR - Charcoal or WHT (OR DWT)

| PRODUCT CODE | PRICE | SIZE/INCHES | | | WEIGHT LBS | VOL FT ³ |
|--------------|-------|-------------|------|------|------------|---------------------|
| | | H | W | D | | |
| HXEPGK | 29 | 3.25 | 5.50 | 2.75 | 0.27 | 0.02 |

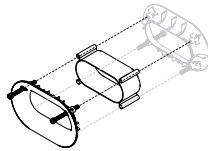
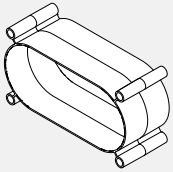
HXEPGCS • Divider Grommet Connector / Spacer

- Divider Grommet Spacer converts any Divider Grommet Kit into a connector.
- Clamps two dividers together through the divider grommet opening.
- Can be located above or below the worksurface at pre-determined locations.
- Specify with the Divider Grommet Kit or use with the Divider Grommet Kit included in the Station 2-Circuit Power Kit.
- Made of injection molded ABS in CHR - Charcoal.
- For Dual Pod connection, only 1 HXEPGK is needed.

| PRODUCT CODE | PRICE | SIZE/INCHES | | | WEIGHT LBS | VOL FT ³ |
|--------------|-------|-------------|------|------|------------|---------------------|
| | | H | W | D | | |
| HXEPGCS | 13 | 3.25 | 5.50 | 2.75 | 0.04 | 0.01 |

GMDPC22W • Slim Desktop Power Module, 2 Simplex

- Desktop power center with two 15A tamper resistant power receptacles, one USB-A and one USB-C (provides 3.1A); 10' power cord.
- Includes three mounting options (i) a screw-in mounting plate for forward facing outlets; or (ii) an under surface mount bracket; or (iii) a clamp mounting kit for 0.5-1.5" thick surfaces.
- Gloss white body with grey face.

| PRODUCT CODE | PRICE | SIZE/INCHES | | | WEIGHT LBS | VOL FT ³ |
|--------------|-------|-------------|------|------|------------|---------------------|
| | | H | W | D | | |
| GMDPC22W | 449 | 2.25 | 4.88 | 2.25 | 2.5 | 0.5 |

GMDPC32W • Slim Desktop Power Module, 3 Simplex

- Desktop power center with three 15A tamper resistant power receptacles, one USB-A and one USB-C (provides 3.1A); 10' power cord.
- Includes three mounting options (i) a screw-in mounting plate for forward facing outlets; or (ii) an under surface mount bracket; or (iii) a clamp mounting kit for 0.5-1.5" thick surfaces.
- Gloss white body with grey face.

| PRODUCT CODE | PRICE | SIZE/INCHES | | | WEIGHT LBS | VOL FT ³ |
|--------------|-------|-------------|------|------|------------|---------------------|
| | | H | W | D | | |
| GMDPC32W | 586 | 2.25 | 6.00 | 2.25 | 2.6 | 0.5 |

BRED50AC • Duo Module with A+C

- **The Duo power module is completely integrated with a mounting clamp to attach to the edge of a worksurface.**
- Provides two 15 Amp 120 Volt AC Receptacles; 2.4 amp USB-A port and 60 watt USB-C power delivery port.
- 10' long three-prong cord.
- Available in W - White or B - Black as indicated by last letter of model number.

| PRODUCT CODE | PRICE | SIZE/INCHES | | | WEIGHT LBS | VOL FT ³ |
|--------------|-------|-------------|-----|-----|------------|---------------------|
| | | H | W | D | | |
| BRED50ACW | 695 | 3 | 5.5 | 3.2 | 3 | 0.2 |
| BRED50ACB | 695 | 3 | 5.5 | 3.2 | 3 | 0.2 |

BREDU51AC • Duo Under Module with A+C

- **The Duo under power module comes with a thin flush mounting bracket to attach to the underside of a work surface or above work surface shelves.**
- Provides two 15 Amp 120 Volt AC Receptacles; 2.4 amp USB-A port and 60 watt USB-C power delivery port.
- 10' long three-prong cord.
- Available in W - White or B - Black as indicated by last letter of model number.

| PRODUCT CODE | PRICE | SIZE/INCHES | | | WEIGHT LBS | VOL FT ³ |
|--------------|-------|-------------|-----|-----|------------|---------------------|
| | | H | W | D | | |
| BREDU51ACW | 695 | 1.8 | 5.5 | 2.8 | 3 | 0.2 |
| BREDU51ACB | 695 | 1.8 | 5.5 | 2.8 | 3 | 0.2 |

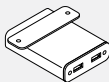
HXEUWC • Under Worksurface/ Edge USB Charger

- Under surface table mounted module - dual USB (A&C) charging ports.
- Consists of one 15 watt USB C charging outlet and one 2.1 amp USB A charging outlet.
- Unit has white housing, white powder coated mounting bracket and white electrical cord.

| PRODUCT CODE | PRICE | SIZE/INCHES | | | WEIGHT LBS | VOL FT ³ |
|--------------|-------|-------------|---|---|------------|---------------------|
| | | H | W | D | | |
| HXEUWC | 367 | 1 | 3 | 4 | 0.31 | 0.01 |

GAADG • Access Door Module

- Soft close door is set back from edge to allow for cable pass thru.
- Available in all standard divider frame finishes.
- GAADGDH includes device holder for most mobilephones or tablets. Holder is only available in white.
- FreeFit can only accommodate one grommet per worksurface.

| PRODUCT CODE | PRICE | SIZE/INCHES | | | WEIGHT LBS | VOL FT ³ |
|--------------|-------|-------------|------|-------|------------|---------------------|
| | | H | D | W | | |
| GAADG | 60 | 1.08 | 5.54 | 10.09 | 2 | 0.04 |
| GAADGDH | 65 | 1.08 | 5.54 | 10.09 | 2 | 0.04 |

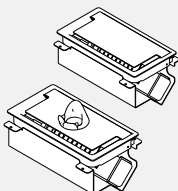
GAADCT • Access Door Module with Cable Tray

- Soft close door is set back from edge to allow for cable pass thru when closed.
- Cable tray comes one standard telcom knock out and a platform to mount a powerbar.
- Sides are open for easy access.
- Available in all standard divider frame finishes.
- GAADCTDH includes device holder for most mobile phones or tablets. Holder is only available in white.
- FreeFit can only accommodate one grommet per worksurface

| PRODUCT CODE | PRICE | SIZE/INCHES | | | WEIGHT LBS | VOL FT ³ |
|--------------|-------|-------------|------|-------|------------|---------------------|
| | | H | D | W | | |
| GAADCT | 95 | 5.07 | 5.54 | 10.09 | 4 | 0.19 |
| GAADCTDH | 103 | 5.07 | 5.54 | 10.09 | 4 | 0.19 |

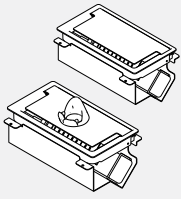
GAADCTPD • Access Door Module with Cable Tray and Power Bar

- Access door module with cable tray and power bar.
- Powerbar with 3 simplex and 2 USB, CSA Certified.
- Soft close door is set back from edge to allow for cable pass thru when closed.
- Sides are open for easy access.
- Cable tray comes one standard telcom knock out and a platform to mount a powerbar.
- Housing Paint Finish - TBD
- GAADCTPDDH includes device holder for most mobile phones or tablets.
- Holder is only available in white.
- One grommet per worksurface.

| PRODUCT CODE | PRICE | SIZE/INCHES | | | WEIGHT LBS | VOL FT ³ |
|-----------------|-------|-------------|------|-------|---------------|------------------------|
| | | H | D | W | | |
| GAADCTPD | 208 | 6.96 | 5.54 | 10.09 | 4 | 0.20 |
| GAADCTPDDH | 212 | 6.96 | 5.54 | 10.09 | 4 | 0.20 |

ModPower Daisy Chain Solution

- Adds flexible power and USB charging to work surfaces.
- Connects up to four units with a single corded infeed with NEMA plug.
- Begin the run with a starter unit which includes a coded infeed. Add additional middle or end units as required.
- Middle and end units are equipped with connecting cables.
- In-surface modules require table top cut-outs for mounting. Please specify TR - Top Right and/or TL - Top Left.
- ModPower units are sold separately.

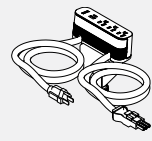
GMDSA10 • ModPower Starter Mounted Unit

- ModPower starter unit includes one 10' cord with a NEMA plug and one 3' connector cord.
- Unit equipped with three 15A tamper resistant receptacles, one USB-A and one USB-C charging ports and a circuit breaker.
- Includes edge clamp and 3 other mounting methods; and 4 cable management cord clips.
- MG at the end of the code indicates a magnesium finish, while WH is a white finish.

| PRODUCT CODE | PRICE | H | W | D | WEIGHT LBS | VOL FT ³ |
|-----------------|-------|------|------|-----|---------------|------------------------|
| | | | | | | |
| GMDSA10WH | 631 | 6.13 | 1.75 | 2.5 | 4.33 | 1.0 |

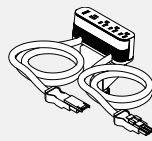
GMDCA3 • ModPower Middle Mounted Unit

- ModPower middle unit includes two 3' connector cords.
- Unit equipped with three 15A rated 12A tamper resistant receptacles, one USB-A and one USB-C charging ports and a circuit breaker.
- Includes edge clamp and 3 other mounting methods; and 4 cable management cord clips.
- MG at the end of the code indicates a magnesium finish, while WH is a white finish.

| PRODUCT CODE | PRICE | H | W | D | WEIGHT LBS | VOL FT ³ |
|-----------------|-------|------|------|-----|---------------|------------------------|
| | | | | | | |
| GMDCA3WH | 597 | 6.13 | 1.75 | 2.5 | 3.33 | 1.0 |

GMDEA3 • ModPower End Mounted Unit

- ModPower end unit includes one 3' connector cord.
- Unit equipped with three 15A rated 12A tamper resistant receptacles, one USB-A and one USB-C charging ports and a circuit breaker.
- Includes edge clamp and 3 other mounting methods; and 2 cable management cord clips.
- MG at the end of the code indicates a magnesium finish, while WH is a white finish.

| PRODUCT CODE | PRICE | H | W | D | WEIGHT LBS | VOL FT ³ |
|-----------------|-------|------|------|-----|---------------|------------------------|
| | | | | | | |
| GMDEA3WH | 528 | 6.13 | 1.75 | 2.5 | 2.75 | 1.0 |

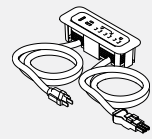
GMDSF10 • ModPower In Surface Starter Unit

- ModPower starter unit includes one 10' cord with a NEMA plug and one 3' connector cord.
- Unit equipped with three 15A tamper resistant receptacles, one USB-A and one USB-C charging ports and a circuit breaker.
- 4 cable management cord clips included.
- MG at the end of the code indicates a magnesium finish, while WH is a white finish.

| PRODUCT CODE | PRICE | H | W | D | WEIGHT LBS | VOL FT ³ |
|-----------------|-------|------|------|------|---------------|------------------------|
| | | | | | | |
| GMDSF10WH | 597 | 2.63 | 7.63 | 2.63 | 3.44 | 1.0 |

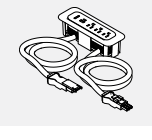
GMDCF3 • ModPower In Surface Middle Unit

- ModPower middle unit includes two 3' connector cords.
- Unit equipped with three 15A rated 12A tamper resistant receptacles, one USB-A and one USB-C charging ports and a circuit breaker.
- 4 cable management cord clips included.
- MG at the end of the code indicates a magnesium finish, while WH is a white finish.

| PRODUCT CODE | PRICE | H | W | D | WEIGHT LBS | VOL FT ³ |
|-----------------|-------|------|------|------|---------------|------------------------|
| | | | | | | |
| GMDCF3WH | 562 | 2.63 | 7.63 | 2.63 | 2.44 | 1.0 |

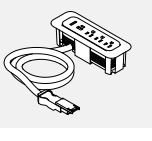
GMDEF3 • ModPower In Surface End Unit

- ModPower end unit includes one 3' connector cord.
- Unit equipped with three 15A rated 12A tamper resistant receptacles, one USB-A and one USB-C charging ports and a circuit breaker.
- 2 cable management cord clips included.
- MG at the end of the code indicates a magnesium finish, while WH is a white finish.

| PRODUCT CODE | PRICE | H | W | D | WEIGHT LBS | VOL FT ³ |
|-----------------|-------|------|------|------|---------------|------------------------|
| | | | | | | |
| GMDEF3WH | 494 | 2.63 | 7.63 | 2.63 | 1.85 | 1.0 |

GMDCLIPS • ModPower Management Clips

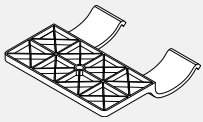

- Includes 10 clips.

| PRODUCT CODE | PRICE | SIZE/INCHES | | | WEIGHT LBS | VOL FT ³ |
|--------------|-------|-------------|-----|-----|------------|---------------------|
| | | H | W | D | | |
| GMDCLIPS | 102 | 2.6 | 2.5 | 0.6 | 0.3 | 0.2 |

GMDJ36BK • ModPower Interconnecting Jumper

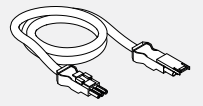

- ModPower interconnecting jumper cord to add an additional 3 feet of cord length between ModPower units.
- Package of 2, each 3 feet with male & female connector.

| PRODUCT CODE | PRICE | SIZE/INCHES | | | WEIGHT LBS | VOL FT ³ |
|--------------|-------|-------------|---|---|------------|---------------------|
| | | H | W | D | | |
| GMDJ36BK | 329 | 36 | | | 1.38 | 0.9 |

HXEPK • Station 2-Circuit Power Kit

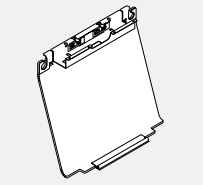

- Station 2-Circuit Power Kit consists of two duplexes, trough, cable shroud and divider grommet.
- Accommodates up to two standard data plates (plates not included).
- Accommodates center mount single or dual screen monitor arm.
- Facilitates 2-circuit power delivery.
- Facilitates interconnection of two stations. Please specify Station to Station Jumper.
- Specify duplex circuit #1, #2 or combination #1+2.
- Ceiling or base feed not included, please specify separately.
- Trough is powder coated metal in CHR - Charcoal.
- Includes all connecting hardware, supporting brackets and through divider grommet.
- PET Felt finish, please chose from any standard PET Felt.
- NOTE: Cannot be used in conjunction with height adjustable tables.

| PRODUCT CODE | PRICE | SIZE/INCHES | | | WEIGHT LBS | VOL FT ³ |
|--------------|-------|-------------|------|------|------------|---------------------|
| | | H | W | D | | |
| HXEPK11 | 311 | 20.85 | 23.5 | 9.73 | 3.92 | 2.76 |
| HXEPK12 | 311 | 20.85 | 23.5 | 9.73 | 3.92 | 2.76 |
| HXEPK22 | 311 | 20.85 | 23.5 | 9.73 | 3.92 | 2.76 |

HXECS • Cable Shroud

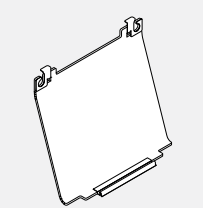

- Cable shroud secures to the bottom of worksurface and clips to the bottom of straight section of any divider.
- Includes all connecting hardware.
- PET Felt finish, please chose from any standard PET Felt.
- NOTE: Cannot be used in conjunction with height adjustable tables.

| PRODUCT CODE | PRICE | SIZE/INCHES | | | WEIGHT LBS | VOL FT ³ |
|--------------|-------|-------------|----|---|------------|---------------------|
| | | H | W | D | | |
| HXECS | 76 | 1 | 22 | 8 | 1.62 | 2.87 |

HXECEF • Ceiling Feed

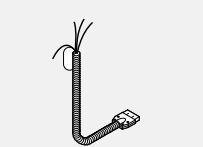

- Ceiling feed plugs into left or right duplex mounted within the 2-Circuit Power Kit.
- 10' long metal conduit, ready to be hardwired to building power supply.
- Strain relief fitting provided; junction box is not included.
- To be used with HXEFCF - Ceiling Feed Pole

| PRODUCT CODE | PRICE | SIZE/INCHES | | | WEIGHT LBS | VOL FT ³ |
|--------------|-------|-------------|-----|------|------------|---------------------|
| | | H | W | D | | |
| HXECEF | 178 | 2.00 | 144 | 2.00 | 5.6 | 0.06 |

HXEFCF • Ceiling Feed Pole

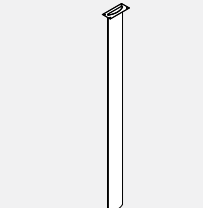

- Ceiling Feed Pole manages power and data cables between ceiling and worksurface.
- Aluminum extrusion with PVC cover secures to the divider grommet and passes below worksurface through the worksurface contured recess.
- Mounting hardware and ceiling bezel included.
- Hardware for securing the pole above ceiling tile is not included.
- Please specify standard paint finish.
- PVC colour CHR - Charcoal.
- Ceiling Feed HXECEF must be ordered separately.

| PRODUCT CODE | PRICE | SIZE/INCHES | | | WEIGHT LBS | VOL FT ³ |
|--------------|-------|-------------|------|------|------------|---------------------|
| | | H | W | D | | |
| HXEFCF | 150 | 116 | 6.00 | 1.50 | 5.49 | 0.38 |

HXEBF • Base Feed

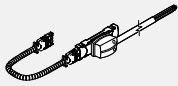

- Base feed provides single power entry from floor into 2-Circuit Power Kit under worksurface.
- 6' long liquid tight whip; ready to be hardwired to building power supply.

| PRODUCT CODE | PRICE | SIZE/INCHES | | | WEIGHT LBS | VOL FT ³ |
|--------------|-------|-------------|----|---|------------|---------------------|
| | | H | W | D | | |
| HXEBF | 354 | 2 | 72 | 2 | 5.6 | 0.06 |

HXEHAP • Height Adjustable Power Kit

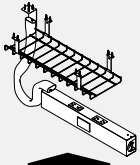

NEW!

- Height Adjustable Circuit Power Kit consists of two duplexes, cable basket, and electrical housing.
- Accommodates one standard data plate (data cover included).
- Facilitates 2-circuit power delivery.
- Specify duplex circuit #1, #2, or combination #1+2.
- Facilitates interconnection of two stations. Please specify Station to Station Jumper.
- Ceiling or base feed not included please specify separately.
- Includes all connecting hardware & supporting brackets.
- Specify standard metal paint finish for the power box.

| PRODUCT CODE | PRICE | SIZE/INCHES | | | WEIGHT LBS | VOL FT ³ |
|--------------|-------|-------------|----|------|------------|---------------------|
| | | H | W | D | | |
| HXEHAP | 563 | 21.50 | 22 | 8.06 | 4.55 | 1.00 |
| HXEHAP12 | 563 | 21.50 | 22 | 8.06 | 4.55 | 1.00 |
| HXEHAP22 | 563 | 21.50 | 22 | 8.06 | 4.55 | 1.00 |

HXEPPJ • Station to Station Jumper Kit

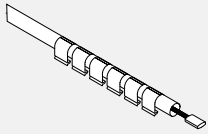

NEW!

- Station to station jumper.
- Facilitates interconnection of two stations (under the worksurface).
- Black neoprene sock of equal length included.
- Mounting clips included (quantity based on length).
- NOTE: Refer to Application Guide for recommended length of jumper kit required.

| PRODUCT CODE | PRICE | H | W | D | WEIGHT | |
|--------------|-------|---|-------|---|--------|-----------------|
| | | | | | LBS | FT ³ |
| HXEPPJ18 | 131 | 2 | 18.50 | 2 | 0.68 | 0.04 |
| HXEPPJ24 | 145 | 2 | 24.50 | 2 | 0.79 | 0.06 |
| HXEPPJ30 | 165 | 2 | 30.50 | 2 | 0.85 | 0.07 |
| HXEPPJ36 | 180 | 2 | 36.50 | 2 | 1.02 | 0.08 |
| HXEPPJ48 | 238 | 2 | 48.50 | 2 | 1.24 | 0.11 |
| HXEPPJ60 | 263 | 2 | 60.50 | 2 | 1.46 | 0.14 |
| HXEPPJ72 | 285 | 2 | 72.50 | 2 | 1.68 | 0.17 |
| HXEPPJ78 | 287 | 2 | 78.50 | 2 | 1.79 | 0.18 |

HXSCSO • Under Worksurface Casual Storage Unit

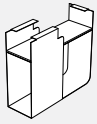

- Open storage with shelf; extension at the back provides side compartment.
- Sheet metal construction with PET liner; 24" deep
- Secured to the bottom of worksurface.
- Choose from standard PET and panel frame finishes.
- Order coat hook HXACHS, attaches to either left or right side of storage unit (sold separately).
- Can not be installed on height adjustable Softpod or two divider pods with surfaces.

| PRODUCT CODE | PRICE | SIZE/INCHES | | | WEIGHT LBS | VOL FT ³ |
|--------------|-------|-------------|---|----|------------|---------------------|
| | | H | W | D | | |
| HXSCSO | 327 | 21 | 8 | 24 | 20 | 4.22 |

HXSCSOL/R • Under Worksurface Lockable Casual Storage Unit

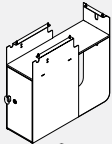

NEW!

- Open storage with shelf, extension at the back provides side compartment.
- Sheet metal construction with PET liner, 24" deep.
- Secured to the bottom of worksurface.
- Choose from standard PET and panel frame finishes.
- Order coat hook HXACHS, attaches to either left or right side of storage unit (sold separately).
- Lockable Cabinet with key - laminate with PVC edge. Please choose any standard laminate and PVC edge.
- Can not be installed on height adjustable Softpod or two divider pods with surfaces.

| PRODUCT CODE | PRICE | SIZE/INCHES | | | WEIGHT LBS | VOL FT ³ |
|--------------|-------|-------------|---|----|------------|---------------------|
| | | H | W | D | | |
| HXSCSOL | 783 | 21 | 8 | 24 | 37 | 4.22 |
| HXCSOR | 783 | 21 | 8 | 24 | 37 | 4.22 |

L2PO • Pantry Storage

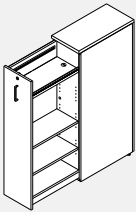

Left Hand Shown

- The pull out cabinet serves as a multifunction, customizable storage unit that both defines space and enhances privacy in an open plan environment.
- Can be used in conjunction with Licence, Bridges, FreeFit and Boulevard.
- Internal organization consists of two fixed shelves top and bottom. The two middle shelves are adjustable. Two accessory rails are standard and will accept GC metal accessories
- Interior cabinet shelves and back are standard in Designer White. Cabinet shell, drawer and top can be specified in any standard laminate.
- L2PO12-NL/R does not fit binders.
- Only available with FA handle.

| PRODUCT CODE | PRICE LP | SIZE/INCHES | | | | WEIGHT LBS | VOL FT ³ | | |
|---------------|----------|-------------|------|---------|------|------------|---------------------|-----|----|
| | | B | W | H(LP/B) | H(W) | | | | |
| L2PO1224H54NL | 1691 | 1709 | 1741 | 53.56 | 54 | 12 | 24 | 138 | 9 |
| L2PO1230H54NL | 1772 | 1792 | 1813 | 53.56 | 54 | 12 | 30 | 153 | 11 |
| L2PO1236H54NL | 1853 | 1878 | 1904 | 53.56 | 54 | 12 | 36 | 167 | 14 |
| L2PO1824H54NL | 1961 | 1986 | 2029 | 53.56 | 54 | 18 | 24 | 166 | 14 |
| L2PO1830H54NL | 2049 | 2081 | 2131 | 53.56 | 54 | 18 | 30 | 182 | 17 |
| L2PO1836H54NL | 2137 | 2173 | 2233 | 53.56 | 54 | 18 | 36 | 197 | 20 |
| L2PO1224H54NR | 1691 | 1709 | 1741 | 53.56 | 54 | 12 | 24 | 138 | 9 |
| L2PO1230H54NR | 1772 | 1792 | 1813 | 53.56 | 54 | 12 | 30 | 153 | 11 |
| L2PO1236H54NR | 1853 | 1878 | 1904 | 53.56 | 54 | 12 | 36 | 167 | 14 |
| L2PO1824H54NR | 1961 | 1986 | 2029 | 53.56 | 54 | 18 | 24 | 166 | 14 |
| L2PO1830H54NR | 2049 | 2081 | 2131 | 53.56 | 54 | 18 | 30 | 182 | 17 |
| L2PO1836H54NR | 2137 | 2173 | 2233 | 53.56 | 54 | 18 | 36 | 197 | 20 |

Finish

While the Pantry Storage cabinet walls, top and pull-out drawer front door and back panel finish can be specified, the internal cabinet back and adjustable shelves are standard white. Please specify the cabinet top and pull-out drawer front finish.

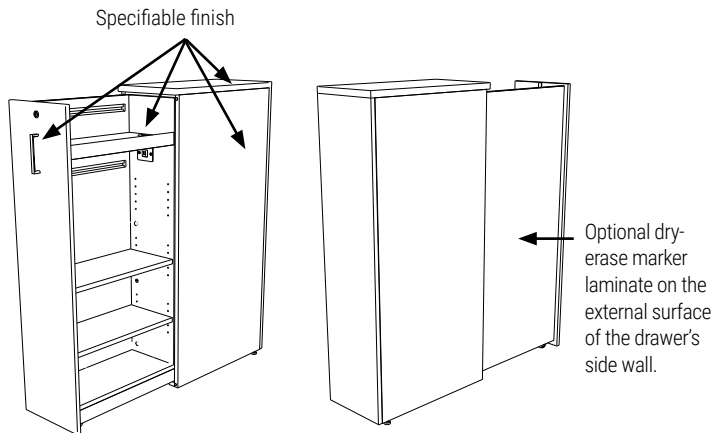

Options

- Dual USB A+C outlet kit - please add "USB" at the end of the code. Add \$388 to the list price
- When you specify dual USB outlet the top shelf will come with grey PET Felt surface and grommet which allows for cable passage from the USB outlet (located below the top shelf). A two-prong power cord exits the cabinet through the floor at the back.
- Dry-erase marker board - Choose "DE" option. Please add \$372 to the list price. If specified the Dry-erase marker laminate will be applied to the external surface of the pull-out drawer side wall.

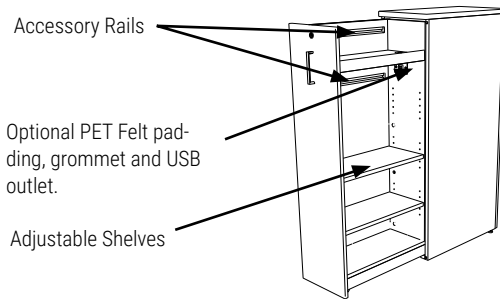

Integrated Accessory rails

Two accessory rails (each 18.25" long) are provided to further enhance customization with Global Contract metal accessories.

Upper Accessory Rail:

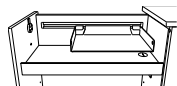

1x BALTO1 or BALTO1GL Letter Ttray

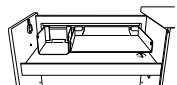

1x BALTO1 Letter Ttray
1x BAMBO1 Media Bin

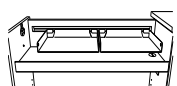

2x BAUTO1 Utility Ttray

Lower Accessory Rail:

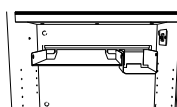

1x BALTO1 Letter Ttray
1x BAMBO1 Media Bin

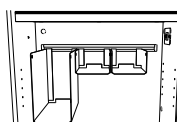

3x BABBO1 Media Bin or 3x BAMBO1 Binder Bin

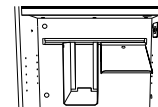

1x BATHO1 Telephone Holder
1x BABBO1 Binder Bin

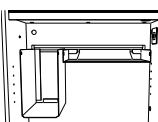

1x BALTO1 Letter Ttray
1x BABBO1 Binder Bin

L2PW • Wardrobe Pantry Storage

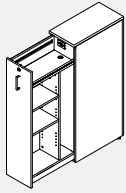

Left Hand Shown

- The pull out cabinet serves as a multifunction, customizable storage unit that both defines space and enhances privacy in an open plan environment.
- Can be used in conjunction with Licence,, FreeFit and Boulevard.
- Internal organization consists of one fixed shelf at the top. The two middle shelves are adjustable. Wardrobe includes coat hook.
- Interior cabinet shelves and back are standard in Designer White. Cabinet shell, drawer and top can be specified in any standard laminate.
- L2PW12-NL/R does not fit binders.
- Only available with FA handle.

Finish

While the Pantry Storage cabinet walls, top and pull-out drawer front door and back panel finish can be specified, the internal cabinet back and adjustable shelves are standard white. Please specify the cabinet top and pull-out drawer front finish.

Options

- Dual USB A+C outlet kit - please add "USB" at the end of the code. Add \$388 to the list price
- When you specify dual USB outlet the top shelf will come with grey felt surface and grommet which allows for cable passage from the USB outlet (located below the top shelf). A two-prong power cord exits the cabinet through the floor at the back.
- Dry-erase marker board - Choose "DE" option. Please add \$372 to the list price. If specified the Dry-erase marker laminate will be applied to the external surface of the pull-out drawer side wall.

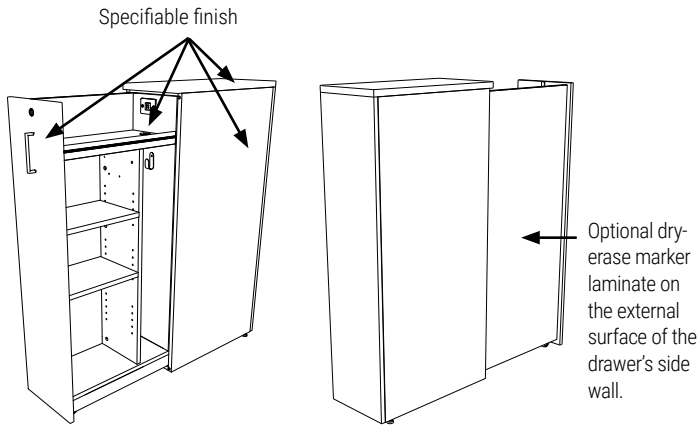

| PRODUCT CODE | PRICE LP | SIZE/INCHES | | | | WEIGHT LBS | VOL FT ³ | | |
|---------------|----------|-------------|------|---------|------|------------|---------------------|-----|----|
| | | B | W | H(LP/B) | H(W) | | | | |
| L2PW1224H42NL | 1680 | 1698 | 1735 | 41.56 | 42 | 12 | 24 | 128 | 7 |
| L2PW1230H42NL | 1757 | 1780 | 1822 | 41.56 | 42 | 12 | 30 | 143 | 9 |
| L2PW1236H42NL | 1832 | 1860 | 1911 | 41.56 | 42 | 12 | 36 | 157 | 11 |
| L2PW1824H42NL | 1946 | 1975 | 2022 | 41.56 | 42 | 18 | 24 | 156 | 11 |
| L2PW1830H42NL | 2031 | 2066 | 2124 | 41.56 | 42 | 18 | 30 | 172 | 13 |
| L2PW1836H42NL | 2116 | 2158 | 2225 | 41.56 | 42 | 18 | 36 | 187 | 16 |
| L2PW1224NL | 1831 | 1848 | 1880 | 49.56 | 50 | 12 | 24 | 133 | 8 |
| L2PW1230NL | 1912 | 1945 | 1971 | 49.56 | 50 | 12 | 30 | 148 | 10 |
| L2PW1236NL | 1993 | 2040 | 2064 | 49.56 | 50 | 12 | 36 | 162 | 15 |
| L2PW1824NL | 2140 | 2173 | 2207 | 49.56 | 50 | 18 | 24 | 161 | 12 |
| L2PW1830NL | 2227 | 2281 | 2310 | 49.56 | 50 | 18 | 30 | 177 | 15 |
| L2PW1836NL | 2315 | 2388 | 2412 | 49.56 | 50 | 18 | 36 | 192 | 18 |
| L2PW1224H54NL | 1866 | 1884 | 1916 | 53.56 | 54 | 12 | 24 | 138 | 9 |
| L2PW1230H54NL | 1947 | 1967 | 1988 | 53.56 | 54 | 12 | 30 | 153 | 11 |
| L2PW1236H54NL | 2028 | 2053 | 2080 | 53.56 | 54 | 12 | 36 | 167 | 14 |
| L2PW1824H54NL | 2182 | 2206 | 2250 | 53.56 | 54 | 18 | 24 | 166 | 14 |
| L2PW1830H54NL | 2269 | 2301 | 2351 | 53.56 | 54 | 18 | 30 | 182 | 17 |
| L2PW1836H54NL | 2358 | 2394 | 2453 | 53.56 | 54 | 18 | 36 | 197 | 20 |
| L2PW1224H42NR | 1680 | 1698 | 1735 | 41.56 | 42 | 12 | 24 | 128 | 7 |
| L2PW1230H42NR | 1757 | 1780 | 1822 | 41.56 | 42 | 12 | 30 | 143 | 9 |
| L2PW1236H42NR | 1832 | 1860 | 1911 | 41.56 | 42 | 12 | 36 | 157 | 11 |
| L2PW1824H42NR | 1946 | 1975 | 2022 | 41.56 | 42 | 18 | 24 | 156 | 11 |
| L2PW1830H42NR | 2031 | 2066 | 2124 | 41.56 | 42 | 18 | 30 | 172 | 13 |
| L2PW1836H42NR | 2116 | 2158 | 2225 | 41.56 | 42 | 18 | 36 | 187 | 16 |
| L2PW1224NR | 1831 | 1848 | 1880 | 49.56 | 50 | 12 | 24 | 133 | 8 |
| L2PW1230NR | 1912 | 1945 | 1971 | 49.56 | 50 | 12 | 30 | 148 | 10 |
| L2PW1236NR | 1993 | 2040 | 2064 | 49.56 | 50 | 12 | 36 | 162 | 15 |
| L2PW1824NR | 2140 | 2173 | 2207 | 49.56 | 50 | 18 | 24 | 161 | 12 |
| L2PW1830NR | 2227 | 2281 | 2310 | 49.56 | 50 | 18 | 30 | 177 | 15 |
| L2PW1836NR | 2315 | 2388 | 2412 | 49.56 | 50 | 18 | 36 | 192 | 18 |
| L2PW1224H54NR | 1866 | 1884 | 1916 | 53.56 | 54 | 12 | 24 | 138 | 9 |
| L2PW1230H54NR | 1947 | 1967 | 1988 | 53.56 | 54 | 12 | 30 | 153 | 11 |
| L2PW1236H54NR | 2028 | 2053 | 2080 | 53.56 | 54 | 12 | 36 | 167 | 14 |
| L2PW1824H54NR | 2182 | 2206 | 2250 | 53.56 | 54 | 18 | 24 | 166 | 14 |
| L2PW1830H54NR | 2269 | 2301 | 2351 | 53.56 | 54 | 18 | 30 | 182 | 17 |
| L2PW1836H54NR | 2358 | 2394 | 2453 | 53.56 | 54 | 18 | 36 | 197 | 20 |

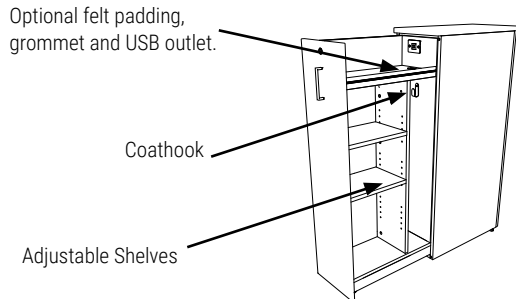

L2PSB • Pantry Felt Storage Bin

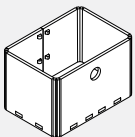

- Crafted from recycled PET felt, felt bins are an intuitive and versatile organization solution within your Pantry unit.
- Felt is 9mm, please choose from our 18 difference finishes.

| PRODUCT CODE | PRICE | H | W | D | WEIGHT LBS | VOL FT ³ |
|--------------|-------|---|---|---|------------|---------------------|
| | | | | | | |

L2PST • Pantry Felt Storage Tray

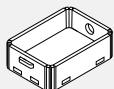

- Crafted from recycled PET felt, felt bins are an intuitive and versatile organization solution within your Pantry unit.
- Felt is 9mm, please choose from our 18 difference finishes.

| PRODUCT CODE | PRICE | H | W | D | WEIGHT LBS | VOL FT ³ |
|--------------|-------|---|---|---|------------|---------------------|
| | | | | | | |

BLVELEDVS • LED Single Arm Lamp

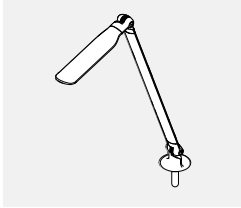

- **7 System watts, 18-fractional LEDs.**
- 3500K 250 lumens, 84 CRI.
- Soft touch - instant on, fade to off.
- Infinite dimming 100% down to 15%, last state memory.
- Standard 10 hours turn off (ATO).
- 50,000 hour life LEDs.
- 15 watt, 24 volt wall transformer, 6' cord.
- White (WHT) Silver (SIL) or Black (BLK) - Must specify colour choice.
- UL, CUL and CSA compliant, ETL Listed.
- Base not included.

| PRODUCT CODE | PRICE | SIZE/ H | INCHES W | D | WEIGHT LBS | VOL FT ³ |
|------------------------------|-------|---------|----------|---|------------|---------------------|
| BLVELEDVS | 616 | | | | 3 | 0.93 |
| With Occupancy Sensor | | | | | | |
| BLVELEDVSO | 920 | | | | 3 | 0.93 |

BLVELEDVD • LED Double Arm Lamp

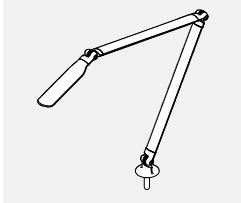

- **7 System watts, 18-fractional LEDs.**
- 3500K 250 lumens, 84 CRI.
- Double arm articulation with 20" base to head reaches.
- Soft touch - instant on, fade to off.
- Infinite dimming 100% down to 15%, last state memory.
- Standard 10 hours turn off (ATO).
- 50,000 hour life LEDs.
- 15 watt, 24 volt wall transformer, 6' cord.
- White (WHT) Silver (SIL) or Black (BLK) - Must specify colour choice.
- UL, CUL and CSA compliant, ETL Listed.
- Base not included.

| PRODUCT CODE | PRICE | SIZE/ H | INCHES W | D | WEIGHT LBS | VOL FT ³ |
|------------------------------|-------|---------|----------|---|------------|---------------------|
| BLVELEDVD | 646 | | | | 3 | 0.93 |
| With Occupancy Sensor | | | | | | |
| BLVELEDVDO | 931 | | | | 3 | 0.93 |

BLVELEDRS • LED Single Arm Lamp

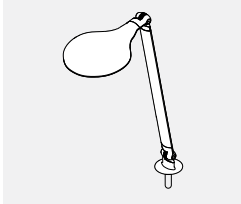

- **7 System watts, 18-fractional LEDs.**
- 3500K 250 lumens, 84 CRI.
- Soft touch - instant on, fade to off.
- Infinite dimming 100% down to 15%, last state memory.
- Standard 10 hours turn off (ATO).
- 50,000 hour life LEDs.
- 15 watt, 24 volt wall transformer, 6' cord.
- White (WHT) Silver (SIL) or Black (BLK) - Must specify colour choice.
- UL, CUL and CSA compliant, ETL Listed.
- Base not included.

| PRODUCT CODE | PRICE | SIZE/ H | INCHES W | D | WEIGHT LBS | VOL FT ³ |
|------------------------------|-------|---------|----------|---|------------|---------------------|
| BLVELEDRS | 616 | | | | 3 | 0.93 |
| With Occupancy Sensor | | | | | | |
| BLVELEDRSO | 920 | | | | 3 | 0.93 |

BLVELEDRD • LED Double Arm Lamp

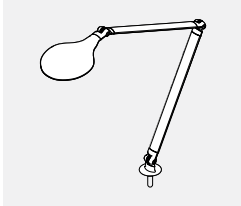

- **7 System watts, 18-fractional LEDs.**
- 3500K 250 lumens, 84 CRI.
- Double arm articulation with 20" base to head reaches.
- Soft touch - instant on, fade to off.
- Infinite dimming 100% down to 15%, last state memory.
- Standard 10 hours turn off (ATO).
- 50,000 hour life LEDs.
- 15 watt, 24 volt wall transformer, 6' cord.
- White (WHT) Silver (SIL) or Black (BLK) - Must specify colour choice.
- UL, CUL and CSA compliant, ETL Listed.
- Base not included.

| PRODUCT CODE | PRICE | SIZE/ H | INCHES W | D | WEIGHT LBS | VOL FT ³ |
|------------------------------|-------|---------|----------|---|------------|---------------------|
| BLVELEDRD | 633 | | | | 3 | 0.93 |
| With Occupancy Sensor | | | | | | |
| BLVELEDRDO | 931 | | | | 3 | 0.93 |

Lamp Mounting Options

- White (WHT) Silver (SIL) or Black (BLK) - Must specify colour choice.



| Worksurface Clamp Mount | | | | | | |
|--------------------------------|-------|---------|----------|---|------------|---------------------|
| PRODUCT CODE | PRICE | SIZE/ H | INCHES W | D | WEIGHT LBS | VOL FT ³ |
| BLVELEDASCM | 155 | | | | 1 | 0.05 |

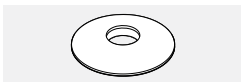

| Freestanding Base | | | | | | |
|--------------------------|-------|---------|----------|---|------------|---------------------|
| PRODUCT CODE | PRICE | SIZE/ H | INCHES W | D | WEIGHT LBS | VOL FT ³ |
| BLVELEDAFS | 173 | | | | 3 | 0.5 |

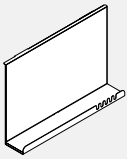
HXAHS • Hanging Shelf

- Hanging Shelf for personal item storage.
- Suspended from the divider's top reveal.
- Installed board measures 16" from top; 9" from top of worksurface.
- Painted metal, choose from standard panel frame finishes.
- Choose a PET Felt finish for the tray insert.
- Must be located away from the stiffeners on freestanding pods.

| PRODUCT CODE | PRICE | PRICE | | | WEIGHT | | VOL | |
|-----------------|-------|-------|------|---|--------|-----------------|-----|--|
| | | H | W | D | LBS | FT ³ | | |
| HXAHS | 104 | 16 | 23.5 | 3 | 8.8 | 1.91 | | |

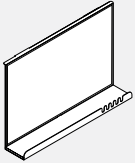
HXAHSWB • Hanging Shelf with Dry Erase Board

- Hanging shelf with, dry-erase marker surface.
- Suspended from the divider's top reveal.
- Installed board measures 16" from top; 9" from top of worksurface.
- White surface, painted metal frame; choose from standard panel frame finishes.
- Choose a PET Felt finish for the tray insert.
- Must be located away from the stiffeners on freestanding pods.

| PRODUCT CODE | PRICE | PRICE | | | WEIGHT | | VOL | |
|-----------------|-------|-------|------|---|--------|-----------------|-----|--|
| | | H | W | D | LBS | FT ³ | | |
| HXAHSWB | 398 | 16 | 23.5 | 3 | 9.57 | 1.91 | | |

HXARWS • Rear Wall Shelf

- Rear wall laminate shelf.
- Made of 3/4" LP- low pressure or HP - high pressure; non-handed, with pre-determined mounting points.
- 2.5" front radii.
- Choose from standard laminate finishes, PVC edge.
- NOTE: Not compatible with Ceiling Feed Pole or any monitor mounts.

| PRODUCT CODE | PRICE | | PRICE | | | WEIGHT | | VOL | |
|-----------------|-------|-----|-------|-------|-----|--------|-----------------|-----|--|
| | LP | HP | H | W | D | LBS | FT ³ | | |
| HXARWS | 106 | 135 | 0.75 | 32.25 | 4.5 | 2.80 | 1.13 | | |

HXACHS • Coat/Bag Hook for Dividers

- Coat/Bag Hook can be installed anywhere along the divider perimeter reveal or either side of the Under Surface Casual Storage Unit.
- Made of die-cast aluminum, specify any standard metal paint finish.
- Choose a PET Felt finish for the plug insert.

| PRODUCT CODE | PRICE | PRICE | | | WEIGHT | | VOL | |
|-----------------|-------|-------|------|------|--------|-----------------|-----|--|
| | | H | W | D | LBS | FT ³ | | |
| HXACHS | 30 | 2 | 1.25 | 0.75 | 0.05 | 0.01 | | |

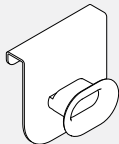
HXACHT • Coat/Bag Hook for Dividers Edge

- Coat/Bag Hook can be installed anywhere along the divider perimeter reveal or either or both sides of any divider.
- Made of die-cast aluminum with steel brackets, specify any standard metal paint finish.
- Choose a PET Felt finish for the plug insert.
- Must be located away from the stiffeners on freestanding pods.

| PRODUCT CODE | PRICE | PRICE | | | WEIGHT | | VOL | |
|-----------------|-------|-------|------|------|--------|-----------------|-----|--|
| | | H | W | D | LBS | FT ³ | | |
| HXACHT | 35 | 2 | 1.25 | 0.75 | 0.23 | 0.01 | | |

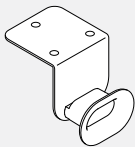
HXABH • Under Surface Bag Hook

- Under Surface Bag Hook can be secured to the bottom of worksurface.
- Made of die-cast aluminum with steel brackets, specify any standard metal paint finish.
- Choose a PET Felt finish for the plug insert.

| PRODUCT CODE | PRICE | PRICE | | | WEIGHT | | VOL | |
|-----------------|-------|-------|------|------|--------|-----------------|-----|--|
| | | H | W | D | LBS | FT ³ | | |
| HXABH | 33 | 2 | 1.25 | 0.75 | 0.18 | 0.01 | | |

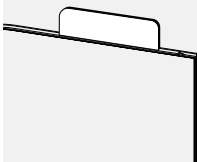
HXNP • Name Plate

- Name Plate sits inside the divider top reveal.
- Two-sided white dry erase surface laminated to 1/2" PET Felt.

| PRODUCT CODE | PRICE | PRICE | | | WEIGHT | | VOL | |
|-----------------|-------|-------|-------|-----|--------|-----------------|-----|--|
| | | H | W | D | LBS | FT ³ | | |
| HXNP | 60 | 3.625 | 10.75 | 0.5 | | 0.01 | | |

GCPPVACH • Universal Polypropylene Divider Panels - H Configuration

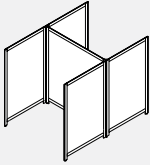

- **Universal Polypropylene Divider Panels dividing space with flexibility.**
- Lightweight and easy to clean partitions.
- Minimal footprint for storage.
- Fluted solid white polypropylene screens surrounded by a 1/2" by 2/5" powder coated aluminum frame in DWT - Designer White or TUN - Tungsten
- Charcoal soft touch radius end trim.
- 7" panel opening at panel bottom for easy cleaning and cable pass-thru.
- Includes all connecting hardware and 1" levelling glide.
- Stations are 60" wide by 42" deep by 66" high.
- Planning stations are preconfigured in a back-to-back H with ability to add stations with a T configuration.

| PRODUCT CODE | PRICE | SIZE/INCHES | | | WEIGHT LBS | VOL FT ³ |
|----------------|-------|-------------|----|----|------------|---------------------|
| | | H | W | D | | |
| GCPPVACH666085 | 1945 | 66 | 60 | 85 | 90 | 18.74 |

GCPPVACT • Universal Polypropylene Divider Panels - T Configuration

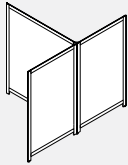

- **Universal Polypropylene Divider Panels dividing space with flexibility.**
- Lightweight and easy to clean partitions.
- Minimal footprint for storage.
- Fluted solid white polypropylene screens surrounded by a 1/2" by 2/5" powder coated aluminum frame in DWT - Designer White or TUN - Tungsten
- Charcoal soft touch radius end trim.
- 7" panel opening at panel bottom for easy cleaning and cable pass-thru.
- Includes all connecting hardware and 1" levelling glide.
- Stations are 60" wide by 42" deep by 66" high.
- Planning stations are preconfigured in a back-to-back H with ability to add stations with a T configuration.

| PRODUCT CODE | PRICE | SIZE/INCHES | | | WEIGHT LBS | VOL FT ³ |
|----------------|-------|-------------|----|----|------------|---------------------|
| | | H | W | D | | |
| GCPPVACT666085 | 1238 | 66 | 60 | 85 | 73 | 11.82 |

GCPPVACU • Universal Polypropylene Divider Panels - U Configuration

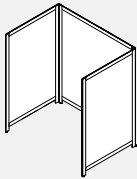

- **Universal Polypropylene Divider Panels dividing space with flexibility.**
- Lightweight and easy to clean partitions.
- Minimal footprint for storage.
- Fluted solid white polypropylene screens surrounded by a 1/2" by 2/5" powder coated aluminum frame in DWT - Designer White or TUN - Tungsten
- Charcoal soft touch radius end trim.
- 7" panel opening at panel bottom for easy cleaning and cable pass-thru.
- Includes all connecting hardware and 1" levelling glide.
- Stations are 60" wide by 42" deep by 66" high.
- Planning stations are preconfigured in a back-to-back U with ability to add stations with an L configuration.

| PRODUCT CODE | PRICE | SIZE/INCHES | | | WEIGHT LBS | VOL FT ³ |
|----------------|-------|-------------|----|----|------------|---------------------|
| | | H | W | D | | |
| GCPPVACU666043 | 1241 | 66 | 60 | 43 | 73 | 11.82 |

GCPPVACL • Universal Polypropylene Divider Panels - L Configuration

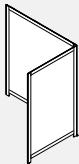

- **Universal Polypropylene Divider Panels dividing space with flexibility.**
- Lightweight and easy to clean partitions.
- Minimal footprint for storage.
- Fluted solid white polypropylene screens surrounded by a 1/2" by 2/5" powder coated aluminum frame in DWT - Designer White or TUN - Tungsten
- Charcoal soft touch radius end trim.
- 7" panel opening at panel bottom for easy cleaning and cable pass-thru.
- Includes all connecting hardware and 1" levelling glide.
- Stations are 60" wide by 42" deep by 66" high.
- Planning stations are preconfigured in a back-to-back U with ability to add stations with an L configuration.

| PRODUCT CODE | PRICE | SIZE/INCHES | | | WEIGHT LBS | VOL FT ³ |
|----------------|-------|-------------|----|----|------------|---------------------|
| | | H | W | D | | |
| GCPPVACL666043 | 885 | 66 | 60 | 43 | 58 | 8.36 |

GCUPFSP • Freestanding Divider Polycarbonate Screen With Flat Feet

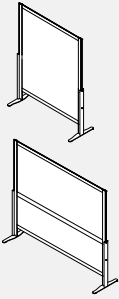

- Provides privacy and room separation.
- Lightweight and easy to clean and move.
- Consists of a powder coated aluminum frame, translucent fluted polycarbonate and steel flat feet.
- Option for 54", 60 and 72" high.
- 72" high by 60" wide divider has a crossbar in the middle.
- Please choose any standard paint finish for frame and feet.

| PRODUCT CODE | PRICE | SIZE/INCHES | | | WEIGHT LBS | VOL FT ³ |
|--------------|-------|-------------|----|----|------------|---------------------|
| | | H | W | D | | |
| GCUPFSP5424 | 485 | 51.75 | 24 | 20 | 15.96 | 14.38 |
| GCUPFSP5430 | 534 | 51.75 | 30 | 20 | 17.96 | 17.97 |
| GCUPFSP5436 | 577 | 51.75 | 36 | 20 | 19.96 | 21.56 |
| GCUPFSP5442 | 625 | 51.75 | 42 | 20 | 21.96 | 25.16 |
| GCUPFSP5448 | 632 | 51.75 | 48 | 20 | 20.96 | 28.75 |
| GCUPFSP5460 | 763 | 51.75 | 60 | 20 | 22.96 | 35.94 |
| GCUPFSP6024 | 496 | 57.75 | 24 | 20 | 17.96 | 16.04 |
| GCUPFSP6030 | 543 | 57.75 | 30 | 20 | 19.96 | 20.05 |
| GCUPFSP6036 | 587 | 57.75 | 36 | 20 | 21.96 | 24.06 |
| GCUPFSP6042 | 634 | 57.75 | 42 | 20 | 23.96 | 28.07 |
| GCUPFSP6048 | 644 | 57.75 | 48 | 20 | 25.96 | 32.08 |
| GCUPFSP6060 | 775 | 57.75 | 60 | 20 | 27.96 | 40.10 |
| GCUPFSP7230 | 626 | 69.75 | 30 | 20 | 21.96 | 24.22 |
| GCUPFSP7236 | 683 | 69.75 | 36 | 20 | 23.96 | 29.06 |
| GCUPFSP7242 | 759 | 69.75 | 42 | 20 | 25.96 | 33.91 |
| GCUPFSP7248 | 766 | 69.75 | 48 | 20 | 27.96 | 38.75 |
| GCUPFSP7260 | 884 | 69.75 | 60 | 20 | 29.96 | 48.44 |

GCUPMSP • Freestanding Divider Polycarbonate Screen With Casters

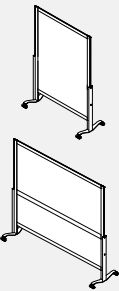

- Provides privacy and room separation.
- Lightweight and easy to clean and move.
- Consists of a powder coated aluminum frame, translucent fluted polycarbonate and steel feet with casters.
- Option for 54", 60 and 72" high.
- 72" high by 60" wide divider has a crossbar in the middle.
- Please choose any standard paint finish for frame and feet.

| PRODUCT CODE | PRICE | SIZE/INCHES | | | WEIGHT LBS | VOL FT ³ |
|--------------|-------|-------------|----|----|------------|---------------------|
| | | H | W | D | | |
| GCUPMSP5424 | 718 | 52.05 | 24 | 20 | 17.13 | 14.46 |
| GCUPMSP5430 | 766 | 52.05 | 30 | 20 | 19.13 | 18.07 |
| GCUPMSP5436 | 748 | 52.05 | 36 | 20 | 21.13 | 21.69 |
| GCUPMSP5442 | 794 | 52.05 | 42 | 20 | 23.13 | 25.30 |
| GCUPMSP5448 | 801 | 52.05 | 48 | 20 | 22.13 | 28.92 |
| GCUPMSP5460 | 922 | 52.05 | 60 | 20 | 24.13 | 36.15 |
| GCUPMSP6024 | 675 | 58.05 | 24 | 20 | 19.13 | 16.13 |
| GCUPMSP6030 | 718 | 58.05 | 30 | 20 | 21.13 | 20.16 |
| GCUPMSP6036 | 759 | 58.05 | 36 | 20 | 23.13 | 24.19 |
| GCUPMSP6042 | 803 | 58.05 | 42 | 20 | 25.13 | 28.22 |
| GCUPMSP6048 | 812 | 58.05 | 48 | 20 | 27.13 | 32.25 |
| GCUPMSP6060 | 932 | 58.05 | 60 | 20 | 29.13 | 40.31 |
| GCUPMSP7230 | 918 | 70.05 | 30 | 20 | 23.13 | 24.32 |
| GCUPMSP7236 | 858 | 70.05 | 36 | 20 | 25.13 | 29.19 |
| GCUPMSP7242 | 917 | 70.05 | 42 | 20 | 27.13 | 34.05 |
| GCUPMSP7248 | 925 | 70.05 | 48 | 20 | 29.13 | 38.92 |
| GCUPMSP7260 | 1033 | 70.05 | 60 | 20 | 31.13 | 48.65 |

GCUPSHS • Shared Divider Polycarbonate Screen

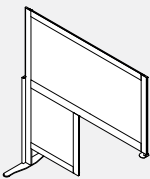

- Provides privacy and divides space for workstations.
- Divider stands on the floor and sits on the worksurface.
- Has no mechanical connection to any surface.
- Lightweight and easy to clean and move.
- Consists of a powder coated aluminum frame, translucent fluted polycarbonate and steel flat foot.
- Option for 54" and 60" high.
- Extends 24" from the worksurface.
- Sits 24" or 30" above worksurface.
- Please choose any standard paint finish for frame and feet.

| PRODUCT CODE | PRICE | SIZE/INCHES | | | WEIGHT LBS | VOL FT ³ |
|--------------|-------|-------------|----|----|------------|---------------------|
| | | H | W | D | | |
| GCUPSHS5448 | 499 | 53.57 | 48 | 20 | 13.45 | 29.76 |
| GCUPSHS5454 | 521 | 53.57 | 54 | 20 | 15.45 | 33.48 |
| GCUPSHS6048 | 541 | 59.57 | 48 | 20 | 17.45 | 33.09 |
| GCUPSHS6054 | 568 | 59.57 | 54 | 20 | 19.45 | 37.23 |

GCUPFSF • Freestanding Divider Felt Screen With Flat Feet

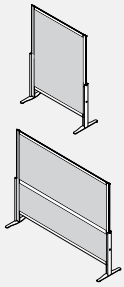

- Provides privacy and room separation.
- Lightweight and easy to clean and move.
- Consists of a powder coated aluminum frame, felt and steel flat feet.
- Option for 54", 60 and 72" high.
- 72" high by 60" wide divider has a crossbar in the middle.
- Please choose any standard paint finish for frame and feet.

| PRODUCT CODE | PRICE | SIZE/INCHES | | | WEIGHT LBS | VOL FT ³ |
|--------------|-------|-------------|----|----|------------|---------------------|
| | | H | W | D | | |
| GCUPFSF5424 | 435 | 51.75 | 24 | 20 | 19.58 | 14.38 |
| GCUPFSF5430 | 459 | 51.75 | 30 | 20 | 20.32 | 17.97 |
| GCUPFSF5436 | 468 | 51.75 | 36 | 20 | 21.06 | 21.56 |
| GCUPFSF5442 | 491 | 51.75 | 42 | 20 | 21.8 | 25.16 |
| GCUPFSF5448 | 500 | 51.75 | 48 | 20 | 22.54 | 28.75 |
| GCUPFSF5460 | 614 | 51.75 | 60 | 20 | 24.03 | 35.94 |
| GCUPFSF6024 | 444 | 57.75 | 24 | 20 | 20.38 | 16.04 |
| GCUPFSF6030 | 471 | 57.75 | 30 | 20 | 21.11 | 20.05 |
| GCUPFSF6036 | 478 | 57.75 | 36 | 20 | 21.84 | 24.06 |
| GCUPFSF6042 | 507 | 57.75 | 42 | 20 | 22.57 | 28.07 |
| GCUPFSF6048 | 510 | 57.75 | 48 | 20 | 23.3 | 32.08 |
| GCUPFSF6060 | 623 | 57.75 | 60 | 20 | 24.87 | 40.10 |
| GCUPFSF7230 | 522 | 69.75 | 30 | 20 | 22.42 | 24.22 |
| GCUPFSF7236 | 530 | 69.75 | 36 | 20 | 23.24 | 29.06 |
| GCUPFSF7242 | 621 | 69.75 | 42 | 20 | 24.06 | 33.91 |
| GCUPFSF7248 | 629 | 69.75 | 48 | 20 | 24.88 | 38.75 |
| GCUPFSF7260 | 785 | 69.75 | 60 | 20 | 29.79 | 48.44 |

GCUPMSF • Freestanding Felt Divider Screen With Casters

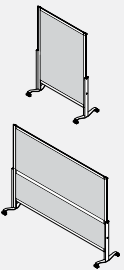

- Provides privacy and room separation.
- Lightweight and easy to clean and move.
- Consists of a powder coated aluminum frame, felt and steel feet with casters.
- Option for 54", 60 and 72" high.
- 72" high by 60" wide divider has a crossbar in the middle.
- Please choose any standard paint finish for frame and feet.

| PRODUCT CODE | PRICE | SIZE/INCHES | | | WEIGHT LBS | VOL FT ³ |
|--------------|-------|-------------|----|----|------------|---------------------|
| | | H | W | D | | |
| GCUPMSF5424 | 618 | 52.05 | 24 | 20 | 20.76 | 14.46 |
| GCUPMSF5430 | 641 | 52.05 | 30 | 20 | 21.5 | 18.07 |
| GCUPMSF5436 | 648 | 52.05 | 36 | 20 | 22.24 | 21.69 |
| GCUPMSF5442 | 671 | 52.05 | 42 | 20 | 22.98 | 25.30 |
| GCUPMSF5448 | 678 | 52.05 | 48 | 20 | 23.72 | 28.92 |
| GCUPMSF5460 | 784 | 52.05 | 60 | 20 | 25.21 | 36.15 |
| GCUPMSF6024 | 627 | 58.05 | 24 | 20 | 21.47 | 16.13 |
| GCUPMSF6030 | 650 | 58.05 | 30 | 20 | 22.23 | 20.16 |
| GCUPMSF6036 | 657 | 58.05 | 36 | 20 | 22.99 | 24.19 |
| GCUPMSF6042 | 680 | 58.05 | 42 | 20 | 23.75 | 28.22 |
| GCUPMSF6048 | 688 | 58.05 | 48 | 20 | 24.51 | 32.25 |
| GCUPMSF6060 | 792 | 58.05 | 60 | 20 | 26.05 | 40.31 |
| GCUPMSF7230 | 699 | 70.05 | 30 | 20 | 23.6 | 24.32 |
| GCUPMSF7236 | 709 | 70.05 | 36 | 20 | 24.42 | 29.19 |
| GCUPMSF7242 | 790 | 70.05 | 42 | 20 | 25.24 | 34.05 |
| GCUPMSF7248 | 797 | 70.05 | 48 | 20 | 26.06 | 38.92 |
| GCUPMSF7260 | 942 | 70.05 | 60 | 20 | 30.97 | 48.65 |

GCUPSHF • Shared Divider Felt Screen

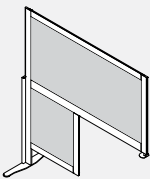

- Provides privacy and divides space for workstations.
- Divider stands on the floor and sits on the worksurface.
- Has no mechanical connection to any surface.
- Lightweight and easy to clean and move.
- Consists of a powder coated aluminum frame, translucent fluted polycarbonate and steel flat foot.
- Option for 54" and 60" high.
- Extends 24" from the worksurface.
- Sits 24" or 30" above worksurface.
- Please choose any standard paint finish for frame and feet.

| PRODUCT CODE | PRICE | SIZE/INCHES | | | WEIGHT LBS | VOL FT ³ |
|--------------|-------|-------------|----|----|------------|---------------------|
| | | H | W | D | | |
| GCUPSHF5448 | 411 | 53.57 | 48 | 20 | 18.06 | 29.76 |
| GCUPSHF5454 | 469 | 53.57 | 54 | 20 | 18.8 | 33.48 |
| GCUPSHF6048 | 438 | 59.57 | 48 | 20 | 18.84 | 33.09 |
| GCUPSHF6054 | 578 | 59.57 | 54 | 20 | 19.6 | 37.23 |

GCUPFSG • Freestanding Divider Glass Screen with Flat Feet

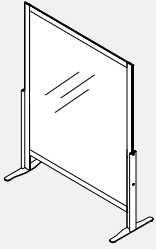

- Provides privacy and room separation.
- Lightweight and easy to clean and move.
- Consists of an aluminum frame, clear glass screen and steel flat feet.
- Please choose any standard panel frame paint finish from Global Contract for all metal parts.
- Option for 54" / 60" high.
- Upcharge for frosted (FRST) glass is 20%.

| PRODUCT CODE | PRICE | SIZE/INCHES | | | WEIGHT LBS | VOL FT ³ |
|--------------|-------|-------------|----|----|------------|---------------------|
| | | H | W | D | | |
| GCUPFSG5424 | 570 | 51.75 | 24 | 20 | 30.83 | 14.38 |
| GCUPFSG5430 | 619 | 51.75 | 30 | 20 | 34.95 | 17.97 |
| GCUPFSG5436 | 668 | 51.75 | 36 | 20 | 39.07 | 21.56 |
| GCUPFSG5442 | 717 | 51.75 | 42 | 20 | 43.19 | 25.16 |
| GCUPFSG5448 | 766 | 51.75 | 48 | 20 | 47.31 | 28.75 |
| GCUPFSG5460 | 864 | 51.75 | 60 | 20 | 55.56 | 35.94 |
| GCUPFSG6024 | 604 | 57.75 | 24 | 20 | 33.11 | 16.04 |
| GCUPFSG6030 | 657 | 57.75 | 30 | 20 | 37.74 | 20.05 |
| GCUPFSG6036 | 712 | 57.75 | 36 | 20 | 42.36 | 24.06 |
| GCUPFSG6042 | 765 | 57.75 | 42 | 20 | 46.99 | 28.07 |
| GCUPFSG6048 | 820 | 57.75 | 48 | 20 | 51.61 | 32.08 |
| GCUPFSG6060 | 928 | 57.75 | 60 | 20 | 60.86 | 40.10 |

GCUPMSG • Freestanding Divider Glass Screen with Casters

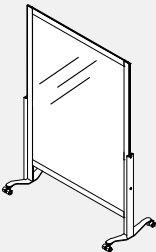

- Provides privacy and room separation.
- Lightweight and easy to clean and move.
- Consists of an aluminum frame, clear glass screen and steel flat feet.
- Please choose any standard panel frame paint finish from Global Contract for all metal parts.
- Option for 54" / 60" high.
- Upcharge for frosted (FRST) glass is 20%.

| PRODUCT CODE | PRICE | SIZE/INCHES | | | WEIGHT LBS | VOL FT ³ |
|--------------|-------|-------------|----|----|------------|---------------------|
| | | H | W | D | | |
| GCUPMSG5424 | 817 | 52.05 | 24 | 20 | 31.99 | 14.46 |
| GCUPMSG5430 | 865 | 52.05 | 30 | 20 | 36.11 | 18.07 |
| GCUPMSG5436 | 915 | 52.05 | 36 | 20 | 40.24 | 21.69 |
| GCUPMSG5442 | 963 | 52.05 | 42 | 20 | 44.36 | 25.30 |
| GCUPMSG5448 | 1012 | 52.05 | 48 | 20 | 48.48 | 28.92 |
| GCUPMSG5460 | 1110 | 52.05 | 60 | 20 | 56.72 | 36.15 |
| GCUPMSG6024 | 850 | 58.05 | 24 | 20 | 34.28 | 16.13 |
| GCUPMSG6030 | 904 | 58.05 | 30 | 20 | 38.9 | 20.16 |
| GCUPMSG6036 | 958 | 58.05 | 36 | 20 | 43.53 | 24.19 |
| GCUPMSG6042 | 1011 | 58.05 | 42 | 20 | 48.15 | 28.22 |
| GCUPMSG6048 | 1065 | 58.05 | 48 | 20 | 52.78 | 32.25 |
| GCUPMSG6060 | 1174 | 58.05 | 60 | 20 | 62.03 | 40.31 |

GCUPSHG • Shared Divider Glass Screen

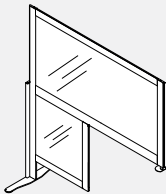

- Provides privacy and divides space for workstations.
- Divider stands on the floor and sits on the worksurface.
- Has no mechanical connection to any surface.
- Lightweight and easy to clean and move.
- Consists of a powder coated aluminum frame, clear glass screen and steel flat foot.
- Option for 54" / 60" high.
- Extends 24" from the worksurface.
- Sits 24" or 30" above worksurface.
- Please choose any standard paint finish for frame and feet.
- Upcharge for frosted (FRST) glass is 20%.

| PRODUCT CODE | PRICE | SIZE/INCHES | | | WEIGHT LBS | VOL FT ³ |
|--------------|-------|-------------|----|----|------------|---------------------|
| | | H | W | D | | |
| GCUPSHG5448 | 629 | 53.57 | 48 | 20 | 36.17 | 29.76 |
| GCUPSHG5454 | 657 | 53.57 | 54 | 20 | 38.51 | 33.48 |
| GCUPSHG6048 | 680 | 59.57 | 48 | 20 | 40.52 | 33.09 |
| GCUPSHG6054 | 714 | 59.57 | 54 | 20 | 43.36 | 37.23 |