

Guideline for Ordering Product

CODES: The price list uses a numbering system with meaningful alphanumeric characters to create a simple-to-understand product number. This makes specifying the product much easier and more accurate.

SPECIFICATION EXAMPLE OF A HEIGHT ADJUSTABLE TABLE

Ordered as components, please order:

1, BASE

PRODUCT CODE:

FT - FreeFit
5 - Standard Range Legs
2 - Leg Quantity
SF - Small Frame
24 - Depth
CL - C-leg Style
S - Standard Controller

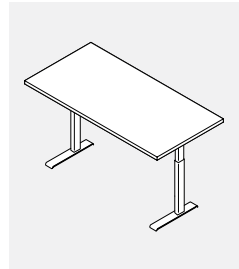

OPTIONS:

Frame Style: 5 - Standard Range Frame 27.5" to 47"
6 - Extended Range Frame 22.5" to 48.5"

Leg Quantity: 1 - 1 Leg for return Kit
2 - 2 Leg table Kit
3 - 3 Leg Table Kit
4 - 4 Leg Table Kit

Frame Size: SF - Small Frame, for 42" to 60" wide Tables
LF - Large Frame, for 66" to 84" wide Tables

Worksurface Depth: 24 - For 23" deep worksurfaces
30 - For 29" and 35" deep worksurfaces

Leg Style: CL - C Shaped Table Leg
TL - T Shaped Table Leg

Controller Style: S - Standard Controller
D - Display Controller

Base Finish: BLK - Black
DWT - Designer White
TUN - Tungsten
The following finishes are available for minimum orders of 72 legs for special projects. For customer who request the finishes below, and do not meet the 72 legs threshold, a 30% surcharge will apply to the base and an extended lead time of 6 weeks.

BZD - Blizzard	SIL - Silver
CHR - Charcoal	FOG - Steel
NEV - Nevada	TPE - Taupe
SDT - Stonedust	

2, TOP

PRODUCT CODE:

FTWR2436

Top: LP = LP (Low Pressure Laminate) Thickness 1"
HP = HP (High Pressure Laminate) Thickness 1 1/16"

Top Finish Laminate: Choose Colour

Top PVC Edging: Choose Colour

3, ACCESSORIES

PRODUCT CODE:

FTAEC12

Base Finish: BLK - Black
DWT - Designer White
TUN - Tungsten
The following finishes are available for minimum orders of 72 legs for special projects. For customer who request the finishes below, and do not meet the 72 legs threshold, a 30% surcharge will apply to the base and an extended lead time of 6 weeks.

BZD - Blizzard	SIL - Silver
CHR - Charcoal	FOG - Steel
NEV - Nevada	TPE - Taupe
SDT - Stonedust	

Height Adjustable Tables • Product Map

C-Leg Base

Standard and Extended Range



90 Degree Retrofit Kit with C-Leg

Standard and Extended Range



Single Frame

Standard and Extended Range

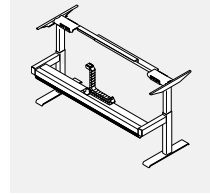

T-Leg Base

Standard and Extended Range

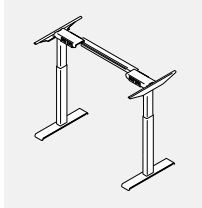

90 Degree Retrofit Kit with T-Leg

Standard and Extended Range



Single End of Run Frame

Standard and Extended Range

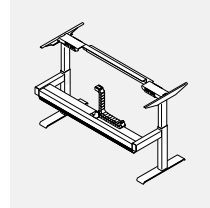

90 Degree Table Base, Equal Sides

Standard and Extended Range

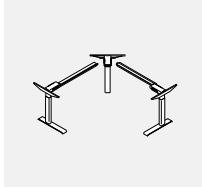

120 Degree Table Base

Standard and Extended Range

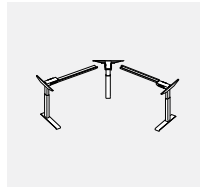

Media Table Frame

Standard and Extended Range

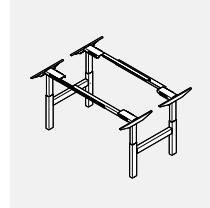

90 Degree Table Base, Unequal Sides

Standard and Extended Range

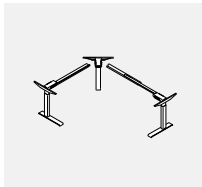

Back to Back Frame

Standard and Extended Range

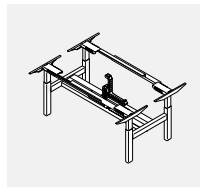

FREEFIT GROMMET LOCATION

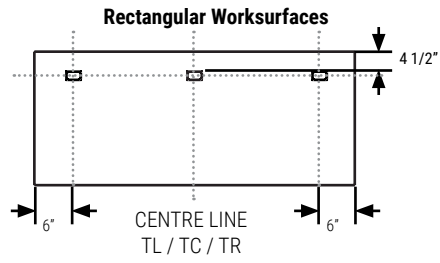
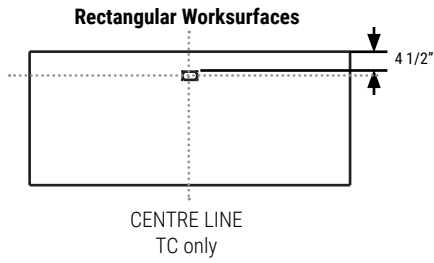

120° Corner Table Top

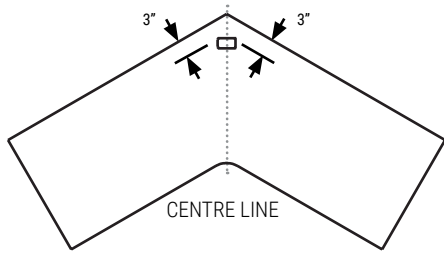

90° Extended Corner Worksurface

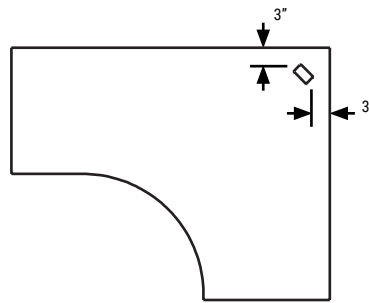

For FTWR worksurfaces 64" and larger, TL/TR, TL/TC and TC/TR are also available.

GAADxx Grommets Rectangular Worksurface TL

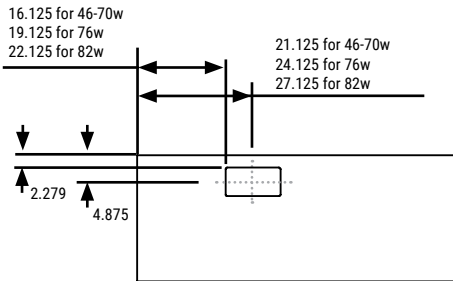

GAADxx Grommets Rectangular Worksurface TR

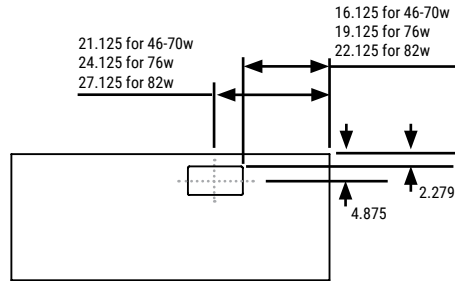

For Back to Back Tables and Freestanding Tables only. Not available for return table tops.

Media Table Tops

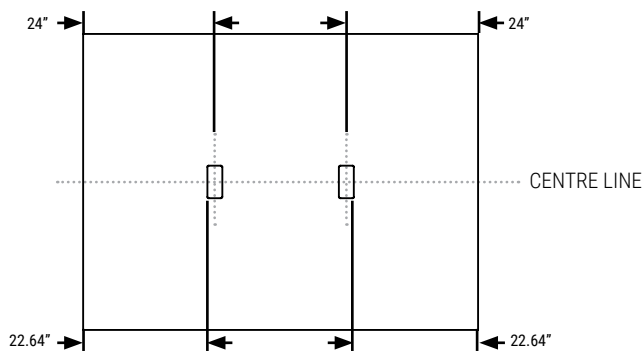

General Specification

FEATURES

- Table frames feature 80 X 50 mm rectangular outer leg with the large tube attached to the foot.
- Open base design with ample room for chair and user's legs.
- Flat foot design includes adjustable (10mm) glides.
- All table frames include expandable width upper crossbars to create a variety of size tables.
- Tables have no lower crossbars.
- All table frames are easy to assemble with few parts.
- Tables are designed so that the paint will never mar on the leg during operation.
- Steel construction of the leg assembly tubing, feet and upper structure assemblies.
- Powder coat finishes for bases standard in (DWT) Designer White, (BLK) Black and (TUN) Tungsten.
- All standard Global Contract laminate finishes are available.
- Sizes of tops are "nominal". Unless otherwise stated, actual depth is 1" less and actual width is 2" less than "nominal" size.
- Additional Finishes available minimum quantity of 72 legs (36 - 2 leg tables, 24 - 3 leg tables or 18 B2B Tables) Blizzard, Charcoal, Nevada, Silver, Steel, Stonedust, and Taupe
- All bases lift 350 lbs on two leg tables.
- All bases operate at 1.5" per second.
- Standard Range Frame adjusts from 27.5" to 47" including the worksurface.
- Extended Range Frame adjusts from 22.5" to 48.5" including the worksurface.
- Tops are warrantied for lifetime and bases are warranted for 7 years.

CERTIFICATIONS

Products are fully compliant with ANSI/BIFMA X5.5 – 2014, CAN/CGSB-44.227 - 2017; EN 60335-1 and UL962

All Global Contract Extended Range tables meet the BIFMA G1-2013 Ergonomic Guideline for "recommended adjustment range".

EXTENDED RANGE COLUMNS

The 3-part construction ensures a short installation dimension combined with a long stroke length making the Extended Range Column the optimum choice no matter the height of the person using it. The middle profile of the column moves synchronously so the profiles are always in the same height optimising the desk design and the stability.

- Compact design where guide and actuator functions are an integrated unit
- Reinforced column and optimised motor housing design for extra strength and stability
- Max. thrust 1200 N per column (12 mm spindle pitch)
- Max. speed 38 mm/s unloaded
- Installation dimension: 560 mm 518 mm (BIFMA)
- Stroke length: 650 mm 665 mm (BIFMA)
- Dimensions column: 50 x 80 mm (outer profile), 43.5 x 73.5 mm (middle profile) and 37 x 67 mm (inner profile)
- Low noise level
- No visible gliding pads

STANDARD RANGE COLUMNS

The 2-part lifting column is a perfect choice for a wide range of different desk applications in the office.

- Compact design where guide and actuator functions are an integrated unit
- Reinforced column and optimised motor housing design for extra strength and stability
- Max. load 800 N per column
- Max. speed: 38 mm/s unloaded
- Standard installation dimension 645 mm
- Standard stroke length 500 mm
- Dimensions column: 50 x 80 mm (outer profile) and 43.5 x 73.5 mm (inner profile)
- Dimension motor housing: 177 x 97 x 46 mm
- Low noise level
- No visible gliding pads

FOOT

Freefit offers two foot styles either a "T" or "C".

The feet are available in two different lengths (560 mm and 710 mm). The foot offers a recessed connection for the column and connects from the bottom with 4 bolts. Adjustable glides are standard

DESK MOUNT FRAME

- Can be specified in two lengths Short Frame (SF) for tables 42" – 60" in length. Long Frames (LF) for tables 66"- 84" in length
 - All metal parts Black
 - Cantilever length: 550 mm
 - Central or off-centre placement of columns (T-desk and C-desk)
- Includes all connecting hardware

CONTROL BOX

Two leg tables come standard with a 200 W Control Box

- Mains voltage 230 VAC, 50 Hz, or 120 VAC, 60 Hz
- Ultra-compact; length 210 mm length
- Lightweight control box; weight only approx. 400 g

Three Leg Tables come standard with a 300 W Control Box

- can be connected up to 4 columns
- Mains voltage 100-240 VAC, 50-60 Hz (universal)
- Ultra-compact; length 265 mm length
- Lightweight control box; weight only approx. 500 g

Common features for the (200 W and 300 W):

- Ultra-low; height only 38 mm
- Environment: Operation Storage
- Ambient temperature: 5 to 40 °C -10 to +50 °C
- Relative humidity: 20 to 80 % at 30 °C 20 to 80 % at 30 °C
- Atmospheric pressure: 700 to 1060 hPa 700 to 1060 hPa
- Compact high-power SMPS (Switch Mode Power Supply)
- Colour: black
- Protection against overload (EOP), by individual current limitation
- The control box is designed with a soft start/stop function
- Autodetection of the number and type of columns connected
- Cable grooves at the bottom to optimise cable management
- White plugs for easy recognition when mounting/dismounting
- PVC-Free™
- Low standby power consumption – only 0.1 W.
- Exchangeable standard mains cable

STANDARD UP/DOWN CONTROLLER

Features Bluetooth® connection, two favourite positions and a reminder via an LED to remind the users to use their desk. The Controller is activated by tilting the desk panel in the same direction as the desk is intended to drive. Via pulsating green and orange lights, the LED reminds the users to change positions. Using the integrated Bluetooth® and downloading the Desk Control™ App the user can also be reminded via notifications on computers and smart devices.

- Colour: Black
- Black cable with RJ45 modular plug, 1700 mm straight
- PVC-Free™
- Featuring ZERO™: Very low power consumption in standby mode
- Approved according to EN 60335-1
- Approved according to UL962

NOTE: All grommets must be specified separately.

DISPLAY UP/DOWN CONTROLLER

Features Bluetooth® connection, four favourite positions, a display to guide the users and a reminder via a light strip to remind the users to use their desks. The Controller is activated by tilting the desk panel in the same direction as the desk is intended to drive. The Display Controller features a modern discreet design with a glossy surface and an integrated display to ensure a clean and minimalist design. The display provides guidance to the users when operating the desk. Via pulsating green and orange lights, the light strip reminds the users to change positions. Using the integrated Bluetooth® and downloading the Desk Control™ App the users can also be reminded via notifications on smart devices.

- Colour: Black
- Black cable with RJ45 modular plug, 1700 mm straight
- PVC-Free™
- Featuring ZERO™: Very low power consumption in standby mode
- Approved according to EN 60335-1
- Approved according to UL962

ANTI COLLISION SENSOR

Features enhanced Anti-Collision protection which can limit material damage to a desk or an object if a collision occurs during driving of the desk. The sensor is a compact plug-in adapter based on gyroscope-technology, and it detects even little tilting of the desk when the desk is driving up or down. Upon detected tilting, the system stops and drives in the opposite direction to avoid collision and damage to the desk or the object. The sensor can detect both hard and soft obstacles. The Anti-Collision Sensor is standard on all desks.

- Reacts to angle changes bigger than 0.7° per second
- Just plug it in – no mounting required
- ZEROTM Power capable
- PVC-Free

BATTERY BOX

A high-performance lithium-Ion battery with a capacity of 2.15 Ah. On a full charge the table can cycle from 35 to 45 stroke lengths based upon the range of column selected and load on the table.

- Compact unit for easy handling and installation
- Battery alarm (audio) when charging is needed
- Battery charging indicator (LED light bars) indicating the capacity level
- Thermal switch protection, overcurrent protection
- Colour: black
- Battery capacity: 2.15 Ah / 52 Wh
- Nominal voltage: 24 V DC
- Discharge current: 9 A (max)
- Maximum charging voltage: 40 V DC
- Charging current: 0.5 A
- Weight: 600 g

USAGE

- Ambient temperature: 5 to 40 °C
- Storage temperature: 0 to 45 °C
- Approved according to:
- EN 62133 (Battery safety testing)
- UL 1642 (Lithium cells, standard test)
- UN 38.3 (transportation of Lithium batteries)
- UL 2054 (Household and commercial batteries)
- EN 60335-1 with CBH Advanced

FT52-CL • Standard Range Base with C-Legs

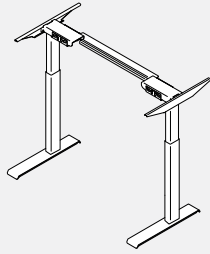

- Kit includes one beam, two cantilevers, two standard range columns and two C styled feet.
- BF indicates a smaller frame for 30" to 36" tables.
- SF indicates small frame for 42" to 60" tables.
- LF indicates large frame: 66" to 84" tables.
- For 23" deep worksurfaces, use 24" CL leg.
- For 29" and 35" deep worksurface, use 30" CL leg.
- For enhanced collision detection an Anti Collision Desk Sensor included with every base.
- For Standard Up/Down Controller add (S) at the end of the code. For Display Controller, please add at "D" at the end of the product code and \$78 to the list price.
- Specify paint finish: BLK-Black, DWT-Designer White, TUN-Tungsten.

PRODUCT CODE	PRICE	HEIGHT MIN/MAX	WIDTH MIN/MAX	DEPTH MIN/MAX	WEIGHT LBS	VOL FT ³
FT52BF24CL	1778	27.5" - 47"	30" - 36"	24" - 24"	56.12	2.3
FT52BF30CL	1791	27.5" - 47"	30" - 36"	30" - 30"	56.12	2.3
FT52SF24CL	1806	27.5" - 47"	42" - 60"	24" - 24"	56.12	2.3
FT52SF30CL	1821	27.5" - 47"	42" - 60"	30" - 36"	56.12	2.3
FT52LF24CL	1815	27.5" - 47"	66" - 84"	24" - 24"	59.3	2.3
FT52LF30CL	1827	27.5" - 47"	66" - 84"	30" - 36"	59.3	2.3

FT52-TL • Standard Range Base with T-Legs

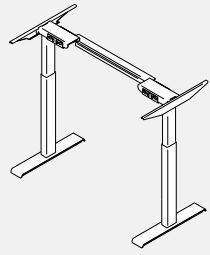

- Kit includes one beam, two cantilevers, two standard range columns and two T styled feet.
- BF indicates a smaller frame for 30" to 36" tables.
- SF indicates small frame for 42" to 60" tables.
- LF indicates large frame: 66" to 84" tables.
- For 23" deep worksurfaces, use 24" TL leg.
- For 29" deep worksurface, use 30" TL leg.
- For enhanced collision detection an Anti Collision Desk Sensor included with every base.
- For Standard Up/Down Controller add (S) at the end of the code. For Display Controller, please add at "D" at the end of the product code and \$78 to the list price.
- Specify paint finish: BLK-Black, DWT-Designer White, TUN-Tungsten.

PRODUCT CODE	PRICE	HEIGHT MIN/MAX	WIDTH MIN/MAX	DEPTH MIN/MAX	WEIGHT LBS	VOL FT ³
FT52BF24TL	1734	27.5" - 47"	30" - 36"	24" - 24"	56.12	2.3
FT52BF30TL	1748	27.5" - 47"	30" - 36"	30" - 30"	56.12	2.3
FT52SF24TL	1763	27.5" - 47"	42" - 60"	24" - 24"	56.12	2.3
FT52SF30TL	1778	27.5" - 47"	42" - 60"	30" - 36"	56.12	2.3
FT52LF24TL	1769	27.5" - 47"	66" - 84"	24" - 24"	59.3	2.3
FT52LF30TL	1784	27.5" - 47"	66" - 84"	30" - 36"	59.3	2.3

FT62-CL • Extended Range Base with C-Legs

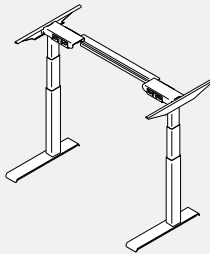

- Kit includes one beam, two cantilevers, two extended range columns and two C styled feet.
- BF indicates a smaller frame for 30" to 36" tables.
- SF indicates small frame for 42" to 60" tables. LF indicates large frame: 66" to 84" tables.
- For 23" deep worksurfaces, use 24" CL leg.
- For 29" and 35" deep worksurface, use 30" CL leg.
- For enhanced collision detection an Anti Collision Desk Sensor included with every base.
- For Standard Up/Down Controller add (S) at the end of the code. For Display Controller, please add at "D" at the end of the product code and \$78 to the list price.
- Specify paint finish: BLK-Black, DWT-Designer White, TUN-Tungsten.

PRODUCT CODE	PRICE	HEIGHT MIN/MAX	WIDTH MIN/MAX	DEPTH MIN/MAX	WEIGHT LBS	VOL FT ³
FT62BF24CL	1896	22.5" - 48.5"	30" - 36"	24" - 24"	56.12	2.3
FT62BF30CL	1911	22.5" - 48.5"	30" - 36"	30" - 30"	56.12	2.3
FT62SF24CL	1927	22.5" - 48.5"	42" - 60"	24" - 24"	59.3	2.3
FT62SF30CL	1941	22.5" - 48.5"	42" - 60"	30" - 36"	59.3	2.3
FT62LF24CL	1932	22.5" - 48.5"	66" - 84"	24" - 24"	64.7	2.3
FT62LF30CL	1947	22.5" - 48.5"	66" - 84"	30" - 36"	64.7	2.3

FT62-TL • Extended Range Base with T-Legs

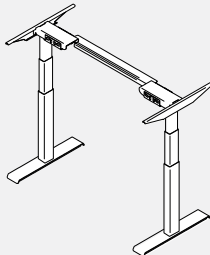

- Kit includes one beam, two cantilevers, two extended range columns and two T styled feet.
- BF indicates a smaller frame for 30" to 36" tables.
- SF indicates small frame for 42" to 60" tables.
- LF indicates large frame: 66" to 84" tables.
- For 23" deep worksurfaces, use 24" TL leg.
- For 29" deep worksurface, use 30" TL leg.
- For enhanced collision detection an Anti Collision Desk Sensor included with every base.
- For Standard Up/Down Controller add (S) at the end of the code. For Display Controller, please add at "D" at the end of the product code and \$78 to the list price.
- Specify paint finish: BLK-Black, DWT-Designer White, TUN-Tungsten.

PRODUCT CODE	PRICE	HEIGHT MIN/MAX	WIDTH MIN/MAX	DEPTH MIN/MAX	WEIGHT LBS	VOL FT ³
FT62BF24TL	1854	22.5" - 48.5"	30" - 36"	24" - 24"	56.12	2.3
FT62BF30TL	1868	22.5" - 48.5"	30" - 36"	30" - 30"	56.12	2.3
FT62SF24TL	1884	22.5" - 48.5"	42" - 60"	24" - 24"	59.3	2.3
FT62SF30TL	1895	22.5" - 48.5"	42" - 60"	30" - 36"	59.3	2.3
FT62LF24TL	1890	22.5" - 48.5"	66" - 84"	24" - 24"	64.7	2.3
FT62LF30TL	1905	22.5" - 48.5"	66" - 84"	30" - 36"	64.7	2.3

• LP = Thermally Fused Laminate, HP = High Pressure Laminate.

FT539F-CL • Standard Range 90 Degree Table Base, Equal Sides

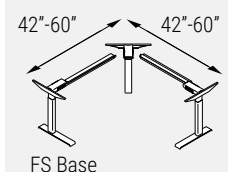

FS Base

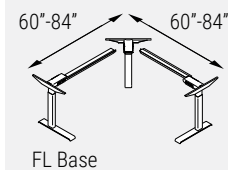

FL Base

- Kit includes two equal length beams, three cantilevers, one standard range corner column, two standard range columns and two C styled feet.

- FS indicates small base for 54" to 60" sided tables.

- FL indicates large base for 66" to 84" sided tables.

- For 23" deep worksurfaces, use 24" CL leg.

- For 29" and 35" deep worksurface, use 30" CL leg.

- For enhanced collision detection an Anti Collision Desk Sensor included with every base.

- For Standard Up/Down Controller add (S) at the end of the code. For Display Controller, please add at "D" at the end of the product code and \$78 to the list price.

- Specify paint finish: BLK-Black, DWT-Designer White, TUN-Tungsten.

PRODUCT CODE	PRICE	HEIGHT MIN/MAX	WIDTH MIN/MAX	DEPTH MIN/MAX	WEIGHT LBS	VOL FT ³
FT539FS24CL	2629	27.5" - 47"	42" - 60"	42" - 60"	79.1	4.7
FT539FS30CL	2644	27.5" - 47"	42" - 60"	42" - 60"	79.1	4.7
FT539FL24CL	2678	27.5" - 47"	66" - 84"	66" - 84"	59.3	4.7
FT539FL30CL	2690	27.5" - 47"	66" - 84"	66" - 84"	59.3	4.7

FT539FSL-CL • Standard Range 90 Degree Table Base, Unequal Sides

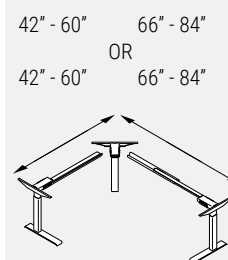

- Kit includes two beams (one small and one large), three cantilevers, one standard range corner column, two standard range columns and two C styled feet.

- For 23" deep worksurfaces, use 24" CL leg.

- For 29" and 35" deep worksurface, use 30" CL leg.

- For enhanced collision detection an Anti Collision Desk Sensor included with every base.

- For Standard Up/Down Controller add (S) at the end of the code. For Display Controller, please add at "D" at the end of the product code and \$78 to the list price.

- Specify paint finish: BLK-Black, DWT-Designer White, TUN-Tungsten.

PRODUCT CODE	PRICE	HEIGHT MIN/MAX	WIDTH MIN/MAX	DEPTH MIN/MAX	WEIGHT LBS	VOL FT ³
FT539FSL24CL	2652	27.5" - 47"	42" - 60"	66" - 84"	85.4	4.7
FT539FSL30CL	2666	27.5" - 47"	42" - 60"	66" - 84"	85.4	4.7

FT639F-CL • Extended Range 90 Degree Table Base, Equal Sides

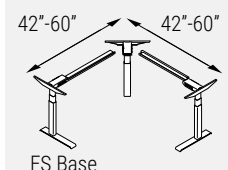

FS Base

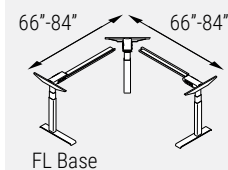

FL Base

- Kit includes two equal length beams, three cantilevers, one extended range corner column, two extended range columns and two C styled feet.

- FS indicates small base for 54" to 60" sided tables.

- FL indicates large base for 66" to 84" sided tables.

- For 23" deep worksurfaces, use 24" CL leg.

- For 29" and 35" deep worksurface, use 30" CL leg.

- For enhanced collision detection an Anti Collision Desk Sensor included with every base.

- For Standard Up/Down Controller add (S) at the end of the code. For Display Controller, please add at "D" at the end of the product code and \$78 to the list price.

- Specify paint finish: BLK-Black, DWT-Designer White, TUN-Tungsten.

PRODUCT CODE	PRICE	HEIGHT MIN/MAX	WIDTH MIN/MAX	DEPTH MIN/MAX	WEIGHT LBS	VOL FT ³
FT639FS24CL	2808	22.5" - 48.5"	42" - 60"	42" - 60"	76.5	4.7
FT639FS30CL	2822	22.5" - 48.5"	42" - 60"	42" - 60"	76.5	4.7
FT639FL24CL	2855	22.5" - 48.5"	66" - 84"	66" - 84"	82.7	4.7
FT639FL30CL	2869	22.5" - 48.5"	66" - 84"	66" - 84"	82.7	4.7

FT639FSL-CL • Extended Range 90 Degree Table Base, Unequal Sides

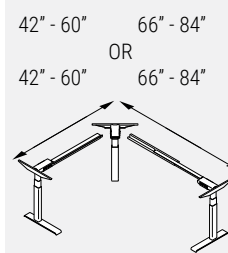

- Kit includes two beams (one small and one large), three cantilevers, one extended range corner column, two extended range columns and two C styled feet.

- For 23" deep worksurfaces, use 24" CL leg.

- For 29" and 35" deep worksurface, use 30" CL leg.

- For enhanced collision detection an Anti Collision Desk Sensor included with every base.

- For Standard Up/Down Controller add (S) at the end of the code. For Display Controller, please add at "D" at the end of the product code and \$78 to the list price.

- Specify paint finish: BLK-Black, DWT-Designer White, TUN-Tungsten.

PRODUCT CODE	PRICE	HEIGHT MIN/MAX	WIDTH MIN/MAX	DEPTH MIN/MAX	WEIGHT LBS	VOL FT ³
FT639FSL24CL	2832	22.5" - 48.5"	42" - 60"	48" - 84"	85.4	4.7
FT639FSL30CL	2845	22.5" - 48.5"	42" - 60"	48" - 84"	85.4	4.7

FT51-R-CL • Standard Range 90 Degree Table Retrofit Kit with with C-Leg

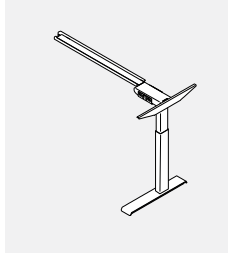

- Kit includes one beam, one cantilever, one standard range column and one C styled foot.

- SR indicates short returns.

- LR indicates long returns.

- For 23" deep worksurfaces, use 24" CL leg.

- For 29" and 35" deep worksurface, use 30" CL leg.

- Specify paint finish: BLK-Black, DWT-Designer White, TUN-Tungsten.

PRODUCT CODE	PRICE	HEIGHT MIN/MAX	WIDTH MIN/MAX	DEPTH MIN/MAX	WEIGHT LBS	VOL FT ³
FT51SR24CL	1195	27.5" - 47"	24" - 48"	24" - 24"	24.9	4.7
FT51LR24CL	1219	27.5" - 47"	54" - 72"	24" - 24"	26.9	4.7
FT51SR30CL	1203	27.5" - 47"	24" - 48"	30" - 36"	24.9	4.7
FT51LR30CL	1225	27.5" - 47"	54" - 72"	30" - 36"	26.9	4.7

FT51-R-TL • Standard Range 90 Degree Table Retrofit Kit with with T-Leg

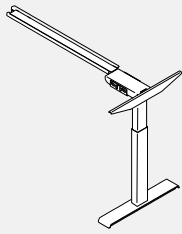

- Kit includes one beam, one cantilever, one standard range column and one T styled foot.
- SR indicates short returns.
- LR indicates long returns.
- For 23" deep worksurfaces, use 24" TL leg.
- For 29" and 35" deep worksurface, use 30" TL leg.
- Specify paint finish: BLK-Black, DWT-Designer White, TUN-Tungsten.

PRODUCT CODE	PRICE	HEIGHT MIN/MAX	WIDTH MIN/MAX	DEPTH MIN/MAX	WEIGHT LBS	VOL FT ³
FT51SR24TL	1176	27.5" - 47"	24" - 48"	24" - 24"	24.9	2.3
FT51LR24TL	1197	27.5" - 47"	54" - 72"	24" - 24"	26.9	2.3
FT51SR30TL	1181	27.5" - 47"	24" - 48"	30" - 36"	24.9	2.3
FT51LR30TL	1204	27.5" - 47"	54" - 72"	30" - 36"	26.9	2.3

FT61-R-CL • Extended Range 90 Degree Table Retrofit Kit with with C-Leg

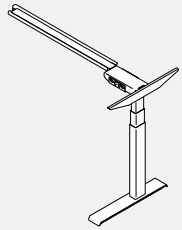

- Kit includes one beam, one cantilever, one extended range column and one C styled foot.
- SR indicates short returns.
- LR indicates long returns.
- For 23" deep worksurfaces, use 24" CL leg.
- For 29" and 35" deep worksurface, use 30" CL leg.
- Specify paint finish: BLK-Black, DWT-Designer White, TUN-Tungsten.

PRODUCT CODE	PRICE	HEIGHT MIN/MAX	WIDTH MIN/MAX	DEPTH MIN/MAX	WEIGHT LBS	VOL FT ³
FT61SR24CL	1255	22.5" - 48.5"	24" - 48"	24" - 24"	27.6	4.7
FT61LR24CL	1279	22.5" - 48.5"	54" - 72"	24" - 24"	30.7	4.7
FT61SR30CL	1262	22.5" - 48.5"	24" - 48"	30" - 36"	27.6	4.7
FT61LR30CL	1286	22.5" - 48.5"	54" - 72"	30" - 36"	30.7	4.7

FT61-R-TL • Extended Range 90 Degree Table Retrofit Kit with with T-Leg

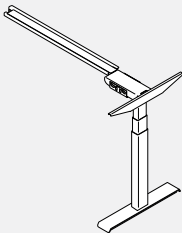

- Kit includes one beam, one cantilever, one extended range column and one T styled foot.
- SR indicates short returns.
- LR indicates long returns.
- For 23" deep worksurfaces, use 24" TL leg.
- For 29" and 35" deep worksurface, use 30" TL leg.
- Specify paint finish: BLK-Black, DWT-Designer White, TUN-Tungsten.

PRODUCT CODE	PRICE	HEIGHT MIN/MAX	WIDTH MIN/MAX	DEPTH MIN/MAX	WEIGHT LBS	VOL FT ³
FT61SR24TL	1234	22.5" - 48.5"	24" - 48"	24" - 24"	27.6	2.3
FT61LR24TL	1257	22.5" - 48.5"	54" - 72"	24" - 24"	30.7	2.3
FT61SR30TL	1241	22.5" - 48.5"	24" - 48"	30" - 36"	27.6	2.3
FT61LR30TL	1265	22.5" - 48.5"	54" - 72"	30" - 36"	30.7	2.3

FT531F-CL • Standard Range 120 Degree Table Base, Equal Sides

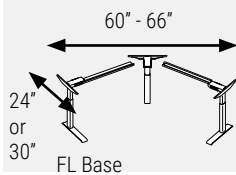
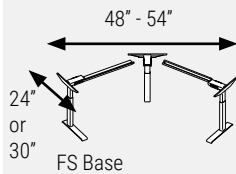

- Kit includes two beams, three cantilevers, one standard range corner column, two standard range columns and two C styled feet.
- FS indicates small base for 48" to 54" sided tables.
- FL indicates large base for 60" to 66" sided tables.
- For 23" deep worksurfaces, use 24" CL leg.
- For 29" and 35" deep worksurface, use 30" CL leg.
- For enhanced collision detection an Anti Collision Desk Sensor included with every base.
- For Standard Up/Down Controller add (S) at the end of the code. For Display Controller, please add at "D" at the end of the product code and \$78 to the list price.
- Specify paint finish: BLK-Black, DWT-Designer White, TUN-Tungsten.

PRODUCT CODE	PRICE	HEIGHT MIN/MAX	WIDTH MIN/MAX	DEPTH MIN/MAX	WEIGHT LBS	VOL FT ³
FT531FS24CL	2629	27.5" - 47"	48" - 54"	48" - 54"	59.7	4.7
FT531FS30CL	2644	27.5" - 47"	48" - 54"	48" - 54"	59.7	4.7
FT531FL24CL	2678	27.5" - 47"	60" - 66"	60" - 66"	59.7	4.7
FT531FL30CL	2690	27.5" - 47"	60" - 66"	60" - 66"	59.7	4.7

FT631F-CL • Extended Range 120 Degree Table Base, Equal Sides

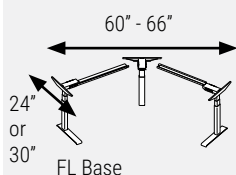
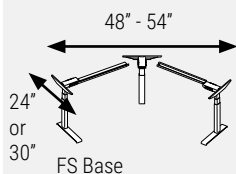

- Kit includes two beams, three cantilevers, one extended range corner column, two extended range columns and two C styled feet.
- FS indicates small base for 48" to 54" sided tables.
- FL indicates large base for 60" to 66" sided tables.
- For 23" deep worksurfaces, use 24" CL leg.
- For 29" and 35" deep worksurface, use 30" CL leg.
- For enhanced collision detection an Anti Collision Desk Sensor included with every base.
- For Standard Up/Down Controller add (S) at the end of the code. For Display Controller, please add at "D" at the end of the product code and \$78 to the list price.
- Specify paint finish: BLK-Black, DWT-Designer White, TUN-Tungsten.

PRODUCT CODE	PRICE	HEIGHT MIN/MAX	WIDTH MIN/MAX	DEPTH MIN/MAX	WEIGHT LBS	VOL FT ³
FT631FS24CL	2808	22.5" - 48.5"	48" - 54"	48" - 54"	59.7	4.7
FT631FS30CL	2822	22.5" - 48.5"	48" - 54"	48" - 54"	59.7	4.7
FT631FL24CL	2855	22.5" - 48.5"	60" - 66"	60" - 66"	59.7	4.7
FT631FL30CL	2869	22.5" - 48.5"	60" - 66"	60" - 66"	59.7	4.7

FT5B2B • Back to Back Standard Range Base

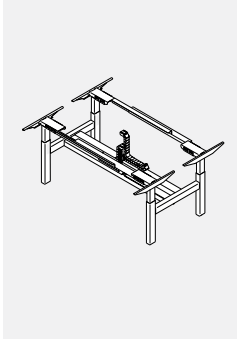

- Kit includes two beams, four cantilevers, four standard range columns and one power trough assembly with two energy chains.
- For 50.5 depth, use two x 23" deep worksurfaces.
- For 62.5" depth, use two x 29" deep worksurfaces.
- 30" or larger depth worksurfaces cannot be used with Back to Back bases.
- Duplex receptacles are not included, please specify separately.
- For enhanced collision detection an Anti Collision Desk Sensor included with every base.
- For Standard Up/Down Controller add (S) at the end of the code. For Display Controller, please add at "D" at the end of the product code and \$165 to the list price.
- Specify paint finish: BLK-Black, DWT-Designer White, TUN-Tungsten.

PRODUCT CODE	PRICE	HEIGHT MIN/MAX	WIDTH MIN/MAX	DEPTH MIN/MAX	WEIGHT LBS	VOL FT ³
FT5B2B48	4977	27.5" - 47"	48" - 48"	50.5" - 62.5"	129	4.7
FT5B2B54	5014	27.5" - 47"	54" - 54"	50.5" - 62.5"	129	4.7
FT5B2B60	5066	27.5" - 47"	60" - 60"	50.5" - 62.5"	129	4.7
FT5B2B66	5104	27.5" - 47"	66" - 66"	50.5" - 62.5"	129	4.7
FT5B2B72	5117	27.5" - 47"	72" - 84"	50.5" - 62.5"	129	4.7

FT6B2B • Back to Back Extended Range Base

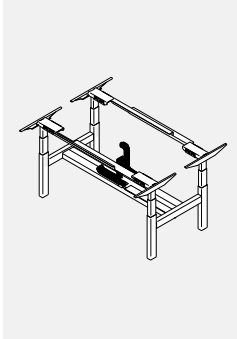

- Kit includes two beams, four cantilevers, four extended range columns and one power trough assembly with two energy chains.
- For 50.5 depth, use two x 23" deep worksurfaces.
- For 62.5" depth, use two x 29" deep worksurfaces.
- 30" or larger depth worksurfaces cannot be used with Back to Back bases.
- Duplex receptacles are not included, please specify separately.
- For enhanced collision detection an Anti Collision Desk Sensor included with every base.
- For Standard Up/Down Controller add (S) at the end of the code. For Display Controller, please add at "D" at the end of the product code and \$165 to the list price.
- Specify paint finish: BLK-Black, DWT-Designer White, TUN-Tungsten.

PRODUCT CODE	PRICE	HEIGHT MIN/MAX	WIDTH MIN/MAX	DEPTH MIN/MAX	WEIGHT LBS	VOL FT ³
FT6B2B48	5204	22.5" - 48.5"	48" - 48"	50.5" - 62.5"	129	4.7
FT6B2B54	5241	22.5" - 48.5"	54" - 54"	50.5" - 62.5"	129	4.7
FT6B2B60	5294	22.5" - 48.5"	60" - 60"	50.5" - 62.5"	129	4.7
FT6B2B66	5331	22.5" - 48.5"	66" - 66"	50.5" - 62.5"	129	4.7
FT6B2B72	5343	22.5" - 48.5"	72" - 84"	50.5" - 62.5"	129	4.7

FT5SGL-T • Standard Range Single Frame

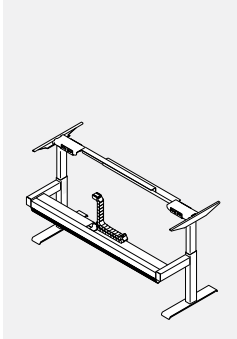

- Kit includes one beam, two cantilevers, two standard range columns, two T styled feet and one power trough assembly with one energy chains.
- For T24 leg, use 23" deep worksurfaces.
- For T30 leg, use 29" deep worksurfaces.
- 30" or larger depth worksurfaces cannot be used with Back to Back bases.
- Duplex receptacles are not included, please specify separately.
- For enhanced collision detection an Anti Collision Desk Sensor included with every base.
- For Standard Up/Down Controller add (S) at the end of the code. For Display Controller, please add at "D" at the end of the product code and \$78 to the list price.
- Specify paint finish: BLK-Black, DWT-Designer White, TUN-Tungsten.

PRODUCT CODE	PRICE	HEIGHT MIN/MAX	WIDTH MIN/MAX	DEPTH MIN/MAX	WEIGHT LBS	VOL FT ³
FT5SGL48T24	2915	27.5" - 47"	48" - 48"	24" - 24"	75	2.3
FT5SGL54T24	2949	27.5" - 47"	54" - 54"	24" - 24"	75	2.3
FT5SGL60T24	2988	27.5" - 47"	60" - 60"	24" - 24"	75	2.3
FT5SGL66T24	3017	27.5" - 47"	66" - 66"	24" - 24"	75	2.3
FT5SGL72T24	3042	27.5" - 47"	72" - 84"	24" - 24"	75	2.3
FT5SGL48T30	2930	27.5" - 47"	48" - 48"	30" - 30"	75	2.3
FT5SGL54T30	2964	27.5" - 47"	54" - 54"	30" - 30"	75	2.3
FT5SGL60T30	3003	27.5" - 47"	60" - 60"	30" - 30"	75	2.3
FT5SGL66T30	3033	27.5" - 47"	66" - 66"	30" - 30"	75	2.3
FT5SGL72T30	3057	27.5" - 47"	72" - 84"	30" - 30"	75	2.3

FT6SGL-T • Extended Range Single Frame

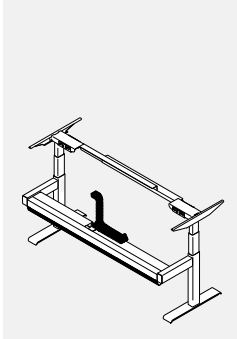

- Kit includes one beam, two cantilevers, two extended range columns, two T styled feet and one power trough assembly with one energy chains.
- For T24 leg, use 23" deep worksurfaces.
- For T30 leg, use 29" deep worksurfaces.
- 30" or larger depth worksurfaces cannot be used with Back to Back bases.
- Duplex receptacles are not included, please specify separately.
- For enhanced collision detection an Anti Collision Desk Sensor included with every base.
- For Standard Up/Down Controller add (S) at the end of the code. For Display Controller, please add at "D" at the end of the product code and \$78 to the list price.
- Specify paint finish: BLK-Black, DWT-Designer White, TUN-Tungsten.

PRODUCT CODE	PRICE	HEIGHT MIN/MAX	WIDTH MIN/MAX	DEPTH MIN/MAX	WEIGHT LBS	VOL FT ³
FT6SGL48T24	3029	22.5" - 48.5"	48" - 48"	24" - 24"	75	2.3
FT6SGL54T24	3063	22.5" - 48.5"	54" - 54"	24" - 24"	75	2.3
FT6SGL60T24	3103	22.5" - 48.5"	60" - 60"	24" - 24"	75	2.3
FT6SGL66T24	3132	22.5" - 48.5"	66" - 66"	24" - 24"	75	2.3
FT6SGL72T24	3157	22.5" - 48.5"	72" - 84"	24" - 24"	75	2.3
FT6SGL48T30	3043	22.5" - 48.5"	48" - 48"	30" - 30"	75	2.3
FT6SGL54T30	3076	22.5" - 48.5"	54" - 54"	30" - 30"	75	2.3
FT6SGL60T30	3115	22.5" - 48.5"	60" - 60"	30" - 30"	75	2.3
FT6SGL66T30	3146	22.5" - 48.5"	66" - 66"	30" - 30"	75	2.3
FT6SGL72T30	3170	22.5" - 48.5"	72" - 84"	30" - 30"	75	2.3

FT5SGL-T • Standard Range End of Run Single Frame

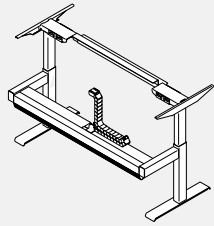

- Kit includes one beam, two cantilevers, two standard range columns, two T styled feet and one power trough assembly with one energy chains.
- For T24 leg, use 23" deep worksurfaces.
- For T30 leg, use 29" deep worksurfaces.
- 30" or larger depth worksurfaces cannot be used with Back to Back bases.
- Duplex receptacles are not included, please specify separately.
- For enhanced collision detection an Anti Collision Desk Sensor included with every base.
- For Standard Up/Down Controller add (S) at the end of the code. For Display Controller, please add at "D" at the end of the product code and \$78 to the list price.
- Specify paint finish: BLK-Black, DWT-Designer White, TUN-Tungsten.

PRODUCT CODE	PRICE	HEIGHT MIN/MAX	WIDTH MIN/MAX	DEPTH MIN/MAX	WEIGHT LBS	VOL FT ³
FT5SGL51T24	3178	27.5" - 47"	51" - 62"	24" - 24"	75	2.3
FT5SGL51T30	3194	27.5" - 47"	51" - 62"	30" - 30"	75	2.3

FT6SGL-T • Extended Range End of Run Single Frame

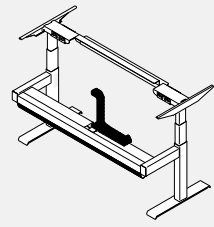

- Kit includes one beam, two cantilevers, two extended range columns, two T styled feet and one power trough assembly with one energy chains.
- For T24 leg, use 23" deep worksurfaces.
- For T30 leg, use 29" deep worksurfaces.
- 30" or larger depth worksurfaces cannot be used with Back to Back bases.
- Duplex receptacles are not included, please specify separately.
- For enhanced collision detection an Anti Collision Desk Sensor included with every base.
- For Standard Up/Down Controller add (S) at the end of the code. For Display Controller, please add at "D" at the end of the product code and \$78 to the list price.
- Specify paint finish: BLK-Black, DWT-Designer White, TUN-Tungsten.

PRODUCT CODE	PRICE	HEIGHT MIN/MAX	WIDTH MIN/MAX	DEPTH MIN/MAX	WEIGHT LBS	VOL FT ³
FT6SGL51T24	3293	22.5" - 48.5"	51" - 62"	24" - 24"	75	2.3
FT6SGL51T30	3306	22.5" - 48.5"	51" - 62"	30" - 30"	75	2.3

FTM5B2B-F • Standard Range Media Table Base

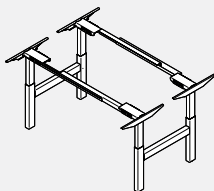

- Kit includes two beams, four cantilevers, four standard range columns and two controllers.
- SF indicates small base for 60" sided tables.
- LF indicates large base for 66" to 96" sided tables.
- Duplex receptacles are not included, please specify separately.
- For enhanced collision detection an Anti Collision Desk Sensor included with every base.
- For Standard Up/Down Controller add (S) at the end of the code. For Display Controller, please add at "D" at the end of the product code and \$165 to the list price.
- Specify paint finish: BLK-Black, DWT-Designer White, TUN-Tungsten.

PRODUCT CODE	PRICE	HEIGHT MIN/MAX	WIDTH MIN/MAX	DEPTH MIN/MAX	WEIGHT LBS	VOL FT ³
FTM5B2BSF	4067	27.5" - 47"	60" - 60"	54" - 60"	129	4.7
FTM5B2BLF	4081	27.5" - 47"	66" - 96"	54" - 60"	129	4.7

FTM6B2B-F • Extended Range Media Table Base

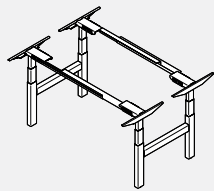

- Kit includes two beams, four cantilevers, four extended range columns and two controllers.
- SF indicates small base for 60" sided tables.
- LF indicates large base for 66" to 96" sided tables.
- Duplex receptacles are not included, please specify separately.
- For enhanced collision detection an Anti Collision Desk Sensor included with every base.
- For Standard Up/Down Controller add (S) at the end of the code. For Display Controller, please add at "D" at the end of the product code and \$165 to the list price.
- Specify paint finish: BLK-Black, DWT-Designer White, TUN-Tungsten.

PRODUCT CODE	PRICE	HEIGHT MIN/MAX	WIDTH MIN/MAX	DEPTH MIN/MAX	WEIGHT LBS	VOL FT ³
FTM6B2BSF	4294	22.5" - 48.5"	60" - 60"	54" - 60"	129	4.7
FTM6B2BLF	4308	22.5" - 48.5"	66" - 96"	54" - 60"	129	4.7

FTWR - Rectangular Worksurface

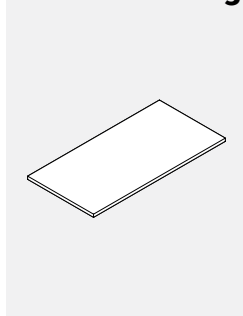

- Rectangular worksurfaces are non-handed and can be interchanged on site.
- Specify laminate finish and PVC edge finish.
- Grommet option for surfaces less than 64" is TC - Top Center only.
- Specification:
- For 23" deep worksurfaces, use FT52(S/L)F24CL/TL standard range or FT62(S/L)F24CL/TL extended range base.
- For 29" deep worksurfaces, use FT52(S/L)F30CL/TL standard range or FT62(S/L)F30CL/TL extended range base.
- For 35" deep worksurfaces, use FT5(S/L)F30CL/TL standard range or FT6(S/L)F30CL/TL extended range base.
- The 35" deep worksurfaces cannot be used with Back to Back Bases.
- For Back to Back bases, please use the following chart:
 FTW(23/29)46, FT(5/6)B2B48
 FTW(23/29)52, FT(5/6)B2B54
 FTW(23/29)58, FT(5/6)B2B60
 FTW(23/29)64, FT(5/6)B2B66
 FTW(23/29)72, FT(5/6)B2B72
 FTW(23/29)76, FT(5/6)B2B72
 FTW(23/29)82, FT(5/6)B2B72

PRODUCT CODE	PRICE LP	HP	SIZE/INCHES			WEIGHT LBS	VOL FT ³
			H	W	D		
FTWR2328	149	191	1	28	23	20	1.16
FTWR2334	165	215	1	34	23	24	1.40
FTWR2340	212	279	1	40	23	28	1.64
FTWR2346	245	329	1	46	23	31	1.84
FTWR2352	290	383	1	52	23	36	2.08
FTWR2358	326	430	1	58	23	40	2.32
FTWR2364	340	449	1	64	23	44	2.56
FTWR2370	355	470	1	70	23	48	3.80
FTWR2376	381	501	1	76	23	52	3.03
FTWR2382	410	537	1	82	23	56	3.27
FTWR2928	173	227	1	28	29	25	1.46
FTWR2934	202	265	1	34	29	30	1.76
FTWR2940	283	371	1	40	29	35	2.06
FTWR2946	290	383	1	46	29	40	2.32
FTWR2952	317	408	1	52	29	45	2.62
FTWR2958	340	449	1	58	29	50	2.92
FTWR2964	353	469	1	64	29	55	3.22
FTWR2970	374	495	1	70	29	60	3.52
FTWR2976	398	524	1	76	29	65	3.83
FTWR2982	443	579	1	82	29	71	4.13
FTWR3528	178	234	1	28	35	30	2.00
FTWR3534	210	275	1	34	35	35	2.00
FTWR3540	295	385	1	40	35	40	2.50
FTWR3546	378	471	1	46	35	48	2.80
FTWR3552	420	526	1	52	35	54	3.16
FTWR3558	466	583	1	58	35	60	3.52
FTWR3564	508	637	1	64	35	67	3.89
FTWR3570	552	691	1	70	35	73	4.25
FTWR3576	594	743	1	76	35	79	4.62
FTWR3582	639	800	1	82	35	85	4.98

FTWRR - Rectangular Return Worksurface

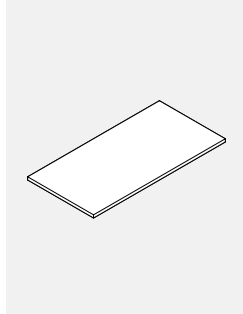

- Rectangular return worksurfaces are non-handed and can be interchanged on site.
- Specify laminate finish and PVC edge finish.
- Includes two flat brackets for connection.
- Specification:
- For 23" deep worksurfaces, use FT51SR24CL/TL standard range or FT61SR24CL/TL extended range base.
- For 29" deep worksurfaces, use FT51SR30CL/TL standard range or FT61SR30CL/TL extended range base.

PRODUCT CODE	PRICE LP	HP	SIZE/INCHES			WEIGHT LBS	VOL FT ³
			H	W	D		
FTWRR2329	149	191	1	29	23	20	1.16
FTWRR2335	165	215	1	35	23	24	1.40
FTWRR2341	212	279	1	41	23	28	1.64
FTWRR2347	254	336	1	47	23	32	1.88
FTWRR2353	297	392	1	53	23	36	2.12
FTWRR2359	333	438	1	59	23	40	2.36
FTWRR2929	173	227	1	29	29	25	1.46
FTWRR2935	202	265	1	35	29	30	1.76
FTWRR2941	283	371	1	41	29	35	2.06
FTWRR2947	297	392	1	47	29	40	2.36
FTWRR2953	323	418	1	53	29	46	2.67
FTWRR2959	347	458	1	59	29	51	2.97

FTWR - Rectangular End of Run Worksurface

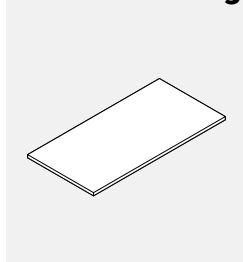

- Rectangular end of run worksurfaces are non-handed and can be interchanged on site.
- Specify laminate finish and PVC edge finish.
- Specification:
- For 23" deep worksurfaces, use FT52(S/F)L24CL/TL standard range or FT62(S/F)L24CL/TL extended range base.
- For 29" deep worksurfaces, use FT52(S/F)L30CL/TL standard range or FT62(S/F)L30CL/TL extended range base.
- For Back to Back bases, please use the following chart:
 FTWR(23/29)51, FT(5/6)B2B60
 FTWR(23/29)62, FT(5/6)B2B66

PRODUCT CODE	PRICE LP	HP	SIZE/INCHES			WEIGHT LBS	VOL FT ³
			H	W	D		
FTWR2351	326	430	1	51	23	40	2.02
FTWR2362	340	449	1	62	23	44	2.5
FTWR2951	340	449	1	51	29	50	2.54
FTWR2962	353	528	1	62	29	55	3.15

• LP = Thermally Fused Laminate, HP = High Pressure Laminate.

FTWCC - 90 Degree Corner Worksurface

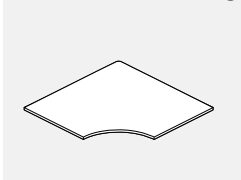

- 90 Corner Worksurface.
- Specify laminate finish and PVC edge finish.
- Specification:
- For tables that connect with 23" deep work-surfaces, use FT539FS24CL standard range or FT539FS24CL extended range base.
- For table that connect with 29" deep work-surfaces, use FT539FS30CL standard range or FT639FS30CL extended range base.

PRODUCT CODE	FINISH		SIZE / INCHES				WEIGHT LBS	VOL FT ³
	LP	HP	H	W	D			
FTWCC234023	549	603	1	40	40	70	1.50	
FTWCC234623	565	620	1	46	46	75	2.00	
FTWCC235223	647	712	1	52	52	80	4.69	
FTWCC235823	828	910	1	58	58	100	5.84	
FTWCC294029	549	603	1	40	40	70	1.50	
FTWCC294629	549	603	1	46	46	75	3.67	
FTWCC295229	647	712	1	52	52	80	4.69	
FTWCC295829	828	910	1	58	58	100	5.84	

FTWEC - Left Extended 90 Degree Corner Worksurface

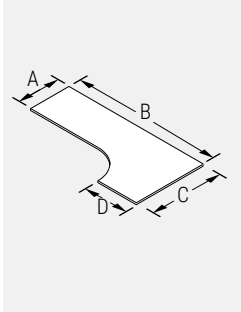

- Left Extended 90 Degree Corner Worksurface.
- Specify laminate finish and PVC edge finish.
- Specification:
- For tables that connect with 23" deep (A and D) work-surfaces, use FT539F(S/L)24CL standard range or FT639F(S/L)24CL extended range base.
- For table that connect with 29" deep (A and D) work-surfaces, use FT539F(S/L)30CL standard range or FT639F(S/L)30CL extended range base.

PRODUCT CODE	FINISH		SIZE / INCHES				WEIGHT LBS	VOL FT ³
	LP	HP	H	W	D			
FTWEC23584023	741	927	1	58	40	115	2.55	
FTWEC23644023	824	1030	1	64	40	127	2.81	
FTWEC23704023	901	1128	1	70	40	138	3.07	
FTWEC23764023	963	1200	1	76	40	150	3.34	
FTWEC23824023	1020	1275	1	82	40	162	3.60	
FTWEC23584623	763	955	1	58	46	115	2.55	
FTWEC23644623	849	1060	1	64	46	127	2.81	
FTWEC23704623	928	1162	1	70	46	138	3.07	
FTWEC23764623	991	1236	1	76	46	150	3.34	
FTWEC23824623	1051	1313	1	82	46	162	3.60	
FTWEC23585223	787	985	1	58	52	130	2.88	
FTWEC23645223	872	1093	1	64	52	143	3.18	
FTWEC23705223	956	1197	1	70	52	156	3.48	
FTWEC23765223	1020	1273	1	76	52	170	3.77	
FTWEC23825223	1082	1353	1	82	52	183	4.07	
FTWEC23645823	901	1125	1	64	58	160	3.54	
FTWEC23705823	986	1232	1	70	58	174	3.88	
FTWEC23765823	1051	1312	1	76	58	189	4.21	
FTWEC23825823	1114	1394	1	82	58	204	4.54	
FTWEC29584029	771	965	1	58	40	115	2.55	
FTWEC29644029	858	1071	1	64	40	127	2.81	
FTWEC29704029	936	1173	1	70	40	138	3.07	
FTWEC29764029	1000	1247	1	76	40	150	3.34	
FTWEC29824029	1060	1327	1	82	40	162	3.60	
FTWEC29584629	794	993	1	58	46	115	2.55	
FTWEC29644629	883	1102	1	64	46	127	2.81	
FTWEC29704629	966	1208	1	70	46	138	3.07	
FTWEC29764629	1031	1286	1	76	46	150	3.34	
FTWEC29824629	1093	1366	1	82	46	162	3.6	
FTWEC29585229	818	1024	1	58	52	130	2.88	
FTWEC29645229	908	1136	1	64	52	143	3.18	
FTWEC29705229	994	1243	1	70	52	156	3.48	
FTWEC29765229	1060	1324	1	76	52	170	3.77	
FTWEC29825229	1125	1407	1	82	52	183	4.07	
FTWEC29645829	935	1170	1	64	58	160	3.54	
FTWEC29705829	1025	1282	1	70	58	174	3.88	
FTWEC29765829	1093	1365	1	76	58	189	4.21	
FTWEC29825829	1159	1451	1	82	58	204	4.54	

NOTE: FTWEC

A	B	C	D
DEPTH	LENGTH	WIDTH	DEPTH

• LP = Thermally Fused Laminate, HP = High Pressure Laminate.

FTWEC • Right Extended 90 Degree Corner Worksurface

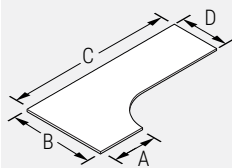

- Right Extended 90 Degree Corner Worksurface.
- Specify laminate finish and PVC edge finish.
- Specification:
- For tables that connect with 23" deep (A and D) worksurfaces, use FT539F(S/L)24CL standard range or FT639F(S/L)24CL extended range base.
- For table that connect with 29" deep (A and D) worksurfaces, use FT539F(S/L)30CL standard range or FT639F(S/L)30CL extended range base.

NOTE: FTWEC

A	B	C	D
DEPTH	WIDTH	LENGTH	DEPTH

PRODUCT CODE	FINISH		SIZE / INCHES			WEIGHT LBS	VOL FT ³
	LP	HP	H	W	D		
FTWEC23405823	741	927	1	58	40	115	2.55
FTWEC23406423	824	1030	1	64	40	127	2.81
FTWEC23407023	901	1128	1	70	40	138	3.07
FTWEC23407623	963	1200	1	76	40	150	3.34
FTWEC23408223	1020	1275	1	82	40	162	3.60
FTWEC23465823	763	955	1	58	46	115	2.55
FTWEC23466423	849	1060	1	64	46	127	2.81
FTWEC23467023	928	1162	1	70	46	138	3.07
FTWEC23467623	991	1236	1	76	46	150	3.34
FTWEC23468223	1051	1313	1	82	46	162	3.6
FTWEC23525823	787	985	1	58	52	130	2.88
FTWEC23526423	872	1093	1	64	52	143	3.18
FTWEC23527023	956	1197	1	70	52	156	3.48
FTWEC23527623	1020	1273	1	76	52	170	3.77
FTWEC23528223	1082	1353	1	82	52	183	4.07
FTWEC23586423	901	1125	1	64	58	160	3.54
FTWEC23587023	986	1232	1	70	58	174	3.88
FTWEC23587623	1051	1312	1	76	58	189	4.21
FTWEC23588223	1114	1394	1	82	58	204	4.54
FTWEC29405829	771	965	1	58	40	115	2.55
FTWEC29406429	858	1071	1	64	40	127	2.81
FTWEC29407029	936	1173	1	70	40	138	3.07
FTWEC29407629	1000	1247	1	76	40	150	3.34
FTWEC29408229	1060	1327	1	82	40	162	3.60
FTWEC29465829	794	993	1	58	46	115	2.55
FTWEC29466429	883	1102	1	64	46	127	2.81
FTWEC29467029	966	1208	1	70	46	138	3.07
FTWEC29467629	1031	1286	1	76	46	150	3.34
FTWEC29468229	1093	1366	1	82	46	162	3.6
FTWEC29525829	818	1024	1	58	52	130	2.88
FTWEC29526429	908	1136	1	64	52	143	3.18
FTWEC29527029	994	1243	1	70	52	156	3.48
FTWEC29527629	1060	1324	1	76	52	170	3.77
FTWEC29528229	1125	1407	1	82	52	183	4.07
FTWEC29586429	935	1170	1	64	58	160	3.54
FTWEC29587029	1025	1282	1	70	58	174	3.88
FTWEC29587629	1093	1365	1	76	58	189	4.21
FTWEC29588229	1159	1451	1	82	58	204	4.54

FTWRE • Rectangular Extension Return Worksurface

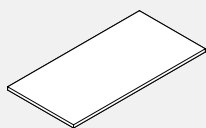

- **Worksurfaces to be used only with Extended 90 Degree Corner Worksurfaces.**
- Rectangular Extension Return Worksurface.
- Specify laminate finish and PVC edge finish.
- Includes 2 flat brackets for connection.
- Specification:
- FTWRE23 to be used with FTWEC23xxxx23.
- FTWRE29 to be used with FTWEC29xxxx29.

PRODUCT CODE	FINISH		SIZE / INCHES			WEIGHT LBS	VOL FT ³
	LP	HP	H	W	D		
FTWRE2324	136	180	1	24	23	16	0.96
FTWRE2330	149	191	1	30	23	20	1.20
FTWRE2336	165	215	1	36	23	25	1.44
FTWRE2924	163	209	1	24	29	21	1.21
FTWRE2930	173	227	1	30	29	26	1.51
FTWRE2936	202	265	1	36	29	31	1.81

FTWTC • 120 Degree Corner Worksurface

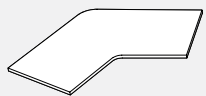

- 120 Degree Corner Worksurface.
- Specify laminate finish and PVC edge finish.
- Specification:
- For tables that connect with 23" deep (A and C) worksurfaces, use FT531F(S/L)24CL standard range or FT531F(S/L)24CL extended range base.
- For table that connect with 29" deep (A and C) worksurfaces, use FT531F(S/L)30CL standard range or FT631F(S/L)30CL extended range.

PRODUCT CODE	FINISH		SIZE / INCHES			WEIGHT LBS	VOL FT ³
	LP	HP	H	W	D		
FTWTC234623	773	1077	1	46	23	165	3.67
FTWTC235223	773	1077	1	52	23	211	4.69
FTWTC235823	1389	1961	1	58	23	263	5.84
FTWTC236423	1389	1961	1	64	23	320	7.11
FTWTC294629	773	1077	1	46	29	165	3.67
FTWTC295229	773	1077	1	52	29	211	4.69
FTWTC295829	1389	1961	1	58	29	263	5.84
FTWTC296429	1389	1961	1	64	29	320	7.10

• LP = Thermally Fused Laminate, HP = High Pressure Laminate.

FTWMR • Media Table Top

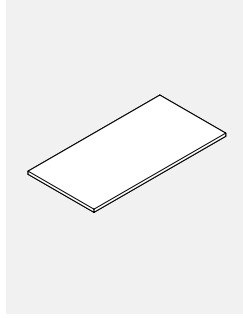

- Media Table Top.
- Specify laminate finish and PVC edge finish.
- Specification:
- For tables FTWMR5a460 and 6060, use FTM5B2BSF standard range or FTM6B2BSF extended range base.
- For all other tables, use FTM5B2BLF standard range or FTM6B2BLF extended range base.

PRODUCT CODE	FINISH LP	HP	SIZE / INCHES			WEIGHT LBS	VOL FT ³
			H	W	D		
FTWMR5460	557	769	1	60	54	96	5.63
FTWMR5466	607	842	1	66	54	106	6.19
FTWMR5472	658	915	1	72	54	115	6.75
FTWMR5478	706	987	1	78	54	125	7.31
FTWMR5484	758	1058	1	84	54	135	7.88
FTWMR5490	807	1131	1	90	54	144	8.44
FTWMR5496	859	1201	1	96	54	154	9.00
FTWMR6060	611	850	1	60	60	107	6.25
FTWMR6066	667	930	1	66	60	118	6.88
FTWMR6072	723	1009	1	72	60	128	7.50
FTWMR6078	778	1088	1	78	60	139	8.13
FTWMR6084	833	1166	1	84	60	150	8.75
FTWMR6090	890	1247	1	90	60	160	9.38
FTWMR6096	944	1327	1	96	60	171	10.00

FTMT5145 • TV Mount

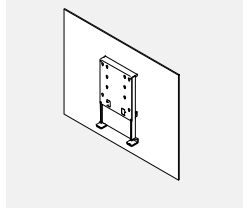

- TV Mount for FreeFit Media Tables.
- Includes the TV/Display bracket and mounting hardware.
- Maximum TV size is 50".
- Back panel is made of PET Felt.

PRODUCT CODE	FINISH LP	SIZE / INCHES			WEIGHT LBS	VOL FT ³
		H	W	D		
FTMT5145	616	40.5	51	4	16.82	4.8

FTB-L • Laminate Leg Shroud for C-Leg, Left

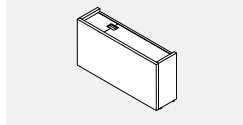

- Laminate shroud for a FreeFit C-Leg on the left side.
- Includes a felt liner at the top.
- Short side panel is removable to access interior.
- Please specify low pressure laminate, PVC edge and felt finishes.

PRODUCT CODE	FINISH LP	SIZE / INCHES			WEIGHT LBS	VOL FT ³
		H	W	D		
FTB23L	495	18	23	9	47	2
FTB29L	518	18	29	9	55	3
FTB35L	540	18	35	9	67	3

FTB-R • Laminate Leg Shroud for C-Leg, Right

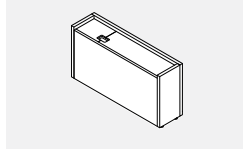

- Laminate housing to cover a FreeFit C-Leg on the right side.
- Includes a felt liner at the top.
- Short side panel is removable to access interior.
- Please specify low pressure laminate, PVC edge and felt finishes.

PRODUCT CODE	FINISH LP	SIZE / INCHES			WEIGHT LBS	VOL FT ³
		H	W	D		
FTB23R	495	18	23	9	47	2
FTB29R	518	18	29	9	55	3
FTB35R	540	18	35	9	67	3

FTB • Laminate Housing for T-Leg

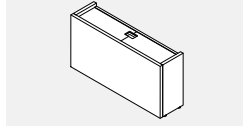

- Laminate housing to cover a FreeFit T-Leg.
- Includes a felt liner at the top.
- Short side panel is removable to access interior.
- Please specify low pressure laminate, PVC edge and felt finishes.

PRODUCT CODE	FINISH LP	SIZE / INCHES			WEIGHT LBS	VOL FT ³
		H	W	D		
FTB23	495	18	23	9	47	2
FTB29	518	18	29	9	55	3
FTB35	540	18	35	9	67	3

FTB • Laminate Leg Shroud for Media Bases

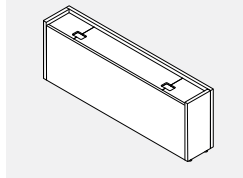

- Includes a felt liner at the top.
- Side panel is removable to access the interior.
- Please specify low pressure laminate, PVC edging and felt finish.

PRODUCT CODE	FINISH LP	SIZE / INCHES			WEIGHT LBS	VOL FT ³
		H	W	D		
FTB54	779	18	54	9	110	5
FTB60	903	18	60	9	134	6

• LP = Thermally Fused Laminate, HP = High Pressure Laminate.

FTCRBFO • Credenza, BF / Open

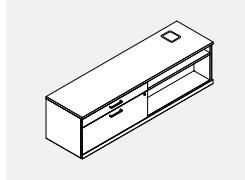

- Credenza storage with grommet to accommodate a FreeFit C leg base.
- Recommended for use with the standard range bases only.
- One lock included
- One adjustable Shelf
- Select any standard Licence2 handle
- Optional E-lock available in the vertical position. Please specify V - Vertical and add \$224.00 list.
- Grommet available only in BLK - Black

PRODUCT CODE	FINISH LP	B	W	SIZE / INCHES			WEIGHT LBS	VOL FT ³
				H(LP/B)	H(W)	D		
FTCRBFO2060	1856	2032	2104	19.94	20.5	60	20	202
FTCRBFO2066	1912	2103	2182	19.94	20.5	66	20	220
FTCRBFO2072	2012	2219	2305	19.94	20.5	72	20	254
FTCRBFO2460	1929	2112	2188	19.94	20.5	60	24	202
FTCRBFO2466	1989	2188	2270	19.94	20.5	66	24	220
FTCRBFO2472	2092	2308	2397	19.94	20.5	72	24	254

FTCROBF • Credenza, Open / BF

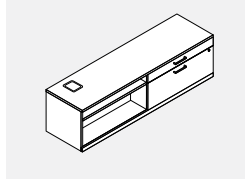

- Credenza storage with grommet to accommodate a FreeFit C leg base.
- Recommended for use with the standard range bases only.
- One lock included
- One adjustable Shelf
- Select any standard Licence2 handle
- Optional E-lock available in the vertical position. Please specify V - Vertical and add \$224.00 list.
- Grommet available only in BLK - Black

PRODUCT CODE	FINISH LP	B	W	SIZE / INCHES			WEIGHT LBS	VOL FT ³
				H(LP/B)	H(W)	D		
FTCROBF2060	1856	2032	2104	19.94	20.5	60	20	202
FTCROBF2066	1912	2103	2182	19.94	20.5	66	20	220
FTCROBF2072	2012	2219	2305	19.94	20.5	72	20	254
FTCROBF2460	1929	2112	2188	19.94	20.5	60	24	202
FTCROBF2466	1989	2188	2270	19.94	20.5	66	24	220
FTCROBF2472	2092	2308	2397	19.94	20.5	72	24	254

FTCRBFO-T • Credenza, BF / Open

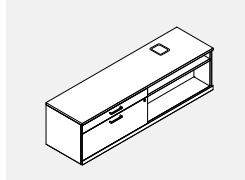

- Credenza storage with grommet to accommodate a FreeFit T-leg base.
- Recommended for use with the standard range bases only.
- One lock included
- One adjustable Shelf
- Select any standard Licence2 handle
- Optional E-lock available in the vertical position. Please specify V - Vertical and add \$224.00 list.
- Grommet available only in BLK - Black

PRODUCT CODE	FINISH LP	B	W	SIZE / INCHES			WEIGHT LBS	VOL FT ³
				H(LP/B)	H(W)	D		
FTCRBFO2060T	1856	2032	2104	19.94	20.5	60	20	202
FTCRBFO2066T	1912	2103	2182	19.94	20.5	66	20	220
FTCRBFO2072T	2012	2219	2305	19.94	20.5	72	20	254
FTCRBFO2460T	1929	2112	2188	19.94	20.5	60	24	202
FTCRBFO2466T	1989	2188	2270	19.94	20.5	66	24	220
FTCRBFO2472T	2092	2308	2397	19.94	20.5	72	24	254

FTCROBF-T • Credenza, Open / BF

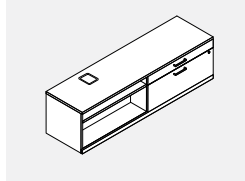

- Credenza storage with grommet to accommodate a FreeFit T-leg base.
- Recommended for use with the standard range bases only.
- One lock included
- One adjustable Shelf
- Select any standard Licence2 handle
- Optional E-lock available in the vertical position. Please specify V - Vertical and add \$224.00 list.
- Grommet available only in BLK - Black

PRODUCT CODE	FINISH LP	B	W	SIZE / INCHES			WEIGHT LBS	VOL FT ³
				H(LP/B)	H(W)	D		
FTCROBF2060T	1856	2032	2104	19.94	20.5	60	20	202
FTCROBF2066T	1912	2103	2182	19.94	20.5	66	20	220
FTCROBF2072T	2012	2219	2305	19.94	20.5	72	20	254
FTCROBF2460T	1929	2112	2188	19.94	20.5	60	24	202
FTCROBF2466T	1989	2188	2270	19.94	20.5	66	24	220
FTCROBF2472T	2092	2308	2397	19.94	20.5	72	24	254

• LP = Thermally Fused Laminate, HP = High Pressure Laminate.

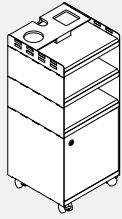
FTSSP12BBFM • Cube Mobile Pedestal, Two Open Boxes, One File Box and Accessory Tray

- Mobile pedestal with two open boxes in the middle, one file box at the bottom and a top accessory tray.
- File box interior dimensions: 11 7/8" h x 11 13/16" w x 10 7/16" d.
- Includes four locking casters, PET felt accessory tray, chrome wire divider and optional lock
- File door lock, if specified is located on the top right corner for the right pedestal and top left corner for the left pedestal.
- Bottom, middle and top shelves, front door and back are made of 3/4" low pressure laminate.
- Sides are made of powder coated metal.
- Ships knocked-down.

PRODUCT CODE	PRICE	SIZE/ INCHES			WEIGHT VOL	
		H	W	D	LBS	FT ³
Without Lock						
FTSSP12BBFMR	568	28	12	12	35	2.33
FTSSP12BBFML	568	28	12	12	35	2.33
With Lock						
FTSSP12BBFMKR	582	28	12	12	35	2.33
FTSSP12BBFMKL	582	28	12	12	35	2.33

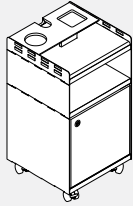
FTSSP12BFMR • Cube Mobile Pedestal, One Open Box, One File Box and Accessory Tray

- Mobile pedestal with one open box in the middle, one file box at the bottom and a top accessory tray.
- File box interior dimensions: 11 7/8" h x 11 13/16" w x 10 7/16" d.
- Includes four locking casters, PET felt accessory tray, chrome wire divider and optional lock
- File door lock, if specified is located on the top right corner for the right pedestal and top left corner for the left pedestal.
- Bottom, middle and top shelves, front door and back are made of 3/4" low pressure laminate.
- Sides are made of powder coated metal.
- Ships knocked-down.

PRODUCT CODE	PRICE	SIZE/ INCHES			WEIGHT VOL	
		H	W	D	LBS	FT ³
Without Lock						
FTSSP12BFMR	447	22	12	12	28	1.83
FTSSP12BFML	447	22	12	12	28	1.83
With Lock						
FTSSP12BFMKR	461	22	12	12	28	1.83
FTSSP12BFMKL	461	22	12	12	28	1.83

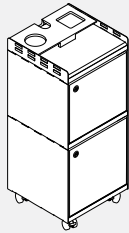
FTSSP12SFM • Cube Mobile Pedestal, One Closed Storage Box, One File Box and Accessory Tray

- Mobile pedestal with one closed storage box at the top, one file box at the bottom and a top accessory tray.
- File box interior dimensions: 11 7/8" h x 11 13/16" w x 10 7/16" d.
- Closed storage box interior dimensions: 10 1/2" h x 11 13/16" w x 10 7/16" d.
- Includes four locking casters, PET felt accessory tray, chrome wire divider and optional lock
- Door locks, if specified are located on the top right corner for the right pedestal and top left corner for the left pedestal of each box.
- Bottom, middle and top shelves, front door and back are made of 3/4" low pressure laminate.
- Sides are made of powder coated metal.
- Ships knocked-down.

PRODUCT CODE	PRICE	SIZE/ INCHES			WEIGHT VOL	
		H	W	D	LBS	FT ³
Without Lock						
FTSSP12SFMR	568	28	12	12	35	2.33
FTSSP12SFML	568	28	12	12	35	2.33
With Lock						
FTSSP12SFMKR	582	28	12	12	35	2.33
FTSSP12SFMKL	582	28	12	12	35	2.33

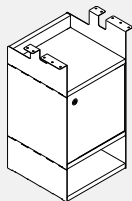
FTSSPH12BFB • Cube Hanging Pedestal, One File Box and Two Open Boxes

- Hanging pedestal with one file box in the middle and two open boxes, one at the top and one at the bottom.
- Attaches to the underside of a worksurface with supplied screws.
- File box interior dimensions: 11 7/8" h x 11 13/16" w x 10 7/16" d.
- Includes chrome wire divider and optional lock.
- Metal wire divider is chrome and sits 3 7/16" from either side and is interchangeable.
- File door lock, if specified is located on the top right corner for the right pedestal and top left corner for the left pedestal.
- Bottom, middle and top shelves, front door and back are made of 3/4" low pressure laminate.
- Sides are made of powder coated metal.
- Ships knocked-down.

PRODUCT CODE	PRICE	SIZE/ H	INCHES			WEIGHT VOL	
			W	D	LBS	FT ³	
Without Lock							
FTSSPH12BFBR	431	24	12	12	26	2.33	
FTSSPH12BFBL	431	24	12	12	26	2.33	
With Lock							
FTSSPH12BFBKR	444	24	12	12	26	2.33	
FTSSPH12BFBKL	444	24	12	12	26	2.33	

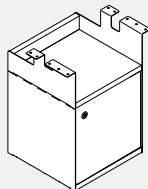
FTSSPH12BF • Cube Hanging Pedestal, One File Box

- Hanging pedestal with one file box at the bottom and one open box at the top.
- Attaches to the underside of a worksurface with supplied screws.
- File box interior dimensions: 11 7/8" h x 11 13/16" w x 10 7/16" d.
- Includes chrome wire divider and optional lock.
- Metal wire divider is chrome and sits 3 7/16" from either side and is interchangeable.
- File door lock, if specified is located on the top right corner for the right pedestal and top left corner for the left pedestal.
- Bottom, middle and top shelves, front door and back are made of 3/4" low pressure laminate.
- Sides are made of powder coated metal.
- Ships knocked-down.

PRODUCT CODE	PRICE	SIZE/ H	INCHES			WEIGHT VOL	
			W	D	LBS	FT ³	
Without Lock							
FTSSPH12BFR	324	18.5	12	12	20	1.83	
FTSSPH12BFL	324	18.5	12	12	20	1.83	
With Lock							
FTSSPH12BFKR	337	18.5	12	12	20	1.83	
FTSSPH12BFKL	337	18.5	12	12	20	1.83	

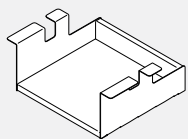
FTSSPH12B • Cube Hanging Pedestal Box

- Hanging pedestal open box.
- Attaches to the underside of a worksurface with supplied screws to create an open box.
- Bottom, middle and top shelves, front door and back are made of 3/4" low pressure laminate.
- Sides are made of powder coated metal.
- Ships knocked-down.

PRODUCT CODE	PRICE	SIZE/ H	INCHES			WEIGHT VOL	
			W	D	LBS	FT ³	
FTSSPH12B	132	6	12	12	6	0.96	

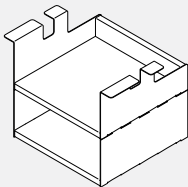
FTSSPH12BB • Cube Hanging Pedestal, Two Open Boxes

- Hanging pedestal with two open boxes.
- Attaches to the underside of a worksurface with supplied screws.
- Bottom, middle and top shelves, front door and back are made of 3/4" low pressure laminate.
- Sides are made of powder coated metal.
- Ships knocked-down.

PRODUCT CODE	PRICE	SIZE/ H	INCHES			WEIGHT VOL	
			W	D	LBS	FT ³	
FTSSPH12BB	244	11.5	12	12	12	1.42	

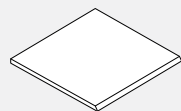
FTFELT03BC • Felt Shelf Liner for Cube Pedestals

- Felt shelf liner can be added to any closed back shelf.
- Front edge is cut at 45 degree.

PRODUCT CODE	PRICE	SIZE/ H	INCHES			WEIGHT VOL	
			W	D	LBS	FT ³	
FTFELT03BC	22	12	12	0.38	0.1	0.03	

BRT8D • Duplex Receptacles

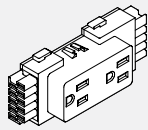

- Snaps into Power Distribution Housing.
- Up to 6 duplex receptacles per circuit.
- xxxD1 = Circuit #1 (utility circuit)
- xxxD2 = Circuit #2 (utility circuit)
- xxxD3 = Circuit #3 (utility circuit)
- xxxDA - Circuit #A (dedicated circuit)
- XW identifies white colour plastic, all others in standard black.

PRODUCT CODE	PRICE	SIZE/ INCHES			WEIGHT VOL	
		H	W	D	LBS	FT ³
BRT8D1	32	2	4.625	1.25	0.10	0.01
BRT8D2	32	2	4.625	1.25	0.10	0.01
BRT8D3	32	2	4.625	1.25	0.10	0.01
BRT8DA	32	2	4.625	1.25	0.10	0.01
BRT8DXW1	47	2	4.625	1.25	0.10	0.01
BRT8DXW2	47	2	4.625	1.25	0.10	0.01
BRT8DXW3	47	2	4.625	1.25	0.10	0.01
BRT8DXWA	47	2	4.625	1.25	0.10	0.01

GAADG • Access Door Module

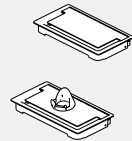

- Soft close door is set back from edge to allow for cable pass thru.
- Available in all standard panel frame finishes.
- GAADGDH includes device holder for most mobile phones or tablets. Holder is only available in white.
- FreeFit can only accomodate one grommet per worksurface.

PRODUCT CODE	PRICE	SIZE/INCHES			WEIGHT LBS	VOL FT ³
		H	D	W		
GAADG	58	1.08	5.54	10.09	2	0.04
GAADGDH	63	1.08	5.54	10.09	2	0.04

GAADCT • Access Door Module with Cable Tray

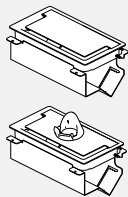

- Soft close door is set back from edge to allow for cable pass thru when closed.
- Cable tray comes one standard telcom knock out and a platform to mount a powerbar.
- Sides are open for easy access.
- Available in all standard panel frame finishes.
- GAADCTDH includes device holder for most mobile phones or tablets. Holder is only available in white.
- FreeFit can only accomodate one grommet per worksurface.

PRODUCT CODE	PRICE	SIZE/INCHES			WEIGHT LBS	VOL FT ³
		H	D	W		
GAADCT	92	5.07	5.54	10.09	4	0.19
GAADCTDH	100	5.07	5.54	10.09	4	0.19

GAADCTPD • Access Door Module with Cable Tray and Power Bar

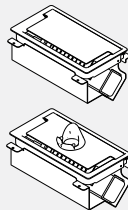

- Powerbar with 3 simplex and 2 USB, CSA Certified.
- Soft close door is set back from edge to allow for cable pass thru when closed.
- Cable tray comes one standard telcom knock out and a platform to mount a powerbar.
- Sides are open for easy access.
- Available in all standard panel frame finishes.
- GAADCTPDDH includes device holder for most mobile phones or tablets. Holder is only available in white.
- FreeFit can only accomodate one grommet per worksurface.

PRODUCT CODE	PRICE	SIZE/INCHES			WEIGHT LBS	VOL FT ³
		H	D	W		
GAADCTPD	202	6.96	5.54	10.09	4	0.20
GAADCTPDDH	206	6.96	5.54	10.09	4	0.20

BWAEGC00158GC • Power Bar with USB

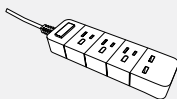

- Power Bar with 3 receptacles + 2 USB and power switch.
- Standard with 6' cord.
- Rating 15A, 125V, AC 60Hz, 1875W.
- USB output 5V, 2.6A (max.)
- White case, white cord.

PRODUCT CODE	PRICE	SIZE/ INCHES			WEIGHT VOL	
		H	W	D	LBS	FT ³
BWAEGC00158GC	99	1.3	2.3	1	1	0.02

BG5 • Rectangular Grommet

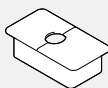

- Option (BLK) Black Plastic (GRY) Grey Plastic (WHT) White Plastic

PRODUCT CODE	PRICE	SIZE/ INCHES			WEIGHT LBS	VOL FT ³
		H	W	D		
BG5	35		3.5	2		

MSPDM • 1 Duplex, 1 Data



- Includes two simplex, one data and one phone connector.
- Black plastic

PRODUCT CODE	PRICE	SIZE/ INCHES			WEIGHT LBS	VOL FT ³
		H	W	D		
MSPDM	276	2.75	6.5	3.5	2	0.1

BWAECF • Ceiling Feed Post

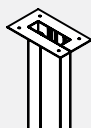

- Ceiling pole brings ceiling feed conduit and data cables from the ceiling down to Power troughs height. Accommodates 9'-3" ceiling heights.
- A two part construction allows power/data conduit lay-in.
- Includes mounting hardware and ceiling bezel.
- Painted finish.

PRODUCT CODE	PRICE	SIZE/INCHES			WEIGHT LBS	VOL FT ³
		H	D	W		
BWAECF	303	99.32	2.5	4.74	13	0.48

BWAECFH • Ceiling Feed Harness



- Ceiling feed provides a single power entry from ceiling, through Ceiling pole into Power Trough, into Power Distribution Housing.
- An 8-wire (4-circuit) metal conduit harness with included metal junction box for hard wiring to the building power supply above ceiling tile.
- Must be hard wired to the building power supply by a licensed electrician.
- Ceiling Pole not included.

PRODUCT CODE	PRICE	SIZE/INCHES			WEIGHT LBS	VOL FT ³
		H	D	W		
BWAECFH120	373	120	6	6.00	5.00	2
BWAECFH144	417	144	6	6.00	6.00	3

FTAEC • Table to Table Connector

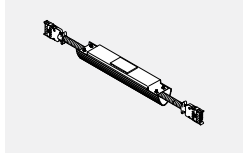

- Connects Freefit back2back legs and trough provide power data/communication pass thru
- Connector kit consist of formed steel housing, mounting brackets,
- Housing to housing harness and one charcoal grey extruded Data/Communication cable manager
- For table to table up to 72" w (with no storage in between tables), use FTAETTC12.
- For table to table 78" w (when no storage in between), use FTAETTC18.
- For table to table 84" w (when no storage in between), use FTAETTC24.
- For table to table up to 72" w with a Pantry Storage is in between, use FTAETTC24.

PRODUCT CODE	PRICE	SIZE/INCHES			WEIGHT LBS	VOL FT ³
		H	D	W		
FTAEC12	259	3	16	2.3	6.00	0.12
FTAEC18	278	3	22	2.3	8.00	0.15
FTAEC24	294	3	28	2.3	9.00	0.18
FTAEC30	310	3	34	2.3	10.60	0.22
FTAEC36	324	3	40	2.3	12.00	0.24
FTAEC42	348	3	46	2.3	11.60	0.28
FTAEC48	372	3	52	2.3	14.00	0.30

FTABRC • Table to Bridges Connector

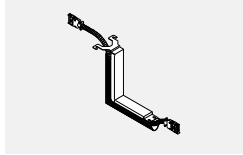

- Connects FreeFit back2back benching to Bridges 29H table with below surface power trough.
- Please specify paint colour on bracket. Wire manager is always charcoal.

PRODUCT CODE	PRICE	SIZE/INCHES			WEIGHT LBS	VOL FT ³
		H	D	W		
FTABRC	219	13	13	2.3	2.4	0.28

FTACCL • Leg Wire Manager

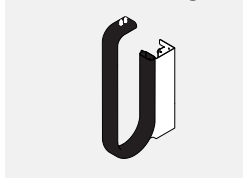

- Provides wire management from under FreeFit worksurface, down the leg and to the floor.
- Can only be used for FreeFit Regular and Media tables. Not for use on FreeFit Back to Back tables.
- Kit includes wire manager housing, magnets, screws and cable chain.
- Magnetically fastens to the Freefit leg and cable chain is screwed to work surface.
- Please specify housing paint finish.

PRODUCT CODE	PRICE	SIZE/INCHES			WEIGHT LBS	VOL FT ³
		H	D	W		
FTACCL	388	16	3.2	2	0.06	0.06

FTAEFF • Floor Feed

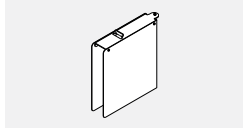

- Floor feed housing for FreeFit benching applications only
- Liquitite whip 72"
- Must be hard wired to power source by a licenced technican
- Please choose paint colour for housing.

PRODUCT CODE	PRICE	SIZE/INCHES			WEIGHT LBS	VOL FT ³
		H	D	W		
FTAEFF	574	10.8	8.75	2	7	0.23

FFTCB • Under Worksurface Cable Basket

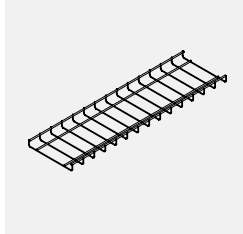

- Shallow 8" wide basket manages cable excess.
- It can be easily unclipped from steel brackets (included) to rearrange cable connections from below work surface.
- As a general rule- specify cable basket 30" shorter that the Freefit work surface.
- Steel wire construction, black painted finish, black steel hanging brackets and fasteners.

PRODUCT CODE	PRICE	SIZE/ INCHES			WEIGHT LBS	VOL FT ³
		H	W	D		
FFTCB36	78	1	8	8	0.36	0.03
FFTCB48	86	1	16	8	0.73	0.07
FFTCB54	90	1	22	8	1.01	0.10
FFTCB60	97	1	28	8	1.20	0.13
FFTCB66	111	1	34	8	1.56	0.15
FFTCB72	114	1	40	8	1.80	0.18
FFTCB78	123	1	46	8	2.16	0.21
FFTCB84	129	1	52	8	2.39	0.24

BRACS • Cable Snake

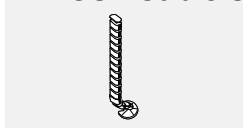

- **Flexible cable management trough.**
- Two pathways within the snake, one for data/communication and one for routing power cables.
- Clear (CLR) available only.

PRODUCT CODE	PRICE	SIZE/ H	INCHES		WEIGHT LBS	VOL FT ³
			W	D		
BRACS	123	30	8	2	3	0.19
BRACSH	207	49	8	2	5	0.27

FTBATT • Battery and Charger

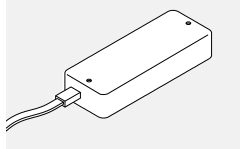

- Battery Pak with charging cable mounts to the underside of the worksurface
- Features LED bars indicating capacity level and audio alarm when it needs to be charged.
- On a full charge the table can cycle from 35 to 45 stroke lengths based upon the range of column selected and load on the table.

PRODUCT CODE	PRICE	SIZE/INCHES			WEIGHT LBS	VOL FT ³
		H	D	W		
FTBATT	859	1.5	8	3	1.54	0.02

FTACDS • Anti Collision Desk Sensor USB Plug

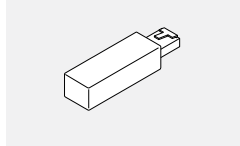

- Provides enhanced anti-collision detection.
- Plugs directly into leg column.
- Only one USB plug required for table assembly.
- This is a replacement part. The sensor ships stand with every table.

PRODUCT CODE	PRICE	SIZE/INCHES			WEIGHT LBS	VOL FT ³
		H	D	W		
FTACDS	72	0.5	2.36	0.6	0.01	0.01

FTDPG1C • Display + Bluetooth + Reminder Controller

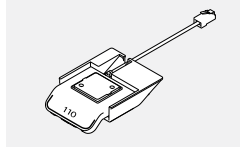

- Up/down drive with 4 memory positions.
- LED Light strip reminder, table height display.
- Bluetooth enabled connects to Desk Control App.

PRODUCT CODE	PRICE	SIZE/INCHES			WEIGHT LBS	VOL FT ³
		H	D	W		
FTDPG1C	166	1	3	4.3	0.4	0.01

FTDPG1M • Memory + Bluetooth + Diode Reminder Controller

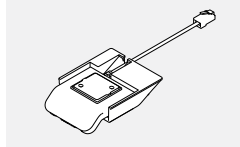

- Up/down drive with 2 memory positions.
- Bluetooth enabled connects to Desk Control App.
- This is a replacement part. Every base comes standard with a controller.

PRODUCT CODE	PRICE	SIZE/INCHES			WEIGHT LBS	VOL FT ³
		H	D	W		
FTDPG1M	66	1	3	4.3	0.4	0.01

FTCD2DUSB • Desk2Device USB Charger

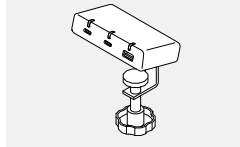

- Charge virtually any USB device directly from your FreeFit desk. Reduce cable clutter and get better power access.
- The charger is powered directly by the control box of a FreeFit table, no additional power outlet is required.
- Features one USB Type-A port (output 7.5w), two USB Type-C ports (output 50w if one port is used, 25w if both are used).
- Housing is white in color and the mounts are in black.
- Can be mounted on top of the table surface or underneath the surface (horizontal or slightly tilted).
- Includes two different mounts and a rubber (silicone) pad to secure placement on a smooth desk surface.
- Low standby power consumption of only 0.1w.
- LED diodes indicate either charging or that an active device is connected.
- PVC-Free (TM).

PRODUCT CODE	PRICE	SIZE/INCHES			WEIGHT LBS	VOL FT ³
		H	D	W		
FTCD2DUSB	422	0.85	3.77	1.96	0.187	0.004

FreeFit • Single Table; 21' high dividers

- FreeFit table mounted dividers for single table or single table row; recessed 6.5" at both ends (for example - 72" (70" actual) FreeFit table mounted divider measures 57").
- The centre of all dividers is always mounted 2.250" from work surface's rear edge. Please note the gap between the divider and the work surface therefore varies, depending on the divider thickness (1.250" framed dividers. 0.750" frame-less LP and 0.250" frame-less glass).
- 48" (33" actual) - 66" (51" actual) dividers have 2 mounting brackets.
- 72" (57" actual) dividers have 3 mounting brackets.

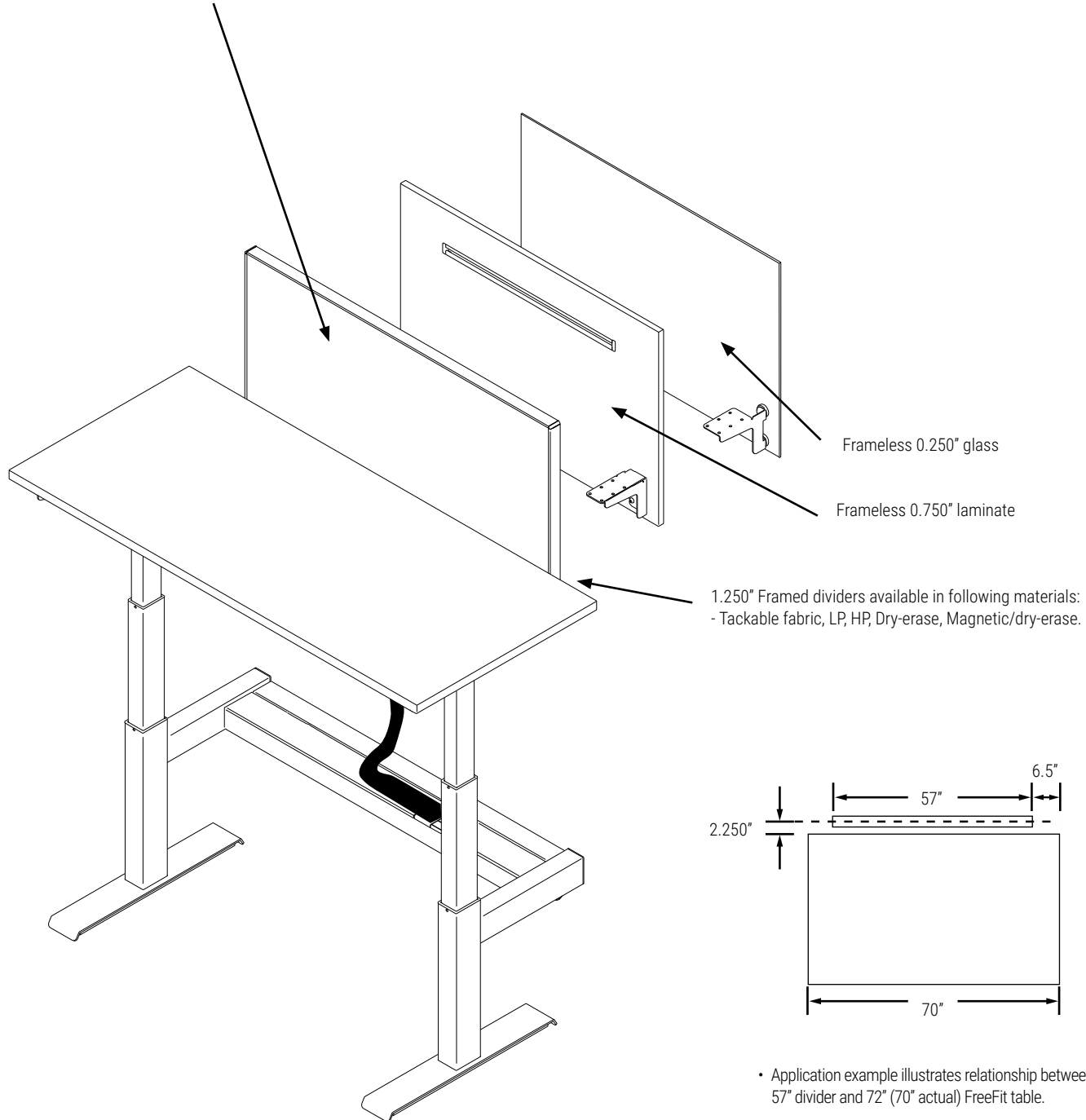

- Application example illustrates relationship between 57" divider and 72" (70" actual) FreeFit table.
- Example Order:
 BWATMFD72
 (actual dimension of 57") for
 BWA2D3072A8
 (actual dimension of 70").

FreeFit • Back 2 Back Table; 37" high dividers

FreeFit Back 2 Back stationary dividers; stationary, shared, secured to table structure; recessed 6.5" at both ends (for example - 72" (70" actual) FreeFit table mounted divider measures 57").

The centre of all dividers is always mounted 2.250" from work surface's rear edge. Please note the gap between the divider and the worksurface therefore varies, depending on the divider thickness (1.250" Framed dividers, 0.750" frame-less LP and 0.250" frame-less glass).

- 48" (33" actual) divider for 48" (46" actual) table
- 54" (39" actual) divider for 54" (52" actual) table
- 60" (45" actual) divider for 60" (58" actual) table
- 66" (51" actual) divider for 66" (64" actual) table
- 72" (57" actual) divider for 72" (70" actual) table

- Framed dividers (Tackable fabric, LP, HP, Dryerase, Magnetic/dry-erase.
- Frameless LP
- Frameless glass

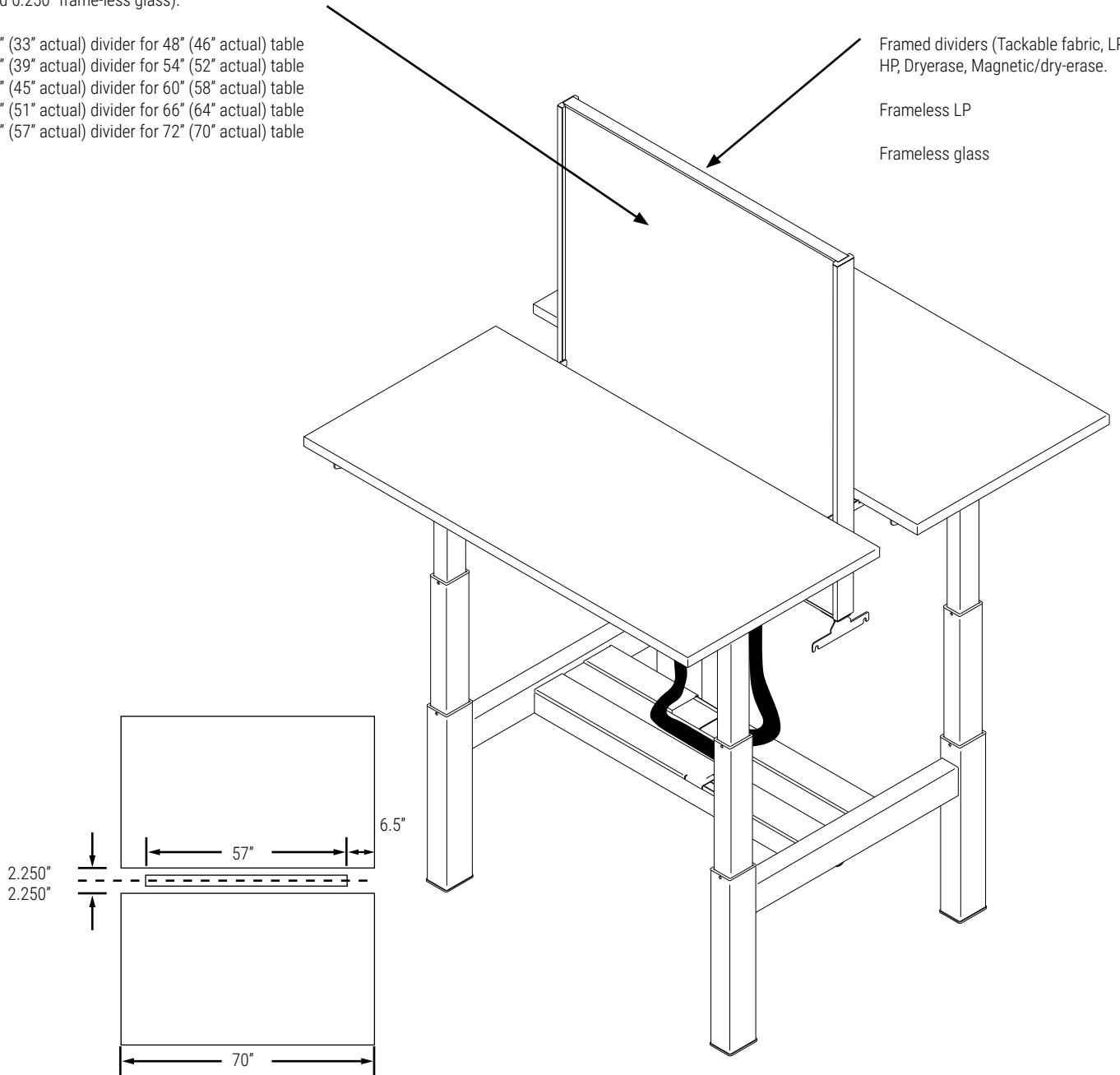

Application example illustrates relationship between 57" shared divider and 72" (70" actual) FreeFit Back 2 Back table.

- Example Order:
 BWASFD72
 (actual dimension of 57") for
 BWA2D6072A8
 (actual dimension of 70").

BWATMFD/BWATMLD • Table Mounted Framed Dividers

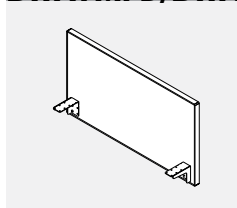

- **Connects parallel on Freefit single and back 2 back tables.**
- Divider frame and connecting hardware is painted, please choose from standard metal paint finishes.
- Fabric divider is tackable.
- Divider infill can be specified in fabric, low pressure laminate (LP), high pressure laminate (HP), dry erase whiteboard (DE) or dry erase magnetic whiteboard (DM) user side only.
- Fastens to the underside of the worksurface
- 1.625" gap between worksurface and divider allows for cable pass thru
- Installed divider measures 15.7" from top of worksurface and 5.75" below the worksurface.
- 48" to 66" dividers include 2 support brackets. 72" divider includes 3 support brackets.
- When dry erase magnetic whiteboard (DM) is specified it is applied user side ONLY and dry erase whiteboard (DE) is applied on the opposite side

TACKABLE FABRIC PRODUCT CODE	PRICE		SIZE/ INCHES			WEIGHT LBS	VOL FT ³
	GR1	GR2	H	W	D		
BWATMFD48	323	359	21.5	33	1.25	16	1.23
BWATMFD54	347	381	21.5	39	1.25	18	1.46
BWATMFD60	377	419	21.5	45	1.25	20	1.68
BWATMFD66	421	469	21.5	51	1.25	22	1.90
BWATMFD72	464	512	21.5	57	1.25	26	2.13

LAMINATE PRODUCT CODE	PRICE					SIZE/ INCHES			WEIGHT LBS	VOL FT ³
	LP	HP	DE	DM	H	W	D			
BWATMLD48	202	320	480	626	21.5	33	1.25	35	1.23	
BWATMLD54	230	381	574	763	21.5	39	1.25	39	1.46	
BWATMLD60	271	431	636	840	21.5	45	1.25	44	1.68	
BWATMLD66	311	535	1075	1442	21.5	51	1.25	48	1.90	
BWATMLD72	340	563	1097	1463	21.5	57	1.25	52	2.13	

BWASFD/BWASLD • Stationary Framed Dividers

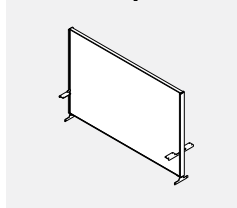

- **Provides a stationary framed divider between back 2 back height adjustable tables**
- Divider frame and connecting hardware is painted, please choose from standard metal paint finishes.
- Fabric divider is tackable.
- Divider infill can be specified in fabric, low pressure laminate (LP), high pressure laminate (HP), dry erase whiteboard (DE) or dry erase magnetic whiteboard (DM).
- Divider is anchored to the base and captured between two aluminum upright tracks. The uprights have sliding brackets that connect the worksurfaces to the divider providing continuous support as it travels up and down.
- 1.625" gap between worksurface and divider allows for cable pass thru
- Installed divider measures 54" from floor.

TACKABLE FABRIC PRODUCT CODE	PRICE		SIZE/ INCHES			WEIGHT LBS	VOL FT ³
	GR1	GR2	H	W	D		
BWASFD48	641	675	37.2	33	2	25	2.13
BWASFD54	658	691	37.2	39	2	28	2.52
BWASFD60	672	713	37.2	45	2	31	2.91
BWASFD66	711	758	37.2	51	2	34	3.29
BWASFD72	921	968	37.2	57	2	37	3.68

LAMINATE PRODUCT CODE	PRICE					SIZE/ INCHES			WEIGHT LBS	VOL FT ³
	LP	HP	DE	DM	H	W	D			
BWASLD48	556	860	1250	2375	37.2	33	2	58	2.13	
BWASLD54	598	928	1329	2512	37.2	39	2	66	2.52	
BWASLD60	613	943	1343	2527	37.2	45	2	73	2.91	
BWASLD66	646	1013	2239	4488	37.2	51	2	81	3.29	
BWASLD72	840	1388	2375	4740	37.2	57	2	88	3.68	

BWATMLLD • Table Mounted Laminate Dividers

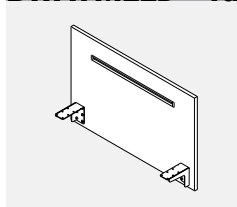

- **Connects parallel on Freefit single and back 2 back tables.**
- Laminate divider with integrated accessory rail, installed one side only.
- Integrated anodized aluminum accessory rail, white cut out and rail trims; white powder coat brackets.
- 3/4" LP PVC edged boards, please specify laminate & 3mm PVC edge.
- Fastens to the underside of the worksurface.
- 1.88 gap between worksurface and divider allows for cable pass thru.
- Installed divider measures 15.7" from top of worksurface and 5.75" below the worksurface.
- 48" to 66" dividers include 2 support brackets. 72" divider includes 3 support brackets.

LAMINATE PRODUCT CODE	PRICE	SIZE/ INCHES			WEIGHT LBS	VOL FT ³
		H	W	D		
BWATMLLD48	242	21.5	33	0.75	16	1.23
BWATMLLD54	257	21.5	39	0.75	19	1.46
BWATMLLD60	272	21.5	45	0.75	21	1.68
BWATMLLD66	404	21.5	51	0.75	24	1.90
BWATMLLD72	418	21.5	57	0.75	27	2.13

BWASLLD • Stationary Laminate Dividers

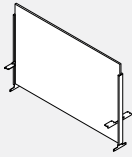

- Provides a stationary laminate divider between back 2 back height adjustable tables
- Divider uprights and connecting hardware is painted, please choose from standard metal paint finishes.
- Please specify laminate (LP) finish.
- Divider is anchored to the base and captured between two aluminum upright tracks. The uprights have sliding brackets that connect the worksurfaces to the divider providing continuous support as it travels up and down.
- 1.88" gap between worksurface and divider allows for cable pass thru.
- Installed divider measures 54" from floor.

LAMINATE PRODUCT CODE	PRICE	SIZE/ INCHES			WEIGHT LBS	VOL FT ³
		H	W	D		
BWASLLD48	493	37.2	33	2	28	2.13
BWASLLD54	507	37.2	39	2	33	2.52
BWASLLD60	523	37.2	45	2	37	2.91
BWASLLD66	792	37.2	51	2	41	3.29
BWASLLD72	805	37.2	57	2	46	3.68

BWATMGD • Table Mounted Glass Dividers

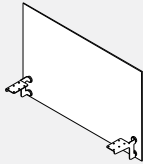

- Frameless glass divider connects parallel on single and back 2 back tables.
- Tempered glass, acid etched on one side (similar to frosted), satin chrome disc fasteners and powder coated steel support brackets.
- Fastens to the underside of the worksurface.
- 2.13 gap between worksurface and divider allows for cable pass thru.
- Installed divider measures 15.7" from top of worksurface and 4.75" below the worksurface.
- 54" to 66" dividers include 2 support brackets. 72" divider includes 3 support brackets.
- 1/2" radius on all four corners.

GLASS PRODUCT CODE	PRICE	SIZE/ INCHES			WEIGHT LBS	VOL FT ³
		H	W	D		
BWATMGD48	521	21.5	33	0.25	16	1.23
BWATMGD54	561	21.5	39	0.25	19	1.46
BWATMGD60	601	21.5	45	0.25	22	1.68
BWATMGD66	637	21.5	51	0.25	24	1.90
BWATMGD72	677	21.5	57	0.25	28	2.13

BWASGD • Stationary Glass Dividers

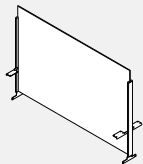

- Provides a stationary glass divider between back 2 back height adjustable tables.
- Tempered glass, acid etched on one side (similar to frosted), satin chrome disc fasteners and white powdercoated steel support brackets.
- Divider is anchored to the base and captured between two aluminum upright tracks. The uprights have sliding brackets that connect the worksurfaces to the divider providing continuous support as it travels up and down.
- 2.13 gap between worksurface and divider allows for cable pass thru.
- 1/2" radius on top two corners.

GLASS PRODUCT CODE	PRICE	SIZE/ INCHES			WEIGHT LBS	VOL FT ³
		H	W	D		
BWASGD48	462	37.2	33	2	30	2.13
BWASGD54	526	37.2	39	2	34	2.52
BWASGD60	596	37.2	45	2	39	2.91
BWASGD66	660	37.2	51	2	43	3.29
BWASGD72	725	37.2	57	2	48	3.68

BWAFWR • Felt Wrap Around Divider for FreeFit Table

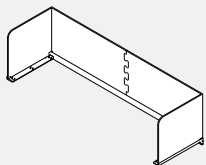

Single

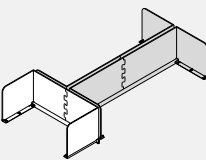

End of Run

- Wraps around FreeFit table to provide privacy.
- 9mm Felt material is tackable and comes in 18 different colours. Please specify colour.
- Installed divider measures 15.7" high from top of the work-surface.
- Please choose standard metal finish for extrusion and brackets.
- Upcharge of \$83 for anodized extrusion option.
- Divider extends by 1.5" at the back.
- For sizes 2346, 2351 and 2352, the felt will be manufactured in one piece, while all others will be manufactured in two pieces as shown.
- Note: Cannot use ceiling feed option with this divider.

PRODUCT CODE	PRICE	SIZE/ INCHES			WEIGHT LBS	VOL FT ³
		H	W	D		
BWAFWR2346	381	18.24	46.84	18.46	26.58	1.07
BWAFWR2352	404	18.24	52.84	18.46	28.40	1.21
BWAFWR2358	425	18.24	58.84	18.46	30.22	1.34
BWAFWR2364	563	18.24	64.84	18.46	32.02	0.74
BWAFWR2370	600	18.24	70.84	18.46	33.84	0.81
BWAFWR2946	431	18.24	46.84	24.46	30.74	1.07
BWAFWR2952	570	18.24	52.84	24.46	32.55	0.60
BWAFWR2958	607	18.24	58.84	24.46	34.37	0.67
BWAFWR2964	642	18.24	64.84	24.46	36.19	0.74
BWAFWR2970	683	18.24	70.84	24.46	38.00	0.81
End of Run						
BWAFWR2351	386	18.24	51.34	27.94	27.94	1.05
BWAFWR2951	569	18.24	51.34	32.09	32.09	0.62
BWAFWR2363	562	18.24	63.34	31.57	31.57	1.50
BWAFWR2963	641	18.24	63.34	35.73	35.73	0.87

BWAFPN • Parallel Felt Divider

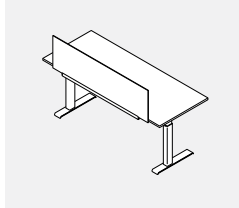

- Felt divider connects parallel on a single or Back to Back FreeFit table.
- 9 mm felt material is tackable and comes in a wide range of colours.
- Installed, the divider measures 15.7" high from the top of the worksurface.
- Kit includes felt divider, support extrusion and left and right brackets.
- Please choose the finish of the felt and the metal finish for the extrusion and brackets.

PRODUCT CODE	PRICE	SIZE/INCHES			WEIGHT LBS	VOL FT ³
		H	W	D		
BWAFPN36	132	18.24	21	5.86	2.21	1.30
BWAFPN42	148	18.24	27	5.86	2.77	1.67
BWAFPN48	202	18.24	33	5.86	2.82	2.04
BWAFPN54	227	18.24	39	5.86	3.29	2.41
BWAFPN60	256	18.24	45	5.86	3.75	2.78
BWAFPN66	361	18.24	51	5.86	4.22	3.15
BWAFPN72	385	18.24	57	5.86	4.69	3.53

BWAFMPSN • Modesty Felt Divider

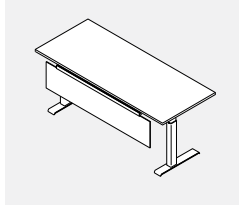

- Felt modesty panel secures to the rear bottom of a regular FreeFit table and provides privacy below the worksurface.
- 9 mm felt material is tackable and comes in a wide range of colours.
- Installed, the divider measures 15" high below the top of the worksurface.
- Kit includes felt modesty, support extrusion and left and right brackets.
- Please choose the finish of the felt and the metal finish for the extrusion and brackets.

PRODUCT CODE	PRICE	SIZE/INCHES			WEIGHT LBS	VOL FT ³
		H	W	D		
BWAFMPSN36	124	13.94	21	4.17	1.84	0.71
BWAFMPSN42	135	13.94	27	4.17	2.32	0.91
BWAFMPSN48	189	13.94	33	4.17	2.44	1.11
BWAFMPSN54	211	13.94	39	4.17	2.86	1.31
BWAFMPSN60	239	13.94	45	4.17	3.27	1.51
BWAFMPSN66	337	13.94	51	4.17	3.68	1.72
BWAFMPSN72	359	13.94	57	4.17	4.09	1.92

BWAFPDN • Parallel Above & Below Felt Divider

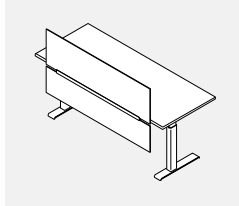

- Felt divider and modesty panel kit secures to the rear bottom of a regular FreeFit table and provides privacy above and below the worksurface.
- 9 mm felt material is tackable and comes in a wide range of colours.
- Installed, the divider measures 15.7 high from the top of the work-surface and 15" high below the top of the worksurface.
- Kit includes two felt dividers, support extrusion and left and right brackets.
- Please choose the finish of the felt and the metal finish for the extrusion and brackets.

PRODUCT CODE	PRICE	SIZE/INCHES			WEIGHT LBS	VOL FT ³
		H	W	D		
BWAFPDN36	195	30.68	21	5.86	2.79	2.18
BWAFPDN42	213	30.68	27	5.86	3.56	2.81
BWAFPDN48	303	30.68	33	5.86	3.82	3.43
BWAFPDN54	336	30.68	39	5.86	4.5	4.06
BWAFPDN60	393	30.68	45	5.86	5.17	4.68
BWAFPDN66	600	30.68	51	5.86	5.85	5.31
BWAFPDN72	637	30.68	57	5.86	6.53	5.93

BWAFFC • Corner Wrap Felt Divider

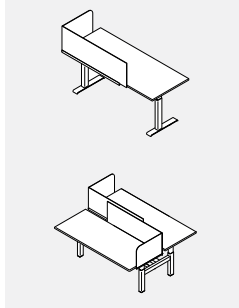

- Felt Corner Wrap secures to the side and rear bottom of a FreeFit table, wraps around one side and provides limited privacy.
- 9 mm felt material is tackable and comes in a wide range of colours.
- Installed, the divider measures 15.7 high from the top of the worksurface..
- Kit includes felt dividers, support extrusion and large and small handed brackets.
- Please choose the finish of the felt and the metal finish for the extrusion and brackets.

PRODUCT CODE	PRICE	SIZE/INCHES			WEIGHT LBS	VOL FT ³
		H	W	D		
BWAFFC2432L	275	18.24	32.46	18.52	4.99	6.35
BWAFFC2432R	275	18.24	32.46	18.52	4.99	6.35
BWAFFC2438L	314	18.24	38.46	18.52	5.46	7.52
BWAFFC2438R	314	18.24	38.46	18.52	5.46	7.52
BWAFFC2448L	337	18.24	47.46	18.52	6.16	9.28
BWAFFC2448R	337	18.24	47.46	18.52	6.16	9.28
BWAFFC3032L	310	18.24	32.46	24.52	5.72	8.40
BWAFFC3032R	310	18.24	32.46	24.52	5.72	8.40
BWAFFC3038L	333	18.24	38.46	24.52	6.19	9.95
BWAFFC3038R	333	18.24	38.46	24.52	6.19	9.95
BWAFFC3048L	358	18.24	47.46	24.52	6.89	12.28
BWAFFC3048R	358	18.24	47.46	24.52	6.89	12.28

FFTDH-H24 • Height Adjustable Table Polycarbonate Divider Screen Kit, 24" high

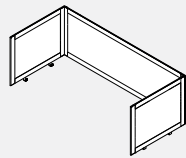

- Provides privacy in an open plan environment.
- Lightweight and easy to clean table mounted partitions.
- Consists of a powder coated aluminum frame, translucent fluted polycarbonate and all hardware to connect. Brackets are painted steel.
- Side dividers extend 6.237" from the front edge of each surface.
- Back divider extends over the back edge of the worksurface by 1 1/2" allowing for the passage of cables to the trough.
- FFTDP24xxH24 are for 23" deep surfaces and FFTD-P30xxH24 are for 29" deep surfaces.
- Width and depth are nominal sizes representing the sizes of the FreeFit Table. Allow for 1/4" overhang at the sides, 1 1/2" at the back and 6.237" at the front.
- Please choose any standard paint finish for frame and hardware. End trim cap is available only in CHR - charcoal.

PRODUCT CODE	PRICE	SIZE/ INCHES			WEIGHT LBS	VOL FT ³
		H	W	D		
FFTDH2436H24	738	24.63	34	31.75	26.55	3.94
FFTDH2442H24	761	24.63	40	31.75	28.10	4.59
FFTDH2448H24	783	24.63	46	31.75	29.65	5.25
FFTDH2454H24	805	24.63	42	31.75	31.20	5.91
FFTDH2460H24	828	24.63	58	31.75	32.75	6.56
FFTDH2466H24	850	24.63	60	31.75	34.30	7.22
FFTDH2472H24	871	24.63	70	31.75	35.85	7.88
FFTDH2478H24	894	24.63	76	31.75	37.40	8.53
FFTDH2484H24	919	24.63	82	31.75	38.95	9.19
FFTDH3036H24	792	24.63	34	37.75	40.50	4.72
FFTDH3042H24	815	24.63	40	37.75	42.05	5.51
FFTDH3048H24	837	24.63	46	37.75	43.60	6.29
FFTDH3054H24	859	24.63	42	37.75	45.15	7.08
FFTDH3060H24	881	24.63	58	37.75	46.70	7.87
FFTDH3066H24	903	24.63	60	37.75	48.25	8.65
FFTDH3072H24	926	24.63	70	37.75	49.80	9.44
FFTDH3078H24	948	24.63	76	37.75	51.35	10.22
FFTDH3084H24	970	24.63	82	37.75	52.90	11.01

FFTDH-H30 • Height Adjustable Table Polycarbonate Divider Screen Kit, 30" high

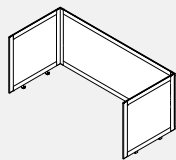

- Provides privacy in an open plan environment.
- Lightweight and easy to clean table mounted partitions.
- Consists of a powder coated aluminum frame, translucent fluted polycarbonate and all hardware to connect. Brackets are painted steel.
- Side dividers extend 6.237" from the front edge of each surface.
- Back divider extends over the back edge of the worksurface by 1 1/2" allowing for the passage of cables to the trough.
- FFTDP24xxH24 are for 23" deep surfaces and FFTD-P30xxH24 are for 29" deep surfaces.
- Width and depth are nominal sizes representing the sizes of the FreeFit Table. Allow for 1/4" overhang at the sides, 1 1/2" at the back and 6.237" at the front.
- Please choose any standard paint finish for frame and hardware. End trim cap is available only in CHR - charcoal.

PRODUCT CODE	PRICE	SIZE/ INCHES			WEIGHT LBS	VOL FT ³
		H	W	D		
FFTDH3036H30	828	30.63	34	31.75	26.55	3.94
FFTDH3042H30	856	30.63	40	31.75	28.10	4.59
FFTDH3048H30	881	30.63	46	31.75	29.65	5.25
FFTDH3054H30	905	30.63	42	31.75	31.20	5.91
FFTDH3060H30	932	30.63	58	31.75	32.75	6.56
FFTDH3066H30	957	30.63	60	31.75	34.30	7.22
FFTDH3072H30	985	30.63	70	31.75	35.85	7.88
FFTDH3078H30	1009	30.63	76	31.75	37.40	8.53
FFTDH3084H30	1034	30.63	82	31.75	38.95	9.19
FFTDH3036H30	879	30.63	34	37.75	40.50	4.72
FFTDH3042H30	905	30.63	40	37.75	42.05	5.51
FFTDH3048H30	931	30.63	46	37.75	43.60	6.29
FFTDH3054H30	956	30.63	42	37.75	45.15	7.08
FFTDH3060H30	983	30.63	58	37.75	46.70	7.87
FFTDH3066H30	1008	30.63	60	37.75	48.25	8.65
FFTDH3072H30	1033	30.63	70	37.75	49.80	9.44
FFTDH3078H30	1059	30.63	76	37.75	51.35	10.22
FFTDH3084H30	1085	30.63	82	37.75	52.90	11.01

FFTDG-H24 • Height Adjustable Table Glass Divider Screen Kit, 24" high

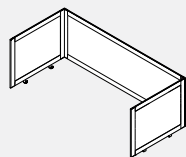

- Provides privacy in an open plan environment.
- Easy to clean table mounted partitions.
- Consists of a powder coated aluminum frame, 4mm clear (CLR) glass and all hardware to connect. Brackets are painted steel.
- Side dividers extend 6.237" from the front edge of each surface.
- Back divider extends over the back edge of the worksurface by 1 1/2" allowing for the passage of cables to the trough.
- FFTDG24xxH24 are for 23" deep surfaces and FFTD-G30xxH24 are for 29" deep surfaces.
- Width and depth are nominal sizes representing the sizes of the FreeFit Table. Allow for 1/4" overhang at the sides, 1 1/2" at the back and 6.237" at the front.
- Please choose any standard paint finish for frame and hardware. End trim cap is available only in CHR - charcoal.
- Upcharge for frosted (FRST) glass is 20%.

PRODUCT CODE	PRICE	SIZE/ INCHES			WEIGHT LBS	VOL FT ³
		H	W	D		
FFTDG2436H24	994	24.60	34	31.50	26.55	3.94
FFTDG2442H24	1029	24.60	40	31.50	28.10	4.59
FFTDG2448H24	1059	24.60	46	31.50	29.65	5.25
FFTDG2454H24	1093	24.60	42	31.50	31.20	5.91
FFTDG2460H24	1125	24.60	58	31.50	32.75	6.56
FFTDG2466H24	1158	24.60	60	31.50	34.30	7.22
FFTDG2472H24	1190	24.60	70	31.50	35.85	7.88
FFTDG2478H24	1223	24.60	76	31.50	37.40	8.53
FFTDG2484H24	1256	24.60	82	31.50	38.95	9.19
FFTDG3036H24	1057	24.60	34	37.75	40.50	4.72
FFTDG3042H24	1089	24.60	40	37.75	42.05	5.51
FFTDG3048H24	1122	24.60	46	37.75	43.60	6.29
FFTDG3054H24	1156	24.60	42	37.75	45.15	7.08
FFTDG3060H24	1187	24.60	58	37.75	46.70	7.87
FFTDG3066H24	1221	24.60	60	37.75	48.25	8.65
FFTDG3072H24	1253	24.60	70	37.75	49.80	9.44
FFTDG3078H24	1286	24.60	76	37.75	51.35	10.22
FFTDG3084H24	1318	24.60	82	37.75	52.90	11.01

FFTDG-H30 • Height Adjustable Table Glass Divider Screen Kit, 30" high

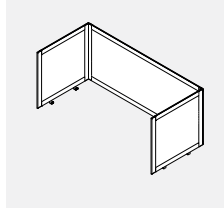

- Provides privacy in an open plan environment.
- Easy to clean table mounted partitions.
- Consists of a powder coated aluminum frame, 4mm clear (CLR) glass and all hardware to connect. Brackets are painted steel.
- Side dividers extend 6.237" from the front edge of each surface.
- Back divider extends over the back edge of the worksurface by 1 1/2" allowing for the passage of cables to the trough.
- FTFDG24xxH30 are for 23" deep surfaces and FTFDG30xxH30 are for 29" deep surfaces.
- Width and depth are nominal sizes representing the sizes of the FreeFit Table. Allow for 1/4" overhang at the sides, 1 1/2" at the back and 6.237" at the front.
- Please choose any standard paint finish for frame and hardware. End trim cap is available only in CHR - charcoal.
- Upcharge for frosted (FRST) glass is 20%.

PRODUCT CODE	PRICE	SIZE/ INCHES			WEIGHT		VOL FT ³
		H	W	D	LBS		
FFTDG2436H30	1042	30.60	34	31.50	28.85	3.94	
FFTDG2442H30	1075	30.60	40	31.50	30.40	4.59	
FFTDG2448H30	1110	30.60	46	31.50	31.95	5.25	
FFTDG2454H30	1143	30.60	42	31.50	33.50	5.91	
FFTDG2460H30	1176	30.60	58	31.50	35.05	6.56	
FFTDG2466H30	1210	30.60	60	31.50	36.60	7.22	
FFTDG2472H30	1230	30.60	70	31.50	38.15	7.88	
FFTDG2478H30	1279	30.60	76	31.50	39.70	8.53	
FFTDG2484H30	1312	30.60	82	31.50	41.25	9.19	
FFTDG3036H30	1109	30.60	34	37.75	42.80	4.72	
FFTDG3042H30	1141	30.60	40	37.75	44.35	5.51	
FFTDG3048H30	1176	30.60	46	37.75	45.90	6.29	
FFTDG3054H30	1209	30.60	42	37.75	47.45	7.08	
FFTDG3060H30	1242	30.60	58	37.75	49.00	7.87	
FFTDG3066H30	1277	30.60	60	37.75	50.55	8.65	
FFTDG3072H30	1297	30.60	70	37.75	52.10	9.44	
FFTDG3078H30	1345	30.60	76	37.75	53.65	10.22	
FFTDG3084H30	1378	30.60	82	37.75	55.20	11.01	

FFTDF-H24 • Height Adjustable Table Felt Divider Screen Kit, 24" high

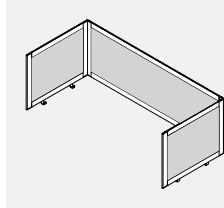

- Provides privacy in an open plan environment.
- Consists of a powder coated aluminum frame, 9mm felt and all hardware to connect. Brackets are painted steel.
- Side dividers extend 6.237" from the front edge of each surface.
- Back divider extends over the back edge of the worksurface by 1 1/2" allowing for the passage of cables to the trough.
- FFTDF24xxH24 are for 23" deep surfaces and FFTDF30xxH24 are for 29" deep surfaces.
- Width and depth are nominal sizes representing the sizes of the FreeFit Table. Allow for 1/4" overhang at the sides, 1 1/2" at the back and 6.237" at the front.
- Please choose any standard paint finish for frame and hardware. Select also a felt finish. End trim cap is available only in CHR - charcoal.
- 9mm felt material is tackable and comes in a variety of colors.

PRODUCT CODE	PRICE	SIZE/INCHES			WEIGHT		VOL FT ³
		H	W	D	LBS		
FFTDF2436H24	647	24.60	34	31.50	22.55	3.94	
FFTDF2442H24	663	24.60	40	31.50	24.10	4.59	
FFTDF2448H24	681	24.60	46	31.50	25.65	5.25	
FFTDF2454H24	699	24.60	42	31.50	27.20	5.91	
FFTDF2460H24	716	24.60	58	31.50	28.75	6.56	
FFTDF2466H24	735	24.60	60	31.50	30.30	7.22	
FFTDF2472H24	751	24.60	70	31.50	31.85	7.80	
FFTDF2478H24	767	24.60	76	31.50	33.40	8.53	
FFTDF2484H24	802	24.60	82	31.50	34.95	9.19	
FFTDF3036H24	669	24.60	34	37.75	36.50	4.72	
FFTDF3042H24	688	24.60	40	37.75	38.05	5.51	
FFTDF3048H24	703	24.60	46	37.75	39.60	6.29	
FFTDF3054H24	722	24.60	42	37.75	41.15	7.08	
FFTDF3060H24	738	24.60	58	37.75	41.70	7.87	
FFTDF3066H24	756	24.60	60	37.75	44.25	8.65	
FFTDF3072H24	773	24.60	70	37.75	45.80	9.44	
FFTDF3078H24	790	24.60	76	37.75	47.35	10.22	
FFTDF3084H24	825	24.60	82	37.75	48.90	11.01	

FFTDF-H30 • Height Adjustable Table Felt Divider Screen Kit, 30" high

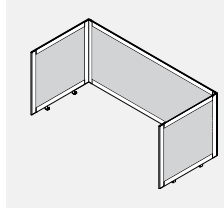

- Provides privacy in an open plan environment.
- Consists of a powder coated aluminum frame, 9mm felt and all hardware to connect. Brackets are painted steel.
- Side dividers extend 6.237" from the front edge of each surface.
- Back divider extends over the back edge of the worksurface by 1 1/2" allowing for the passage of cables to the trough.
- FFTDF24xxH30 are for 23" deep surfaces and FFTDF30xxH30 are for 29" deep surfaces.
- Width and depth are nominal sizes representing the sizes of the FreeFit Table. Allow for 1/4" overhang at the sides, 1 1/2" at the back and 6.237" at the front.
- Please choose any standard paint finish for frame and hardware. Select also a felt finish. End trim cap is available only in CHR - charcoal.
- 9mm felt material is tackable and comes in a variety of colors.

PRODUCT CODE	PRICE	SIZE/INCHES			WEIGHT		VOL FT ³
		H	W	D	LBS		
FFTDF2436H30	641	30.60	34	31.50	24.85	3.94	
FFTDF2442H30	659	30.60	40	31.50	26.40	4.59	
FFTDF2448H30	674	30.60	46	31.50	27.95	5.25	
FFTDF2454H30	691	30.60	42	31.50	29.50	5.91	
FFTDF2460H30	705	30.60	58	31.50	31.05	6.56	
FFTDF2466H30	723	30.60	60	31.50	32.60	7.22	
FFTDF2472H30	738	30.60	70	31.50	34.15	7.88	
FFTDF2478H30	755	30.60	76	31.50	35.70	8.53	
FFTDF2484H30	793	30.60	82	31.50	37.25	9.19	
FFTDF3036H30	673	30.60	34	37.75	38.80	4.72	
FFTDF3042H30	690	30.60	40	37.75	40.35	5.51	
FFTDF3048H30	704	30.60	46	37.75	41.90	6.29	
FFTDF3054H30	722	30.60	42	37.75	43.45	7.08	
FFTDF3060H30	738	30.60	58	37.75	45.00	7.87	
FFTDF3066H30	755	30.60	60	37.75	46.55	8.65	
FFTDF3072H30	769	30.60	70	37.75	48.10	9.44	
FFTDF3078H30	787	30.60	76	37.75	49.65	10.22	
FFTDF3084H30	824	30.60	82	37.75	51.20	11.01	

FTATB • Boulevard Connector Kit

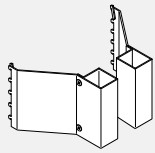

- FreeFit to Boulevard kit secures FreeFit height adjustable freestanding tables to parallel Boulevard panels.
- It provides panel/table alignment, preventing moving parts from rubbing against panel vertical surfaces and maintains 1" clearance around table surface perimeter.
- Standard metal finishes.
- All hardware included.
- Sold as a pair.
- Note: - Kit connects to C style base only.

PRODUCT CODE	PRICE	SIZE/INCHES			WEIGHT VOL	
		H	W	D	LBS	FT ³
FTATB	140	10	6.5	10	7.00	0.50

FTAEG • Back to Back End Gable

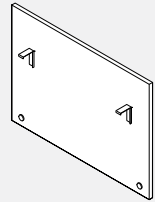

- Optional Back to Back Freefit End Gable is intended to be installed at the end of Freefit Back to Back table run.
- Made out of 3/4" PL Laminate, it enhances Freefit table assembly aesthetics by reducing number of visible elements below work surface.
- Two heights available.
- The End Gable connects to Freefit H-frame crossbar; compatible with Floor Feed.
- Please specify LP finish.
- Please specify paint finish for the brackets.

PRODUCT CODE	PRICE	SIZE/INCHES			WEIGHT LBS	VOL FT ³
		H	D	W		
FTAEG18H	311	18	30	0.75	10.00	0.24
FTAEG22H	337	23	30	0.75	13.00	0.30

FTACPU • CPU Holder

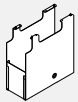

- Accepts tower CPU's with a width range from 7.6" to 2.25" and a maximum height of 18"
- Durable sheet metal construction
- Please specify paint finish.

PRODUCT CODE	PRICE	SIZE/INCHES			WEIGHT LBS	VOL FT ³
		H	D	W		
FTACPU	281	21	21	8	3.57	2.04

BRTLCS • Locking Caster for Rectangular Leg Tables



- Locking Caster for Rectangular Table.
- 40mm dia. locking caster with 8mm thread; white-body, light grey tires.

PRODUCT CODE	PRICE	SIZE/INCHES			WEIGHT LBS	VOL FT ³
		H	D	W		
BRTLCS	26	2.5	2.7	2.6	0.06	0.01

FTFOOT-TL • T-foot

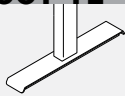

- Replacement single "T" foot.
- Includes attachment hardware.

PRODUCT CODE	PRICE	SIZE/INCHES			WEIGHT LBS	VOL FT ³
		H	D	W		
FTFOOT24TL	83	1.16	23	3	4.4	0.25
FTFOOT30TL	89	1.16	29	3	4.85	0.31

FTFOOT-CL • C-foot

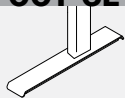

- Replacement single "C" foot.
- Includes attachment hardware.

PRODUCT CODE	PRICE	SIZE/INCHES			WEIGHT LBS	VOL FT ³
		H	D	W		
FTFOOT24CL	107	1.16	23	3	4.4	0.25
FTFOOT30CL	116	1.16	29	3	4.85	0.31

FTSETGLIDE • Set of Glides



- Replacement Glides a set of two with 1/2" adjustment

PRODUCT CODE	PRICE	SIZE/INCHES			WEIGHT LBS	VOL FT ³
		H	D	W		
FTSETGLIDE	12	1	1.5	1.5	0.06	0.01

BRLBST • Single Table Accessory Rail

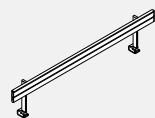

- **Table mounted accessory rail.**
- Compatible with standard Bins, Trays and Sorters.
- Includes end caps and mounting hardware.
- Please specify paint finish
- To ensure proper connection and clearance on tables 46" wide and up, choose accessory rail 13" smaller than the actual table width (70" wide table gets 57" wide rail).
- Tables 40" wide and smaller use 33" wide accessory rail.

PRODUCT CODE	PRICE	SIZE/INCHES			WEIGHT VOL	
		H	W	D	LBS	FT ³
BRLBST36	288	16	33	2.95	5.9	0.26
BRLBST42	301	16	39	2.95	6.44	0.30
BRLBST48	311	16	45	2.95	6.98	0.35
BRLBST54	323	16	51	2.95	7.52	0.39
BRLBST60	332	16	57	2.95	8.07	0.43
BRLBST66	342	16	63	2.95	8.61	0.48
BRLBST72	355	16	69	2.95	9.15	0.52
BRLBST78	365	16	75	2.95	9.69	0.56
BRLBST84	377	16	81	2.95	10.24	0.61