

Bridges Feature List

Our desire was to develop an environment for collaborative teamwork which would facilitate connection, or bridging, of people and ideas. A set of components which would even serve as a catalyst - inviting team members out of their cocooned comfort zones and encouraging them to engage, to co-create.

- Flexible building components:**
- single tables (freestanding or mobile)
 - training rooms
 - boardrooms
 - library
 - 1 person general and private office
 - 2 person work station
 - 3-person work station
 - 4-person work station
 - 6+ -person work station
 - Storage spine-based work station
 - Panel based work station

Easy to customize / reconfigure to fit specific requirements. From the facility manager's perspective, all work stations can be standardized to form a linear worksurface and power/data services, and their respective function, or purpose, can be governed by the type, quantity and placement of adjacent components like dividers, storage cabinets, shelves and accessories. These adjacent components can be easily reconfigured with minimal down time - without having to invite electrical and IT crew.

Compatible with various environments clean, simple, elegant design language with finishes suggesting comfortable, even domestic flavour. Wide range of finished various environments. From understated to some combinations, like anodized aluminum and white that give a hint of subtle sophistication.

Choice of two functionally and visually differentiated leg supports on casters or levelers: - height-adjustable round legs - fixed height rectangular legs with optional anodized aluminum finish

Various power/data delivery levels to choose from: - wire basket to organize cable excess under worksurface and storage - table leg integrated vertical cable manager - worksurface edge-mounted power/data units (easy to reconfigure, plug into wall/floor outlets) - single and double below worksurface power/data trough (desk top, floor standing computers and office equipment) - worksurface access door (access to below worksurface power outlets and data terminals) - above worksurface power/data trough (laptop / tablet / phone immediate access) - storage integrated power/data unit - horizontal cable management under storage units with optional wire basket - raised storage units for uninterrupted access to panel based floor raceway

Interconnected storage units can form a spine (space division, storage, cable management and worksurface support). Storage leg can be configured to act as a ganging bracket.

Panel integrated storage units can be connected and provide support to panel partitions (space division, storage, cable management, panel power/data delivery access and worksurface support). Panel integrated Bridges leg provides support to panel mounted worksurfaces.

Bridges Collaborative Seating collection consists of seating, privacy screens, tables, tablets and power. It is a versatile modular furniture series which can be configured into many space planning scenarios including corner, in-line, open concept, traditional reception as well as secluded seating with high privacy partitions.

Worksurfaces

- Worksurfaces are available in (HP) high pressure laminate and (LP) low pressure laminate.
- Veneer tops available, please contact your Customer Service Representative.
- HP laminate tops are 1 1/16" thick laminate particle board and have a flat 3 mm edge profile on all sides.
- LP laminate tops are 1" thick melamine particle board and have a flat 3 mm edge profile on all side.

Tables

- All single sliding rail tables are standard with casters.
- All multiple linear workstations are standard with levelers.
- Tops square for flush surface-to-surface abutment and to accept desk mounted accessories.
- Worksurfaces provided with pilot holes for alignment purposes.

Worksurface Edge Profiles:

HP/LP edge: 

CODES: The price list uses a numbering system with meaningful alphanumeric characters to create a simple-to-understand product number. This makes specifying the product much easier and more accurate.

SPECIFICATION EXAMPLE OF A BRIDGES WORKSURFACE

PRODUCT CODE: BRTWS2472HP MR71T CHR
 BRT = Bridges
 WS = Type of Worksurface
 2472 = Size: Depth x Width
 HP = Finish
 MR71T = High Pressure Laminate
 CHR = PVC Edging

How To Specify:

- Specify Bridges product code in appropriate top material.
- Specify top colour - ie. Laminate colour MR71T (Studio White Matrix).
- Specify PVC edge colour - ie. CHR (Charcoal).

30" WIDE UNITS Storage Capacity Chart

SIDE TO SIDE

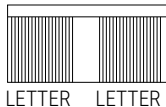

SIDE TO SIDE LETTER/FRONT TO BACK LEGAL

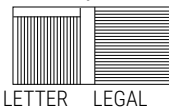

36" & 42" WIDE UNITS Storage Capacity Chart

SIDE TO SIDE LETTER

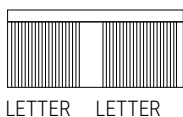

FRONT TO BACK LEGAL

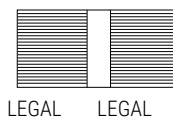

SIDE TO SIDE LETTER/FRONT TO BACK LEGAL

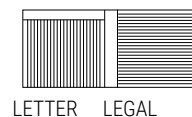

GRAIN DIRECTION CHART

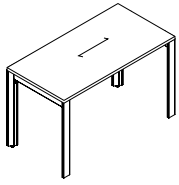

BRTS1P-L

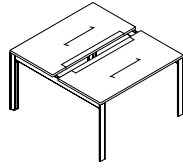

BRTBAR2PA-L

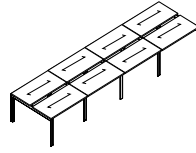

BRTBAR8PA-L

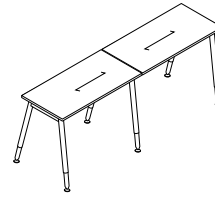

BRTS2P-LR

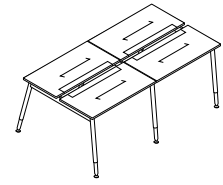

BRTBAR4PA-LR

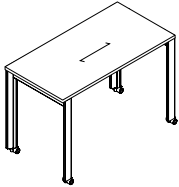

BRTS1P-C

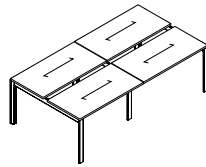

BRTBAR4P-L

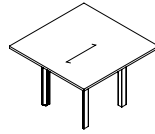

BRTSQ

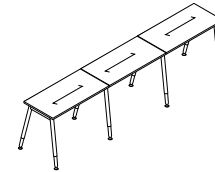

BRTS3P-LR

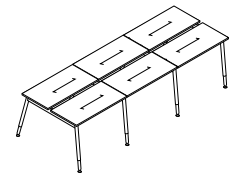

BRTBAR6P-LR

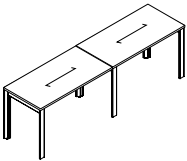

BRTS2P-L

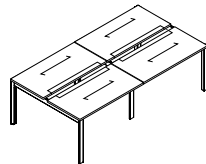

BRTBAR4PA-L

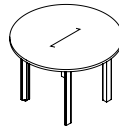

BRTR

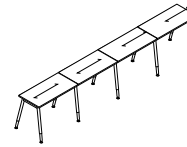

BRTS4P-LR

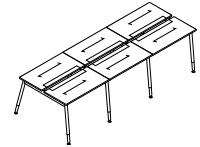

BRTBAR6PA-LR

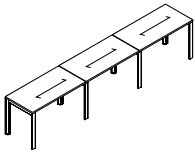

BRTS3P-L

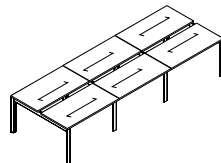

BRTBAR6P-L

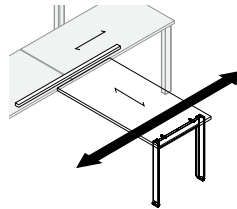

BRTSLDT72C

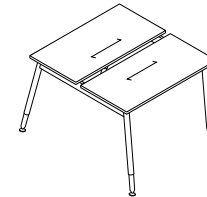

BRTBAR2P-LR

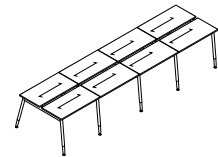

BRTBAR8P-LR

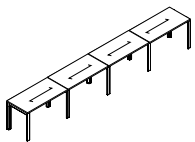

BRTS4P-L

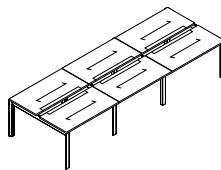

BRTBAR6PA-L

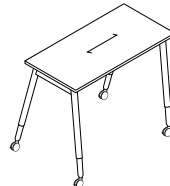

BRTS1P-CR

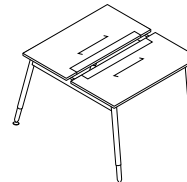

BRTBAR2PA-LR

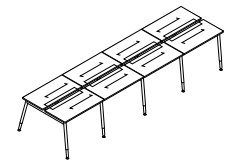

BRTBAR8PA-LR

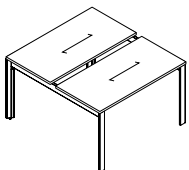

BRTBAR2P-L

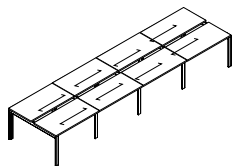

BRTBAR8P-L

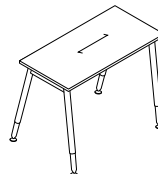

BRTS1P-LR



BRTBAR4P-LR

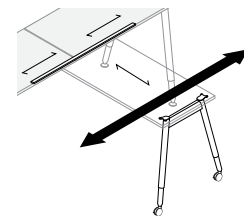

BRTSLDT72CR

GRAIN DIRECTION CHART

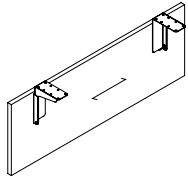

BRTMPS

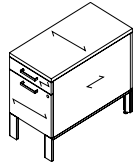

BRT25BF-L

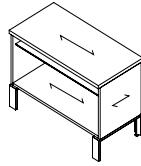

BRT25LO-L

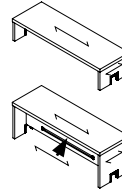

BRTBTS

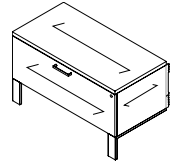

BRTPSL

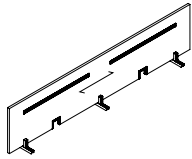

BRTLPPD

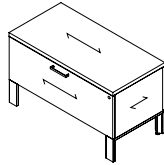

BRT21F-L

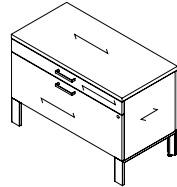

BRT25LBF-L

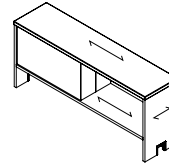

BRTBAS048

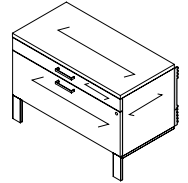

BRTPLBF

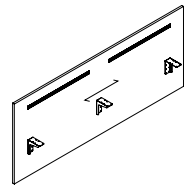

BRTLPPD

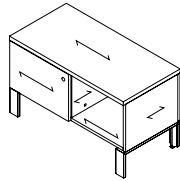

BRT21LS-L

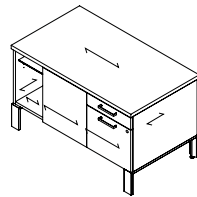

BRT25LBF042L

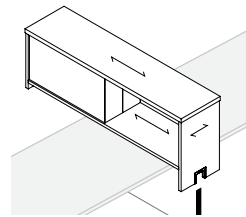

BRTSDS48

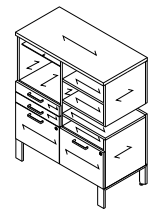

BRTCS45BBFF

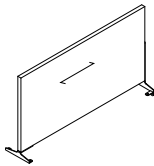

BRTLPPD

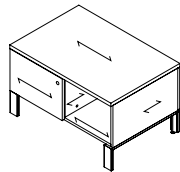

BRT21LSS-L

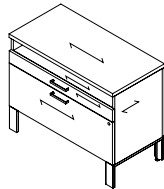

BRT29LOBF-L

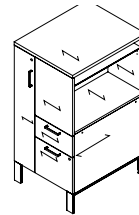

BRTTW50

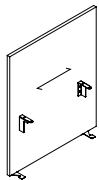

BRTLPPD

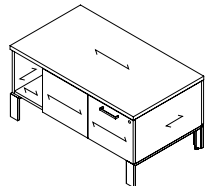

BRT21LS042L

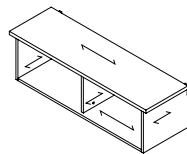

BRTTES

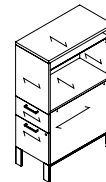

BRTT50

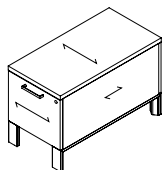

BRT21BF

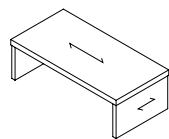

BRTSTS

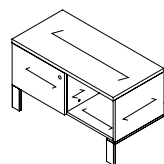

BRTPSLS

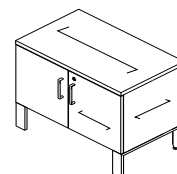

BRT25L2D

Technical Information - Rectangular Leg

Support Leg and Frame

Single and shared worksurface support.

Bridges Rectangular legs are available with:

- Locking casters (BRTLCS)
- Levelers (BRTLVS)
- Casters and Levelers not retrofitable.

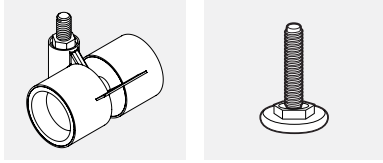

NOTES:

- Levelers have a 2" height range, with 5/16-18 thread.
- Levelers are available in black only.
- 45mm high casters with 8mm thread, available in White Body/Grey Tire combination only.
- Leg frame is available in our (9) standard paint and anodized aluminum finish.
- Paint finish is durable environmentally friendly epoxy powder coating.

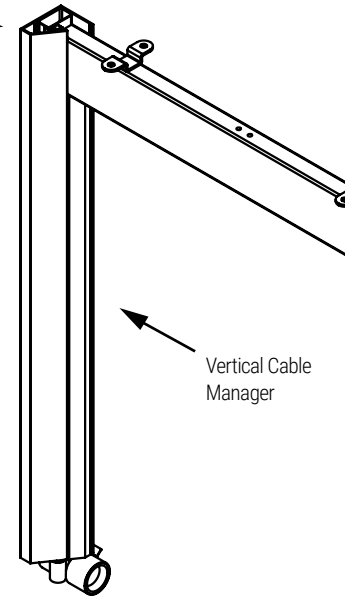

Vertical Cable Manager

Technical Information - Round Leg

Support Leg and Frame

- Tubular steel legs are adjustable in 1" increments.

Single and shared worksurface support.

Height adjustment allows the user to easily set the height of a table.

Legs have a height adjustment range of 24" - 32" in 1" increments with levelers and 27" - 35" with casters.

Bridges Round legs are available with:

- Locking casters (BRTLCR)
- Levelers (BRTLVR)
- Casters and levelers are retrofitable on site.



NOTES:

- Levelers have a 1" height range, with 3/8-16 thread.
- Levelers are available in Chrome only.
- Casters available in Tungsten/Black combination only.
- Casters are 3" diameter with an overall height of 3 3/4", with 3/8-16 thread.
- Inner leg is available in Chrome only.
- Leg frame is available in our (9) standard paint finishes.
- Paint finish is durable environmentally friendly epoxy powder coating.

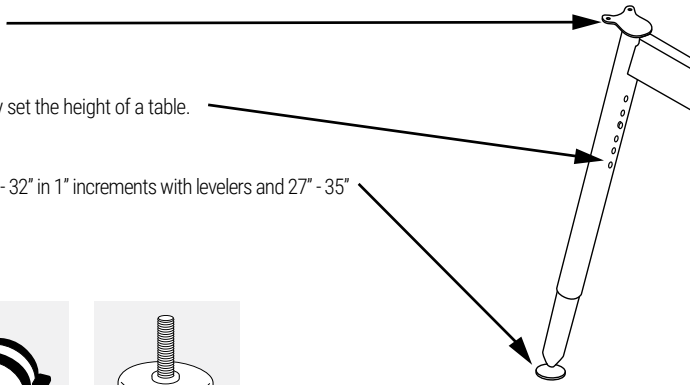

Height Adjustable Leg

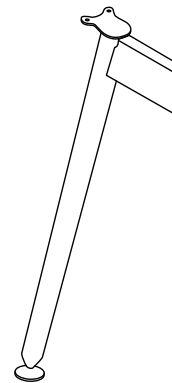

Fixed Leg

Technical Information - Handle Options

Optional handle to provide a softer and slimmer alternative to standard Bridges2 storage handles. Radiused corners and edges. Can be retrofitted on site as the drilling hole drawer front pattern remains unchanged.

Finish matches anodized aluminum.

- Centre to centre hole pattern for Bridges 2 handles is 128 mm.

Standard Handle

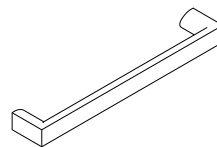

BRH1 - Anodized aluminum
BRH1B - Black

Optional Handle

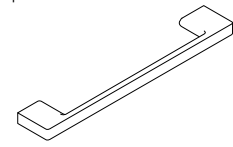

BRH2 - Anodized aluminum

BRTS1P-L • Rectangular Legs - Single Line 1 Person Pod (Levelers)

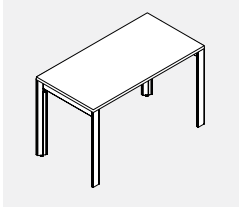

- **Single Line Table Assemblies consist of one worksurface, two leg assemblies and one horizontal structural beam.**
- Finish option, please choose from:
 - 1) anodized aluminum vertical legs with powder coated steel horizontal structural members. Anodized aluminum leg upcharge of \$110 for this configuration.
 - 2) powder coated aluminum vertical legs and steel horizontal structural members. Choose from standard metal finishes.
- Worksurface available in HP and LP. For wood veneer tops, please contact your Customer Service Representative.

PRODUCT CODE	PRICE		SIZE/ INCHES			WEIGHT VOL	
	LP	HP	H	W	D	LBS	FT ³
BRTS1P2436L	982	1038	29	36	24	45	4.00
BRTS1P2442L	1043	1111	29	42	24	48	4.10
BRTS1P2448L	1093	1174	29	48	24	51	4.20
BRTS1P2451L	1123	1209	29	50.5	24	54	4.30
BRTS1P2454L	1154	1249	29	54	24	57	4.40
BRTS1P2460L	1197	1301	29	60	24	60	4.48
BRTS1P2463L	1207	1317	29	62.5	24	63	4.57
BRTS1P2466L	1221	1328	29	66	24	66	4.65
BRTS1P2472L	1232	1356	29	72	24	69	4.73
BRTS1P2478L	1279	1395	29	78	24	72	4.82
BRTS1P2484L	1316	1441	29	84	24	75	4.92
BRTS1P3036L	1057	1120	29	36	30	54	4.20
BRTS1P3042L	1146	1233	29	42	30	57	4.30
BRTS1P3048L	1169	1262	29	48	30	60	4.41
BRTS1P3051L	1191	1287	29	50.5	30	63	4.50
BRTS1P3054L	1217	1304	29	54	30	66	4.60
BRTS1P3060L	1242	1353	29	60	30	69	4.73
BRTS1P3063L	1254	1366	29	62.5	30	72	4.80
BRTS1P3066L	1263	1381	29	66	30	75	4.90
BRTS1P3072L	1293	1416	29	72	30	78	5.01
BRTS1P3078L	1327	1452	29	78	30	81	5.10
BRTS1P3084L	1381	1516	29	84	30	84	5.20

BRTS1P-C • Rectangular Legs - Single Line 1 Person Pod (Casters)

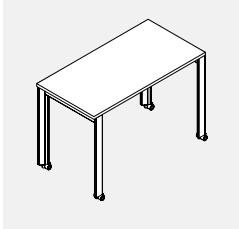

- **Single Line Table Assemblies consist of one worksurface, two leg assemblies and one horizontal structural beam.**
- 40mm white locking casters with grey tires; steel horizontal beams, aluminum legs.
- Finish options, please choose from:
 - 1) anodized aluminum vertical legs with powder coated steel horizontal structural members. Anodized aluminum leg upcharge of \$110 for this configuration.
 - 2) powder coated aluminum vertical legs and steel horizontal structural members. Choose from standard metal finishes.
- Worksurface available in HP and LP. For wood veneer tops, please contact your Customer Service Representative.

PRODUCT CODE	PRICE		SIZE/ INCHES			WEIGHT VOL	
	LP	HP	H	W	D	LBS	FT ³
BRTS1P2436C	1047	1104	29	36	24	45	4.00
BRTS1P2442C	1109	1175	29	42	24	48	4.10
BRTS1P2448C	1159	1238	29	48	24	51	4.20
BRTS1P2451C	1189	1277	29	50.5	24	54	4.30
BRTS1P2454C	1221	1312	29	54	24	57	4.40
BRTS1P2460C	1261	1366	29	60	24	60	4.48
BRTS1P2463C	1272	1383	29	62.5	24	63	4.57
BRTS1P2466C	1285	1393	29	66	24	66	4.65
BRTS1P2472C	1305	1421	29	72	24	69	4.73
BRTS1P2478C	1342	1460	29	78	24	72	4.82
BRTS1P2484C	1381	1505	29	84	24	75	4.92
BRTS1P3036C	1122	1187	29	36	30	54	4.20
BRTS1P3042C	1209	1299	29	42	30	57	4.30
BRTS1P3048C	1233	1327	29	48	30	60	4.41
BRTS1P3051C	1256	1351	29	50.5	30	63	4.50
BRTS1P3054C	1280	1368	29	54	30	66	4.60
BRTS1P3060C	1309	1417	29	60	30	69	4.73
BRTS1P3063C	1318	1431	29	62.5	30	72	4.90
BRTS1P3066C	1328	1444	29	66	30	75	4.90
BRTS1P3072C	1357	1464	29	72	30	78	5.01
BRTS1P3078C	1392	1516	29	78	30	81	5.10
BRTS1P3084C	1455	1581	29	84	30	84	5.20

BRTS2P-L • Rectangular Legs - Single Line 2 Person Pod (Levelers)

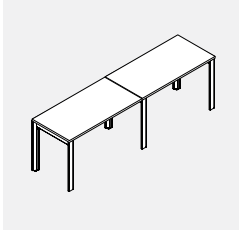

- **Single Line, 2-person workstation consists of two worksurfaces, three leg assemblies and 2 horizontal structural beams.**
- One leg can be shared by 2 adjoining worksurfaces.
- Finish options, please choose from:
 - 1) anodized aluminum vertical legs with powder coated steel horizontal structural members. Anodized aluminum leg upcharge of \$164 for this configuration.
 - 2) powder coated aluminum vertical legs and steel horizontal structural members. Choose from standard metal finishes.
- Worksurface available in HP and LP. For wood veneer tops, please contact your Customer Service Representative.

PRODUCT CODE	PRICE		SIZE/ INCHES			WEIGHT VOL	
	LP	HP	H	W	D	LBS	FT ³
BRTS2P2448L	1863	2027	29	96	24	95	6.21
BRTS2P2454L	1987	2169	29	108	24	104	6.45
BRTS2P2460L	2068	2283	29	120	24	113	6.71
BRTS2P2466L	2115	2334	29	132	24	122	6.95
BRTS2P2472L	2158	2391	29	144	24	131	7.13
BRTS2P2478L	2231	2468	29	156	24	140	7.27
BRTS2P2484L	2309	2558	29	168	24	149	7.41
BRTS2P3048L	2001	2186	29	96	30	113	6.57
BRTS2P3054L	2086	2269	29	108	30	122	6.85
BRTS2P3060L	2147	2365	29	120	30	131	7.13
BRTS2P3066L	2190	2422	29	132	30	140	7.41
BRTS2P3072L	2264	2510	29	144	30	155	7.69
BRTS2P3078L	2314	2562	29	156	30	164	7.97
BRTS2P3084L	2422	2693	29	168	30	173	8.25

BRTS3P-L • Rectangular Legs - Single Line 3 Person Pod (Levelers)

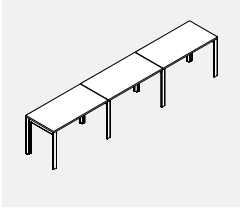

- **Single Line, 3-person workstation consists of 3 worksurfaces, 4 leg assemblies and 3 horizontal structural beams.**
- Finish options, please choose from:
 - 1) anodized aluminum vertical legs with powder coated steel horizontal structural members. Anodized aluminum leg upcharge of \$217 for this configuration.
 - 2) powder coated aluminum vertical legs and steel horizontal structural members. Choose from standard metal finishes.
- Worksurface available in HP and LP. For wood veneer tops, please contact your Customer Service Representative.

PRODUCT CODE	PRICE		SIZE/INCHES			WEIGHT VOL	
	LP	HP	H	W	D	LBS	FT ³
BRTS3P2448L	2632	2879	29	144	24	138	8.47
BRTS3P2454L	2816	3093	29	162	24	152	8.68
BRTS3P2460L	2945	3249	29	180	24	165	8.89
BRTS3P2466L	3011	3340	29	198	24	179	9.11
BRTS3P2472L	3077	3424	29	216	24	192	9.32
BRTS3P2478L	3186	3543	29	234	24	206	9.53
BRTS3P2484L	3298	3678	29	252	24	219	9.74
BRTS3P3048L	2833	3106	29	144	30	161	9.01
BRTS3P3054L	2958	3232	29	162	30	178	9.44
BRTS3P3060L	3050	3379	29	180	30	195	9.87
BRTS3P3066L	3113	3461	29	198	30	212	10.30
BRTS3P3072L	3204	3570	29	216	30	229	10.72
BRTS3P3078L	3300	3676	29	234	30	246	11.16
BRTS3P3084L	3461	3869	29	252	30	263	11.59

BRTS4P-L • Rectangular Legs - Single Line 4 Person Pod (Levelers)

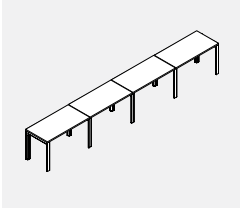

- **Single Line, 4-person workstation consists of 4 worksurfaces, 5 leg assemblies and 4 horizontal structural beams.**
- Finish options, please choose from:
 - 1) anodized aluminum vertical legs with powder coated steel horizontal structural members. Anodized aluminum leg upcharge of \$271 for this configuration.
 - 2) powder coated aluminum vertical legs and steel horizontal structural members. Choose from standard metal finishes.
- Worksurface available in HP and LP. For wood veneer tops, please contact your Customer Service Representative.

PRODUCT CODE	PRICE		SIZE/INCHES			WEIGHT VOL	
	LP	HP	H	W	D	LBS	FT ³
BRTS4P2448L	3400	3730	29	192	24	180	10.73
BRTS4P2454L	3649	4015	29	216	24	199	11.22
BRTS4P2460L	3815	4241	29	240	24	217	11.71
BRTS4P2466L	3905	4344	29	264	24	236	12.20
BRTS4P2472L	4021	4490	29	288	24	254	12.69
BRTS4P2478L	4137	4617	29	312	24	273	13.18
BRTS4P2484L	4292	4797	29	336	24	291	13.67
BRTS4P3048L	3663	4032	29	192	30	213	11.45
BRTS4P3054L	3831	4200	29	216	30	235	12.02
BRTS4P3060L	3955	4392	29	240	30	257	12.59
BRTS4P3066L	4037	4506	29	264	30	279	13.16
BRTS4P3072L	4159	4645	29	288	30	301	13.73
BRTS4P3078L	4290	4787	29	312	30	323	14.30
BRTS4P3084L	4506	5044	29	336	30	345	14.87

BRTBAR2P-L • Rectangular Legs - Back 2 Back 2 Person Pod (Levelers)

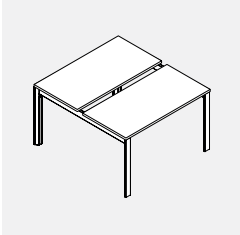

- **Back 2 Back, 2-person workstation consists of 2 worksurfaces, 2 Back 2 Back leg assemblies and 2 horizontal structural beams.**
- Finish options, please choose from:
 - 1) anodized aluminum vertical legs with powder coated steel horizontal structural members. Anodized aluminum leg upcharge of \$110 for this configuration.
 - 2) powder coated aluminum vertical legs and steel horizontal structural members. Choose from standard metal finishes.
- Worksurface available in HP and LP. For wood veneer tops, please contact your Customer Service Representative.

PRODUCT CODE	PRICE		SIZE/INCHES			WEIGHT VOL	
	LP	HP	H	W	D	LBS	FT ³
BRTBAR2P2460L	1939	2154	29	60	50.5	110	8.56
BRTBAR2P2466L	1987	2203	29	66	50.5	119	8.76
BRTBAR2P2472L	2030	2262	29	72	50.5	128	9.02
BRTBAR2P2478L	2101	2341	29	78	50.5	137	9.20
BRTBAR2P2484L	2179	2429	29	84	50.5	146	9.40
BRTBAR2P3060L	1968	2190	29	60	62.5	130	9.00
BRTBAR2P3066L	2011	2245	29	66	62.5	141	9.25
BRTBAR2P3072L	2076	2314	29	72	62.5	152	9.54
BRTBAR2P3078L	2145	2387	29	78	62.5	163	9.80
BRTBAR2P3084L	2245	2515	29	84	62.5	174	10.4

BRTBAR2PA-L • Rectangular Legs - Back 2 Back 2 Person Pod (Levelers) with Access Door

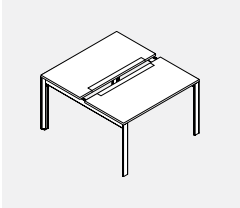

- **Back 2 Back, 2-person workstation consists of 2 worksurfaces, 2 Back 2 Back leg assemblies and 2 horizontal structural beams.**
- Finish options, please choose from:
 - 1) anodized aluminum vertical legs with powder coated steel horizontal structural members. Anodized aluminum leg upcharge of \$110 for this configuration.
 - 2) powder coated aluminum vertical legs and steel horizontal structural members. Choose from standard metal finishes.
- Anodized aluminum worksurface door provides access to power / data through below worksurface.
- Worksurface with access doors cannot be combined with above worksurface power trough.
- Worksurface available in HP and LP.

PRODUCT CODE	PRICE		SIZE/INCHES			WEIGHT VOL	
	LP	HP	H	W	D	LBS	FT ³
BRTBAR2PA2460L	2019	2323	29	60	50.5	110	8.56
BRTBAR2PA2466L	2097	2435	29	66	50.5	119	8.76
BRTBAR2PA2472L	2179	2567	29	72	50.5	128	9.02
BRTBAR2PA3060L	2179	2567	29	60	62.5	130	9.00
BRTBAR2PA3066L	2292	2710	29	66	62.5	141	9.25
BRTBAR2PA3072L	2372	2841	29	72	62.5	152	9.54

BRTBAR2PDA-L • Rectangular Legs - Back 2 Back 2 Person Pod (Levelers) with Access Doors

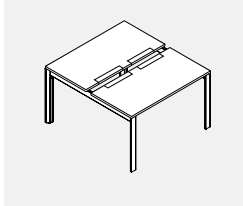

• **Back 2 Back, 2-person workstation consists of 2 worksurfaces, 2 Back 2 Back leg assemblies and 2 horizontal structural beams.**

- These tables feature dual access doors providing a central connection point for monitor lifts.
- Finish options, please choose from:
 - 1) anodized aluminum vertical legs with powder coated steel horizontal structural members. Anodized aluminum leg upcharge of \$110 for this configuration.
 - 2) powder coated aluminum vertical legs and steel horizontal structural members. Choose from standard metal finishes.

- Anodized aluminum worksurface door provides access to power / data through below worksurface.
- Worksurface with access doors cannot be combined with above worksurface power trough.
- Worksurface available in HP and LP.

PRODUCT CODE	PRICE		SIZE/INCHES			WEIGHT VOL	
	LP	HP	H	W	D	LBS	FT ³
BRTBAR2PDA2460L	2179	2511	29	60	50.5	110	8.56
BRTBAR2PDA2466L	2264	2632	29	66	50.5	119	8.76
BRTBAR2PDA2472L	2352	2772	29	72	50.5	128	9.02
BRTBAR2PDA2478L	2404	2842	29	78	50.5	137	9.20
BRTBAR2PDA2484L	2476	2961	29	84	50.5	146	9.40
BRTBAR2PDA3060L	2352	2772	29	60	62.5	130	9.00
BRTBAR2PDA3066L	2476	2927	29	66	62.5	141	9.25
BRTBAR2PDA3072L	2563	3067	29	72	62.5	152	9.54
BRTBAR2PDA3078L	2615	3172	29	78	62.5	163	9.80
BRTBAR2PDA3084L	2702	3295	29	84	62.5	174	10.4

BRTBAR4P-L • Rectangular Legs - Back 2 Back 4 Person Pod (Levelers)

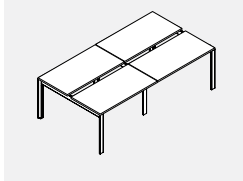

• **Back 2 Back, 4-person workstation consists of 4 worksurfaces, 2 Back 2 Back outer leg assemblies, 1 Back 2 Back narrow leg assembly and 4 horizontal structural beams.**

- Finish options, please choose from:
 - 1) anodized aluminum vertical legs with powder coated steel horizontal structural members. Anodized aluminum leg upcharge of \$164 for this configuration.
 - 2) powder coated aluminum vertical legs and steel horizontal structural members. Choose from standard metal finishes.

- Worksurface available in HP and LP. For wood veneer tops, please contact your Customer Service Representative.

PRODUCT CODE	PRICE		SIZE/INCHES			WEIGHT VOL	
	LP	HP	H	W	D	LBS	FT ³
BRTBAR4P2460L	3428	3853	29	120	50.5	208	13.82
BRTBAR4P2466L	3518	3958	29	132	50.5	224	14.28
BRTBAR4P2472L	3608	4073	29	144	50.5	240	14.74
BRTBAR4P2478L	3751	4227	29	156	50.5	256	15.20
BRTBAR4P2484L	3905	4409	29	168	50.5	272	15.66
BRTBAR4P3060L	3518	3958	29	120	62.5	253	14.70
BRTBAR4P3066L	3603	4068	29	132	62.5	273	15.24
BRTBAR4P3072L	3724	4209	29	144	62.5	293	15.78
BRTBAR4P3078L	3853	4352	29	156	62.5	313	16.32
BRTBAR4P3084L	4068	4608	29	168	62.5	333	16.86

BRTBAR4PA-L • Rectangular Legs - Back 2 Back 4 Person Pod (Levelers) with Access Door

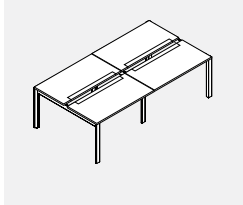

• **Back 2 Back, 4-person workstation consists of 4 worksurfaces, 2 Back 2 Back outer leg assemblies, 1 Back 2 Back narrow leg assembly and 4 horizontal structural beams**

- Finish options, please choose from:
 - 1) anodized aluminum vertical legs with powder coated steel horizontal structural members. Anodized aluminum leg upcharge of \$164 for this configuration.

- 2) powder coated aluminum vertical legs and steel horizontal structural members. Choose from standard metal finishes.
- Anodized aluminum worksurface door provides access to power / data through below worksurface.
- Worksurface with access doors cannot be combined with above worksurface power trough.
- Worksurface available in HP and LP.

PRODUCT CODE	PRICE		SIZE/INCHES			WEIGHT VOL	
	LP	HP	H	W	D	LBS	FT ³
BRTBAR4PA2460L	3584	4197	29	120	50.5	208	13.82
BRTBAR4PA2466L	3743	4422	29	132	50.5	224	14.28
BRTBAR4PA2472L	3905	4681	29	144	50.5	240	14.74
BRTBAR4PA3060L	3873	4648	29	120	62.5	253	14.70
BRTBAR4PA3066L	4098	4939	29	132	62.5	273	15.24
BRTBAR4PA3072L	4261	5196	29	144	62.5	293	15.78

BRTBAR4PDA-L • Rectangular Legs - Back 2 Back 4 Person Pod (Levelers) with Access Doors

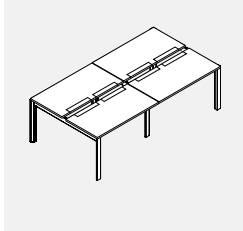

• **Back 2 Back, 4-person workstation consists of 4 worksurfaces, 2 Back 2 Back outer leg assemblies, 1 Back 2 Back narrow leg assembly and 4 horizontal structural beams**

- These tables feature dual access doors providing a central connection point for monitor lifts.
- Finish options, please choose from:
 - 1) anodized aluminum vertical legs with powder coated steel horizontal structural members. Anodized aluminum leg upcharge of \$164 for this configuration.

- 2) powder coated aluminum vertical legs and steel horizontal structural members. Choose from standard metal finishes.
- Anodized aluminum worksurface door provides access to power / data through below worksurface.
- Worksurface with access doors cannot be combined with above worksurface power trough.
- Worksurface available in HP and LP.

PRODUCT CODE	PRICE		SIZE/INCHES			WEIGHT VOL	
	LP	HP	H	W	D	LBS	FT ³
BRTBAR4PDA2460L	3869	4532	29	120	50.5	208	13.82
BRTBAR4PDA2466L	4045	4774	29	132	50.5	224	14.28
BRTBAR4PDA2472L	4216	5055	29	144	50.5	240	14.74
BRTBAR4PDA2478L	4323	5192	29	156	50.5	256	15.20
BRTBAR4PDA2484L	4459	5438	29	168	50.5	272	15.66
BRTBAR4PDA3060L	4183	5018	29	120	62.5	253	14.70
BRTBAR4PDA3066L	4426	5334	29	132	62.5	273	15.24
BRTBAR4PDA3072L	4602	5612	29	144	62.5	293	15.78
BRTBAR4PDA3078L	4707	5821	29	156	62.5	313	16.32
BRTBAR4PDA3084L	4880	6064	29	168	62.5	333	16.86

BRTBAR6P-L • Rectangular Legs - Back 2 Back 6 Person Pod (Levelers)

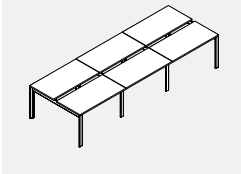

- **Back 2 Back, 6-person workstation consists of 6 worksurfaces, 2 Back 2 Back outer leg assemblies, 2 Back 2 Back narrow leg assemblies and 6 horizontal structural beams.**
- Finish options, please choose from:
 - 1) anodized aluminum vertical legs with powder coated steel horizontal structural members. Anodized aluminum leg upcharge of \$217 for this configuration.
 - 2) powder coated aluminum vertical legs and steel horizontal structural members. Choose from standard metal finishes.
- Worksurface available in HP and LP. For wood veneer tops, please contact your Customer Service Representative.

PRODUCT CODE	PRICE		SIZE/INCHES			WEIGHT LBS	VOL FT ³
	LP	HP	H	W	D		
BRTBAR6P2460L	4883	5523	29	180	50.5	308	19.76
BRTBAR6P2466L	5051	5710	29	198	50.5	329	20.54
BRTBAR6P2472L	5187	5883	29	216	50.5	359	21.32
BRTBAR6P2478L	5400	6116	29	234	50.5	409	22.10
BRTBAR6P2484L	5632	6387	29	252	50.5	434	22.88
BRTBAR6P3060L	5003	5660	29	180	62.5	369	21.08
BRTBAR6P3066L	5160	5860	29	198	62.5	400	21.97
BRTBAR6P3072L	5346	6072	29	216	62.5	431	22.86
BRTBAR6P3078L	5540	6283	29	234	62.5	462	23.75
BRTBAR6P3084L	5860	6672	29	252	62.5	493	24.53

BRTBAR6PA-L • Rectangular Legs - Back 2 Back 6 Person Pod (Levelers) with Access Door

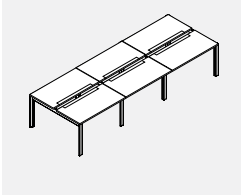

- **Back 2 Back, 6-person workstation consists of 6 worksurfaces, 2 Back 2 Back outer leg assemblies, 2 Back 2 Back narrow leg assemblies and 6 horizontal structural beams.**
- Finish options, please choose from
 - 1) anodized aluminum vertical legs with powder coated steel horizontal structural members. Anodized aluminum leg upcharge of \$217 for this configuration.
 - 2) powder coated aluminum vertical legs and steel horizontal structural members. Choose from standard metal finishes.
- Anodized aluminum work surface door provides access to power / data through below work surface.
- Worksurface with access doors cannot be combined with above work surface power trough.
- Worksurface available in HP and LP.

PRODUCT CODE	PRICE		SIZE/INCHES			WEIGHT LBS	VOL FT ³
	LP	HP	H	W	D		
BRTBAR6PA2460L	5116	6035	29	180	50.5	308	19.76
BRTBAR6PA2466L	5388	6408	29	198	50.5	329	20.54
BRTBAR6PA2472L	5632	6795	29	216	50.5	359	21.32
BRTBAR6PA3060L	5536	6698	29	180	62.5	369	21.08
BRTBAR6PA3066L	5907	7165	29	198	62.5	400	21.97
BRTBAR6PA3072L	6149	7554	29	216	62.5	431	22.86

BRTBAR6PDA-L • Rectangular Legs - Back 2 Back 6 Person Pod (Levelers) with Access Doors

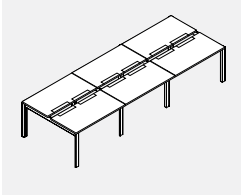

- **Back 2 Back, 6-person workstation consists of 6 worksurfaces, 2 Back 2 Back outer leg assemblies, 2 Back 2 Back narrow leg assemblies and 6 horizontal structural beams.**
- These tables feature dual access doors providing a central connection point for monitor lifts.
- Finish options, please choose from
 - 1) anodized aluminum vertical legs with powder coated steel horizontal structural members. Anodized aluminum leg upcharge of \$217 for this configuration.
 - 2) powder coated aluminum vertical legs and steel horizontal structural members. Choose from standard metal finishes.
- Anodized aluminum work surface door provides access to power / data through below work surface.
- Worksurface with access doors cannot be combined with above work surface power trough.
- Worksurface available in HP and LP.

PRODUCT CODE	PRICE		SIZE/INCHES			WEIGHT LBS	VOL FT ³
	LP	HP	H	W	D		
BRTBAR6PDA2460L	5525	6519	29	180	50.5	308	19.76
BRTBAR6PDA2466L	5821	6871	29	198	50.5	329	20.54
BRTBAR6PDA2472L	6083	7339	29	216	50.5	359	21.32
BRTBAR6PDA2478L	6240	7548	29	234	50.5	409	22.10
BRTBAR6PDA2484L	6448	7911	29	252	50.5	434	22.88
BRTBAR6PDA3060L	5977	7234	29	180	62.5	369	21.08
BRTBAR6PDA3066L	6379	7739	29	198	62.5	400	21.97
BRTBAR6PDA3072L	6641	8158	29	216	62.5	431	22.86
BRTBAR6PDA3078L	6798	8470	29	234	62.5	462	23.75
BRTBAR6PDA3084L	7060	8837	29	252	62.5	493	24.53

BRTBAR8P-L • Rectangular Legs - Back 2 Back 8 Person Pod (Levelers)

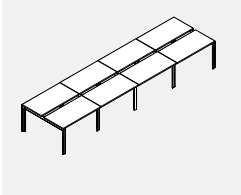

- **Back 2 Back, 8-person workstation consists of 8 worksurfaces, 2 Back 2 Back outer leg assemblies, 3 Back 2 Back narrow leg assemblies and 8 horizontal structural beams.**
- Finish options, please choose from:
 - 1) anodized aluminum vertical legs with powder coated steel horizontal structural members. Anodized aluminum leg upcharge of \$271 for this configuration.
 - 2) powder coated aluminum vertical legs and steel horizontal structural members. Choose from standard metal finishes.
- Worksurface available in HP and LP. For wood veneer tops, please contact your Customer Service Representative.

PRODUCT CODE	PRICE		SIZE/INCHES			WEIGHT LBS	VOL FT ³
	LP	HP	H	W	D		
BRTBAR8P2460L	6435	7288	29	240	50.5	412	24.42
BRTBAR8P2466L	6584	7464	29	264	50.5	448	25.30
BRTBAR8P2472L	6766	7695	29	288	50.5	484	26.30
BRTBAR8P2478L	7048	8003	29	312	50.5	520	27.30
BRTBAR8P2484L	7358	8364	29	336	50.5	556	28.30
BRTBAR8P3060L	6551	7431	29	240	62.5	492	26.18
BRTBAR8P3066L	6719	7647	29	264	62.5	536	27.28
BRTBAR8P3072L	6966	7934	29	288	62.5	581	28.38
BRTBAR8P3078L	7224	8219	29	312	62.5	625	29.48
BRTBAR8P3084L	7647	8733	29	336	62.5	669	30.58

BRTBAR8PA-L • Rectangular Legs - Back 2 Back 8 Person Pod (Levelers) with Access Door

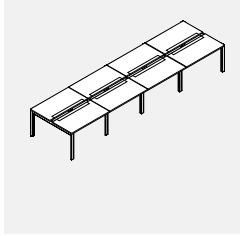

- Back 2 Back, 8-person workstation consists of 8 worksurfaces, 2 Back 2 Back outer leg assemblies, 3 Back 2 Back narrow leg assemblies and 8 horizontal structural beams.

- Finish options, please choose from:

- 1) anodized aluminum vertical legs with powder coated steel horizontal structural members. Anodized aluminum leg upcharge of \$271 for this configuration.
- 2) powder coated aluminum vertical legs and steel horizontal structural members. Choose from standard metal finishes.
- Anodized aluminum worksurface door provides access to power / data through below worksurface.
- Worksurface with access doors cannot be combined with above worksurface power trough.
- Worksurface available in HP and LP.

PRODUCT CODE	PRICE		SIZE/INCHES				WEIGHT VOL	
	LP	HP	H	W	D	LBS	FT³	
BRTBAR8PA2460L	6744	7971	29	240	50.5	412	24.42	
BRTBAR8PA2466L	7035	8392	29	264	50.5	448	25.30	
BRTBAR8PA2472L	7358	8908	29	288	50.5	484	26.30	
BRTBAR8PA3060L	7261	8811	29	240	62.5	492	26.18	
BRTBAR8PA3066L	7714	9393	29	264	62.5	536	27.28	
BRTBAR8PA3072L	8037	9906	29	288	62.5	581	28.38	

BRTBAR8PDA-L • Rectangular Legs - Back 2 Back 8 Person Pod (Levelers) with Access Doors

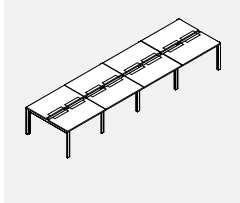

- Back 2 Back, 8-person workstation consists of 8 worksurfaces, 2 Back 2 Back outer leg assemblies, 3 Back 2 Back narrow leg assemblies and 8 horizontal structural beams.

- These tables feature dual access doors providing a central connection point for monitor lifts.

- Finish options, please choose from:

- 1) anodized aluminum vertical legs with powder coated steel horizontal structural members. Anodized aluminum leg upcharge of \$271 for this configuration.
- 2) powder coated aluminum vertical legs and steel horizontal structural members. Choose from standard metal finishes.
- Anodized aluminum worksurface door provides access to power / data through below worksurface.
- Worksurface with access doors cannot be combined with above worksurface power trough.
- Worksurface available in HP and LP.

PRODUCT CODE	PRICE		SIZE/INCHES				WEIGHT VOL	
	LP	HP	H	W	D	LBS	FT³	
BRTBAR8PDA2460L	7284	8609	29	240	50.5	412	24.42	
BRTBAR8PDA2466L	7599	9064	29	264	50.5	448	25.30	
BRTBAR8PDA2472L	7949	9622	29	288	50.5	484	26.30	
BRTBAR8PDA2478L	8158	9898	29	312	50.5	520	27.30	
BRTBAR8PDA2484L	8436	10388	29	336	50.5	556	28.30	
BRTBAR8PDA3060L	7842	9517	29	240	62.5	492	26.18	
BRTBAR8PDA3066L	8333	10145	29	264	62.5	536	27.28	
BRTBAR8PDA3072L	8677	10701	29	288	62.5	581	28.38	
BRTBAR8PDA3078L	8888	11120	29	312	62.5	625	29.48	
BRTBAR8PDA3084L	9238	11440	29	336	62.5	669	30.58	

BRT36P-C • Rectangular Legs - 36" High Single Table (Casters)

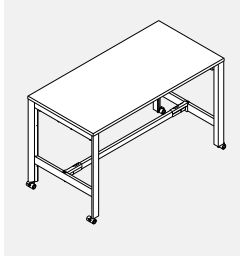

- Single table assembly consists of one work-surface, two H leg assemblies and all required beams.

- 24" deep tables have three (3) beams at the top, and one bottom beam.

- 30" and 36" deep tables have four (4) beams at the top, and one bottom beam.

- 40mm white locking casters with grey tires.

- Finish option, please choose from:

- 1) anodized aluminum vertical legs with powder coated steel horizontal structural members. Anodized aluminum leg upcharge of \$110 for this configuration.
- 2) powder coated aluminum vertical legs with steel horizontal structural members. Choose from standard metal finishes.
- Worksurface available in LP and HP.

PRODUCT CODE	PRICE		SIZE/INCHES				WEIGHT VOL	
	LP	HP	H	W	D	LBS	FT³	
BRT36P2436C	1891	1943	36	36	24	68.5	4.55	
BRT36P2442C	1950	2017	36	42	24	76.0	4.76	
BRT36P2448C	2025	2107	36	48	24	81.5	4.98	
BRT36P2454C	2130	2222	36	54	24	88.0	5.19	
BRT36P2460C	2198	2305	36	60	24	94.6	5.41	
BRT36P2466C	2248	2357	36	66	24	101.1	5.62	
BRT36P2472C	2295	2410	36	72	24	107.6	5.83	
BRT36P2478C	2354	2475	36	78	24	114.1	6.13	
BRT36P2484C	2413	2540	36	84	24	120.6	6.42	
BRT36P3036C	2178	2239	36	36	30	83.9	5.00	
BRT36P3042C	2273	2361	36	42	30	91.0	5.26	
BRT36P3048C	2330	2422	36	48	30	99.2	5.53	
BRT36P3054C	2432	2526	36	54	30	107.3	5.79	
BRT36P3060C	2498	2608	36	60	30	115.5	6.06	
BRT36P3066C	2552	2668	36	66	30	123.6	6.32	
BRT36P3072C	2617	2736	36	72	30	131.8	6.59	
BRT36P3078C	2682	2807	36	78	30	139.9	6.95	
BRT36P3084C	2761	2897	36	84	30	148.1	7.32	
BRT36P3642C	2464	2549	36	42	36	99.9	6.56	
BRT36P3648C	2552	2644	36	48	36	109.0	6.87	
BRT36P3654C	2670	2778	36	54	36	118.2	7.18	
BRT36P3660C	2758	2873	36	60	36	126.3	7.48	
BRT36P3666C	2844	2972	36	66	36	135.5	7.79	
BRT36P3672C	2927	3065	36	72	36	144.6	8.10	
BRT36P3678C	3012	3160	36	78	36	152.8	8.50	
BRT36P3684C	3092	3252	36	84	36	161.9	8.91	

BRT36P-L • Rectangular Legs - 36" High Single Table (Levelers)

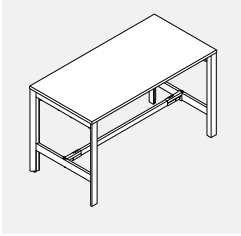

- Single table assembly consists of one work-surface, two H leg assemblies and all required beams.
- 24" deep tables have three (3) beams at the top, and one bottom beam.
- 30" and 36" deep tables have four (4) beams at the top, and one bottom beam.
- Finish option, please choose from:
 - 1) anodized aluminum vertical legs with powder coated steel horizontal structural members. Anodized aluminum leg upcharge of \$110 for this configuration
 - 2) powder coated aluminum vertical legs with steel horizontal structural members Choose from standard metal finishes
- Worksurface available in LP and HP.

PRODUCT CODE	PRICE		SIZE/INCHES				WEIGHT LBS	VOL FT ³
	LP	HP	H	W	D			
BRT36P2436L	1813	1863	36	36	24	68.0	4.55	
BRT36P2442L	1872	1939	36	42	24	75.5	4.76	
BRT36P2448L	1947	2028	36	48	24	81.0	4.98	
BRT36P2454L	2053	2145	36	54	24	87.6	5.19	
BRT36P2460L	2120	2225	36	60	24	94.1	5.41	
BRT36P2466L	2169	2279	36	66	24	100.6	5.62	
BRT36P2472L	2218	2333	36	72	24	107.1	5.83	
BRT36P2478L	2277	2397	36	78	24	113.6	6.13	
BRT36P2484L	2335	2462	36	84	24	120.2	6.42	
BRT36P3036L	2098	2162	36	36	30	83.4	5.00	
BRT36P3042L	2195	2283	36	42	30	90.5	5.26	
BRT36P3048L	2252	2344	36	48	30	98.7	5.53	
BRT36P3054L	2354	2448	36	54	30	106.8	5.79	
BRT36P3060L	2421	2529	36	60	30	115.0	6.06	
BRT36P3066L	2474	2591	36	66	30	123.1	6.32	
BRT36P3072L	2538	2658	36	72	30	131.3	6.59	
BRT36P3078L	2603	2728	36	78	30	139.4	6.95	
BRT36P3084L	2683	2820	36	84	30	147.6	7.32	
BRT36P3642L	2387	2471	36	42	36	99.4	6.56	
BRT36P3648L	2474	2566	36	48	36	108.5	6.87	
BRT36P3654L	2592	2697	36	54	36	117.7	7.18	
BRT36P3660L	2680	2794	36	60	36	125.8	7.48	
BRT36P3666L	2764	2893	36	66	36	135.0	7.79	
BRT36P3672L	2849	2988	36	72	36	144.1	8.10	
BRT36P3678L	2933	3083	36	78	36	152.3	8.50	
BRT36P3684L	3014	3174	36	84	36	161.4	8.91	

BRT36A-L • Rectangular Legs - 36" High Add-On (Levelers)

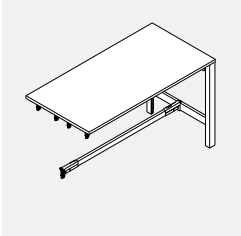

- Single table assembly consists of one work-surface, one H leg assembly and all required beams.
- 24" deep tables have three (3) beams at the top, and one bottom beam.
- 30" and 36" deep tables have four (4) beams at the top, and one bottom beam.
- Finish option, please choose from:
 - 1) anodized aluminum vertical legs with powder coated steel horizontal structural members. Anodized aluminum leg upcharge of \$55 for this configuration
 - 2) powder coated aluminum vertical legs with steel horizontal structural members Choose from standard metal finishes
- Worksurface available in LP and HP.

PRODUCT CODE	PRICE		SIZE/INCHES				WEIGHT LBS	VOL FT ³
	LP	HP	H	W	D			
BRT36A2436L	1366	1418	36	36	24	54.2	2.87	
BRT36A2442L	1427	1494	36	42	24	61.7	3.08	
BRT36A2448L	1500	1583	36	48	24	67.2	3.30	
BRT36A2454L	1606	1697	36	54	24	73.7	3.51	
BRT36A2460L	1673	1781	36	60	24	80.2	3.73	
BRT36A2466L	1724	1833	36	66	24	86.8	3.94	
BRT36A2472L	1771	1887	36	72	24	93.3	4.15	
BRT36A2478L	1830	1950	36	78	24	99.8	4.45	
BRT36A2484L	1890	2016	36	84	24	106.3	4.74	
BRT36A3036L	1624	1687	36	36	30	67.5	3.24	
BRT36A3042L	1720	1807	36	42	30	74.7	3.50	
BRT36A3048L	1777	1867	36	48	30	82.8	3.77	
BRT36A3054L	1879	1970	36	54	30	91.0	4.03	
BRT36A3060L	1945	2054	36	60	30	99.1	4.30	
BRT36A3066L	1999	2115	36	66	30	107.3	4.56	
BRT36A3072L	2064	2182	36	72	30	115.4	4.83	
BRT36A3078L	2129	2254	36	78	30	123.6	5.19	
BRT36A3084L	2209	2345	36	84	30	131.7	5.56	
BRT36A3642L	1845	1927	36	42	36	81.6	4.30	
BRT36A3648L	1929	2025	36	48	36	90.8	4.61	
BRT36A3654L	2050	2155	36	54	36	99.9	4.92	
BRT36A3660L	2136	2254	36	60	36	108.1	5.22	
BRT36A3666L	2222	2350	36	66	36	117.2	5.53	
BRT36A3672L	2308	2446	36	72	36	126.4	5.84	
BRT36A3678L	2390	2540	36	78	36	134.5	6.24	
BRT36A3684L	2472	2630	36	84	36	143.7	6.65	

BRT42P-C • Rectangular Legs - 42" High Pod (Casters)

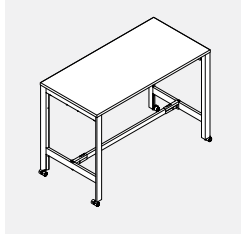

- Single table assembly consists of one work-surface, two H leg assemblies and all required beams.
- 24" deep tables have three (3) beams at the top, and one bottom beam.
- 30" and 36" deep tables have four (4) beams at the top, and one bottom beam.
- 40mm white locking casters with grey tires
- Finish option, please choose from:
 - 1) anodized aluminum vertical legs with powder coated steel horizontal structural members. Anodized aluminum leg upcharge of \$110 for this configuration
 - 2) powder coated aluminum vertical legs with steel horizontal structural members. Choose from standard metal finishes
- Worksurface available in LP and HP.

PRODUCT CODE	PRICE		SIZE / INCHES			WEIGHT LBS	VOL FT ³
	LP	HP	H	W	D		
BRT42P2436C	1935	1987	42	36	24	70.4	5.11
BRT42P2442C	1995	2063	42	42	24	77.9	5.32
BRT42P2448C	2068	2152	42	48	24	83.4	5.54
BRT42P2454C	2175	2266	42	54	24	89.9	5.75
BRT42P2460C	2243	2349	42	60	24	96.5	5.97
BRT42P2466C	2292	2400	42	66	24	103.0	6.18
BRT42P2472C	2339	2454	42	72	24	109.5	6.39
BRT42P2478C	2399	2518	42	78	24	116.0	6.69
BRT42P2484C	2457	2586	42	84	24	122.5	6.98
BRT42P3036C	2222	2285	42	36	30	85.8	5.60
BRT42P3042C	2318	2404	42	42	30	92.9	5.86
BRT42P3048C	2375	2465	42	48	30	101.1	6.13
BRT42P3054C	2477	2569	42	54	30	109.2	6.39
BRT42P3060C	2543	2652	42	60	30	117.4	6.66
BRT42P3066C	2595	2714	42	66	30	125.5	6.92
BRT42P3072C	2660	2782	42	72	30	133.7	7.19
BRT42P3078C	2727	2850	42	78	30	141.8	7.55
BRT42P3084C	2807	2945	42	84	30	150.0	7.92
BRT42P3642C	2510	2593	42	42	36	101.8	7.34
BRT42P3648C	2595	2688	42	48	36	110.9	7.65
BRT42P3654C	2715	2820	42	54	36	120.1	7.96
BRT42P3660C	2803	2918	42	60	36	128.2	8.26
BRT42P3666C	2888	3015	42	66	36	137.4	8.57
BRT42P3672C	2973	3111	42	72	36	146.5	8.88
BRT42P3678C	3056	3205	42	78	36	154.7	9.28
BRT42P3684C	3138	3295	42	84	36	163.8	9.69

BRT42P-L • Rectangular Legs - 42" High Pod (Levelers)

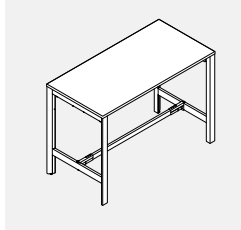

- Single table assembly consists of one work-surface, two H leg assemblies and all required beams.
- 24" deep tables have three (3) beams at the top, and one bottom beam.
- 30" and 36" deep tables have four (4) beams at the top, and one bottom beam.
- Finish option, please choose from:
 - 1) anodized aluminum vertical legs with powder coated steel horizontal structural members. Anodized aluminum leg upcharge of \$110 for this configuration
 - 2) powder coated aluminum vertical legs with steel horizontal structural members. Choose from standard metal finishes
- Worksurface available in LP and HP.

PRODUCT CODE	PRICE		SIZE / INCHES			WEIGHT LBS	VOL FT ³
	LP	HP	H	W	D		
BRT42P2436L	1858	1906	42	36	24	69.94	5.11
BRT42P2442L	1917	1983	42	42	24	77.46	5.32
BRT42P2448L	1990	2071	42	48	24	82.98	5.54
BRT42P2454L	2096	2190	42	54	24	89.50	5.75
BRT42P2460L	2166	2270	42	60	24	96.02	5.97
BRT42P2466L	2213	2322	42	66	24	102.54	6.18
BRT42P2472L	2261	2377	42	72	24	109.06	6.39
BRT42P2478L	2321	2442	42	78	24	115.58	6.69
BRT42P2484L	2379	2507	42	84	24	122.10	6.98
BRT42P3036L	2145	2207	42	36	30	85.33	5.60
BRT42P3042L	2237	2325	42	42	30	92.48	5.86
BRT42P3048L	2296	2388	42	48	30	100.63	6.13
BRT42P3054L	2399	2490	42	54	30	108.78	6.39
BRT42P3060L	2464	2574	42	60	30	116.93	6.66
BRT42P3066L	2517	2635	42	66	30	125.08	6.92
BRT42P3072L	2583	2703	42	72	30	133.23	7.19
BRT42P3078L	2650	2772	42	78	30	141.38	7.55
BRT42P3084L	2728	2864	42	84	30	149.53	7.92
BRT42P3642L	2430	2515	42	42	36	101.34	7.34
BRT42P3648L	2517	2613	42	48	36	110.49	7.65
BRT42P3654L	2637	2742	42	54	36	119.64	7.96
BRT42P3660L	2724	2841	42	60	36	127.79	8.26
BRT42P3666L	2809	2936	42	66	36	136.94	8.57
BRT42P3672L	2894	3033	42	72	36	146.09	8.88
BRT42P3678L	2978	3126	42	78	36	154.24	9.28
BRT42P3684L	3059	3216	42	84	36	163.39	9.69

BRT42A-L • Rectangular Legs - 42" High Add-On (Levelers)

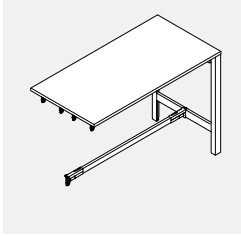

- **Single table assembly consists of one work-surface, one H leg assembly and all required beams.**
- 24" deep tables have three (3) beams at the top, and one bottom beam.
- 30" and 36" deep tables have four (4) beams at the top, and one bottom beam.
- Finish option, please choose from:
 - 1) anodized aluminum vertical legs with powder coated steel horizontal structural members. Anodized aluminum leg upcharge of \$55 for this configuration
 - 2) powder coated aluminum vertical legs with steel horizontal structural members. Choose from standard metal finishes
- Worksurface available in LP and HP.

PRODUCT CODE	PRICE		SIZE/INCHES			WEIGHT LBS	VOL FT ³
	LP	HP	H	W	D		
BRT42A2436L	1389	1440	42	36	24	55.15	3.15
BRT42A2442L	1450	1516	42	42	24	62.67	3.36
BRT42A2448L	1522	1605	42	48	24	68.19	3.58
BRT42A2454L	1628	1722	42	54	24	74.71	3.79
BRT42A2460L	1696	1802	42	60	24	81.23	4.01
BRT42A2466L	1747	1855	42	66	24	87.75	4.22
BRT42A2472L	1792	1906	42	72	24	94.27	4.43
BRT42A2478L	1852	1973	42	78	24	100.79	4.73
BRT42A2484L	1913	2038	42	84	24	107.31	5.02
BRT42A3036L	1647	1708	42	36	30	68.52	3.54
BRT42A3042L	1739	1829	42	42	30	75.67	3.80
BRT42A3048L	1799	1891	42	48	30	83.82	4.07
BRT42A3054L	1901	1993	42	54	30	91.97	4.33
BRT42A3060L	1967	2076	42	60	30	100.12	4.60
BRT42A3066L	2020	2136	42	66	30	108.27	4.86
BRT42A3072L	2086	2206	42	72	30	116.42	5.13
BRT42A3078L	2152	2276	42	78	30	124.57	5.49
BRT42A3084L	2231	2366	42	84	30	132.72	5.86
BRT42A3642L	1866	1950	42	42	36	82.60	4.69
BRT42A3648L	1954	2046	42	48	36	91.75	5.00
BRT42A3654L	2070	2178	42	54	36	100.90	5.31
BRT42A3660L	2158	2276	42	60	36	109.05	5.61
BRT42A3666L	2245	2372	42	66	36	118.20	5.92
BRT42A3672L	2330	2467	42	72	36	127.35	6.23
BRT42A3678L	2413	2562	42	78	36	135.50	6.63
BRT42A3684L	2493	2653	42	84	36	144.65	7.04

BRTSQ • Rectangular Legs - Meeting Table - Rectangular

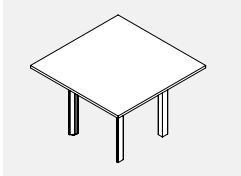

- **Rectangular meeting tables; levelers or casters**
- LP or HP tops, 3mm edging.
- Anodized aluminum leg upcharge of \$110 for this configuration.
- Includes top, legs and beam.
- L = Levelers
- C = Casters
- Worksurface available in HP and LP. For wood veneer tops, please contact your Customer Service Representative.

PRODUCT CODE	PRICE		SIZE/INCHES			WEIGHT LBS	VOL FT ³
	LP	HP	H	W	D		
BRTSQ42L	1221	1349	29	42	42	85	4.20
BRTSQ42C	1285	1414	29	42	42	85	4.20

BRTR • Rectangular Legs - Meeting Table - Round

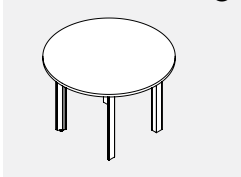

- **Round meeting tables; levelers or casters**
- LP or HP tops, 3mm edging.
- Anodized aluminum leg upcharge of \$110 for this configuration.
- Includes top, legs and beam.
- L = Levelers
- C = Casters
- Worksurface available in HP and LP. For wood veneer tops, please contact your Customer Service Representative.

PRODUCT CODE	PRICE		SIZE/INCHES			WEIGHT LBS	VOL FT ³
	LP	HP	H	W	D		
BRTR42L	1221	1349	29	42	42	65	3.90
BRTR42C	1285	1414	29	42	42	65	3.90

BRTSLDT72C • Rectangular Legs - Rail Sliding Table Kit

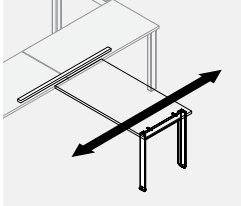

- **Includes leg, leg support, sliding bracket hardware, 72" rail and hardware to secure table. Worksurface not included.**
- 40mm dia. locking casters with 8mm thread, white body and grey tires.
- Legs included are for 24" deep worksurfaces.
- Anodized aluminum leg upcharge of \$55 for this configuration.
- Maximum length of the sliding table surface is 48".

PRODUCT CODE	PRICE	SIZE/INCHES			WEIGHT LBS	VOL FT ³
		H	W	D		
BRTSLDT72C	646	29	48	72	28.5	2.40

BRTS1P-LR • Round Legs Single Line 1 Person Pod (Levelers)

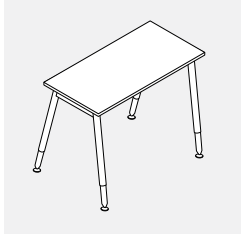

- Single Line Table Assemblies consist of one worksurface, two leg assemblies and one horizontal structural beam.
- Worksurface available in HP and LP. For wood veneer tops, please contact your Customer Service Representative.

PRODUCT CODE	PRICE		SIZE/INCHES			WEIGHT VOL	
	LP	HP	H	W	D	LBS	FT ³
BRTS1P2436LR	1048	1084	29	36	24	45	4.00
BRTS1P2442LR	1084	1135	29	42	24	48	4.10
BRTS1P2448LR	1133	1217	29	48	24	51	4.20
BRTS1P2451LR	1163	1232	29	50.5	24	54	4.30
BRTS1P2454LR	1207	1286	29	54	24	57	4.40
BRTS1P2460LR	1233	1342	29	60	24	60	4.48
BRTS1P2463LR	1250	1355	29	62.5	24	63	4.57
BRTS1P2466LR	1258	1366	29	66	24	66	4.65
BRTS1P2472LR	1282	1395	29	72	24	69	4.73
BRTS1P2478LR	1316	1433	29	78	24	72	4.82
BRTS1P2484LR	1354	1481	29	84	24	75	4.92
BRTS1P3036LR	1019	1080	29	36	30	45	4.00
BRTS1P3042LR	1136	1225	29	42	30	48	4.10
BRTS1P3048LR	1162	1253	29	48	30	51	4.20
BRTS1P3051LR	1198	1291	29	50.5	30	54	4.30
BRTS1P3054LR	1221	1312	29	54	30	57	4.40
BRTS1P3060LR	1251	1343	29	60	30	60	4.48
BRTS1P3063LR	1261	1374	29	62.5	30	63	4.57
BRTS1P3066LR	1268	1387	29	66	30	66	4.65
BRTS1P3072LR	1300	1406	29	72	30	69	4.73
BRTS1P3078LR	1332	1456	29	78	30	72	4.82
BRTS1P3084LR	1387	1522	29	84	30	75	4.92

BRTS1P-CR • Round Legs Single Line 1 Person Pod (Casters)



- Single Line Table Assemblies consist of one worksurface, two leg assemblies and one horizontal structural beam.
- Worksurface available in HP and LP. For wood veneer tops, please contact your Customer Service Representative.

PRODUCT CODE	PRICE		SIZE/INCHES			WEIGHT VOL	
	LP	HP	H	W	D	LBS	FT ³
BRTS1P2436CR	1124	1162	29	36	24	45	4.00
BRTS1P2442CR	1162	1210	29	42	24	48	4.10
BRTS1P2448CR	1207	1290	29	48	24	51	4.20
BRTS1P2451CR	1238	1312	29	50.5	24	54	4.30
BRTS1P2454CR	1287	1363	29	54	24	57	4.40
BRTS1P2460CR	1313	1418	29	60	24	60	4.48
BRTS1P2463CR	1326	1432	29	62.5	24	63	4.57
BRTS1P2466CR	1334	1444	29	66	24	66	4.65
BRTS1P2472CR	1356	1473	29	72	24	69	4.73
BRTS1P2478CR	1393	1514	29	78	24	72	4.82
BRTS1P2484CR	1431	1558	29	84	24	75	4.92
BRTS1P3036CR	1095	1159	29	36	30	45	4.00
BRTS1P3042CR	1217	1301	29	42	30	48	4.10
BRTS1P3048CR	1236	1329	29	48	30	51	4.20
BRTS1P3051CR	1277	1370	29	50.5	30	54	4.30
BRTS1P3054CR	1294	1388	29	54	30	57	4.40
BRTS1P3060CR	1327	1420	29	60	30	60	4.48
BRTS1P3063CR	1338	1452	29	62.5	30	63	4.57
BRTS1P3066CR	1349	1464	29	66	30	66	4.65
BRTS1P3072CR	1383	1483	29	72	30	69	4.73
BRTS1P3078CR	1412	1535	29	78	30	72	4.82
BRTS1P3084CR	1464	1599	29	84	30	75	4.92

BRTS2P-LR • Round Legs Single Line 2 Person Pod (Levelers)



- Single Line Table Assemblies consists of 2 worksurfaces, 3 leg assemblies and 2 horizontal structural beams.
- Worksurface available in HP and LP. For wood veneer tops, please contact your Customer Service Representative.

PRODUCT CODE	PRICE		SIZE/INCHES			WEIGHT VOL	
	LP	HP	H	W	D	LBS	FT ³
BRTS2P2448LR	1923	2086	29	96	24	95	6.21
BRTS2P2454LR	2043	2225	29	108	24	104	6.45
BRTS2P2460LR	2127	2341	29	120	24	113	6.71
BRTS2P2466LR	2179	2391	29	132	24	122	6.95
BRTS2P2472LR	2219	2451	29	144	24	131	7.13
BRTS2P2478LR	2287	2527	29	156	24	140	7.27
BRTS2P2484LR	2378	2617	29	168	24	149	7.41
BRTS2P3048LR	2011	2195	29	96	30	113	6.57
BRTS2P3054LR	2094	2280	29	108	30	122	6.85
BRTS2P3060LR	2156	2376	29	120	30	131	7.13
BRTS2P3066LR	2198	2429	29	132	30	140	7.41
BRTS2P3072LR	2259	2501	29	144	30	155	7.69
BRTS2P3078LR	2323	2574	29	156	30	164	7.97
BRTS2P3084LR	2429	2702	29	168	30	173	8.25

BRTS3P-LR • Round Legs Single Line 3 Person Pod (Levelers)

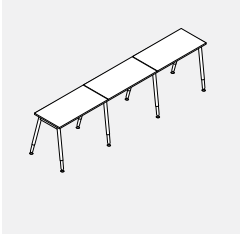

- Single Line, 3-person workstation consists of 3 worksurfaces, 4 leg assemblies and 3 horizontal structural beams.
- Worksurface available in HP and LP. For wood veneer tops, please contact your Customer Service Representative.

PRODUCT CODE	PRICE		SIZE/INCHES			WEIGHT VOL	
	LP	HP	H	W	D	LBS	FT ³
BRTS3P2448LR	2709	2957	29	144	24	138	8.47
BRTS3P2454LR	2894	3168	29	162	24	152	8.68
BRTS3P2460LR	3020	3340	29	180	24	165	8.89
BRTS3P2466LR	3087	3418	29	198	24	179	9.11
BRTS3P2472LR	3156	3506	29	216	24	192	9.32
BRTS3P2478LR	3259	3621	29	234	24	206	9.53
BRTS3P2484LR	3378	3754	29	252	24	219	9.74
BRTS3P3048LR	2846	3123	29	144	30	161	9.01
BRTS3P3054LR	2973	3249	29	162	30	178	9.44
BRTS3P3060LR	3064	3392	29	180	30	195	9.87
BRTS3P3066LR	3126	3476	29	198	30	212	10.30
BRTS3P3072LR	3219	3582	29	216	30	229	10.72
BRTS3P3078LR	3315	3687	29	234	30	246	11.16
BRTS3P3084LR	3476	3881	29	252	30	263	11.59

BRTS4P-LR • Round Legs Single Line 4 Person Pod (Levelers)

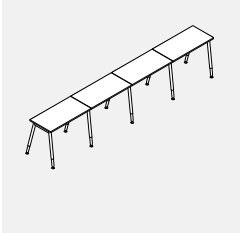

- Single Line, 4-person workstation consists of 4 worksurfaces, 5 leg assemblies and 3 horizontal structural beams.
- Worksurface available in HP and LP. For wood veneer tops, please contact your Customer Service Representative.

PRODUCT CODE	PRICE		SIZE/INCHES			WEIGHT VOL	
	LP	HP	H	W	D	LBS	FT ³
BRTS4P2448LR	3460	3828	29	192	24	180	10.73
BRTS4P2454LR	3743	4111	29	216	24	199	11.22
BRTS4P2460LR	3898	4338	29	240	24	217	11.71
BRTS4P2466LR	4004	4443	29	264	24	236	12.20
BRTS4P2472LR	4093	4556	29	288	24	254	12.69
BRTS4P2478LR	4236	4711	29	312	24	273	13.18
BRTS4P2484LR	4389	4893	29	336	24	291	13.67
BRTS4P3048LR	3680	4047	29	192	30	213	11.45
BRTS4P3054LR	3846	4215	29	216	30	235	12.02
BRTS4P3060LR	3970	4409	29	240	30	257	12.59
BRTS4P3066LR	4055	4518	29	264	30	279	13.16
BRTS4P3072LR	4177	4660	29	288	30	301	13.73
BRTS4P3078LR	4304	4803	29	312	30	323	14.30
BRTS4P3084LR	4518	5063	29	336	30	345	14.87

BRTBAR2P-LR • Round Legs Back 2 Back 2 Person Pod (Levelers)

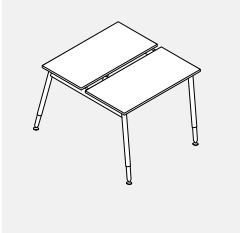

- Back 2 Back, 2-person workstation consists of 2 worksurfaces, 2 Back 2 Back leg assemblies and 2 horizontal structural beams.
- Worksurface available in HP and LP. For wood veneer tops, please contact your Customer Service Representative.

PRODUCT CODE	PRICE		SIZE/INCHES			WEIGHT VOL	
	LP	HP	H	W	D	LBS	FT ³
BRTBAR2P2460LR	1991	2203	29	60	50.5	110	8.56
BRTBAR2P2466LR	2037	2256	29	66	50.5	119	8.76
BRTBAR2P2472LR	2083	2314	29	72	50.5	128	9.02
BRTBAR2P2478LR	2154	2391	29	78	50.5	137	9.20
BRTBAR2P2484LR	2215	2464	29	84	50.5	146	9.40
BRTBAR2P3060LR	1851	2239	29	60	62.5	130	9.00
BRTBAR2P3066LR	2063	2295	29	66	62.5	141	9.25
BRTBAR2P3072LR	2124	2358	29	72	62.5	152	9.54
BRTBAR2P3078LR	2190	2435	29	78	62.5	163	9.80
BRTBAR2P3084LR	2295	2567	29	84	62.5	174	10.4

BRTBAR2PA-LR • Round Legs Back 2 Back 2 Person Pod with Access Door (Levelers)

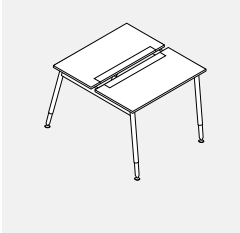

- Back 2 Back, 2-person workstation consists of 2 worksurfaces, 2 Back 2 Back leg assemblies and 2 horizontal structural beams.
- Anodized aluminum worksurface door provides access to power / data through below worksurface.
- Worksurface with access doors cannot be combined with above worksurface power trough.
- Worksurface available in HP and LP.

PRODUCT CODE	PRICE		SIZE/INCHES			WEIGHT VOL	
	LP	HP	H	W	D	LBS	FT ³
BRTBAR2PA2460LR	2068	2376	29	60	50.5	110	8.56
BRTBAR2PA2466LR	2149	2488	29	66	50.5	119	8.76
BRTBAR2PA2472LR	2231	2617	29	72	50.5	128	9.02
BRTBAR2PA3060LR	2198	2586	29	60	62.5	130	9.00
BRTBAR2PA3066LR	2312	2730	29	66	62.5	141	9.25
BRTBAR2PA3072LR	2391	2861	29	72	62.5	152	9.54

BRTBAR2PDA-LR • Round Legs Back 2 Back 2 Person Pod with Access Door (Levelers)

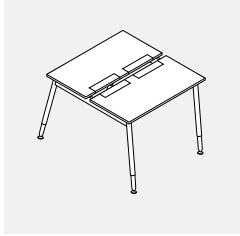

- Back 2 Back, 2-person workstation consists of 2 worksurfaces, 2 Back 2 Back leg assemblies and 2 horizontal structural beams.
- These tables feature dual access doors providing a central connection point for monitor lifts.
- Anodized aluminum worksurface door provides access to power / data through below worksurface.
- Worksurface with access doors cannot be combined with above worksurface power trough.
- Worksurface available in HP and LP.

PRODUCT CODE	PRICE		SIZE/INCHES			WEIGHT VOL	
	LP	HP	H	W	D	LBS	FT ³
BRTBAR2PDA2460LR	2234	2567	29	60	50.5	110	8.56
BRTBAR2PDA2466LR	2322	2687	29	66	50.5	119	8.76
BRTBAR2PDA2472LR	2408	2826	29	72	50.5	128	9.02
BRTBAR2PDA2478LR	2462	2896	29	78	50.5	137	9.20
BRTBAR2PDA2484LR	2514	3002	29	84	50.5	146	9.40
BRTBAR2PDA3060LR	2372	2792	29	60	62.5	130	9.00
BRTBAR2PDA3066LR	2496	2950	29	66	62.5	141	9.25
BRTBAR2PDA3072LR	2582	3090	29	72	62.5	152	9.54
BRTBAR2PDA3078LR	2637	3193	29	78	62.5	163	9.80
BRTBAR2PDA3084LR	2723	3315	29	84	62.5	174	10.4

BRTBAR4P-LR • Round Legs Back 2 Back 4 Person Pod (Levelers)

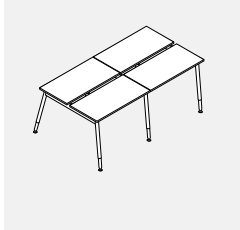

- Back 2 Back, 4-person workstation consists of 4 worksurfaces, 3 Back 2 Back leg assemblies and 4 horizontal structural beams.
- Worksurface available in HP and LP. For wood veneer tops, please contact your Customer Service Representative.

PRODUCT CODE	PRICE		SIZE/INCHES			WEIGHT VOL	
	LP	HP	H	W	D	LBS	FT ³
BRTBAR4P2460LR	3539	3962	29	120	50.5	208	13.82
BRTBAR4P2466LR	3627	4068	29	132	50.5	224	14.28
BRTBAR4P2472LR	3717	4183	29	144	50.5	240	14.74
BRTBAR4P2478LR	3862	4338	29	156	50.5	256	15.20
BRTBAR4P2484LR	4015	4518	29	168	50.5	272	15.66
BRTBAR4P3060LR	3627	4068	29	120	62.5	253	14.70
BRTBAR4P3066LR	3649	4111	29	132	62.5	273	15.24
BRTBAR4P3072LR	3803	4286	29	144	62.5	293	15.78
BRTBAR4P3078LR	3930	4428	29	156	62.5	313	16.32
BRTBAR4P3084LR	4145	4685	29	168	62.5	333	16.86

BRTBAR4PA-LR • Round Legs Back 2 Back 4 Person Pod with Access Door (Levelers)

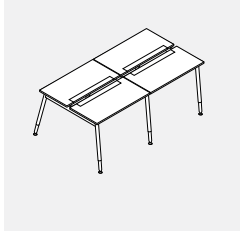

- Back 2 Back, 4-person workstation consists of 4 worksurfaces, 3 Back 2 Back leg assemblies and 4 horizontal structural beams.
- Anodized aluminum worksurface door provides access to power / data through below worksurface.
- Worksurface with access doors cannot be combined with above worksurface power trough.
- Worksurface available in HP and LP.

PRODUCT CODE	PRICE		SIZE/INCHES			WEIGHT VOL	
	LP	HP	H	W	D	LBS	FT ³
BRTBAR4PA2460LR	3691	4304	29	120	50.5	208	13.82
BRTBAR4PA2466LR	3926	4604	29	132	50.5	224	14.28
BRTBAR4PA2472LR	4015	4789	29	144	50.5	240	14.74
BRTBAR4PA3060LR	3983	4759	29	120	62.5	253	14.70
BRTBAR4PA3066LR	4241	5015	29	132	62.5	273	15.24
BRTBAR4PA3072LR	4338	5273	29	144	62.5	293	15.78

BRTBAR4PDA-LR • Round Legs Back 2 Back 4 Person Pod with Access Door (Levelers)



- Back 2 Back, 4-person workstation consists of 4 worksurfaces, 3 Back 2 Back leg assemblies and 4 horizontal structural beams.
- These tables feature dual access doors providing a central connection point for monitor lifts.
- Anodized aluminum worksurface door provides access to power / data through below worksurface.
- Worksurface with access doors cannot be combined with above worksurface power trough.
- Worksurface available in HP and LP.

PRODUCT CODE	PRICE		SIZE/INCHES			WEIGHT VOL	
	LP	HP	H	W	D	LBS	FT ³
BRTBAR4PDA2460LR	3986	4649	29	120	50.5	208	13.82
BRTBAR4PDA2466LR	4239	4973	29	132	50.5	224	14.28
BRTBAR4PDA2472LR	4337	5172	29	144	50.5	240	14.74
BRTBAR4PDA2478LR	4440	5312	29	156	50.5	256	15.20
BRTBAR4PDA2484LR	4579	5555	29	168	50.5	272	15.66
BRTBAR4PDA3060LR	4301	5139	29	120	62.5	253	14.70
BRTBAR4PDA3066LR	4579	5415	29	132	62.5	273	15.24
BRTBAR4PDA3072LR	4684	5695	29	144	62.5	293	15.78
BRTBAR4PDA3078LR	4789	5906	29	156	62.5	313	16.32
BRTBAR4PDA3084LR	4963	6148	29	168	62.5	333	16.86

BRTBAR6P-LR • Round Legs Back 2 Back 6 Person Pod (Levelers)



- Back 2 Back, 6-person workstation consists of 6 worksurfaces, 4 Back 2 Back leg assemblies and 6 horizontal structural beams.
- Worksurface available in HP and LP. For wood veneer tops, please contact your Customer Service Representative.

PRODUCT CODE	PRICE		SIZE/INCHES			WEIGHT VOL	
	LP	HP	H	W	D	LBS	FT ³
BRTBAR6P2460LR	5083	5734	29	180	50.5	308	19.76
BRTBAR6P2466LR	5218	5877	29	198	50.5	329	20.54
BRTBAR6P2472LR	5354	6052	29	216	50.5	359	21.32
BRTBAR6P2478LR	5568	6283	29	234	50.5	409	22.10
BRTBAR6P2484LR	5800	6554	29	252	50.5	434	22.88
BRTBAR6P3060LR	5170	5830	29	180	62.5	369	21.08
BRTBAR6P3066LR	5297	5995	29	198	62.5	400	21.97
BRTBAR6P3072LR	5480	6206	29	216	62.5	431	22.86
BRTBAR6P3078LR	5676	6419	29	234	62.5	462	23.75
BRTBAR6P3084LR	6002	6807	29	252	62.5	493	24.53

BRTBAR6PA-LR • Round Legs Back 2 Back 6 Person Pod with Access Door (Levelers)

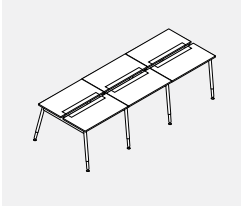

- **Back 2 Back, 6-person workstation consists of 6 worksurfaces, 4 Back 2 Back leg assemblies and 6 horizontal structural beams.**
- Anodized aluminum worksurface door provides access to power / data through below worksurface.
- Worksurface with access doors cannot be combined with above worksurface power trough.
- Worksurface available in HP and LP.

PRODUCT CODE	PRICE		SIZE/INCHES			WEIGHT VOL	
	LP	HP	H	W	D	LBS	FT ³
BRTBAR6PA2460LR	5317	6237	29	180	50.5	308	19.76
BRTBAR6PA2466LR	5556	6576	29	198	50.5	329	20.54
BRTBAR6PA2472LR	5800	6964	29	216	50.5	359	21.32
BRTBAR6PA3060LR	5705	6865	29	180	62.5	369	21.08
BRTBAR6PA3066LR	6041	7301	29	198	62.5	400	21.97
BRTBAR6PA3072LR	6283	7688	29	216	62.5	431	22.86

BRTBAR6PDA-LR • Round Legs Back 2 Back 6 Person Pod with Access Door (Levelers)



- **Back 2 Back, 6-person workstation consists of 6 worksurfaces, 4 Back 2 Back leg assemblies and 6 horizontal structural beams.**
- These tables feature dual access doors providing a central connection point for monitor lifts.
- Anodized aluminum worksurface door provides access to power / data through below worksurface.
- Worksurface with access doors cannot be combined with above worksurface power trough.
- Worksurface available in HP and LP.

PRODUCT CODE	PRICE		SIZE/INCHES			WEIGHT VOL	
	LP	HP	H	W	D	LBS	FT ³
BRTBAR6PDA2460LR	5742	6735	29	180	50.5	308	19.76
BRTBAR6PDA2466LR	6001	7102	29	198	50.5	329	20.54
BRTBAR6PDA2472LR	6266	7520	29	216	50.5	359	21.32
BRTBAR6PDA2478LR	6419	7726	29	234	50.5	409	22.10
BRTBAR6PDA2484LR	6632	8093	29	252	50.5	434	22.88
BRTBAR6PDA3060LR	6160	7413	29	180	62.5	369	21.08
BRTBAR6PDA3066LR	6524	7886	29	198	62.5	400	21.97
BRTBAR6PDA3072LR	6787	8302	29	216	62.5	431	22.86
BRTBAR6PDA3078LR	6943	8615	29	234	62.5	462	23.75
BRTBAR6PDA3084LR	7203	8984	29	252	62.5	493	24.53

BRTBAR8P-LR • Round Legs Back 2 Back 8 Person Pod (Levelers)

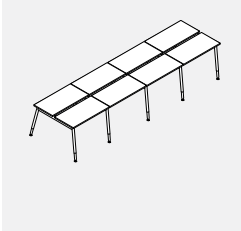

- **Back 2 Back, 8-person workstation consists of 8 worksurfaces, 5 Back 2 Back leg assemblies and 8 horizontal structural beams.**
- Worksurface available in HP and LP. For wood veneer tops, please contact your Customer Service Representative.

PRODUCT CODE	PRICE		SIZE/INCHES			WEIGHT VOL	
	LP	HP	H	W	D	LBS	FT ³
BRTBAR8P2460LR	6629	7481	29	240	50.5	412	24.42
BRTBAR8P2466LR	6811	7688	29	264	50.5	448	25.30
BRTBAR8P2472LR	6992	7921	29	288	50.5	484	26.30
BRTBAR8P2478LR	7275	8230	29	312	50.5	520	27.30
BRTBAR8P2484LR	7598	8592	29	336	50.5	556	28.30
BRTBAR8P3060LR	6744	7622	29	240	62.5	492	26.18
BRTBAR8P3066LR	6914	7842	29	264	62.5	536	27.28
BRTBAR8P3072LR	7160	8128	29	288	62.5	581	28.38
BRTBAR8P3078LR	7415	8412	29	312	62.5	625	29.48
BRTBAR8P3084LR	7842	8927	29	336	62.5	669	30.58

BRTBAR8PA-LR • Round Legs Back 2 Back 8 Person Pod with Access Door (Levelers)

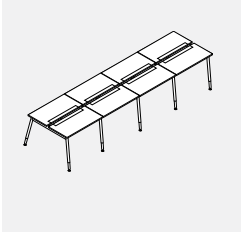

- **Back 2 Back, 8-person workstation consists of 8 worksurfaces, 5 Back 2 Back leg assemblies and 8 horizontal structural beams.**
- Anodized aluminum worksurface door provides access to power / data through below worksurface.
- Worksurface with access doors cannot be combined with above worksurface power trough.
- Worksurface available in HP and LP.

PRODUCT CODE	PRICE		SIZE/INCHES			WEIGHT VOL	
	LP	HP	H	W	D	LBS	FT ³
BRTBAR8PA2460LR	6940	8166	29	240	50.5	412	24.42
BRTBAR8PA2466LR	7261	8616	29	264	50.5	448	25.30
BRTBAR8PA2472LR	7585	9134	29	288	50.5	484	26.30
BRTBAR8PA3060LR	7456	9005	29	240	62.5	492	26.18
BRTBAR8PA3066LR	7907	9585	29	264	62.5	536	27.28
BRTBAR8PA3072LR	8230	10101	29	288	62.5	581	28.38

BRTBAR8PDA-LR • Round Legs Back 2 Back 8 Person Pod with Access Door (Levelers)

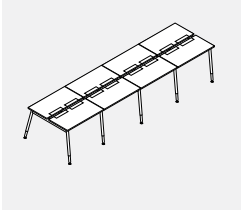

- **Back 2 Back, 8-person workstation consists of 8 worksurfaces, 5 Back 2 Back leg assemblies and 8 horizontal structural beams.**
- These tables feature dual access doors providing a central connection point for monitor lifts.
- Anodized aluminum worksurface door provides access to power / data through below worksurface.
- Worksurface with access doors cannot be combined with above worksurface power trough.
- Worksurface available in HP and LP.

PRODUCT CODE	PRICE		SIZE/INCHES			WEIGHT VOL	
	LP	HP	H	W	D	LBS	FT ³
BRTBAR8PDA2460LR	7494	8819	29	240	50.5	412	24.42
BRTBAR8PDA2466LR	7842	9307	29	264	50.5	448	25.30
BRTBAR8PDA2472LR	8193	9865	29	288	50.5	484	26.30
BRTBAR8PDA2478LR	8400	10145	29	312	50.5	520	27.30
BRTBAR8PDA2484LR	8677	10630	29	336	50.5	556	28.30
BRTBAR8PDA3060LR	8053	9725	29	240	62.5	492	26.18
BRTBAR8PDA3066LR	8540	10353	29	264	62.5	536	27.28
BRTBAR8PDA3072LR	8888	10911	29	288	62.5	581	28.38
BRTBAR8PDA3078LR	9097	11328	29	312	62.5	625	29.48
BRTBAR8PDA3084LR	9447	11817	29	336	62.5	669	30.58

BRTSLDT72CR • Sliding Table Kit (Round Legs)



- **Includes leg, leg support, sliding bracket hardware, 72" rail and hardware to secure table. Worksurface not included.**
- Maximum length of the Sliding Table surface is 48".
- Locking casters are 3" diameter as standard.

PRODUCT CODE	PRICE	SIZE/INCHES			WEIGHT VOL	
		H	W	D	LBS	FT ³
BRTSLDT72CR	646	29	48	72	28.5	2.40

BRTSL-C • Single Leg Assembly (Casters)

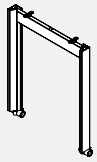

- Two Single Leg Assemblies form the structure of the Bridges series Single Table.
- 40mm white locking casters with grey tires; steel frame, aluminum legs.
- Anodized aluminum leg upcharge \$55.
- Please specify paint finish for support.

PRODUCT CODE	PRICE	SIZE/INCHES			WEIGHT VOL	
		H	W	D	LBS	FT ³
BRTSL24C	426	28	2.5	24	8	1.34
BRTSL30C	443	28	2.5	30	8	1.41
BRTSL36C	462	28	2.5	36	8	1.81

BRTSL-L • Single Leg Assembly (Levelers)

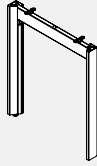

- Two Single Leg Assemblies form the structure of the Bridges series Single Line Tables.
- One leg can be shared by 2 adjoining worksurfaces.
- Leveling glides, steel frame, aluminum legs.
- Anodized aluminum leg upcharge \$55.
- Please specify paint finish for support.
- Please specify 2 beams when using BRTSL36L.

PRODUCT CODE	PRICE	SIZE/INCHES			WEIGHT VOL	
		H	W	D	LBS	FT ³
BRTSL24L	387	28	2.5	24	8	1.34
BRTSL30L	405	28	2.5	30	8	1.34
BRTSL36L	422	28	2.5	36	9	1.50

BRTBA-L • Back 2 Back Leg Assembly (Levelers)

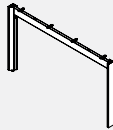

- Two Back 2 Back Leg Assemblies form the structure of the Bridges series Back 2 Back Tables.
- One double leg can be shared by 4 adjoining worksurfaces.
- Leveling, steel frame, aluminum legs.
- Anodized aluminum leg upcharge \$55.
- Please specify paint finish for support.

PRODUCT CODE	PRICE	SIZE/INCHES			WEIGHT VOL	
		H	W	D	LBS	FT ³
BRTBA34L	387	28	2.5	34	10	2.47
BRTBA51L	420	28	2.5	50.5	12	2.96
BRTBA63L	437	28	2.5	62.5	13	3.21

BRTHL-C • Single "H" Leg Assembly (Casters)

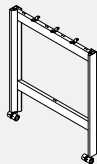

- Two Single Leg Assemblies form the structure of the Bridges series Single Line Tables.
- Leveling glides, steel frame, aluminum legs.
- Anodized aluminum leg upcharge \$55.
- Please specify paint finish for support.
- Note:
 - 24" deep tables must have three (3) beams at the top, and one beam (BRTBB-C "Bottom Table Beam") at the bottom.
 - 30" and 36" deep tables must have four (4) beams at the top, and one beam (BRTBB-C "Bottom Table Beam") at the bottom.

PRODUCT CODE	PRICE	SIZE/INCHES			WEIGHT VOL	
		H	W	D	LBS	FT ³
BRTHL3624C	485	35	2.5	24	14	1.68
BRTHL3630C	513	35	2.5	30	16	1.76
BRTHL3636C	583	35	2.5	36	18	2.26
BRTHL4224C	507	41	2.5	24	15	1.96
BRTHL4230C	536	41	2.5	30	17	2.06
BRTHL4236C	604	41	2.5	36	19	2.65

BRTHL-L • Single "H" Leg Assembly (Levelers)

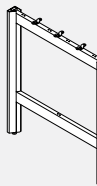

- Two Single Leg Assemblies form the structure of the Bridges series Single Line Tables.
- One leg can be shared by 2 adjoining worksurfaces.
- Leveling glides, steel frame, aluminum legs.
- Anodized aluminum leg upcharge \$55.
- Please specify paint finish for support.
- Note:
 - 24" deep tables must have three (3) beams at the top, and one beam (BRTBB-C "Bottom Table Beam") at the bottom.
 - 30" and 36" deep tables must have four (4) beams at the top, and one beam (BRTBB-C "Bottom Table Beam") at the bottom.

PRODUCT CODE	PRICE	SIZE/INCHES			WEIGHT VOL	
		H	W	D	LBS	FT ³
BRTHL3624L	446	35	2.5	24	14	1.68
BRTHL3630L	474	35	2.5	30	16	1.76
BRTHL3636L	541	35	2.5	36	18	2.26
BRTHL4224L	469	41	2.5	24	15	1.96
BRTHL4230L	498	41	2.5	30	17	2.06
BRTHL4236L	564	41	2.5	36	19	2.65

BRTDLSHS34 • 34" Leg Shroud

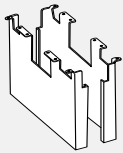

- A two part steel enclosure creates 5" deep and 30" wide cable management cavity between 34" rectangular table legs.
- Hides floor power feeds as well as data/communication cables rising from floor monuments to the underside of Bridges II tables.
- Secures to BRTBA34L rectangular leg and to underside of worksurfaces.
- Specify paint finish.

PRODUCT CODE	PRICE	SIZE/INCHES			WEIGHT VOL	
		H	W	D	LBS	FT ³
BRTDLSHS34	438	28	30	5	62	5.25

BRTSLL • Single Loop Leg

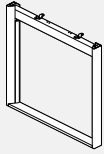

- Two Single Leg Assemblies form the structure of the Bridges series Single Line Tables.
- One leg can be shared by 2 adjoining worksurfaces.
- Leveling glides, steel frame, aluminum legs.
- Anodized aluminum leg upcharge \$55.
- Please specify paint finish for support.
- Please specify two beams when using BRTSLL36L

PRODUCT CODE	PRICE	SIZE/INCHES			WEIGHT VOL	
		H	W	D	LBS	FT ³
BRTSLL24L	447	28	2.5	24	11.00	1.01
BRTSLL30L	466	28	2.5	30	13.75	1.26
BRTSLL36L	494	28	2.5	36	16.50	1.51

BRTBALL • Back 2 Back Loop Leg

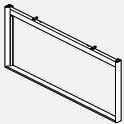

- Two Back 2 Back Leg Assemblies form the structure of the Bridges series Back 2 Back Tables.
- One double leg can be shared by 4 adjoining worksurfaces.
- Leveling glides, steel frame, aluminum legs.
- Anodized aluminum leg upcharge \$55.
- Please specify paint finish for support.

PRODUCT CODE	PRICE	SIZE/INCHES			WEIGHT VOL	
		H	W	D	LBS	FT ³
BRTBALL51L	512	28	2.5	50.5	23.14	2.12
BRTBALL63L	535	28	2.5	62.5	28.64	2.62

BRT • 120° Corner Leg Kit

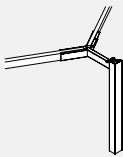

- One 120° corner leg kit combined with two single or double Leg Assemblies and support beams form the structure of the Bridges series 120° Tables.
- 120° corner leg kit includes one corner leg and adjacent, telescopic beams to support BRTWAC120 or BRTWAC120A 120° worksurfaces. Telescopic horizontal beams allow single or double Leg Assemblies to be positioned either under the worksurface (end of a run) or to be shared by adjoining worksurfaces. Levelers, steel frame, aluminum legs.
- Anodized aluminum leg upcharge \$30.
- Please specify paint finish for support.

PRODUCT CODE	PRICE	SIZE/INCHES			WEIGHT VOL	
		H	W	D	LBS	FT ³
BRT120L42	741	28	2.5	34	6.6	2.80

BRTHLEG • Boulevard Leg Assembly

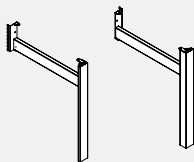

- Boulevard Leg Assembly attaches to a Boulevard panel for applications which require functionality of Boulevard panels with an open environment of Bridges tables.
- One leg with horizontal member connecting to 1" increment slots in panel's vertical frame member. Provides support to panel and panel-connected worksurface at the end of a run; design coordinated with Bridges freestanding tables.
- Supports 24" and 30" deep worksurfaces. By adding 2 BHBF01 flat brackets and 1 BHBC02 corner bracket, a single leg can then support the adjoining worksurface. Leveling glide is standard. No worksurface supporting beams, use panel cantilevers and storage for worksurface support. One aluminum leg with steel structure - specify Left or Right and 24" or 30" deep for corresponding worksurface depths. Panel bracket, dislodgment clip and worksurface hardware included.
- Anodized aluminum leg upcharge \$30.
- Please specify paint finish for support.

PRODUCT CODE	PRICE	SIZE/INCHES			WEIGHT VOL	
		H	W	D	LBS	FT ³
BRTHLEG24LL	308	28	2.5	24	9	1.25
BRTHLEG24RL	308	28	2.5	24	9	1.25
BRTHLEG30LL	323	28	2.5	30	11	1.45
BRTHLEG30RL	323	28	2.5	30	11	1.45

BRTLVS • Leveler for Rectangular Leg Table



- 5/16" thread with black base; leveler has 2" adjustment range.
- Casters and levelers on Rectangular legs cannot be interchanged on site.

PRODUCT CODE	PRICE	SIZE/INCHES			WEIGHT VOL	
		H	W	D	LBS	FT ³
BRTLVS	9	2.5	1	1	0.025	0.001

BRTLCS • Locking Caster for Rectangular Leg Tables

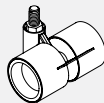

- Locking Caster for Rectangular Table
- 40mm dia. locking caster with 8mm thread; white body, light grey tires.
- Casters and levelers on rectangular legs cannot be interchanged on site.

PRODUCT CODE	PRICE	SIZE/INCHES			WEIGHT VOL	
		H	W	D	LBS	FT ³
BRTLCS	26	2.5	2.7	2.6	0.055	0.008

BRTSL • Single Leg Assembly

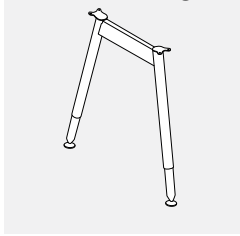

- Two Single Leg Assemblies combined with a Single Beam form the supporting structure of the Bridges series Single Line Tables.
- One leg can be shared by 2 adjoining worksurfaces.
- Leveling glides are standard. Locking casters are available on single tables. Specify 2 casters (BRTLCL) at an upcharge of \$22 each.

PRODUCT CODE	PRICE	SIZE/INCHES			WEIGHT VOL	
		H	W	D	LBS	FT ³
BRTSL	342	28	3	24	8	1.25

BRTFSL • Fixed Height Single Leg Assembly



- Two Single Leg Assemblies combined with a Single Beam form the supporting structure of the Bridges series Single Line Tables.
- One leg can be shared by 2 adjoining worksurfaces.

PRODUCT CODE	PRICE	SIZE/INCHES			WEIGHT VOL	
		H	W	D	LBS	FT ³
BRTFSL	294	28	2.5	24	5	0.97

BRTDL • Back 2 Back Leg Assembly



- Two Back 2 Back Leg Assemblies combined with 2 Single Beams form the supporting structure of the Bridges series Back 2 Back tables.
- One leg can be shared by 2 adjoining worksurfaces.
- Leveling glides are standard.

PRODUCT CODE	PRICE	SIZE/INCHES			WEIGHT VOL	
		H	W	D	LBS	FT ³
BRTDL	446	28	3	50	12	2.81

BRTFDL • Fixed Height Back 2 Back Leg Assembly

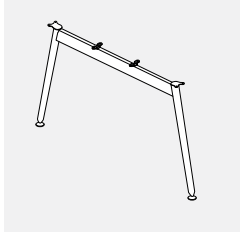

- Two Back 2 Back Leg Assemblies combined with 2 Single Beams form the supporting structure of the Bridges series Back 2 Back tables.
- One leg can be shared by 2 adjoining worksurfaces.
- Leveling glides are standard.

PRODUCT CODE	PRICE	SIZE/INCHES			WEIGHT VOL	
		H	W	D	LBS	FT ³
BRTFDL	399	28	2.5	50	8	2.03

BRTBL • Boulevard Leg Assembly

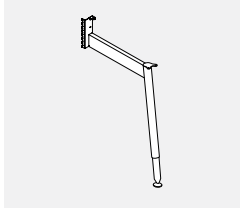

- Boulevard Leg Assembly attaches to a Boulevard panel for applications which require functionality of Boulevard panels with an open environment of Bridge 2 tables.
- Panel bracket secures the leg to the panel in 1" increments, within a 24" to 32" height range.
- Panel mounting bracket is reversible for non-handed applications.
- Supports 24" and 30" deep worksurfaces. By adding 2 BHBF01 flat brackets and 1 BHBC02 corner bracket, a single leg can then support the adjoining worksurface. Leveling glide is standard. No worksurface supporting beams, use panel cantilevers and storage for worksurface support. Panel bracket, dislodgment clip and worksurface hardware included.
- Leveling glide is standard.

PRODUCT CODE	PRICE	SIZE/INCHES			WEIGHT VOL	
		H	W	D	LBS	FT ³
BRTBL	328	28	3	24	12	1.25

BRTCRL • 120° Corner Leg Kit

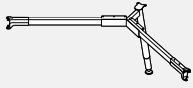

- Provides support for worksurfaces connected at 120° Degree.
- Single leg and beam assembly for 120° worksurface planning.
- Works with BRTWAC120 or BRTWAC120A worksurfaces.
- For a single table application two BRTSL (single legs) must be added.
- To join to a Back 2 Back table application, leg assembly will join to existing pod.
- Note: When joining to an existing table, the beam extends to reach the shared leg.

PRODUCT CODE	PRICE	SIZE / INCHES			WEIGHT VOL	
		H	W	D	LBS	FT ³
BRTCRL42	686	28	18	16	15	1.50

BRTFCRL • 120° Fixed Height Corner Leg Kit

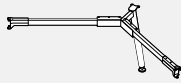

- Provides support for worksurfaces connected at 120° Degree, supported by fixed height legs.
- Single leg and beam assembly for 120° worksurface planning.
- Works with BRTWAC120 or BRTWAC120A worksurfaces.
- For a single table application two BRTFSL (single legs) must be added.
- To join to a Back 2 Back table application, leg assembly will join to existing pod.
- Note: When joining to an existing table, the beam extends to reach the shared leg.

PRODUCT CODE	PRICE	SIZE / INCHES			WEIGHT VOL	
		H	W	D	LBS	FT ³
BRTFCRL42	639	28	18	16	13	1.50

BRTLVR • Levelers for Tables

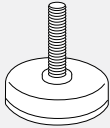

- Provides an option to casters.
- Leveler is 2 1/8" diameter.
- 1 1/2" long, 3/8" - 16 threaded stem provides 1" height adjustment range.
- Field retrofittable on round leg.

PRODUCT CODE	PRICE	SIZE / INCHES			WEIGHT VOL	
		H	W	D	LBS	FT ³
BRTLVR	9	2	2.125	2.125	0.2	0.002

BRTLCL • Locking Casters for Round Leg Tables

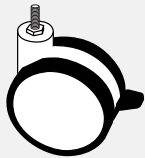

- Provides an option to levelers.
- Caster is 3" diameter wheel and 3/8" - 16 threaded stem.
- Overall height is 3 3/4".
- Field retrofittable on round leg.

PRODUCT CODE	PRICE	SIZE / INCHES			WEIGHT VOL	
		H	W	D	LBS	FT ³
BRTLCL	26	3.75	3	1.5	0.3	0.002

BRTSL • Round Table Leg Assembly

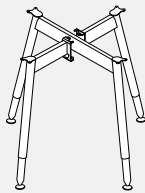

- Four leg assembly.
- Leveling glides are standard. Locking casters are available. Specify 4 casters (BRTLCL) at an upcharge of \$17 each.
- Maximum table diameter is 42".
- Includes all connecting hardware.

PRODUCT CODE	PRICE	SIZE / INCHES			WEIGHT VOL	
		H	W	D	LBS	FT ³
BRTSL	705	28	24	24	16	2.33

Beam Applications

Bridges II table legs are connected with supporting beams. Unless there is one beam for a single line of tables while two beams connect Back 2 Back table structures. Adjustable clamps at either end of the beam can be adjusted to accommodate the following applications in both single table as well as Back 2 Back table configurations.

STANDARD TABLE BEAM

Single table beam application bridges two legs to form support for a single table, or two Back 2 Back work surfaces.

Adjustable clamps at either end of the beam are pushed all the way in to allow both table legs to be tucked under the work surface.

End of run table beam application supports one table leg assembly tucked under work surface (one adjustable clamp pushed all the way in), while the other table leg assembly can be shared between two adjacent work surfaces (adjustable clamp pulled out to extend the beam).

Interconnecting table beam application supports both table leg assemblies extended to support adjacent work surfaces on either side. Both adjustable clamps pulled out to extend the beam at either end.

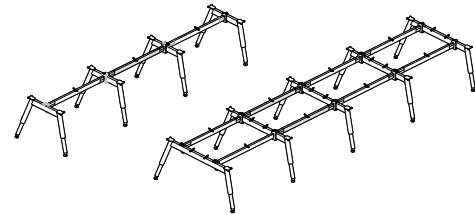
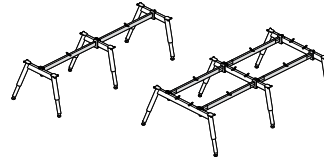
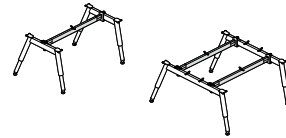

TELESCOPIC TABLE RETURN BEAM

Supports a return connected perpendicularly to a 24" or 30" deep primary work surface. The Telescopic beam is connected to a single or Back 2 Back leg on one side and to any work surface-supporting beam on the opposite side. Telescopic beam clamp allows the table leg to be tucked under worksurface or shared between two adjacent worksurfaces.

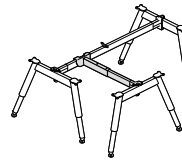

TABLE TO TABLE TELESCOPIC BRIDGE BEAM

Supports a 36" to 84" wide top connected perpendicularly between two freestanding tables. Adjustable brackets on both sides of the beam connect off module to the perpendicular standard beam and can be adjusted to accommodate 24" and 30" deep primary worksurfaces.

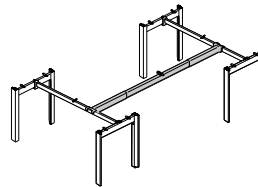
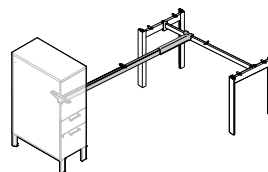

TABLE TO STORAGE TELESCOPIC RETURN BEAM

Supports a return connected perpendicularly to a 24" or 30" deep primary work surface on one end and a storage cabinet on the other. This allows the return worksurface to be layered otop of storage without the need for an additional leg assembly.



STORAGE TABLE BEAM

The Storage beam is connected to a single or Back 2 Back leg on one side and to the work surface on the opposite side - thus saving one leg (assembly work surface is connected to storage units with included storage brackets). Storage table beam's flexibility allows for a single table application (with the table leg tucked in under the work surface) as well as for a double table installation (two adjacent tables supported by a shared leg in the middle and two storage cabinets at the opposite ends).

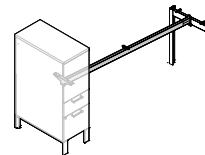

STORAGE TABLE BEAM ADAPTER

Connects to Storage table beam. This assembly allows a work surface to be supported by a leg on one side and a spine (formed by interconnected storage cabinets) on the opposite side.

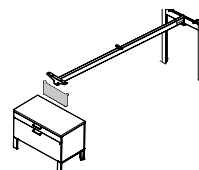

BRTSB-C • Standard Table Beam

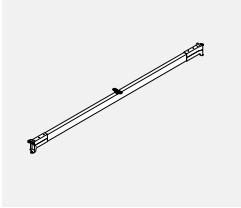

- **Standard table beam bridges two legs to form support for a single table, or two Back 2 Back work surfaces. Adjustable clamps at either end of the beam accommodate Standard table beam, end of run and interconnecting table beam applications. Adjustable brackets ship attached to the beam.**
- Specify Single Table Beam size corresponding nominally to the worksurface length. Includes all hardware necessary to connect to legs. Powder coated steel beam and aluminum cast clamps.
- Specify metal finish.
- Distance between bottom of beam and floor of standard height application is 25 3/8".

PRODUCT CODE	PRICE	SIZE/INCHES			WEIGHT VOL	
		H	W	D	LBS	FT ³
BRTSB15C	147	2	10	1	1.28	0.01
BRTSB24C	187	2	19	1	2.03	0.01
BRTSB30C	189	2	25	1	2.70	0.02
BRTSB36C	191	2	31	1	3.31	0.03
BRTSB42C	194	2	37	1	3.59	0.04
BRTSB48C	202	2	43	1	4.60	0.05
BRTSB51C	211	2	45.5	1	4.81	0.05
BRTSB54C	218	2	49	1	4.86	0.06
BRTSB60C	227	2	55	1	5.45	0.07
BRTSB63C	231	2	57.5	1	5.72	0.08
BRTSB66C	233	2	61	1	6.09	0.08
BRTSB72C	242	2	67	1	6.74	0.09
BRTSB78C	252	2	73	1	7.38	0.12
BRTSB84C	257	2	79	1	8.02	0.15

BRTBB-C • Bottom Table Beam

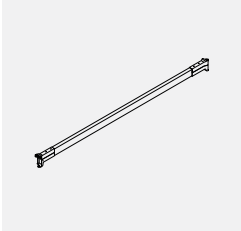

- **Bottom table beam connects to the lower cross beam on the 36" and 42" high "H" leg to create the footrest.**
- One beam required for each table
- Cannot be used as a substitute for the standard table beam.
- Specify the bottom table beam that corresponds to the worksurface length. Includes all hardware necessary to connect to "H" leg. Powder coated steel beam and aluminum cast clamps.
- Specify metal finish

PRODUCT CODE	PRICE	SIZE/INCHES			WEIGHT VOL	
		H	W	D	LBS	FT ³
BRTBB36C	191	2	31	1	3.31	0.03
BRTBB42C	194	2	37	1	3.59	0.04
BRTBB48C	202	2	43	1	4.60	0.05
BRTBB54C	218	2	49	1	4.86	0.06
BRTBB60C	227	2	55	1	5.45	0.07
BRTBB66C	233	2	61	1	6.09	0.08
BRTBB72C	242	2	67	1	6.74	0.09
BRTBB78C	252	2	73	1	7.38	0.12
BRTBB84C	257	2	79	1	8.02	0.15

BRTTB-C • Telescopic Table Return Beam

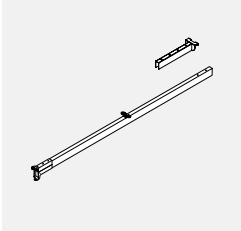

- **Provides support for a worksurface connected perpendicularly to a run of primary tables.**
- Can be adjusted to accommodate 24" and 30" deep primary worksurfaces.
- Adjustable clamp secures the beam to a Leg assembly on one side, while the other side of the beam connects off-module, to the perpendicular Standard Beam.
- The adjustable clamp can also be extended to allow for the leg to be tucked in under the work surface or to be shared by two adjacent work surfaces.
- Includes all hardware necessary to connect to legs.
- Powder coated steel and die-cast aluminum clamp.
- Distance between bottom of beam and floor of standard height application is 25 3/8".

PRODUCT CODE	PRICE	SIZE/INCHES			WEIGHT VOL	
		H	W	D	LBS	FT ³
BRTTB36C	298	2	48.5	1	5.19	0.05
BRTTB42C	315	2	54.5	1	5.83	0.06
BRTTB48C	331	2	60.5	1	6.74	0.07
BRTTB54C	345	2	66.5	1	7.11	0.07
BRTTB60C	362	2	72.5	1	7.75	0.08
BRTTB66C	372	2	78.5	1	8.40	0.09
BRTTB72C	380	2	84.5	1	9.04	0.09
BRTTB78C	387	2	90.5	1	9.68	0.12
BRTTB84C	396	2	96.5	1	10.32	0.15

BRTSTB-C • Storage Table Beam



- **Storage Table Beam allows a worksurface to be supported by a leg on one side and storage tower(s) on the opposite side. The Storage beam is connected to a single or Back 2 Back leg on one side and to the worksurface on the opposite side - thus saving one leg assembly. The flexible arrangement of such a leg/beam/clamp assembly allows the leg to be tucked in under the work surface or to be shared by two adjacent work surfaces.**
- Also, applies to multiple, Back 2 Back Assemblies.
- Specify Storage table beam size corresponding nominally to the worksurface length. Includes all hardware necessary to connect to legs.
- Powder coated steel.
- Distance between bottom of beam and floor of standard height application is 25 3/8".

PRODUCT CODE	PRICE	SIZE/INCHES			WEIGHT VOL	
		H	W	D	LBS	FT ³
BRTSTB36C	202	2	32.75	1	3.50	0.03
BRTSTB42C	211	2	38.75	1	4.16	0.04
BRTSTB48C	213	2	44.75	1	4.78	0.05
BRTSTB54C	227	2	50.75	1	5.43	0.05
BRTSTB60C	242	2	54.75	1	5.85	0.06
BRTSTB66C	257	2	62.75	1	6.74	0.07
BRTSTB72C	267	2	68.75	1	7.35	0.08
BRTSTB78C	275	2	74.75	1	7.99	0.08
BRTSTB84C	283	2	80.75	1	8.64	0.09

BRT2TTB • Table to Table Telescopic Bridge Beam

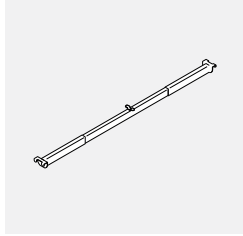

- Provides support for a worksurface connected between two primary tables.
- Can be adjusted to accommodate 24" and 30" deep primary worksurfaces.
- Adjustable brackets on both sides of the beam connect off-module to the perpendicular standard beam.
- Includes all hardware necessary to connect to legs.
- Power coated steel. Please specify colour.

PRODUCT CODE	PRICE	SIZE / INCHES			WEIGHT VOL	
		H	W	D	LBS	FT ³
BRT2TTB36	321	2.52	61.3	3.41	8.7	3.5
BRT2TTB42	328	2.52	67.3	3.41	9.3	3.8
BRT2TTB48	333	2.52	73.3	3.41	9.9	4.2
BRT2TTB54	340	2.52	79.3	3.41	10.5	4.6
BRT2TTB60	344	2.52	85.3	3.41	11.1	4.9
BRT2TTB66	353	2.52	91.3	3.41	11.7	5.3
BRT2TTB72	359	2.52	97.3	3.41	12.3	5.6
BRT2TTB78	364	2.52	103.3	3.41	12.9	6.0
BRT2TTB84	371	2.52	109.3	3.41	13.5	6.4

BRT2STTB • Table to Storage Telescopic Return Beam

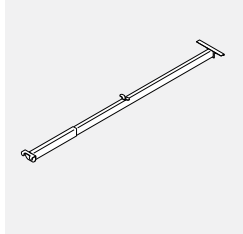

- Provides support for a return connected a primary work surface on one end and a storage cabinet on the other.
- Can be adjusted to accommodate 24" and 30" deep primary worksurfaces.
- Adjustable clamp secures the beam to a Storage Tower on one side, while the other side of the beam connects off-module, to the perpendicular Standard Beam.
- Includes all hardware necessary to connect to legs.
- Power coated steel. Please specify colour.

PRODUCT CODE	PRICE	SIZE / INCHES			WEIGHT VOL	
		H	W	D	LBS	FT ³
BRT2STTB36	232	2.52	61.3	3.41	8.7	3.5
BRT2STTB42	239	2.52	67.3	3.41	9.3	3.8
BRT2STTB48	244	2.52	73.3	3.41	9.9	4.2
BRT2STTB54	252	2.52	79.3	3.41	10.5	4.6
BRT2STTB60	257	2.52	85.3	3.41	11.1	4.9
BRT2STTB66	263	2.52	91.3	3.41	11.7	5.3
BRT2STTB72	270	2.52	97.3	3.41	12.3	5.6
BRT2STTB78	276	2.52	103.3	3.41	12.9	6.0
BRT2STTB84	281	2.52	109.3	3.41	13.5	6.4

BRTSA • Storage Table Beam Adapter

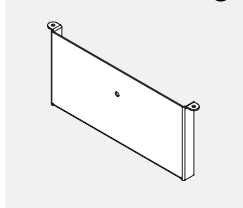

- Storage table beam adapter allows a worksurface to be supported by a leg on one side and storage spine on the opposite side. A typical Storage spine is formed by series of interconnected 21" or 25" high storage cabinets of corresponding depth.
- The Storage beam is connected to a single or Back 2 Back leg on one side and to the worksurface on the opposite side - thus saving one leg assembly.
- The 21" or 25" adapters provide structural support - acting as supports between top of the storage cabinet spine and the bottom of perpendicular worksurfaces.
- The flexible leg/beam/adapter assembly arrangement allows the leg to be tucked in under the worksurface or to be shared by two adjacent worksurfaces. Included hardware connect the adapter to the worksurface and to the Spine storage beam adapter tower.
- Note: Specify Storage Beam nominally 18" shorter than worksurfaces for storage spine support application.
- Specify Storage Spine Adapter BRTSA21 (21") or BRTSA25 adapter (25") - depending on the height of Bridges storage units forming the spine.
- Includes all hardware necessary to connect the adapter to the beam, worksurface and storage spine.

PRODUCT CODE	PRICE	SIZE / INCHES			WEIGHT VOL	
		H	W	D	LBS	FT ³
BRTSA21	97	6.5	15.2	1	2.15	0.05
BRTSA25	81	2.75	15.2	1	4.3	0.02

BRTLSC • Leg Support Cantilever

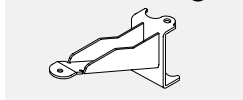

- Provides stability for leg supports.

PRODUCT CODE	PRICE	SIZE / INCHES			WEIGHT VOL	
		H	W	D	LBS	FT ³
BRTLSC	120	3.5	7	2	0.5	0.007

BRTESBBIN • Elevated Shelf Binder Bin

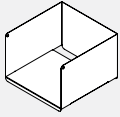

- **Elevated Shelf Binder Bin.**
- Frame finish.
- Not compatible with 16" Deep shared Overhead with Sliding Doors.
- Handy companion to 12" deep BRTBTS Shared Elevated Table Shelves. The bin rests on top surface, provides better utilization of vertical space, binder/book manager, enhanced sense of privacy as well as magnetic board on the opposite side.

PRODUCT CODE	PRICE	SIZE/INCHES			WEIGHT VOL	
		H	W	D	LBS	FT ³
BRTESBBIN	147	8	12	12	6	0.66

BRTHB • Hanging Bracket

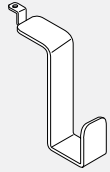

- **A formed steel bracket hooks over Bridges2 table leg. Can be secured either on the inner or outer side of the leg.**
- Frame Finish.

PRODUCT CODE	PRICE	SIZE/INCHES			WEIGHT VOL	
		H	W	D	LBS	FT ³
BRTHB	24	3.5	1.5	3.3	0.2	0.01

BRTWB • Whiteboard

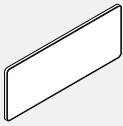

- **White dry-erase marker board surface on white powder coated steel backer.**
- Fits 16" tall Bridges 2 dividers and single-sided shelves. White dry-erase surface attaches magnetically to the steel backer, when removed the backer can be used as a magnetic board.

PRODUCT CODE	PRICE	SIZE/INCHES			WEIGHT VOL	
		H	W	D	LBS	FT ³
BRTWB0924	201	8.5	24	0.5	1	0.56

BRTTB • Tackboard

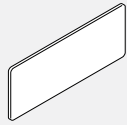

- **Grey tackboard surface on white powder coated steel backer.**
- Fits 16" tall Bridges 2 dividers and single sided shelves.

PRODUCT CODE	PRICE	SIZE/INCHES			WEIGHT VOL	
		H	W	D	LBS	FT ³
BRTTB0924	201	8.5	24	0.5	1	0.56

BRTTEGF • Table End Gap Filler

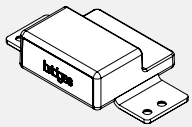

- **Injection molded block fills the gap finishing the end of Back 2 Back table assemblies. Secures to the bottom of two Back 2 Back worksurfaces.**
- Injection molded resin, white.

PRODUCT CODE	PRICE	SIZE/INCHES			WEIGHT VOL	
		H	W	D	LBS	FT ³
BRTTEGF	9	1.1	2.5	4.5	0.025	0.006

BRTWS • Rectangular Worksurface Top

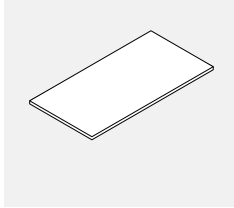

- **Worksurfaces are available in high pressure laminate (HP 1 1/16" thick) and low pressure laminate (LP 1" thick) with a flat 3 mm edge profile on all sides.**
- Worksurfaces provided with pilot holes for alignment purposes.
- Worksurface available in HP and LP.

PRODUCT CODE	PRICE		SIZE/INCHES			WEIGHT VOL	
	LP	HP	H	W	D	LBS	FT ³
BRTWS2436	156	207	1	36	24	23	0.71
BRTWS2442	205	272	1	42	24	28	0.90
BRTWS2448	245	329	1	48	24	31	1.06
BRTWS2454	290	383	1	54	24	35	1.20
BRTWS2460	326	430	1	60	24	39	1.30
BRTWS2466	340	449	1	66	24	43	1.41
BRTWS2472	355	470	1	72	24	47	1.54
BRTWS2478	381	501	1	78	24	51	1.70
BRTWS2484	410	537	1	84	24	55	1.80
BRTWS3036	194	256	1	36	30	30	1.06
BRTWS3042	275	362	1	42	30	34	1.12
BRTWS3048	290	383	1	48	30	39	1.41
BRTWS3054	317	408	1	54	30	44	1.44
BRTWS3060	340	449	1	60	30	49	1.77
BRTWS3066	353	469	1	66	30	54	1.80
BRTWS3072	374	495	1	72	30	59	2.00
BRTWS3078	398	524	1	78	30	64	2.10
BRTWS3084	443	579	1	84	30	69	2.24
BRTWS3642	333	418	1	42	36	39	2.63
BRTWS3648	378	471	1	48	36	45	3.00
BRTWS3654	420	526	1	54	36	51	3.38
BRTWS3660	466	583	1	60	36	56	3.75
BRTWS3666	508	637	1	66	36	62	4.13
BRTWS3672	552	691	1	72	36	68	4.50
BRTWS3678	594	743	1	78	36	73	4.88
BRTWS3684	639	800	1	84	36	79	5.25

BRTWSA • Rectangular Worksurface Top with Access Door

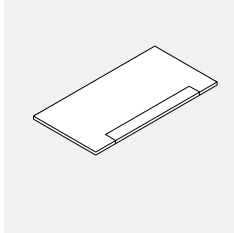

- **Tables Worksurfaces are available in high pressure laminate (HP: 1 1/16" thick), low pressure laminate (LP: 1" thick), 3 mm edging on all sides.**
- Worksurfaces provided with pilot holes for easier alignment purposes.
- Worksurfaces 42" through 72" have one access door.
- 3.5" deep anodized aluminum door provides access to power / data trough below worksurface.
- Access door is offset 13.5" from either side of worksurface.
- Worksurfaces with access doors cannot be combined with Above Worksurface Power Troughs.
- Worksurface available in HP and LP.

PRODUCT CODE	PRICE		SIZE/INCHES			WEIGHT VOL	
	LP	HP	H	W	D	LBS	FT ³
BRTWSA2442	257	372	1	42	24	23	0.71
BRTWSA2448	290	420	1	48	24	28	0.90
BRTWSA2454	323	469	1	54	24	31	1.06
BRTWSA2460	362	519	1	60	24	35	1.20
BRTWSA2466	396	564	1	66	24	39	1.30
BRTWSA2472	428	620	1	72	24	43	1.41
BRTWSA3042	308	443	1	42	30	30	1.06
BRTWSA3048	345	501	1	48	30	34	1.12
BRTWSA3054	387	564	1	54	30	39	1.41
BRTWSA3060	428	620	1	60	30	44	1.44
BRTWSA3066	476	686	1	66	30	49	1.77
BRTWSA3072	508	741	1	72	30	54	1.80
BRTWSA3642	366	498	1	42	36	39	2.63
BRTWSA3648	436	590	1	48	36	45	3.00
BRTWSA3654	493	681	1	54	36	51	3.38
BRTWSA3660	553	754	1	60	36	56	3.75
BRTWSA3666	636	854	1	66	36	62	4.13
BRTWSA3672	688	936	1	72	36	68	4.50

BRTWSAA • Rectangular Worksurface Top with 2 16" Access Doors

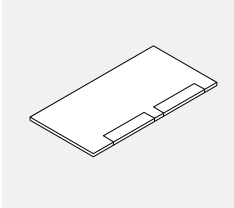

- **Tables Worksurfaces are available in high pressure laminate (HP: 1 1/16" thick), low pressure laminate (LP: 1" thick), 3 mm edging on all sides.**
- Worksurfaces provided with pilot holes for easier alignment purposes.
- 3.5" deep anodized aluminum door provides access to power / data trough below worksurface.
- Access door is offset 10" (60" worksurfaces) and 13.5" (worksurfaces 66" and wider) from either side of worksurface.
- Worksurfaces with access doors cannot be combined with Above Worksurface Power Troughs.
- Dimension between doors is 8" for 60" and 66" long surfaces, 14" for 72", 20" for 78" and 26" for 84".
- Worksurface available in HP and LP. F
- Worksurfaces should not be used with Table Mounted Dividers BRPX3P21.

PRODUCT CODE	PRICE		SIZE/INCHES			WEIGHT VOL	
	LP	HP	H	W	D	LBS	FT ³
BRTWSAA2460	393	558	1	60	24	35	1.20
BRTWSAA2466	428	612	1	66	24	39	1.30
BRTWSAA2472	462	672	1	72	24	43	1.41
BRTWSAA2478	466	677	1	78	24	47	1.54
BRTWSAA2484	493	730	1	84	24	51	1.70
BRTWSAA3060	462	672	1	60	30	44	1.44
BRTWSAA3066	518	740	1	66	30	49	1.77
BRTWSAA3072	547	802	1	72	30	54	1.80
BRTWSAA3078	551	821	1	78	30	59	2.00
BRTWSAA3084	585	871	1	84	30	64	2.10
BRTWSAA3660	521	726	1	60	36	56	3.75
BRTWSAA3666	604	829	1	66	36	62	4.13
BRTWSAA3672	650	920	1	72	36	68	4.50
BRTWSAA3678	675	954	1	78	36	73	4.88
BRTWSAA3684	741	1041	1	84	36	79	5.25

BRTWAC120 • 120° Table Top

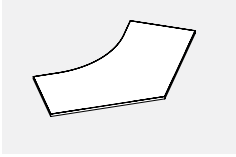

- 5-sided worksurface can be used for a single, freestanding table, can form a pod of two or three tables, or can be combined with rectangular worksurfaces to create larger workstations.

- Worksurfaces provided with pilot holes for alignment purposes.
- Worksurface available in HP and LP.

PRODUCT CODE	PRICE		SIZE/INCHES			WEIGHT VOL	
	LP	HP	H	W	D	LBS	FT ³
BRTWAC120424224	735	974	1	42	24	31	1.06
BRTWAC120424230	800	1042	1	42	30	39	1.41

BRTWAC120A • 120° Table Top with Access Door

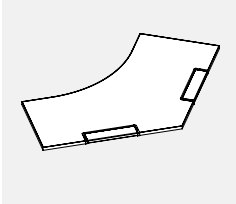

- 5-sided worksurface can be used for a single, freestanding table, can form a pod of two or three tables, or can be combined with rectangular worksurfaces to create larger workstations.

- 3.5" deep anodized aluminum door provides access to power / data trough below worksurface.
- 120° Worksurface as above with Worksurface access door - anodized aluminum worksurface access door provides access to power / data trough below worksurface.
- Worksurface with access doors cannot be combined with above worksurface power trough.
- Access door is offset 13.5" from either side of worksurface.
- Worksurface available in HP and LP.

PRODUCT CODE	PRICE		SIZE/INCHES			WEIGHT VOL	
	LP	HP	H	W	D	LBS	FT ³
BRTWAC120A424224	781	1041	1	42	24	31	1.06
BRTWAC120A424230	843	1169	1	42	30	39	1.41

BRTMTR • Round Meeting Table Top

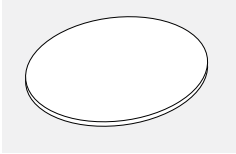

- **Round top**
- Worksurfaces provided with pilot holes for alignment purposes.
- Worksurface available in HP and LP.

PRODUCT CODE	PRICE		SIZE/INCHES			WEIGHT VOL	
	LP	HP	H	W	D	LBS	FT ³
BRTMTR42	387	484	1	42	42	40	1.76

BRTWS • Meeting Table Top

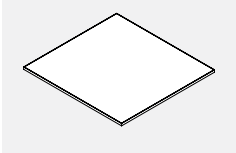

- **Can create convenient, flexible extension of the Back 2 Back Bridges table assembly.**
- Worksurfaces provided with pilot holes for alignment purposes.
- Meeting table top. 50.5" long side matches 24" deep, Back 2 Back Bridges table assembly
- Meeting table tops 62.5 long side matches 30" deep, Back 2 Back Bridges table assemblies.
- Worksurface available in HP and LP.

PRODUCT CODE	PRICE		SIZE/INCHES			WEIGHT VOL	
	LP	HP	H	W	D	LBS	FT ³
BRTWS2451	290	383	1	50.5	24	31	1.06
BRTWS3051	303	398	1	50.5	30	37	1.41
BRTWS3651	451	526	1	50.5	36	43	1.71
BRTWS4251	499	634	1	50.5	42	48	1.93
BRTWS4851	569	715	1	50.5	48	52	2.07
BRTWS5151	608	748	1	50.5	50.5	55	2.12
BRTWS5451	658	839	1	50.5	54	59	2.19
BRTWS6051	748	934	1	50.5	60	63	2.26
BRTWS2463	332	441	1	62.5	24	39	1.41
BRTWS3063	344	459	1	62.5	30	49	1.77
BRTWS3663	507	637	1	62.5	36	53	1.94
BRTWS4263	608	763	1	62.5	42	57	2.07
BRTWS4863	730	914	1	62.5	48	61	2.13
BRTWS5463	824	1026	1	62.5	54	63	2.21
BRTWS6063	915	1140	1	62.5	60	67	2.34

BRTWS-SCP • Display Wall Table Top with Scoop

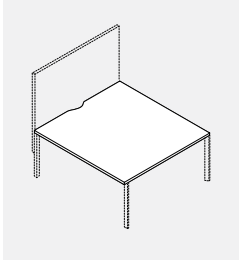

• Display wall mounts to the end of Bridges Back 2 Back table assembly supported by rectangular legs. As opposed to two separate Back 2 Back work surfaces, the Display Wall table top provides one continuous, uninterrupted surface with a scoop cutout next to the Display Wall (the scoop facilitates cable passage from below the table).

- Worksurfaces provided with pilot holes for alignment purposes.
- Table top. 50.5" long side matches 24" deep, Back 2 Back Bridges table assembly
- Meeting table tops 62.5 long side matches 30" deep, Back 2 Back Bridges table assemblies.
- Worksurface available in HP and LP.

PRODUCT CODE	PRICE		SIZE/INCHES			WEIGHT		VOL FT ³
	LP	HP	H	W	D	LBS		
BRTWS4851SCP	569	715	1	50.5	48	60	1.40	
BRTWS5451SCP	658	839	1	50.5	54	68	1.58	
BRTWS6051SCP	748	934	1	50.5	60	75	1.75	
BRTWS4863SCP	730	914	1	62.5	48	75	1.74	
BRTWS5463SCP	824	1026	1	62.5	54	84	1.95	
BRTWS6063SCP	915	1140	1	62.5	60	93	2.17	

BRTTVFT • Display Wall: Monitor Facing Double Work Station

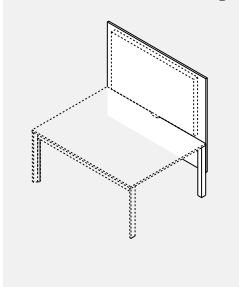

• Display wall mounts to the end of bridges Back 2 Back table assembly supported by bridges rectangular legs.

- Display faces the double work station - facilitates seated presentation area.
- Includes laminate board, TV/display brackets (black), mounting hardware, vertical cable manager (black). Slim (22mm) bracket capable of supporting displays/TVs up to 50" (resp. 62") wide, up to 80lbs. When installed, top of the 52" x 50.5" (resp. 62.5") wide board reaches 65.5" high.
- 1" LP or HP laminate board with 3mm edging. Different HP laminate finishes expand product functionality. For instance: white dryerase marker board laminate can be specified on "non-display" board surface. Specify laminate finish, HP laminate position (Display side, non-display side) and edging.
- Note: Included vertical cable manager passes through the gap between two Back 2 Back work surfaces. Should you need one continuous, uninterrupted surface specify Display Wall table top with a scoop (listed in the Work surface section of bridges Price List).
- Display wall mounts to the end of Bridges Back 2 Back table assembly supported by rectangular legs or Back 2 Back table structure with BRTWS-SCP Display Wall Table Top with scoop. As opposed to two separate Back 2 Back work surfaces, the BRTWS-SCP Display Wall Table Top provides one continuous, uninterrupted surface with a scoop cutout next to the display wall (the scoop facilitates cable passage from below the table top).
- Please add \$422 for white, dry erase on 51" wide Display Wall and \$576 for 63" wide.

PRODUCT CODE	PRICE		SIZE/INCHES			WEIGHT		VOL FT ³
	LP	HP	H	W	D	LBS		
BRTTVFT51	1384	1845	52	50.5	4	62.00	6.08	
BRTTVFT63	1460	1999	52	62.5	4	74.00	7.52	

BRTTVBK • Display Wall: Monitor Facing Back of Double Work Station

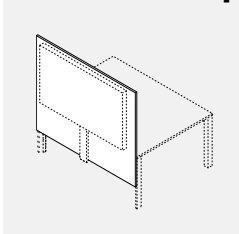

• Display wall support board mounts to end of bridges Back 2 Back table assembly supported by bridges rectangular legs. Display faces back of the double work station - facilitates standing or seated presentation area (combine with collaborative seating).

- Includes laminate board, TV/display brackets (black), mounting hardware, vertical cable manager (black). Slim (22mm) bracket capable of supporting displays/TVs up to 50" (resp. 62") wide, up to 80lbs.
- When installed, top of the 52" x 50.5" (resp. 62.5") wide board reaches 65.5" high.
- 1" LP or HP laminate board with 3mm edging. Different HP laminate finished expand product functionality. For instance: white dry-erase marker board laminate can be specified on "non-display" board surface. Specify laminate finish, HP laminate position (Display side, non-display side) and edging.
- Display wall mounts to the end of Bridges Back 2 Back table assembly supported by rectangular legs or Back 2 Back table structure with BRTWS-SCP Display Wall Table Top with scoop. As opposed to two separate Back 2 Back work surfaces, the BRTWS-SCP Display Wall Table Top provides one continuous, uninterrupted surface with a scoop cutout next to the display wall (the scoop facilitates cable passage from below the table top).
- Please add \$422 for white, dry erase on 51" wide Display Wall and \$576 for 63" wide.

PRODUCT CODE	PRICE		SIZE/INCHES			WEIGHT		VOL FT ³
	LP	HP	H	W	D	LBS		
BRTTVBK51	1384	1845	52	50.5	4	62.00	6.08	
BRTTVBK63	1460	1999	52	62.5	4	74.00	7.52	

Power delivery / cable management

At the basic level, table and floor based office equipment is serviced by a wall or floor power supply. As the operation grows, there might be a need to organize excessive cable clutter.

Cable Basket (1) connects to the underside of worksurfaces with steel brackets and cables are simply dropped and coiled into them.

Cable Snake(2) installed in proximity of floor monument to manage vertical cable clutter.

Table clamped, single circuit Desk Top Power Data Modules (3) deliver services to desk height, while tapping into wall or floor power supply. Again, the excessive cables can be managed with Cable Baskets.

Ceiling pole BRTCPP (4) manages power and data cables between ceiling and above or below worksurface power troughs.

Above and Below Worksurface Power/Data Troughs (5) can be installed between Back 2 Back tables for extended below and above desk height power/data distribution. - 8 wire, 4-circuit system.

Single Sided Power/Data Troughs (6) can be installed to the underside of a single table.

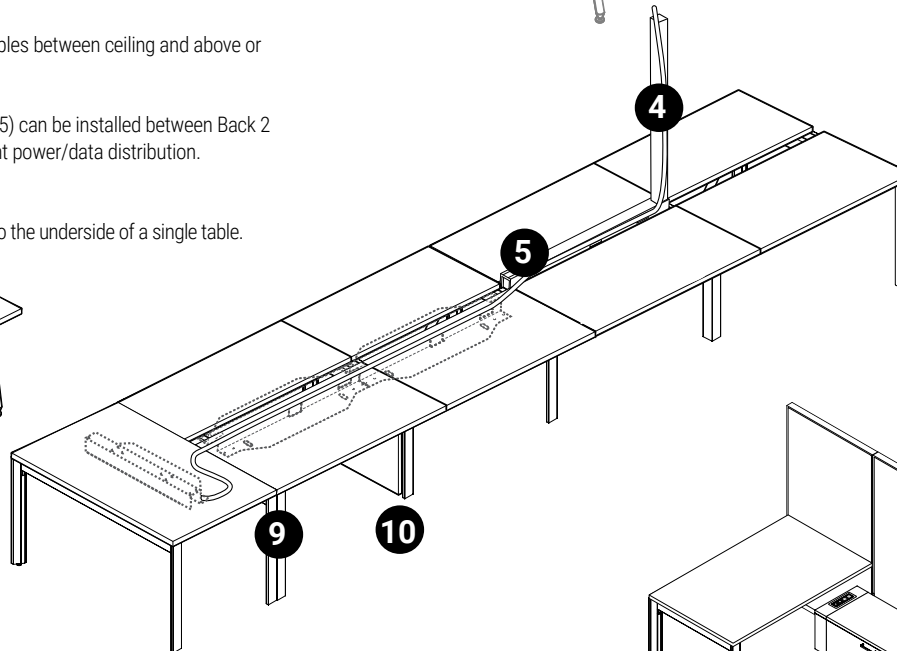
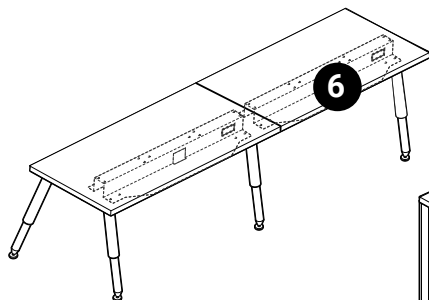
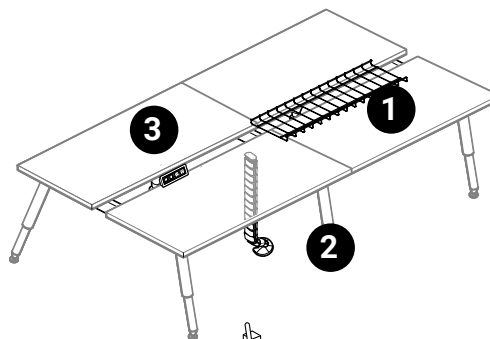

Elevated storage units provide access to floor raceway power duplexes and data terminals (7). 1" gap between panels and storage allow for easy passage of cables.

Some storage units can be connected to panel vertical slots and those allow to open and access panel floor raceway.

Storage power/data box BRTVCM (8) attaches to storage units and provides access to one duplex/data terminal on top storage surface. Integrated single circuit module can be plugged to floor monument under the storage, to a wall outlet or to a panel floor raceway duplex receptacle.

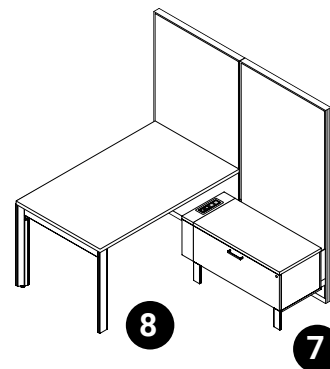

NOTE: Specify BRTHH58 (9) to distribute power from double sided, Back 2 Back below worksurface power trough to a single sided, below work surface power trough at the end of a table run.

Leg shroud (10) attaches to 34" wide legs and manages power floor feed as well as data cables from floor monument.

Electrical system

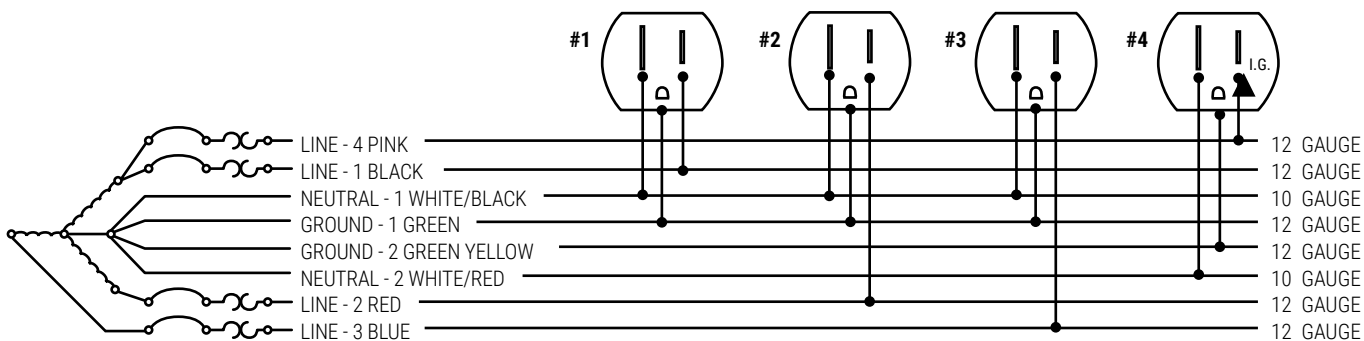

An 8-wire, 4-circuits, 3+1 electrical systems complies with UL 1286

8 Wires	4 Circuits	Receptacles
4 Lines (12ga.)	3 Utility Circuit	Duplex - Up to 6 duplex receptacles per circuit
2 Neutrals	1 Isolated Circuit	
2 Grounds (12ga.)		

Specifications
120 VAC system rated at 20A (15 CSA)

BRED50 • Duo Module



- The duo power module is completely integrated with a mounting clamp to attach to the edge of a worksurface.
- Provides two outlets and two 2.1 amp USB ports.
- White face plate, outlets and bracket; 72" long three-prong cord.

PRODUCT CODE	PRICE	SIZE/ INCHES			WEIGHT VOL	
		H	W	D	LBS	FT ³
BRED50	615	1.8	5.5	3.2	2.50	0.14

BRED50AC • Duo Module with A+C



- The Duo power module is completely integrated with a mounting clamp to attach to the edge of a worksurface.
- 10' long three-prong cord.
- Provides two 15 Amp 120 Volt AC Receptacles; 2.4 amp USB-A port and 60 watt USB-C power delivery port.
- Available in W - White or B - Black as indicated by last letter of model number.

PRODUCT CODE	PRICE	SIZE/ INCHES			WEIGHT VOL	
		H	W	D	LBS	FT ³
BRED50ACW	695	3	5.5	3.2	3	0.2
BRED50ACB	695	3	5.5	3.2	3	0.2

BREDU51 • Duo Under Module

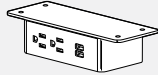

- The duo under power module comes with a thin flush mounting bracket to attach to the underside of a work surface or above work surface shelves.
- Provides two outlets and two 2.1 amp USB ports.
- White face plate, outlets and brackets; 72" long three-prong cord.

PRODUCT CODE	PRICE	SIZE/ INCHES			WEIGHT VOL	
		H	W	D	LBS	FT ³
BREDU51	537	1.8	5.5	2.8	2.5	0.14

BREDU51AC • Duo Under Module with A+C

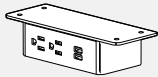

- The Duo under power module comes with a thin flush mounting bracket to attach to the underside of a work surface or above work surface shelves.
- 10' long three-prong cord.
- Provides two 15 Amp 120 Volt AC Receptacles; 2.4 amp USB-A port and 60 watt USB-C power delivery port.
- Available in W - White or B - Black as indicated by last letter of model number.

PRODUCT CODE	PRICE	SIZE/ INCHES			WEIGHT VOL	
		H	W	D	LBS	FT ³
BREDU51ACW	695	1.8	5.5	2.8	3	0.2
BREDU51ACB	695	1.8	5.5	2.8	3	0.2

BREDB52 • Duo Bezel Module



- The duo bezel power module is embedded and flush-mounted in a piece of furniture or a work surface.
- Provides two outlets and two 2.1 amp USB ports.
- White face plate, outlets and bezel; 72" long three-prong cord.
- Note: Will not work on W thick worksurfaces, please contact your Customer Service Representative for specific surface applications.

PRODUCT CODE	PRICE	SIZE/ INCHES			WEIGHT VOL	
		H	W	D	LBS	FT ³
BREDB52	576	4	6.5	3.2	2.5	0.14

BRETP53 • Trio Plus Module

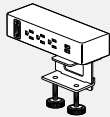

- The trio plus power module is completely integrated with a mounting clamp to attach to the edge of a work surface or above work surface shelves.
- Provides three outlets and two 2.1 amp USB ports and an adapter kit containing blank cover, HDMI, RJ45 or VGA adapter brackets. Note: HDMI, RJ45 and VGA connectors are not included.
- White face plate, outlets, adapters and brackets; 72" long three-prong cord.

PRODUCT CODE	PRICE	SIZE/ INCHES			WEIGHT VOL	
		H	W	D	LBS	FT ³
BRETP53	693	1.8	8	3.2	2.5	0.14

BRETPB55 • Trio Plus Bezel Module



- The trio plus bezel power module is embedded and flush-mounted in a piece of furniture or a work surface.
- Provides three outlets and two 2.1 amp USB ports and an adapter kit containing blank cover, HDMI, RJ45 or VGA adapter brackets. Note: HDMI, RJ45 and VGA connectors are not included.
- White face plate, outlets, adapters and bezel; 72" long three-prong cord.
- Will not work on W thick worksurfaces, please contact your Customer Service Representative for specific surface applications.

PRODUCT CODE	PRICE	SIZE/ INCHES			WEIGHT VOL	
		H	W	D	LBS	FT ³
BRETPB55	662	4	9	3.2	2.5	0.14

BRTPD5 • Data/Comm Spacer

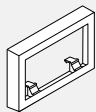

- Data/comm plate spacer extends the depth behind data/comm jacks by 0.6" in order to accommodate larger data/comm cable bending radius.
- Black finish.
- "W" indicates White, "S" indicates Silver.

PRODUCT CODE	PRICE	SIZE/ INCHES			WEIGHT VOL	
		H	W	D	LBS	FT ³
BRTPD5	45	2.04	4.75	0.6	0.1	0.01
BRTPD5W	45	2.04	4.75	0.6	0.1	0.01
BRTPD5S	45	2.04	4.75	0.6	0.1	0.01

BRACS • Cable Snake



- Flexible cable management trough.
- Two pathways within the snake, one for data/communication and one for routing power cables.
- Clear (CLR) available only.

PRODUCT CODE	PRICE	SIZE/ INCHES			WEIGHT VOL	
		H	W	D	LBS	FT ³
BRACS	123	30	8	2	3	0.19
BRACSH	207	49	8	2	5	0.27

BRTCM • Wire Manager



- Replacement wire manager can be added to Bridges. Wire manager neatly organizes and stores electrical and communication cables.
- Two lengths, 46" for tops 60" and under, 58" for tops 72".

PRODUCT CODE	PRICE	SIZE/ INCHES			WEIGHT VOL	
		H	W	D	LBS	FT ³
BRTCM43	47	3	5	46	8	0.67
BRTCM55	58	3	5	58	9	0.85

ModPower Power Solution

- Power solutions for flexible spaces. Connect up to four units (in Canada)/six units in the USA from a single infeed with NEMA plug to deliver power and charging ports to the table top. In-surface modules and clamp on modules available.
- Easy to install; code compliant that allows users to optimize any space providing convenient power access. Perfect for training areas, meeting rooms, in-office workstations and more. Units feature tamper-resistant receptacles as well as both USB-A and USB-C charging ports.
- Easy to use connectors that are touch-safe with added latch to prevent unintended separation. Easy push together to connect, and simple press down on latch to disconnect.
- Maximum overall length not to exceed 48.5 feet per infeed. UL listed to UL962A SD, the standard for furniture power distribution units for portable/moveable work space tables.
- Certified to CSA standard C22.2 No. 203-16.

- Will work with Licence, Terina and Bridges Products.
- Surface mounted module ships with a clamp mount that will accommodate any material 1/2" to 1-1/2" thick; additional brackets are also included for screw in mounting options that can accommodate vertical or horizontal positions.

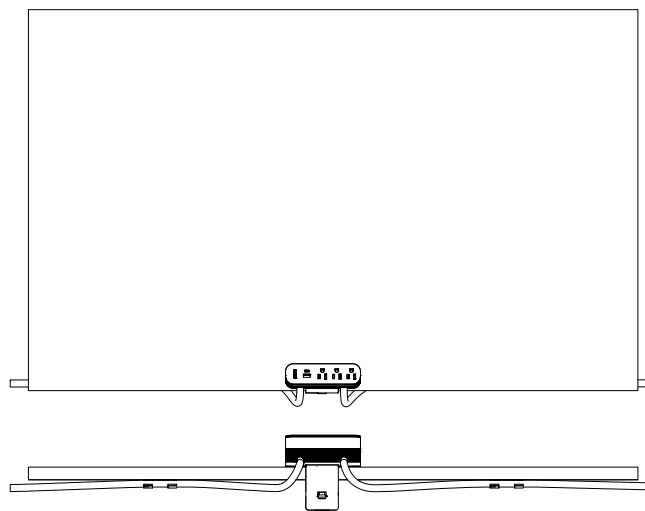
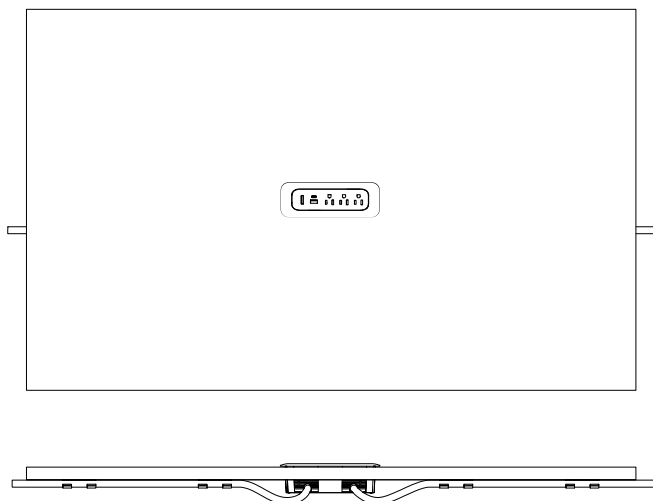
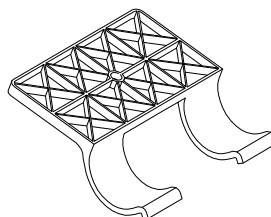

GMDSF10 • ModPower In Surface Starter Unit

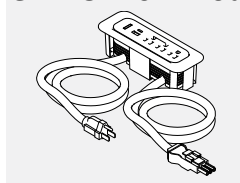

- ModPower starter unit includes one 10' cord with a NEMA plug and one 3' connector cord.
- Unit equipped with three 15A tamper resistant receptacles, one USB-A and one USB-C charging ports and a circuit breaker.
- 4 cable management cord clips included.
- MG at the end of the code indicates a magnesium finish, while WH is a white finish.

PRODUCT CODE	PRICE	DIMENSIONS			WEIGHT		VOL FT ³
		H	W	D	LBS	FT ³	
GMDSF10MG	597	2.63	7.63	2.63	3.44	1.0	
GMDSF10WH	597	2.63	7.63	2.63	3.44	1.0	

GMDCF3 • ModPower In Surface Middle Unit

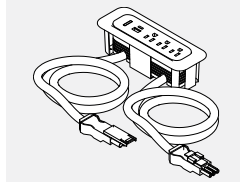

- ModPower middle unit includes two 3' connector cords.
- Unit equipped with three 15A rated 12A tamper resistant receptacles, one USB-A and one USB-C charging ports and a circuit breaker.
- 4 cable management cord clips included.
- MG at the end of the code indicates a magnesium finish, while WH is a white finish.

PRODUCT CODE	PRICE	DIMENSIONS			WEIGHT		VOL FT ³
		H	W	D	LBS	FT ³	
GMDCF3MG	562	2.63	7.63	2.63	2.44	1.0	
GMDCF3WH	562	2.63	7.63	2.63	2.44	1.0	

GMDEF3 • ModPower In Surface End Unit

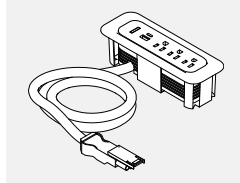

- ModPower end unit includes one 3' connector cord.
- Unit equipped with three 15A rated 12A tamper resistant receptacles, one USB-A and one USB-C charging ports and a circuit breaker.
- 2 cable management cord clips included.
- MG at the end of the code indicates a magnesium finish, while WH is a white finish.

PRODUCT CODE	PRICE	DIMENSIONS			WEIGHT		VOL FT ³
		H	W	D	LBS	FT ³	
GMDEF3MG	494	2.63	7.63	2.63	1.85	1.0	
GMDEF3WH	494	2.63	7.63	2.63	1.85	1.0	

GMDSA10 • ModPower Starter Mounted Unit

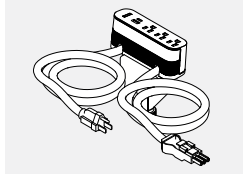

- ModPower starter unit includes one 10' cord with a NEMA plug and one 3' connector cord.
- Unit equipped with three 15A tamper resistant receptacles, one USB-A and one USB-C charging ports and a circuit breaker.
- Includes edge clamp and 3 other mounting methods; and 4 cable management cord clips.
- MG at the end of the code indicates a magnesium finish, while WH is a white finish.

PRODUCT CODE	PRICE	DIMENSIONS			WEIGHT		VOL	
		H	W	D	LBS	FT ³		
GMDSA10MG	631	2.5	6.13	1.75	4.33	1.0		
GMDSA10WH	631	2.5	6.13	1.75	4.33	1.0		

GMDCA3 • ModPower Middle Mounted Unit

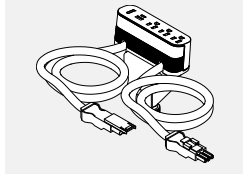

- ModPower middle unit includes two 3' connector cords.
- Unit equipped with three 15A rated 12A tamper resistant receptacles, one USB-A and one USB-C charging ports and a circuit breaker.
- Includes edge clamp and 3 other mounting methods; and 4 cable management cord clips.
- MG at the end of the code indicates a magnesium finish, while WH is a white finish.

PRODUCT CODE	PRICE	DIMENSIONS			WEIGHT		VOL	
		H	W	D	LBS	FT ³		
GMDCA3MG	597	2.5	6.13	1.75	3.33	1.0		
GMDCA3WH	597	2.5	6.13	1.75	3.33	1.0		

GMDEA3 • ModPower End Mounted Unit

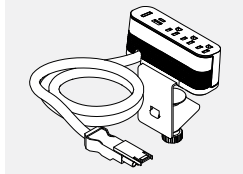

- ModPower end unit includes one 3' connector cord.
- Unit equipped with three 15A rated 12A tamper resistant receptacles, one USB-A and one USB-C charging ports and a circuit breaker.
- Includes edge clamp and 3 other mounting methods; and 2 cable management cord clips.
- MG at the end of the code indicates a magnesium finish, while WH is a white finish.

PRODUCT CODE	PRICE	DIMENSIONS			WEIGHT		VOL	
		H	W	D	LBS	FT ³		
GMDEA3MG	528	2.5	6.13	1.75	2.75	1.0		
GMDEA3WH	528	2.5	6.13	1.75	2.75	1.0		

GMDCLIPS • ModPower Management Clips

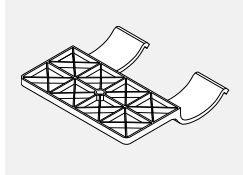

- Includes 10 clips.

PRODUCT CODE	PRICE	DIMENSIONS			WEIGHT		VOL	
		H	W	D	LBS	FT ³		
GMDCLIPS	102	0.6	2.6	2.5	0.3	0.2		

GMDJ36BK • ModPower Interconnecting Jumper

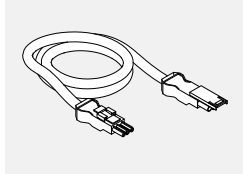

- ModPower interconnecting jumper cord to add an additional 3 feet of cord length between ModPower units.
- Package of 2, each 3 feet with male & female connector.

PRODUCT CODE	PRICE	DIMENSIONS			WEIGHT		VOL	
		H	W	D	LBS	FT ³		
GMDJ36BK	329		36		1.38	0.9		

BRTETA-KIT • Above Worksurface Power Trough

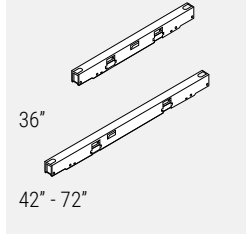

• **Above Worksurface Power Trough Kit Facilitates power distribution and data/communication cable management.**

- Formed steel trough is secured between Back 2 Back stations. Not suitable for single table assemblies.
- Power Trough Kits 36-72 consist of one double sided steel trough, Power Distribution Housing, mounting brackets and one charcoal grey extruded Data/Communication cable manager.
- Power Trough Kits 78 and 84 consist of two double sided steel troughs (BRTETA78KIT = BRTETA36 above KIT + BRTETA42KIT + Jumper. BRTETA84KIT = BRTETA42KIT + BRTETA42KIT + Jumper), two Power Distribution Housings, mounting brackets and two charcoal grey extruded Data/Communication cable managers.
- Specify Duplex receptacles separately. 36" trough can house one duplex per side and 42-72" trough can house two duplexes per side, 78" trough can house three duplexes and 84" trough can house four duplexes per side. Specify Jumpers between tables separately.
- Ceiling feed entry through slots at either end; base feed entry at either end.
- Each trough provides two openings 1.37" x 2.68" (one per side) for data/communication terminal plates. A single terminal plate (not supplied) can accommodate up to 4 data/communication plates.
- Data/comm plate spacer BRTPDS available to accommodate larger cable-to-terminal bending radius
- Each trough provides two openings 1.37" x 2.68" (one per side) for data/communication terminal plates. A single terminal plate (not supplied) can accommodate up to 4 data/communication terminals (jacks).
- Painted finish.
- Specify above worksurface power trough end cap BRTETEC to finish open ends of the power trough.
- Each trough includes one black (BRTPDS) data/comm spacer extending the depth behind the data/comm jacks by 0.6". White (BRTPDSW) and Silver (BRTPDSS) are also available as an option. Additional spacers may be purchased individually for \$45 list, see BRTPDS.

PRODUCT CODE	PRICE	SIZE/INCHES			WEIGHT VOL	
		H	W	D	LBS	FT ³
BRTETA36KIT	485	3.5	35.9	2.5	4.06	0.18
BRTETA42KIT	525	3.5	41.9	2.5	4.73	0.21
BRTETA48KIT	557	3.5	47.9	2.5	5.41	0.24
BRTETA54KIT	589	3.5	53.9	2.5	6.09	0.27
BRTETA60KIT	607	3.5	59.9	2.5	6.77	0.30
BRTETA66KIT	652	3.5	65.9	2.5	7.45	0.33
BRTETA72KIT	663	3.5	71.9	2.5	8.12	0.36
BRTETA78KIT	1008	3.5	78	2.5	8.81	0.39
BRTETA84KIT	1051	3.5	84	2.5	9.49	0.42

BRTTEST-KIT • Back 2 Back Storage Tower Gap Filler Kit

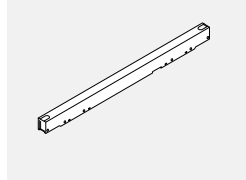

• **Consists of a formed sheet metal cover and four brackets which allow the cover to be mounted at either above worksurface power trough level or below work surface power trough level.**

- Versatile brackets secure the cover trough at corners, to the bottom of Back 2 Back work surface supported by either shared 51 or 63 legs or storage beam and storage towers.
- Note: the Back 2 Back storage tower gap filler is not compatible with single, freestanding tables.
- The BRTTEST15kit covers the gap between two Back 2 Back BRTT5024x or BRTT5030x storage towers.
- The BRTTEST30kit covers the gap between two pairs of Back 2 Back BRTT5024x or BRTT5030x storage towers.
- The BRTTEST24kit covers the gap between two Back 2 Back BRTTW5024x or BRTTW5030x storage towers.
- The BRTTEST48kit covers the gap between two pairs of Back 2 Back BRTTW5024x or BRTTW5030x storage towers.
- A corresponding harness is included.

PRODUCT CODE	PRICE	SIZE/INCHES			WEIGHT VOL	
		H	W	D	LBS	FT ³
BRTTEST15KIT	428	3.5	2.5	15.5	2	0.078
BRTTEST30KIT	495	3.5	2.5	31	3.5	0.157
BRTTEST24KIT	464	3.5	2.5	24	2.5	0.122
BRTTEST48KIT	547	3.5	2.5	48	4	0.243

BRTETEC • Above Worksurface Power Trough End Cap

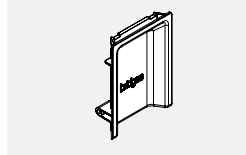

• **Covers the ends of the worksurface power trough.**

- Specify two per linear trough assembly.
- Finish white

PRODUCT CODE	PRICE	SIZE/INCHES			WEIGHT VOL	
		H	W	D	LBS	FT ³
BRTETEC	9	3.1	2.25	0.5	0.1	0.002

BRTVCM • Vertical Cable Manager

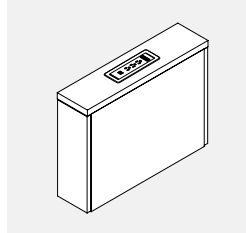

- 6" wide vertical channel which can be secured to an end or in-between 21" or 25" high storage units of corresponding depth.
- Facilitates power / data transfer from a floor monument under storage cabinets or from a panel base raceway to top of storage units.
- The units can join other 18" or 24" deep storage units to form a storage spine.
- Floor clearance allows for access to panel floor raceway duplex outlets.
- Removable top with a Below Worksurface Power/Data Module provides easy access.
- Optional Cable Basket suspends off storage unit's bottoms and manages cables along the horizontal plane. 3/4" LP chassis, fronts and back (specify LP finish), 1" top (specify LP or HP finish); unfinished cut-out edges. Universal connecting hardware included.
- Flush-mounted Trio Plus Bezel Module (BRETPE55) included
- Provides three outlets and two 2.1 amp USB ports and an adapter kit containing blank cover, HDMI, RJ45 or VGA adapter brackets. Note: HDMI, RJ45 and VGA connectors are not included.

PRODUCT CODE	PRICE		SIZE/INCHES			WEIGHT VOL	
	LP	HP	H	W	D	LBS	FT ³
BRTVCM2118	903	920	21	6	18	14	1.31
BRTVCM2518	920	935	25	6	18	17	1.56
BRTVCM2124	953	969	21	6	24	17	1.75
BRTVCM2524	969	985	25	6	24	22	2.08

BRTETB-SKIT • Below Worksurface Single Power/Data Trough

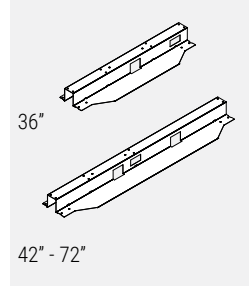

• **Below Worksurface Single Power Trough Kit Facilitates power distribution and data/communication cable management.**

- Formed steel trough is secured below a single table work-surface; outlets are facing the rear worksurface edge.
- Not suitable for Back 2 Back tables
- Power Trough Kits 36-72 consist of one single sided steel trough, Power Distribution Housing, mounting brackets and one charcoal grey extruded Data/Communi-cation cable manager.
- Power Trough Kits 78 and 84 consist of two single sided steel troughs (BRTERB78KIT = BRTETB36KIT + BRTETB42KIT + Jumper. BRTETB84KIT = BRTETB42KIT + BRTETB42KIT + Jumper), two Power Distribution Housings, mounting brackets and two charcoal grey extruded Data/Communication cable managers.
- Specify Duplex receptacles separately. 36" trough can house one duplex, 42-72" trough can house two duplexes, 78" through can house three duplexes and 84" trough can house four duplexes per side.
- Specify Jumpers between tables separately.
- Base feed entry at either end; no ceiling feed.
- Each trough provides one opening 1.37" x 2.68" for terminal plate (not supplied). One terminal plate can accommodate up to 4 data/communi-cation terminals (jacks).
- Each trough includes one black (BRTPDS) data/comm spacer extending the depth behind the data/comm jacks by 0.6". White (BRTPDSW) and Silver (BRTPDSS) are also available as an option. Additional spacers may be purchased individually for \$45 list, see BRTPDS.
- Painted finish.
- Note: Please specify BRTETB36SKIT Single Trough Kit for 120° Degree Tables BRTWAC120

PRODUCT CODE	PRICE	SIZE/INCHES			WEIGHT VOL	
		H	W	D	LBS	FT³
BRTETB36SKIT	428	2.5	30.34	8.5	4.5	0.59
BRTETB42SKIT	469	2.5	36.34	8.5	5.3	0.61
BRTETB48SKIT	508	2.5	42.34	8.5	6.2	0.71
BRTETB54SKIT	532	2.5	48.34	8.5	7.1	0.81
BRTETB60SKIT	541	2.5	54.34	8.5	8.0	0.91
BRTETB66SKIT	564	2.5	60.34	8.5	8.9	1.01
BRTETB72SKIT	583	2.5	66.34	8.5	9.8	1.11
BRTETB78SKIT	895	2.5	72.34	8.5	11.0	1.21
BRTETB84SKIT	935	2.5	78.34	8.5	12.0	1.31

BRTETB-DKIT • Below Worksurface Double Power/Data Trough

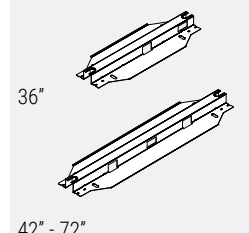

• **Below Worksurface Double Power Trough Kit Facili-tates power distribution and data/communication cable management.**

- Formed steel trough is secured below worksurfaces, between Back 2 Back stations, supported by Back 2 Back Legs.
- Not suitable for single table assemblies.
- Power Trough Kits 36-72 consist of one double sided steel trough, Power Distribution Housing, mounting brackets and one charcoal grey extruded Data/Communi-cation cable manager.
- Power Trough Kits 78 and 84 consist of two double sided steel troughs (BRTETB78KIT = BRTETB36KIT + BRTETB42KIT + Jumper. BRTETB84KIT = BRTETB42KIT + BRTETB42KIT + Jumper), two Power Distribution Housings, mounting brackets and two charcoal grey extruded Data/Communication cable managers.
- Specify Duplex receptacles separately. 36" trough can house one duplex per side, 42-72" trough can house two duplexes, 78" trough can house three duplexes and 84"trough can house four duplexes per side.
- Specify Jumpers between tables separately.
- Ceiling feed entry through slots at either end; base feed entry at either end.
- Each trough provides two openings 1.37" x 2.68"(one per side) for data/communication terminal plates (not supplied).
- Painted finish.
- Each trough includes one black (BRTPDS) data/comm spacer extending the depth behind the data/comm jacks by 0.6". White (BRTPDSW) and Silver (BRTPDSS) are also available as an option. Additional spacers may be purchased individually for \$45 list, see BRTPDS.

PRODUCT CODE	PRICE	SIZE/INCHES			WEIGHT VOL	
		H	W	D	LBS	FT³
BRTETB36DKIT	589	2.5	30.3	11.6	3.8	0.37
BRTETB42DKIT	607	2.5	36.3	11.6	4.5	0.44
BRTETB48DKIT	633	2.5	42.3	11.6	5.3	0.52
BRTETB54DKIT	646	2.5	48.3	11.6	6.0	0.59
BRTETB60DKIT	663	2.5	54.3	11.6	6.8	0.66
BRTETB66DKIT	686	2.5	60.3	11.6	7.5	0.74
BRTETB72DKIT	702	2.5	66.3	11.6	8.3	0.81
BRTETB78DKIT	1196	2.5	72.3	11.6	9.0	0.88
BRTETB84DKIT	1209	2.5	78.3	11.6	9.8	0.96

BRTCF • Bridges Ceiling Feed

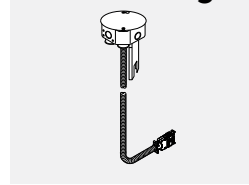

• **Ceiling feed provides a single power entry from ceiling, through Ceiling pole into Power Trough, into Power Distribution Housing.**

- An 8-wire (4-circuit) metal conduit harness with included metal junction box for hard wiring to the building power supply above ceiling tile.
- Must be hard wired to the building power supply by a licensed electrician.
- Ceiling Pole not included.

PRODUCT CODE	PRICE	SIZE/INCHES			WEIGHT VOL	
		H	W	D	LBS	FT³
BRTCF120	409	120	6	6	5	2
BRTCF144	455	144	6	6	6	3

BRTBF • Bridges Base Feed

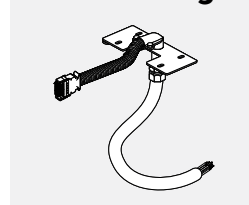

• **Provides single power entry from floor or wall located building power supply.**

- Connects to Power Distribution Housing.
- Must be hard wired to the building power supply by a licensed electrician.

PRODUCT CODE	PRICE	SIZE/INCHES			WEIGHT VOL	
		H	W	D	LBS	FT³
BRTBF	449	4	72	6	4	2
BRTBF120	641	4	120	6	6	2
BRTBF144	691	4	144	6	8	2

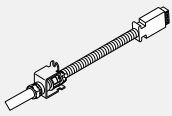
BRTDIVPBF • Bridges Divider Panel Base Feed

- Provides single power entry from floor or wall located building power supply.
- Connects to Power Distribution Housing.
- Must be hard wired to the building power supply by a licensed electrician.

PRODUCT CODE	PRICE	SIZE/INCHES			WEIGHT VOL	
		H	W	D	LBS	FT ³
BRTDIVPBF	430	4	72	6	4	2

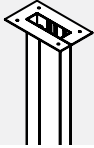
BRTCPP • Bridges Ceiling Pole

- Ceiling pole brings ceiling feed conduit and data cables from the ceiling down to Power troughs at desk height. Accommodates 10' ceiling heights.
- A two part construction allows power/data conduit lay-in.
- Includes mounting hardware and ceiling bezel.
- Painted finish.

PRODUCT CODE	PRICE	SIZE/INCHES			WEIGHT VOL	
		H	W	D	LBS	FT ³
BRTCPP	242	99	4.75	1.5	13	0.48

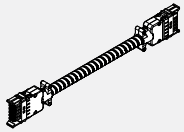
BRTHH • Housing to Housing Harness

- Distributes power between Power Distribution Housings.
- Specify BRTHH58 to distribute power from double sided, Back 2 Back below the worksurface power trough to a single sided, below work surface power trough at the end of a table run.
(Please see Power Delivery page at the beginning of electrical section (item #9)).

PRODUCT CODE	PRICE	SIZE/INCHES			WEIGHT VOL	
		H	W	D	LBS	FT ³
BRTHH28	145	2	28	0.5	1.0	1.17
BRTHH44	173	2	44.5	0.5	1.5	1.17
BRTHH52	183	2	52.5	0.5	2.0	1.17
BRTHH58	189	2	58.5	0.5	2.2	1.17
BRTHH76	212	2	76.5	0.5	2.8	1.17

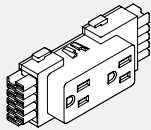
BRT8D • Duplex Receptacles

- Snaps into Power Distribution Housing.
- Up to 6 duplex receptacles per circuit.
- D1 = Circuit #1 (utility circuit)
- D2 = Circuit #2 (utility circuit)
- D3 = Circuit #3 (utility circuit)
- DA - Circuit #A (dedicated circuit)
- XW identifies white colour plastic, all others in standard black.

PRODUCT CODE	PRICE	SIZE/INCHES			WEIGHT VOL	
		H	W	D	LBS	FT ³
BRT8D1	32	2	4.625	1.25	0.10	0.01
BRT8D2	32	2	4.625	1.25	0.10	0.01
BRT8D3	32	2	4.625	1.25	0.10	0.01
BRT8DA	32	2	4.625	1.25	0.10	0.01
BRT8DXW1	47	2	4.625	1.25	0.10	0.01
BRT8DXW2	47	2	4.625	1.25	0.10	0.01
BRT8DXW3	47	2	4.625	1.25	0.10	0.01
BRT8DXWA	47	2	4.625	1.25	0.10	0.01

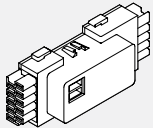
BE8D • USB Receptacles

- Snaps into Power Distribution Housing.
- USB charging module provides convenient charging power access through dual ports on face of receptacles.
- Two USB ports.
- 2 amp output, considered as circuit #1.

PRODUCT CODE	PRICE	SIZE/INCHES			WEIGHT VOL	
		H	W	D	LBS	FT ³
BRT8DU1-W	216	2	4.625	1.25	0.10	0.01
BRT8DU1-B	216	2	4.625	1.25	0.10	0.01

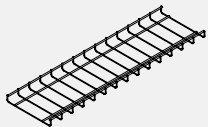
BRTCB • Power/Data Cable Basket

- Shallow, 8" wide basket manages cable excess. If suspended below Back 2 Back worksurfaces, it facilitates the simplest way of electrifying a workstation. The equipment can be plugged directly to a wall or floor monument outlets and the Cable Basket serves to manage cords and cables. It can be easily unclipped from steel brackets (included) to rearrange cable connections from below the worksurface.
- The same steel brackets can suspend the Cable Basket below storage cabinet's bottom where it keeps the cords and cables off the floor and manages them under storage cabinets along the horizontal plane - between panel base raceway outlets, floor monuments and Storage Vertical Cable Manager, for example.
- Tall storage cabinet's legs provide easy access to the Cable Basket where it can be easily unclipped from steel brackets (included) to rearrange cable connections.
- Note: wide Cable Baskets can span under several storage cabinets. As a general rule - specify Cable Basket min. 8" shorter than the storage cabinet spine assembly.
- Steel wire construction, black finish baskets; black steel hanging brackets, fasteners.
- BRTCB76KIT contains 2 pieces BRTCB34.

PRODUCT CODE	PRICE	SIZE/INCHES			WEIGHT VOL	
		H	W	D	LBS	FT ³
BRTCB8	78	1	8	8	0.36	0.03
BRTCB16	86	1	16	8	0.73	0.07
BRTCB22	90	1	22	8	1.01	0.10
BRTCB28	97	1	28	8	1.20	0.13
BRTCB34	111	1	34	8	1.56	0.15
BRTCB40	114	1	40	8	1.80	0.18
BRTCB46	123	1	46	8	2.16	0.21
BRTCB52	129	1	52	8	2.39	0.24
BRTCB58	140	1	58	8	2.66	0.26
BRTCB64	142	1	64	8	2.94	0.29
BRTCB70	154	1	70	8	3.22	0.34
BRTCB76KIT	212	1	34	8	1.56	0.15

BRPBS • Starter Beam



- Bridges Power Beam divides space, delineates territory, provides power and data to adjacent work spaces.
- Starter Beam can serve as a single, standalone unit or the beginning of a longer run of interconnected beams.
- 30" to 72" wide beams feature knockouts for two electrical duplex and one communication face place on each side while 24" wide beams accommodate one electrical duplex and one communication face place on each side.
- The leg expands by approximately 4" in height to compensate for uneven floors and allow for accurate levelling. Feet depth is 24".
- Starter Beam consist of the horizontal channel, raceway covers, two legs, two 24" deep feet, two vertical end trims and corresponding end trim capture strips.
- Specify standard Flat Top Trim (BRPBTC), Glass and Top Trim Kit (BRPBEG) or PET Felt and Top Trim Kit (BRPBEF) separately.
- Specify electrical components separately.
- Specify standard metal paint finish.

PRODUCT CODE	PRICE	SIZE/INCHES			WEIGHT LBS	VOL FT ³
		H	W	D		
BRPBS1824	406	18	24	24	20.23	6.00
BRPBS1830	431	18	30	24	21.83	7.50
BRPBS1836	450	18	36	24	23.14	9.00
BRPBS1842	471	18	42	24	24.46	10.50
BRPBS1848	496	18	48	24	25.77	12.00
BRPBS1854	517	18	54	24	27.08	13.50
BRPBS1860	538	18	60	24	28.39	15.00
BRPBS1866	562	18	66	24	29.7	16.50
BRPBS1872	595	18	72	24	31.01	18.00
BRPBS2624	432	26	24	24	21.24	8.67
BRPBS2630	457	26	30	24	22.84	10.83
BRPBS2636	476	26	36	24	24.15	13.00
BRPBS2642	497	26	42	24	25.47	15.17
BRPBS2648	523	26	48	24	26.77	17.33
BRPBS2654	544	26	54	24	28.09	19.50
BRPBS2660	564	26	60	24	29.4	21.67
BRPBS2666	588	26	66	24	30.7	23.83
BRPBS2672	621	26	72	24	32.02	26.00
BRPBS3424	455	34	24	24	22.25	11.33
BRPBS3430	489	34	30	24	23.85	14.17
BRPBS3436	508	34	36	24	25.16	17.00
BRPBS3442	529	34	42	24	26.47	19.83
BRPBS3448	554	34	48	24	27.78	22.67
BRPBS3454	575	34	54	24	29.09	25.50
BRPBS3460	596	34	60	24	30.4	28.33
BRPBS3466	617	34	66	24	31.71	31.17
BRPBS3472	656	34	72	24	33.02	34.00

BPRBA • Add-on Beam



- Bridges Power Beam divides space, delineates territory, provides power and data to adjacent work spaces.
- Add-on Beam connects to the Starter Beam and serves to extend the run of Bridges Power Beams as desired.
- 30" to 72" wide beams feature knockouts for two electrical duplex and one communication face place on each side while 24" wide beams accommodate one electrical duplex and one communication face place on each side.
- Add-on Beam consist of the horizontal channel, raceway covers, two legs, one foot and a pair of beam-to-beam connecting capture strips.
- The leg expands by approximately 4" in height to compensate for uneven floors and allow for accurate levelling. Feet depth is 24".
- Specify standard Flat Top Trim (BRPBTC), Glass and Top Trim Kit (BRPBEG) or PET Felt and Top Trim Kit (BRPBEF) separately.
- Specify electrical components separately.
- Specify standard metal paint finish.

PRODUCT CODE	PRICE	SIZE/INCHES			WEIGHT LBS	VOL FT ³
		H	W	D		
BPRBA1824	298	18	24	24	14.46	6.00
BPRBA1830	323	18	30	24	16.06	7.50
BPRBA1836	342	18	36	24	17.37	9.00
BPRBA1842	363	18	42	24	18.68	10.50
BPRBA1848	389	18	48	24	19.99	12.00
BPRBA1854	410	18	54	24	21.31	13.50
BPRBA1860	430	18	60	24	22.62	15.00
BPRBA1866	451	18	66	24	23.92	16.50
BPRBA1872	487	18	72	24	25.24	18.00
BPRBA2624	325	26	24	24	15.5	8.67
BPRBA2630	350	26	30	24	17.11	10.83
BPRBA2636	369	26	36	24	18.42	13.00
BPRBA2642	389	26	42	24	19.73	15.17
BPRBA2648	415	26	48	24	21.04	17.33
BPRBA2654	436	26	54	24	22.35	19.50
BPRBA2660	456	26	60	24	23.66	21.67
BPRBA2666	477	26	66	24	24.97	23.83
BPRBA2672	513	26	72	24	26.28	26.00
BPRBA3424	356	34	24	24	16.55	11.33
BPRBA3430	381	34	30	24	18.15	14.17
BPRBA3436	400	34	36	24	19.46	17.00
BPRBA3442	421	34	42	24	20.77	19.83
BPRBA3448	447	34	48	24	22.08	22.67
BPRBA3454	468	34	54	24	23.4	25.50
BPRBA3460	488	34	60	24	24.71	28.33
BPRBA3466	509	34	66	24	26.01	31.17
BPRBA3472	545	34	72	24	27.33	34.00

BRPBTC • Flat Top Trim

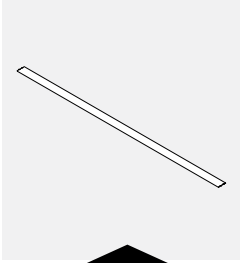

NEW!

- Flat Top Trim attaches on top of Bridges Power Beams to add privacy or divide space.
- Flat top trim is made of an aluminum extrusion.
- Specify standard metal paint finish.

PRODUCT CODE	PRICE	SIZE/INCHES			WEIGHT LBS	VOL FT ³
		H	W	D		
BRPBTC24	10	0.2	24	2.61	0.24	0.01
BRPBTC30	13	0.2	30	2.61	0.61	0.01
BRPBTC36	15	0.2	36	2.61	0.73	0.01
BRPBTC42	17	0.2	42	2.61	0.85	0.01
BRPBTC48	20	0.2	48	2.61	0.97	0.01
BRPBTC54	23	0.2	54	2.61	1.1	0.02
BRPBTC60	23	0.2	60	2.61	1.22	0.02
BRPBTC66	26	0.2	66	2.61	1.34	0.02
BRPBTC72	30	0.2	72	2.61	1.47	0.02

BRPBEG • Embedded Glass and Top Trim Kit

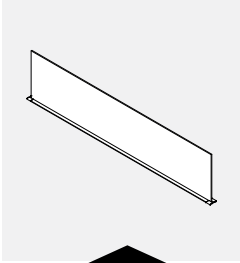

NEW!

- Embedded Glass and Top Trim Kit attaches on top of beams to add privacy or divide space.
- Embedded Glass Top Trim Kit consist of the extruded aluminum channel, die-cast channel end covers, glass partition, gasket and hardware required to secure the trim to the beam's horizontal channel.
- Specify standard metal paint finish.
- Clear tempered glass is standard.

PRODUCT CODE	PRICE	CLR	FRST	SIZE/INCHES			WEIGHT LBS	VOL FT ³
				H	W	D		
BRPBEG0824	125	207	8	24	2.61	9.42	0.29	
BRPBEG0830	133	214	8	30	2.61	11.79	0.36	
BRPBEG0836	140	222	8	36	2.61	14.15	0.44	
BRPBEG0842	148	230	8	42	2.61	16.52	0.51	
BRPBEG0848	163	254	8	48	2.61	18.88	0.58	
BRPBEG0854	181	283	8	54	2.61	19.52	0.65	
BRPBEG0860	198	311	8	60	2.61	20.58	0.73	
BRPBEG0866	215	340	8	66	2.61	21.55	0.80	
BRPBEG0872	238	374	8	72	2.61	23.62	0.87	
BRPBEG1624	130	212	16	24	2.61	9.891	0.58	
BRPBEG1630	160	256	16	30	2.61	12.37	0.73	
BRPBEG1636	179	302	16	36	2.61	14.85	0.87	
BRPBEG1642	204	347	16	42	2.61	17.346	1.02	
BRPBEG1648	229	392	16	48	2.61	19.824	1.16	
BRPBEG1654	253	413	16	54	2.61	21.25	1.31	
BRPBEG1660	278	482	16	60	2.61	23.62	1.45	
BRPBEG1666	303	527	16	66	2.61	25.98	1.60	
BRPBEG1672	333	578	16	72	2.61	28.35	1.74	

BRPBEF • Embedded PET Felt and Top Trim Kit

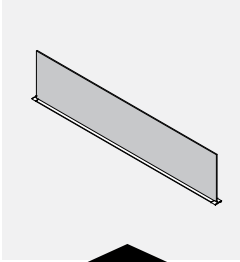

NEW!

- Embedded PET Felt and Top Trim Kit attaches on top of beams to add privacy or divide space.
- - Embedded PET Felt Top Trim Kit consist of the extruded aluminum channel, die-cast channel end covers, PET felt partition and hardware required to secure the trim to the beams horizontal channel.
- Specify standard metal paint finish.
- 9mm PET felt material is tackable Please specify standard finish.

PRODUCT CODE	PRICE	SIZE/INCHES			WEIGHT LBS	VOL FT ³
		H	W	D		
BRPBEF0824	61	8	24	2.61	1.32	0.29
BRPBEF0830	64	8	30	2.61	1.65	0.36
BRPBEF0836	85	8	36	2.61	1.99	0.44
BRPBEF0842	89	8	42	2.61	2.32	0.51
BRPBEF0848	160	8	48	2.61	2.65	0.58
BRPBEF0854	164	8	54	2.61	2.98	0.65
BRPBEF0860	167	8	60	2.61	3.32	0.73
BRPBEF0866	171	8	66	2.61	3.65	0.80
BRPBEF0872	180	8	72	2.61	3.98	0.87
BRPBEF1624	61	16	24	2.61	1.83	0.58
BRPBEF1630	64	16	30	2.61	2.3	0.73
BRPBEF1636	85	16	36	2.61	2.76	0.87
BRPBEF1642	89	16	42	2.61	3.22	1.02
BRPBEF1648	160	16	48	2.61	3.68	1.16
BRPBEF1654	164	16	54	2.61	4.14	1.31
BRPBEF1660	167	16	60	2.61	4.61	1.45
BRPBEF1666	171	16	66	2.61	5.07	1.60
BRPBEF1672	180	16	72	2.61	5.53	1.74

BRPBEFP • Embedded Perforated PET Felt and Top Trim Kit

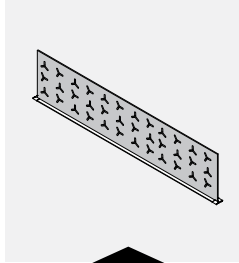

NEW!

- Embedded Perforated PET Felt and Top Trim Kit attaches on top of beams to add privacy or divide space.
- Embedded Perforated PET Felt Top Trim Kit consist of the extruded aluminum channel, die-cast channel end covers, perforated PET felt partition and hardware required to secure the trim to the beams horizontal channel.
- Specify standard metal paint finish.
- 9mm PET felt material is tackable. Please specify standard finish.

PRODUCT CODE	PRICE	SIZE/INCHES			WEIGHT LBS	VOL FT ³
		H	W	D		
BRPBEFP0824	122	8	24	2.61	1.32	0.29
BRPBEFP0830	129	8	30	2.61	1.65	0.36
BRPBEFP0836	170	8	36	2.61	1.99	0.44
BRPBEFP0842	177	8	42	2.61	2.32	0.51
BRPBEFP0848	320	8	48	2.61	2.65	0.58
BRPBEFP0854	327	8	54	2.61	2.98	0.65
BRPBEFP0860	335	8	60	2.61	3.32	0.73
BRPBEFP0866	342	8	66	2.61	3.65	0.80
BRPBEFP0872	360	8	72	2.61	3.98	0.87
BRPBEFP1624	122	16	24	2.61	1.83	0.58
BRPBEFP1630	129	16	30	2.61	2.3	0.73
BRPBEFP1636	170	16	36	2.61	2.76	0.87
BRPBEFP1642	177	16	42	2.61	3.22	1.02
BRPBEFP1648	320	16	48	2.61	3.68	1.16
BRPBEFP1654	327	16	54	2.61	4.14	1.31
BRPBEFP1660	335	16	60	2.61	4.61	1.45
BRPBEFP1666	342	16	66	2.61	5.07	1.60
BRPBEFP1672	360	16	72	2.61	5.53	1.74

BPX30P • Over Panel Frame

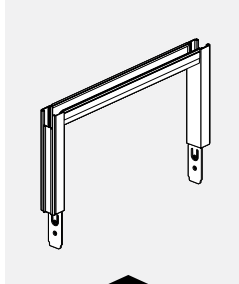

NEW!

- Attaches to the top of any Boulevard System 3 panel to create a floor-to-ceiling wall.
- Any tile can be attached to either side to enclose the frame.
- Two non-slotted uprights at either end slide into vertical extrusions on the base.
- Shipped without horizontal and vertical trim, specify separately.
- Openings in horizontal channels allow for vertical cable passage from top lay-in channel and behind the cover tiles
- Over Panel Frames 18" and 24" wide are not punched for vertical wire channel.
- Boulevard System 3 Over Panel is not compatible with Boulevard 1 panels.

PRODUCT CODE	PRICE	SIZE/ INCHES			WEIGHT LBS	VOL FT ³
		H	W	D		
BPX30P0824	99	8	24	2.61	4	0.43
BPX30P0830	106	8	30	2.61	4	0.65
BPX30P0836	114	8	36	2.61	4	0.71
BPX30P0842	127	8	42	2.61	5	0.87
BPX30P0848	134	8	48	2.61	5	0.93
BPX30P0854	142	8	54	2.61	6	1.04
BPX30P0860	151	8	60	2.61	6	1.20
BPX30P0866	168	8	66	2.61	7	1.31
BPX30P0872	186	8	72	2.61	8	1.42
BPX30P1624	99	16	24	2.61	5	0.73
BPX30P1630	106	16	30	2.61	5	1.09
BPX30P1636	114	16	36	2.61	5	1.18
BPX30P1642	127	16	42	2.61	6	1.45
BPX30P1648	134	16	48	2.61	6	1.55
BPX30P1654	142	16	54	2.61	7	1.73
BPX30P1660	151	16	60	2.61	7	2.00
BPX30P1666	168	16	66	2.61	9	2.16
BPX30P1672	186	16	72	2.61	10	2.37

BP3FT • Removeable Face Tile - Fabric or Laminate

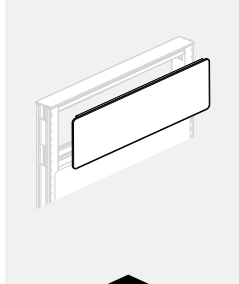

NEW!

- Attaches to any opening in a Pass-Thru Panel.
- Tile clips included.
- Easily interchangeable on site.
- Specify two tiles per over panel opening of corresponding width. Tiles can be combined. For example, Fabric Tile on one side and Accessory Tile on the opposite side of the same panel.
- OPT* = Laminate or Whiteboard.

PRODUCT CODE	PRICE			SIZE/ INCHES			WEIGHT VOL	
	GR1	GR2	OPT*	H	W	D	LBS	FT ³
BP3FT0824	94	103	110	8	24	0.25	1	0.16
BP3FT0830	103	114	130	8	30	0.25	2	0.20
BP3FT0836	127	140	154	8	36	0.25	2	0.25
BP3FT0842	135	147	164	8	42	0.25	2	0.29
BP3FT0848	141	154	168	8	48	0.25	3	0.33
BP3FT0854	149	164	176	8	54	0.25	3	0.37
BP3FT0860	154	167	182	8	60	0.25	4	0.41
BP3FT0866	175	232	296	8	66	0.25	4	0.46
BP3FT0872	226	298	373	8	72	0.25	4	0.50
BP3FT1624	106	112	120	16	24	0.25	2	0.33
BP3FT1630	113	128	142	16	30	0.25	3	0.41
BP3FT1636	140	152	167	16	36	0.25	3	0.50
BP3FT1642	149	164	176	16	42	0.25	3	0.58
BP3FT1648	156	169	186	16	48	0.25	4	0.66
BP3FT1654	165	176	193	16	54	0.25	4	0.75
BP3FT1660	182	240	199	16	60	0.25	5	0.83
BP3FT1666	199	256	319	16	66	0.25	5	0.92
BP3FT1672	246	326	408	16	72	0.25	6	1.00

BP3AT • Removable Face Tile - Accessory

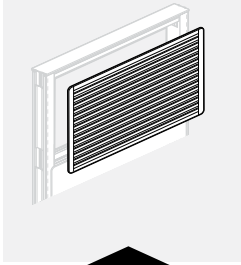

NEW!

- Attaches to any opening in an Over Panel Frame.
- Provides support for accessories.
- Easily interchangeable on site.
- Two tile clips included.
- Specify two tiles per over panel opening of corresponding width. Tiles can be combined. For example, Fabric Tile on one side and Accessory Tile on the opposite side of the same panel.
- Accessory Tile cannot be installed opposite an electrical tile.

PRODUCT CODE	PRICE	SIZE/ INCHES			WEIGHT VOL	
		H	W	D	LBS	FT ³
BP3AT0824	112	08	24	0.25	2.3	0.16
BP3AT0830	123	08	30	0.25	2.9	0.20
BP3AT0836	145	08	36	0.25	3.5	0.25
BP3AT0842	175	08	42	0.25	4.1	0.29
BP3AT0848	205	08	48	0.25	4.7	0.33
BP3AT0854	220	08	54	0.25	5.3	0.37
BP3AT0860	251	08	60	0.25	5.9	0.41
BP3AT0866	271	08	66	0.25	6.5	0.45
BP3AT0872	294	08	72	0.25	7.0	0.50
BP3AT1624	134	16	24	0.25	4.7	0.33
BP3AT1630	143	16	30	0.25	5.7	0.41
BP3AT1636	173	16	36	0.25	7.0	0.50
BP3AT1642	205	16	42	0.25	8.2	0.58
BP3AT1648	238	16	48	0.25	9.4	0.66
BP3AT1654	257	16	54	0.25	10.6	0.75
BP3AT1660	295	16	60	0.25	11.9	0.83
BP3AT1666	326	16	66	0.25	13.0	0.91
BP3AT1672	355	16	72	0.25	14.0	1.00

BP3GT • Removable Face Tile - Glazed

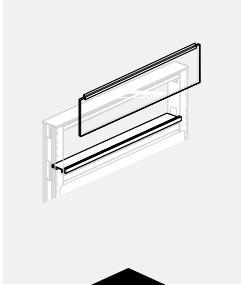

NEW!

- Attaches to any opening in a Pass-Thru Panel.
- 8" or 16" high glazing provides visual accessibility and light transfer.
- Easily interchangeable on site.
- Specify one Glazed Tile for over panel opening of corresponding width.
- Clear tempered glass standard.

PRODUCT CODE	PRICE	FRST/SMK	SIZE/ INCHES			WEIGHT VOL	
			H	W	D	LBS	FT ³
BP3GT0824	112	134	8	24	2.61	3.1	0.16
BP3GT0830	123	147	8	30	2.61	3.9	0.20
BP3GT0836	144	173	8	36	2.61	4.7	0.25
BP3GT0842	168	202	8	42	2.61	5.5	0.29
BP3GT0848	194	231	8	48	2.61	6.3	0.33
BP3GT0854	218	262	8	54	2.61	7.1	0.37
BP3GT0860	242	292	8	60	2.61	7.8	0.41
BP3GT0866	268	321	8	66	2.61	8.6	0.46
BP3GT0872	292	352	8	72	2.61	9.4	0.50
BP3GT1624	121	145	16	24	2.61	5.8	0.33
BP3GT1630	140	167	16	30	2.61	7.2	0.41
BP3GT1636	169	204	16	36	2.61	8.7	0.50
BP3GT1642	198	238	16	42	2.61	10.2	0.58
BP3GT1648	228	272	16	48	2.61	11.6	0.66
BP3GT1654	256	308	16	54	2.61	13.1	0.75
BP3GT1660	286	342	16	60	2.61	14.6	0.83
BP3GT1666	315	361	16	66	2.61	16.0	0.91
BP3GT1672	342	394	16	72	2.61	17.5	1.00

BRP3PS • 90 Degree Post

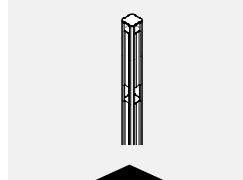

NEW!

- Post facilitates splitting of the beam run into up to 4 directions at 90 angle.
- Post kit consist of the extruded aluminum post and four pairs of capture strip connectors.
- Post Vertical Trim must be specified in accordance to your post 2-way, 3-way or 4-way configuration.
- Specify painted metal finish colour.

PRODUCT CODE	PRICE	SIZE/INCHES			WEIGHT LBS	VOL FT ³
		H	W	D		
BRP3PS018	65	18	2.61	2.61	3.00	0.12
BRP3PS026	93	26	2.61	2.61	3.60	0.13
BRP3PS034	122	34	2.61	2.61	4.00	0.14

BRP3PS • 60 Degree Post

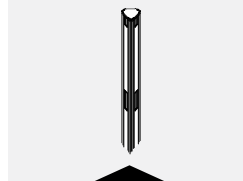

NEW!

- Post facilitates splitting of the beam run into up to 3 directions at 120 angle.
- Post kit consist of the extruded aluminum post and three pairs of capture strip connectors.
- Post Vertical Trim must be specified in accordance to your post 2-way, 3-way or 4-way configuration.
- Specify painted metal finish colour.

PRODUCT CODE	PRICE	SIZE/INCHES			WEIGHT LBS	VOL FT ³
		H	W	D		
BRP3PS60018	65	18	2.61	2.61	3.00	0.12
BRP3PS60026	93	26	2.61	2.61	3.60	0.13
BRP3PS60034	122	34	2.61	2.61	4.00	0.14

BRP3PS • 45 Degree Post

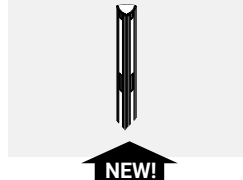

NEW!

- Post facilitates two beams at 45 angle.
- Post kit consist of the extruded aluminum post and four pairs of capture strip connectors.
- Post Vertical Trim must be specified in accordance to your post 2-way, 3-way or 4-way configuration.
- Specify painted metal finish colour.

PRODUCT CODE	PRICE	SIZE/INCHES			WEIGHT LBS	VOL FT ³
		H	W	D		
BRP3PS45018	65	18	2.61	2.61	3.00	0.12
BRP3PS45026	93	26	2.61	2.61	3.60	0.13
BRP3PS45034	122	34	2.61	2.61	4.00	0.14

BRPVTRF • End Trim

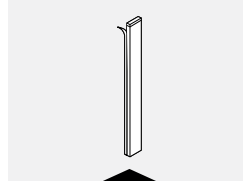

NEW!

- Attaches to Post
- Consist of the extruded aluminum trim and one pair of capture strip connectors.
- Post Vertical Trim must be specified in accordance to your post 2-way, 3-way or 4-way configuration.
- Specify painted metal finish colour.

PRODUCT CODE	PRICE	SIZE/INCHES			WEIGHT LBS	VOL FT ³
		H	W	D		
BRPVTRF18	22	18	2.61	2.61	0.50	0.01
BRPVTRF26	29	26	2.61	2.61	0.72	0.02
BRPVTRF34	37	34	2.61	2.61	0.94	0.03
BRPVTRF42	45	42	2.61	2.61	1.16	0.04
BRPVTRF50	54	50	2.61	2.61	1.38	0.05

BA3VTEF • Overpanel End Trim

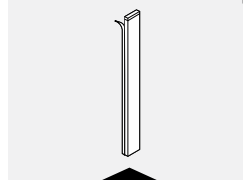

NEW!

- Attaches to sides of Overpanel Extension frame.
- Overpanel Extension Vertical Trim consist of the extruded aluminum trim, die-cast corner and a pair capture strip connectors.
- Overpanel Extension Vertical Trim must be specified because Overpanel Extensions may not necessarily continue in full length, and single, strategically positioned Overpane Extensions will therefore require their own vertical trims in corresponding locations.
- Specify metal finish colour

PRODUCT CODE	PRICE	SIZE/INCHES			WEIGHT LBS	VOL FT ³
		H	W	D		
BA3VTEF8	11	8	2.61	0.125	0.20	0.01
BA3VTEF16	23	16	2.61	0.125	0.50	0.03

BRPRB • Round Disk Base for Post

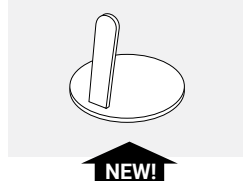

NEW!

- Attached to the bottom of BRP3PS Post to provide stability at an intersection.
- Round metal plate is 1/4" thick.
- Specify painted metal finish colour.

PRODUCT CODE	PRICE	SIZE/INCHES			WEIGHT LBS	VOL FT ³
		H	W	D		
BRPRB	235	6.5	7.5	7.5	3.67	0.01

BEPE • Post Extension

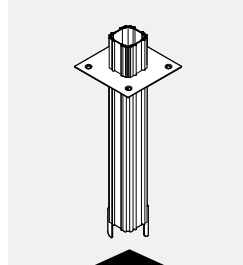

NEW!

- **Lightweight aluminum pole to be used to bring power and/or data/communication cables from ceiling to a beam through a post.**
- Attaches to ceiling and post.
- Includes connectors, ceiling trim plate and screws.
- Post extension will accept:
 - 75 cables 5.6mm (0.220") dia. data cables
 - 60 cables 5.6mm (0.220") dia. data cables with 1 power feed
 - 45 cables 5.6mm (0.220") dia. data cables with 2 power feeds.
- Ceiling bezel is white only.
- Specify metal finish colour

PRODUCT CODE	PRICE	SIZE/INCHES			WEIGHT LBS	VOL FT ³
		H	W	D		
BEPE81	171	81	2.61	2.61	9	0.43

B3LEP-NC • End of Run Gallery Panel in a T configuration, No Connectors for Additional Gallery Panels

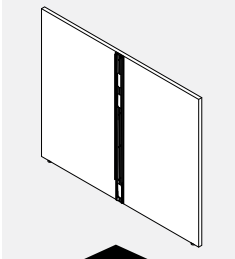

NEW!

- Provides floor standing support while enclosing the end of a panel run on two sides.
- Attaches to the end of a Bridges Power Beam with capture strips to form a T configuration.
- Connection is on the interior face center.
- Includes all attachment hardware and glides.
- Total height is inclusive of panel glides extended to their full height.
- 51" wide gallery panel accommodates two 24" deep surfaces while the 63" wide accommodates two 30" deep surfaces and 75" wide two 36" deep surfaces.
- Please specify LP laminate finish and PVC edge finish.
- If a wood grain laminate is chosen, grain direction run horizontally.
- Edged in PVC on three exposed edges and self edged on bottom.

PRODUCT CODE	PRICE LP	SIZE/INCHES			WEIGHT LBS	VOL FT ³
		H	W	D		
B3LEP4227NC	404	42	26.5	1	29.49	0.64
B3LEP4251NC	634	42	51	1	55.17	1.24
B3LEP4263NC	710	42	63	1	68.01	1.53
B3LEP4275NC	790	42	75	1	80.86	1.82
B3LEP5027NC	471	50	26.5	1	35.25	0.77
B3LEP5051NC	736	50	51	1	65.92	1.48
B3LEP5063NC	829	50	63	1	81.27	1.82
B3LEP5075NC	936	50	75	1	96.62	2.17
B3LEP5427NC	471	54	26.5	1	38.12	0.83
B3LEP5451NC	758	54	51	1	71.3	1.59
B3LEP5463NC	854	54	63	1	87.9	1.97
B3LEP5475NC	965	54	75	1	104.49	2.34

B3LSEPL-NC • Left End of Run Single Gallery Panel in L Configuration, No Connectors for Additional Gallery Panels

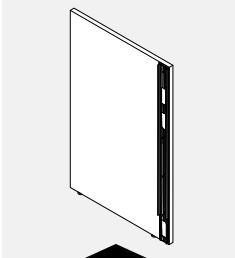

NEW!

- Provides floor standing support while enclosing the end of a panel run on one side.
- Attaches to the end of a Bridges Power Beam with capture strips to form an L configuration.
- Connection is on interior face near it's right end.
- Includes all attachment hardware and glides.
- Total height is inclusive of panel glides extended to their full height.
- 27" wide gallery panel accommodates a 24" deep surface while the 33" wide accommodates a 30" deep surface and 39" wide a 36" deep surface.
- Please specify LP laminate finish and PVC edge finish.
- If a wood grain laminate is chosen, grain direction run horizontally.
- Edged in PVC on three exposed edges and self edged on bottom.

PRODUCT CODE	PRICE LP	SIZE/INCHES			WEIGHT LBS	VOL FT ³
		H	W	D		
B3LSEPL4215NC	332	42	14.25	1	16.64	0.35
B3LSEPL4227NC	483	42	27	1	29.47	0.66
B3LSEPL4233NC	521	42	33	1	35.89	0.80
B3LSEPL4239NC	548	42	39	1	42.32	0.95
B3LSEPL5015NC	378	50	14.25	1	19.9	0.41
B3LSEPL5027NC	549	50	27	1	35.23	0.78
B3LSEPL5033NC	595	50	33	1	42.9	0.95
B3LSEPL5039NC	637	50	39	1	50.57	1.13
B3LSEPL5415NC	378	54	14.25	1	21.52	0.45
B3LSEPL5427NC	565	54	27	1	38.1	0.84
B3LSEPL5433NC	614	54	33	1	46.4	1.03
B3LSEPL5439NC	657	54	39	1	54.7	1.22

B3LSEPR-NC • Right End of Run Single Gallery Panel in L Configuration, No Connectors for Additional Gallery Panels

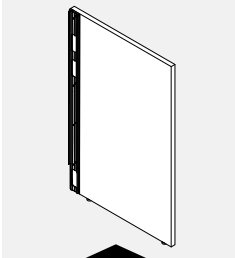

NEW!

- Provides floor standing support while enclosing the end of a panel run on one side.
- Attaches to the end of a Bridges Power Beam with capture strips to form an L configuration.
- Connection is on interior face near it's right end.
- - Includes all attachment hardware and glides.
- Total height is inclusive of panel glides extended to their full height.
- 27" wide gallery panel accommodates a 24" deep surface while the 33" wide accommodates a 30" deep surface and 39" wide a 36" deep surface.
- Please specify LP laminate finish and PVC edge finish.
- If a wood grain laminate is chosen, grain direction run horizontally.
- Edged in PVC on three exposed edges and self edged on bottom.

PRODUCT CODE	PRICE LP	SIZE/INCHES			WEIGHT LBS	VOL FT ³
		H	W	D		
B3LSEPR4215NC	332	42	14.25	1	16.64	0.35
B3LSEPR4227NC	483	42	27	1	29.47	0.66
B3LSEPR4233NC	521	42	33	1	35.89	0.80
B3LSEPR4239NC	548	42	39	1	42.32	0.95
B3LSEPR5015NC	378	50	14.25	1	19.9	0.41
B3LSEPR5027NC	549	50	27	1	35.23	0.78
B3LSEPR5033NC	595	50	33	1	42.9	0.95
B3LSEPR5039NC	637	50	39	1	50.57	1.13
B3LSEPR5415NC	378	54	14.25	1	21.52	0.45
B3LSEPR5427NC	565	54	27	1	38.1	0.84
B3LSEPR5433NC	614	54	33	1	46.4	1.03
B3LSEPR5439NC	657	54	39	1	54.7	1.22

B3LEP • End of Run Gallery Panel in a T configuration, with Connectors for Additional Gallery Panels

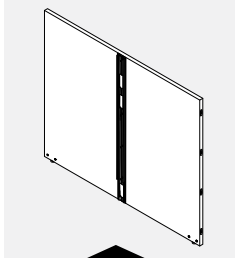

NEW!

- Provides floor standing support while enclosing the end of a panel run.
- Attaches to the end of a Bridges Power Beam with capture strips to form a T configuration.
- Connections at both ends as well as on the middle of interior face.
- The end connections are to connect other Gallery Panels.
- The side right is compatible with right hand Gallery Panels (B3LX-PRxxxx and B3LXPRxxxxNC, B3L2PRxxxx and B3L3PRxxxx) only.
- The left side is compatible with left hand Gallery Panels (B3LX-PLxxxx and B3LXPLxxxxNC, B3L2PLxxxx and B3L3PLxxxx) only.
- The middle interior face connections are for Boulevard panels.
- Includes all attachment hardware and glides.
- Total height is inclusive of panel glides extended to their full height.
- 51" wide gallery panel accomodates two 24" deep surface while the 63" wide accomodates two 30" deep surfaces and 75" wide two 36" deep surfaces.
- Please specify LP laminate finish and PVC edge finish.
- If a wood grain laminate is chosen, grain direction run horizontally.
- Gallery panel is edged in PVC on exposed top edge only and self edged on the three other edges.

PRODUCT CODE	PRICE LP	SIZE/INCHES			WEIGHT LBS	VOL FT ³
		H	W	D		
B3LEP4251	648	42	51	1	55.25	1.24
B3LEP4263	723	42	63	1	68.1	1.53
B3LEP4275	804	42	75	1	80.95	1.82
B3LEP5051	750	50	51	1	66.01	1.48
B3LEP5063	843	50	63	1	81.36	1.82
B3LEP5075	950	50	75	1	96.71	2.17
B3LEP5451	772	54	51	1	71.38	1.59
B3LEP5463	868	54	63	1	87.98	1.97
B3LEP5475	979	54	75	1	104.58	2.34

B3LSEPL • Left End of Run Single Gallery Panel in L Configuration, with Connectors for Additional Gallery Panels

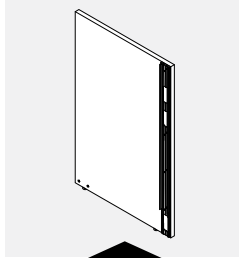

NEW!

- Provides floor standing support while enclosing the end of a panel run.
- Attaches at the end of a Bridges Power Beam with capture strips to form an L configuration.
- Connection to the Boulevard panel is on interior face near its right end.
- Connections for a Gallery Panel are on the left edge.
- Compatible with left hand Gallery Panels (B3LXPLxxxx and B3LXPLxxxxNC, B3L2PLxxxx and B3L3PLxxxx) only.
- Includes all attachment hardware and glides.
- Total height is inclusive of panel glides extended to their full height.
- 27" wide gallery panel accomodates a 24" deep surface while the 33" wide accomodates a 30" deep surface and 39" wide a 36" deep surface.
- Please specify LP laminate finish and PVC edge finish.
- If a wood grain laminate is chosen, grain direction run horizontally.
- Edged in PVC on two exposed edges, self edged on connecting to gallery panel edge and the bottom.

PRODUCT CODE	PRICE LP	SIZE /INCHES			WEIGHT LBS	VOL FT ³
		H	W	D		
B3LSEPL4227	490	42	27	1	29.51	0.66
B3LSEPL4233	528	42	33	1	35.94	0.80
B3LSEPL4239	554	42	39	1	42.36	0.95
B3LSEPL5027	556	50	27	1	35.27	0.78
B3LSEPL5033	603	50	33	1	42.94	0.95
B3LSEPL5039	645	50	39	1	50.62	1.13
B3LSEPL5427	572	54	27	1	38.14	0.84
B3LSEPL5433	620	54	33	1	46.44	1.03
B3LSEPL5439	663	54	39	1	54.74	1.22

B3LSEPR • Right End of Run Single Gallery Panel in L Configuration, with Connectors for additional Gallery Panels

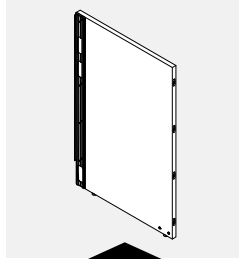

NEW!

- Provides floor standing support while enclosing the end of a panel run.
- Attaches at the end of a Bridges Power Beam with capture strips to form an L configuration.
- Connection to the Boulevard panel is on interior face near its left end.
- Connections for a Gallery Panel are on the right edge.
- Compatible with right hand Gallery Panels (B3LXPRxxxx and B3LXPRxxxxNC, B3L2PRxxxx and B3L3PRxxxx) only.
- Includes all attachment hardware and glides.
- Total height is inclusive of panel glides extended to their full height.
- 27" wide gallery panel accomodates a 24" deep surface while the 33" wide accomodates a 30" deep surface and 39" wide a 36" deep surface.
- Please specify LP laminate finish and PVC edge finish.
- If a wood grain laminate is chosen, grain direction run horizontally.
- Edged in PVC on two exposed edges, self edged on connecting to gallery panel edge and the bottom.

PRODUCT CODE	PRICE LP	SIZE /INCHES			WEIGHT LBS	VOL FT ³
		H	W	D		
B3LSEPR4227	490	42	27	1	29.51	0.66
B3LSEPR4233	528	42	33	1	35.94	0.80
B3LSEPR4239	554	42	39	1	42.36	0.95
B3LSEPR5027	556	50	27	1	35.27	0.78
B3LSEPR5033	603	50	33	1	42.94	0.95
B3LSEPR5039	645	50	39	1	50.62	1.13
B3LSEPR5427	572	54	27	1	38.14	0.84
B3LSEPR5433	620	54	33	1	46.44	1.03
B3LSEPR5439	663	54	39	1	54.74	1.22

B3LXPL • Left Gallery Panel Extension, with Connectors for Additional Gallery Panels

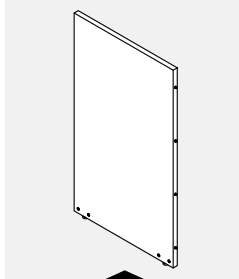

NEW!

- Provides floor standing support while extending the Gallery Panels runs.
- Attaches to the left edge of a Gallery Panel by the pin connectors to allow for additional Gallery Panels to be added on the left side.
- Pin connectors on the right edge and modular connectors on the left edge of the interior face.
- The right side is compatible with Gallery Panels (B3LEPxxx, B3LSEPL, B3LMPxxx, B3LSMP and B3LXPLxxx) only.
- The left side is compatible with left hand Gallery Panels (B3LXPLxxxx and B3LXPLxxxxNC, B3L2PLxxxx and B3L3PLxxxx) only.
- Includes all attachment hardware and glides.
- Total height is inclusive of panel glides extended to their full height.
- Please specify LP laminate finish and PVC edge finish.
- If a wood grain laminate is chosen, grain direction run horizontally.
- Edged in PVC on exposed top edge only and self edges on the three other.
- Edged in PVC on two exposed edges, self edged on connecting to gallery panel edge and the bottom.

PRODUCT CODE	PRICE LP	SIZE /INCHES			WEIGHT LBS	VOL FT ³
		H	W	D		
B3LXPL4224	252	42	24	1	25.83	0.58
B3LXPL4230	290	42	30	1	32.26	0.73
B3LXPL4236	328	42	36	1	38.68	0.88
B3LXPL4242	365	42	42	1	45.11	1.02
B3LXPL4248	403	42	48	1	51.53	1.17
B3LXPL5024	300	50	24	1	30.83	0.69
B3LXPL5030	347	50	30	1	38.51	0.87
B3LXPL5036	394	50	36	1	46.18	1.04
B3LXPL5042	440	50	42	1	53.86	1.22
B3LXPL5048	487	50	48	1	61.53	1.39
B3LXPL5424	310	54	24	1	33.34	0.75
B3LXPL5430	358	54	30	1	41.64	0.94
B3LXPL5436	405	54	36	1	49.94	1.13
B3LXPL5442	452	54	42	1	58.24	1.31
B3LXPL5448	503	54	48	1	66.54	1.50

B3LXPR • Right Gallery Panel Extension, with Connectors for Additional Gallery Panels

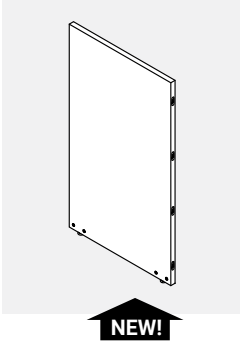

- Provides floor standing support while extending the Gallery Panels run.
- Attaches to the right edge of a Gallery Panel by the pin connectors to allow for additional Gallery Panels to be added on the right side.
- Pin connectors on the right edge and modular connectors on the left edge of the interior face.
- The right side is compatible with right hand Gallery Panels (B3LXPRxxxx and B3LXPRxxxxNC, B3L2PRxxxx and B3L3PRxxxx) only.
- The left side is compatible with Gallery Panels (B3LEPxxx, B3LSEPRxxx, B3LMPxxx and B3LXPRxxx) only.
- Includes all attachment hardware and glides.
- Total height is inclusive of panel glides extended to their full height.
- Please specify LP laminate finish and PVC edge finish.
- If a wood grain laminate is chosen, grain direction run horizontally.
- Edged in PVC on exposed top edge only and self edges on the three other.

PRODUCT CODE	PRICE LP	SIZE /INCHES			WEIGHT LBS	VOL FT ³
		H	W	D		
B3LXPR4224	252	42	24	1	25.83	0.58
B3LXPR4230	290	42	30	1	32.26	0.73
B3LXPR4236	328	42	36	1	38.68	0.88
B3LXPR4242	365	42	42	1	45.11	1.02
B3LXPR4248	403	42	48	1	51.53	1.17
B3LXPR5024	300	50	24	1	30.83	0.69
B3LXPR5030	347	50	30	1	38.51	0.87
B3LXPR5036	394	50	36	1	46.18	1.04
B3LXPR5042	440	50	42	1	53.86	1.22
B3LXPR5048	487	50	48	1	61.53	1.39
B3LXPR5424	310	54	24	1	33.34	0.75
B3LXPR5430	358	54	30	1	41.64	0.94
B3LXPR5436	405	54	36	1	49.94	1.13
B3LXPR5442	452	54	42	1	58.24	1.31
B3LXPR5448	503	54	48	1	66.54	1.50

B3LXPL-NC • Left Gallery Panel Extension, No Connectors for Additional Gallery Panels

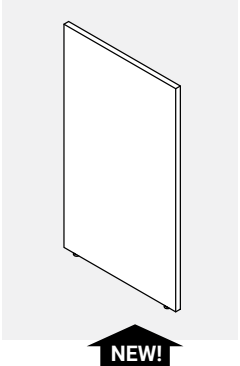

- Provides floor standing support while enclosing the end of a Gallery Panel left run.
- Attached to the left edge of a Gallery Panel by the pin connectors to finish the run.
- Pin connectors are on the right edge of the interior face.
- Compatible with gallery panels (B3LEPxxxx, B3LSEPLxxxx, B3LMPxxxx, B3LSMPxxxx and B3LXPLxxxx) only.
- Includes all attachment hardware and glides.
- Total height is inclusive of panel glides extended to their full height.
- Please specify LP laminate finish and PVC edge finish.
- If a wood grain laminate is chosen, grain direction run horizontally.
- Edged in PVC on two exposed edges, self edged on connecting to gallery panel edge and the bottom.

PRODUCT CODE	PRICE LP	SIZE /INCHES			WEIGHT LBS	VOL FT ³
		H	W	D		
B3LXPL4212NC	138	42	12	1	12.95	0.29
B3LXPL4224NC	245	42	24	1	25.8	0.58
B3LXPL4230NC	283	42	30	1	32.22	0.73
B3LXPL4236NC	320	42	36	1	38.65	0.88
B3LXPL4242NC	359	42	42	1	45.07	1.02
B3LXPL4248NC	396	42	48	1	51.5	1.17
B3LXPL5012NC	172	50	12	1	15.45	0.35
B3LXPL5024NC	294	50	24	1	30.8	0.69
B3LXPL5030NC	340	50	30	1	38.47	0.87
B3LXPL5036NC	386	50	36	1	46.15	1.04
B3LXPL5042NC	435	50	42	1	53.82	1.22
B3LXPL5048NC	481	50	48	1	61.5	1.39
B3LXPL5412NC	172	54	12	1	16.7	0.38
B3LXPL5424NC	303	54	24	1	33.3	0.75
B3LXPL5430NC	351	54	30	1	41.6	0.94
B3LXPL5436NC	398	54	36	1	49.9	1.13
B3LXPL5442NC	447	54	42	1	58.2	1.31
B3LXPL5448NC	494	54	48	1	66.5	1.50

B3LXPR-NC • Right Gallery Panel Extension, No Connectors for Additional Gallery Panels

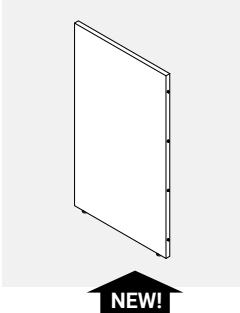

- Provides floor standing support while enclosing the end of a Gallery Panel right run.
- Attached to the right edge of a Gallery Panel by the pin connectors to finish the run.
- Pin connectors are on the left edge of the interior face.
- Compatible with gallery panels (B3LEPxxxx, B3LSEPRxxxx, B3LMPxxxx and B3LXPRxxxx) only.
- Includes all attachment hardware and glides.
- Total height is inclusive of panel glides extended to their full height.
- Please specify LP laminate finish and PVC edge finish.
- If a wood grain laminate is chosen, grain direction run horizontally.
- Edged in PVC on two exposed edges, self edged on connecting to gallery panel edge and the bottom.

PRODUCT CODE	PRICE LP	SIZE /INCHES			WEIGHT LBS	VOL FT ³
		H	W	D		
B3LXPR4212NC	138	42	12	1	12.95	0.29
B3LXPR4224NC	245	42	24	1	25.8	0.58
B3LXPR4230NC	283	42	30	1	32.22	0.73
B3LXPR4236NC	320	42	36	1	38.65	0.88
B3LXPR4242NC	359	42	42	1	45.07	1.02
B3LXPR4248NC	396	42	48	1	51.5	1.17
B3LXPR5012NC	172	50	12	1	15.45	0.35
B3LXPR5024NC	294	50	24	1	30.8	0.69
B3LXPR5030NC	340	50	30	1	38.47	0.87
B3LXPR5036NC	386	50	36	1	46.15	1.04
B3LXPR5042NC	435	50	42	1	53.82	1.22
B3LXPR5048NC	481	50	48	1	61.5	1.39
B3LXPR5412NC	172	54	12	1	16.7	0.38
B3LXPR5424NC	303	54	24	1	33.3	0.75
B3LXPR5430NC	351	54	30	1	41.6	0.94
B3LXPR5436NC	398	54	36	1	49.9	1.13
B3LXPR5442NC	447	54	42	1	58.2	1.31
B3LXPR5448NC	494	54	48	1	66.5	1.50

B3L2PR • Right Gallery Panel End of Run Return

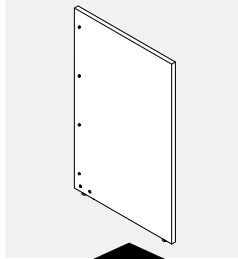

NEW!

- Provides floor standing support while enclosing the end of a Gallery Panel run.
- Attaches at the Gallery Panel right edge with connectors to form an L configuration.
- Connections to Gallery Panel are on the interior face near it's left end.
- Compatible with Gallery Panels (B3LEPxxxx, B3LSEPRxxxx, B3LMPxxxx and B3LXPRxxxx) only.
- Includes all attachment hardware and glides.
- Total height is inclusive of panel glides extended to their full height.
- 25" wide gallery panel accomodates a 24" deep surface while the 31" wide accomodates a 30" deep surface and 37" wide a 36" deep surface.
- Please specify LP laminate finish and PVC edge finish.
- If a wood grain laminate is chosen, grain direction run horizontally.
- Edged in PVC on three exposed edges and self edged on the bottom edge.

PRODUCT CODE	PRICE LP	SIZE /INCHES			WEIGHT LBS	VOL FT ³
		H	W	D		
B3L2PR4213	149	42	13	1	14.02	0.32
B3L2PR4225	283	42	25	1	26.87	0.61
B3L2PR4231	320	42	31	1	33.29	0.75
B3L2PR4237	347	42	37	1	39.72	0.90
B3L2PR5013	186	50	13	1	16.73	0.38
B3L2PR5025	340	50	25	1	32.08	0.72
B3L2PR5031	386	50	31	1	39.75	0.90
B3L2PR5037	428	50	37	1	47.43	1.07
B3L2PR5413	186	54	13	1	18.08	0.41
B3L2PR5425	351	54	25	1	34.68	0.78
B3L2PR5431	398	54	31	1	42.98	0.97
B3L2PR5437	441	54	37	1	51.28	1.16

B3L2PL • Left Gallery Panel End of Run Return

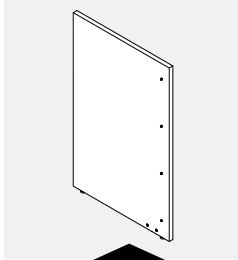

NEW!

- Provides floor standing support while enclosing the end of a gallery panel run.
- Attaches at the Gallery Panel left edge with connectors to form an L configuration.
- Connections to Gallery Panel are on the interior face near it's right end.
- Compatible with Gallery Panels (B3LEPxxxx, B3LSEPLxxxx, B3LMPxxxx, B3LSMPxxxx and B3LXPLxxxx) only.
- Includes all attachment hardware and glides.
- Total height is inclusive of panel glides extended to their full height.
- 25" wide gallery panel accomodates a 24" deep surface while the 31" wide accomodates a 30" deep surface and 37" wide a 36" deep surface.
- Please specify LP laminate finish and PVC edge finish.
- If a wood grain laminate is chosen, grain direction run horizontally.
- Edged in PVC on three exposed edges and self edged on the bottom edge.

PRODUCT CODE	PRICE LP	SIZE /INCHES			WEIGHT LBS	VOL FT ³
		H	W	D		
B3L2PL4213	149	42	13	1	14.02	0.32
B3L2PL4225	283	42	25	1	26.87	0.61
B3L2PL4231	320	42	31	1	33.29	0.75
B3L2PL4237	347	42	37	1	39.72	0.90
B3L2PL5013	186	50	13	1	16.73	0.38
B3L2PL5025	340	50	25	1	32.08	0.72
B3L2PL5031	386	50	31	1	39.75	0.90
B3L2PL5037	428	50	37	1	47.43	1.07
B3L2PL5413	186	54	13	1	18.08	0.41
B3L2PL5425	351	54	25	1	34.68	0.78
B3L2PL5431	398	54	31	1	42.98	0.97
B3L2PL5437	441	54	37	1	51.28	1.16

B3L3PL • Left Gallery Panel End of Run 3-Way Return

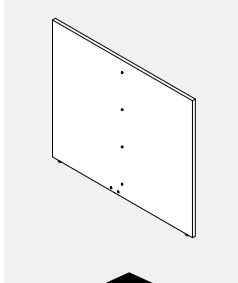

NEW!

- Provides floor standing support while enclosing the end of a Gallery Panel run.
- Attaches to the Gallery Panel left edge with connectors to form an T configuration.
- Connections to Gallery Panel are on the interior face in the middle.
- Compatible with Gallery Panels (B3LEPxxxx, B3LSEPLxxxx, B3LMPxxxx, B3LSMPxxxx and B3LXPLxxxx) only.
- Includes all attachment hardware and glides.
- Total height is inclusive of panel glides extended to their full height.
- 49" wide gallery panel accomodates two 24" deep surfaces while the 61" wide accomodates two 30" deep surface and 73" wide two 36" deep surface.
- Please specify LP laminate finish and PVC edge finish.
- If a wood grain laminate is chosen, grain direction run horizontally.
- Edged in PVC on three exposed edges and self edged on the bottom edge.

PRODUCT CODE	PRICE LP	SIZE /INCHES			WEIGHT LBS	VOL FT ³
		H	W	D		
B3L3PL4225	222	42	25	1	26.87	0.61
B3L3PL4249	384	42	49	1	52.57	1.19
B3L3PL4261	509	42	61	1	65.41	1.48
B3L3PL4273	591	42	73	1	78.26	1.77
B3L3PL5025	278	50	25	1	32.08	0.72
B3L3PL5049	527	50	49	1	62.77	1.42
B3L3PL5061	620	50	61	1	78.12	1.77
B3L3PL5073	727	50	73	1	93.47	2.11
B3L3PL5425	278	54	25	1	34.68	0.78
B3L3PL5449	543	54	49	1	67.88	1.53
B3L3PL5461	639	54	61	1	84.48	1.91
B3L3PL5473	750	54	73	1	101.08	2.28

B3L3PR • Right Gallery Panel End of Run 3-Way Return

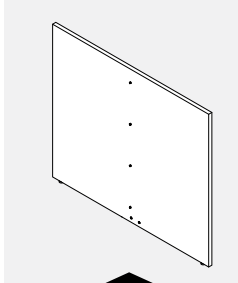

NEW!

- Provides floor standing support while enclosing the end of a Gallery Panel run.
- Attaches to the Gallery Panel right edge with connectors to form an T configuration.
- Connections to Gallery Panel are on the interior face in the middle.
- Compatible with gallery panels (B3LEPxxxx, B3LSEPRxxxx, B3LMPxxxx and B3LXPRxxxx) only.
- Includes all attachment hardware and glides.
- Total height is inclusive of panel glides extended to their full height.
- 49" wide gallery panel accomodates two 24" deep surfaces while the 61" wide accomodates two 30" deep surface and 73" wide two 36" deep surface.
- Please specify LP laminate finish and PVC edge finish.
- If a wood grain laminate is chosen, grain direction run horizontally.
- Edged in PVC on three exposed edges and self edged on the bottom edge.

PRODUCT CODE	PRICE LP	SIZE /INCHES			WEIGHT LBS	VOL FT ³
		H	W	D		
B3L3PR4225	222	42	25	1	26.87	0.61
B3L3PR4249	384	42	49	1	52.57	1.19
B3L3PR4261	509	42	61	1	65.41	1.48
B3L3PR4273	591	42	73	1	78.26	1.77
B3L3PR5025	278	50	25	1	32.08	0.72
B3L3PR5049	527	50	49	1	62.77	1.42
B3L3PR5061	620	50	61	1	78.12	1.77
B3L3PR5073	727	50	73	1	93.47	2.11
B3L3PR5425	278	54	25	1	34.68	0.78
B3L3PR5449	543	54	49	1	67.88	1.53
B3L3PR5461	639	54	61	1	84.48	1.91
B3L3PR5473	750	54	73	1	101.08	2.28

B3HLPBB01 • Gallery Panel Bottom Inline Bracket

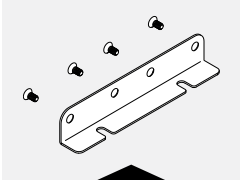

NEW!

- Gallery Panel Bottom Inline Bracket connects two Gallery Panels at the bottom with screws.
- Available in standard paint colors.

PRODUCT CODE	PRICE	SIZE /INCHES			WEIGHT		VOL FT ³
		H	W	D	LBS		
B3HLPBB01	34	7	1.5	8	1	0.5	

B3HLPCB01 • Gallery Panel Corner Bracket

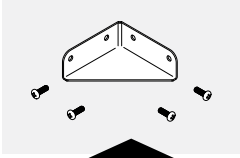

NEW!

- Gallery Panel Corner Bottom bracket connects two Gallery Panels at 90 degrees.
- Available in standard paint colors.

PRODUCT CODE	PRICE	SIZE /INCHES			WEIGHT		VOL FT ³
		H	W	D	LBS		
B3HLPCB01	33	7	1.5	4	4	0.5	

B3PMP-GI-W • Privacy Glass for 1" Laminate Panels

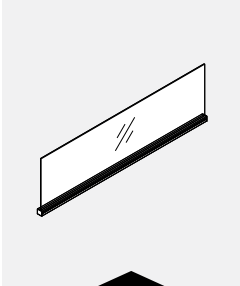

NEW!

- Privacy glass integrated with aluminum top trim.
- Attaches on top of gallery panels to add privacy or divide space.
- Includes aluminum trim with channel, end caps and glass tile.
- Top rail may also be used to hang accessories.
- Glass and attachment hardware ship separately.
- Please specify standard paint finish for the channel.
- Standard in clear (CLR) or frosted (FRST).

PRODUCT CODE	PRICE	FRST	SIZE /INCHES			WEIGHT		VOL FT ³
			H	W	D	LBS		
B3PMP24GI8W	195	244	8	24	1	4.84	0.11	
B3PMP30GI8W	213	268	8	30	1	6.06	0.14	
B3PMP38GI8W	228	283	8	36	1	7.28	0.17	
B3PMP42GI8W	244	304	8	42	1	8.5	0.19	
B3PMP48GI8W	254	317	8	48	1	9.72	0.22	
B3PMP24GI16W	195	244	16	24	1	8.92	0.22	
B3PMP30GI16W	213	268	16	30	1	11.17	0.28	
B3PMP36GI16W	228	283	16	36	1	13.43	0.33	
B3PMP42GI16W	244	304	16	42	1	15.68	0.39	
B3PMP48GI16W	254	317	16	48	1	17.92	0.44	

B3PFD-W • Felt divider for 1" Laminate Panels

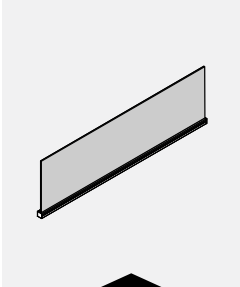

NEW!

- Privacy felt integrated with aluminum top trim.
- Attaches on top of gallery panels to add privacy or divide space.
- Includes aluminum trim with channel, end caps and felt tile.
- Top rail may also be used to hang accessories.
- Felt and attachment hardware ship separately.
- Please specify standard paint finish for the channel.
- Please specify standard felt finish.

PRODUCT CODE	PRICE	SIZE /INCHES			WEIGHT		VOL FT ³
		H	W	D	LBS		
B3PFD0824W	70		8	24	1	1.32	0.11
B3PFD0830W	85		8	30	1	1.65	0.14
B3PFD0836W	99		8	36	1	1.99	0.17
B3PFD0842W	111		8	42	1	2.32	0.19
B3PFD0848W	165		8	48	1	2.65	0.22
B3PFD0854W	178		8	54	1	2.98	0.25
B3PFD0860W	193		8	60	1	3.32	0.28
B3PFD0866W	204		8	66	1	3.65	0.31
B3PFD0872W	231		8	72	1	3.98	0.33
B3PFD1624W	81		16	24	1	1.83	0.22
B3PFD1630W	95		16	30	1	2.3	0.28
B3PFD1636W	113		16	36	1	2.76	0.33
B3PFD1642W	126		16	42	1	3.22	0.39
B3PFD1648W	187		16	48	1	3.68	0.44
B3PFD1654W	204		16	54	1	4.14	0.50
B3PFD1660W	219		16	60	1	4.61	0.56
B3PFD1666W	231		16	66	1	5.07	0.61
B3PFD1672W	263		16	72	1	5.53	0.67

BE8CI-1 • "I" Connector



NEW!

- Connects two Pass Thru Cables.
- Inline coupler used to connect two BE8CPxxHH Pass-Thru Cables.

PRODUCT CODE	PRICE	SIZE/ INCHES			WEIGHT VOL	
		H	W	D	LBS	FT ³
BE8CI1	77	1.5	1.5	4.625	0.06	0.03

BE8D • Duplex Receptacles

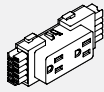

NEW!

- Snaps into Power Distribution Housing.
- Up to 6 duplex receptacles per circuit.
- BE8D1 = Circuit #1 (utility circuit)
- BE8D2 = Circuit #2 (utility circuit)
- BE8D3 = Circuit #3 (utility circuit)
- BE8DA - Circuit #A (dedicated circuit)

PRODUCT CODE	PRICE	SIZE/ INCHES			WEIGHT VOL	
		H	W	D	LBS	FT ³
BE8D1	32	2	4.625	1.25	0.10	0.01
BE8D2	32	2	4.625	1.25	0.10	0.01
BE8D3	32	2	4.625	1.25	0.10	0.01
BE8DA	32	2	4.625	1.25	0.10	0.01

BE8D • USB Receptacles

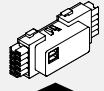

NEW!

- Snaps into Power Distribution Housing.
- USB charging module provides convenient charging power access through dual ports on face of receptacles.
- Two USB ports.
- 2 amp output, considered as circuit #1.

PRODUCT CODE	PRICE	SIZE/ INCHES			WEIGHT VOL	
		H	W	D	LBS	FT ³
BE8DU1-B	216	2	4.625	1.25	0.10	0.01
BE8DU1-W	216	2	4.625	1.25	0.10	0.01

BE83D • Power Distribution Housing Kit - Beam Raceway

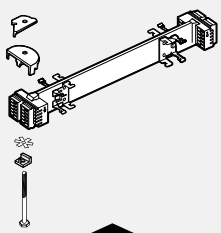

NEW!

- Provides two duplex receptacles per panel side for all panel widths above 24" wide.
- Power Distribution Housing is specified per panel size. eg. BE83D36 is for use with a 36" panel.
- 24" wide panel allows for only one (1) duplex receptacle per panel side.

PRODUCT CODE	PRICE	SIZE/ INCHES			WEIGHT VOL	
		H	L	D	LBS	FT ³
BE83D24	180	2	9.25	2.61	0.83	1.17
BE83D30	189	2	15.25	2.61	1.28	1.17
BE83D36	200	2	21.25	2.61	1.62	1.65
BE83D42	205	2	27.25	2.61	2.00	2.00
BE83D48	216	2	33.25	2.61	2.32	2.54
BE83D54	220	2	39.25	2.61	2.66	3.20
BE83D60	221	2	45.25	2.61	3.04	3.20
BE83D66	282	2	51.25	2.61	3.49	3.25
BE83D72	310	2	57.25	2.61	3.76	3.30

BE8JC • Jumper Cable

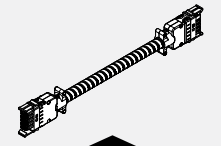

NEW!

- Electrically connects two Power Distribution Housings.
- The BE8JC16 electrically connects two powered panels positioned side by side.
- The BE8JC20 electrically connects two powered panels separated by a post.
- Wires are concealed in a flexible metal conduit.
- Cannot go through a Boulevard 1 post in a corner application. (Please use the Jumper Cable Mesh)

PRODUCT CODE	PRICE	SIZE/ INCHES			WEIGHT VOL	
		H	L	D	LBS	FT ³
BE8JC16	145	2	16.75	0.5	0.66	1.17
BE8JC20	147	2	20.75	0.5	0.78	1.17

BE8JM19 • Jumper Cable Mesh

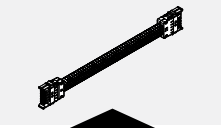

NEW!

- Electrically connects two Power Distribution Housings in Boulevard 1 panels that are separated by a post in a corner application.
- BE8JM19 - Wires are covered with a durable nylon mesh.
- BE8JMS19 - Wires are concealed in a flexible metal shroud and covered with a durable nylon mesh.
- Used in System 3 Panels at tile position passing through post at corner application.

PRODUCT CODE	PRICE	SIZE/ INCHES			WEIGHT VOL	
		H	L	D	LBS	FT ³
BE8JM19	147	2	19	0.5	0.75	1.17
BE8JMS19	167	2	19	0.5	0.75	1.17

BE8CP-HH • Housing-to-Housing Pass-Thru Cable

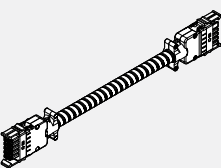

NEW!

- Electrically connects two Power Distribution Housings in panels separated by one or more non-powered panels.
- Wires are concealed in a flexible metal conduit.
- **NOTE** : In Boulevard 1 and or System 3 tile position applications, the Housing-to-Housing Pass-Thru Cables can only be used in a straight run.

PRODUCT CODE	PRICE	SIZE/ INCHES			WEIGHT VOL	
		H	L	D	LBS	FT ³
BE8CP40HH	146	2	40.5	0.5	1.44	1.17
BE8CP46HH	152	2	46.5	0.5	1.71	1.17
BE8CP52HH	161	2	52.5	0.5	1.95	1.17
BE8CP58HH	167	2	58.5	0.5	2.21	1.17
BE8CP64HH	173	2	64.5	0.5	2.37	1.17
BE8CP70HH	178	2	70.5	0.5	2.6	1.17
BE8CP76HH	185	2	76.5	0.5	2.81	1.17
BE8CP82HH	194	2	82.5	0.5	3.03	1.17
BE8CP88HH	201	2	88.5	0.5	3.05	1.17
BE8CP94HH	205	2	94.5	0.5	3.30	1.17
BE8CP100HH	212	2	100.5	0.5	3.47	1.17
BE8CP106HH	220	2	106.5	0.5	3.87	1.17
BE8CP118HH	233	2	118.5	0.5	4.08	1.17
BE8CP130HH	244	2	130.5	0.5	4.73	1.17
BE8CP142HH	256	2	142.5	0.5	4.99	1.17

BE8CP-HJ • Housing-to-Jumper Pass-Thru Cable

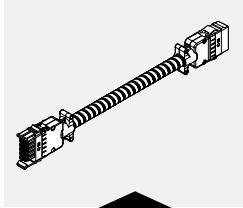

NEW!

- Electrically connects a Power Distribution Housing to a Housing connection of a harness.
- Wires are concealed in a flexible metal conduit.
- **NOTE** : In both Boulevard 1 and System 3 Tile Position applications, the Housing-to-Jumper Pass-Thru Cables can only be used in a straight run.

PRODUCT CODE	PRICE	SIZE/ INCHES			WEIGHT VOL	
		H	L	D	LBS	FT ³
BE8CP24HJ	113	2	24	0.5	0.9	1.17
BE8CP30HJ	119	2	30	0.5	1.3	1.17
BE8CP36HJ	124	2	36	0.5	1.44	1.17
BE8CP42HJ	154	2	42	0.5	1.71	1.17
BE8CP48HJ	161	2	48	0.5	1.95	1.17
BE8CP54HJ	171	2	54	0.5	2.21	1.17
BE8CP60HJ	178	2	60	0.5	2.37	1.17
BE8CP72HJ	185	2	72	0.5	2.81	1.17
BE8CP84HJ	200	2	84	0.5	3.05	1.17
BE8CP96HJ	212	2	96	0.5	3.3	1.17
BE8CP108HJ	221	2	108	0.5	3.87	1.17
BE8CP120HJ	234	2	120	0.5	4.08	1.17
BE8CP144HJ	266	2	144	0.5	4.59	1.17

BRBPEFH • Base Feed and Housing for powerBeam

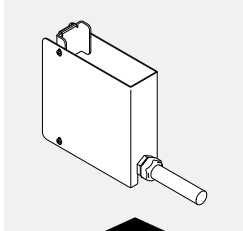

NEW!

- Floorfeed housing and harness for Bridges Power Beam applications. Specify xx18 baseFEED for 18" high power-BEAMS. xx26 baseFEED for 26" Bridges Power Beam, etc.
- Attaches to inner side of the powerBEAM leg
- Base feed kit consist of two mounting brackets, steel shroud and base feed harness with 72" long liquid-tight conduit hardwired to building power supply.
- **NOTE**: on-site drilling required to secure mounting brackets to the inside of the beam vertical leg
- Post Vertical Trim must be specified in accordance to your post 2-way, 3-way or 4-way configuration.
- Specify metal finish colour

PRODUCT CODE	PRICE	SIZE/ INCHES			WEIGHT VOL	
		H	L	D	LBS	FT ³
BRBPEFH18	524	6.9	6	2.5	2.70	0.06
BRBPEFH26	559	16.9	6	2.5	5.41	0.15
BRBPEFH34	585	22.9	6	2.5	7.03	0.20

BE8CF-1 • Ceiling Feed - Single

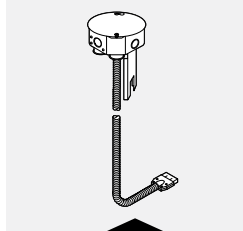

NEW!

- Provides single power entry from ceiling, through post and into raceway channel.
- Power entry cable penetrates 8" into a panel and plugs into either a Power Distribution Housing or BE8CPxxHJ Pass-Thru Harness.
- Specify Post Extension separately.
- Must be hard wired to power source by a licensed electrician.

PRODUCT CODE	PRICE	SIZE/ INCHES			WEIGHT VOL	
		H	L	D	LBS	FT ³
BE8CF1201	321	6	120	6	5.24	2
BE8CF1441	435	6	144	6	5.96	2

BE8CF-2 • Ceiling Feed - Double

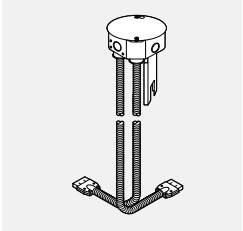

NEW!

- Provides dual power entry from ceiling, through post and into raceway channel.
- Power entry cable penetrates 8" into a panel and plugs into either a Power Distribution Housing or a BE8CPxxHJ Pass-Thru Harness.
- Use 1) In middle of run to distribute power in two directions.
2) At beginning of run where second Ceiling Feed harness is connected to BE8CPxxHJ and distributes power underneath Power Distribution Housing to pick-up second circuit grouping in long panel run.
- Specify Post Extension separately.
- Must be hard wired to power source by a licensed electrician.

PRODUCT CODE	PRICE	SIZE/ INCHES			WEIGHT VOL	
		H	L	D	LBS	FT ³
BE8CF1202	564	6	120	3	5.24	2
BE8CF1442	637	6	144	3	5.96	2

BRTWMS • Wire Manager Kit

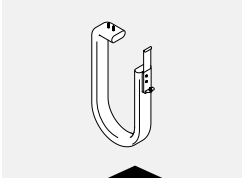

NEW!

- Provides wire management from under the Freefit worksurface to the Power Beam.
- The bracket can be aligned anywhere on the Power Beam.
- Kit includes a neoprene wire manager sock, bracket and screws.
- Please specify bracket paint finish.

PRODUCT CODE	PRICE	SIZE/ INCHES			WEIGHT VOL	
		H	L	D	LBS	FT ³
BRTWMS	102	1.25	42	5.25	1.87	0.4

Applications

Combining **Bridges tables with BRPX3P table mounted dividers** increases power, data capacity, offers optional, integrated desk-height power/data access and enhances sense of privacy with fabric covered panel tiles. Optional Accessory tiles support paper-organizing accessories.

Non-powered BRPX3P dividers combined with BRTETB power troughs. The troughs in this instance provide power/data distribution and access, while the BRPX3P dividers enhance sense of privacy and, with accessory tiles in place, provide support for bridges paper accessories.

Notice that the dividers combined with power troughs do not distribute any power.

Specify quantity and finish of BRA3VTRF22 vertical aluminum flat end trim at either end.

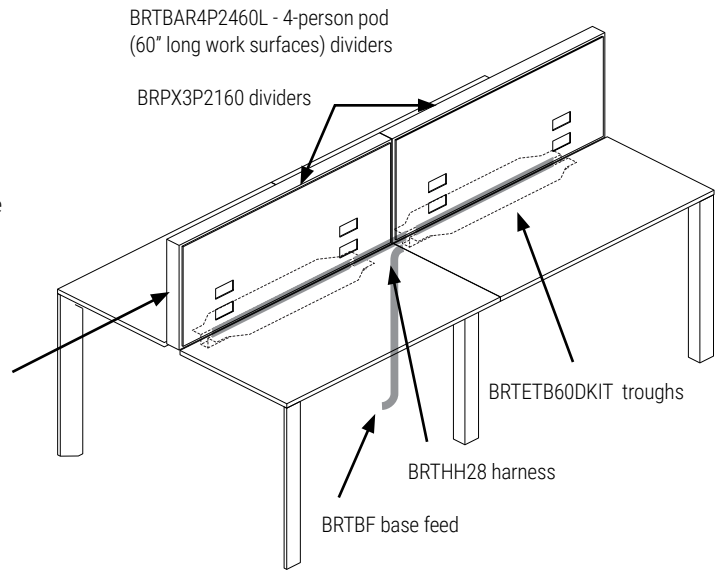

BRPX3P dividers with built-in 8-wire, 4-circuit power distribution system and data.

The BRPX3P dividers provide power/data distribution, desk-height access, while enhancing sense of privacy. When specified, accessory tiles can provide support for Bridges paper accessories.

Note: **Powered BRPX3P dividers cannot be combined with BRTETB power troughs on freestanding Bridges tables.** They both require separate, dedicated base feed, and BRPX3P Divider's base feed would physically interfere with the BRTETB below work surface trough.

BRPX3P dividers and BRTETB below work surface troughs can only be combined if the **power to the BRPX3P dividers is fed horizontally from adjacent Boulevard System 3 panels** (thus preventing base feed's interfering with the troughs). BRTETB below work surface troughs remain powered by BRTDIVPBF base feed.

Under certain conditions **powered BRPX3P dividers can be combined with BRTETB power troughs.** Thus, in addition to enhanced privacy and support for accessories, the BRPX3P/BRTETB electrified combo provides double layered power distribution system (each with 8 wires and 4 circuits) for customers with high power demands. Note that each layer needs its own power supply source base feed power supply.

Note: BRPX3P dividers and BRTETB below work surface troughs can only be combined if the **power to the BRPX3P dividers is fed horizontally from adjacent Boulevard System 3 panels.**

BRPX3P Divider's base feed will physically interfere with the BRTETB below work surface trough. BRTETB below work surface troughs remain powered by BRTDIVPBF base feed. Bridges BRTBF base feed and BRTDIVPBF divider base feed are dedicated, non-interchangeable components.

Specify quantity and finish of BRA3VTRF22 vertical aluminum flat end trim at either

BRTBAR4P2460L - 4-person pod (60" long work surfaces) dividers

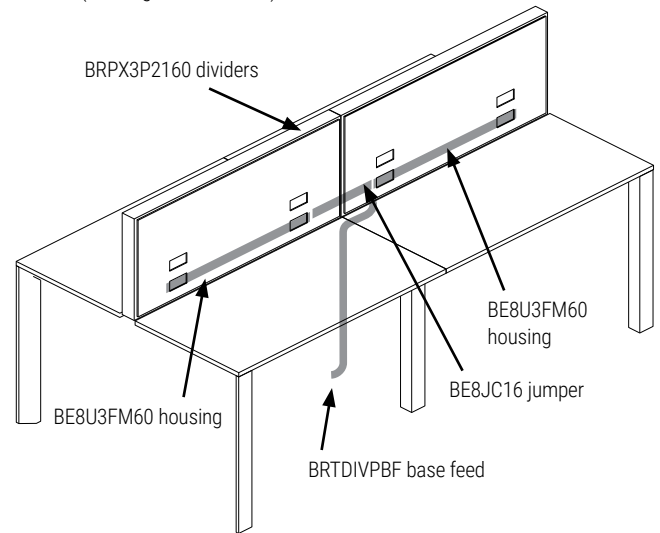

BRTBAR4P2460L - 4-person pod 60" long work surfaces dividers power troughs

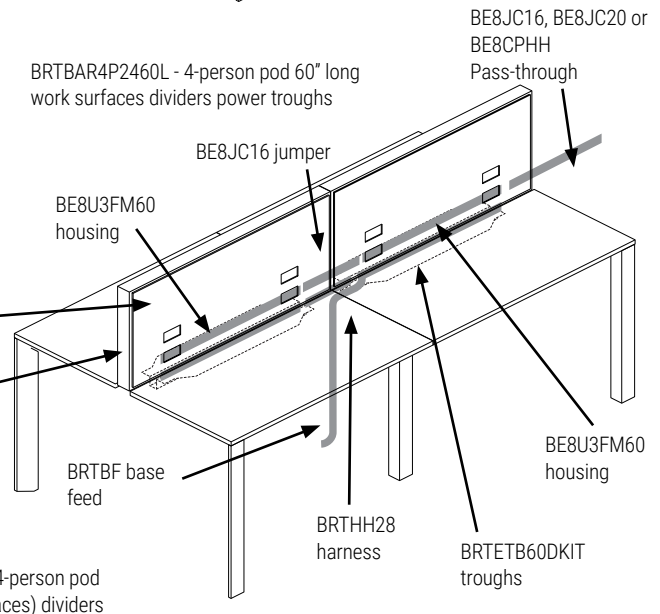

Applications

Bridges table mounted BRPX3P dividers offers can be combined with Boulevard System 3 panels. Table mounted BRPX3P dividers will match in height 50" high Boulevard System 3 floor standing panel.

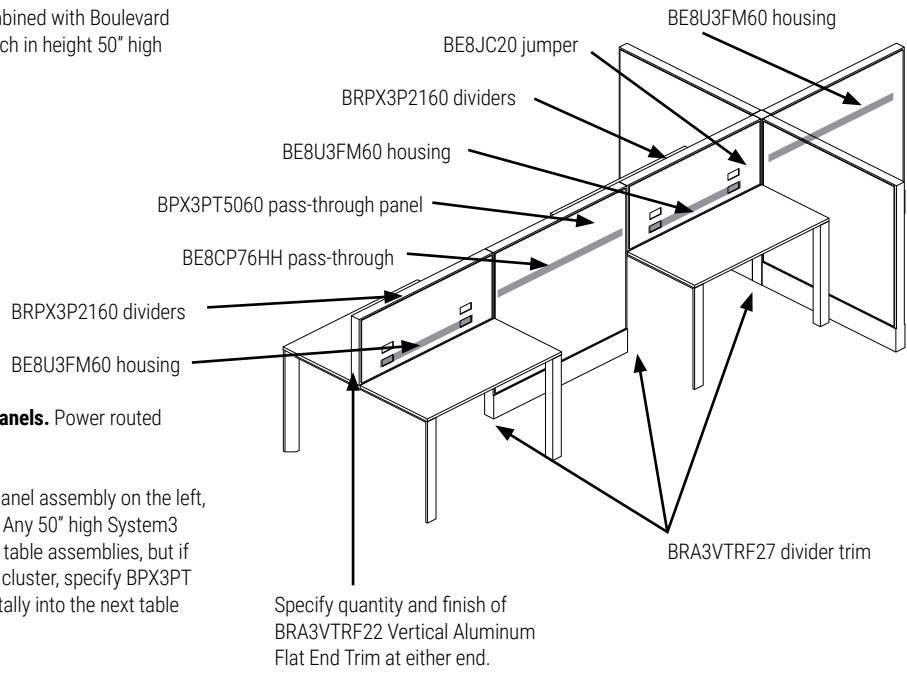

BRPX3P dividers combined with BOULEVARD System3 panels. Power routed through System 3 panels.

This example illustrates power routed from the System 3 panel assembly on the left, through the post and into table mounted BRPX3P dividers. Any 50" high System3 panel can be connected between two independent bridges table assemblies, but if you intend to route power/ data into the next bridges table cluster, specify BPX3PT Pass-through panel so that the cables could cross horizontally into the next table mounted BRPX3P divider on the right.

Specify quantity and finish of BRA3VTRF27 Bridges Divider trims which cover System 3 panel vertical face below Bridges table mounted BRPX3P dividers.

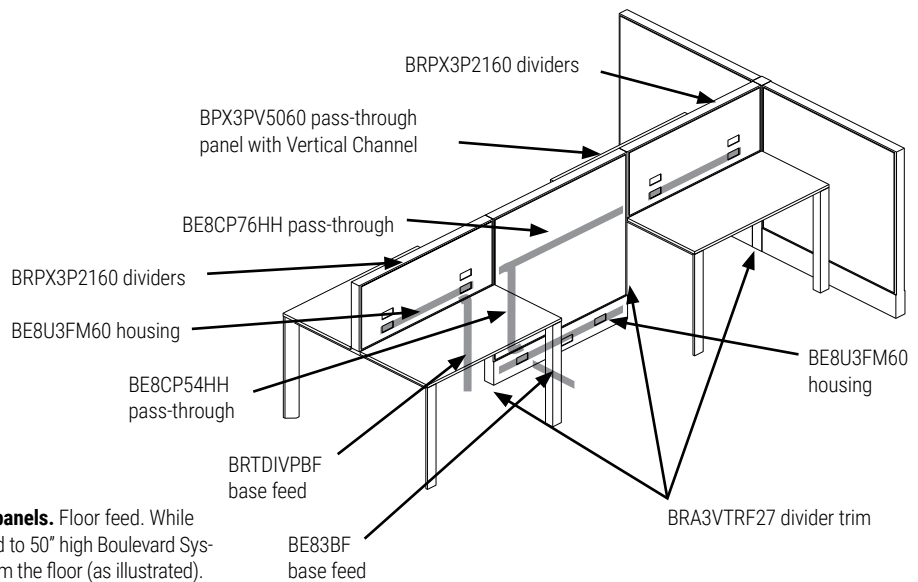

BRPX3P dividers combined with BOULEVARD System 3 panels. Floor feed. While table mounted BRPX3P dividers can be physically connected to 50" high Boulevard System 3 floor standing panels, power/data could be routed from the floor (as illustrated). There are two ways of facilitating floor feed. 1: Power could enter through the bottom of table mounted BRPX3P divider, into BE8U3FM60 housing and then continues through BPX3PT5060 or BPX3PV5060 pass-through panel into adjacent BRPX3P divider. 2: BE83BF base feed supplies BE8U3FM60 housing within BPX3PV5060 pass-through panel (with integrated vertical channel). BE8CP54HH Pass-through harness then feeds BE8U3FM60 housing within the table mounted BRPX3P divider on the right. BE8CP76HH Pass-through harness then continues through BPX3PV5060 pass-through panel into adjacent BRPX3P divider.

Note: These two examples are for illustration purposes only as **two power feeds must not be connected to one power distribution system!**

Applications

BRPX3MA25 and BRPXGMA25 Boulevard System 3 dividers facilitate seamless transition from panel-based office to open environment.

BRPX3MA25 and BRPXGMA25 panels combined with BOULEVARD System 3.
Power routed through System 3 panels.

The first 50" high panel is furnished with face mount power through its integrated vertical channel.

Any equipment placed on top of the 25" storage cabinets can be plugged into the floor raceway (cables rising through the gap between the panels and the cabinet).

Specify quantity and finish of BRA3VTSF25 bridges-BLVD step down end trims.

BRPXGMA25 panel

BRPXGMA25 panel

The pair of work surface-mounted BRED50 Duo Modules on the right (plugged into the floor raceway) provide easy access to power at desk height.

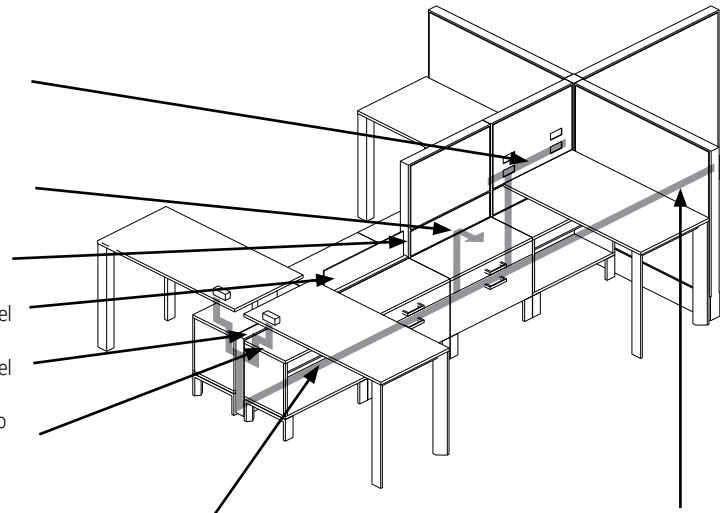

Specify quantity and finish of BRA3VTRF25 vertical aluminum flat end trim at the end.

This example illustrates power routed at the floor level from the System 3 panel assembly on the left into BRPX3MA25 and BRPXGMA25 panels.

Combination of **25" high Bridges storage cabinets with BRPX3S storage mounted dividers** forms storage-based linear spine capable of delivering 8-wire, 4-circuit power distribution along the spine.

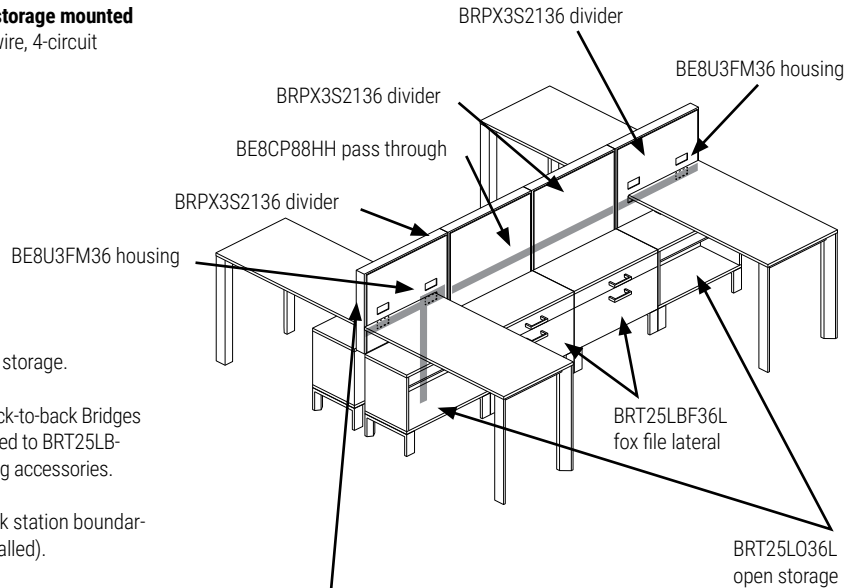

BRPX3S storage mounted dividers combined with Bridges 25" high storage.

BRPX3S dividers are secured to a storage-based spine formed by back-to-back Bridges storage cabinets of corresponding width (BRPX3S2136 divider secured to BRT25LBF36L, for instance). Optional Accessory tiles support paper-organizing accessories.

Storage mounted dividers reach 46" above the floor to suggest work station boundaries as well as to support paper organizers (with accessory tile installed).

Power enters the spine from the bottom, in-between the back-to-back storage cabinets and is then routed horizontally between the dividers.

Note: This assembly was conceived as a stand-alone application - **not compatible with floor standing Boulevard System 3 panels.**

Specify quantity and finish of BRA3VTRF22 Vertical Aluminum Flat End Trim at either end.

Applications

Note: BRPX3S storage mounted dividers combined with Bridges 25" high storage was conceived as a standalone application. **It is not compatible with floor standing Boulevard System 3 panels.**

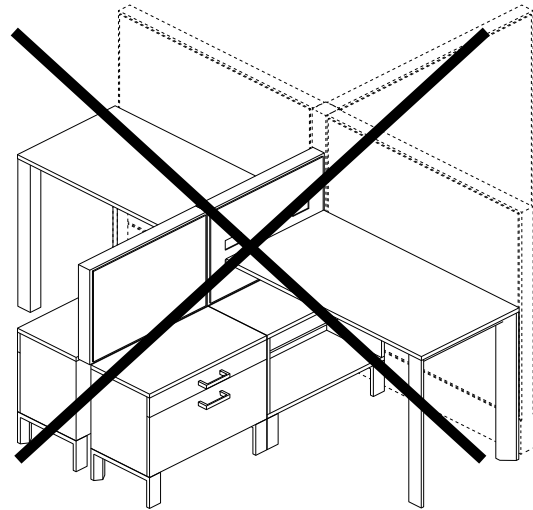

BRPX3MA25 • 25" High System 3 Panel

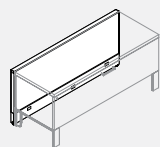

PRODUCT CODE	PRICE			SIZE/INCHES			WEIGHT VOL		
	GR1	GR2	OPT	H	W	D	LBS	FT ³	
BRPX3MA2530	439	461	481	25	30	2.5	5.00	1.09	
BRPX3MA2536	477	521	547	25	36	2.5	6.00	1.30	
BRPX3MA2542	521	561	589	25	42	2.5	7.00	1.52	

- 25" high System3 panel facilitates seamless transition from a panel-based, enclosed office to an open one. It can be connected to a cluster of panels on one side and continue with power / data spine distribution into collaborative areas.
- 25" high System3 panel also enables creation of a storage-based spine with full 8-wire, 4-circuit power and data capacity.

BRPX3GMA25 • 25" High System 3 Panel

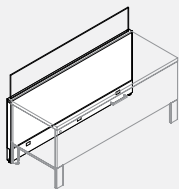

PRODUCT CODE	PRICE			SIZE/INCHES			WEIGHT VOL		
	GR1	GR2	OPT	H	W	D	LBS	FT ³	
BRPX3GMA2530	860	882	926	25	30	2.5	5.00	1.09	
BRPX3GMA2536	904	945	993	25	36	2.5	6.00	1.30	
BRPX3GMA2542	958	999	1051	25	42	2.5	7.00	1.52	

- 25" high System3 panel facilitates seamless transition from a panel-based, enclosed office to an open one. It can be connected to a cluster of panels on one side and continue with power / data spine distribution into collaborative areas.
- 25" high System3 panel also enables creation of a storage-based spine with full 8-wire, 4-circuit power and data capacity.
- B3 panel Top trim option provided with embedded, frame-less glass pane rising 8" above the top of the panel. For instance, when installed on 42" high B3 panel, overall height will be 50" high.
- There is 1.25" gap between two adjacent glass panes.
- Glass shipped separately, Allen key to set the glass pane plumb is provided with each panel.
- 5mm tempered glass, acid etched on one side or clear.
- Square corners on glass.
- Integrated adjustable brackets and extruded aluminum trim.
- Cannot be retrofit on-site.

BRPX3P21 • Table Mounted Open Frame Divider

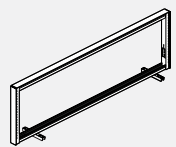

PRODUCT CODE	PRICE	SIZE/INCHES			WEIGHT VOL		
		H	W	D	LBS	FT ³	
BRPX3P2130	166	22	30	2.5	5.40	0.95	
BRPX3P2136	173	22	36	2.5	6.50	1.15	
BRPX3P2142	178	22	42	2.5	7.50	1.34	
BRPX3P2148	188	22	48	2.5	8.60	1.53	
BRPX3P2154	195	22	54	2.5	9.70	1.72	
BRPX3P2160	202	22	60	2.5	10.80	1.91	
BRPX3P2166	207	22	66	2.5	11.90	2.10	
BRPX3P2172	215	22	72	2.5	13.00	2.29	

- Aluminum panel frame designed to be secured between two back-2-back bridges work surfaces. When installed, the height of the panel matches the height of 50" high System3 panel. Note: individual panels can be interconnected with 'Capture strips'. The bridges panel is physically compatible with System 3 and can be interconnected using System 3 'Capture strips'.
- Intended to distribute 8-wire / 4-circuit power and data along table-based spine, enhance seated privacy, acoustics and support paper / task accessories. Not suitable for panel mounted Monitor arms. Divider is not slotted.
- Table mounting brackets and capture strips included (individual in-line panels can be interconnected with Capture strips). Specify power distribution harness, duplexes and tiles. End trims not included.
- Tile options: full fabric, full fabric with power/data openings, partial accessory/fabric tile and partial accessory / fabric with power/data openings.
- NOTE: The panel mounts only parallel, between back-2-back work surface. Perpendicular mounting brackets are not available.
- NOTE: Table Mounted Dividers with tiles should not be used with worksurfaces with access doors, BRTWSA & BRTWSAA.

Application

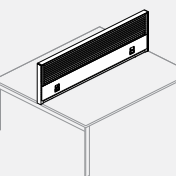

BRPX3S • Storage Mounted B3 Divider

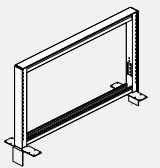

PRODUCT CODE	PRICE	SIZE/INCHES			WEIGHT VOL		
		H	W	D	LBS	FT ³	
BRPX3S2130	166	22	30	2.5	5.40	0.95	
BRPX3S2136	173	22	36	2.5	6.50	1.15	
BRPX3S2142	178	22	42	2.5	7.50	1.34	

- Aluminum panel frame designed to be secured between two back-2-back bridges 21" or 25" high lateral storage units. When installed, top of the panel reaches 42" or 46". Note: individual panels can be interconnected with 'Capture strips'. The bridges panel is physically compatible with System 3 and can be interconnected using System 3 'Capture strips'.
- Intended to distribute 8-wire / 4-circuit power and data along storage-based spine, enhance seated privacy, acoustics and support Paper / task accessories. Not suitable for panel mounted monitor arms. Divider is not slotted.
- Storage mounting brackets and capture strips included (individual in-line panels can be interconnected with capture strips)
- Specify power distribution harness, duplexes and tiles. End trims not included.
- Tile options: full fabric, full fabric with power/data openings, partial accessory/fabric tile and partial accessory fabric with power/data openings.
- NOTE: The panel mounts only parallel, between Back-2-back storage units. Perpendicular mounting brackets are not available.
- Horizontal cable management will not work between storage to table dividers or to panels.
- Cable management must be between dividers on storage only.

Application

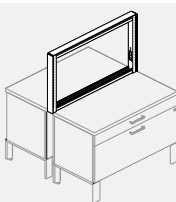

BRPX3FT21 • B3 Bridges Divider Tile

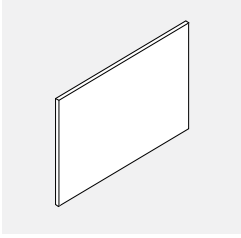

- Full fabric tile. Aluminum frame, fabric stretched around frame's perimeter.

PRODUCT CODE	PRICE			SIZE/INCHES			WEIGHT VOL	
	GR1	GR2	OPT	H	W	D	LBS	FT ³
BRPX3FT2130	80	87	92	22	30	1	2.70	0.38
BRPX3FT2136	87	92	101	22	36	1	3.25	0.46
BRPX3FT2142	99	106	113	22	42	1	3.80	0.53
BRPX3FT2148	109	118	128	22	48	1	4.32	0.61
BRPX3FT2154	120	129	140	22	54	1	4.86	0.69
BRPX3FT2160	130	141	152	22	60	1	5.40	0.76
BRPX3FT2166	142	152	166	22	66	1	5.94	0.84
BRPX3FT2172	152	166	177	22	72	1	6.48	0.92

BRPX3NET21 • B3 Bridges Fabric Electrical Tile

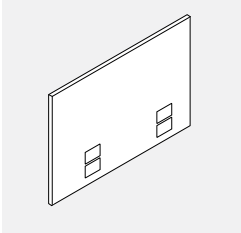

- Full fabric tile with openings for power and data. Aluminum frame, fabric stretched around frame's perimeter.
- Includes one data opening blank cover. Specify power distribution module, duplexes.
- Jumpers and power feed harnesses separately.

PRODUCT CODE	PRICE			SIZE/INCHES			WEIGHT VOL	
	GR1	GR2	OPT	H	W	D	LBS	FT ³
BRPX3NET2130	151	164	175	22	30	1	2.70	0.38
BRPX3NET2136	154	167	178	22	36	1	3.25	0.46
BRPX3NET2142	157	171	186	22	42	1	3.80	0.53
BRPX3NET2148	164	174	189	22	48	1	4.32	0.61
BRPX3NET2154	166	177	194	22	54	1	4.86	0.69
BRPX3NET2160	169	184	198	22	60	1	5.40	0.76
BRPX3NET2166	173	188	202	22	66	1	5.94	0.84
BRPX3NET2172	176	193	206	22	72	1	6.48	0.92

BRPX3ATF21 • B3 Bridges Accessory Fabric Tile

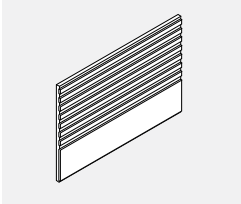

- Partial accessory/fabric tile. The kit consists of a 12" high accessory tile with horizontal slats and an 8" high fabric tile (fabric stretched over aluminum frame).

PRODUCT CODE	PRICE			SIZE/INCHES			WEIGHT VOL	
	GR1	GR2	OPT	H	W	D	LBS	FT ³
BRPX3ATF2130	252	271	294	22	30	1	6.84	0.38
BRPX3ATF2136	260	283	304	22	36	1	8.20	0.46
BRPX3ATF2142	272	294	317	22	42	1	9.57	0.53
BRPX3ATF2148	283	304	330	22	48	1	10.94	0.61
BRPX3ATF2154	294	317	341	22	54	1	12.31	0.69
BRPX3ATF2160	303	329	355	22	60	1	13.68	0.76
BRPX3ATF2166	314	339	366	22	66	1	15.04	0.84
BRPX3ATF2172	323	352	378	22	72	1	16.40	0.92

BRPX3ATE21 • B3 Bridges Accessory Electrical Tile

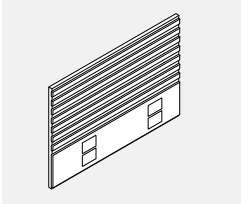

- Partial accessory/fabric power and data tile. The kit consists of a 12" high accessory tile with horizontal slats and an 8" high fabric tile (fabric stretched over aluminum frame).
- Power/data openings in the partial fabric tile section, cover includes one data opening blank cover.
- Specify power distribution module, Duplexes, Jumpers and Power feed harnesses separately.

PRODUCT CODE	PRICE			SIZE/INCHES			WEIGHT VOL	
	GR1	GR2	OPT	H	W	D	LBS	FT ³
BRPX3ATE2130	276	298	323	22	30	1	7.00	0.38
BRPX3ATE2136	289	311	337	22	36	1	8.40	0.46
BRPX3ATE2142	300	323	352	22	42	1	9.80	0.53
BRPX3ATE2148	311	337	362	22	48	1	11.10	0.61
BRPX3ATE2154	323	350	377	22	54	1	12.50	0.69
BRPX3ATE2160	333	361	389	22	60	1	13.90	0.76
BRPX3ATE2166	344	373	405	22	66	1	15.20	0.84
BRPX3ATE2172	358	386	418	22	72	1	16.60	0.92

BRA3VTRF22 • B3 Bridges Divider Trim

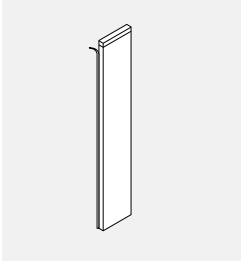

- For use with Bridges/System3 Panel/Storage Dividers.
- Table mounted BRPX3P End Trim.
- 25" Boulevard Panel Vertical trim.
- System3 step down panel trim - covers panel's vertical from the bottom of table mounted BRPX3P to the bottom of the adjacent System3 panel.
- System3 step down panel trim - covers panel's vertical from top of BRPXGMA25 panel to top of adjacent BPX3-34" high System3 panel.
- System3 step down panel trim - covers panel's vertical from top of BRPXGMA25 panel on top of adjacent BPX3-42" high System3 panel.
- System3 step down panel trim - covers panel's vertical from top of BRPXGMA25 panel to top of adjacent BPX3-50" high System3 panel.

PRODUCT CODE	PRICE	SIZE/INCHES			WEIGHT VOL	
		H	W	D	LBS	FT ³
BRA3VTRF22	28	22	2.61	0.125	0.045	
BRA3VTRF25	33	25	2.61	0.125	0.045	
BRA3VTRF27	40	27	2.61	0.125	0.05	
BRA3VTRF34	45	34	2.61	0.125	0.06	
BRA3VTRF38	52	38	2.61	0.125	0.07	
BRA3VTSF09	20	9	2.61	0.125	0.02	
BRA3VTSF17	23	17	2.61	0.125	0.03	
BRA3VTSF25	33	25	2.61	0.125	0.05	

BRTAGDD • Glass Table Mounted Dividers

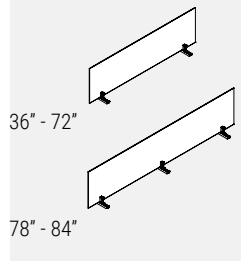

- **Parallel divider, Back 2 Back tables, glass**
- Secures between two Back 2 Back tables; provides privacy, divides space.
- Installed divider measures 15.7" from the top of the worksurface.
- 36" -72" dividers include 2 support brackets; 78" and 84" dividers include 3 support brackets.
- Tempered glass, acid etched finish on one side (similar to frosted), painted support brackets.

PRODUCT CODE	PRICE	SIZE/INCHES			WEIGHT VOL	
		H	W	D	LBS	FT ³
BRTAGDD36	362	16	33	0.25	12	0.07
BRTAGDD42	405	16	39	0.25	14	0.09
BRTAGDD48	437	16	45	0.25	16	0.10
BRTAGDD54	476	16	51	0.25	18	0.11
BRTAGDD60	501	16	57	0.25	21	0.13
BRTAGDD66	541	16	63	0.25	23	0.14
BRTAGDD72	583	16	69	0.25	25	0.16
BRTAGDD78	677	16	75	0.25	27	0.17
BRTAGDD84	718	16	81	0.25	29	0.18

BRTAGDS • Glass Table Mounted Parallel Divider

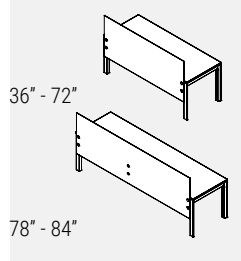

- **Secures to the rear edge of a single table; provides privacy, divides space while not obstructing available light.**
- 36"-72" dividers include 2 mounting brackets; 78" and 84" dividers include 3 mounting brackets.
- Tempered glass, acid etched on one side (similar to frosted), satin chrome disc fasteners and powder coated steel support brackets.
- Installed divider reaches 15.7 up and 15" down from the top of the worksurface.
- Not recommended for use on tables using 42" high legs.

PRODUCT CODE	PRICE	SIZE/INCHES			WEIGHT VOL	
		H	W	D	LBS	FT ³
BRTAGDS36	686	30.7	33	0.250	23	0.150
BRTAGDS42	751	30.7	39	0.250	27	0.175
BRTAGDS48	816	30.7	45	0.250	31	0.200
BRTAGDS54	881	30.7	51	0.250	35	0.225
BRTAGDS60	944	30.7	57	0.250	39	0.250
BRTAGDS66	1008	30.7	63	0.250	43	0.275
BRTAGDS72	1074	30.7	69	0.250	47	0.300
BRTAGDS78	1285	30.7	75	0.250	51	0.325
BRTAGDS84	1349	30.7	81	0.250	55	0.350

BRTAGED • Glass Perpendicular End of Run Divider

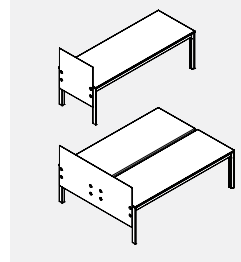

- **Secures to the perpendicular edge of a single or double Back 2 Back table; provides privacy, divides space while not obstructing available light.**
- Installed divider reaches 15.7 up and 15" down from the top of the worksurface.
- 1/2" radius front top corner of 24" and 30" deep glass dividers. 51" and 63" glass dividers for Back 2 Back tables have both top corners 1/2" radius.
- 24" and 30" dividers include 2 mounting brackets.
- 51" and 63" dividers include 4 mounting brackets.
- Tempered glass, acid etched on one side (similar to frosted), satin chrome disc fasteners and powder coated steel support brackets.
- Note: Outside of glass is etched and inside is smooth for left (BRTAGEDL) and right (BRTAGED-R).

PRODUCT CODE	PRICE	SIZE/INCHES			WEIGHT VOL	
		H	W	D	LBS	FT ³
BRTAGED24L	652	30.7	25.4	0.250	23	0.150
BRTAGED24R	652	30.7	25.4	0.250	23	0.150
BRTAGED30L	718	30.7	31.4	0.250	27	0.175
BRTAGED30R	718	30.7	31.4	0.250	27	0.175
BRTAGED51	1285	30.7	50.5	0.250	31	0.200
BRTAGED63	1414	30.7	62.5	0.250	35	0.225

BRTAGPPD-M • Shared Glass Perpendicular Side to Side Divider - Middle

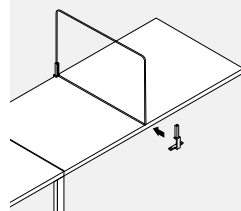

- **Provides privacy, divides space.**
- 24M and 30M kits are designed to be installed on tables with recessed legs (round legs, 34" rectangular legs).
- 24M and 30M kits consist of a rear and front bracket (powder coated steel), tempered glass with rounded top corners (acid etched on one side), bracket-fitting gaskets and mounting screws securing the brackets to the underside of the worksurface.
- Over the seam application would be installed with the wide bracket at the front (thus bypassing the shared leg) and "middle of the work surface" application would be installed with the wide bracket at the back and the narrow at the front".

PRODUCT CODE	PRICE	SIZE/INCHES			WEIGHT VOL	
		H	W	D	LBS	FT ³
BRTAGPPD24M	484	16	24	0.250	9	0.055
BRTAGPPD30M	503	16	30	0.250	11.25	0.069

BRTAGPPD-MQ • Shared Glass Perpendicular Side to Side Divider - Middle - Square Corners

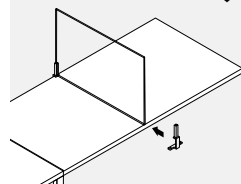

- **Provides privacy, divides space.**
- 24M and 30M kits are designed to be installed on tables with recessed legs (round legs, 34" rectangular legs).
- 24M and 30M kits consist of a rear and front bracket (powder coated steel), tempered glass with rounded top corners (acid etched on one side), bracket-fitting gaskets and mounting screws securing the brackets to the underside of the worksurface.
- Over the seam application would be installed with the wide bracket at the front (thus bypassing the shared leg) and "middle of the work surface" application would be installed with the wide bracket at the back and the narrow at the front".

PRODUCT CODE	PRICE	SIZE/INCHES			WEIGHT VOL	
		H	W	D	LBS	FT ³
BRTAGPPD24MQ	409	16	24	0.250	9	0.055
BRTAGPPD30MQ	430	16	30	0.250	11.25	0.069

BRTAGPPD-S • Shared Glass Perpendicular Side to Side Divider - Seam

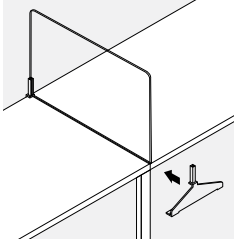

- Provides privacy, divides space.
- 24S and 30S kits are designed to be installed in the middle or over a seam of two adjacent work surfaces supported by a shared, full depth RECTANGULAR leg.
- 24S and 30S kits consist of a rear and front bracket (powder coated steel), tempered glass with rounded top corners (acid etched on one side), bracket-fitting gaskets and mounting screws securing the brackets to the underside of the worksurface.
- Note: Cannot be installed over two, side-by-side rectangular legs. Only one shared or recessed leg.

PRODUCT CODE	PRICE	SIZE/INCHES			WEIGHT VOL	
		H	W	D	LBS	FT ³
BRTAGPPD24S	484	16	24	0.250	9	0.055
BRTAGPPD30S	503	16	30	0.250	11.25	0.069

BRTAGPPD-SQ • Shared Glass Perpendicular Side to Side Divider - Seam - Square Corners

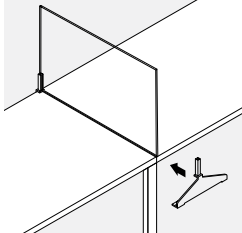

- Provides privacy, divides space.
- 24S and 30S kits are designed to be installed in the middle or over a seam of two adjacent work surfaces supported by a shared, full depth RECTANGULAR leg.
- 24S and 30S kits consist of a rear and front bracket (powder coated steel), tempered glass with rounded top corners (acid etched on one side), bracket-fitting gaskets and mounting screws securing the brackets to the underside of the worksurface. Note: Cannot be installed over two, side-by-side rectangular legs. Only one shared or recessed leg.

PRODUCT CODE	PRICE	SIZE/INCHES			WEIGHT VOL	
		H	W	D	LBS	FT ³
BRTAGPPD24SQ	409	16	24	0.250	9	0.055
BRTAGPPD30SQ	430	16	30	0.250	11.25	0.069

BRTAGMPS • Glass Modesty Panel

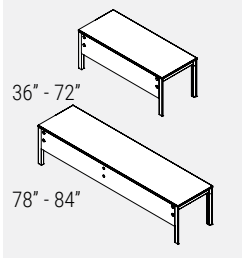

- Secures to the rear edge of a single table, between table legs; provides privacy. Installed divider reaches 15" below the worksurface.
- 36"-72" modesty panels include 2 mounting brackets.
- 78"-84" modesty panels include 3 mounting brackets.
- Tempered glass, acid etched on one side (similar to frosted), satin chrome disc fasteners and powder coated steel support brackets.

PRODUCT CODE	PRICE	SIZE/INCHES			WEIGHT VOL	
		H	W	D	LBS	FT ³
BRTAGMPS36	476	13.25	29.75	0.25	9	0.05
BRTAGMPS42	507	13.25	35.75	0.25	11	0.06
BRTAGMPS48	541	13.25	41.75	0.25	13	0.08
BRTAGMPS54	574	13.25	47.75	0.25	15	0.09
BRTAGMPS60	607	13.25	53.75	0.25	17	0.10
BRTAGMPS66	638	13.25	59.75	0.25	19	0.11
BRTAGMPS72	671	13.25	65.75	0.25	20	0.12
BRTAGMPS78	847	13.25	71.75	0.25	22	0.13
BRTAGMPS84	881	13.25	77.75	0.25	24	0.14

BRTAFDD • Back 2 Back Parallel Felt Divider

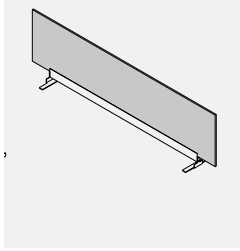

- **Secures to the underside of the worksurface.**
- 9mm felt material is tackable and comes in 18 different colours. Please specify colour.
- Installed divider measures 15.7" high from the top of the worksurface.
- Please choose standard metal finish for extrusion and brackets.
- Upcharge of \$96 for anodized extrusion option.

PRODUCT CODE	PRICE	SIZE/INCHES			WEIGHT VOL	
		H	W	D	LBS	FT ³
BRTAFDD36	198	16.88	33	7.5	2.8	0.41
BRTAFDD42	222	16.88	39	7.5	3.2	0.48
BRTAFDD48	252	16.88	45	7.5	3.7	0.55
BRTAFDD54	355	16.88	51	7.5	4.1	0.63
BRTAFDD60	377	16.88	57	7.5	4.6	0.70
BRTAFDD66	398	16.88	63	7.5	5.0	0.77
BRTAFDD72	420	16.88	69	7.5	5.4	0.85
BRTAFDD78	441	16.88	75	7.5	5.9	0.92
BRTAFDD84	463	16.88	81	7.5	6.3	1.00

BRTAFPPD-M • Perpendicular Side to Side Off Module Felt Divider

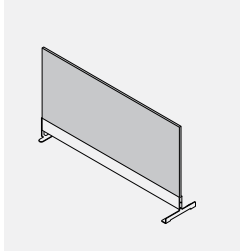

- **1 wide bracket at the back and 1 narrow bracket at the front secure the divider off module to worksurface edges.**
- 9mm felt material is tackable and comes in 18 different colours. Please specify colour.
- Installed divider measures 15.7" high from the top of the worksurface.
- Please choose standard metal finish for extrusion and brackets.
- Upcharge of \$96 for anodized extrusion option.

PRODUCT CODE	PRICE	SIZE/INCHES			WEIGHT VOL	
		H	W	D	LBS	FT ³
BRTAFPPD24M	166	16.85	24.24	6.5	2.1	0.22
BRTAFPPD30M	189	16.85	30.24	6.5	2.6	0.27

BRTAFPPD-S • Perpendicular Side to Side Felt Divider

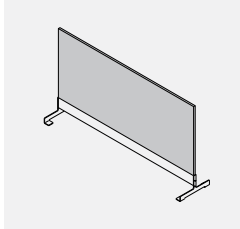

- **2 wide bracket secure the divider off module and over the seam of 2 adjacent worksurface.**
- 9mm felt material is tackable and comes in 18 different colours. Please specify colour.
- Installed divider measures 15.7" high from the top of the worksurface.
- Please choose standard metal finish for extrusion and brackets.
- Upcharge of \$96 for anodized extrusion option.

PRODUCT CODE	PRICE	SIZE/INCHES			WEIGHT VOL	
		H	W	D	LBS	FT ³
BRTAFPPD24S	171	16.85	24.24	6.5	2.3	0.22
BRTAFPPD30S	193	16.85	30.24	6.5	2.7	0.27
BRTAFPPD51S	347	16.85	50.81	6.5	4.2	0.46
BRTAFPPD63S	393	16.85	62.81	6.5	5.1	0.57

BRTAFDSN • Felt Divider and Modesty Panel Kit

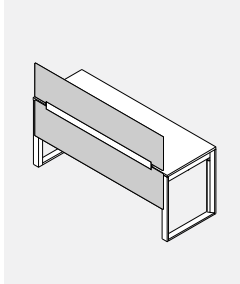

- **Felt divider and modesty panel kit secures to the rear bottom of a single Bridges table and provides privacy above and below the worksurface.**
- 9 mm felt material is tackable and comes in a wide range of colours.
- Installed, the divider measures 15.7 high from the top of the worksurface and 15" high below the top of the worksurface.
- Kit includes two felt dividers, support extrusion and left and right brackets.
- Please choose the finish of the felt and the metal finish for the extrusion and brackets.

PRODUCT CODE	PRICE	SIZE/INCHES			WEIGHT VOL	
		H	W	D	LBS	FT ³
BRTAFDSN48	484	30.68	45	4.05	5.19	38.83
BRTAFDSN54	585	30.68	51	4.05	5.87	44.01
BRTAFDSN60	624	30.68	57	4.05	6.54	49.18
BRTAFDSN66	652	30.68	63	4.05	7.21	54.36
BRTAFDSN72	748	30.68	69	4.05	7.89	59.54
BRTAFDSN78	788	30.68	72	4.05	8.57	62.13
BRTAFDSN84	826	30.68	78	4.05	9.24	67.30

BRTAFEDN • Felt End Divider and Modesty Panel Kit

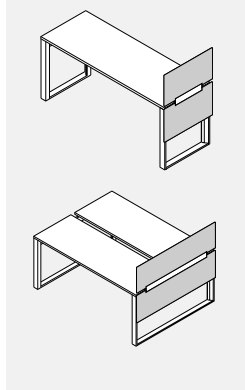

- Felt divider and modesty panel kit secures to the side bottom of a single or back to back Bridges table and provides privacy above and below the worksurface.
- 9 mm felt material is tackable and comes in a wide range of colours.
- Installed, the divider measures 15.7 high from the top of the worksurface and 15" high below the top of the worksurface.
- Kit includes two felt dividers, support extrusion and left and right brackets.
- Please choose the finish of the felt and the metal finish for the extrusion and brackets.

PRODUCT CODE	PRICE	SIZE/ INCHES			WEIGHT VOL	
		H	W	D	LBS	FT ³
BRTAFEDN24	294	30.68	25.46	4.05	3.3	21.97
BRTAFEDN30	331	30.68	31.46	4.05	3.98	27.15
BRTAFEDN51	607	30.68	50.56	4.05	6.22	43.63
BRTAFEDN63	692	30.68	62.56	4.05	7.57	53.98

BRTAFMPSN • Felt Modesty Panel

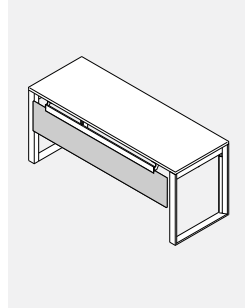

- Felt modesty panel secures to the rear bottom of a single Bridges table and provides privacy below the worksurface.
- 9 mm felt material is tackable and comes in a wide range of colours.
- Installed, the divider measures 15" high below the top of the worksurface.
- Kit includes felt modesty, support extrusion and left and right brackets.
- Please choose the finish of the felt and the metal finish for the extrusion and brackets.

PRODUCT CODE	PRICE	SIZE/ INCHES			WEIGHT VOL	
		H	W	D	LBS	FT ³
BRTAFMPSN48	196	13.82	41.76	4.17	3.31	16.71
BRTAFMPSN54	268	13.82	47.76	4.17	3.72	19.11
BRTAFMPSN60	281	13.82	53.76	4.17	4.13	21.51
BRTAFMPSN66	298	13.82	59.76	4.17	4.54	23.92
BRTAFMPSN72	317	13.82	65.76	4.17	4.95	26.32
BRTAFMPSN78	333	13.82	71.76	4.17	5.36	28.72
BRTAFMPSN84	353	13.82	77.76	4.17	5.77	31.12

Single Table Or Single Table Row Application:

Perpendicular laminate side to side divider
BRTLPPD: flush with the front WS edge. Can be installed off-module to the front and back edge of work surface, regardless of type of leg support - supporting brackets can straddle over shared leg."

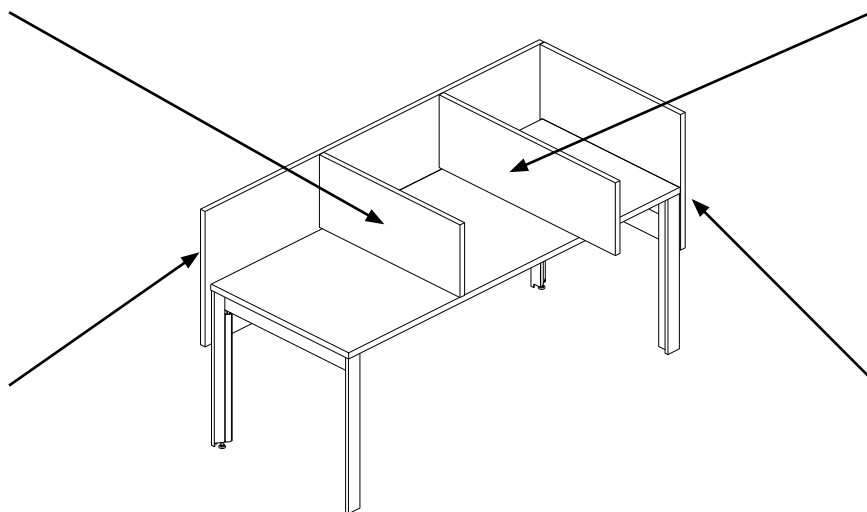

Extended Perpendicular Laminate side to side divider
BRTLPE The extended version protrudes by 6" beyond the front WS edge for added privacy. Can be installed off-module to the front and back edge of work surface, regardless of type of leg support - supporting brackets can straddle over shared leg."

Parallel laminate table mounted divider
BRTLPPDS for single table or single table row: recessed 1.3" at both ends; mounted to the table with 0.9" gap at the back.

Laminate perpendicular end of run divider
BRTLPE 24, 30 for single table or single table run: flush at the front WS edge; extended back flush with BRTLPPDS divider."

Back-To-Back And Back 2 Back Table Row Application:

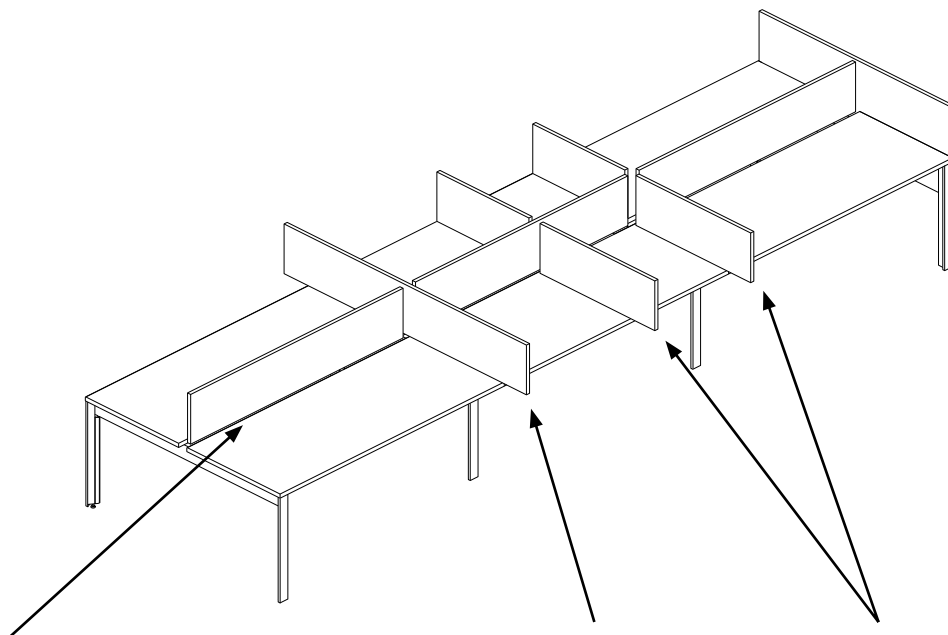

Parallel laminate table mounted divider
BRTLPPD: recessed 1.3" at both ends; mounted between two back-to-back work surfaces."

Extended perpendicular laminate side to side double divider BRTLPPDSE: this one piece divider spans beyond both back-2-back work surfaces: installs on-module, between two BRTLPPD dividers and is secured to the front edge of both work surfaces, regardless of type of leg support - supporting brackets can straddle over shared leg." Protrudes 6" beyond the front

Extended perpendicular laminate side to side divider BRTLPE. The extended version protrudes by 6" beyond the front WS edge for added privacy. Can be installed off-module or on module to the front and back edge of work surface, regardless of type of leg support - supporting brackets can straddle over shared leg." Shown above in On-module and Off-module application.

BRTLPESE • Perpendicular Laminate Side to Side Divider - Extended

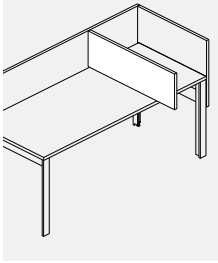

- Provides privacy, divides spaces.
- Protrudes by 6" beyond the front worksurface edge for added privacy.
- Specify BRTLPESE30 for 24" deep work surfaces and BRTLPESE36 for 30" deep work surfaces.
- Secures off-module or on-module to the front and back edge of work surface, regardless of type of leg support - supporting brackets can straddle over shared leg.
- Includes powder coated steel support brackets. 3/4 LP PVC edge boards, please specify laminate and 3mm PVC edge on order.

PRODUCT CODE	PRICE	SIZE/INCHES			WEIGHT VOL	
		H	W	D	LBS	FT ³
BRTLPESE30	215	16	30	0.75	9.00	0.21
BRTLPESE36	245	16	36	0.75	11.00	0.25

BRTLPESE • Perpendicular Laminate Side to Side Double Divider - Extended

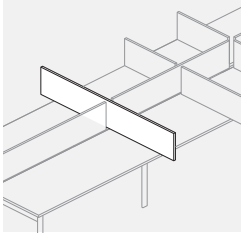

- Provides privacy, divides space. Protrudes 6" beyond the front worksurface edges on either side for added privacy.
- Specify BRTLPESE63 for 24" deep back 2 back work surfaces and BRTLPESE75 for 30" deep back 2 back work surfaces.
- Installs on-module, between two BRTLPESE dividers. It is secured to the front edge of both work surfaces, regardless of type of leg support - supporting brackets can straddle over shared leg.
- NOTE: Can only be installed on-module, between two BRTLPESE dividers.
- Includes powder coated steel support brackets. 3/4 LP PVC edge boards, please specify laminate and 3mm PVC edge on order.

PRODUCT CODE	PRICE	SIZE/INCHES			WEIGHT VOL	
		H	W	D	LBS	FT ³
BRTLPESE63	399	16	63	0.75	18.00	0.44
BRTLPESE75	446	16	75	0.75	22.00	0.52

BRTLPESE • Laminate Table Mounted Dividers

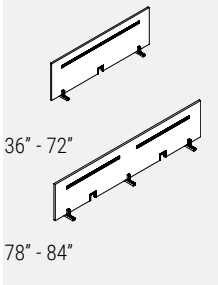

- Parallel divider, Back 2 Back tables, LP
- Secures between two Back 2 Back tables; provides privacy, divides space.
- Installed divider measures 15.7" from the top of the worksurface.
- 78" and 84" dividers include 3 support brackets and two pass-through grommets.
- Integrated anodized aluminum accessory rail, white cut out and rail trims; painted support brackets.
- 3/4" LP PVC edged boards, please specify laminate & 3mm PVC edge on order.

PRODUCT CODE	PRICE	SIZE/INCHES			WEIGHT VOL	
		H	W	D	LBS	FT ³
BRTLPESE36	283	16	33	0.75	10	0.22
BRTLPESE42	309	16	39	0.75	12	0.27
BRTLPESE48	337	16	45	0.75	14	0.31
BRTLPESE54	355	16	51	0.75	15	0.35
BRTLPESE60	372	16	57	0.75	17	0.39
BRTLPESE66	389	16	63	0.75	19	0.43
BRTLPESE72	417	16	69	0.75	21	0.47
BRTLPESE78	523	16	75	0.75	23	0.52
BRTLPESE84	539	16	81	0.75	24	0.56

BRTLPESE • High Laminate Table Mounted Divider

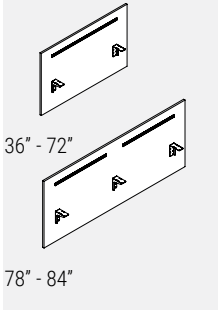

- Parallel divider, single tables, LP
- Accessory rail is installed on one side only.
- Secures to the back of a single table; provides privacy, divides space.
- Installed divider reaches 15.7 up and 15" down from the top of the worksurface.
- 36" - 72" dividers include 2 support brackets; 78" and 84" dividers include 3 support brackets.
- Integrated anodized aluminum accessory rail, white cut out and rail trims; powder coat brackets.
- Integrated modesty panel.
- 3/4" LP PVC edged boards, please specify laminate & 3mm PVC edge on order.
- Not recommended for use on tables using 42" high legs.

PRODUCT CODE	PRICE	SIZE/INCHES			WEIGHT VOL	
		H	W	D	LBS	FT ³
BRTLPESE36	398	30.7	33	0.75	22	0.50
BRTLPESE42	486	30.7	39	0.75	25	0.56
BRTLPESE48	523	30.7	45	0.75	29	0.66
BRTLPESE54	550	30.7	51	0.75	32	0.75
BRTLPESE60	592	30.7	57	0.75	36	0.83
BRTLPESE66	626	30.7	63	0.75	40	0.91
BRTLPESE72	663	30.7	69	0.75	43	1.00
BRTLPESE78	813	30.7	75	0.75	47	1.08
BRTLPESE84	849	30.7	81	0.75	50	1.16

BRTLPPD • High Perpendicular Laminate Side to Side Divider

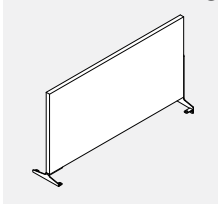

- Perpendicular side-to-side divider, 3/4" LP PVC edged board, please specify laminate & 3mm PVC edge finish.
- Includes powder coated steel support brackets.
- Provides privacy, divides space; secures off-module or on-module to the front and back edge of worksurface, regardless of type of leg support - supporting brackets can straddle over shared leg.
- Installed divider measures 15.7" from the top of the worksurface.

PRODUCT CODE	PRICE	SIZE/INCHES			WEIGHT VOL	
		H	W	D	LBS	FT ³
BRTLPPD24	195	16	24	0.75	7	0.16
BRTLPPD30	212	16	30	0.75	9	0.20

BRTLPEP • Laminate Perpendicular End of a Run Divider

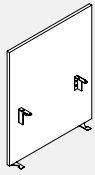

- Secures to the side edge of a table/tables; provides privacy, divides space, LP.
- Installed divider reaches 15.7" up and 15" down from the top of the worksurface.
- Includes powder coated steel support brackets for rectangular legs only.
- Integrated modesty panel.
- 3/4" LP self edged boards, please specify laminate & 3mm PVC edge on order.

PRODUCT CODE	PRICE	SIZE/INCHES			WEIGHT VOL	
		H	W	D	LBS	FT ³
BRTLPEP24	310	30.7	24	0.75	7	0.16
BRTLPEP30	337	30.7	30	0.75	9	0.20
BRTLPEP51	530	30.7	50.5	0.75	15	0.35
BRTLPEP63	603	30.7	62.5	0.75	19	0.43

BRTPEG • Laminate Gable for Rectangular Leg

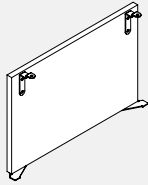

- **Perpendicular end of a run gable, LP**
- Secures to the side edge of a table/tables and rectangular legs; provides privacy, divides space.
- Includes powder coated steel support brackets.
- 3/4" LP self edged boards.
- 3 Gable heights available:
 - BRTPEG24, 30, 51 and 63 measure 15" below worksurface.
 - BRTPEGH21 lines up with the bottom of storage cabinets.
 - BRTPEGH27 reaches down 1" from the floor.
- Note: BRTPEGH27 will not fit on BRTSLLL Loop Leg.

PRODUCT CODE	PRICE	SIZE/INCHES			WEIGHT VOL	
		H	W	D	LBS	FT ³
BRTPEG24	202	14	24	0.75	6	0.14
BRTPEG24H21	231	20.5	24	0.75	9	0.21
BRTPEG24H27	270	26.5	24	0.75	12	0.26
BRTPEG30	218	14	30	0.75	8	0.18
BRTPEG30H21	245	20.5	30	0.75	12	0.26
BRTPEG30H27	284	26.5	30	0.75	15	0.33
BRTPEG51	356	14	50.5	0.75	13	0.30
BRTPEG51H21	422	20.5	50.5	0.75	20	0.43
BRTPEG51H27	493	26.5	50.5	0.75	26	0.56
BRTPEG63	387	14	62.5	0.75	16	0.38
BRTPEG63H21	455	20.5	62.5	0.75	25	0.53
BRTPEG63H27	524	26.5	62.5	0.75	32	0.69

BRTMPS • Laminate Modesty Panel

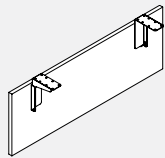

- **Parallel modesty panel, single tables, LP**
- Secures to the back edge of a table; provides privacy, divides space.
- Installed divider reaches 15" below worksurface.
- Includes powder coated steel support brackets.
- 3/4" LP self edged boards.
- Flip down for easy access to underside of worksurface.
- Note: actual size of modesty is different than the nominal code.

PRODUCT CODE	PRICE	SIZE/INCHES			WEIGHT VOL	
		H	W	D	LBS	FT ³
BRTMPS36	345	14	30.5	0.75	9	0.21
BRTMPS42	362	14	36.5	0.75	11	0.25
BRTMPS48	380	14	42.5	0.75	13	0.29
BRTMPS54	396	14	48.5	0.75	14	0.32
BRTMPS60	410	14	54.5	0.75	16	0.36
BRTMPS66	428	14	60.5	0.75	17	0.40
BRTMPS72	443	14	66.5	0.75	19	0.43
BRTMPS78	461	14	72.5	0.75	20	0.47
BRTMPS84	476	14	78.5	0.75	22	0.51

BRLBST • Single Rail Accessory Rail

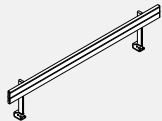

- **Table mounted accessory rail**
- Compatible with standard accessories.
- Includes end caps and mounting hardware.
- Please specify paint finish.

PRODUCT CODE	PRICE	SIZE/INCHES			WEIGHT VOL	
		H	W	D	LBS	FT ³
BRLBST36	288	13.5	33	2.95	5.90	0.26
BRLBST42	301	13.5	39	2.95	6.44	0.30
BRLBST48	311	13.5	45	2.95	6.98	0.35
BRLBST54	323	13.5	51	2.95	7.52	0.39
BRLBST60	332	13.5	57	2.95	8.07	0.43
BRLBST66	342	13.5	63	2.95	8.61	0.48
BRLBST72	355	13.5	69	2.95	9.15	0.52
BRLBST78	365	13.5	75	2.95	9.69	0.56
BRLBST84	377	13.5	81	2.95	10.24	0.61

BRLBB2B • Back 2 Back Accessory Rail

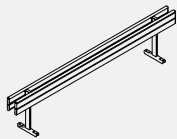

- **Double sided accessory rail mounts between worksurfaces on back 2 back assembly**
- Compatible with standard accessories.
- Includes end caps and mounting hardware.
- Please specify paint finish.

PRODUCT CODE	PRICE	SIZE/INCHES			WEIGHT VOL	
		H	W	D	LBS	FT ³
BRLBB2B36	444	13.5	33	7.50	9.02	0.32
BRLBB2B42	472	13.5	39	7.50	10.10	0.37
BRLBB2B48	495	13.5	45	7.50	11.19	0.42
BRLBB2B54	519	13.5	51	7.50	12.27	0.48
BRLBB2B60	534	13.5	57	7.50	13.36	0.53
BRLBB2B66	557	13.5	63	7.50	14.44	0.58
BRLBB2B72	578	13.5	69	7.50	15.52	0.63
BRLBB2B78	601	13.5	75	7.50	16.61	0.69
BRLBB2B84	624	13.5	81	7.50	17.69	0.74

Single Table Or Single Table Row Application; 16" and 30" high dividers

Table Mounted Framed Divider for single table or single table row; recessed 1.5" at both ends, mounted to the table with 0.6" gap at the back.

BRTMFD/BRTMLD 36" (33" actual) - 66" (63" actual) dividers have 2 mounting brackets.
BRTMFD/BRTMLD 72" (69" actual) - 84" (81" actual) dividers have 3 mounting brackets.

Perpendicular Single Table End of Run Framed Divider;
BREFD/BRELD 24" (21" actual for 24" deep work surfaces),
BREFD/BRELD 30" (27" actual for 30" deep work surfaces),
BREFD/BRELD 36" (33" actual for 36" deep work surfaces),

Two brackets secure the divider to the side edge of work surface. Flush with rear edge, 3" recessed from front work surface edge.

Perpendicular Shared Framed Divider;
BRSFD/BRSLD 24" (21" actual for 24" deep work surfaces),
BRSFD/BRSLD 30" (27" actual for 30" deep work surfaces),
BRSFD/BRSLD 36" (33" actual for 36" deep work surfaces),

Single bracket secures the divider to the rear edge of work surface; Can be mounted off-module or over the seam of two adjacent work surfaces. Flush with the rear edge, 3" recessed from front work surface edge.

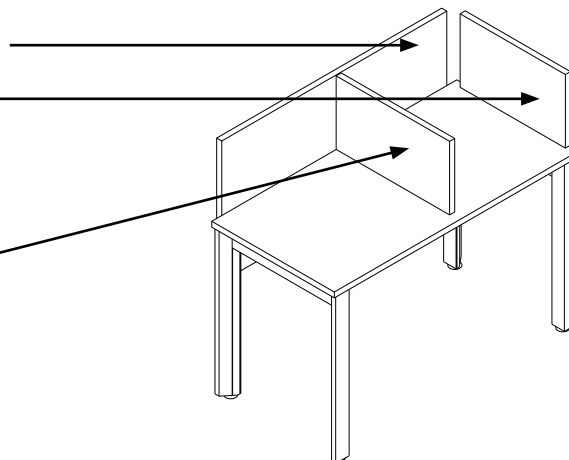

Back 2 Back Table Application; 16" dividers

Perpendicular Back 2 Back Parallel Framed Divider secured between two back-to-back tables; recessed 1.5" at both ends; 0.6" gap between the divider and work surfaces.

BRPFD/BRPLD 36" (33" actual) - 66" (63" actual) dividers have 2 mounting brackets.
BRPFD/BRPLD 72" (69" actual) - 84" (81" actual) dividers have 3 mounting brackets.

Perpendicular Shared Frame Back 2 Back Framed Divider;
BRSDFD/BRSDLD 51" (45" actual for 24" deep back-to-back work surfaces)
BRSDFD/BRSDLD 63" (57" actual for 30" deep back-to-back work surfaces).
One bracket secures the divider through the gap between work surfaces; two brackets locate top of the divider between two adjacent Parallel dividers.
NOTE: cannot be used on its own without the two Parallel dividers.
3" recessed from front work surface edges.

Perpendicular Back 2 Back End of Run Framed Divider;
BREDFD/BREDLD 51" (45" actual for 24" deep back-to-back work surfaces)
BREDFD/BREDLD 63" (57" actual for 30" deep back-to-back work surfaces).
Three brackets secure the divider to both side edges of work surfaces.
3" recessed from front work surface edges.

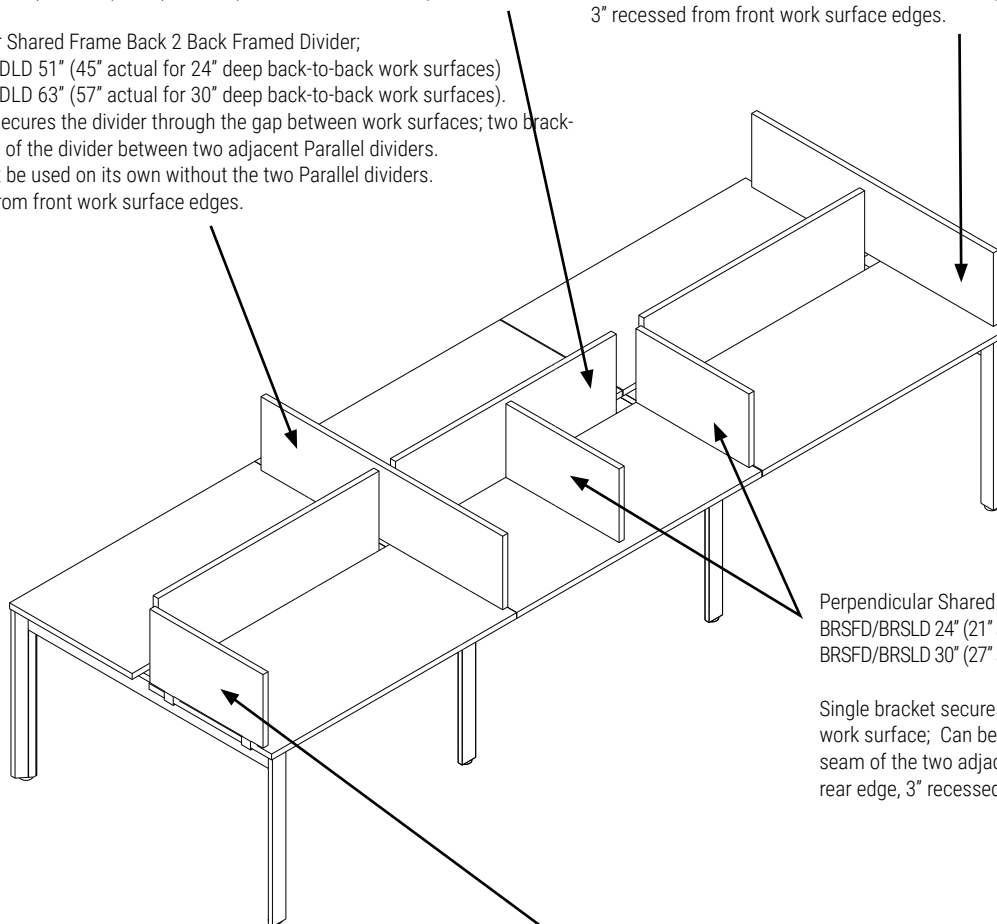

Perpendicular Shared Framed Divider;
BRSFD/BRSLD 24" (21" actual for 24" deep work surfaces).
BRSFD/BRSLD 30" (27" actual for 30" deep work surfaces).

Single bracket secures the divider to the rear edge of work surface; Can be mounted off-module or over the seam of the two adjacent work surfaces. Flush with the rear edge, 3" recessed from front work surfaces edge.

Perpendicular Single Table End of Run Framed Divider;
BREFD/BRELD 24" (21" actual for 24" deep work surfaces).
BREFD/BRELD 30" (27" actual for 30" deep work surfaces).

Two brackets secure the divider to the side edge of work surface. Flush with the rear edge, 3" recessed from front work surface edge.

Note: Do not use framed dividers with glass dividers. Connection hardware will not fit.

BRPFD/BRPLD • Back 2 Back Parallel Framed Dividers

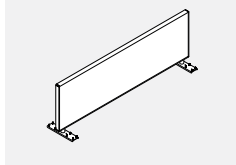

- **Secures to the underside of the worksurface**
- Divider frame and connecting hardware is painted, please choose from standard metal paint finishes.
- Fabric divider is tackable and always railroaded.
- Divider infill can be specified in fabric, low pressure laminate (LP), high pressure laminate (HP), dry erase whiteboard (DE) or dry erase magnetic whiteboard (DM).
- Installed divider measures 15.7" from top of worksurface.
- 36" to 54" dividers include 2 support brackets. 60" to 84" dividers include 3 support brackets.
- Note 60" - 84" dividers require 3 support brackets and cannot be used with worksurfaces that have a single access door

PRODUCT CODE	PRICE		SIZE/INCHES			WEIGHT VOL	
	GR1	GR2	H	W	D	LBS	FT ³
BRPFD36	341	375	16	33	1.25	13	0.92
BRPFD42	352	384	16	39	1.25	15	1.08
BRPFD48	404	443	16	45	1.25	17	1.25
BRPFD54	421	469	16	51	1.25	19	1.42
BRPFD60	508	557	16	57	1.25	22	1.58
BRPFD66	535	590	16	63	1.25	23	1.75
BRPFD72	552	613	16	69	1.25	25	1.92
BRPFD78	561	624	16	75	1.25	27	2.08
BRPFD84	587	656	16	81	1.25	28	2.25

PRODUCT CODE	PRICE				SIZE/INCHES			LP/HP/DE	MAG	VOL
	LP	HP	DE	DM	H	W	D	LBS	LBS	FT ³
BRPLD36	251	326	424	710	16	33	1.25	17	20	0.92
BRPLD42	265	347	459	785	16	39	1.25	19	23	1.08
BRPLD48	297	404	527	903	16	45	1.25	21	26	1.25
BRPLD54	347	486	860	1608	16	51	1.25	24	29	1.42
BRPLD60	418	574	908	1659	16	57	1.25	26	32	1.58
BRPLD66	431	626	916	1760	16	63	1.25	30	37	1.75
BRPLD72	446	630	971	1774	16	69	1.25	33	40	1.92
BRPLD78	451	659	978	1790	16	75	1.25	35	43	2.08
BRPLD84	461	691	987	1803	16	81	1.25	37	46	2.25

BREFD/BRELD • Perpendicular Single Table End of Run Framed Dividers

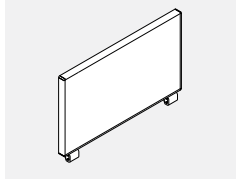

- **Connects to the perpendicular end of a single or Back 2 Back table.**
- Divider frame and connecting hardware is painted, please choose from standard metal paint finishes.
- Fabric divider is tackable and always railroaded.
- Divider infill can be specified in fabric, low pressure laminate (LP), high pressure laminate (HP), dry erase whiteboard (DE) or dry erase magnetic whiteboard (DM) user side only.
- Installed divider measures 15.7" from top of worksurface.
- Divider comes with 2 support brackets.
- When dry erase magnetic whiteboard (DM) is specified it is applied user side ONLY and dry erase whiteboard (DE) is applied on the opposite side.
- Two brackets secure the divider to the side edge of work surface. Flush with the rear edge, 3" recessed from front work surface edge.

PRODUCT CODE	PRICE		SIZE/INCHES			WEIGHT VOL	
	GR1	GR2	H	W	D	LBS	FT ³
BREFD24	263	292	16	21	1.25	9	0.58
BREFD30	272	300	16	27	1.25	11	0.75
BREFD36	297	332	16	33	1.25	12	0.92

PRODUCT CODE	PRICE				SIZE/INCHES			LP/HP/DE	MAG	VOL
	LP	HP	DE	DM	H	W	D	LBS	LBS	FT ³
BRELD24	188	242	305	367	16	21	1.25	12	14	0.58
BRELD30	208	277	340	418	16	27	1.25	14	17	0.75
BRELD36	215	293	389	486	16	33	1.25	16	20	0.92

BRSFD/BRSLD • Perpendicular Shared Framed Dividers

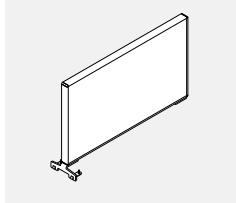

- **Connects anywhere along and between worksurfaces to divide space and create privacy.**
- Divider is fastened under the worksurface flush to the back of the table and recessed 3" from the front edge on the user side.
- Divider frame and connecting hardware is painted, please choose from standard metal paint finishes.
- Fabric divider is tackable and always railroaded.
- Divider infill can be specified in fabric, low pressure laminate (LP), high pressure laminate (HP), dry erase whiteboard (DE) or dry erase magnetic whiteboard (DM).
- Installed divider measures 15.7" from top of worksurface.
- Divider comes with a support bracket at the back and a spacer plate with double sided adhesive at the front.

PRODUCT CODE	PRICE		SIZE/INCHES			WEIGHT VOL	
	GR1	GR2	H	W	D	LBS	FT ³
BRSFD24	254	281	16	21	1.25	9	0.58
BRSFD30	263	292	16	27	1.25	11	0.75
BRSFD36	290	322	16	33	1.25	12	0.92

PRODUCT CODE	PRICE				SIZE/INCHES			LP/HP/DE	MAG	VOL
	LP	HP	DE	DM	H	W	D	LBS	LBS	FT ³
BRSLD24	188	237	297	486	16	21	1.25	12	14	0.58
BRSLD30	202	271	333	603	16	27	1.25	14	17	0.75
BRSLD36	215	293	389	667	16	33	1.25	16	20	0.92

BREDFD/BREDLD • Perpendicular Back 2 Back End of Run Framed Dividers

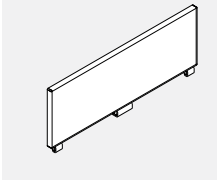

- **Connects to the end of run on Back 2 Back tables to create privacy.**
- Divider is fastened under the worksurface and recessed 3" from the user edge on the either side.
- Divider frame and connecting hardware is painted, please choose from standard metal paint finishes.
- Fabric divider is tackable and always railroaded.
- Divider infill can be specified in fabric, low pressure laminate (LP), high pressure laminate (HP), dry erase whiteboard (DE) or dry erase magnetic whiteboard (DM) user side only.
- Installed divider measures 15.7" from top of worksurface.
- Divider comes with 1 large and 2 small support brackets.
- When dry erase magnetic whiteboard (DM) is specified it is applied user side ONLY and dry erase whiteboard (DE) is applied on the opposite side

PRODUCT CODE	PRICE		SIZE/ INCHES			WEIGHT		VOL FT ³
	GR1	GR2	H	W	D	LBS		
BREDFD51	410	454	16	45	1.25	18	1.25	
BREDFD63	464	512	16	57	1.25	21	1.58	

PRODUCT CODE	PRICE		SIZE/ INCHES				LP/HP/DE		MAG LBS	VOL FT ³
	LP	HP	DE	DM	H	W	D			
BREDLD51	305	408	541	659	16	45	1.25	21	26	1.25
BREDLD63	375	535	875	1119	16	57	1.25	26	32	1.58

BRSDFD/BRSDL D • Perpendicular Back 2 Back Shared Framed Dividers

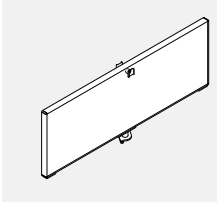

- **Connects between parallel framed dividers for Back 2 Back tables to divide space and create privacy.**
- Divider is fastened under the worksurface and recessed 3" from the user edge on the either side.
- Divider frame and connecting hardware is painted, please choose from standard metal paint finishes.
- Fabric divider is tackable and always railroaded.
- Divider infill can be specified in fabric, low pressure laminate (LP), high pressure laminate (HP), dry erase whiteboard (DE) or dry erase magnetic whiteboard (DM).
- Installed divider measures 15.7" from top of worksurface.
- Divider comes with one center support bracket, two spacer plates with adhesive and two top spacer clamps.

PRODUCT CODE	PRICE		SIZE/ INCHES			WEIGHT		VOL FT ³
	GR1	GR2	H	W	D	LBS		
BRSDFD51	385	426	16	45	1.25	17	1.25	
BRSDFD63	438	486	16	57	1.25	20	1.58	

PRODUCT CODE	PRICE		SIZE/ INCHES				LP/HP/DE		MAG LBS	VOL FT ³
	LP	HP	DE	DM	H	W	D			
BRSDL D51	293	396	521	894	16	45	1.25	21	26	1.25
BRSDL D63	361	513	853	1603	16	57	1.25	26	32	1.58

NOTE: cannot be used on its own without the two Parallel dividers.

BRTMFD/BRTMLD • Table Mounted Framed Dividers

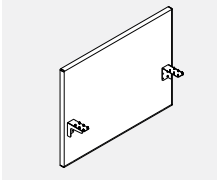

- **Parallel divider for single tables.**
- Divider frame and connecting hardware is painted, please choose from standard metal paint finishes.
- Fabric divider is tackable and always railroaded.
- Divider infill can be specified in fabric, low pressure laminate (LP), high pressure laminate (HP), dry erase whiteboard (DE) or dry erase magnetic whiteboard (DM) user side only.
- Fastens to the underside of the worksurface
- 0.6 gap between worksurface and divider allows for cable pass thru.
- Installed divider reaches 15.7" up and 15" down from the top of the worksurface.
- 36" to 66" dividers include 2 support brackets. 72" to 84" dividers include 3 support brackets.
- When dry erase magnetic whiteboard (DM) is specified it is applied user side ONLY and dry erase whiteboard (DE) is applied on the opposite side.
- LAMINATE NOTE: 72" to 84" dividers require 3 support brackets and cannot be used with worksurfaces that have a single access door.
- FABRIC NOTE: 60" to 84" dividers require 3 support brackets and cannot be used with worksurfaces that have a single access door.

PRODUCT CODE	PRICE		SIZE/ INCHES			WEIGHT		VOL FT ³
	GR1	GR2	H	W	D	LBS		
BRTMFD36	307	340	30	33	1.25	20	1.90	
BRTMFD42	367	403	30	39	1.25	22	2.03	
BRTMFD48	410	454	30	45	1.25	25	2.34	
BRTMFD54	457	505	30	51	1.25	27	2.66	
BRTMFD60	518	565	30	57	1.25	30	2.97	
BRTMFD66	587	641	30	63	1.25	33	3.28	
BRTMFD72	604	667	30	69	1.25	37	3.59	
BRTMFD78	630	692	30	75	1.25	40	3.91	
BRTMFD84	674	743	30	81	1.25	43	4.22	

PRODUCT CODE	PRICE		SIZE/ INCHES				LP/HP/DE		MAG LBS	VOL FT ³
	LP	HP	DE	DM	H	W	D			
BRTMLD36	365	510	741	1184	30	33	1.25	30	38	1.90
BRTMLD42	380	526	1069	1434	30	39	1.25	34	42	2.03
BRTMLD48	395	540	1075	1527	30	45	1.25	38	48	2.34
BRTMLD54	408	556	2060	2794	30	51	1.25	43	54	2.66
BRTMLD60	431	576	2185	2958	30	57	1.25	48	60	2.97
BRTMLD66	446	653	2191	2973	30	63	1.25	52	66	3.28
BRTMLD72	468	673	2206	2988	30	69	1.25	57	71	3.59
BRTMLD78	928	1236	2220	3001	30	75	1.25	61	77	3.91
BRTMLD84	943	1250	2234	3016	30	81	1.25	66	83	4.22

BRTADP-H24 • Back 2 Back Polycarbonate Divider Screen Kit, 24" high

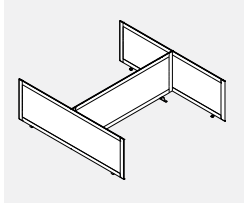

- Provides privacy in an open plan environment.
- Lightweight and easy to clean table mounted partitions.
- Consists of a powder coated aluminum frame, translucent fluted polycarbonate and all hardware to connect. Brackets are painted steel.
- Side dividers extend 6.25" from the front edge of each surface.
- Center divider sits over the gap between the work surface allowing for the passage of cables to the trough. The gap for each side is approximately 1".
- BRTADP51-H24 are for 24" deep surfaces and BRTADP63-H24 are for 30" deep surfaces.
- Width and depth are nominal sizes representing the sizes of the Bridges configuration. Allow for 1/4" overhang at sides and 6 1/4" at front.
- Please choose any standard paint finish for frame and hardware. End trim cap is available only in CHR - charcoal.

PRODUCT CODE	PRICE	SIZE/INCHES			WEIGHT LBS	VOL FT³
		H	W	D		
BRTADP5136H24	1070	24.63	36	50.50	33.00	6.31
BRTADP5142H24	1092	24.63	42	50.50	34.50	7.36
BRTADP5148H24	1114	24.63	48	50.50	36.00	8.42
BRTADP5154H24	1136	24.63	54	50.50	37.50	9.47
BRTADP5160H24	1159	24.63	60	50.50	39.00	10.52
BRTADP5166H24	1183	24.63	66	50.50	40.50	11.57
BRTADP5172H24	1202	24.63	72	50.50	42.00	12.63
BRTADP5178H24	1225	24.63	78	50.50	43.50	13.68
BRTADP5184H24	1249	24.63	84	50.50	45.00	14.73
BRTADP6336H24	1158	24.63	36	62.50	46.50	7.81
BRTADP6342H24	1179	24.63	42	62.50	48.00	9.11
BRTADP6348H24	1201	24.63	48	62.50	49.50	10.42
BRTADP6354H24	1224	24.63	54	62.50	51.00	11.72
BRTADP6360H24	1246	24.63	60	62.50	52.50	13.02
BRTADP6366H24	1267	24.63	66	62.50	54.00	14.32
BRTADP6372H24	1290	24.63	72	62.50	55.50	15.63
BRTADP6378H24	1313	24.63	78	62.50	57.00	16.93
BRTADP6384H24	1335	24.63	84	62.50	58.50	18.23

BRTADP-H30 • Back 2 Back Polycarbonate Divider Screen Kit, 30" high

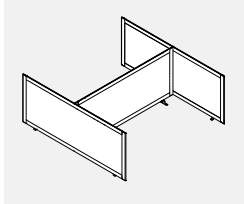

- Provides privacy in an open plan environment.
- Lightweight and easy to clean table mounted partitions.
- Consists of a powder coated aluminum frame, translucent fluted polycarbonate and all hardware to connect. Brackets are painted steel.
- Side dividers extend 6.25" from the front edge of each surface.
- Center divider sits over the gap between the work surface allowing for the passage of cables to the trough. The gap for each side is approximately 1".
- BRTADP51-H24 are for 24" deep surfaces and BRTADP63-H24 are for 30" deep surfaces.
- Width and depth are nominal sizes representing the sizes of the Bridges configuration. Allow for 1/4" overhang at sides and 6 1/4" at front.
- Please choose any standard paint finish for frame and hardware. End trim cap is available only in CHR - charcoal.

PRODUCT CODE	PRICE	SIZE/INCHES			WEIGHT LBS	VOL FT³
		H	W	D		
BRTADP5136H30	1187	30.63	36	50.50	35.50	6.31
BRTADP5142H30	1212	30.63	42	50.50	37.00	7.36
BRTADP5148H30	1238	30.63	48	50.50	38.50	8.42
BRTADP5154H30	1264	30.63	54	50.50	40.00	9.47
BRTADP5160H30	1289	30.63	60	50.50	41.50	10.52
BRTADP5166H30	1316	30.63	66	50.50	43.00	11.57
BRTADP5172H30	1341	30.63	72	50.50	44.50	12.63
BRTADP5178H30	1366	30.63	78	50.50	46.00	13.68
BRTADP5184H30	1393	30.63	84	50.50	47.50	14.73
BRTADP6336H30	1332	30.63	36	62.50	49.00	7.81
BRTADP6342H30	1357	30.63	42	62.50	50.50	9.11
BRTADP6348H30	1386	30.63	48	62.50	52.00	10.42
BRTADP6354H30	1409	30.63	54	62.50	53.50	11.72
BRTADP6360H30	1437	30.63	60	62.50	55.00	13.02
BRTADP6366H30	1462	30.63	66	62.50	56.50	14.32
BRTADP6372H30	1488	30.63	72	62.50	58.00	15.63
BRTADP6378H30	1515	30.63	78	62.50	59.50	16.93
BRTADP6384H30	1539	30.63	84	62.50	61.00	18.23

BRTADPE-H24 - Back 2 Back Polycarbonate Divider Screen Kit, 24" high

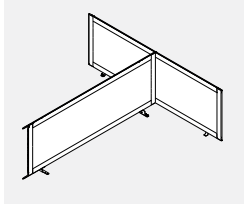

- Provides an extension for privacy in an open plan environment. Intended to always connect to Back 2 Back Divider Screen Kit
- Lightweight and easy to clean table mounted partitions.
- Consists of a powder coated aluminum frame, translucent fluted polycarbonate and all hardware to connect. Brackets are painted steel.
- Side dividers extend 6.25" from the front edge of each surface.
- Center divider sits over the gap between the work surface allowing for the passage of cables to the trough. The gap for each side is approximately 1".
- BRTADPE51-H24 are for 24" deep surfaces and BRTADPE63-H24 are for 30" deep surfaces.
- Width and depth are nominal sizes representing the sizes of the Bridges configuration. Allow for 1/4" overhang at sides and 6 1/4" at front.
- Please choose any standard paint finish for frame and hardware. End trim cap is available only in CHR - charcoal.
- Can be used as left or right connection.

PRODUCT CODE	PRICE	SIZE/INCHES			WEIGHT LBS	VOL FT³
		H	W	D		
BRTADPE5136H24	725	24.63	36	50.50	26.35	6.31
BRTADPE5142H24	745	24.63	42	50.50	27.85	7.36
BRTADPE5148H24	768	24.63	48	50.50	29.35	8.42
BRTADPE5154H24	792	24.63	54	50.50	30.85	9.47
BRTADPE5160H24	815	24.63	60	50.50	32.35	10.52
BRTADPE5166H24	837	24.63	66	50.50	33.85	11.57
BRTADPE5172H24	859	24.63	72	50.50	35.35	12.63
BRTADPE5178H24	881	24.63	78	50.50	36.85	13.68
BRTADPE5184H24	903	24.63	84	50.50	38.35	14.73
BRTADPE6336H24	767	24.63	36	62.50	39.85	7.81
BRTADPE6342H24	790	24.63	42	62.50	41.35	9.11
BRTADPE6348H24	813	24.63	48	62.50	42.85	10.42
BRTADPE6354H24	835	24.63	54	62.50	44.35	11.72
BRTADPE6360H24	858	24.63	60	62.50	45.85	13.02
BRTADPE6366H24	881	24.63	66	62.50	47.35	14.32
BRTADPE6372H24	902	24.63	72	62.50	48.85	15.63
BRTADPE6378H24	924	24.63	78	62.50	50.35	16.93
BRTADPE6384H24	947	24.63	84	62.50	51.85	18.23

BRTADPE-H30 • Back 2 Back Polycarbonate Divider Screen Kit, 30" high

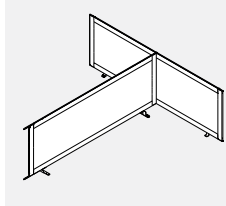

- Provides an extension for privacy in an open plan environment. Intended to always connect to Back 2 Back Divider Screen Kit
- Lightweight and easy to clean table mounted partitions.
- Consists of a powder coated aluminum frame, translucent fluted polycarbonate and all hardware to connect. Brackets are painted steel.
- Side dividers extend 6.25" from the front edge of each surface.
- Center divider sits over the gap between the work surface allowing for the passage of cables to the trough. The gap for each side is approximately 1".
- BRTADPE51-H24 are for 24" deep surfaces and BRTADPE63-H24 are for 30" deep surfaces.
- Width and depth are nominal sizes representing the sizes of the Bridges configuration. Allow for 1/4" overhang at sides and 6 1/4" at front.
- Please choose any standard paint finish for frame and hardware. End trim cap is available only in CHR - charcoal.
- Can be used as left or right connection.

PRODUCT CODE	PRICE	SIZE/INCHES			WEIGHT LBS	VOL FT ³
		H	W	D		
BRTADPE5136H30	796	30.63	36	50.50	28.85	6.31
BRTADPE5142H30	824	30.63	42	50.50	30.35	7.36
BRTADPE5148H30	849	30.63	48	50.50	31.85	8.42
BRTADPE5154H30	875	30.63	54	50.50	33.35	9.47
BRTADPE5160H30	901	30.63	60	50.50	34.85	10.52
BRTADPE5166H30	926	30.63	66	50.50	36.35	11.57
BRTADPE5172H30	953	30.63	72	50.50	37.85	12.63
BRTADPE5178H30	977	30.63	78	50.50	39.35	13.68
BRTADPE5184H30	1003	30.63	84	50.50	40.85	14.73
BRTADPE6336H30	847	30.63	36	62.50	42.35	7.81
BRTADPE6342H30	872	30.63	42	62.50	43.85	9.11
BRTADPE6348H30	899	30.63	48	62.50	45.35	10.42
BRTADPE6354H30	924	30.63	54	62.50	46.85	11.72
BRTADPE6360H30	952	30.63	60	62.50	48.35	13.02
BRTADPE6366H30	975	30.63	66	62.50	49.85	14.32
BRTADPE6372H30	1003	30.63	72	62.50	51.35	15.63
BRTADPE6378H30	1029	30.63	78	62.50	52.85	16.93
BRTADPE6384H30	1054	30.63	84	62.50	54.35	18.23

BRTADP-H24 • Single Table Polycarbonate Divider Screen Kit, 24" high

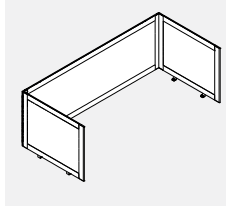

- Provides privacy in an open plan environment.
- Lightweight and easy to clean table mounted partitions.
- Consists of a powder coated aluminum frame, translucent fluted polycarbonate and all hardware to connect. Brackets are painted steel.
- Side dividers extend 6.25" from the front edge of each surface.
- Back divider extends over the back edge of the work surface by 1 1/2" allowing for the passage of cables to the trough.
- BRTADP24-H24 are for 24" deep surfaces and BRTADP30-H24 are for 30" deep surfaces.
- Width and depth are nominal sizes representing the sizes of the Bridges configuration. Allow for 1/4" overhang at the sides, 1 1/2" at the back and 6 1/4" at the front.
- Please choose any standard paint finish for frame and hardware. End trim cap is available only in CHR - charcoal.

PRODUCT CODE	PRICE	SIZE/INCHES			WEIGHT LBS	VOL FT ³
		H	W	D		
BRTADP2436H24	738	24.63	36	31.75	26.55	3.97
BRTADP2442H24	761	24.63	42	31.75	28.10	4.63
BRTADP2448H24	783	24.63	48	31.75	29.65	5.29
BRTADP2454H24	805	24.63	54	31.75	31.20	5.95
BRTADP2460H24	828	24.63	60	31.75	32.75	6.61
BRTADP2466H24	850	24.63	66	31.75	34.30	7.28
BRTADP2472H24	871	24.63	72	31.75	35.85	7.94
BRTADP2478H24	894	24.63	78	31.75	37.40	8.60
BRTADP2484H24	919	24.63	84	31.75	38.95	9.26
BRTADP3036H24	792	24.63	36	37.75	40.50	4.72
BRTADP3042H24	815	24.63	42	37.75	42.05	5.51
BRTADP3048H24	837	24.63	48	37.75	43.60	6.29
BRTADP3054H24	859	24.63	54	37.75	45.15	7.08
BRTADP3060H24	881	24.63	60	37.75	46.70	7.87
BRTADP3066H24	903	24.63	66	37.75	48.25	8.65
BRTADP3072H24	926	24.63	72	37.75	49.80	9.44
BRTADP3078H24	948	24.63	78	37.75	51.35	10.22
BRTADP3084H24	970	24.63	84	37.75	52.90	11.01

BRTADP-H30 • Single Table Polycarbonate Divider Screen Kit, 30" high

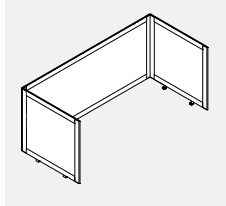

- Provides privacy in an open plan environment.
- Lightweight and easy to clean table mounted partitions.
- Consists of a powder coated aluminum frame, translucent fluted polycarbonate and all hardware to connect. Brackets are painted steel.
- Side dividers extend 6.25" from the front edge of each surface.
- Back divider extends over the back edge of the work surface by 1 1/2" allowing for the passage of cables to the trough.
- BRTADP24-H24 are for 24" deep surfaces and BRTADP30-H24 are for 30" deep surfaces.
- Width and depth are nominal sizes representing the sizes of the Bridges configuration. Allow for 1/4" overhang at the sides, 1 1/2" at the back and 6 1/4" at the front.
- Please choose any standard paint finish for frame and hardware. End trim cap is available only in CHR - charcoal.

PRODUCT CODE	PRICE	SIZE/INCHES			WEIGHT LBS	VOL FT ³
		H	W	D		
BRTADP2436H30	828	30.63	36	31.75	28.85	3.97
BRTADP2442H30	856	30.63	42	31.75	30.35	4.63
BRTADP2448H30	881	30.63	48	31.75	31.85	5.29
BRTADP2454H30	905	30.63	54	31.75	33.35	5.95
BRTADP2460H30	932	30.63	60	31.75	34.85	6.61
BRTADP2466H30	957	30.63	66	31.75	36.35	7.28
BRTADP2472H30	985	30.63	72	31.75	37.85	7.94
BRTADP2478H30	1009	30.63	78	31.75	39.35	8.60
BRTADP2484H30	1034	30.63	84	31.75	40.85	9.26
BRTADP3036H30	879	30.63	36	37.75	42.35	4.72
BRTADP3042H30	905	30.63	42	37.75	43.85	5.51
BRTADP3048H30	931	30.63	48	37.75	45.35	6.29
BRTADP3054H30	956	30.63	54	37.75	46.85	7.08
BRTADP3060H30	983	30.63	60	37.75	48.35	7.87
BRTADP3066H30	1008	30.63	66	37.75	49.85	8.65
BRTADP3072H30	1033	30.63	72	37.75	51.35	9.44
BRTADP3078H30	1059	30.63	78	37.75	52.85	10.22
BRTADP3084H30	1085	30.63	84	37.75	54.35	11.01

BRTADPE-H24 • Single Table Polycarbonate Divider Screen Extension Kit, 24" high

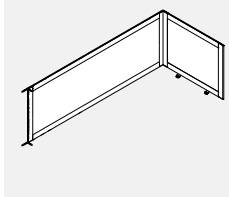

- Provides an extension for privacy in an open plan environment. Intended to always connect to Single Table Divider Screen Kit
- Lightweight and easy to clean table mounted partitions.
- Can be used as left or right connection.
- Consists of a powder coated aluminum frame, translucent fluted polycarbonate and all hardware to connect. Brackets are painted steel.
- Side dividers extend 6.25" from the front edge of each surface.
- Back divider extends over the back edge of the worksurface by 1 1/2" allowing for the passage of cables to the trough.
- BRTADPE24-H24 are for 24" deep surfaces and BRTADPE30-H24 are for 30" deep surfaces.
- Width and depth are nominal sizes representing the sizes of the Bridges configuration. Allow for 1/4" overhang at the sides, 1 1/2" at the back and 6 1/4" at the front.
- Please choose any standard paint finish for frame and hardware. End trim cap is available only in CHR - charcoal.
- Can be used as left or right connection.

PRODUCT CODE	PRICE	SIZE/INCHES			WEIGHT LBS	VOL FT ³
		H	W	D		
BRTADPE2436H24	553	24.63	36	31.75	21.05	3.97
BRTADPE2442H24	608	24.63	42	31.75	22.60	4.63
BRTADPE2448H24	630	24.63	48	31.75	24.15	5.29
BRTADPE2454H24	652	24.63	54	31.75	25.70	5.95
BRTADPE2460H24	674	24.63	60	31.75	27.25	6.61
BRTADPE2466H24	697	24.63	66	31.75	28.80	7.28
BRTADPE2472H24	719	24.63	72	31.75	30.35	7.94
BRTADPE2478H24	741	24.63	78	31.75	31.90	8.60
BRTADPE2484H24	763	24.63	84	31.75	33.45	9.26
BRTADPE3036H24	575	24.63	36	37.75	35.00	4.72
BRTADPE3042H24	629	24.63	42	37.75	36.55	5.51
BRTADPE3048H24	652	24.63	48	37.75	38.10	6.29
BRTADPE3054H24	674	24.63	54	37.75	39.65	7.08
BRTADPE3060H24	697	24.63	60	37.75	41.20	7.87
BRTADPE3066H24	718	24.63	66	37.75	42.75	8.65
BRTADPE3072H24	740	24.63	72	37.75	44.30	9.44
BRTADPE3078H24	763	24.63	78	37.75	45.85	10.22
BRTADPE3084H24	787	24.63	84	37.75	47.40	11.01

BRTADPE-H30 • Single Table Polycarbonate Divider Screen Extension Kit, 30" high

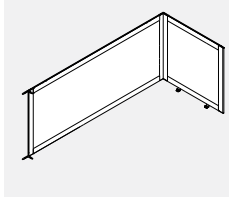

- Provides an extension for privacy in an open plan environment. Intended to always connect to Single Table Divider Screen Kit
- Lightweight and easy to clean table mounted partitions.
- Can be used as left or right connection.
- Consists of a powder coated aluminum frame, translucent fluted polycarbonate and all hardware to connect. Brackets are painted steel.
- Side dividers extend 6.25" from the front edge of each surface.
- Back divider extends over the back edge of the worksurface by 1 1/2" allowing for the passage of cables to the trough.
- BRTADPE24-H24 are for 24" deep surfaces and BRTADPE30-H24 are for 30" deep surfaces.
- Width and depth are nominal sizes representing the sizes of the Bridges configuration. Allow for 1/4" overhang at the sides, 1 1/2" at the back and 6 1/4" at the front.
- Please choose any standard paint finish for frame and hardware. End trim cap is available only in CHR - charcoal.
- Can be used as left or right connection.

PRODUCT CODE	PRICE	SIZE/INCHES			WEIGHT LBS	VOL FT ³
		H	W	D		
BRTADPE2436H30	609	30.63	36	31.75	22.85	3.97
BRTADPE2442H30	667	30.63	42	31.75	24.40	4.63
BRTADPE2448H30	692	30.63	48	31.75	25.95	5.29
BRTADPE2454H30	717	30.63	54	31.75	27.50	5.95
BRTADPE2460H30	743	30.63	60	31.75	29.05	6.61
BRTADPE2466H30	768	30.63	66	31.75	30.60	7.28
BRTADPE2472H30	794	30.63	72	31.75	32.15	7.94
BRTADPE2478H30	821	30.63	78	31.75	33.70	8.60
BRTADPE2484H30	845	30.63	84	31.75	35.25	9.26
BRTADPE3036H30	635	30.63	36	37.75	36.80	4.72
BRTADPE3042H30	692	30.63	42	37.75	38.35	5.51
BRTADPE3048H30	717	30.63	48	37.75	39.90	6.29
BRTADPE3054H30	741	30.63	54	37.75	41.45	7.08
BRTADPE3060H30	768	30.63	60	37.75	43.00	7.87
BRTADPE3066H30	794	30.63	66	37.75	44.55	8.65
BRTADPE3072H30	820	30.63	72	37.75	46.10	9.44
BRTADPE3078H30	845	30.63	78	37.75	47.65	10.22
BRTADPE3084H30	870	30.63	84	37.75	49.20	11.01

BRTADG-H24 • Back 2 Back Glass Divider Screen Kit, 24" high

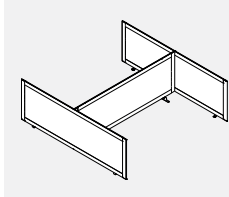

- Provides privacy in an open plan environment.
- Easy to clean table mounted partitions.
- Consists of a powder coated aluminum frame, 4mm clear (CLR) glass and all hardware to connect. Brackets are painted steel.
- Side dividers extend 6.25" from the front edge of each surface.
- Center divider sits over the gap between the worksurface allowing for the passage of cables to the trough. The gap for each side is approximately 1".
- BRTADG51-H24 are for 24" deep surfaces and BRTADG63-H24 are for 30" deep surfaces.
- Width and depth are nominal sizes representing the sizes of the Bridges configuration. Allow for 1/4" overhang at sides and 6 1/4" at front.
- Please choose any standard paint finish for frame and hardware. End trim cap is available only in CHR - charcoal.
- Upcharge for frosted (FRST) glass is 20%

PRODUCT CODE	PRICE	SIZE/INCHES			WEIGHT LBS	VOL FT ³
		H	W	D		
BRTADG5136H24	1389	24.60	36	50.50	33.00	6.31
BRTADG5142H24	1421	24.60	42	50.50	34.50	7.36
BRTADG5148H24	1454	24.60	48	50.50	36.00	8.42
BRTADG5154H24	1488	24.60	54	50.50	37.50	9.47
BRTADG5160H24	1519	24.60	60	50.50	39.00	10.52
BRTADG5166H24	1553	24.60	66	50.50	40.50	11.57
BRTADG5172H24	1585	24.60	72	50.50	42.00	12.63
BRTADG5178H24	1618	24.60	78	50.50	43.50	13.68
BRTADG5184H24	1650	24.60	84	50.50	45.00	14.73
BRTADG6336H24	1519	24.60	36	62.50	46.50	7.81
BRTADG6342H24	1552	24.60	42	62.50	48.00	9.11
BRTADG6348H24	1584	24.60	48	62.50	49.50	10.42
BRTADG6354H24	1617	24.60	54	62.50	51.00	11.72
BRTADG6360H24	1649	24.60	60	62.50	52.50	13.02
BRTADG6366H24	1683	24.60	66	62.50	54.00	14.32
BRTADG6372H24	1714	24.60	72	62.50	55.50	15.63
BRTADG6378H24	1748	24.60	78	62.50	57.00	16.93
BRTADG6384H24	1781	24.60	84	62.50	58.50	18.23

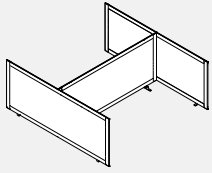
BRTADG-H30 • Back 2 Back Glass Divider Screen Kit, 30" high

- Provides privacy in an open plan environment.
- Easy to clean table mounted partitions.
- Consists of a powder coated aluminum frame, 4mm clear (CLR) glass and all hardware to connect. Brackets are painted steel.
- Side dividers extend 6.25" from the front edge of each surface.
- Center divider sits over the gap between the worksurface allowing for the passage of cables to the trough. The gap for each side is approximately 1".
- BRTADG51-H30 are for 24" deep surfaces and BRTADG63-H30 are for 30" deep surfaces.
- Width and depth are nominal sizes representing the sizes of the Bridges configuration. Allow for 1/4" overhang at sides and 6 1/4" at front.
- Please choose any standard paint finish for frame and hardware. End trim cap is available only in CHR - charcoal.
- Upcharge for frosted (FRST) glass is 20%.

PRODUCT CODE	PRICE	SIZE/INCHES			WEIGHT LBS	VOL FT ³
		H	W	D		
BRTADG5136H30	1467	30.60	36	50.50	35.50	6.31
BRTADG5142H30	1502	30.60	42	50.50	37.00	7.36
BRTADG5148H30	1535	30.60	48	50.50	38.50	8.42
BRTADG5154H30	1568	30.60	54	50.50	40.00	9.47
BRTADG5160H30	1603	30.60	60	50.50	41.50	10.52
BRTADG5166H30	1635	30.60	66	50.50	43.00	11.57
BRTADG5172H30	1656	30.60	72	50.50	44.50	12.63
BRTADG5178H30	1703	30.60	78	50.50	46.00	13.68
BRTADG5184H30	1736	30.60	84	50.50	47.50	14.73
BRTADG6336H30	1647	30.60	36	62.50	49.00	7.81
BRTADG6342H30	1682	30.60	42	62.50	50.50	9.11
BRTADG6348H30	1714	30.60	48	62.50	52.00	10.42
BRTADG6354H30	1749	30.60	54	62.50	53.50	11.72
BRTADG6360H30	1782	30.60	60	62.50	55.00	13.02
BRTADG6366H30	1815	30.60	66	62.50	56.50	14.32
BRTADG6372H30	1835	30.60	72	62.50	58.00	15.63
BRTADG6378H30	1883	30.60	78	62.50	59.50	16.93
BRTADG6384H30	1917	30.60	84	62.50	61.00	18.23

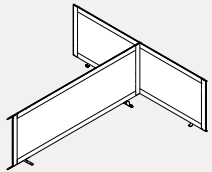
BRTADG-H24 • Back 2 Back Glass Divider Screen Extension Kit, 24" high

- Provides privacy in an open plan environment.
- Easy to clean table mounted partitions.
- Consists of a powder coated aluminum frame, 4mm clear (CLR) glass and all hardware to connect. Brackets are painted steel.
- Side dividers extend 6.25" from the front edge of each surface.
- Center divider sits over the gap between the worksurface allowing for the passage of cables to the trough. The gap for each side is approximately 1".
- BRTADG51-H30 are for 24" deep surfaces and BRTADG63-H30 are for 30" deep surfaces.
- Width and depth are nominal sizes representing the sizes of the Bridges configuration. Allow for 1/4" overhang at sides and 6 1/4" at front.
- Please choose any standard paint finish for frame and hardware. End trim cap is available only in CHR - charcoal.
- Upcharge for frosted (FRST) glass is 20%.
- Can be used as left or right connection.

PRODUCT CODE	PRICE	SIZE/INCHES			WEIGHT LBS	VOL FT ³
		H	W	D		
BRTADGE5136H24	916	24.60	36	50.50	26.35	6.31
BRTADGE5142H24	949	24.60	42	50.50	27.85	7.36
BRTADGE5148H24	982	24.60	48	50.50	29.35	8.42
BRTADGE5154H24	1015	24.60	54	50.50	30.85	9.47
BRTADGE5160H24	1047	24.60	60	50.50	32.35	10.52
BRTADGE5166H24	1080	24.60	66	50.50	33.85	11.57
BRTADGE5172H24	1113	24.60	72	50.50	35.35	12.63
BRTADGE5178H24	1144	24.60	78	50.50	36.85	13.68
BRTADGE5184H24	1177	24.60	84	50.50	38.35	14.73
BRTADGE6336H24	982	24.60	36	62.50	39.85	7.81
BRTADGE6342H24	1013	24.60	42	62.50	41.35	9.11
BRTADGE6348H24	1047	24.60	48	62.50	42.85	10.42
BRTADGE6354H24	1077	24.60	54	62.50	44.35	11.72
BRTADGE6360H24	1111	24.60	60	62.50	45.85	13.02
BRTADGE6366H24	1144	24.60	66	62.50	47.35	14.32
BRTADGE6372H24	1176	24.60	72	62.50	48.85	15.63
BRTADGE6378H24	1209	24.60	78	62.50	50.35	16.93
BRTADGE6384H24	1242	24.60	84	62.50	51.85	18.23

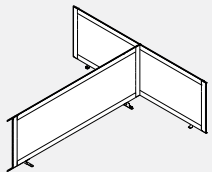
BRTADG-H30 • Back 2 Back Glass Divider Screen Extension Kit, 30" high

- Provides an extension for privacy in an open plan environment. Intended to always connect to Back 2 Back Divider Screen Kit
- Easy to clean table mounted partitions.
- Consists of a powder coated aluminum frame, 4mm clear (CLR) glass and all hardware to connect. Brackets are painted steel.
- Side dividers extend 6.25" from the front edge of each surface.
- Center divider sits over the gap between the worksurface allowing for the passage of cables to the trough. The gap for each side is approximately 1".
- BRTADGE51-H30 are for 24" deep surfaces and BRTADGE63-H30 are for 30" deep surfaces.
- Width and depth are nominal sizes representing the sizes of the Bridges configuration. Allow for 1/4" overhang at sides and 6 1/4" at front.
- Please choose any standard paint finish for frame and hardware. End trim cap is available only in CHR - charcoal.
- Upcharge for frosted (FRST) glass is 20%.
- Can be used as left or right connection.

PRODUCT CODE	PRICE	SIZE/INCHES			WEIGHT LBS	VOL FT ³
		H	W	D		
BRTADGE5136H30	966	30.60	36	50.50	28.85	6.31
BRTADGE5142H30	999	30.60	42	50.50	30.35	7.36
BRTADGE5148H30	1033	30.60	48	50.50	31.85	8.42
BRTADGE5154H30	1067	30.60	54	50.50	33.35	9.47
BRTADGE5160H30	1100	30.60	60	50.50	34.85	10.52
BRTADGE5166H30	1134	30.60	66	50.50	36.35	11.57
BRTADGE5172H30	1154	30.60	72	50.50	37.85	12.63
BRTADGE5178H30	1201	30.60	78	50.50	39.35	13.68
BRTADGE5184H30	1235	30.60	84	50.50	40.85	14.73
BRTADGE6336H30	1032	30.60	36	62.50	42.35	7.81
BRTADGE6342H30	1067	30.60	42	62.50	43.85	9.11
BRTADGE6348H30	1099	30.60	48	62.50	45.35	10.42
BRTADGE6354H30	1133	30.60	54	62.50	46.85	11.72
BRTADGE6360H30	1166	30.60	60	62.50	48.35	13.02
BRTADGE6366H30	1200	30.60	66	62.50	49.85	14.32
BRTADGE6372H30	1221	30.60	72	62.50	51.35	15.63
BRTADGE6378H30	1267	30.60	78	62.50	52.85	16.93
BRTADGE6384H30	1301	30.60	84	62.50	54.35	18.23

BRTADG-H24 • Single Table Glass Divider Screen Kit, 24" high

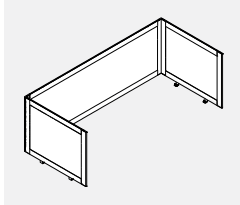

- Provides privacy in an open plan environment.
- Easy to clean table mounted partitions.
- Consists of a powder coated aluminum frame, 4mm clear (CLR) glass and all hardware to connect. Brackets are painted steel.
- Side dividers extend 6.25" from the front edge of each surface.
- Back divider extends over the back edge of the worksurface by 1 1/2" allowing for the passage of cables to the trough.
- BRTADG24-H24 are for 24" deep surfaces and BRTADG30-H24 are for 30" deep surfaces.
- Width and depth are nominal sizes representing the sizes of the Bridges configuration. Allow for 1/4" overhang at the sides, 1 1/2" at the back and 6 1/4" at the front.
- Please choose any standard paint finish for frame and hardware. End trim cap is available only in CHR - charcoal.
- Upcharge for frosted (FRST) glass is 20%.

PRODUCT CODE	PRICE	SIZE/INCHES			WEIGHT LBS	VOL FT ³
		H	W	D		
BRTADG2436H24	1003	24.60	36	31.50	26.55	3.94
BRTADG2442H24	1035	24.60	42	31.50	28.10	4.59
BRTADG2448H24	1068	24.60	48	31.50	29.65	5.25
BRTADG2454H24	1100	24.60	54	31.50	31.20	5.91
BRTADG2460H24	1134	24.60	60	31.50	32.75	6.56
BRTADG2466H24	1165	24.60	66	31.50	34.30	7.22
BRTADG2472H24	1199	24.60	72	31.50	35.85	7.88
BRTADG2478H24	1230	24.60	78	31.50	37.40	8.53
BRTADG2484H24	1264	24.60	84	31.50	38.95	9.19
BRTADG3036H24	1064	24.60	36	37.75	40.50	4.72
BRTADG3042H24	1097	24.60	42	37.75	42.05	5.51
BRTADG3048H24	1131	24.60	48	37.75	43.60	6.29
BRTADG3054H24	1163	24.60	54	37.75	45.15	7.08
BRTADG3060H24	1196	24.60	60	37.75	46.70	7.87
BRTADG3066H24	1228	24.60	66	37.75	48.25	8.65
BRTADG3072H24	1261	24.60	72	37.75	49.80	9.44
BRTADG3078H24	1293	24.60	78	37.75	51.35	10.22
BRTADG3084H24	1327	24.60	84	37.75	52.90	11.01

BRTADG-H30 • Single Table Glass Divider Screen Kit, 30" high

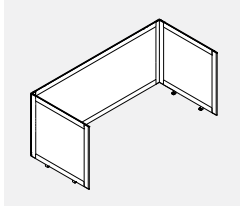

- Provides privacy in an open plan environment.
- Easy to clean table mounted partitions.
- Consists of a powder coated aluminum frame, 4mm clear (CLR) glass and all hardware to connect. Brackets are painted steel.
- Side dividers extend 6.25" from the front edge of each surface.
- Back divider extends over the back edge of the worksurface by 1 1/2" allowing for the passage of cables to the trough.
- BRTADG24-H30 are for 24" deep surfaces and BRTADG30-H30 are for 30" deep surfaces.
- Width and depth are nominal sizes representing the sizes of the Bridges configuration. Allow for 1/4" overhang at the sides, 1 1/2" at the back and 6 1/4" at the front.
- Please choose any standard paint finish for frame and hardware. End trim cap is available only in CHR - charcoal.
- Upcharge for frosted (FRST) glass is 20%.

PRODUCT CODE	PRICE	SIZE/INCHES			WEIGHT LBS	VOL FT ³
		H	W	D		
BRTADG2436H30	1042	30.60	36	31.50	28.85	3.94
BRTADG2442H30	1076	30.60	42	31.50	30.40	4.59
BRTADG2448H30	1110	30.60	48	31.50	31.95	5.25
BRTADG2454H30	1144	30.60	54	31.50	33.50	5.91
BRTADG2460H30	1177	30.60	60	31.50	35.05	6.56
BRTADG2466H30	1212	30.60	66	31.50	36.60	7.22
BRTADG2472H30	1230	30.60	72	31.50	38.15	7.88
BRTADG2478H30	1279	30.60	78	31.50	39.70	8.53
BRTADG2484H30	1313	30.60	84	31.50	41.25	9.19
BRTADG3036H30	1110	30.60	36	37.75	42.80	4.72
BRTADG3042H30	1143	30.60	42	37.75	44.35	5.51
BRTADG3048H30	1176	30.60	48	37.75	45.90	6.29
BRTADG3054H30	1210	30.60	54	37.75	47.45	7.08
BRTADG3060H30	1243	30.60	60	37.75	49.00	7.87
BRTADG3066H30	1279	30.60	66	37.75	50.55	8.65
BRTADG3072H30	1297	30.60	72	37.75	52.10	9.44
BRTADG3078H30	1345	30.60	78	37.75	53.65	10.22
BRTADG3084H30	1379	30.60	84	37.75	55.20	11.01

BRTADGE-H24 • Single Table Glass Divider Screen Extension Kit, 24" high

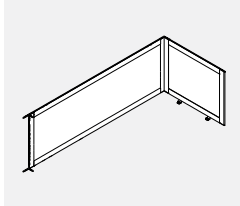

- Provides an extension for privacy in an open plan environment. Intended to always connect to Single Table Divider Screen Kit
- Lightweight and easy to clean table mounted partitions.
- Consists of a powder coated aluminum frame, 4mm clear (CLR) glass and all hardware to connect. Brackets are painted steel.
- Side dividers extend 6.25" from the front edge of each surface.
- Back divider extends over the back edge of the worksurface by 1 1/2" allowing for the passage of cables to the trough.
- BRTADGE24-H24 are for 24" deep surfaces and BRTADGE30-H24 are for 30" deep surfaces.
- Width and depth are nominal sizes representing the sizes of the Bridges configuration. Allow for 1/4" overhang at the sides, 1 1/2" at the back and 6 1/4" at the front.
- Please choose any standard paint finish for frame and hardware. End trim cap is available only in CHR - charcoal.
- Upcharge for frosted (FRST) glass is 20%.
- Can be used as left or right connection.

PRODUCT CODE	PRICE	SIZE/INCHES			WEIGHT LBS	VOL FT ³
		H	W	D		
BRTADGE2436H24	716	24.60	36	31.50	21.05	3.94
BRTADGE2442H24	781	24.60	42	31.50	22.60	4.59
BRTADGE2448H24	815	24.60	48	31.50	24.15	5.25
BRTADGE2454H24	845	24.60	54	31.50	25.70	5.91
BRTADGE2460H24	879	24.60	60	31.50	27.25	6.56
BRTADGE2466H24	910	24.60	66	31.50	28.80	7.22
BRTADGE2472H24	944	24.60	72	31.50	30.35	7.88
BRTADGE2478H24	975	24.60	78	31.50	31.90	8.53
BRTADGE2484H24	1009	24.60	84	31.50	33.45	9.19
BRTADGE3036H24	754	24.60	36	37.75	35.00	4.72
BRTADGE3042H24	817	24.60	42	37.75	36.55	5.51
BRTADGE3048H24	850	24.60	48	37.75	38.10	6.29
BRTADGE3054H24	883	24.60	54	37.75	39.65	7.08
BRTADGE3060H24	915	24.60	60	37.75	41.20	7.87
BRTADGE3066H24	948	24.60	66	37.75	42.75	8.65
BRTADGE3072H24	982	24.60	72	37.75	44.30	9.44
BRTADGE3078H24	1013	24.60	78	37.75	45.85	10.22
BRTADGE3084H24	1047	24.60	84	37.75	47.40	11.01

BRTADGE-H30 • Single Table Glass Divider Screen Extension Kit, 30" high

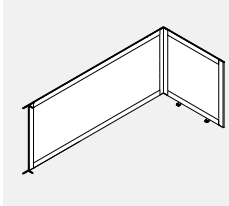

- Provides an extension for privacy in an open plan environment. Intended to always connect to Single Table Divider Screen Kit

- Easy to clean table mounted partitions.
- Consists of a powder coated aluminum frame, 4mm clear (CLR) glass and all hardware to connect. Brackets are painted steel.
- Side dividers extend 6.25" from the front edge of each surface.
- Back divider extends over the back edge of the worksurface by 1 1/2" allowing for the passage of cables to the trough.
- BRTADGE24-H30 are for 24" deep surfaces and BRTADGE30-H30 are for 30" deep surfaces.
- Width and depth are nominal sizes representing the sizes of the Bridges configuration. Allow for 1/4" overhang at the sides, 1 1/2" at the back and 6 1/4" at the front.
- Please choose any standard paint finish for frame and hardware. End trim cap is available only in CHR - charcoal.
- Upcharge for frosted (FRST) glass is 20%.
- Can be used as left or right connection.

PRODUCT CODE	PRICE	SIZE/INCHES			WEIGHT LBS	VOL FT ³
		H	W	D		
BRTADGE2436H30	752	30.60	36	31.50	22.85	3.94
BRTADGE2442H30	818	30.60	42	31.50	24.40	4.59
BRTADGE2448H30	851	30.60	48	31.50	25.95	5.25
BRTADGE2454H30	886	30.60	54	31.50	27.50	5.91
BRTADGE2460H30	920	30.60	60	31.50	29.05	6.56
BRTADGE2466H30	953	30.60	66	31.50	30.60	7.22
BRTADGE2472H30	971	30.60	72	31.50	32.15	7.88
BRTADGE2478H30	1020	30.60	78	31.50	33.70	8.53
BRTADGE2484H30	1055	30.60	84	31.50	35.25	9.19
BRTADGE3036H30	785	30.60	36	37.75	36.80	4.72
BRTADGE3042H30	851	30.60	42	37.75	38.35	5.51
BRTADGE3048H30	884	30.60	48	37.75	39.90	6.29
BRTADGE3054H30	920	30.60	54	37.75	41.45	7.08
BRTADGE3060H30	953	30.60	60	37.75	43.00	7.87
BRTADGE3066H30	986	30.60	66	37.75	44.55	8.65
BRTADGE3072H30	1005	30.60	72	37.75	46.10	9.44
BRTADGE3078H30	1054	30.60	78	37.75	47.65	10.22
BRTADGE3084H30	1088	30.60	84	37.75	49.20	11.01

BRTADF-H24 • Back 2 Back Felt Divider Screen Kit, 24" high

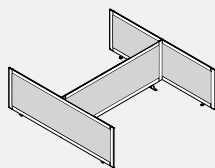

- Provides privacy in an open plan environment.
- Consists of a powder coated aluminum frame, 9mm felt and all hardware to connect. Brackets are painted steel.
- Side dividers extend 6.25" from the front edge of each surface.
- Center divider sits over the gap between the worksurface allowing for the passage of • cables to the trough. The gap for each side is approximately 1".
- BRTADF51-H24 are for 24" deep surfaces and BRTADF63-H24 are for 30" deep surfaces.
- Width and depth are nominal sizes representing the sizes of the Bridges configuration. Allow for 1/4" overhang at sides and 6 1/4" at front.
- Please choose any standard paint finish for frame and hardware. End trim cap is available only in CHR - charcoal.
- 9mm felt material is tackable and comes in a variety of colors.

PRODUCT CODE	PRICE	SIZE/INCHES			WEIGHT LBS	VOL FT ³
		H	W	D		
BRTADF5136H24	890	24.60	36	50.50	28.00	6.31
BRTADF5142H24	905	24.60	42	50.50	29.50	7.36
BRTADF5148H24	923	24.60	48	50.50	31.00	8.42
BRTADF5154H24	936	24.60	54	50.50	32.50	9.47
BRTADF5160H24	957	24.60	60	50.50	34.00	10.52
BRTADF5166H24	974	24.60	66	50.50	35.50	11.57
BRTADF5172H24	992	24.60	72	50.50	37.00	12.63
BRTADF5178H24	1010	24.60	78	50.50	38.50	13.68
BRTADF5184H24	1043	24.60	84	50.50	40.00	14.73
BRTADF6336H24	957	24.60	36	62.50	41.50	7.81
BRTADF6342H24	974	24.60	42	62.50	43.00	9.11
BRTADF6348H24	992	24.60	48	62.50	44.50	10.42
BRTADF6354H24	1009	24.60	54	62.50	46.00	11.72
BRTADF6360H24	1026	24.60	60	62.50	47.50	13.02
BRTADF6366H24	1043	24.60	66	62.50	49.00	14.32
BRTADF6372H24	1060	24.60	72	62.50	50.50	15.63
BRTADF6378H24	1077	24.60	78	62.50	52.00	16.93
BRTADF6384H24	1111	24.60	84	62.50	53.50	18.23

BRTADF-H30 • Back 2 Back Felt Divider Screen Kit, 30" high

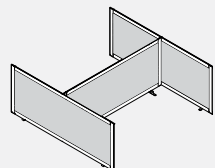

- Provides privacy in an open plan environment.
- Consists of a powder coated aluminum frame, 9mm felt and all hardware to connect. Brackets are painted steel.
- Side dividers extend 6.25" from the front edge of each surface.
- Center divider sits over the gap between the worksurface allowing for the passage of • cables to the trough. The gap for each side is approximately 1".
- BRTADF51-H30 are for 24" deep surfaces and BRTADF63-H30 are for 30" deep surfaces.
- Width and depth are nominal sizes representing the sizes of the Bridges configuration. Allow for 1/4" overhang at sides and 6 1/4" at front.
- Please choose any standard paint finish for frame and hardware. End trim cap is available only in CHR - charcoal.
- 9mm felt material is tackable and comes in a variety of colors.

PRODUCT CODE	PRICE	SIZE/INCHES			WEIGHT LBS	VOL FT ³
		H	W	D		
BRTADF5136H30	890	30.60	36	50.50	30.50	6.31
BRTADF5142H30	905	30.60	42	50.50	32.00	7.36
BRTADF5148H30	923	30.60	48	50.50	33.50	8.42
BRTADF5154H30	936	30.60	54	50.50	35.00	9.47
BRTADF5160H30	957	30.60	60	50.50	36.50	10.52
BRTADF5166H30	974	30.60	66	50.50	38.00	11.57
BRTADF5172H30	992	30.60	72	50.50	39.50	12.63
BRTADF5178H30	1010	30.60	78	50.50	41.00	13.68
BRTADF5184H30	1043	30.60	84	50.50	42.50	14.73
BRTADF6336H30	957	30.60	36	62.50	44.00	7.81
BRTADF6342H30	974	30.60	42	62.50	45.50	9.11
BRTADF6348H30	992	30.60	48	62.50	47.00	10.42
BRTADF6354H30	1009	30.60	54	62.50	48.50	11.72
BRTADF6360H30	1026	30.60	60	62.50	50.00	13.02
BRTADF6366H30	1043	30.60	66	62.50	51.50	14.32
BRTADF6372H30	1060	30.60	72	62.50	53.00	15.63
BRTADF6378H30	1077	30.60	78	62.50	54.50	16.93
BRTADF6384H30	1111	30.60	84	62.50	56.00	18.23

BRTADFE-H24 • Back 2 Back Felt Divider Screen Extension Kit, 24" high

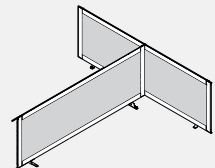

- Provides an extension for privacy in an open plan environment. Intended to always connect to Back 2 Back Divider Screen Kit.
- Consists of a powder coated aluminum frame, 9mm felt and all hardware to connect. Brackets are painted steel.
- Side dividers extend 6.25" from the front edge of each surface.
- Center divider sits over the gap between the worksurface allowing for the passage of • cables to the trough. The gap for each side is approximately 1".
- BRTADFE51-H24 are for 24" deep surfaces and BRTADFE63-H24 are for 30" deep surfaces.
- Width and depth are nominal sizes representing the sizes of the Bridges configuration. Allow for 1/4" overhang at sides and 6 1/4" at front.
- Please choose any standard paint finish for frame and hardware. End trim cap is available only in CHR - charcoal.
- 9mm felt material is tackable and comes in a variety of colors.
- Can be used as left or right connection.

PRODUCT CODE	PRICE	SIZE/INCHES			WEIGHT LBS	VOL FT ³
		H	W	D		
BRTADFE5136H24	605	24.60	36	50.50	23.35	6.31
BRTADFE5142H24	624	24.60	42	50.50	24.85	7.36
BRTADFE5148H24	639	24.60	48	50.50	26.35	8.42
BRTADFE5154H24	658	24.60	54	50.50	27.85	9.47
BRTADFE5160H24	674	24.60	60	50.50	29.35	10.52
BRTADFE5166H24	692	24.60	66	50.50	30.85	11.57
BRTADFE5172H24	710	24.60	72	50.50	32.35	12.63
BRTADFE5178H24	726	24.60	78	50.50	33.85	13.68
BRTADFE5184H24	761	24.60	84	50.50	35.35	14.73
BRTADFE6336H24	638	24.60	36	62.50	36.85	7.81
BRTADFE6342H24	656	24.60	42	62.50	38.35	9.11
BRTADFE6348H24	673	24.60	48	62.50	39.85	10.42
BRTADFE6354H24	691	24.60	54	62.50	41.35	11.72
BRTADFE6360H24	706	24.60	60	62.50	42.85	13.02
BRTADFE6366H24	725	24.60	66	62.50	44.35	14.32
BRTADFE6372H24	741	24.60	72	62.50	45.85	15.63
BRTADFE6378H24	760	24.60	78	62.50	47.35	16.93
BRTADFE6384H24	794	24.60	84	62.50	48.85	18.23

BRTADFE-H30 • Back 2 Back Felt Divider Screen Extension Kit, 30" high

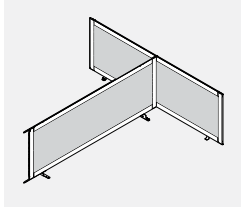

- Provides an extension for privacy in an open plan environment. Intended to always connect to Back 2 Back Divider Screen Kit.

- Consists of a powder coated aluminum frame, 9mm felt and all hardware to connect. Brackets are painted steel.
- Side dividers extend 6.25" from the front edge of each surface.
- Center divider sits over the gap between the worksurface allowing for the passage of • cables to the trough. The gap for each side is approximately 1".
- BRTADFE51-H30 are for 24" deep surfaces and BRTADFE63-H30 are for 30" deep surfaces.
- Width and depth are nominal sizes representing the sizes of the Bridges configuration. Allow for 1/4" overhang at sides and 6 1/4" at front.
- Please choose any standard paint finish for frame and hardware. End trim cap is available only in CHR - charcoal.
- 9mm felt material is tackable and comes in a variety of colors.
- Can be used as left or right connection.

PRODUCT CODE	PRICE	SIZE/INCHES			WEIGHT LBS	VOL FT ³
		H	W	D		
BRTADFE5136H30	605	30.60	36	50.50	25.85	6.31
BRTADFE5142H30	624	30.60	42	50.50	27.35	7.36
BRTADFE5148H30	639	30.60	48	50.50	28.85	7.42
BRTADFE5154H30	658	30.60	54	50.50	30.35	9.47
BRTADFE5160H30	674	30.60	60	50.50	31.85	10.52
BRTADFE5166H30	692	30.60	66	50.50	33.35	11.57
BRTADFE5172H30	710	30.60	72	50.50	34.85	12.63
BRTADFE5178H30	726	30.60	78	50.50	36.35	13.68
BRTADFE5184H30	761	30.60	84	50.50	37.85	14.73
BRTADFE6336H30	638	30.60	36	62.50	39.35	7.81
BRTADFE6342H30	656	30.60	42	62.50	40.85	9.11
BRTADFE6348H30	673	30.60	48	62.50	42.35	10.42
BRTADFE6354H30	691	30.60	54	62.50	43.85	11.72
BRTADFE6360H30	706	30.60	60	62.50	45.35	13.02
BRTADFE6366H30	725	30.60	66	62.50	46.85	14.32
BRTADFE6372H30	741	30.60	72	62.50	48.35	15.63
BRTADFE6378H30	760	30.60	78	62.50	49.85	16.93
BRTADFE6384H30	794	30.60	84	62.50	51.35	18.23

BRTADF-H24 • Single Table Divider Felt Screen Kit, 24" high

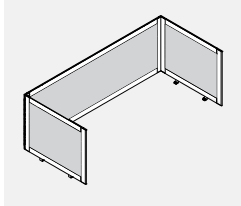

- Provides privacy in an open plan environment.
- Consists of a powder coated aluminum frame, 9mm felt and all hardware to connect. Brackets are painted steel.
- Side dividers extend 6.237" from the front edge of each surface.
- Back divider extends over the back edge of the worksurface by 1 1/2" allowing for the passage of cables to the trough.
- BRTADF24-H24 are for 24" deep surfaces and BRTADF30-H24 are for 30" deep surfaces.
- Width and depth are nominal sizes representing the sizes of the FreeFit Table. Allow for 1/4" overhang at the sides, 1 1/2" at the back and 6.237" at the front.
- Please choose any standard paint finish for frame and hardware. End trim cap is available only in CHR - charcoal.
- 9mm felt material is tackable and comes in a variety of colors.

PRODUCT CODE	PRICE	SIZE/INCHES			WEIGHT LBS	VOL FT ³
		H	W	D		
BRTADF2436H24	647	24.60	36	31.50	22.55	3.94
BRTADF2442H24	663	24.60	42	31.50	24.10	4.59
BRTADF2448H24	681	24.60	48	31.50	25.65	5.25
BRTADF2454H24	699	24.60	54	31.50	27.20	5.91
BRTADF2460H24	716	24.60	60	31.50	28.75	6.56
BRTADF2466H24	733	24.60	66	31.50	30.30	7.22
BRTADF2472H24	751	24.60	72	31.50	31.85	7.88
BRTADF2478H24	767	24.60	78	31.50	33.40	8.53
BRTADF2484H24	802	24.60	84	31.50	34.95	9.19
BRTADF3036H24	669	24.60	36	37.75	36.50	4.72
BRTADF3042H24	688	24.60	42	37.75	38.05	5.51
BRTADF3048H24	703	24.60	48	37.75	39.60	6.29
BRTADF3054H24	722	24.60	54	37.75	41.15	7.08
BRTADF3060H24	738	24.60	60	37.75	41.70	7.87
BRTADF3066H24	756	24.60	66	37.75	44.25	8.65
BRTADF3072H24	773	24.60	72	37.75	45.80	9.44
BRTADF3078H24	790	24.60	78	37.75	47.35	10.22
BRTADF3084H24	825	24.60	84	37.75	48.90	11.01

BRTADF-H30 • Single Table Divider Felt Screen Kit, 30" high

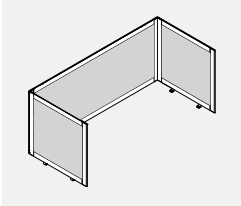

- Provides privacy in an open plan environment.
- Consists of a powder coated aluminum frame, 9mm felt and all hardware to connect. Brackets are painted steel.
- Side dividers extend 6.237" from the front edge of each surface.
- Back divider extends over the back edge of the worksurface by 1 1/2" allowing for the passage of cables to the trough.
- BRTADF24-H30 are for 24" deep surfaces and BRTADF30-H30 are for 30" deep surfaces.
- Width and depth are nominal sizes representing the sizes of the FreeFit Table. Allow for 1/4" overhang at the sides, 1 1/2" at the back and 6.237" at the front.
- Please choose any standard paint finish for frame and hardware. End trim cap is available only in CHR - charcoal.
- 9mm felt material is tackable and comes in a variety of colors.

PRODUCT CODE	PRICE	SIZE/INCHES			WEIGHT LBS	VOL FT ³
		H	W	D		
BRTADF2436H30	647	30.60	36	31.50	24.85	3.94
BRTADF2442H30	663	30.60	42	31.50	26.40	4.59
BRTADF2448H30	681	30.60	48	31.50	27.95	5.25
BRTADF2454H30	699	30.60	54	31.50	29.50	5.91
BRTADF2460H30	716	30.60	60	31.50	31.05	6.56
BRTADF2466H30	733	30.60	66	31.50	32.60	7.22
BRTADF2472H30	751	30.60	72	31.50	34.14	7.88
BRTADF2478H30	767	30.60	78	31.50	34.70	8.53
BRTADF2484H30	802	30.60	84	31.50	37.25	9.19
BRTADF3036H30	669	30.60	36	37.75	38.80	4.72
BRTADF3042H30	688	30.60	42	37.75	40.35	5.51
BRTADF3048H30	703	30.60	48	37.75	41.90	6.29
BRTADF3054H30	722	30.60	54	37.75	43.45	7.08
BRTADF3060H30	738	30.60	60	37.75	45.00	7.87
BRTADF3066H30	756	30.60	66	37.75	46.55	8.65
BRTADF3072H30	773	30.60	72	37.75	48.10	9.44
BRTADF3078H30	790	30.60	78	37.75	49.65	10.22
BRTADF3084H30	825	30.60	84	37.75	51.20	11.01

BRTADFE-H24 • Single Table Felt Divider Screen Extension Kit, 24" high

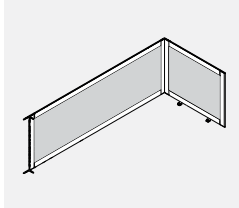

• Provides an extension for privacy in an open plan environment. Intended to always connect to Single Table Divider Screen Kit

- Consists of a powder coated aluminum frame, 9mm felt and all hardware to connect. Brackets are painted steel.
- Side dividers extend 6.237" from the front edge of each surface.
- Back divider extends over the back edge of the worksurface by 1 1/2" allowing for the passage of cables to the trough.
- BRTADFE24-H24 are for 24" deep surfaces and BRTADFE30-H24 are for 30" deep surfaces.
- Width and depth are nominal sizes representing the sizes of the FreeFit Table. Allow for 1/4" overhang at the sides, 1 1/2" at the back and 6.237" at the front.
- Please choose any standard paint finish for frame and hardware. End trim cap is available only in CHR - charcoal.
- 9mm felt material is tackable and comes in a variety of colors.
- Can be used as left or right connection.

PRODUCT CODE	PRICE	SIZE/INCHES			WEIGHT LBS	VOL FT ³
		H	W	D		
BRTADFE2436H24	488	24.60	36	31.50	18.55	3.94
BRTADFE2442H24	536	24.60	42	31.50	20.10	4.59
BRTADFE2448H24	553	24.60	48	31.50	21.65	5.25
BRTADFE2454H24	571	24.60	54	31.50	23.20	5.91
BRTADFE2460H24	589	24.60	60	31.50	24.75	6.56
BRTADFE2466H24	605	24.60	66	31.50	26.30	7.22
BRTADFE2472H24	624	24.60	72	31.50	27.85	7.88
BRTADFE2478H24	639	24.60	78	31.50	29.40	8.53
BRTADFE2484H24	674	24.60	84	31.50	30.95	9.19
BRTADFE3036H24	507	24.60	36	37.75	32.50	4.72
BRTADFE3042H24	556	24.60	42	37.75	34.05	5.51
BRTADFE3048H24	572	24.60	48	37.75	35.60	6.29
BRTADFE3054H24	590	24.60	54	37.75	37.15	7.08
BRTADFE3060H24	607	24.60	60	37.75	38.70	7.87
BRTADFE3066H24	625	24.60	66	37.75	40.25	8.65
BRTADFE3072H24	640	24.60	72	37.75	41.80	9.44
BRTADFE3078H24	659	24.60	78	37.75	43.35	10.22
BRTADFE3084H24	693	24.60	84	37.75	44.90	11.01

BRTADFE-H30 • Single Table Felt Divider Screen Extension Kit, 30" high

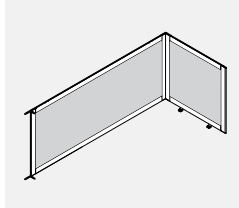

• Provides an extension for privacy in an open plan environment. Intended to always connect to Single Table Divider Screen Kit

- Consists of a powder coated aluminum frame, 9mm felt and all hardware to connect. Brackets are painted steel.
- Side dividers extend 6.237" from the front edge of each surface.
- Back divider extends over the back edge of the worksurface by 1 1/2" allowing for the passage of cables to the trough.
- BRTADFE24-H30 are for 24" deep surfaces and BRTADFE30-H30 are for 30" deep surfaces.
- Width and depth are nominal sizes representing the sizes of the FreeFit Table. Allow for 1/4" overhang at the sides, 1 1/2" at the back and 6.237" at the front.
- Please choose any standard paint finish for frame and hardware. End trim cap is available only in CHR - charcoal.
- 9mm felt material is tackable and comes in a variety of colors.
- Can be used as left or right connection.

PRODUCT CODE	PRICE	SIZE/INCHES			WEIGHT LBS	VOL FT ³
		H	W	D		
BRTADFE2436H30	488	30.60	36	31.50	20.35	3.94
BRTADFE2442H30	536	30.60	42	31.50	21.90	4.59
BRTADFE2448H30	553	30.60	48	31.50	23.45	5.25
BRTADFE2454H30	571	30.60	54	31.50	25.00	5.91
BRTADFE2460H30	589	30.60	60	31.50	26.55	6.56
BRTADFE2466H30	605	30.60	66	31.50	28.10	7.22
BRTADFE2472H30	624	30.60	72	31.50	29.65	7.88
BRTADFE2478H30	639	30.60	78	31.50	31.20	8.53
BRTADFE2484H30	674	30.60	84	31.50	32.75	9.19
BRTADFE3036H30	507	30.60	36	37.75	34.30	4.72
BRTADFE3042H30	556	30.60	42	37.75	35.85	5.51
BRTADFE3048H30	572	30.60	48	37.75	37.40	6.29
BRTADFE3054H30	590	30.60	54	37.75	38.95	7.08
BRTADFE3060H30	607	30.60	60	37.75	40.50	7.87
BRTADFE3066H30	625	30.60	66	37.75	42.05	8.65
BRTADFE3072H30	640	30.60	72	37.75	43.60	9.44
BRTADFE3078H30	659	30.60	78	37.75	45.15	10.22
BRTADFE3084H30	693	30.60	84	37.75	46.70	11.01

BRTADPCPP4 • Back 2 Back Ceiling Feed Pole Kit

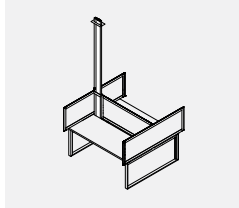

• Ceiling pole brings ceiling feed conduit and data cables from the ceiling to Power Troughs at desk height.

- To be used in conjunction with BRTCF - Bridges Ceiling Feed.
- A two part construction allows for power/data conduit lay-in.
- Includes mounting hardware and ceiling bezel, painted finish.
- Please specify the center divider 6" shorter when using the Ceiling Feed Pole Kit.

PRODUCT CODE	PRICE	SIZE/INCHES			WEIGHT LBS	VOL FT ³
		H	W	D		
BRTADPCPP	275	99	4.75	1.50	13.00	0.48

BRTMKIT • Screen Middle Kit

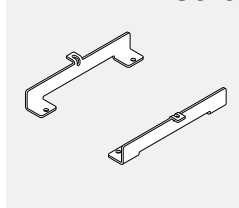

• Kit to be used with Bridges Screen Divider when the End Table Shelf is used.

- During installation, remove the end cap brackets and install the BRTMKIT instead.

PRODUCT CODE	PRICE	SIZE/INCHES			WEIGHT LBS	VOL FT ³
		H	W	D		
BRTMKIT	24	2	2	2	0.50	0.01

Storage Assembly

For a complete storage assembly, one must specify a top, a chassis and legs.

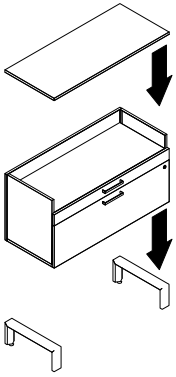

- 1 - BRT29LOBF-U
- 1 - BRTWU
- 2 - BRT-LEGL

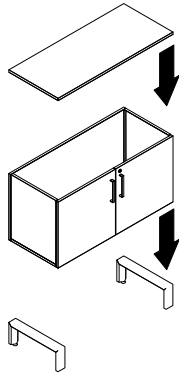

- 1 - BRT29L2D-U
- 1 - BRTWU
- 2 - BRT-LEGL

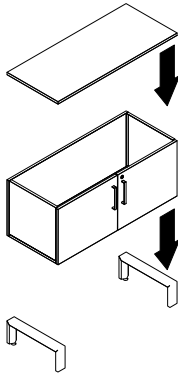

- 1 - BRT25L2D-U
- 1 - BRTWU
- 2 - BRT-LEGL

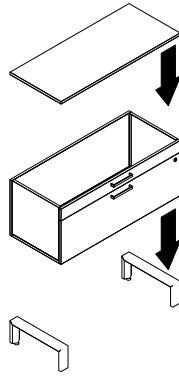

- 1 - BRT25LBF-U
- 1 - BRTWU
- 2 - BRT-LEGL

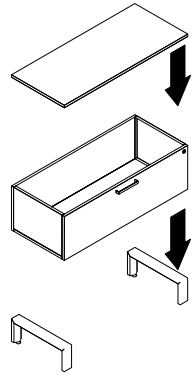

- 1 - BRT21F-U
- 1 - BRTWU
- 2 - BRT-LEGL

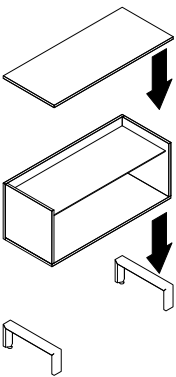
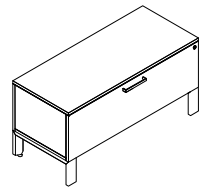
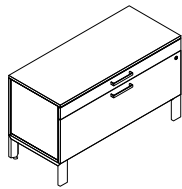
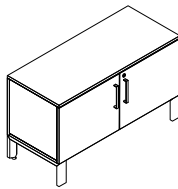
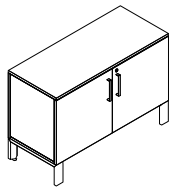
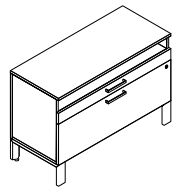

- 1 - BRT25LO-U
- 1 - BRTWU
- 2 - BRT-LEGL

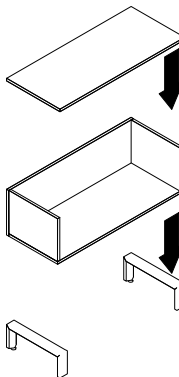

- 1 - BRT21LO-U
- 1 - BRTWU
- 2 - BRTLEGL

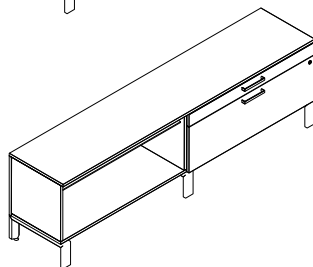
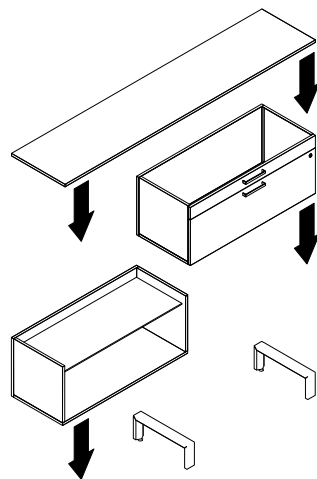

For larger assemblies, legs may be shared.
 1 - BRT25LO-U
 1 - BRT25LBF-U
 1 - BRTWU - ensuring the width of the surface equal the combined width of both storage chassis
 3 - BRT-LEGL

BRT21BF • 21" File Pedestal

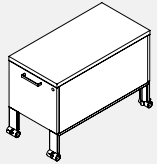
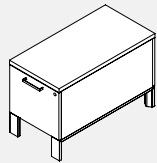

Fits below Bridges tables

- Can join with other 21" high storage units of corresponding depth to form a spine or slides out on casters to serve as an additional worksurface.
- Floor clearance allows for access to panel floor raceway duplex outlets; units on levelers accommodate installation of an optional Cable Basket to manage cords and data cables under storage spine.
- One file drawer (holds letter, legal and A4 suspended file folders except 18" pedestals).
- Optional Cable Basket suspends off storage unit's bottom and manages cables along the horizontal plane. (NO CASTER models only)
- Fits under table beams even with optional seat cushion.
- LP chassis and drawer fronts (specify LP finish) 1" top (specify LP or HP finish); metal handles, powder coated aluminum or anodized aluminum legs specify 5/16x2" levelers or 40mm white/grey, locking casters.
- Anodized aluminum leg upcharge \$55.
- Optional e-lock available in the vertical position. Please specify V-Vertical and add \$224 list.

PRODUCT CODE	PRICE		SIZE/INCHES			WEIGHT VOL	
	LP	HP	H	W	D	LBS	FT ³
Levelers							
BRT21BF18L	710	760	21	15.5	18	58	3.39
BRT21BF24L	825	870	21	15.5	24	64	4.52
BRT21BF30L	903	969	21	15.5	30	72	5.65
Casters							
BRT21BF18C	710	760	21	15.5	18	58	3.39
BRT21BF24C	825	870	21	15.5	24	64	4.52
BRT21BF30C	903	969	21	15.5	30	72	5.65

BRT25BF-L • 25" Box/File Pedestal

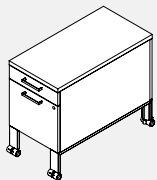
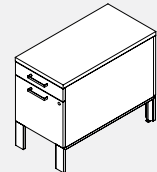

Fits below Bridges tables

- Can join with other 25" high storage units of corresponding depth to form a spine or slides out on casters to serve as an additional worksurface.
- Floor clearance allows for access to panel floor raceway duplex outlets; units on levelers accommodate installation of an optional Cable Basket to manage cords and data cables under storage spine.
- One box drawer, one file drawer (holds letter, legal and A4 suspended file folders except 18" pedestals).
- Optional Cable Basket suspends off storage unit's bottom and manages cables along the horizontal plane. (NO CASTER models only)
- Fits under 30" worksurface table beams as is.
- LP chassis and drawer fronts (specify LP finish) 1" top (specify LP or HP finish); metal handles, powder coated aluminum or anodized aluminum legs specify 5/16x2" levelers or 40mm white/grey, locking casters
- Anodized aluminum leg upcharge \$55.
- Pedestal with cushion will not fit under beam.
- Black injection moulded pencil tray included.
- 25" high Bridges storage should not be used under Back 2 Back Bridges table applications using Below Worksurface Trough. Storage will not fit under the trough.
- Optional e-lock available in the vertical position. Please specify V-Vertical and add \$224 list.

PRODUCT CODE	PRICE		SIZE/INCHES			WEIGHT VOL	
	LP	HP	H	W	D	LBS	FT ³
Levelers							
BRT25BF18L	806	857	25	15.5	18	69	3.89
BRT25BF24L	935	986	25	15.5	24	74	5.02
BRT25BF30L	1019	1082	25	15.5	30	82	6.15
Casters							
BRT25BF18C	870	921	25	15.5	18	69	3.89
BRT25BF24C	1000	1051	25	15.5	24	74	5.02
BRT25BF30C	1082	1146	25	15.5	30	82	6.15

BRT21LS-L/R • 21" Sliding Door Storage

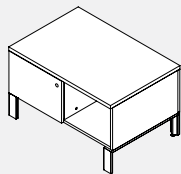

Right Open Shown

Fits below Bridges tables

- Can join with other 21" high storage units to form a spine.
- Can serve as an additional worksurface or an ad-hoc guest seating with optional cushion.
- Floor clearance allows for access to panel floor raceway duplex outlets and for installation of an optional Cable Basket to manage cords and data cables under storage spine.
- Storage compartment internal height: 12.36"
- Sliding door locks on left side.
- Optional 15.5"x18" cushion.
- Optional Cable Basket suspends off storage unit's bottom and manages cables along the horizontal plane.
- LP chassis and sliding door (specify LP finish), 1" top (specify LP or HP finish); metal handles, powder coated aluminum or anodized aluminum legs.
- Anodized aluminum leg upcharge \$55.

PRODUCT CODE	PRICE		SIZE/INCHES			WEIGHT VOL	
	LP	HP	H	W	D	LBS	FT ³
Left							
BRT21LS30L	774	839	21	30	18	53	6.56
BRT21LS36L	857	921	21	36	18	60	7.87
BRT21LS42L	935	1000	21	42	18	67	9.18
Right							
BRT21LS30R	774	839	21	30	18	53	6.56
BRT21LS36R	857	921	21	36	18	60	7.87
BRT21LS42R	935	1000	21	42	18	67	9.18

BRT21LSS-L/R • 21" Shared Sliding Door Storage

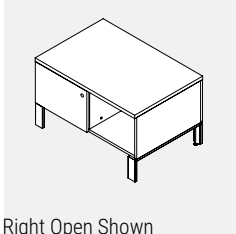

Right Open Shown

- Shared units offer two 11" deep storage compartments on either side - positioned usually beside Bridges table assembly, between two adjacent workstations.
- The units can join with other 21" high, 24" deep storage units to form a storage spine or to serve as an additional return worksurface or an ad-hoc guest seating with optional cushion.
- Floor clearance allows for installation of an optional Cable Basket to manage cords and data cables under storage spine. Storage compartment internal height: 12.36". Sliding door locks on left side.
- Optional 15.5"x18" cushion.
- Optional Cable Basket suspends off storage unit's bottom and manages cables along the horizontal plane.
- LP chassis and sliding door (specify LP finish) 1" top (specify LP or HP finish); metal handles, powder coated aluminum or anodized aluminum legs.
- Anodized aluminum leg upcharge \$55.

PRODUCT CODE	PRICE		SIZE/INCHES			WEIGHT VOL	
	LP	HP	H	W	D	LBS	FT ³
Left							
BRT21LSS30L	1082	1146	21	30	24	69	8.75
BRT21LSS36L	1177	1260	21	36	24	78	10.50
BRT21LSS42L	1277	1373	21	42	24	87	12.25
Right							
BRT21LSS30R	1082	1146	21	30	24	69	8.75
BRT21LSS36R	1177	1260	21	36	24	78	10.50
BRT21LSS42R	1277	1373	21	42	24	87	12.25

BRT21LSO42L • 21" Shared File/Open Storage

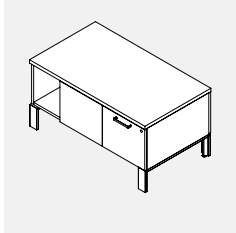

- Shared units offer storage compartments on either side - positioned usually between two adjacent Bridges workstations.
- The units can join with other 21" high, 24" deep storage units to form a storage spine or to serve as an additional return worksurface or an ad-hoc guest seating with optional cushion.
- Floor clearance allows for installation of an optional Cable Basket to manage cords and data cables under storage spine.
- One lockable file drawer, one open compartment per side. Storage compartment internal height without height adjustable shelf: 12.360"
- Optional 15.5" x 18" cushion. Optional Cable Basket suspends off storage unit's bottom manages cables along the horizontal plane.
- LP chassis drawer fronts (specify LP finish) 1" top (specify LP or HP finish); metal handles, powder coated aluminum or anodized aluminum legs.
- Anodized aluminum leg upcharge \$55.
- 25" high Bridges storage should not be used under Back 2 Back Bridges table applications using Below Worksurface Trough. Storage will not fit under the trough.
- Optional e-lock available in the vertical position. Please specify V-Vertical and add \$224 list.

PRODUCT CODE	PRICE		SIZE/INCHES			WEIGHT VOL	
	LP	HP	H	W	D	LBS	FT ³
BRT21LSO42L	1453	1566	21	42	24	124	14.0

BRT25LBF042L • 25" Shared Storage

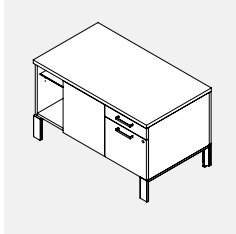

- Shared units offer storage compartments on either side.
- Positioned usually between two adjacent Bridges workstations. The units can join with other 25" high, 24" deep storage units to form a storage spine or to serve as an additional return worksurface.
- Floor clearance allows for installation of an optional Cable Basket to manage cords and data cables under storage spine.
- One lockable file drawer, one box drawer, one open compartment with adjustable shelf per side. Storage compartment internal height without height adjustable shelf: 16.08". Optional 15.5" x 18" cushion.
- Optional Cable Basket suspends off storage unit's bottom and manages cables along the horizontal plane.
- LP chassis and drawer fronts (specify LP finish) 1" top (specify LP or HP finish); metal handles, powder coated aluminum or anodized aluminum legs.
- Anodized aluminum leg upcharge \$55.
- Black injection moulded pencil tray included.
- 25" high Bridges storage should not be used under Back 2 Back Bridges table applications using Below Worksurface Trough. Storage will not fit under the trough.
- Optional e-lock available in the vertical position. Please specify V-Vertical and add \$224 list.

PRODUCT CODE	PRICE		SIZE/INCHES			WEIGHT VOL	
	LP	HP	H	W	D	LBS	FT ³
BRT25LBF042L	1823	1923	25	42	24	154	16.66

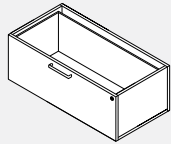
BRT21F-U • 21" High Lateral File Drawer, No Top

- **Fits below Bridges tables.**

- Can join with other 21" high storage units to form a spine.
- Floor clearance allows for access to panel floor raceway duplex outlets and for installation of an optional Cable Basket to manage cords and data cables under storage spine.
- One file drawer, top and legs to be ordered separately.
- LP chassis and drawer front (specify LP finish); metal handles.
- Optional Cable Basket suspends off storage unit's bottom and manages cables along the horizontal plane.
- Optional e-lock available in the vertical position. Please specify V-Vertical and add \$224 list.

PRODUCT CODE	PRICE LP	SIZE/INCHES			WEIGHT VOL	
		H	W	D	LBS	FT ³
BRT21F3018U	763	13	30	18	47	4.06
BRT21F3618U	843	13	36	18	51	4.88
BRT21F4218U	978	13	42	18	56	5.69
BRT21F3024U	781	13	30	24	51	5.42
BRT21F3624U	869	13	36	24	55	6.50
BRT21F4224U	1024	13	42	24	60	7.58

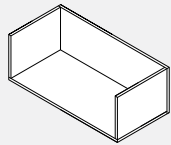
BRT21LO-U • 21" High Open Storage, No Top

- **An open storage unit with no top.**

- Positioned usually beside Bridges table assembly or between two adjacent workstations.
- Can join with other 21" high storage units to form a spine.
- Floor clearance allows for access to panel floor raceway duplex outlets and for installation of an optional Cable Basket to manage cords and data cables under storage spine.
- One box opening, top and legs to be ordered separately.
- LP chassis (specify LP finish).
- Optional Cable Basket suspends off storage unit's bottom and manages cables along the horizontal plane.
- Unit ships knocked down.

PRODUCT CODE	PRICE LP	SIZE/INCHES			WEIGHT VOL	
		H	W	D	LBS	FT ³
BRT21LO3018U	240	13	30	18	25	4.06
BRT21LO3618U	358	13	36	18	29	4.88
BRT21LO4218U	387	13	42	18	32	5.69
BRT21LO3024U	251	13	30	24	29	5.42
BRT21LO3624U	371	13	36	24	33	6.50
BRT21LO4224U	403	13	42	24	36	7.58

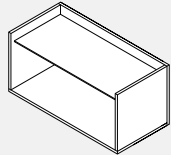
BRT25LO-U • 25" High Open Storage with Glass Shelf, No Top

- **An open storage unit with glass shelf and no top.**

- Positioned usually beside Bridges table assembly or between two adjacent workstations.
- Can join with other 25" high storage units to form a spine.
- Floor clearance allows for access to panel floor raceway duplex outlets and for installation of an optional Cable Basket to manage cords and data cables under storage spine.
- One box opening with glass shelf, top and legs to be ordered separately.
- LP chassis (specify LP finish).
- Optional Cable Basket suspends off storage unit's bottom and manages cables along the horizontal plane.
- 25" high Bridges storage should not be used under Back 2 Back Bridges table applications using Below Worksurface Trough. Storage will not fit under the trough.
- Unit ships knocked down.

PRODUCT CODE	PRICE LP	SIZE/INCHES			WEIGHT VOL	
		H	W	D	LBS	FT ³
BRT25LO3018U	355	17	30	18	40	5.31
BRT25LO3618U	486	17	36	18	46	6.38
BRT25LO4218U	503	17	42	18	52	7.44
BRT25LO3024U	380	17	30	24	44	7.08
BRT25LO3624U	506	17	36	24	50	8.50
BRT25LO4224U	528	17	42	24	56	9.92

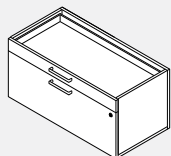
BRT25LBF-U • 25" High Box File Lateral, No Top

- **A box / file storage unit.**

- Positioned usually beside Bridges table assembly or between two adjacent workstations.
- Can join with other 25" high storage units to form a spine.
- Floor clearance allows for access to panel floor raceway duplex outlets and for installation of an optional Cable Basket to manage cords and data cables under storage spine.
- One lockable file drawer, one box drawer, top and legs to be ordered separately.
- LP chassis and drawer fronts (specify LP finish); metal handles.
- Black injection moulded pencil tray included (can be secured inside the drawer anywhere along the perimeter wall).
- 25" high Bridges storage should not be used under Back 2 Back Bridges table applications using Below Worksurface Trough. Storage will not fit under the trough.
- Optional Cable Basket suspends off storage unit's bottom and manages cables along the horizontal plane.
- Optional e-lock available in the vertical position. Please specify V-Vertical and add \$224 list.

PRODUCT CODE	PRICE LP	SIZE/INCHES			WEIGHT VOL	
		H	W	D	LBS	FT ³
BRT25LBF3018U	915	17	30	18	58	5.31
BRT25LBF3618U	1062	17	36	18	79	6.38
BRT25LBF4218U	1133	17	42	18	68	7.44
BRT25LBF3024U	952	17	30	24	62	7.08
BRT25LBF3624U	1104	17	36	24	83	8.50
BRT25LBF4224U	1177	17	42	24	72	9.92

BRT25L2D-U • 25" High Storage Cabinet, No Top

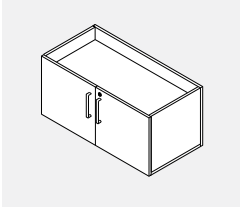

- **A 2 door storage unit.**
- Positioned usually beside Bridges table assembly, between two adjacent workstations.
- The units are level with Bridges tops, can join other 29" high storage units to form a credenza.
- Floor clearance allows for access to panel floor raceway duplex outlets and for installation of an optional Cable Basket to manage cords and data cables under storage spine.
- Two lockable doors, glass shelf included. Top and legs to be ordered separately.
- Storage compartment internal height is 20.5".
- LP chassis and drawer fronts (specify LP finish); metal handles.
- Optional Cable Basket suspends off storage unit's bottom and manages cables along the horizontal plane.
- Optional e-lock available in the horizontal position for the storage cabinet. Please specify HR - Horizontal Right or HL Horizontal Left and add \$224 list.
- Unit ships knocked down.

PRODUCT CODE	PRICE LP	SIZE / INCHES			WEIGHT VOL	
		H	W	D	LBS	FT ³
BRT25L2D3018U	675	17	30	18	39	5.31
BRT25L2D3618U	727	17	36	18	45	6.38
BRT25L2D4218U	757	17	42	18	54	7.44
BRT25L2D3024U	788	17	30	24	43	7.08
BRT25L2D3624U	859	17	36	24	49	8.50
BRT25L2D4224U	893	17	42	24	58	9.92

BRT29L2D-U • 29" High Storage Cabinet, No Top

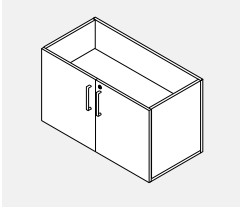

- **A 2 door storage unit.**
- Positioned usually beside Bridges table assembly, between two adjacent workstations.
- The units are level with Bridges tops, can join other 29" high storage units to form a credenza.
- Floor clearance allows for access to panel floor raceway duplex outlets and for installation of an optional Cable Basket to manage cords and data cables under storage spine.
- Two lockable doors, glass shelf included. Top and legs to be ordered separately.
- Storage compartment internal height is 20.5".
- LP chassis and drawer fronts (specify LP finish); metal handles.
- Optional Cable Basket suspends off storage unit's bottom and manages cables along the horizontal plane.
- Optional e-lock available in the horizontal position for the storage cabinet. Please specify HR - Horizontal Right or HL Horizontal Left and add \$224 list.
- Unit ships knocked down.

PRODUCT CODE	PRICE LP	SIZE / INCHES			WEIGHT VOL	
		H	W	D	LBS	FT ³
BRT29L2D3018U	773	21	30	18	49	6.56
BRT29L2D3618U	806	21	36	18	55	7.88
BRT29L2D4218U	842	21	42	18	64	9.19
BRT29L2D3024U	908	21	30	24	53	8.75
BRT29L2D3624U	948	21	36	24	59	10.50
BRT29L2D4224U	969	21	42	24	68	12.25

BRT29LOBF-U • 29" High Box File Open Storage, No Top

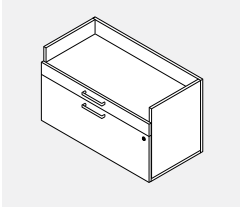

- **Box/file/shelf unit.**
- Positioned usually beside Bridges table assembly, between two adjacent workstations.
- The units are level with Bridges tops, can join other 29" high storage units to form a credenza.
- Floor clearance allows for access to panel floor raceway duplex outlets and for installation of an optional Cable Basket to manage cords and data cables under storage spine.
- One lockable file drawer, one box drawer, one open compartment. Top and legs to be ordered separately.
- Storage compartment internal height: 3.9"
- Black injection moulded pencil tray included (can be secured inside the drawer anywhere along the perimeter wall).
- LP chassis and drawer fronts (specify LP finish); metal handles.
- Optional Cable Basket suspends off storage unit's bottom and manages cables along the horizontal plane.
- Optional e-lock available in the vertical position. Please specify V-Vertical and add \$224 list.

PRODUCT CODE	PRICE LP	SIZE / INCHES			WEIGHT VOL	
		H	W	D	LBS	FT ³
BRT29LOBF3018U	1077	21	30	18	70	6.56
BRT29LOBF3618U	1217	21	36	18	78	7.88
BRT29LOBF4218U	1335	21	42	18	86	9.19
BRT29LOBF3024U	1121	21	30	24	74	8.75
BRT29LOBF3624U	1264	21	36	24	82	10.50
BRT29LOBF4224U	1389	21	42	24	90	12.25

BRT-LEGL • Bridges Leg for Modular Storage

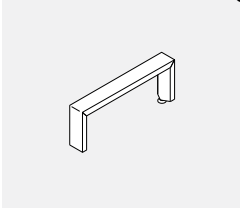

- **Two single legs form the structure of the Bridges series modular storage.**
- A single can be used at the each end of modular storage units or can be used to support where two modular units meet.
- Leveling glides, steel frame, aluminum legs.
- Please specify paint or anodized finish.
- Anodized aluminum leg upcharge \$55.

PRODUCT CODE	PRICE	SIZE / INCHES			WEIGHT VOL	
		H	W	D	LBS	FT ³
BRT18LEGL	48	8	2.5	18	8	1.34
BRT24LEGL	56	8	2.5	24	8	1.34

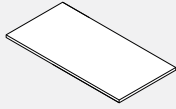
BRTWU • Bridges Worksurface for Modular Storage

- Worksurfaces are available in high pressure laminate (HP 1 1/16" thick) and low pressure laminate (LP 1" thick) with a flat 3 mm edge profile on all sides.
- Worksurfaces provided with pilot holes for alignment purposes.
- Worksurfaces can be used for each modular unit or can span two to three units.

PRODUCT CODE	PRICE		SIZE/INCHES			WEIGHT VOL	
	LP	HP	H	W	D	LBS	FT ³
BRTWU1830	134	178	1	30	18	15	0.50
BRTWU1836	154	204	1	36	18	18	0.59
BRTWU1842	202	270	1	42	18	21	0.68
BRTWU1860	319	410	1	60	18	29	0.97
BRTWU1866	334	439	1	66	18	32	1.10
BRTWU1872	352	464	1	72	18	35	1.20
BRTWU1878	369	488	1	78	18	38	1.30
BRTWU1884	405	530	1	84	18	41	1.40
BRTWU1890	421	551	1	90	18	44	1.50
BRTWU1896	437	573	1	96	18	47	1.60
BRTWU2430	141	184	1	30	24	20	0.65
BRTWU2436	156	207	1	36	24	24	0.78
BRTWU2442	205	272	1	42	24	28	0.90
BRTWU2460	326	430	1	60	24	39	1.30
BRTWU2466	340	449	1	66	24	43	1.41
BRTWU2472	355	470	1	72	24	47	1.54
BRTWU2478	381	501	1	78	24	51	1.70
BRTWU2484	410	537	1	84	24	55	1.80
BRTWU2490	428	561	1	90	24	59	1.90
BRTWU2496	444	583	1	96	24	63	2.00

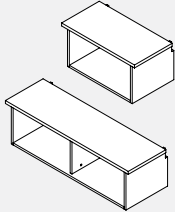
BRTTES • Table Mounted End Shelf

- Single or double open shelf / extended work surface.
- Secured to the end of single or Back 2 Back Bridges table; supported by rectangular legs, all mounting hardware included.
- Storage compartment internal height: 13.25"
- LP chassis (specify LP finish) 1" top (specify LP or HP finish).
- NOTE: not compatible with round legs.
- 25" high Bridges storage should not be used under Back 2 Back Bridges table applications using Below Worksurface Trough. Storage will not fit under the trough.

PRODUCT CODE	PRICE		SIZE/INCHES			WEIGHT VOL	
	LP	HP	H	W	D	LBS	FT ³
BRTTES24	596	646	15	24	15.5	29	3.22
BRTTES30	652	710	15	30	15.5	34	4.03
BRTTES51	1082	1188	15	50.5	15.5	57	6.79
BRTTES63	1188	1323	15	62.5	15.5	68	8.4

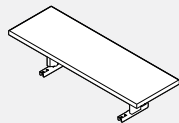
BRTCMS • Centre Mount Shelf

- Open, shared Centre mount shelf 'floats' 6.750" above the gap formed by two back-to-back work surfaces. 12" deep x 30" or 36" laminate shelf surface accepts BRTESBBIN Elevated Shelf Binder Bin - The 30" wide shelf accommodates two, while 36" shelf accommodates up to three BRTESBBIN bins. Shelves overhang the support structure by 6" on either side.
- Aluminum / die cast structure attaches to the underside of both work surfaces.
- Note: Not compatible with BRTETA Above Work Surface Power Trough and Work Surfaces with Access Doors.
- Specify high pressure laminate shelf (HP 1 1/16" thick) or low pressure laminate shelf (LP 1" thick).
- Specify support structure metal finish.
- Anodized support structure finish up charge \$55.

PRODUCT CODE	PRICE		SIZE/INCHES			WEIGHT VOL	
	LP	HP	H	W	D	LBS	FT ³
BRTCMS30	215	245	6.75	30	12	12.60	1.41
BRTCMS36	308	339	6.75	36	12	15.20	1.69

BRTSTS • Single Sided Elevated Table Shelf

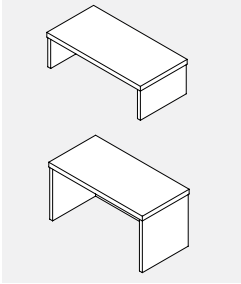

- **Single sided elevated shelf.**
- Secured perpendicularly to the single or Back 2 Back Bridges tables. Integrated anodized aluminum accessory rail. White cut out and accessory rail trims.
- Optional Elevated Shelf Binder Bin rests on top surface - better utilization of vertical space, enhanced sense of privacy.
- Three heights available:
- 8" high provides additional storage space without obstructing view; reaches 16" module height when combined with 8" high Binder Shelf. Internal height 6.6".
- 13" high lines up with 42" floor-standing panels.
- 16" high lines up with top of 16" table dividers (15.8"). Specify 12" narrower Shared Elevated Shelf immediately adjacent to the perpendicular elevated shelf. Internal height 14.6".
- NOTE: In order to prevent interference ensure that the Shared Elevated Shelves immediately adjacent to the perpendicular elevated shelf which are of equal or bigger height are specified 12" narrower than the supporting worksurface.
- Optional Elevated Shelf Binder Bin (BRTESBBIN) rests on top surface - better utilization of vertical space, enhanced sense of privacy.
- See Accessory compatibility chart.

PRODUCT CODE	PRICE		SIZE/INCHES			WEIGHT VOL	
	LP	HP	H	W	D	LBS	FT ³
BRTSTS0824	211	275	8	24	12	14	1.33
BRTSTS0830	242	308	8	30	12	16	1.66
BRTSTS0851	387	485	8	50.5	12	25	2.80
BRTSTS0863	437	583	8	62.5	12	28	3.47
BRTSTS1324	227	290	13	24	12	18	2.16
BRTSTS1330	257	323	13	30	12	21	2.70
BRTSTS1351	387	485	13	50.5	12	32	4.55
BRTSTS1363	451	583	13	62.5	12	38	5.64
BRTSTS1624	257	323	16	24	12	19	2.66
BRTSTS1630	308	372	16	30	12	29	3.33
BRTSTS1651	451	564	16	50.5	12	33	5.61
BRTSTS1663	519	663	16	62.5	12	39	6.94

BRTBTS • Shared Elevated Table Shelf

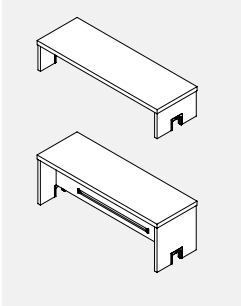

- **Shared, Back 2 Back elevated shelf; rests on Back 2 Back Bridges tables.**
- Cut-outs in both supporting side gables allow placement over Above Worksurface Power/data troughs. Integrated anodized aluminum accessory rail. White cut out and accessory rail trims.
- Three heights available:
- 8" high provides additional storage space without obstructing view; reaches 16" module height when combined with 8" high Binder Shelf. Internal height 6.6".
- 13" high lines up with 42" floor-standing panels.
- 16" high lines up with top of 16" table dividers (15.8"). Specify 12" narrower Shared Elevated Shelf immediately adjacent to the perpendicular elevated shelf. Internal height 14.6".
- NOTE: In order to prevent interference ensure that the Shared Elevated Shelves immediately adjacent to the perpendicular elevated shelf which are of equal or bigger height are specified 12" narrower than the supporting worksurface.
- Optional Elevated Shelf Binder Bin (BRTESBBIN) rests on top surface - better utilization of vertical space, binder/book manager, enhanced sense of privacy, magnetic board on the opposite side.
- LP chassis (specify LP finish); 1" top (specify LP or HP finish).

PRODUCT CODE	PRICE		SIZE/INCHES			WEIGHT VOL	
	LP	HP	H	W	D	LBS	FT ³
BRTBTS0836	323	387	8	36	12	16	2.00
BRTBTS0842	356	420	8	42	12	19	2.33
BRTBTS0848	387	485	8	48	12	21	2.66
BRTBTS0854	405	519	8	54	12	23	3.00
BRTBTS0860	451	583	8	60	12	26	3.33
BRTBTS0866	485	633	8	66	12	28	3.66
BRTBTS0872	519	663	8	72	12	30	4.00
BRTBTS0878	550	710	8	78	12	32	4.33
BRTBTS0884	583	760	8	84	12	35	4.66
BRTBTS1336	387	469	13	36	12	22	3.25
BRTBTS1342	437	519	13	42	12	25	3.79
BRTBTS1348	469	583	13	48	12	28	4.33
BRTBTS1354	519	633	13	54	12	30	4.87
BRTBTS1360	564	677	13	60	12	33	5.86
BRTBTS1366	550	741	13	66	12	36	6.45
BRTBTS1372	646	806	13	72	12	39	6.50
BRTBTS1378	696	857	13	78	12	42	7.04
BRTBTS1384	741	921	13	84	12	44	7.58
BRTBTS1636	405	469	16	36	12	25	4.00
BRTBTS1642	451	550	16	42	12	28	4.66
BRTBTS1648	501	596	16	48	12	31	5.33
BRTBTS1654	532	663	16	54	12	34	6.00
BRTBTS1660	583	710	16	60	12	38	6.66
BRTBTS1666	633	760	16	66	12	41	7.33
BRTBTS1672	677	825	16	72	12	44	8.00
BRTBTS1678	710	870	16	78	12	47	8.66
BRTBTS1684	760	935	16	84	12	50	9.33

BRTBASO48 • Table Supported Shared Overhead

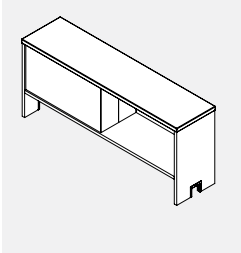

- **One compartment per side; white magnetic back wall; lines up with 50" high floor standing storage.**
- Integrated anodized aluminum accessory rail below the shelves.
- Fits over the gap between two parallel Back 2 Back Bridges tables.
- Fits over above worksurface power/data trough.
- Storage compartment internal height: 12.25".
- Optional Elevated Shelf Binder Bin rests on top surface - better utilization of vertical space, enhanced sense of privacy.
- LP chassis (specify LP finish), white powder-coated steel central partition and backs; 1" top (specify LP or HP finish).

PRODUCT CODE	PRICE		SIZE/INCHES			WEIGHT VOL	
	LP	HP	H	W	D	LBS	FT ³
BRTBASO48	646	741	21	48	12	54	7.00

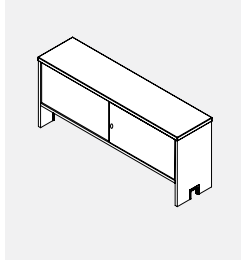
BRTBASL • Shared Elevated Overhead with Sliding Laminate Doors

- **Two compartments facing in opposite direction can be locked with sliding laminate doors. Storage compartment internal height: 12.25**
- Shared elevated overhead fits over the gap between two parallel Bridges Back 2 Back tables.
- Integrated anodized aluminum accessory rail below the storage compartments. Fits over Above Worksurface Power/Data Troughs.
- NOTE: In order to prevent duplex outlet and work surface access door interference, please specify overhead of the same width as the width of the supporting worksurface.

To prevent interference with ceiling feed pole please specify overhead 6" shorter in order width corresponding with the length of the supporting work surface. Elevated Shelf Binder Bins DO NOT work with this overhead. Bottom accessory rail accepts BALT01 Letter Tray, BAMBO1 Media Bin, BAUT01 Utility Tray and BVATH01 Telephone holder.
LP chassis (specify LP finish); 1" top (specify LP or HP finish), satin lock.

PRODUCT CODE	PRICE		SIZE/INCHES			WEIGHT VOL	
	LP	HP	H	W	D	LBS	FT ³
BRTBASL36	1836	1956	21	36	16	23.5	6.56
BRTBASL42	1964	2113	21	42	16	27.5	7.65
BRTBASL48	2066	2242	21	48	16	31.4	8.75
BRTBASL54	2222	2405	21	54	16	35.3	9.84
BRTBASL60	2344	2537	21	60	16	39.3	10.93
BRTBASL66	2646	2868	21	66	16	43.2	12.03
BRTBASL72	2785	3035	21	72	16	47.1	13.12
BRTBASL78	2932	3200	21	78	16	51.0	14.21
BRTBASL84	2970	3340	21	84	16	55.0	15.31

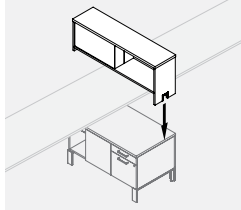
BRTSDS48 • 45" High Shared Storage Divider

- **Divides side-2-side workstations; two shared open shelves**

- One compartment per side; white magnetic back wall. Rests on top of shared 25" box/file/open and Back 2 Back worksurface.
- Top of the unit is 15.7" from the top of the worksurface.
- Storage compartment internal height: 12.8".
- Optional Elevated Shelf Binder Bin (BRTSEBBIN) rests on top surface - better utilization of vertical space, enhanced sense of privacy.
- LP chassis (specify LP finish), white powder-coated steel central partition and backs; 1" top (specify LP or HP finish).

PRODUCT CODE	PRICE		SIZE/INCHES			WEIGHT VOL	
	LP	HP	H	W	D	LBS	FT ³
BRTSDS48	519	613	16	48	12	54	5.33

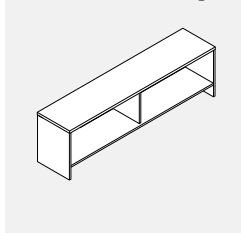
BRT21HO • Open Single Sided Storage

- **Table supported single sided open storage**
- Storage compartment internal height: 14"
- LP chassis (specify LP finish); 1" top (specify LP or HP finish).
- NOTE: Cannot be used in conjunction with above worksurface power trough.
- In order to prevent duplex outlet and work surface access door interference, please specify overhead of the same width as the width of the supporting worksurface.
- To prevent interference with ceiling feed pole please specify overhead 6" shorter width corresponding with the length of the supporting work surface.

PRODUCT CODE	PRICE		SIZE/INCHES			WEIGHT VOL	
	LP	HP	H	W	D	LBS	FT ³
BRT21HO3616	811	919	21	36	16	81	9
BRT21HO4216	871	997	21	42	16	96	10.5
BRT21HO4816	930	1070	21	48	16	100	12
BRT21HO5416	987	1146	21	54	16	124	13.5
BRT21HO6016	1054	1229	21	60	16	134	15
BRT21HO6616	1120	1315	21	66	16	144	16.5
BRT21HO7216	1162	1383	21	72	16	152	18
BRT21HO7816	1250	1480	21	78	16	161	19.5
BRT21HO8416	1300	1546	21	84	16	168	21

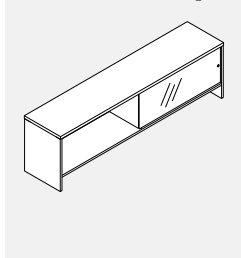
BRT21GS • Open Single Sided Storage with One Sliding Glass Door

- **Table supported single sided open storage, single sliding glass door with recessed pull**
- Storage compartment internal height: 14"
- LP chassis (specify LP finish); 1" top (specify LP or HP finish).
- Not locking.
- Glass is clear.
- NOTE: Cannot be used in conjunction with above worksurface power trough.
- In order to prevent duplex outlet and work surface access door interference, please specify overhead of the same width as the width of the supporting worksurface.
- To prevent interference with ceiling feed pole please specify overhead 6" shorter width corresponding with the length of the supporting work surface.

PRODUCT CODE	PRICE		SIZE/INCHES			WEIGHT VOL	
	LP	HP	H	W	D	LBS	FT ³
BRT21GS3616	1279	1386	21	36	16	87	9
BRT21GS4216	1343	1467	21	42	16	103	10.5
BRT21GS4816	1400	1541	21	48	16	108	12
BRT21GS5416	1671	1830	21	54	16	133	13.5
BRT21GS6016	1736	1915	21	60	16	144	15
BRT21GS6616	1821	2016	21	66	16	155	16.5
BRT21GS7216	1880	2092	21	72	16	164	18
BRT21GS7816	1981	2210	21	78	16	174	19.5
BRT21GS8416	2039	2287	21	84	16	181	21

BRT21LS • Open Single Sided Storage with One Sliding Laminate Door

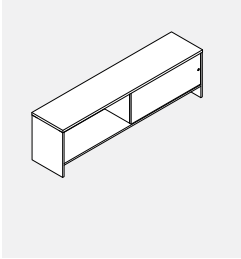

- **Table supported single sided open storage, single sliding laminate door with recessed pull**
- Storage compartment internal height: 14"
- LP chassis (specify LP finish); 1" top (specify LP or HP finish).
- Not locking.
- NOTE: Cannot be used in conjunction with above worksurface power trough.
- In order to prevent duplex outlet and work surface access door interference, please specify overhead of the same width as the width of the supporting worksurface.
- To prevent interference with ceiling feed pole please specify overhead 6" shorter width corresponding with the length of the supporting work surface.

PRODUCT CODE	PRICE		SIZE/INCHES			WEIGHT VOL	
	LP	HP	H	W	D	LBS	FT ³
BRT21LS3616	1241	1392	21	36	16	94	9
BRT21LS4216	1302	1478	21	42	16	111	10.5
BRT21LS4816	1360	1559	21	48	16	117	12
BRT21LS5416	1417	1642	21	54	16	143	13.5
BRT21LS6016	1639	1890	21	60	16	155	15
BRT21LS6616	1707	1981	21	66	16	167	16.5
BRT21LS7216	1757	2056	21	72	16	177	18
BRT21LS7816	1836	2160	21	78	16	188	19.5
BRT21LS8416	1887	2234	21	84	16	198	21

BRT21HDO • Open Double Sided Storage

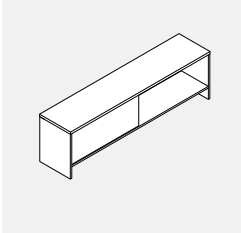

- **Table supported double sided open storage.**
- Fits over the gap between two parallel Bridges Back 2 Back tables.
- Storage compartment internal height: 14"
- LP chassis (specify LP finish); 1" top (specify LP or HP finish)
- NOTE: Cannot be used in conjunction with above worksurface power trough
- In order to prevent duplex outlet and work surface access door interference, please specify overhead of the same width as the width of the supporting worksurface.
- To prevent interference with ceiling feed pole please specify overhead 6" shorter width corresponding with the length of the supporting work surface.

PRODUCT CODE	PRICE		SIZE/INCHES			WEIGHT VOL	
	LP	HP	H	W	D	LBS	FT ³
BRT21HDO3616	842	948	21	36	16	81	9
BRT21HDO4216	890	1013	21	42	16	96	10.5
BRT21HDO4816	931	1074	21	48	16	100	12
BRT21HDO5416	1004	1163	21	54	16	124	13.5
BRT21HDO6016	1056	1230	21	60	16	134	15
BRT21HDO6616	1136	1330	21	66	16	144	16.5
BRT21HDO7216	1173	1386	21	72	16	152	18
BRT21HDO7816	1265	1496	21	78	16	161	19.5
BRT21HDO8416	1301	1549	21	84	16	168	21

BRT21GDS • Double Sided Storage with Sliding Glass Door

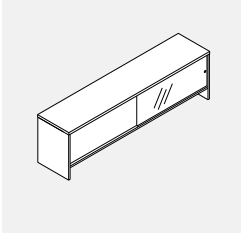

- **Table supported double sided storage with sliding glass doors and recessed pull.**
- Fits over the gap between two parallel Bridges Back 2 Back tables.
- Storage compartment internal height: 14"
- LP chassis (specify LP finish); 1" top (specify LP or HP finish).
- Not Locking
- NOTE: Cannot be used in conjunction with above worksurface power trough
- In order to prevent duplex outlet and work surface access door interference, please specify overhead of the same width as the width of the supporting worksurface.
- To prevent interference with ceiling feed pole please specify overhead 6" shorter width corresponding with the length of the supporting work surface.

PRODUCT CODE	PRICE		SIZE/INCHES			WEIGHT VOL	
	LP	HP	H	W	D	LBS	FT ³
BRT21GDS3616	1661	1766	21	36	16	94	9
BRT21GDS4216	1737	1862	21	42	16	111	10.5
BRT21GDS4816	1778	1918	21	48	16	117	12
BRT21GDS5416	2298	2457	21	54	16	143	13.5
BRT21GDS6016	2341	2517	21	60	16	155	15
BRT21GDS6616	2497	2692	21	66	16	167	16.5
BRT21GDS7216	2552	2762	21	72	16	177	18
BRT21GDS7816	2655	2884	21	78	16	188	19.5
BRT21GDS8416	2826	3075	21	84	16	196	21

BRT21LDS • Double sided Storage with Sliding Laminate Door

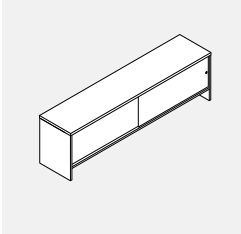

- **Table supported double sided storage with sliding laminate doors and recessed pull.**
- Fits over the gap between two parallel Bridges Back 2 Back tables.
- Storage compartment internal height: 14"
- LP chassis (specify LP finish); 1" top (specify LP or HP finish).
- Not Locking
- NOTE: Cannot be used in conjunction with above worksurface power trough
- In order to prevent duplex outlet and work surface access door interference, please specify overhead of the same width as the width of the supporting worksurface.
- To prevent interference with ceiling feed pole please specify overhead 6" shorter width corresponding with the length of the supporting work surface.

PRODUCT CODE	PRICE		SIZE/INCHES			WEIGHT VOL	
	LP	HP	H	W	D	LBS	FT ³
BRT21LDS3616	1631	1736	21	36	16	106	9
BRT21LDS4216	1734	1859	21	42	16	126	10.5
BRT21LDS4816	1771	1913	21	48	16	134	12
BRT21LDS5416	2212	2371	21	54	16	162	13.5
BRT21LDS6016	2252	2428	21	60	16	176	15
BRT21LDS6616	2401	2596	21	66	16	190	16.5
BRT21LDS7216	2438	2651	21	72	16	203	18
BRT21LDS7816	2530	2759	21	78	16	216	19.5
BRT21LDS8416	2682	2928	21	84	16	227	21

BRTTW50-L/R • Storage Tower with Coat Storage

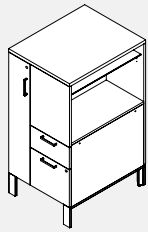

Left Shown

- Provides storage and privacy at the end of a table
- Box+file drawers; open compartment with adjustable shelf (50" high); coat storage with hinged door.
- Specify Left or Right handed.
- Capable of supporting worksurface on one side (built-in threaded inserts to secure dedicated worksurface supporting beam).
- Open side storage compartment internal height: 19.6"
- Optional Cable Basket suspends off storage unit's bottom and manages cables along the horizontal plane.
- LP chassis (specify LP finish), 1" top (specify LP or HP finish); metal handles; powder coated aluminum or anodized aluminum legs (specify paint finish).
- Anodized aluminum leg upcharge \$55.
- Black injection moulded pencil tray included.
- Optional e-lock available in the vertical position for the box, file drawer. Please specify V-Vertical and add \$224 list.
- Optional e-lock available in the horizontal position for the wardrobe. Please specify HR-Horizontal Right or HL-Horizontal Left and add \$224 list.

PRODUCT CODE	PRICE		SIZE/INCHES			WEIGHT VOL	
	LP	HP	H	W	D	LBS	FT ³
BRTTW5024L	1759	1872	50	24	24	142	16.66
BRTTW5024R	1759	1872	50	24	24	142	16.66
BRTTW5030L	1955	2066	50	24	30	163	20.83
BRTTW5030R	1955	2066	50	24	30	163	20.83

BRTTW66-L/R • Storage Tower with Coat Storage

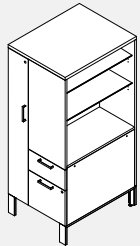

Left Shown

- Provides storage and privacy at the end of a table
- Box+file drawers; open compartment (66" high); coat storage with hinged door and 2 shelves.
- Specify Left or Right handed.
- Capable of supporting worksurface on one side (built-in threaded inserts to secure dedicated worksurface supporting beam).
- Open side storage compartment internal height: 35.6"
- Optional Cable Basket suspends off storage unit's bottom and manages cables along the horizontal plane.
- LP chassis (specify LP finish), 1" top (specify LP or HP finish); metal handles; powder coated aluminum or anodized aluminum legs (specify paint finish).
- Anodized aluminum leg upcharge \$55.
- Black injection moulded pencil tray included.
- Optional e-lock available in the vertical position for the box, file drawer. Please specify V-Vertical and add \$224 list.
- Optional e-lock available in the horizontal position for the wardrobe. Please specify HR-Horizontal Right or HL-Horizontal Left and add \$224 list.

PRODUCT CODE	PRICE		SIZE/INCHES			WEIGHT VOL	
	LP	HP	H	W	D	LBS	FT ³
BRTTW6624L	2287	2433	66	24	24	170	22
BRTTW6624R	2287	2433	66	24	24	170	22
BRTTW6630L	2540	2684	66	24	30	195	27.5
BRTTW6630R	2540	2684	66	24	30	195	27.5

BRTT50-L/R • 50" High Storage Tower

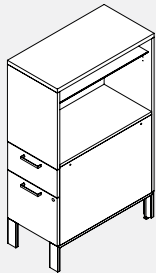

Left Shown

- Provides storage and privacy at the end of a table
- Box+file drawers; open compartment with adjustable glass shelf.
- Specify Left or Right handed.
- Capable of supporting worksurface on one side (built-in threaded inserts to secure dedicated worksurface supporting beam).
- Open side storage compartment internal height: 19.6"
- Optional Cable Basket suspends off storage unit's bottoms and manages cables along the horizontal plane.
- LP chassis (specify LP finish), 1" top (specify LP or HP finish); metal handles; powder coated aluminum or anodized aluminum legs (specify paint finish).
- Anodized aluminum leg upcharge \$55.
- Black injection moulded pencil tray included.
- Optional e-lock available in the vertical position. Please specify V-Vertical and add \$224 list.

PRODUCT CODE	PRICE		SIZE/INCHES			WEIGHT VOL	
	LP	HP	H	W	D	LBS	FT ³
BRTT5024L	1309	1388	50	15.5	24	88	10.76
BRTT5024R	1309	1388	50	15.5	24	88	10.76
BRTT5030L	1438	1533	50	15.5	30	101	13.45
BRTT5030R	1438	1533	50	15.5	30	101	13.45

BRTT66-L/R • 66" High Storage Tower

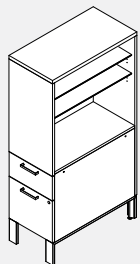

Left Shown

- Provides storage and privacy at the end of a table
- Box+file drawers; open compartment with 2 adjustable glass shelf.
- Specify Left or Right handed.
- Capable of supporting worksurface on one side (built-in threaded inserts to secure dedicated worksurface supporting beam).
- Open side storage compartment internal height: 35.6"
- Optional Cable Basket suspends off storage unit's bottoms and manages cables along the horizontal plane.
- LP chassis (specify LP finish), 1" top (specify LP or HP finish); metal handles; powder coated aluminum or anodized aluminum legs (specify paint finish).
- Anodized aluminum leg upcharge \$55.
- Black injection moulded pencil tray included.
- Optional e-lock available in the vertical position. Please specify V-Vertical and add \$224 list.

PRODUCT CODE	PRICE		SIZE/INCHES			WEIGHT VOL	
	LP	HP	H	W	D	LBS	FT ³
BRTT6624L	1700	1805	66	15.5	24	106	12.91
BRTT6624R	1700	1805	66	15.5	24	106	12.91
BRTT6630L	1869	1995	66	15.5	30	121	16.14
BRTT6630R	1869	1995	66	15.5	30	121	16.14

BRTTW2D50-L/R - 50" High Two Door Storage Tower

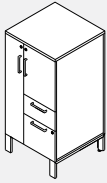

Left Shown

- Provides storage and privacy at the end of a table
- Box+file drawers; closed compartment with one adjustable laminate shelf and hinged door; coat storage with hinged door.
- Specify Left or Right handed.
- Closed side storage compartment internal height: 20.3"
- Optional Cable Basket suspends off storage unit's bottoms and manages cables along the horizontal plane.
- LP chassis (specify LP finish), 1" top (specify LP or HP finish); metal handles; powder coated aluminum or anodized aluminum legs (specify paint finish).
- Anodized aluminum leg upcharge \$55.
- Black injection moulded pencil tray included.
- Optional e-lock available in the vertical position for the box, file drawer. Please specify V-Vertical and add \$224 list.
- Optional e-lock available in the horizontal position for the wardrobe. Please specify HR-Horizontal Right or HL-Horizontal Left and add \$224 list.
- Optional e-lock available in the horizontal position for the closed compartment. Please specify HR-Horizontal Right or HL-Horizontal Left and add \$224 list.

PRODUCT CODE	PRICE		SIZE/INCHES			WEIGHT VOL	
	LP	HP	H	W	D	LBS	FT ³
BRTTW2D5018L	1628	1715	50	24	18	121	12.50
BRTTW2D5018R	1628	1715	50	24	18	121	12.50
BRTTW2D5024L	1826	1938	50	24	24	142	16.67
BRTTW2D5024R	1826	1938	50	24	24	142	16.67
BRTTW2D5030L	2021	2132	50	24	30	163	20.83
BRTTW2D5030R	2021	2132	50	24	30	163	20.83

BRTTW2D66-L/R - 66" High Two Door Storage Tower

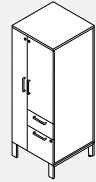

Left Shown

- Provides storage and privacy at the end of a table
- Box+file drawers; closed compartment with two adjustable laminate shelves and hinged door; coat storage with hinged door.
- Specify Left or Right handed.
- Closed side storage compartment internal height: 36.3"
- Anodized aluminum leg upcharge \$55.
- Optional Cable Basket suspends off storage unit's bottoms and manages cables along the horizontal plane.
- LP chassis (specify LP finish), 1" top (specify LP or HP finish); metal handles; powder coated aluminum or anodized aluminum legs (specify paint finish).
- Black injection moulded pencil tray included.
- Optional e-lock available in the vertical position for the box, file drawer. Please specify V-Vertical and add \$224 list.
- Optional e-lock available in the horizontal position for the wardrobe. Please specify HR-Horizontal Right or HL-Horizontal Left and add \$224 list.
- Optional e-lock available in the horizontal position for the closed compartment. Please specify HR-Horizontal Right or HL-Horizontal Left and add \$224 list.

PRODUCT CODE	PRICE		SIZE/INCHES			WEIGHT VOL	
	LP	HP	H	W	D	LBS	FT ³
BRTTW2D6618L	2082	2188	66	24	18	145	16.50
BRTTW2D6618R	2082	2188	66	24	18	145	16.50
BRTTW2D6624L	2354	2499	66	24	24	170	22.00
BRTTW2D6624R	2354	2499	66	24	24	170	22.00
BRTTW2D6630L	2607	2751	66	24	30	195	27.50
BRTTW2D6630R	2607	2751	66	24	30	195	27.50

BRTT1D50-L/R - 50" High Hinged Door Storage Tower

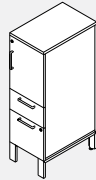

Right Shown

- Provides storage and privacy at the end of a table
- Box+file drawers; closed compartment with one adjustable laminate shelf and hinged door.
- Specify Left or Right handed.
- Closed side storage compartment internal height: 20.3"
- Optional Cable Basket suspends off storage unit's bottoms and manages cables along the horizontal plane.
- LP chassis (specify LP finish), 1" top (specify LP or HP finish); metal handles; powder coated aluminum or anodized aluminum legs (specify paint finish).
- Anodized aluminum leg upcharge \$55.
- Black injection moulded pencil tray included.
- Optional e-lock available in the vertical position for the box, file drawer. Please specify V-Vertical and add \$224 list.
- Optional e-lock available in the horizontal position for the closed compartment. Please specify HR-Horizontal Right or HL-Horizontal Left and add \$224 list.

PRODUCT CODE	PRICE		SIZE/INCHES			WEIGHT VOL	
	LP	HP	H	W	D	LBS	FT ³
BRTT1D5018L	1199	1260	50	15.5	18	110	8.07
BRTT1D5018R	1199	1260	50	15.5	18	110	8.07
BRTT1D5024L	1375	1454	50	15.5	24	131	10.76
BRTT1D5024R	1375	1454	50	15.5	24	131	10.76
BRTT1D5030L	1504	1599	50	15.5	30	152	13.45
BRTT1D5030R	1504	1599	50	15.5	30	152	13.45

BRTT1D66-L/R - 66" High Hinged Door Storage Tower

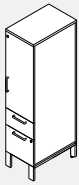

Right Shown

- Provides storage and privacy at the end of a table
- Box+file drawers; closed compartment with two adjustable laminate shelves and hinged door.
- Specify Left or Right handed.
- Closed side storage compartment internal height: 36.3"
- Optional Cable Basket suspends off storage unit's bottoms and manages cables along the horizontal plane.
- LP chassis (specify LP finish), 1" top (specify LP or HP finish); metal handles; powder coated aluminum or anodized aluminum legs (specify paint finish).
- Anodized aluminum leg upcharge \$55.
- Black injection moulded pencil tray included.
- Optional e-lock available in the vertical position for the box, file drawer. Please specify V-Vertical and add \$224 list.
- Optional e-lock available in the horizontal position for the closed compartment. Please specify HR-Horizontal Right or HL-Horizontal Left and add \$224 list.

PRODUCT CODE	PRICE		SIZE/INCHES			WEIGHT VOL	
	LP	HP	H	W	D	LBS	FT ³
BRTT1D6618L	1533	1620	66	15.5	18	134	10.66
BRTT1D6618R	1533	1620	66	15.5	18	134	10.66
BRTT1D6624L	1766	1872	66	15.5	24	159	14.21
BRTT1D6624R	1766	1872	66	15.5	24	159	14.21
BRTT1D6630L	1936	2063	66	15.5	30	184	17.76
BRTT1D6630R	1936	2063	66	15.5	30	184	17.76

BRTW1D-L/R - Hinged Door Wardrobe Tower

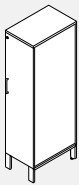

Right Shown

- Provides wardrobe and privacy at the end of a table.
- Specify Left or Right handed.
- Optional Cable Basket suspends off storage unit's bottoms and manages cables along the horizontal plane.
- LP chassis (specify LP finish), 1" top (specify LP or HP finish); metal handles; powder coated aluminum or anodized aluminum legs (specify paint finish).
- Anodized aluminum leg upcharge \$55.
- Optional e-lock available in the horizontal position for the wardrobe. Please specify HR-Horizontal Right or HL-Horizontal Left and add \$224 list.
- 18" unit has coat hooks, 24" and 30" units have a coat rod.

PRODUCT CODE	PRICE		SIZE/INCHES			WEIGHT VOL	
	LP	HP	H	W	D	LBS	FT ³
BRTW1D5018L	924	983	50	15.5	18	105	8.07
BRTW1D5018R	924	983	50	15.5	18	105	8.07
BRTW1D5024L	1047	1123	50	15.5	24	126	10.76
BRTW1D5024R	1047	1123	50	15.5	24	126	10.76
BRTW1D5030L	1174	1271	50	15.5	30	147	13.45
BRTW1D5030R	1174	1271	50	15.5	30	147	13.45
BRTW1D6618L	1169	1228	66	15.5	18	129	10.66
BRTW1D6618R	1169	1228	66	15.5	18	129	10.66
BRTW1D6624L	1323	1399	66	15.5	24	154	14.21
BRTW1D6624R	1323	1399	66	15.5	24	154	14.21
BRTW1D6630L	1481	1575	66	15.5	30	179	17.76
BRTW1D6630R	1481	1575	66	15.5	30	179	17.76

BRTCS45BBFF • Cantilever Storage Open Box, Box, File, Open, File

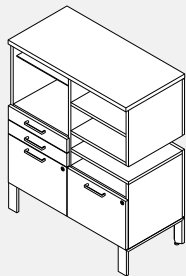

Left Shown

- Provides storage and privacy anywhere along the length of the bench.
- The middle opening of the cabinet allows the upper portion to cantilever above the worksurface
- Two locking file drawers.
- Two pencil drawers not locking.
- Open compartment with adjustable glass shelf, internal dimension of 15.9"
- Three fixed open compartments two above worksurfaces (6.7" interior dimension), one below (3.7" interior dimension)
- Specify Left or Right handed.
- Optional Cable Basket suspends off storage unit's bottoms and manages cables along the horizontal plane.
- LP chassis (specify LP finish), 1" top (specify LP or HP finish); metal handles; powder coated aluminum or anodized aluminum legs (specify paint finish).
- Anodized aluminum leg upcharge \$55.
- Optional e-lock available in the vertical position. Please specify V-Vertical and add \$224 list each.
- Cantilever storage requires two e-locks.

PRODUCT CODE	PRICE		SIZE/INCHES			WEIGHT VOL	
	LP	HP	H	W	D	LBS	FT ³
BRTCS45BBFFL	1978	2079	45	36	18	256	24
BRTCS45BBFFR	1978	2079	45	36	18	256	24

BRTCS45FFF0 • Cantilever Storage Open, File, Open, File, Open

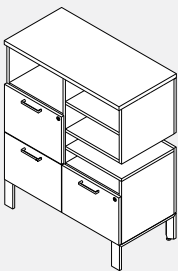

Left Shown

- Provides storage and privacy anywhere along the length of the bench.
- The middle opening of the cabinet allows the upper portion to cantilever above the worksurface
- Three locking file drawers with two locks.
- Open compartment (10.3" interior dimension)
- Three fixed open compartments two above worksurface (6.7" interior dimension), one below (3.7" interior dimension).
- Specify Left or Right handed.
- Optional Cable Basket suspends off storage unit's bottoms and manages cables along the horizontal plane.
- LP chassis (specify LP finish), 1" top (specify LP or HP finish); metal handles; powder coated aluminum or anodized aluminum legs (specify paint finish).
- Anodized aluminum leg upcharge \$55.
- Optional e-lock available in the vertical position. Please specify V-Vertical and add \$224 list each.
- Cantilever storage requires two e-locks.

PRODUCT CODE	PRICE		SIZE/INCHES			WEIGHT VOL	
	LP	HP	H	W	D	LBS	FT ³
BRTCS45FFFOL	2026	2124	45	36	18	256	24
BRTCS45FFFOR	2026	2124	45	36	18	256	24

BRTCS45BBF00 • Cantilever Storage Open, Box, Box, File, Open



Left Shown

- Provides storage and privacy anywhere along the length of the bench.
- The middle opening of the cabinet allows the upper portion to cantilever above the worksurface
- Locking file drawer.
- Two pencil drawers not locking.
- Open compartment (10.3" interior dimension) with adjustable glass shelf.
- Four fixed open compartments two above worksurface (6.7" interior dimension), two below (lower 12.2" interior dimension and upper 3.3" interior dimension)
- Specify Left or Right handed.
- Optional Cable Basket suspends off storage unit's bottoms and manages cables along the horizontal plane.
- LP chassis (specify LP finish), 1" top (specify LP or HP finish); metal handles; powder coated aluminum or anodized aluminum legs (specify paint finish).
- Anodized aluminum leg upcharge \$55.
- Optional e-lock available in the vertical position. Please specify V-Vertical and add \$224 list each.
- Cantilever storage requires one e-lock.

PRODUCT CODE	PRICE		SIZE/INCHES				WEIGHT VOL	
	LP	HP	H	W	D	LBS	FT³	
BRTCS45BBFOOL	1933	2032	45	36	18	256	24	
BRTCS45BBFOOR	1933	2032	45	36	18	256	24	

BRTDS2B2F • Pier Storage unit Box/File, Box/File

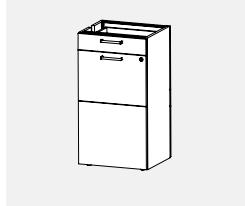

- Supports SideXSide divider with Box File on opposite sides for SideXSide application.
- Two lockable file drawers, two box drawers.
- Black injection moulded pencil tray included (can be secured inside the drawer anywhere along the perimeter wall).
- Optional e-lock available in the vertical position. Please specify V-Vertical and add \$446 list.

PRODUCT CODE	PRICE	SIZE/ INCHES			WEIGHT VOL	
		H	W	D	LBS	FT³
BRTDS2B2F	1271	36	18	16	85	14

BRTDSOP • Pier Storage unit Open with Two glass adjustable shelves

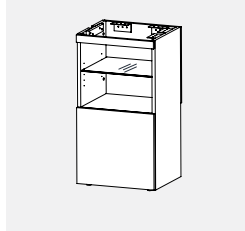

- Supports SideXSide divider with Box File on opposite sides for SideXSide application.
- Storage compartment internal height without height adjustable shelf: 15"

PRODUCT CODE	PRICE	SIZE/ INCHES			WEIGHT VOL	
		H	W	D	LBS	FT³
BRTDSOP	843	36	18	16	75	14

BRTDS2D • Pier Storage unit Hinged Door with Two glass adjustable shelves

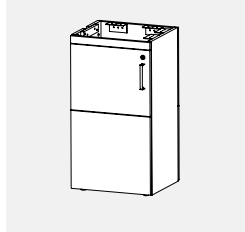

- Supports SideXSide divider with hinged lockable door on opposite sides for SideXSide application.
- Storage compartment internal height without height adjustable shelf: 15"
- Optional e-lock available in the vertical position. Please specify HL HR- Horizontal Left and Right add \$446 list.

PRODUCT CODE	PRICE	SIZE/ INCHES			WEIGHT VOL	
		H	W	D	LBS	FT³
BRTDS2D	1135	36	18	16	79	14

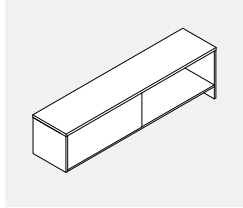
BRT21PHDO • SideXSide Storage - Open Double Sided

- Pier and Table supported SideXSide double sided open storage.
- Divides space and provides storage anywhere along bench or table.
- Storage compartment internal height: 14".
- LP chassis (specify LP finish); 1" top (specify LP or HP finish).

PRODUCT CODE	PRICE		SIZE/INCHES			WEIGHT VOL	
	LP	HP	H	W	D	LBS	FT ³
BRT21PHDO4216	733	858	21	42	16	96	10.5
BRT21PHDO4816	781	923	21	48	16	100	12
BRT21PHDO5416	857	1015	21	54	16	124	13.5
BRT21PHDO6016	903	1081	21	60	16	134	15
BRT21PHDO6616	980	1174	21	66	16	144	16.5
BRT21PHDO7216	1033	1246	21	72	16	152	18

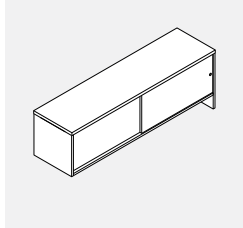
BRT21PLDS • SideXSide Storage - Sliding Laminate Double Sided

- Pier and Table supported SideXSide double sided storage with sliding laminate doors and recessed pull.
- Divides space and provides storage anywhere along bench or table.
- Storage compartment internal height: 14".
- LP chassis (specify LP finish); 1" top (specify LP or HP finish).
- Not Locking

PRODUCT CODE	PRICE		SIZE/INCHES			WEIGHT VOL	
	LP	HP	H	W	D	LBS	FT ³
BRT21PLDS4216	1703	1828	21	42	16	126	11
BRT21PLDS4816	1738	1880	21	48	16	134	12
BRT21PLDS5416	2181	2341	21	54	16	162	14
BRT21PLDS6016	2221	2398	21	60	16	176	15
BRT21PLDS6616	2371	2566	21	66	16	190	17
BRT21PLDS7216	2408	2619	21	72	16	203	18

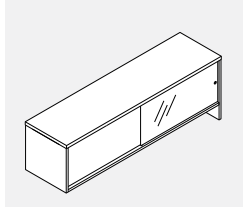
BRT21PGDS • SideXSide Storage - Sliding Glass Double Sided

- Pier and Table supported SideXSide double sided storage with sliding glass doors and recessed pull.
- Divides space and provides storage anywhere along bench or table.
- Storage compartment internal height: 14".
- LP chassis (specify LP finish); 1" top (specify LP or HP finish).

PRODUCT CODE	PRICE		SIZE/INCHES			WEIGHT VOL	
	LP	HP	H	W	D	LBS	FT ³
BRT21PGDS4216	1722	1843	21	42	16	110	10.5
BRT21PGDS4816	1758	1899	21	48	16	116	12
BRT21PGDS5416	2281	2441	21	54	16	141	13.5
BRT21PGDS6016	2322	2498	21	60	16	153	15
BRT21PGDS6616	2477	2671	21	66	16	165	16.5
BRT21PGDS7216	2532	2745	21	72	16	175	18

Panel supporting laterals

- Provide storage and panel support. Full access to Boulevard System 3 bottom raceway cover and power/data outlets. Feet support the front of the unit while a set of brackets (included) secures the unit to Boulevard panels.
- Panel mounting brackets leave 1" deep space between the storage and the panel allowing for easy cable passage behind the storage. Note: that the brackets bring the total depth to 19" (18" deep storage units) from the panel and 24" (23" deep storage units).
- Optional Cable Basket suspends off storage unit's bottom and manages cables along the horizontal plane.
- LP chassis (specify LP finish); 1" top (specify LP or HP finish); metal handles; powder coated aluminum or anodized aluminum legs (specify finish).

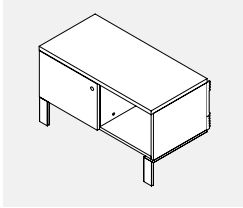
BRTPSLS • Panel Supporting Lateral Sliding Door

- Fits below Bridges tables, can join with other 21" high, 18" and 23" deep storage units along the panel. Can serve as an additional worksurface or an ad-hoc guest seating with optional cushion.
- Storage compartment internal height: 12.36".
- Sliding door locks on left side.
- Anodized aluminum leg upcharge \$55.

PRODUCT CODE	PRICE		SIZE/INCHES			WEIGHT VOL	
	LP	HP	H	W	D	LBS	FT ³
BRTPSLS30	986	1051	21	30	19	53	6.56
BRTPSLS36	1064	1132	21	36	19	60	7.87
BRTPSLS42	1146	1209	21	42	19	67	9.18
BRTPSLS2330	1313	1399	21	30	24	61	8.39
BRTPSLS2336	1420	1505	21	36	24	70	10.06
BRTPSLS2342	1528	1616	21	42	24	79	11.74

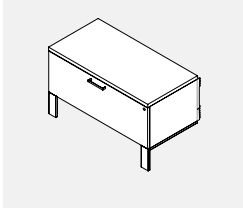
BRTPSL • Panel Supporting Lateral File Drawer

- Fits below Bridges tables, can join with other 21" high, 18" and 23" deep storage units along the panel. Can serve as an additional worksurface or an ad-hoc guest seating with optional cushion.
- One file drawer (holds letter, legal and A4 suspended file folders).
- Anodized aluminum leg upcharge \$55.
- Optional e-lock available in the vertical position. Please specify V-Vertical and add \$224 list.

PRODUCT CODE	PRICE		SIZE/INCHES			WEIGHT VOL	
	LP	HP	H	W	D	LBS	FT ³
BRTPSL30	1019	1033	21	30	19	77	6.56
BRTPSL36	1114	1177	21	36	19	84	7.87
BRTPSL42	1227	1290	21	42	19	92	9.18
BRTPSL2330	1355	1376	21	30	24	86	8.39
BRTPSL2336	1484	1570	21	36	24	95	10.06
BRTPSL2342	1642	1723	21	42	24	104	11.74

BRTP25LO-L • Panel Supporting Open Storage

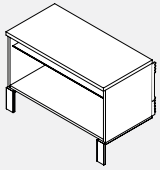

- Fits below Bridges tables, can join with other 25" high, 18" and 23" deep storage units along the panel. Can serve as an additional worksurface or an ad-hoc guest seating with optional cushion.
- Open compartment with glass adjustable shelf. Storage compartment internal height without height adjustable shelf: 15.8"
- Anodized aluminum leg upcharge \$55.

PRODUCT CODE	PRICE		SIZE/INCHES				WEIGHT VOL	
	LP	HP	H	W	D	LBS	FT ³	
BRTP25LO30L	564	677	25	30	19	49	7.81	
BRTP25LO36L	710	774	25	36	19	55	9.37	
BRTP25LO42L	774	857	25	42	19	62	10.93	
BRTP25LO2330L	755	903	25	30	24	59	10.42	
BRTP25LO2336L	947	1033	25	36	24	66	12.50	
BRTP25LO2342L	1033	1140	25	42	24	72	14.58	

BRTPLBF • Panel Supporting Lateral Box/File

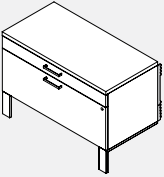

- Fits below Bridges tables, can join with other 25" high, 18" and 23" deep storage units along the panel.
- One lockable file drawer (holds letter, legal and A4 suspended file folders), one box drawer.
- Anodized aluminum leg upcharge \$55.
- Black injection moulded pencil tray included (can be secured inside the drawer anywhere along the perimeter wall).
- Optional e-lock available in the vertical position. Please specify V-Vertical and add \$224 list.

PRODUCT CODE	PRICE		SIZE/INCHES				WEIGHT VOL	
	LP	HP	H	W	D	LBS	FT ³	
BRTPLBF30	1098	1163	25	30	19	88	7.81	
BRTPLBF36	1260	1323	25	36	19	96	9.37	
BRTPLBF42	1373	1453	25	42	19	104	10.93	
BRTPLBF2330	1540	1616	25	30	24	98	10.42	
BRTPLBF2336	1680	1763	25	36	24	107	12.50	
BRTPLBF2342	1830	1936	25	42	24	116	14.58	

BRTP25L2D • Panel Supporting Lateral w/hinged doors

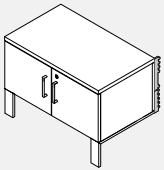

- Fits below Bridges tables, can join with other 25" high, 18" or 23" deep storage units along the panel.
- Can serve as an additional worksurface or an ad-hoc guest seating with optional cushion.
- Two lockable doors
- LP chassis and door fronts (specify LP finish)
- 1" top (specify LP or HP finish); metal handles, powder coated aluminum or anodized aluminum legs. Anodized aluminum leg upcharge \$55.

PRODUCT CODE	PRICE		SIZE/INCHES				WEIGHT VOL	
	LP	HP	H	W	D	LBS	FT ³	
BRTP25L2D30	870	955	25	30	19	69	7.81	
BRTP25L2D36	941	1038	25	36	19	78	9.38	
BRTP25L2D42	987	1102	25	42	19	90	10.94	
BRTP25L2D3024	997	1109	25	30	24	75	10.42	
BRTP25L2D3624	1081	1214	25	36	24	84	12.50	
BRTP25L2D4224	1162	1279	25	42	24	96	14.58	

BRTC • Cushion

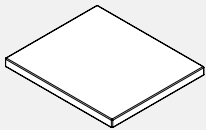

- Optional seat cushion may be added to any storage component.

PRODUCT CODE	SIZE/ INCHES			WEIGHT VOL		
	H	W	D	LBS	FT ³	
BRTC	1.25	15.5	18	1	0.41	

PRODUCT CODE	PRICE										
	GR1	GR2	GR3	GR4	GR5	GR6	GR7	GR8	GR9	GR10	GR20
BRTC	187	220	245	278	329	373	420	464	509	560	
BRTC	625	718	806	898	1099	1299	1502	1702	1902	2126	

Bridges Collaborative Seating

Bridges collaborative seating collection consists of seating, privacy screens, tables, tablets and power. It is a versatile modular furniture series which can be configured into many space planning scenarios including corner, in-line, open concept, traditional reception as well as secluded seating with high privacy partitions.

Furniture pieces can be used as stand alone items or can be mechanically linked together to form a variety of seating configurations.

Seat and backrest can be integrated with Bridges tables, as well as Boulevard panels.

Corner tables and in-line 6" table modules double as power delivery centers.

Dedicated seat backrests feature dual USB charging port.

Some Inline 6" table modules are furnished with grommets to support tablets.

Legs are available in standard Bridges metal painted finishes and anodized aluminum finish.

Bridges Collaborative Seating upholstery features a single stitch, thick white thread around the edges. The white, wide stitch along with crisp corners are part of its distinctive personality. In order to achieve crisp edges and to minimize "pillow" effect caused by taut fabric, the upholstery material has been applied deliberately loose, which may, over time, produce puckering of the upholstery surface material. This can be easily corrected by stretching the fabric by hand or during vacuuming.

In order to efficiently utilize fabric yield all 60" seats and backs feature a seam in the middle. The double stitch seam is sewn with a thin thread, closely matching the upholstery material in colour.

Some complicated fabric patterns prevent pattern matching and will be upholstered without the seam at the discretion of the factory.

Should you require no middle seam by cutting into the roll, please specify "NO SEAM" at time of your order.

• COM yardage is an estimate only. More accurate yardage will be dependent on the width of the fabric and on the repeat pattern.

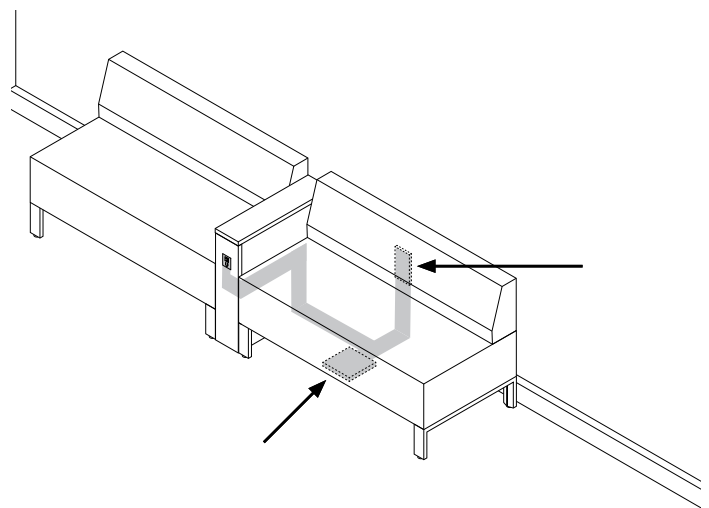
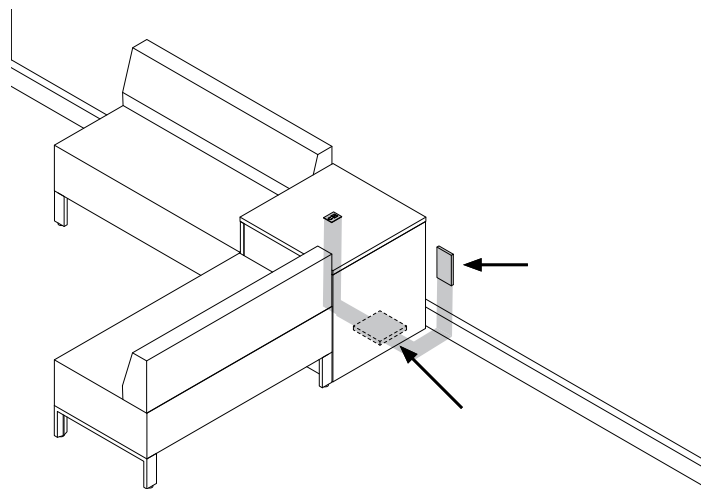
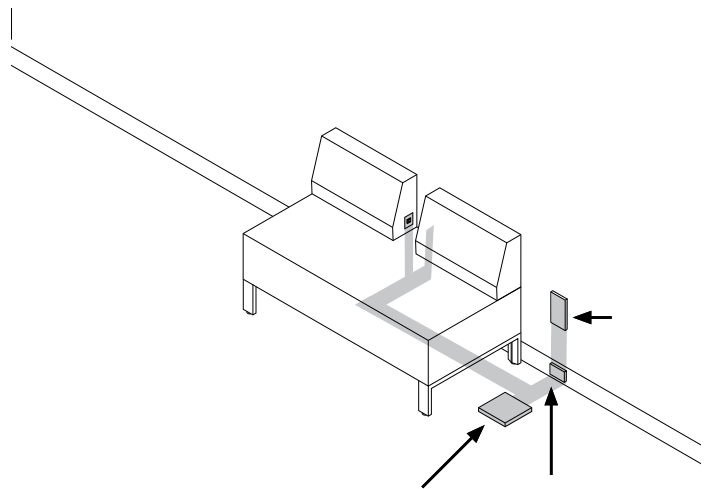

BRTST24-F • Low Table

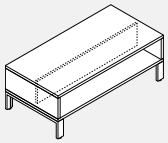

- Freestanding 17" high tables.
- Central partition divides space under top surface into two 11" deep compartments. All LP chassis w/ HP or LP top (3mm edging). Bridges storage aluminum leg.
- Specify chassis and top finish, specify metal leg finish. Add \$55 for anodized aluminum leg finish.
- To convert to mobile, please add \$36 list and an "M" at the end of the product code.

PRODUCT CODE	PRICE			SIZE/INCHES			WEIGHT	VOL
	LP	HP		H	W	D	LBS	FT ³
BRTST2424F	462	537		17	24	24	40.7	5.67
BRTST2448F	652	845		17	48	24	69.0	11.33
BRTST2460F	730	999		17	60	24	83.6	14.17

BRTSE-NB • Lounge Seat

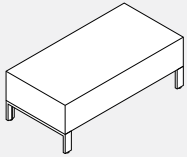

- Fully upholstered armless lounge seat with metal base.
- Seats can be freestanding or linked with optional interlocking bracket kit.
- Specify seating fabric and leg finish.
- Add \$55 for anodized aluminum leg finish.

PRODUCT CODE	SIZE/INCHES			WEIGHT	VOL	YRDS
	H	W	D	LBS	FT ³	(COM)
BRTSE24NB	17	24	24	22.7	5.57	1.25
BRTSE48NB	17	48	24	36.9	11.33	2.00
BRTSE60NB	17	60	24	47.0	14.17	2.50

PRODUCT CODE	PRICE										
	GR1	GR2	GR3	GR4	GR5	GR6	GR7	GR8	GR9	GR10	
BRTSE24NB	652	697	732	774	839	899	958	1015	1076	1140	
BRTSE48NB	1191	1262	1317	1386	1488	1584	1681	1767	1867	1969	
BRTSE60NB	1378	1467	1537	1621	1750	1871	1990	2101	2224	2352	
GRADE	GR11	GR12	GR13	GR14	GR15	GR16	GR17	GR18	GR19	GR20	
BRTSE24NB	1224	1343	1460	1580	1840	2101	2364	2626	2886	3175	
BRTSE48NB	2105	2295	2484	2670	3092	3508	3928	4348	4764	5225	
BRTSE60NB	2522	2759	2992	3227	3754	4275	4802	5324	5845	6421	

BRTSE-B • Lounge Seat with Backrest

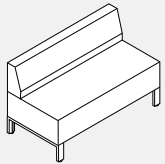

- Fully upholstered armless lounge seat with full backrest and metal base.
- Backrests are permanently secured to the seats and cannot be reconfigured on site.
- Seats can be freestanding or linked with optional interlocking bracket kit.
- Specify seating fabric and leg finish.
- Add \$55 for anodized aluminum leg finish.

PRODUCT CODE	SIZE/INCHES			WEIGHT	VOL	YRDS
	H	W	D	LBS	FT ³	(COM)
BRTSE2424B		24	24	33.0	9.57	2.25
BRTSE4848B		48	24	55.5	19.33	3.50
BRTSE6060B		60	24	70.0	24.17	4.50

PRODUCT CODE	PRICE										
	GR1	GR2	GR3	GR4	GR5	GR6	GR7	GR8	GR9	GR10	
BRTSE2424B	1030	1109	1170	1249	1364	1471	1581	1680	1790	1904	
BRTSE4848B	1901	2025	2123	2242	2421	2589	2758	2911	3086	3266	
BRTSE6060B	2203	2363	2488	2641	2870	3089	3307	3505	3727	3958	
GRADE	GR11	GR12	GR13	GR14	GR15	GR16	GR17	GR18	GR19	GR20	
BRTSE2424B	2056	2273	2484	2694	3167	3633	4109	4579	5046	5568	
BRTSE4848B	3502	3835	4160	4489	5229	5953	6692	7426	8153	8962	
BRTSE6060B	4261	4687	5110	5531	6479	7414	8363	9306	10241	11283	

BRTSE-BL/R • Lounge Seat, Single 24" Offset Backrest

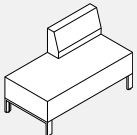

Right Hand Shown

- Fully upholstered armless lounge seat with one backrest and metal base.
- Specify backrest as either Left or Right side. Backrests are permanently secured to the bench and cannot be reconfigured on site.
- Seats can be free-standing or linked with optional interlocking bracket kit.
- Specify seating fabric and leg finish.
- Add \$55 for anodized aluminum leg finish.

PRODUCT CODE	SIZE/INCHES			WEIGHT	VOL	YRDS
	H	W	D	LBS	FT ³	(COM)
BRTSE2448BL	48	24	24	46.10	19.33	3.00
BRTSE2448BR	48	24	24	46.10	19.33	3.00

PRODUCT CODE	PRICE										
	GR1	GR2	GR3	GR4	GR5	GR6	GR7	GR8	GR9	GR10	
BRTSE2448BL	1568	1672	1757	1858	2012	2156	2301	2432	2582	2735	
BRTSE2448BR	1568	1672	1757	1858	2012	2156	2301	2432	2582	2735	
GRADE	GR11	GR12	GR13	GR14	GR15	GR16	GR17	GR18	GR19	GR20	
BRTSE2448BL	2936	3224	3506	3785	4417	5041	5675	6302	6926	7619	
BRTSE2448BR	2936	3224	3506	3785	4417	5041	5675	6302	6926	7619	

BRTSE-BODL/R • Lounge Seat, Two 24" Offset Backrest

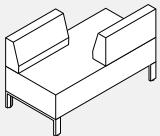

Left Hand Shown

- Fully upholstered armless lounge seat with two offset backrests and metal base.
- Specify either Left or Right backrest configuration. Backrests are permanently secured to the bench and cannot be reconfigured on site.
- Seats can be freestanding or linked with optional interlocking bracket kit.
- Specify seating fabric and leg finish.
- Add \$55 for anodized aluminum leg finish.

PRODUCT CODE	SIZE/INCHES			WEIGHT	VOL	YRDS
	H	W	D	LBS	FT ³	(COM)
BRTSE2448BODL	29	48	24	46.10	19.33	4.00
BRTSE2448BODR	29	48	24	46.10	19.33	4.00

PRODUCT CODE	PRICE										
	GR1	GR2	GR3	GR4	GR5	GR6	GR7	GR8	GR9	GR10	
BRTSE2448BODL	1944	2085	2196	2331	2536	2728	2922	3098	3296	3502	
BRTSE2448BODR	1944	2085	2196	2331	2536	2728	2922	3098	3296	3502	
GRADE	GR11	GR12	GR13	GR14	GR15	GR16	GR17	GR18	GR19	GR20	
BRTSE2448BODL	3771	4151	4527	4901	5743	6576	7417	8256	9087	10011	
BRTSE2448BODR	3771	4151	4527	4901	5743	6576	7417	8256	9087	10011	

BRTSE-EBL/R • Lounge Seat, Single 21" Wide Backrest with USB

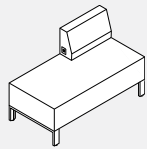

Right Hand Shown

- Fully upholstered armless lounge seat with one backrest and metal base.

- 21" wide backrest come with embedded dual USB port in its side. Note: the side mounted power/USB outlets always point to the centre of the seat. Each USB outlet offers 2 amps. AC/DC transformer plugs into the wall or floor monument (approximately 4' long cable available from the bottom of the seat). Transformer power consumption: 0.68 amps.

- Specify either Left or Right backrest configuration. Backrests are permanently secured to the bench and cannot be reconfigured on site.
- Seats can be freestanding or linked with optional interlocking bracket kit.

	PRODUCT CODE	PRICE									
		GR1	GR2	GR3	GR4	GR5	GR6	GR7	GR8	GR9	GR10
• White USB outlets.	BRTSE2148EBL	1816	1923	2005	2107	2259	2404	2550	2682	2831	2984
• Specify seating fabric and leg finish.	BRTSE2148EBR	1816	1923	2005	2107	2259	2404	2550	2682	2831	2984
• Add \$55 for anodized aluminum leg finish.	BRTSE2148EBL	3187	3474	3753	4035	4666	5290	5921	6549	7173	7867
	BRTSE2148EBR	3187	3474	3753	4035	4666	5290	5921	6549	7173	7867

PRODUCT CODE	SIZE/INCHES			WEIGHT LBS	VOL FT ³	YRDS (COM)
	H	W	D			
BRTSE2148EBL	29	48	24	46.10	19.33	3.00
BRTSE2148EBR	29	48	24	46.10	19.33	3.00

BRTSE-E2B • Lounge Seat, two 21" Wide Backrests with USB

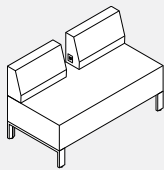

- Fully upholstered armless lounge seat with two backrests, each with dual USB outlet and metal base.

- Both 21" wide backrests come with embedded dual USB port in its side. Note: the side mounted power/USB outlets always point to the centre of the seat. Each USB outlet offers 2 amps. AC/DC transformer plugs into the wall or floor monument (about 52" long cable available from the bottom of the seat). Transformer power consumption: 0.68 amps.

- Backrests are permanently secured to the bench and cannot be reconfigured on site.
- Seats can be freestanding or linked with optional interlocking bracket kit.
- Specify seating fabric and leg finish.
- USB outlets are white.

	PRODUCT CODE	PRICE									
		GR1	GR2	GR3	GR4	GR5	GR6	GR7	GR8	GR9	GR10
• Add \$55 for anodized aluminum leg finish.	BRTSE2148E2B	2442	2582	2694	2828	3034	3226	3420	3595	3794	3997
	BRTSE2148E2B	4268	4649	5024	5399	6241	7073	7915	8754	9584	10509

PRODUCT CODE	SIZE/INCHES			WEIGHT LBS	VOL FT ³	YRDS (COM)
	H	W	D			
BRTSE2148E2B	29	48	24	57.00	19.33	4.00

BRTSE-EBODL/R • Lounge Seat Two USB backrests Offset

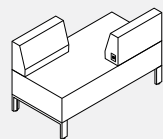

Left Hand Shown

- Fully upholstered armless lounge seat with two offset backrests, each with dual USB outlet and metal base.

- Both 21" wide backrests come with embedded dual USB port in its side.

- Note: the side mounted power/USB outlets always point to the centre of the seat. Each USB outlet offers 2 amps. AC/DC transformer plugs into the wall or floor monument (about 52" long cable available from the bottom of the seat). Transformer power consumption: 0.68 amps.

- Backrests are permanently secured to the bench and cannot be reconfigured on site.
- Seats can be freestanding or linked with optional interlocking bracket kit.

	PRODUCT CODE	PRICE									
		GR1	GR2	GR3	GR4	GR5	GR6	GR7	GR8	GR9	GR10
• Specify seating fabric and leg finish.	BRTSE2148EBODL	2442	2582	2694	2828	3034	3226	3420	3595	3794	3997
• USB outlets are white.	BRTSE2148EBODR	2442	2582	2694	2828	3034	3226	3420	3595	3794	3997
• Add \$55 for anodized aluminum leg finish.	BRTSE2148EBODL	4268	4649	5024	5399	6241	7073	7915	8754	9584	10509
	BRTSE2148EBODR	4268	4649	5024	5399	6241	7073	7915	8754	9584	10509

PRODUCT CODE	SIZE/INCHES			WEIGHT LBS	VOL FT ³	YRDS (COM)
	H	W	D			
BRTSE2148EBODL	29	48	24	57.00	19.33	4.00
BRTSE2148EBODR	29	48	24	57.00	19.33	4.00

BRTSE-EBL/R • Single Seat, Single 21" Wide Backrest with USB

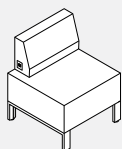

Right Hand Shown

- Fully upholstered armless lounge seat with one backrests, with dual USB outlet and metal base.

- 21" wide backrest come with embedded dual USB port in its side.

- Note: Each USB outlet offers 2 amps. AC/DC transformer plugs into the wall or floor monument (about 52" long cable available from the bottom of the seat). Transformer power consumption: 0.68 amps.

- Backrests are permanently secured to the bench and cannot be reconfigured on site.
- Seats can be freestanding or linked with optional interlocking bracket kit.

	PRODUCT CODE	PRICE									
		GR1	GR2	GR3	GR4	GR5	GR6	GR7	GR8	GR9	GR10
• Specify seating fabric and leg finish.	BRTSE2124EBL	1279	1356	1420	1496	1612	1722	1828	1927	2039	2155
• USB outlets are white.	BRTSE2124EBR	1279	1356	1420	1496	1612	1722	1828	1927	2039	2155
• Add \$55 for anodized aluminum leg finish.	BRTSE2124EBL	2306	2519	2730	2945	3418	3883	4356	4828	5297	5818
	BRTSE2124EBR	2306	2519	2730	2945	3418	3883	4356	4828	5297	5818

PRODUCT CODE	SIZE/INCHES			WEIGHT LBS	VOL FT ³	YRDS (COM)
	H	W	D			
BRTSE2124EBL	29	24	24	33.00	9.67	2.25
BRTSE2124EBR	29	24	24	33.00	9.67	2.25

BRTSPI • Boulevard Integrated Lounge Seat

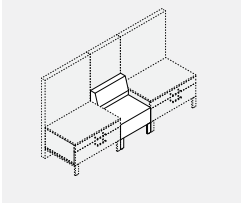

- Fully upholstered armless lounge seat with full width backrest and special metal legs.
- The single backrest is permanently secured to the bench and cannot be reconfigured on site.
- The seat brackets connect on-module to panel's vertical slots; **On-module applications only**. The seat width must be equal to panel width. The seat is **NOT** capable of supporting the panel.
- Seats and storage units can be interconnected with shared leg. Special leg support allows access to panel raceway cavity under the seat as well as access to panel-distributed duplex outlets.
- Backrests are permanently secured to the bench and cannot be reconfigured on site.

PRODUCT CODE	SIZE/INCHES			WEIGHT LBS	VOL FT ³	YRDS (COM)
	H	W	D			
BRTSPI2424	29	24	24	33.00	9.67	2.25
BRTSPI4848	29	48	24	55.50	19.33	3.50
BRTSPI6060	29	60	24	69.00	24.17	4.50

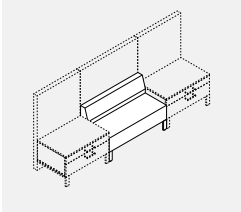

PRODUCT CODE	GRADE	PRICE									
		GR1	GR2	GR3	GR4	GR5	GR6	GR7	GR8	GR9	GR10
BRTSPI2424		1030	1109	1170	1249	1364	1471	1581	1680	1790	1904
BRTSPI4848		1901	2025	2123	2242	2421	2589	2758	2911	3086	3266
BRTSPI6060		2203	2363	2488	2641	2870	3089	3307	3505	3727	3958
PRODUCT CODE	GRADE	GR11	GR12	GR13	GR14	GR15	GR16	GR17	GR18	GR19	GR20
BRTSPI2424		2056	2273	2484	2694	3167	3633	4109	4579	5046	5568
BRTSPI4848		3502	3835	4160	4489	5229	5953	6692	7426	8153	8962
BRTSPI6060		4261	4687	5110	5531	6479	7414	8363	9306	10241	11283

BRTSPI-L/R • Boulevard integrated Single Seat with USB

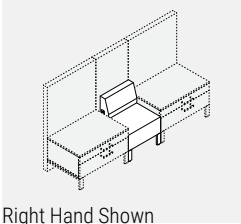

Right Hand Shown

- Fully upholstered armless lounge seat with 21" wide backrest with dual USB outlets and special metal legs.
- The single backrest is permanently secured to the bench and cannot be reconfigured on site.
- The seat brackets connect on-module to panel's vertical slots; **On-module applications only**. The seat width must be equal to panel width. The seat is **NOT** capable of supporting the panel.
- Seats and storage units can be interconnected with shared leg. Special leg support allows access to panel raceway cavity under the seat as well as access to panel-distributed duplex outlets.
- Note: Each USB outlet offers 2 amps. AC/DC transformer plugs into the wall or floor monument (about 52" long cable available from the bottom of the seat). Transformer power consumption:0.68 amps.
- Panels and storage units not included.

PRODUCT CODE	SIZE/INCHES			WEIGHT LBS	VOL FT ³	YRDS (COM)
	H	W	D			
BRTSPI2124L	29	24	24	33.00	9.67	2.25
BRTSPI2124R	29	24	24	55.50	19.33	2.25

PRODUCT CODE	GRADE	PRICE									
		GR1	GR2	GR3	GR4	GR5	GR6	GR7	GR8	GR9	GR10
BRTSPI2124L		1279	1356	1420	1496	1612	1722	1828	1927	2039	2155
BRTSPI2124R		1279	1356	1420	1496	1612	1722	1828	1927	2039	2155
PRODUCT CODE	GRADE	GR11	GR12	GR13	GR14	GR15	GR16	GR17	GR18	GR19	GR20
BRTSPI2124L		2306	2519	2730	2945	3418	3883	4356	4828	5297	5818
BRTSPI2124R		2306	2519	2730	2945	3418	3883	4356	4828	5297	5818

BRTSPI-B2 • Boulevard integrated Lounge Seat Two 21" Backrests with USB

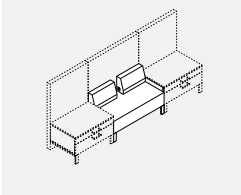

- Fully upholstered armless lounge seat with 21" wide backrest with dual USB outlets and special metal legs.
- The single backrest is permanently secured to the bench and cannot be reconfigured on site.
- The seat brackets connect on-module to panel's vertical slots; **On-module applications only**. The seat width must be equal to panel width. The seat is **NOT** capable of supporting the panel.
- Seats and storage units can be interconnected with shared leg. Special leg support allows access to panel raceway cavity under the seat as well as access to panel-distributed duplex outlets.
- Note: Each USB outlet offers 2 amps. AC/DC transformer plugs into the wall or floor monument (about 52" long cable available from the bottom of the seat). Transformer power consumption:0.68 amps.
- Panels and storage units not included.

PRODUCT CODE	SIZE/INCHES			WEIGHT LBS	VOL FT ³	YRDS (COM)
	H	W	D			
BRTSPI2148B2	29	48	24	33.00	9.67	4.00

PRODUCT CODE	GRADE	PRICE									
		GR1	GR2	GR3	GR4	GR5	GR6	GR7	GR8	GR9	GR10
BRTSPI2148B2		2442	2582	2694	2828	3034	3226	3420	3595	3794	3997
PRODUCT CODE	GRADE	GR11	GR12	GR13	GR14	GR15	GR16	GR17	GR18	GR19	GR20
BRTSPI2148B2		4268	4649	5024	5399	6241	7073	7915	8754	9584	10509

BRTSINT-S • Bridges Integrated Lounge Seat Single Sided

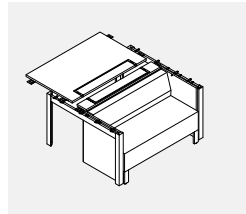
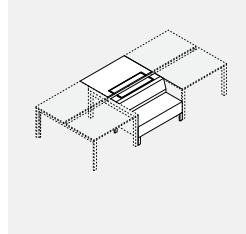

- Fully upholstered armless lounge seat with full width backrest and metal legs
- Integrated into Bridges 62.5" deep Back 2 Back linear table assembly.
- The Single-sided kit consists of 24"x48" or 24"x60" seat, full width back, three-sided below work surface enclosure, 6" deep work surface module with access door, 30"x48" or 30"x60" wide work surface with access door and supporting hardware.
- **Note: Only compatible with Back 2 Back 30" deep work surfaces (62.5" total depth) supported by Bridges rectangular legs.**
- **Connecting Back 2 Back table beams, legs and worksurface need to be specified separately.**
- Not compatible with Bridges round legs, 24" deep work surfaces; not compatible with single line table assemblies 24" and 30" deep. The kit cannot be used at the end of a table run, nor can it be used as a standalone, freestanding configuration. It must always be supported by Back 2 Back Bridges table assemblies on either side.
- Note: the seat module accommodates continuation of power and data distribution services below work surfaces (specify Below Work surface Power Troughs and power components separately).
- The 6" deep work surface module with access door provides access to Below Work Surface Power Trough.
- Backrests are permanently secured to the bench and cannot be reconfigured on site.
- Tables not included.
- Specify seating fabric and leg finish. Add \$55 for anodized aluminum leg finish

PRODUCT CODE	SIZE/INCHES			WEIGHT LBS	VOL FT ³	YRDS (COM)
	H	W	D			
BRTSINT48S	29	48	24	126.00	19.33	3.50
BRTSINT60S	29	60	24	155.00	24.17	4.50

PRODUCT CODE	PRICE										
	GRADE	GR1	GR2	GR3	GR4	GR5	GR6	GR7	GR8	GR9	GR10
BRTSINT48SLP	4164	4237	4291	4358	4459	4558	4655	4743	4841	4943	
BRTSINT60SLP	4353	4441	4511	4596	4722	4847	4965	5075	5200	5328	
BRTSINT48SHP	4386	4455	4511	4578	4682	4776	4875	4963	5063	5165	
BRTSINT60SHP	4573	4660	4732	4816	4942	5066	5184	5295	5418	5548	
GRADE	GR11	GR12	GR13	GR14	GR15	GR16	GR17	GR18	GR19	GR20	
BRTSINT48SLP	5080	5270	5456	5643	6065	6480	6904	7323	7737	8199	
BRTSINT60SLP	5498	5734	5969	6202	6729	7249	7776	8300	8819	9396	
BRTSINT48SHP	5299	5489	5677	5863	6284	6701	7123	7542	7956	8421	
BRTSINT60SHP	5716	5952	6186	6420	6947	7468	7995	8520	9038	9617	

BRTSINT-D • Bridges Integrated Lounge Double Sided

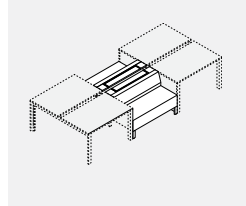

- Fully upholstered armless lounge bench with backrests and metal legs integrated into Bridges 62.5" deep Back 2 Back linear table assembly.
- The Double-sided kit consists of two 24"x48" or 24"x60" seats, full width backs, three-sided below work surface enclosures, 6" deep work surface modules with access doors and supporting hardware.
- Note: Only compatible with Back 2 Back 30" deep work surfaces (62.5" total depth) supported by Bridges rectangular legs. Not compatible with Bridges round legs, 24" deep work surfaces; not compatible with single line table assemblies 24" and 30" deep.
- The kit cannot be used at the end of a table run nor as a standalone, freestanding configuration. It must always be supported by Back 2 Back Bridges table assemblies on either side.
- Note: the seat module accommodates continuation of power and data distribution services below work surfaces (specify Below Work Surface Power Troughs and power components separately).
- The 6" deep work surface module with access door provides access to Below Work Surface Power Trough.
- Backrests are permanently secured to the bench and cannot be reconfigured on site.
- Tables not included.
- Specify seating fabric, LP laminate finish (enclosure), work surface and leg finish.
- Specify seating fabric and leg finish. Add \$55 for anodized aluminum leg finish.

PRODUCT CODE	SIZE/INCHES			WEIGHT LBS	VOL FT ³	YRDS (COM)
	H	W	D			
BRTSINT48D	29	48	24	182.00	19.33	3.50
BRTSINT60D	29	60	24	220.00	24.17	4.50

PRODUCT CODE	PRICE										
	GRADE	GR1	GR2	GR3	GR4	GR5	GR6	GR7	GR8	GR9	GR10
BRTSINT48DLP	5121	5365	5564	5799	6156	6497	6832	7139	7490	7849	
BRTSINT60DLP	5727	6041	6294	6599	7059	7494	7928	8323	8771	9232	
BRTSINT48DHP	5339	5586	5782	6019	6377	6714	7051	7360	7707	8067	
BRTSINT60DHP	5946	6263	6514	6818	7278	7714	8146	8542	8989	9453	
GRADE	GR11	GR12	GR13	GR14	GR15	GR16	GR17	GR18	GR19	GR20	
BRTSINT48DLP	8319	8985	9639	10296	11771	13225	14702	16168	17623	19241	
BRTSINT60DLP	9838	10694	11538	12381	14277	16148	18044	19930	21801	23883	
BRTSINT48DHP	8539	9203	9859	10515	11990	13444	14922	16389	17844	19461	
BRTSINT60DHP	10060	10913	11757	12599	14497	16367	18264	20149	22020	24100	

BRTPP-L1 • Seat Partitions

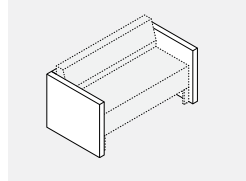

- Fully upholstered, 2.5" thick, 3-part, low level partition kit wraps around 24" or 48" bridges seat.
- The seat front is recessed by 2.5". The kit is secured to seats on-site (brackets connecting seat legs to the inner side of the partition are included).
- Upholsterd kits consist of 2" hollow core boards, 1/4 foam, fabric, levelers and connecting hardware. Specify panel fabric finish.
- Note: Seats and backrests are not included.

PRODUCT CODE	PRICE		SIZE/INCHES			WEIGHT LBS	VOL FT ³	YRDS (COM)
	GR1	GR2	H	W	D			
BRTPP2424L1	1098	1207	25	29	28.7	32.00	12.04	2.50
BRTPP2448L1	1464	1616	25	53	28.7	41.00	22.01	3.25

BRTPP-L2 • Seat Privacy Partitions

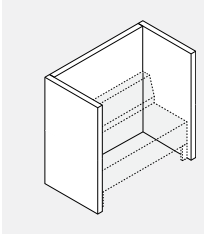

- Fully upholstered, 2.5" thick, 3-part, Two tier partition kit wraps around 24" or 48" bridges seat. The 50" high assembly provides seated visual privacy.
- 2.5" thick, upholstered partitions improve acoustic privacy for focused time away from the team or for a quiet phone call. Recessed seat extends the partition at the front by 2.5" for enhanced sense of privacy.
- The kit is secured to seats on-site (brackets connecting seat legs to the inner side of the partition are included).
- Upholstered kits consist of 2" hollow core boards, 1/4" foam, fabric, levelers and connecting hardware. Specify panel fabric finish.
- Note: Seats and backrests are not included.

PRODUCT CODE	PRICE		SIZE/INCHES			WEIGHT LBS	VOL FT ³	YRDS (COM)
	GR1	GR2	H	W	D			
BRTPP2424L2	1610	1830	50	29	28.7	38.00	24.08	5.00
BRTPP2448L2	2123	2343	50	53	28.7	48.00	44.01	6.50

BRTS-B • Square Table Block

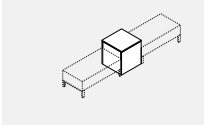

- Freestanding 25" high, 24" square table block serves as a visual anchor whenever bridges seat needs to turn corner, or split into two, three or four directions.
- BRTS2424BP can be positioned directly over a floor monument, which will supply power to the top-mounted Power module. This option includes 24"x24" block chassis and flush-mounted Duo power module included (two outlets and two 2.1 amp USB ports, white face plate, outlets and bezel, 72" long three prong black cord).
- The square table block can function as a self-supporting, freestanding unit or it can be secured permanently to adjacent Bridges seats with optional interconnecting brackets listed below.
- Specify LP laminate chassis, 1" LP or HP laminate surface.
- 2 Square Table Ganging Brackets Kits included.
- Powered Square Table Block has optional side panel grommet as needed. Please specify GRMTRS for right side and GRMTLS for left side.

PRODUCT CODE	PRICE		SIZE/INCHES			WEIGHT LBS	VOL FT ³
	LP	HP	H	W	D		
BRTS2424B	512	586	25	24	24	57.00	8.33
BRTS2424BP	1025	1098	25	24	24	59.30	8.33

BRTSTBG • Square Table Block Ganging Bracket Kit

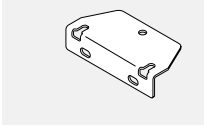

- Two Square Table Block Ganging Brackets connect seat legs permanently to the side of the 24" square table block on site. The kit employs machine screws connecting legs to seats and ships with wood screws which provide permanent connection the the Square Table Block.
- Includes 2 brackets and screws; Black powdercoat finish.

PRODUCT CODE	PRICE	SIZE/ INCHES			WEIGHT LBS	VOL FT ³
		H	W	D		
BRTSTBG	36	1.1	5	2.4	0.50	0.01

BRTSTSB • Ganging Bracket Kit

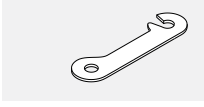

- Two ganging brackets connect seat temporarily to adjacent in-line seat or 24" deep bridges storage.
- Black powder coat finish.

PRODUCT CODE	PRICE	SIZE/ H	INCHES		WEIGHT LBS	VOL FT ³
			W	D		
BRTSTSB	17	.1	6	1.3	0.3	0.00

BRTS-Bx • Inline 6" Block

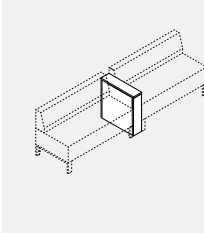

- Multifunctional In-line 6" table block divides seating areas, serves as a utility surface, can support tablet arms, lamps and double as a power delivery centre.
- It is permanently secured between two Bridges seats and cannot be placed at the end of a run. Two Square Table Block Ganging Brackets BRTSTBG connect seat legs permanently to the side of the in-line table block on site. The included kit employs machine screws connecting legs to seats and ships with wood screws which provide permanent connection the the Inline 6" Block. Black powder coat finish.
- The chassis is available without Power Module, with one Power Module or with two vertically embedded Power Modules.
- Vertical-panel flush-mounted Duo module provides two outlets and two 2.1 amp USB ports; 72" cord exits through the bottom and plugs into a floor monument under seats, white face plate and bezel.
- BRTS2406BT and BRTS2406BPT include 9.5" x 14.5" swivel tablet.
- Specify LP laminate chassis, 1" LP or HP laminate surface. If top is specified in LP the tablet will be manufactured in LP as well. If top is specified in HP the tablet will be manufactured in HP.
- 2 Square Table Ganging Bracket Kits included.

PRODUCT CODE	PRICE		SIZE/INCHES			WEIGHT LBS	VOL FT ³
	LP	HP	H	W	D		
BRTS2406B	439	474	25	6	24	21.00	2.08
BRTS2406BP	953	988	25	6	24	23.30	2.08
BRTS2406B2P	1464	1500	25	6	24	24.30	2.08
BRTS2406BT	842	879	25	6	24	25.60	2.08
BRTS2406BPT	1354	1392	25	6	24	24.30	2.08

BRTS2406B

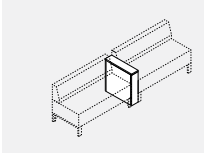

Inline table (without power module and swivel arm).

BRTS2406BP

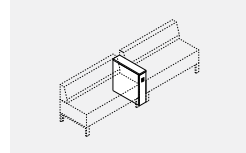

Inline table with front power module

BRTS2406B2P

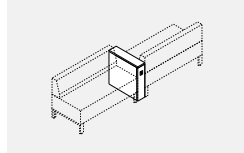

Inline table with front and rear power module.

BRTS2406BT

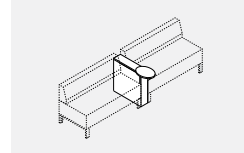

Inline table with swivel tablet arm.

BRTS2406BPT

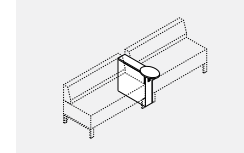

Inline table with front power module and swivel tablet arm.

LICENCE 2 SPECIFICATIONS

- Greenguard certified (www.greenguard.org)
- Carb compliant
- Level3™ certified (www.levelcertified.org)
- Tested to meet or exceed ANSI/BIFMA X5.9.2004 , ANSI/BIFMA X5.5.2008 and CAN/CGSB 44-227-2008
- Plant is ISO 9001:2015 (Quality) certified
- Plant is ISO 14001: 2015 (Environmental) certified
- Plant is OHSAS 18001:2007 (Health and Safety) certified
- 100% made in Canada
- Lifetime Warranty
- Over 6500 standard components
- Custom units available in 5 weeks lead time
- Over 24 standard laminate finishes available
- Edge colour can be specified - select from 20 colours and patterns
- Desk shells and rectangular returns non handed
- Panel end style with top over side panel design
- Tops available in 1" thick Low Pressure Laminate
- Tops available in 1-1/16" or 1-7/16" thick High Pressure Laminate
- Tops available in one edge style: Boulevard (S)
- Surfaces constructed of 45lb. density particleboard substructure with high performance thermally fused laminate or optional high pressure laminate
- Chassis constructed from 45lb. density particleboard substructure with thermally fused laminate
- 3mm edges surround all tops, end panels, drawers and door fronts
- Laminate full modesty and 10" partial modesty available as standard
- Anodized Aluminum framed frosted glazed doors available, no handles included.
- Box drawers mounted on full extension premium ball bearing slides
- File drawers mounted on premium full extension progressive ball bearing slides
- File drawers accommodate letter and/or legal hanging files (see file drawer capacity page G.2)
- Locks are standard on all units. Available in black or silver finish
- All lateral files feature a drawer interlocking mechanism
- Desk drawers open with pulls as standard
- Drawer bottoms are routed into the drawer sides
- Drawer fronts are edged on all four sides with matching 3mm edge
- All drawers locking as standard
- Key alike available
- Pedestals available in 15-1/2" width and 18, 20, 23, 24, 29, 30, 36 depth, include one pencil tray
- All mobile pedestals have option for a counterweight
- Storage modules feature levellers 5/16" x 1" easily accessible from outside the unit. All others feature 5/16" x 2" levellers.
- Monopost legs available in 3 different options, 2.5" or 3" square, 3" round and 6" round
- 6 handle options
- Storage modules available in 4 heights 29", 50", 65.8", 72.8"
- Lateral modules available in 3 widths 30", 36", 42"
- Rectangular grommets are standard and can be specified in a variety of locations as standard (see Grommet Location page A.10)
- Several Power Grommets style and configurations available.
- Drawers/Door fronts are available in a different finish than that of the chassis. Please specify option. Note that the kick plate will match the drawer front finish unless otherwise noted.

FREESTANDING - TECHNICAL INFORMATION

Worksurfaces

- Worksurfaces are offered in LP (1"), B (1 1/16") or W (1 7/16").
- All worksurfaces are drilled to accept connectors in a desk configuration.
- Worksurfaces are available in the following shapes: rectangular, bow, wedge and swerve.

Worksurface Edge trim

- Available in 1 1/16" ("B" thickness), 1 7/16" ("W" thickness) or 1" ("LP" thickness).
- Wood grain PVC edge trim, available in Boulevard (S) edge "B" and "W" thickness only.

Edge Options

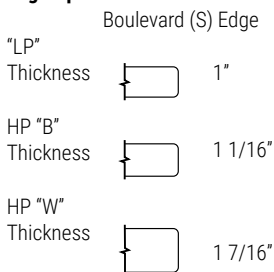

Hardware

All attachment hardware is included.

Modesty Panels

- Available in full panel 27 5/8" high or half panel ("H" option) 10" high.
- Modesty panels are flush mounted with 24", 30" and 36" deep end gables.
- Modesty panels are available recessed for 30" and 36" deep end gables.
- All recessed modesty panels are inset 6" from the edge.
- Only flush modesty panels are used for extended shell and bridge.
- Only full modesty panels are used for "L2D" desks: Rectangular, Bow, and Wedge worksurfaces.
- All exposed edges are edge banded.

Panel and Gables

- The term "end gable" or "narrow gable" is used to configure a shell, single pedestal or return.
- The term "end panel" or "narrow panel" is used to configure a table desk with shaped worksurfaces such as "D", "P", or profiles.
- All end gables are interchangeable for left or right hand use.

- End gables 24", 30" and 36" deep are drilled to accept full or half modesty panels that are flush mounted.
- End gables 30" and 36" are used for full or half modesty panels that are recessed.
- All panels and end gables are 1" thick and 27 5/8" high.
- All panels and end gables are finished in low pressure laminate.
- End gables are used in shells and single pedestal desks.
- Narrow end gables are used in shells, single pedestal desks, "T", or "L" bases.
- Narrow panels are routed to accept modular connectors for "T" or "L" applications.
- All panels and gables are predrilled to accept levelers at the bottom and connectors at the top.
- All panels or gables are 3mm edge banded at the exposed edge .
- All narrow gables are routed at the top to allow cables to pass through and come with a connecting flat bracket.
- All bottom edges are edge banded.

Handles

- Handles are offered in 4 styles.
- Options are as follows:

- BB = Bow Matte Black
- BC = Bow Matte Chrome
- UB = "U"Dull Black
- UC = "U"Dull Chrome
- FA = Flat Aluminum
- RN = Round Nickel

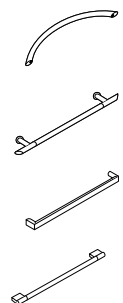

- Span dimension between drilling locations is 192mm.
- e-lock

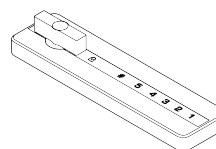

WOOD GRAIN (WG) LAMINATE DIRECTION

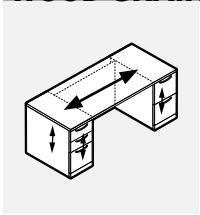

Double Pedestal Desks

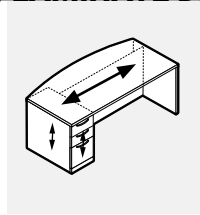

Single Pedestal Desks

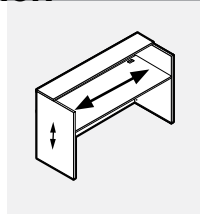

Reception Desks

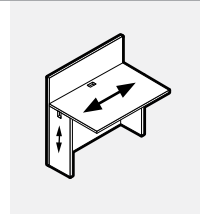

Surround Bridges

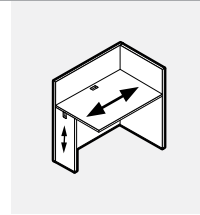

Right Hand Surround Bridges

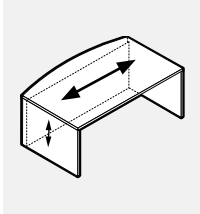

Shells

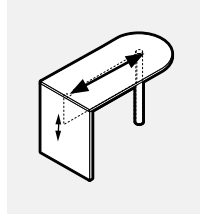

"D" Shaped Tables

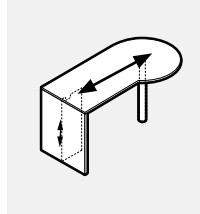

"P" Shaped Tables

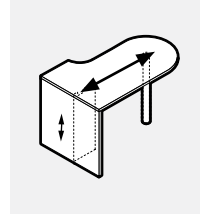

Profile Corner Round Tables

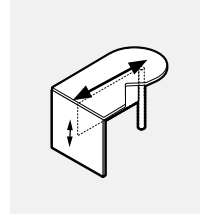

Profile Corner Cut Tables

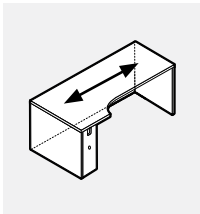

Profile Corner Desks

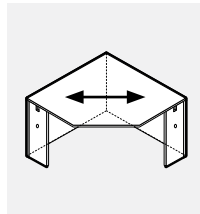

All Corner Desks 42" and Smaller

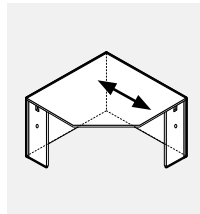

All Corner Desks Larger than 42"

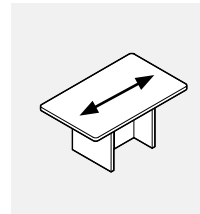

Occasional Tables

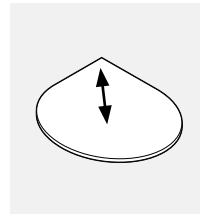

Teardrop Table Tops

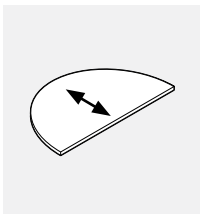

Half Moon Table Tops

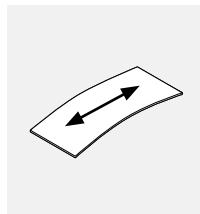

All Other Table Tops

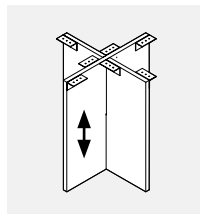

Bases

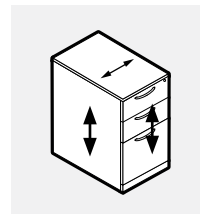

All Pedestals

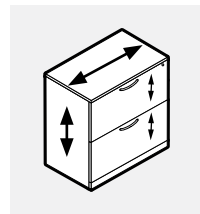

All Laterals

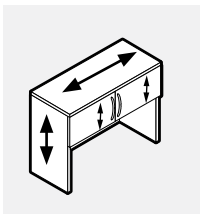

All Hinged Door Hutches

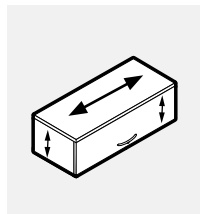

All Flip-Up Door Overheads

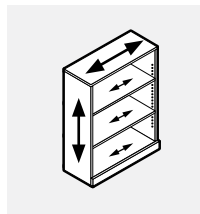

All Bookcases

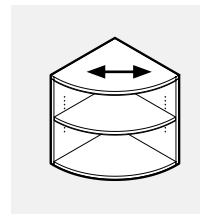

All Corner Bookcases

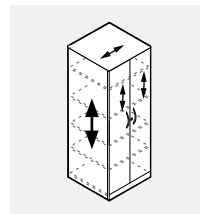

All Towers

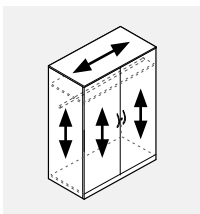

All Cabinets

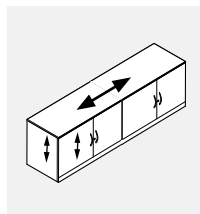

All Credenzas

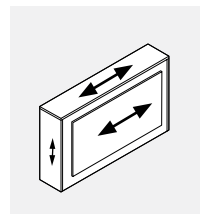

Gallery Desk

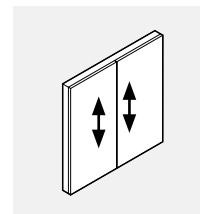

Visual Board

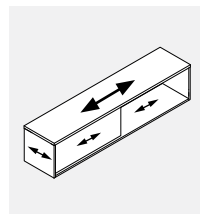

Overhead Divider Storage

GROMMET LOCATION

Notes

- All worksurfaces are standard with rectangular grommets # BG5.
- Worksurfaces 54" wide and under are standard with 1 grommet.
- Worksurfaces over 54" wide are standard with 2 grommets.
- Grommet location must be specified at time of order or it will default to "no grommet" option.

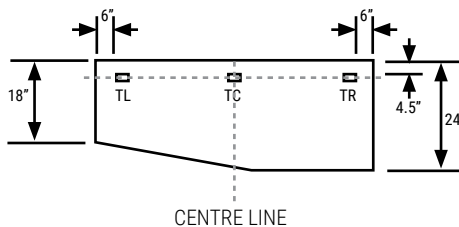
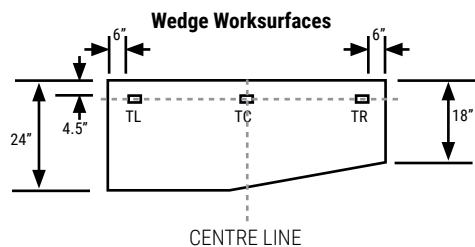
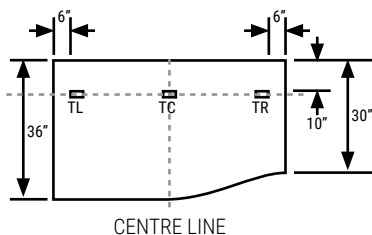
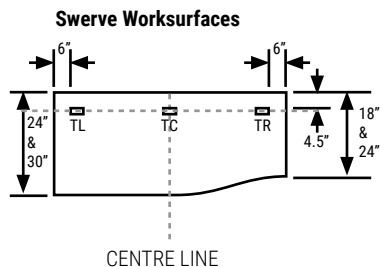
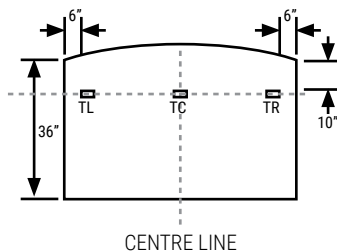
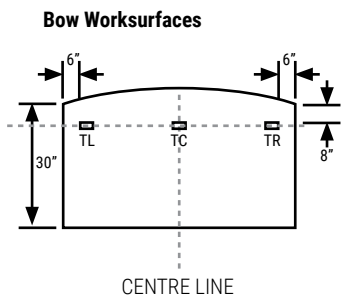
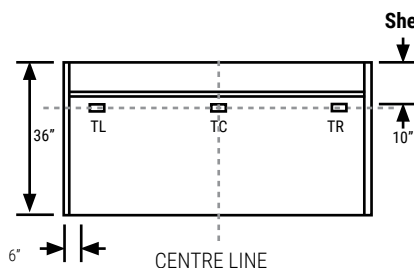
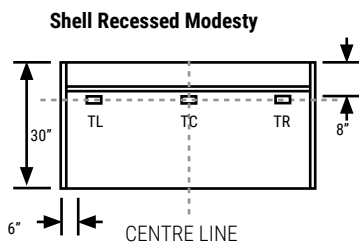
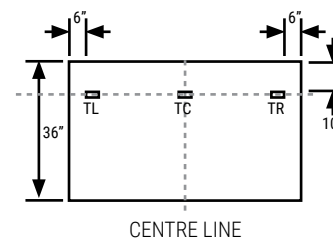
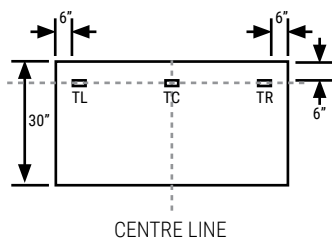
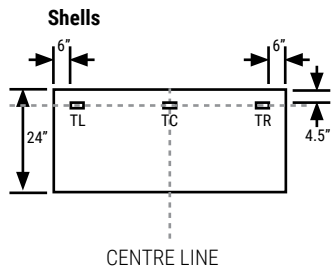
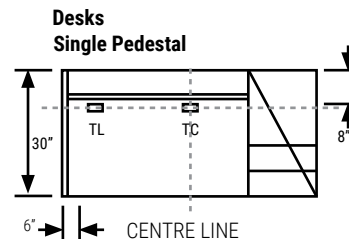
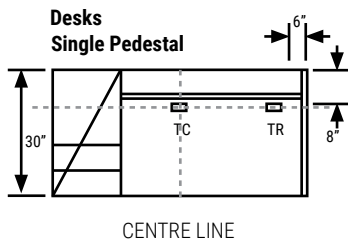
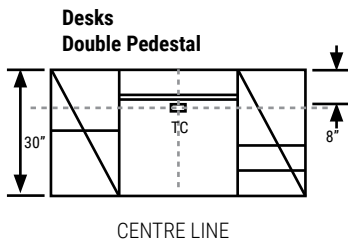

GROMMET LOCATION

"P" Shaped Tables "L2T"

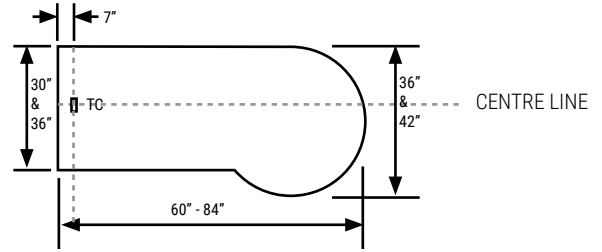
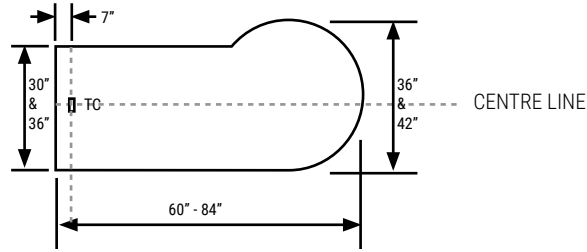

Extended "D" - L2TED

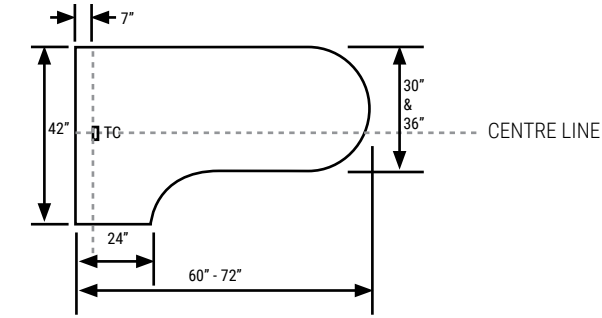

"D" Shaped Tables

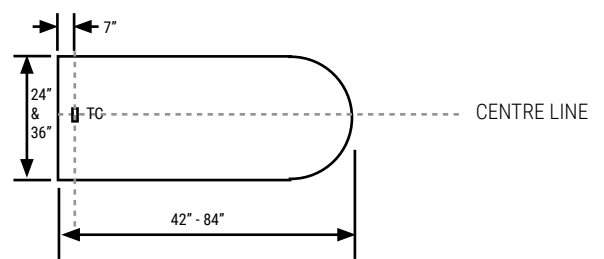

Extended Corner "L2EC"

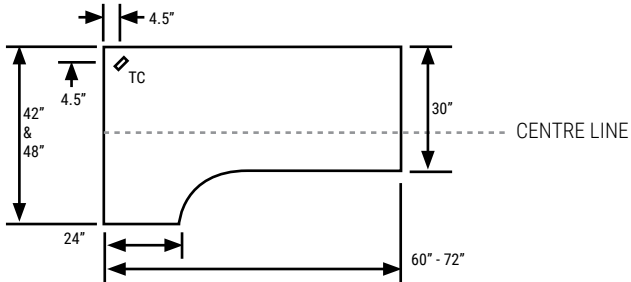

Extended "D" Cut Out "L2TEDCO"

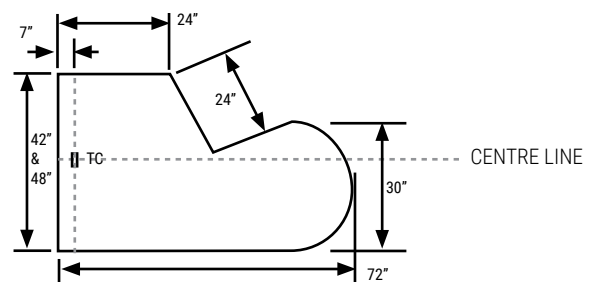

Extended Corner Recessed Modesty

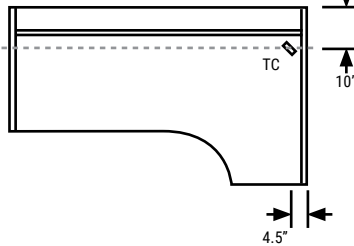

Wedge Shell Recessed Modesty

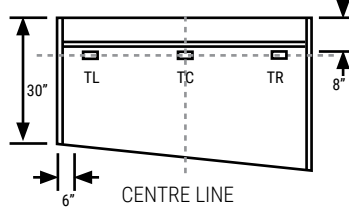

Corner Worksurfaces - 1 Piece

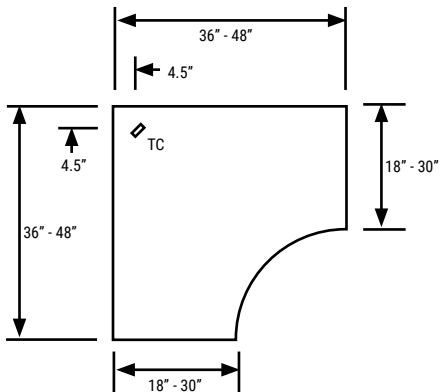

Split Corner Worksurfaces - 2 Piece

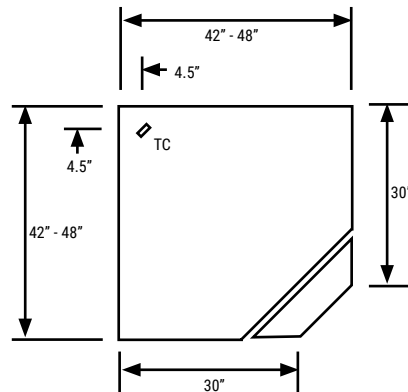

GROMMET LOCATION

Hockey Shaped Tables "L2TH"



Floating Tops "L2F"

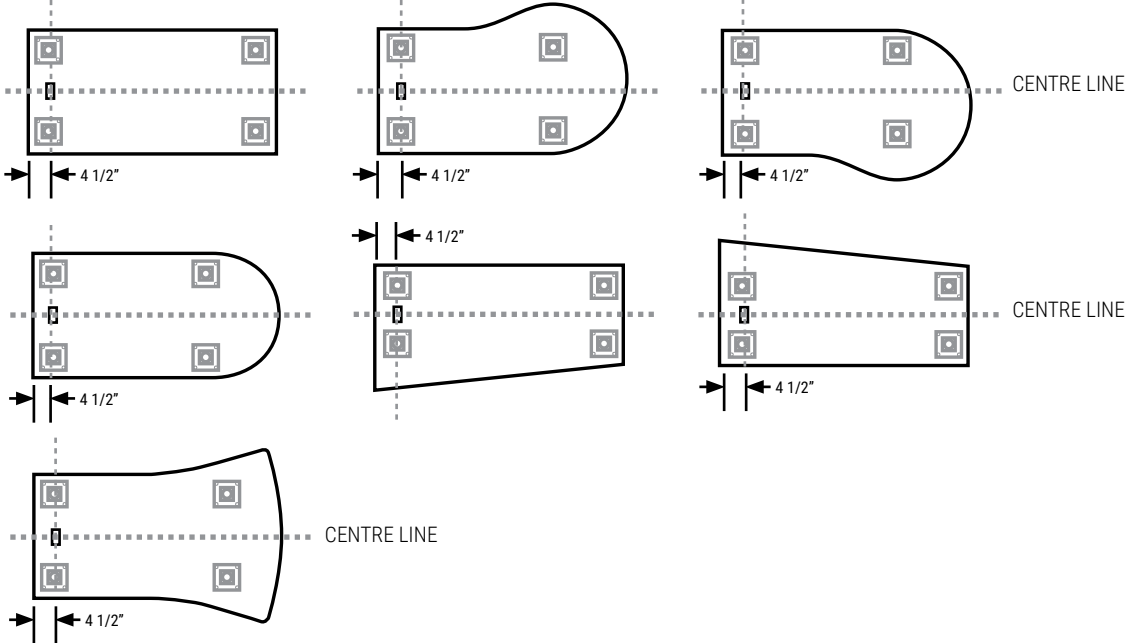

Runoff Tops "L2TC"

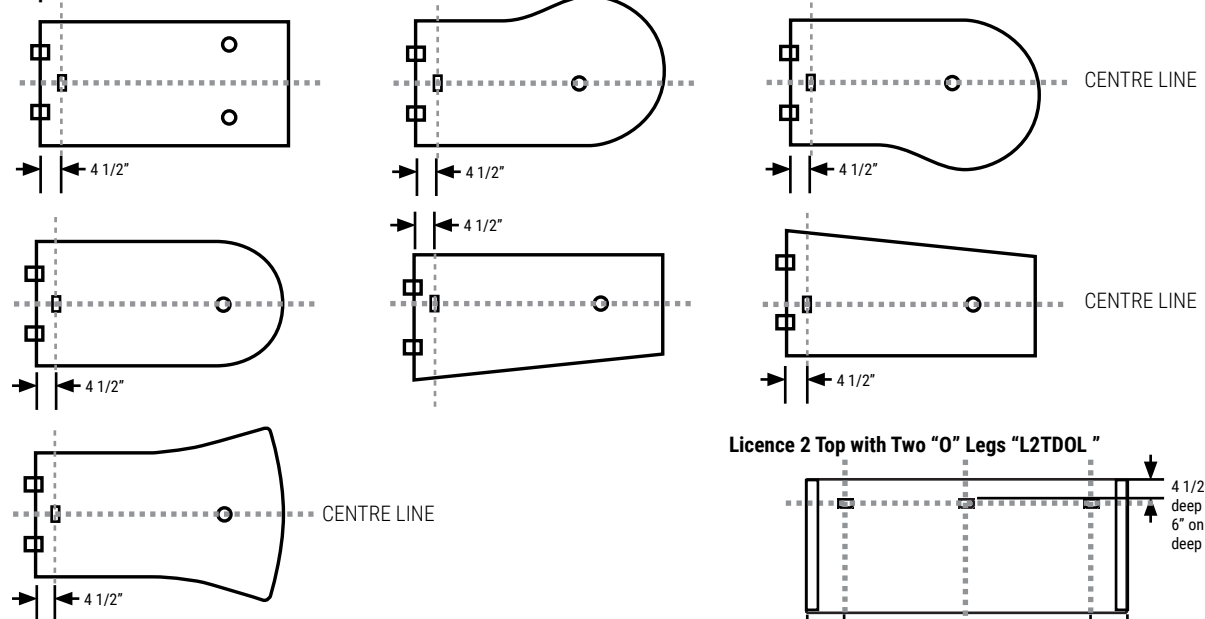

Licence 2 Top with Two "O" Legs "L2TDOL"

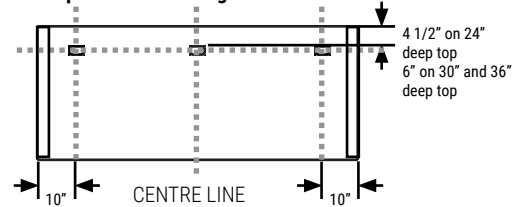

Floating Tops "L2FFL"

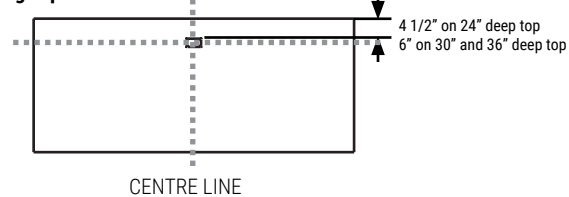

Technical Information

Double Pedestal Desk/ Single Pedestal Desk

- All desks are Shipped knocked down (KD).
- Pedestals are shipped assembled
- Pedestals are LP all over
- Non Interlocking mechanism Pedestals
- Half modesty available on all Double Pedestal Desks, specify 'H' Before size eg. L2DRH3060FB
- Half modesty available on Single Pedestal Desks, specify "H" before size eg. L2DRH-3060BR
- All desks have modesty recessed 6"

Executive Return Desk

- All desks are Shipped knocked down (KD).
- This typed of desk must be connected at open end to adjoining worksurface with flat brackets.
- Half modesty available on all Single Pedestal Returns, specify "H" before size eg. L2RH2036FL

Single Pedestal Returns

- All desks are Shipped knocked down (KD).
- This type of desk must be connected at open end to adjoining worksurface with flat brackets.

DESKS • GUIDELINES FOR ORDERING PRODUCT

CODES: The price list uses a numbering system with meaningful alphanumeric characters to create a simple-to-understand product number. This makes specifying the product much easier and more accurate.

SPECIFICATION EXAMPLE OF A DESK UNIT

PRODUCT CODE: L2DR3060FB
 L2 = New Licence
 D = Desk
 R = Rectangular
 3060 = Size: Depth x Width
 FB = PED FF LEFT / PED BBF RIGHT

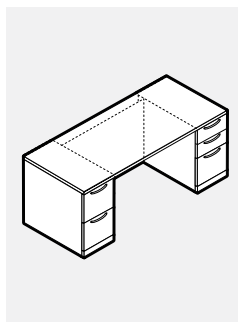

OPTIONS:
 Top: LP - LP (Low Pressure Laminate) Thickness 1"
 HP B - B Thickness 1 1/16"
 HP W - W Thickness 1 7/16"

Top Finish Laminate: Choose Colour

Top PVC Edging: Choose Colour

Chassis Laminate: Choose Colour

Chassis PVC Edging: Choose Colour

Handle Style: **BC - Bow Matte Chrome (DEFAULT)**
 BB - Bow Matt Black
 UB - "U" Dull Black
 UC - "U" Dull Chrome
 FA - Flat Aluminum
 RN - Round Nickel

Grommet Location: **N - No grommet (DEFAULT)**
 Double Pedestal desk: TC - Top Centre Only
 Single Right Pedestal Desk: TC - Top Centre
 TL - Top Left
 Single Left Pedestal Desk: TC - Top Centre
 TR - Top Right

L2 • Keys

PRODUCT CODE	PRICE	SIZE/ INCHES		WEIGHT	VOL
		H	W D		
Master key:					
L2MK	29				
Extra key for existing cabinet:					
L2EK	12				
Core key:					
L2CK	14				
Core & Key:					
L2LOCKKEY	31				

- Additional key (specify at time of order).
- Please choose black or silver.

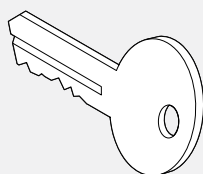

L2DR-FB • Double Pedestal Desk, FF Left, BBF Right, Recessed Modesty

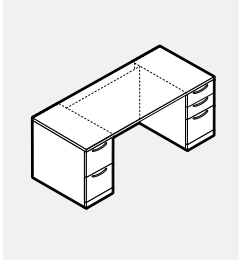

• Optional e-lock available for each pedestal in the vertical position. Please specify V-Vertical and add \$224 list for each.

PRODUCT CODE	FINISH LP	B	W	SIZE/INCHES			D	WEIGHT LBS	VOL FT ³
				H (LP/B)	H (W)	W			
L2DR3060FB	2290	2426	2550	29	29.5	60	30	224	24
L2DR3066FB	2333	2482	2617	29	29.5	66	30	234	25
L2DR3072FB	2376	2538	2684	29	29.5	72	30	244	25
L2DR3078FB	2420	2593	2752	29	29.5	78	30	272	26
L2DR3084FB	2463	2653	2822	29	29.5	84	30	299	26
L2DR3672FB	2497	2693	2861	29	29.5	72	36	272	26
L2DR3678FB	2544	2756	2935	29	29.5	78	36	299	28
L2DR3684FB	2593	2820	3014	29	29.5	84	36	327	28

L2DR-BF • Double Pedestal Desk, FF Right, BBF Left, Recessed Modesty

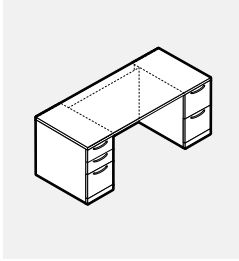

• Optional e-lock available for each pedestal in the vertical position. Please specify V-Vertical and add \$224 list for each.

PRODUCT CODE	FINISH LP	B	W	SIZE/INCHES			D	WEIGHT LBS	VOL FT ³
				H (LP/B)	H (W)	W			
L2DR3060BF	2290	2426	2550	29	29.5	60	30	224	24
L2DR3066BF	2333	2482	2617	29	29.5	66	30	234	25
L2DR3072BF	2376	2538	2684	29	29.5	72	30	244	25
L2DR3078BF	2420	2593	2752	29	29.5	78	30	272	26
L2DR3084BF	2463	2653	2822	29	29.5	84	30	299	26
L2DR3672BF	2497	2693	2861	29	29.5	72	36	272	26
L2DR3678BF	2544	2756	2935	29	29.5	78	36	299	28
L2DR3684BF	2593	2820	3014	29	29.5	84	36	327	28

L2DRH-FB • Double Pedestal Desk, FF Left, BBF Right Recessed Half Modesty

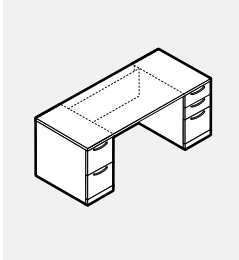

• Optional e-lock available for each pedestal in the vertical position. Please specify V-Vertical and add \$224 list for each.

PRODUCT CODE	FINISH LP	B	W	SIZE/INCHES			D	WEIGHT LBS	VOL FT ³
				H (LP/B)	H (W)	W			
L2DRH3060FB	2234	2369	2496	29	29.5	60	30	224	24
L2DRH3066FB	2269	2420	2553	29	29.5	66	30	234	25
L2DRH3072FB	2301	2462	2611	29	29.5	72	30	244	25
L2DRH3078FB	2334	2510	2668	29	29.5	78	30	272	26
L2DRH3084FB	2368	2556	2728	29	29.5	84	30	299	26
L2DRH3672FB	2423	2617	2785	29	29.5	72	36	272	26
L2DRH3678FB	2460	2670	2849	29	29.5	78	36	299	28
L2DRH3684FB	2498	2726	2919	29	29.5	84	36	327	28

L2DRH-BF • Double Pedestal Desk, BBF Left, FF Right Recessed Half Modesty

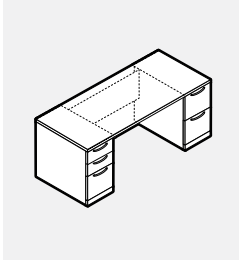

• Optional e-lock available for each pedestal in the vertical position. Please specify V-Vertical and add \$224 list for each.

PRODUCT CODE	FINISH LP	B	W	SIZE/INCHES			D	WEIGHT LBS	VOL FT ³
				H (LP/B)	H (W)	W			
L2DRH3060BF	2234	2369	2496	29	29.5	60	30	224	24
L2DRH3066BF	2269	2420	2553	29	29.5	66	30	234	25
L2DRH3072BF	2301	2462	2611	29	29.5	72	30	244	25
L2DRH3078BF	2334	2510	2668	29	29.5	78	30	272	26
L2DRH3084BF	2368	2556	2728	29	29.5	84	30	299	26
L2DRH3672BF	2423	2617	2785	29	29.5	72	36	272	26
L2DRH3678BF	2460	2670	2849	29	29.5	78	36	299	28
L2DRH3684BF	2498	2726	2919	29	29.5	84	36	327	28

L2DB-FB • Bowfront Double Pedestal Desk, FF Left, BBF Right, Recessed Modesty

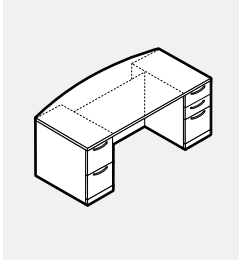

• Optional e-lock available for each pedestal in the vertical position. Please specify V-Vertical and add \$224 list for each.

PRODUCT CODE	FINISH LP	B	W	SIZE/INCHES			D	WEIGHT LBS	VOL FT ³
				H (LP/B)	H (W)	W			
L2DB3060FB	2344	2507	2646	29	29.5	60	36	374	25
L2DB3066FB	2390	2569	2721	29	29.5	66	36	383	26
L2DB3072FB	2435	2631	2795	29	29.5	72	36	395	26
L2DB3078FB	2485	2694	2869	29	29.5	78	36	422	28
L2DB3084FB	2534	2760	2948	29	29.5	84	36	450	28
L2DB3672FB	2558	2785	2970	29	29.5	72	42	422	28
L2DB3678FB	2611	2855	3051	29	29.5	78	42	450	29
L2DB3684FB	2664	2927	3138	29	29.5	84	42	477	29

L2DB-BF • Bowfront Double Pedestal Desk, FF Right, BBF Left, Recessed Modesty

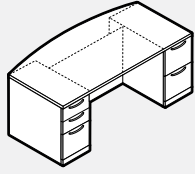

• Optional e-lock available for each pedestal in the vertical position. Please specify V-Vertical and add \$224 list for each.

PRODUCT CODE	FINISH LP	B	W	SIZE / INCHES				WEIGHT LBS	VOL FT ³
				H(LP/B)	H(W)	W	D		
L2DB3060BF	2344	2507	2646	29	29.5	60	36	374	25
L2DB3066BF	2390	2569	2721	29	29.5	66	36	383	26
L2DB3072BF	2435	2631	2795	29	29.5	72	36	395	26
L2DB3078BF	2485	2694	2869	29	29.5	78	36	422	28
L2DB3084BF	2534	2760	2948	29	29.5	84	36	450	28
L2DB3672BF	2558	2785	2970	29	29.5	72	42	422	28
L2DB3678BF	2611	2855	3051	29	29.5	78	42	450	29
L2DB3684BF	2664	2927	3138	29	29.5	84	42	477	29

L2DBH-FB • Bowfront Double Pedestal Desk, FF Left, BBF Right Recessed Half Modesty

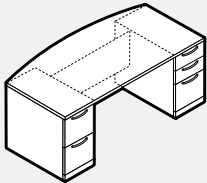

• Optional e-lock available for each pedestal in the vertical position. Please specify V-Vertical and add \$224 list for each.

PRODUCT CODE	FINISH LP	B	W	SIZE / INCHES				WEIGHT LBS	VOL FT ³
				H(LP/B)	H(W)	W	D		
L2DBH3060FB	2290	2452	2592	29	29.5	60	36	374	25
L2DBH3066FB	2324	2507	2655	29	29.5	66	36	383	26
L2DBH3072FB	2363	2555	2721	29	29.5	72	36	395	26
L2DBH3078FB	2398	2611	2784	29	29.5	78	36	422	28
L2DBH3084FB	2438	2665	2850	29	29.5	84	36	450	28
L2DBH3672FB	2485	2710	2894	29	29.5	72	42	422	28
L2DBH3678FB	2525	2770	2966	29	29.5	78	42	450	29
L2DBH3684FB	2570	2833	3042	29	29.5	84	42	477	29

L2DBH-BF • Bowfront Double Pedestal Desk, BBF Left, FF Right Recessed Half Modesty

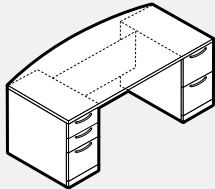

• Optional e-lock available for each pedestal in the vertical position. Please specify V-Vertical and add \$224 list for each.

PRODUCT CODE	FINISH LP	B	W	SIZE / INCHES				WEIGHT LBS	VOL FT ³
				H(LP/B)	H(W)	W	D		
L2DBH3060BF	2290	2452	2592	29	29.5	60	36	374	25
L2DBH3066BF	2324	2507	2655	29	29.5	66	36	383	26
L2DBH3072BF	2363	2555	2721	29	29.5	72	36	395	26
L2DBH3078BF	2398	2611	2784	29	29.5	78	36	422	28
L2DBH3084BF	2438	2665	2850	29	29.5	84	36	450	28
L2DBH3672BF	2485	2710	2894	29	29.5	72	42	422	28
L2DBH3678BF	2525	2770	2966	29	29.5	78	42	450	29
L2DBH3684BF	2570	2833	3042	29	29.5	84	42	477	29

L2DR-BR • Single Pedestal Desk, BBF Right, Recessed Modesty

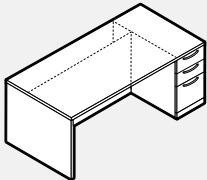

• Optional e-lock available for the pedestal in the vertical position. Please specify V-Vertical and add \$224 list.

PRODUCT CODE	FINISH LP	B	W	SIZE / INCHES				WEIGHT LBS	VOL FT ³
				H(LP/B)	H(W)	W	D		
L2DR3060BR	1590	1724	1849	29	29.5	60	30	224	14
L2DR3066BR	1632	1781	1916	29	29.5	66	30	234	15
L2DR3072BR	1674	1837	1983	29	29.5	72	30	244	15
L2DR3078BR	1711	1885	2045	29	29.5	78	30	272	17
L2DR3084BR	1763	1955	2123	29	29.5	84	30	299	17
L2DR3672BR	1782	1975	2145	29	29.5	72	36	272	17
L2DR3678BR	1821	2031	2215	29	29.5	78	36	299	18
L2DR3684BR	1878	2103	2298	29	29.5	84	36	327	18

L2DR-BL • Single Pedestal Desk, BBF Left, Recessed Modesty

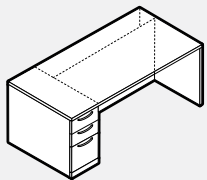

• Optional e-lock available for the pedestal in the vertical position. Please specify V-Vertical and add \$224 list.

PRODUCT CODE	FINISH LP	B	W	SIZE / INCHES				WEIGHT LBS	VOL FT ³
				H(LP/B)	H(W)	W	D		
L2DR3060BL	1590	1724	1849	29	29.5	60	30	224	14
L2DR3066BL	1632	1781	1916	29	29.5	66	30	234	15
L2DR3072BL	1674	1837	1983	29	29.5	72	30	244	15
L2DR3078BL	1711	1885	2045	29	29.5	78	30	272	17
L2DR3084BL	1763	1955	2123	29	29.5	84	30	299	17
L2DR3672BL	1782	1975	2145	29	29.5	72	36	272	17
L2DR3678BL	1821	2031	2215	29	29.5	78	36	299	18
L2DR3684BL	1878	2103	2298	29	29.5	84	36	327	18

L2DRH-BR • Single Pedestal Desk, BBF Right Recessed Half Modesty

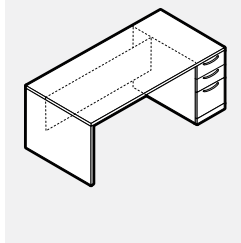

• Optional e-lock available for the pedestal in the vertical position. Please specify V-Vertical and add \$224 list.

PRODUCT CODE	FINISH LP	B	W	SIZE / INCHES		W	D	WEIGHT LBS	VOL FT ³
				H (LP/B)	H (W)				
L2DRH3060BR	1485	1620	1748	29	29.5	60	30	224	14
L2DRH3066BR	1518	1668	1803	29	29.5	66	30	234	15
L2DRH3072BR	1552	1713	1862	29	29.5	72	30	244	15
L2DRH3078BR	1584	1759	1916	29	29.5	78	30	272	17
L2DRH3084BR	1619	1808	1978	29	29.5	84	30	299	17
L2DRH3672BR	1658	1851	2022	29	29.5	72	36	272	17
L2DRH3678BR	1695	1903	2086	29	29.5	78	36	299	18
L2DRH3684BR	1733	1961	2155	29	29.5	84	36	327	18

L2DRH-BL • Single Pedestal Desk, BBF Left Recessed Half Modesty

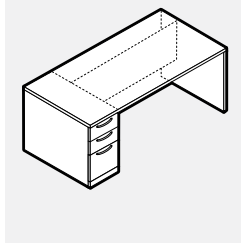

• Optional e-lock available for the pedestal in the vertical position. Please specify V-Vertical and add \$224 list.

PRODUCT CODE	FINISH LP	B	W	SIZE / INCHES		W	D	WEIGHT LBS	VOL FT ³
				H (LP/B)	H (W)				
L2DRH3060BL	1485	1620	1748	29	29.5	60	30	224	14
L2DRH3066BL	1518	1668	1803	29	29.5	66	30	234	15
L2DRH3072BL	1552	1713	1862	29	29.5	72	30	244	15
L2DRH3078BL	1584	1759	1916	29	29.5	78	30	272	17
L2DRH3084BL	1619	1808	1978	29	29.5	84	30	299	17
L2DRH3672BL	1658	1851	2022	29	29.5	72	36	272	17
L2DRH3678BL	1695	1903	2086	29	29.5	78	36	299	18
L2DRH3684BL	1733	1961	2155	29	29.5	84	36	327	18

L2DB-BR • Bowfront Single Pedestal Desk, BBF Right, Recessed Modesty

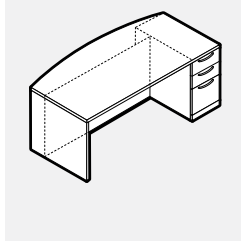

• Optional e-lock available for the pedestal in the vertical position. Please specify V-Vertical and add \$224 list.

PRODUCT CODE	FINISH LP	B	W	SIZE / INCHES		W	D	WEIGHT LBS	VOL FT ³
				H (LP/B)	H (W)				
L2DB3060BR	1642	1805	1945	29	29.5	60	36	264	14
L2DB3066BR	1690	1867	2022	29	29.5	66	36	274	15
L2DB3072BR	1736	1929	2094	29	29.5	72	36	286	15
L2DB3078BR	1778	1988	2162	29	29.5	78	36	314	17
L2DB3084BR	1835	2059	2248	29	29.5	84	36	338	17
L2DB3672BR	1843	2068	2254	29	29.5	72	42	310	17
L2DB3678BR	1890	2133	2330	29	29.5	78	42	338	18
L2DB3684BR	1948	2213	2422	29	29.5	84	42	362	18

L2DB-BL • Bowfront Single Pedestal Desk, BBF Left, Recessed Modesty

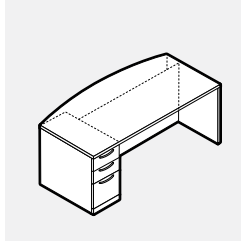

• Optional e-lock available for the pedestal in the vertical position. Please specify V-Vertical and add \$224 list.

PRODUCT CODE	FINISH LP	B	W	SIZE / INCHES		W	D	WEIGHT LBS	VOL FT ³
				H (LP/B)	H (W)				
L2DB3060BL	1642	1805	1945	29	29.5	60	36	264	14
L2DB3066BL	1690	1867	2022	29	29.5	66	36	274	15
L2DB3072BL	1736	1929	2094	29	29.5	72	36	286	15
L2DB3078BL	1778	1988	2162	29	29.5	78	36	314	17
L2DB3084BL	1835	2059	2248	29	29.5	84	36	338	17
L2DB3672BL	1843	2068	2254	29	29.5	72	42	310	17
L2DB3678BL	1890	2133	2330	29	29.5	78	42	338	18
L2DB3684BL	1948	2213	2422	29	29.5	84	42	362	18

L2DBH-BR • Bowfront Single Pedestal Desk, BBF Right Recessed Half Modesty

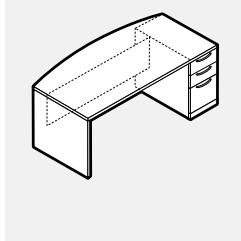

• Optional e-lock available for the pedestal in the vertical position. Please specify V-Vertical and add \$224 list.

PRODUCT CODE	FINISH LP	B	W	SIZE / INCHES		W	D	WEIGHT LBS	VOL FT ³
				H (LP/B)	H (W)				
L2DBH3060BR	1540	1701	1840	29	29.5	60	36	264	14
L2DBH3066BR	1575	1753	1904	29	29.5	66	36	274	15
L2DBH3072BR	1612	1807	1969	29	29.5	72	36	286	15
L2DBH3078BR	1648	1861	2032	29	29.5	78	36	314	17
L2DBH3084BR	1689	1915	2101	29	29.5	84	36	338	17
L2DBH3672BR	1720	1945	2129	29	29.5	72	42	310	17
L2DBH3678BR	1759	2003	2200	29	29.5	78	42	338	18
L2DBH3684BR	1803	2067	2279	29	29.5	84	42	362	18

L2DBH-BL • Bowfront Single Pedestal Desk, BBF Left Recessed Half Modesty

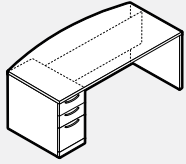

- Optional e-lock available for the pedestal in the vertical position. Please specify V-Vertical and add \$224 list.

PRODUCT CODE	FINISH LP	B	W	SIZE / INCHES				WEIGHT LBS	VOL FT³
				H(LP/B)	H(W)	W	D		
L2DBH3060BL	1540	1701	1840	29	29.5	60	36	264	14
L2DBH3066BL	1575	1753	1904	29	29.5	66	36	274	15
L2DBH3072BL	1612	1807	1969	29	29.5	72	36	286	15
L2DBH3078BL	1648	1861	2032	29	29.5	78	36	314	17
L2DBH3084BL	1689	1915	2101	29	29.5	84	36	338	17
L2DBH3672BL	1720	1945	2129	29	29.5	72	42	310	17
L2DBH3678BL	1759	2003	2200	29	29.5	78	42	338	18
L2DBH3684BL	1803	2067	2279	29	29.5	84	42	362	18

L2DRA-FB • Double Desk, FF Left BBF Right Recessed, Glazed Full Modesty

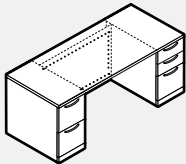

- Modesty is aluminum framed.
- Glazing is frosted acrylic.
- Optional e-lock available for each pedestal in the vertical position. Please specify V-Vertical and add \$224 list for each.

PRODUCT CODE	FINISH LP	B	W	SIZE / INCHES				WEIGHT LBS	VOL FT³
				H(LP/B)	H(W)	W	D		
L2DRA3060FB	2714	2846	2967	29.06	29.5	60	30	204	22
L2DRA3066FB	2797	2945	3076	29.06	29.5	66	30	213	23
L2DRA3072FB	2882	3039	3183	29.06	29.5	72	30	222	23
L2DRA3078FB	2962	3138	3290	29.06	29.5	78	30	247	24
L2DRA3084FB	3051	3237	3403	29.06	29.5	84	30	272	24
L2DRA3672FB	3001	3190	3355	29.06	29.5	72	36	247	24
L2DRA3678FB	3087	3293	3473	29.06	29.5	78	36	272	25
L2DRA3684FB	3180	3400	3590	29.06	29.5	84	36	297	25

L2DRA-BF • Double Desk, FF Right BBF Left Recessed, Glazed Full Modesty

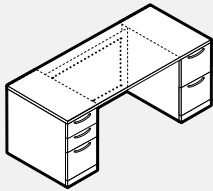

- Modesty is aluminum framed.
- Glazing is frosted acrylic.
- Optional e-lock available for each pedestal in the vertical position. Please specify V-Vertical and add \$224 list for each.

PRODUCT CODE	FINISH LP	B	W	SIZE / INCHES				WEIGHT LBS	VOL FT³
				H(LP/B)	H(W)	W	D		
L2DRA3060BF	2714	2846	2967	29.06	29.5	60	30	204	22
L2DRA3066BF	2797	2945	3076	29.06	29.5	66	30	213	23
L2DRA3072BF	2882	3039	3183	29.06	29.5	72	30	222	23
L2DRA3078BF	2962	3138	3290	29.06	29.5	78	30	247	24
L2DRA3084BF	3051	3237	3403	29.06	29.5	84	30	272	24
L2DRA3672BF	3001	3190	3355	29.06	29.5	72	36	247	24
L2DRA3678BF	3087	3293	3473	29.06	29.5	78	36	272	25
L2DRA3684BF	3180	3400	3590	29.06	29.5	84	36	297	25

L2DBA-FB • Bowfront Double Desk, FF Left BBF Right Recessed, Glazed Full Modesty

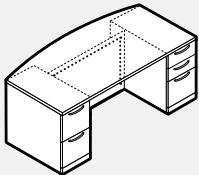

- Modesty is aluminum framed.
- Glazing is frosted acrylic.
- Optional e-lock available for each pedestal in the vertical position. Please specify V-Vertical and add \$224 list for each.

PRODUCT CODE	FINISH LP	B	W	SIZE / INCHES				WEIGHT LBS	VOL FT³
				H(LP/B)	H(W)	W	D		
L2DBA3060FB	2764	2924	3061	29.06	29.5	60	36	340	23
L2DBA3066FB	2851	3027	3175	29.06	29.5	66	36	348	24
L2DBA3072FB	2945	3130	3290	29.06	29.5	72	36	359	24
L2DBA3078FB	3031	3232	3406	29.06	29.5	78	36	384	25
L2DBA3084FB	3122	3342	3523	29.06	29.5	84	36	409	25
L2DBA3672FB	3061	3282	3460	29.06	29.5	72	42	384	25
L2DBA3678FB	3153	3392	3584	29.06	29.5	78	42	409	26
L2DBA3684FB	3249	3507	3711	29.06	29.5	84	42	434	26

L2DBA-BF • Bowfront Double Desk, FF Right BBF Left Recessed, Glazed Full Modesty

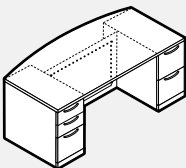

- Modesty is aluminum framed.
- Glazing is frosted acrylic.
- Optional e-lock available for each pedestal in the vertical position. Please specify V-Vertical and add \$224 list for each.

PRODUCT CODE	FINISH LP	B	W	SIZE / INCHES				WEIGHT LBS	VOL FT³
				H(LP/B)	H(W)	W	D		
L2DBA3060BF	2764	2924	3061	29.06	29.5	60	36	340	23
L2DBA3066BF	2851	3027	3175	29.06	29.5	66	36	348	24
L2DBA3072BF	2945	3130	3290	29.06	29.5	72	36	359	24
L2DBA3078BF	3031	3232	3406	29.06	29.5	78	36	384	25
L2DBA3084BF	3122	3342	3523	29.06	29.5	84	36	409	25
L2DBA3672BF	3061	3282	3460	29.06	29.5	72	42	384	25
L2DBA3678BF	3153	3392	3584	29.06	29.5	78	42	409	26
L2DBA3684BF	3249	3507	3711	29.06	29.5	84	42	434	26

L2DRAH-FB • Double Pedestal Desk, FF Left BBF Right Recessed, Half Glazed Modesty

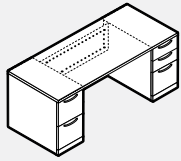

- Modesty is aluminum framed.
- Glazing is frosted acrylic.
- Optional e-lock available for each pedestal in the vertical position. Please specify V-Vertical and add \$224 list for each.

PRODUCT CODE	FINISH LP	B	W	SIZE/INCHES		W	D	WEIGHT LBS	VOL FT ³
				H(LP/B)	H(W)				
L2DRAH3060FB	2569	2701	2823	29.06	29.5	60	30	204	22
L2DRAH3066FB	2638	2783	2917	29.06	29.5	66	30	213	23
L2DRAH3072FB	2697	2856	3001	29.06	29.5	72	30	222	23
L2DRAH3078FB	2759	2928	3084	29.06	29.5	78	30	247	24
L2DRAH3084FB	2823	3010	3174	29.06	29.5	84	30	272	24
L2DRAH3672FB	2818	3009	3170	29.06	29.5	72	36	247	24
L2DRAH3678FB	2882	3087	3265	29.06	29.5	78	36	272	25
L2DRAH3684FB	2950	3170	3359	29.06	29.5	84	36	297	25

L2DRAH-BF • Double Pedestal Desk, BBF Left FF Right Recessed, Half Glazed Modesty

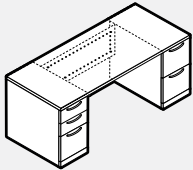

- Modesty is aluminum framed.
- Glazing is frosted acrylic.
- Optional e-lock available for each pedestal in the vertical position. Please specify V-Vertical and add \$224 list for each.

PRODUCT CODE	FINISH LP	B	W	SIZE/INCHES		W	D	WEIGHT LBS	VOL FT ³
				H(LP/B)	H(W)				
L2DRAH3060BF	2569	2701	2823	29.06	29.5	60	30	204	22
L2DRAH3066BF	2638	2783	2917	29.06	29.5	66	30	213	23
L2DRAH3072BF	2697	2856	3001	29.06	29.5	72	30	222	23
L2DRAH3078BF	2759	2928	3084	29.06	29.5	78	30	247	24
L2DRAH3084BF	2823	3010	3174	29.06	29.5	84	30	272	24
L2DRAH3672BF	2818	3009	3170	29.06	29.5	72	36	247	24
L2DRAH3678BF	2882	3087	3265	29.06	29.5	78	36	272	25
L2DRAH3684BF	2950	3170	3359	29.06	29.5	84	36	297	25

L2DBAH-FB • Bowfront Double Desk, FF Left BBF Right Recessed, Half Glazed Modesty

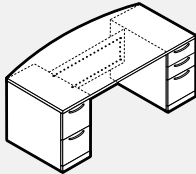

- Modesty is aluminum framed.
- Glazing is frosted acrylic.
- Optional e-lock available for each pedestal in the vertical position. Please specify V-Vertical and add \$224 list for each.

PRODUCT CODE	FINISH LP	B	W	SIZE/INCHES		W	D	WEIGHT LBS	VOL FT ³
				H(LP/B)	H(W)				
L2DBAH3060FB	2620	2780	2917	29.06	29.5	60	36	340	23
L2DBAH3066FB	2694	2867	3015	29.06	29.5	66	36	348	24
L2DBAH3072FB	2758	2949	3106	29.06	29.5	72	36	359	24
L2DBAH3078FB	2822	3027	3200	29.06	29.5	78	36	384	25
L2DBAH3084FB	2892	3113	3295	29.06	29.5	84	36	409	25
L2DBAH3672FB	2877	3099	3278	29.06	29.5	72	42	384	25
L2DBAH3678FB	2948	3187	3377	29.06	29.5	78	42	409	26
L2DBAH3684FB	3016	3277	3480	29.06	29.5	84	42	434	26

L2DBAH-BF • Bowfront Double Desk, BBF Left FF Right Recessed, Half Glazed Modesty

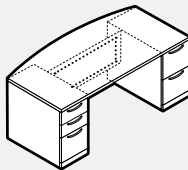

- Modesty is aluminum framed.
- Glazing is frosted acrylic.
- Optional e-lock available for each pedestal in the vertical position. Please specify V-Vertical and add \$224 list for each.

PRODUCT CODE	FINISH LP	B	W	SIZE/INCHES		W	D	WEIGHT LBS	VOL FT ³
				H(LP/B)	H(W)				
L2DBAH3060BF	2620	2780	2917	29.06	29.5	60	36	340	23
L2DBAH3066BF	2694	2867	3015	29.06	29.5	66	36	348	24
L2DBAH3072BF	2758	2949	3106	29.06	29.5	72	36	359	24
L2DBAH3078BF	2822	3027	3200	29.06	29.5	78	36	384	25
L2DBAH3084BF	2892	3113	3295	29.06	29.5	84	36	409	25
L2DBAH3672BF	2877	3099	3278	29.06	29.5	72	42	384	25
L2DBAH3678BF	2948	3187	3377	29.06	29.5	78	42	409	26
L2DBAH3684BF	3016	3277	3480	29.06	29.5	84	42	434	26

L2ER-FL • Executive Return with FF Pedestal Left

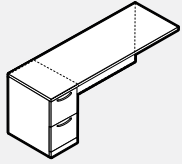

• Optional e-lock available for the pedestal in the vertical position. Please specify V-Vertical and add \$224 list.

PRODUCT CODE	FINISH LP	B	W	SIZE / INCHES				WEIGHT LBS	VOL FT ³
				H(LP/B)	H(W)	W	D		
L2ER2036FL	1135	1199	1264	29	29.5	36	20	151	12
L2ER2042FL	1174	1252	1327	29	29.5	42	20	172	12
L2ER2048FL	1220	1301	1388	29	29.5	48	20	179	12
L2ER2054FL	1258	1354	1448	29	29.5	54	20	184	13
L2ER2436FL	1179	1249	1317	29	29.5	36	24	151	12
L2ER2442FL	1223	1300	1381	29	29.5	42	24	172	12
L2ER2448FL	1264	1354	1442	29	29.5	48	24	179	13
L2ER2454FL	1309	1409	1505	29	29.5	54	24	184	13

L2ER-FR • Executive Return with FF Pedestal Right

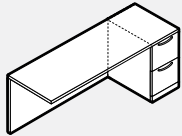

• Optional e-lock available for the pedestal in the vertical position. Please specify V-Vertical and add \$224 list.

PRODUCT CODE	FINISH LP	B	W	SIZE / INCHES				WEIGHT LBS	VOL FT ³
				H(LP/B)	H(W)	W	D		
L2ER2036FR	1135	1199	1264	29	29.5	36	20	151	12
L2ER2042FR	1174	1252	1327	29	29.5	42	20	172	12
L2ER2048FR	1220	1301	1388	29	29.5	48	20	179	12
L2ER2054FR	1258	1354	1448	29	29.5	54	20	184	13
L2ER2436FR	1179	1249	1317	29	29.5	36	24	151	12
L2ER2442FR	1223	1300	1381	29	29.5	42	24	172	12
L2ER2448FR	1264	1354	1442	29	29.5	48	24	179	13
L2ER2454FR	1309	1409	1505	29	29.5	54	24	184	13

L2ERH-FL • Executive Return with FF Pedestal Left and Half Modesty

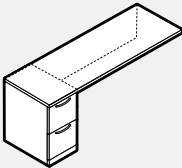

• Optional e-lock available for the pedestal in the vertical position. Please specify V-Vertical and add \$224 list.

PRODUCT CODE	FINISH LP	B	W	SIZE / INCHES				WEIGHT LBS	VOL FT ³
				H(LP/B)	H(W)	W	D		
L2ERH2036FL	1084	1148	1218	29	29.5	36	20	151	12
L2ERH2042FL	1114	1190	1264	29	29.5	42	20	172	12
L2ERH2048FL	1141	1229	1315	29	29.5	48	20	179	12
L2ERH2054FL	1170	1266	1363	29	29.5	54	20	184	13
L2ERH2436FL	1126	1196	1263	29	29.5	36	24	151	12
L2ERH2442FL	1159	1235	1316	29	29.5	42	24	172	12
L2ERH2448FL	1189	1280	1366	29	29.5	48	24	179	13
L2ERH2454FL	1221	1320	1417	29	29.5	54	24	184	13

L2ERH-FR • Executive Return with FF Pedestal Right and Half Modesty

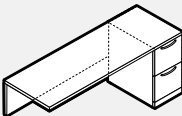

• Optional e-lock available for the pedestal in the vertical position. Please specify V-Vertical and add \$224 list.

PRODUCT CODE	FINISH LP	B	W	SIZE / INCHES				WEIGHT LBS	VOL FT ³
				H(LP/B)	H(W)	W	D		
L2ERH2036FR	1084	1148	1218	29	29.5	36	20	151	12
L2ERH2042FR	1114	1190	1264	29	29.5	42	20	172	12
L2ERH2048FR	1141	1229	1315	29	29.5	48	20	179	12
L2ERH2054FR	1170	1266	1363	29	29.5	54	20	184	13
L2ERH2436FR	1126	1196	1263	29	29.5	36	24	151	12
L2ERH2442FR	1159	1235	1316	29	29.5	42	24	172	12
L2ERH2448FR	1189	1280	1366	29	29.5	48	24	179	13
L2ERH2454FR	1221	1320	1417	29	29.5	54	24	184	13

L2ER-BL • Executive Return with BBF Pedestal Left

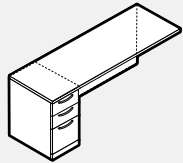

• Optional e-lock available for the pedestal in the vertical position. Please specify V-Vertical and add \$224 list.

PRODUCT CODE	FINISH LP	B	W	SIZE/INCHES				WEIGHT LBS	VOL FT ³
				H(LP/B)	H(W)	W	D		
L2ER2036BL	1196	1260	1327	29	29.5	36	20	151	12
L2ER2042BL	1235	1313	1388	29	29.5	42	20	172	12
L2ER2048BL	1279	1364	1448	29	29.5	48	20	179	12
L2ER2054BL	1318	1416	1509	29	29.5	54	20	184	13
L2ER2436BL	1242	1312	1381	29	29.5	36	24	151	12
L2ER2442BL	1286	1364	1442	29	29.5	42	24	172	12
L2ER2448BL	1328	1418	1505	29	29.5	48	24	179	13
L2ER2454BL	1373	1472	1569	29	29.5	54	24	184	13

L2ER-BR • Executive Return with BBF Pedestal Right

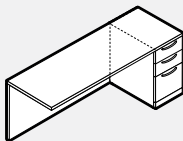

• Optional e-lock available for the pedestal in the vertical position. Please specify V-Vertical and add \$224 list.

PRODUCT CODE	FINISH LP	B	W	SIZE/INCHES				WEIGHT LBS	VOL FT ³
				H(LP/B)	H(W)	W	D		
L2ER2036BR	1196	1260	1327	29	29.5	36	20	151	12
L2ER2042BR	1235	1313	1388	29	29.5	42	20	172	12
L2ER2048BR	1279	1364	1448	29	29.5	48	20	179	12
L2ER2054BR	1318	1416	1509	29	29.5	54	20	184	13
L2ER2436BR	1242	1312	1381	29	29.5	36	24	151	12
L2ER2442BR	1286	1364	1442	29	29.5	42	24	172	12
L2ER2448BR	1328	1418	1505	29	29.5	48	24	179	13
L2ER2454BR	1373	1472	1569	29	29.5	54	24	184	13

L2ERH-BL • Executive Return with BBF Pedestal Left and Half Modesty

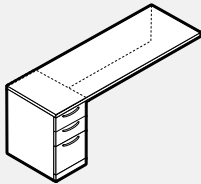

• Optional e-lock available for the pedestal in the vertical position. Please specify V-Vertical and add \$224 list.

PRODUCT CODE	FINISH LP	B	W	SIZE/INCHES				WEIGHT LBS	VOL FT ³
				H(LP/B)	H(W)	W	D		
L2ERH2036BL	1143	1207	1279	29	29.5	36	20	151	12
L2ERH2042BL	1173	1251	1326	29	29.5	42	20	172	12
L2ERH2048BL	1202	1289	1375	29	29.5	48	20	179	12
L2ERH2054BL	1232	1329	1423	29	29.5	54	20	184	13
L2ERH2436BL	1190	1258	1327	29	29.5	36	24	151	12
L2ERH2442BL	1222	1299	1378	29	29.5	42	24	172	12
L2ERH2448BL	1252	1342	1430	29	29.5	48	24	179	13
L2ERH2454BL	1284	1384	1481	29	29.5	54	24	184	13

L2ERH-BR • Executive Return with BBF Pedestal Right and Half Modesty

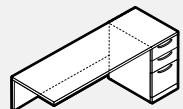

• Optional e-lock available for the pedestal in the vertical position. Please specify V-Vertical and add \$224 list.

PRODUCT CODE	FINISH LP	B	W	SIZE/INCHES				WEIGHT LBS	VOL FT ³
				H(LP/B)	H(W)	W	D		
L2ERH2036BR	1143	1207	1279	29	29.5	36	20	151	12
L2ERH2042BR	1173	1251	1326	29	29.5	42	20	172	12
L2ERH2048BR	1202	1289	1375	29	29.5	48	20	179	12
L2ERH2054BR	1232	1329	1423	29	29.5	54	20	184	13
L2ERH2436BR	1190	1258	1327	29	29.5	36	24	151	12
L2ERH2442BR	1222	1299	1378	29	29.5	42	24	172	12
L2ERH2448BR	1252	1342	1430	29	29.5	48	24	179	13
L2ERH2454BR	1284	1384	1481	29	29.5	54	24	184	13

Technical Information

Technical Information

Reception Desk:

- All desks are shipped KD.
- Centre desk reception transaction top is available in "LP", "B" or "W" thickness to match the thickness and profile of worksurface edge.
- All other exposed edges are banded with 3mm PVC.
- Center unit is freestanding and can be connected on one or both sides with a return or bridge.
- **Bridge unit is connected to the centre unit to extend the return on either side. This unit must be connected on both ends and nonhanded.**
- Left or right hand unit is designed to extend the centre unit. This unit must be connected on one end.
- **Can be used as a freestanding unit or connected with surrounding bridge or corner surround.**
- **Comes with transaction top.**

DESKS • GUIDELINES FOR ORDERING PRODUCT

CODES: The price list uses a numbering system with meaningful alphanumeric characters to create a simple-to-understand product number. This makes specifying the product much easier and more accurate.

SPECIFICATION EXAMPLE OF A GALLERY RECEPTION DESK UNIT

PRODUCT CODE: L2GR66
 L2 = New Licence
 G = Gallery
 R = Reception
 66 = Size: Width

OPTIONS:
 Top: LP - LP (Low Pressure Laminate) Thickness 1"
 HP B - B Thickness 1 1/16"
 HP W - W Thickness 1 7/16"

Top Finish Laminate: Choose Colour

Top PVC Edging: Choose Colour

Chassis Laminate: Choose Colour

Chassis PVC Edging: Choose Colour

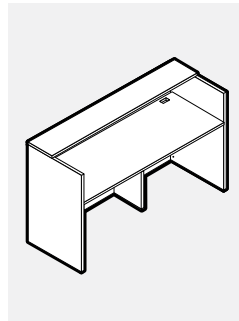

L2GR • Gallery Reception Desk

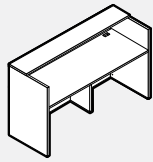

- Two grommets installed TL/TR.

PRODUCT CODE	FINISH LP	SIZE/INCHES			H (LP/B)	H (W)	W	D	WEIGHT LBS	VOL FT³
		B	W	D						
L2GR66	1313	1647	1834	42.315	42.750	66	25	149	15	
L2GR72	1381	1745	1943	42.315	42.750	72	25	163	17	
L2GR78	1447	1837	2055	42.315	42.750	78	25	166	18	
L2GR84	1515	1932	2166	42.315	42.750	84	25	171	20	
L2GR96	1648	2123	2389	42.315	42.750	96	25	178	23	

L2GB • Gallery Bridge

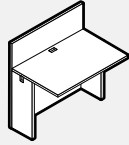

- One grommet installed TC.

PRODUCT CODE	FINISH LP	SIZE/INCHES			H (LP/B)	H (W)	W	D	WEIGHT LBS	VOL FT³
		B	W	D						
L2GB42	585	716	778	41.315	41.315	42	25	79	10	
L2GB48	639	788	859	41.315	41.315	48	25	86	12	
L2GB54	693	859	938	41.315	41.315	54	25	95	13	
L2GB60	744	928	1020	41.315	41.315	60	25	101	14	

L2GR-L • Gallery Left Return

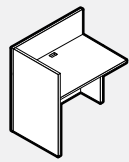

- One grommet installed TC.

PRODUCT CODE	FINISH LP	SIZE/INCHES			H (LP/B)	H (W)	W	D	WEIGHT LBS	VOL FT³
		B	W	D						
L2GR36L	652	773	829	41.315	41.315	36	25	90	9	
L2GR42L	705	843	910	41.315	41.315	42	25	97	11	
L2GR48L	762	915	992	41.315	41.315	48	25	106	13	
L2GR54L	816	987	1071	41.315	41.315	54	25	119	14	
L2GR60L	868	1057	1151	866	901	60	25	132	16	

L2GR-R • Gallery Right Return

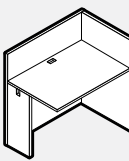

- One grommet installed TC.

PRODUCT CODE	FINISH LP	SIZE/INCHES			H (LP/B)	H (W)	W	D	WEIGHT LBS	VOL FT³
		B	W	D						
L2GR36R	652	773	829	41.315	41.315	36	25	90	9	
L2GR42R	705	843	910	41.315	41.315	42	25	97	11	
L2GR48R	762	915	992	41.315	41.315	48	25	106	13	
L2GR54R	816	987	1071	41.315	41.315	54	25	119	14	
L2GR60R	868	1057	1151	866	901	60	25	132	16	

L2GD • Gallery Desk Decorative Panel

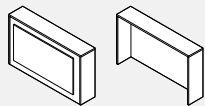

Front Back

- To be used in conjunction with a 66", 72" or 84" rectangular desk shell.
- Decorative Panel is high pressure laminate.

PRODUCT CODE	FINISH LP	SIZE/INCHES			H (LP/B)	H (W)	W	D	WEIGHT LBS	VOL FT³
		B	W	D						
L2GD66	1618	1757	1906	42.315	42.750	68.25	12	99	20	
L2GD72	1837	1999	2171	42.315	42.750	74.25	12	113	22	
L2GD84	1970	2149	2344	42.315	42.750	86.25	12	117	25	

L2GDP • Gallery Desk with Pigeon Holes and Decorative Panel

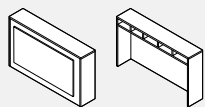

Front Back

- To be used in conjunction with a 66", 72" or 84" rectangular desk shell.
- Decorative Panel is high pressure laminate.

PRODUCT CODE	FINISH LP	SIZE/INCHES			H (LP/B)	H (W)	W	D	WEIGHT LBS	VOL FT³
		B	W	D						
L2GDP66	1682	1863	2016	42.315	42.750	68.25	12	99	20	
L2GDP72	1906	2119	2298	42.315	42.750	74.25	12	113	22	
L2GDP84	2055	2287	2488	42.315	42.750	86.25	12	117	25	

L2GRKIT • Reception Kit Gallery

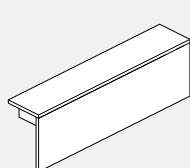

- Unit to be placed on L2DR or L2CRS Desk Shell

PRODUCT CODE	FINISH LP	SIZE/INCHES			H (LP/B)	H (W)	W	D	WEIGHT LBS	VOL FT³
		B	W	D						
L2GRKIT36H36	406	429	446	18.37	18.75	36	12	68	1.50	
L2GRKIT42H36	443	471	492	18.37	18.75	42	12	79	1.75	
L2GRKIT48H36	481	518	535	18.37	18.75	48	12	90	2.00	
L2GRKIT54H36	521	557	583	18.37	18.75	54	12	101	2.25	
L2GRKIT60H36	558	601	626	18.37	18.75	60	12	113	2.50	
L2GRKIT36H42	449	494	509	24.37	24.75	36	12	68	1.50	
L2GRKIT42H42	495	547	564	24.37	24.75	42	12	79	1.75	
L2GRKIT48H42	539	596	620	24.37	24.75	48	12	90	2.00	
L2GRKIT54H42	586	650	674	24.37	24.75	54	12	101	2.25	
L2GRKIT60H42	633	702	730	24.37	24.75	60	12	113	2.50	

Technical Information

- All Desks and connecting shells are Shipped knocked down (KD).
- All connecting units must be connected to an adjoining worksurface where there is either no end gable or a narrow gable with flat brackets.
- Gables & partial gables are interchangeable.
- All bottom edges are edge banded.
- Each shell allows for grommet (BG5) to be specified at no upcharge. Please see general information (Section A) for location.

DESKS • GUIDELINES FOR ORDERING PRODUCT

CODES: The price list uses a numbering system with meaningful alphanumeric characters to create a simple-to-understand product number. This makes specifying the product much easier and more accurate.

SPECIFICATION EXAMPLE OF A DESK UNIT

PRODUCT CODE: L2DR3060
 L2 = New Licence
 D = Desk
 R = Rectangular
 3060 = Size: Depth x Width

OPTIONS:
 Top: LP - LP (Low Pressure Laminate) Thickness 1"
 HP B - B Thickness 1 1/16"
 HP W - W Thickness 1 7/16"

Top Finish Laminate: Choose Colour
 Top PVC Edging: Choose Colour
 Chassis Laminate: Choose Colour
 Chassis PVC Edging: Choose Colour

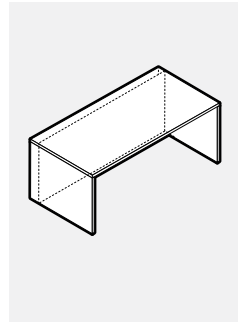

SPECIFICATION EXAMPLE OF A CONNECTING RETURN UNIT

PRODUCT CODE: L2RCH2030R
 L2 = New Licence
 R = Return
 C = Connecting
 H = Half Back Panel
 2030 = Size: Depth x Width
 R = Connecting on Right

OPTIONS:
 Top: LP - LP (Low Pressure Laminate) Thickness 1"
 HP B - B Thickness 1 1/16"
 HP W - W Thickness 1 7/16"

Top Finish Laminate: Choose Colour
 Top PVC Edging: Choose Colour
 Chassis Laminate: Choose Colour
 Chassis PVC Edging: Choose Colour

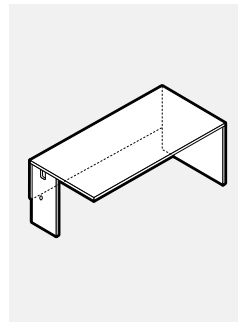

L2DR • Rectangular Desk, Recessed Modesty

• All recessed modesties are inset 6" from the visitor edge.

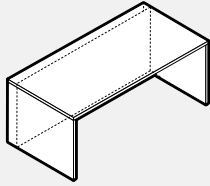

PRODUCT CODE	FINISH			SIZE/INCHES				WEIGHT LBS	VOL FT ³
	LP	B	W	H(LP/B)	H(W)	W	D		
L2DR3060	853	1041	1169	29	29.5	60	30	136	6
L2DR3066	898	1102	1247	29	29.5	66	30	145	7
L2DR3072	943	1165	1317	29	29.5	72	30	155	7
L2DR3078	988	1227	1389	29	29.5	78	30	175	9
L2DR3084	1038	1293	1471	29	29.5	84	30	185	10
L2DR3660	949	1170	1320	29	29.5	60	36	155	7
L2DR3666	999	1239	1401	29	29.5	66	36	165	9
L2DR3672	1051	1312	1484	29	29.5	72	36	176	9
L2DR3678	1098	1381	1568	29	29.5	78	36	197	11
L2DR3684	1153	1455	1654	29	29.5	84	36	208	12

L2DB • Bowfront Desk, Recessed Modesty

• All recessed modesties are inset 6" from the visitor edge.

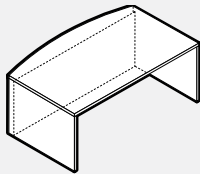

PRODUCT CODE	FINISH			SIZE/INCHES				WEIGHT LBS	VOL FT ³
	LP	B	W	H(LP/B)	H(W)	W	D		
L2DB3060	909	1132	1286	29	29.5	60	36	155	7
L2DB3066	958	1199	1366	29	29.5	66	36	165	9
L2DB3072	1007	1266	1451	29	29.5	72	36	176	9
L2DB3078	1057	1338	1531	29	29.5	78	36	197	11
L2DB3084	1111	1415	1620	29	29.5	84	36	208	12
L2DB3660	1007	1261	1433	29	29.5	60	42	155	7
L2DB3666	1060	1338	1527	29	29.5	66	42	165	9
L2DB3672	1114	1415	1618	29	29.5	72	42	176	9
L2DB3678	1166	1493	1707	29	29.5	78	42	197	11
L2DB3684	1227	1573	1807	29	29.5	84	42	208	12

L2CRS • Credenza Shell, Full End Gables on Both Sides and Flush Back

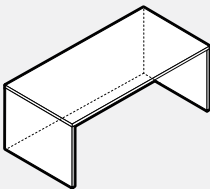

PRODUCT CODE	FINISH			SIZE/INCHES				WEIGHT LBS	VOL FT ³
	LP	B	W	H(LP/B)	H(W)	W	D		
L2CRS2024	503	575	625	29	29.5	24	20	68	3
L2CRS2030	546	633	691	29	29.5	30	20	77	3
L2CRS2036	586	681	756	29	29.5	36	20	87	3
L2CRS2042	625	737	820	29	29.5	42	20	94	3
L2CRS2048	668	793	884	29	29.5	48	20	102	4
L2CRS2054	705	847	948	29	29.5	54	20	109	4
L2CRS2060	756	909	1021	29	29.5	60	20	118	4
L2CRS2066	799	965	1085	29	29.5	66	20	127	6
L2CRS2072	838	1020	1148	29	29.5	72	20	135	6
L2CRS2078	879	1074	1217	29	29.5	78	20	151	7
L2CRS2084	926	1135	1286	29	29.5	84	20	160	8
L2CRS2424	524	596	651	29	29.5	24	24	68	3
L2CRS2430	565	652	718	29	29.5	30	24	77	3
L2CRS2436	609	710	787	29	29.5	36	24	87	3
L2CRS2442	650	768	853	29	29.5	42	24	94	3
L2CRS2448	696	826	921	29	29.5	48	24	102	4
L2CRS2454	736	882	987	29	29.5	54	24	109	4
L2CRS2460	787	945	1062	29	29.5	60	24	118	4
L2CRS2466	828	1003	1131	29	29.5	66	24	127	6
L2CRS2472	870	1058	1197	29	29.5	72	24	135	6
L2CRS2478	914	1118	1262	29	29.5	78	24	151	7
L2CRS2484	963	1179	1335	29	29.5	84	24	160	8
L2CRS3030	620	724	796	29	29.5	30	30	90	3
L2CRS3036	667	787	869	29	29.5	36	30	99	3
L2CRS3042	710	847	943	29	29.5	42	30	109	4
L2CRS3048	756	909	1019	29	29.5	48	30	119	4
L2CRS3054	801	971	1089	29	29.5	54	30	127	6
L2CRS3060	853	1041	1169	29	29.5	60	30	136	6
L2CRS3066	898	1102	1247	29	29.5	66	30	145	7
L2CRS3072	943	1165	1317	29	29.5	72	30	155	7
L2CRS3078	988	1227	1389	29	29.5	78	30	175	9
L2CRS3084	1038	1293	1471	29	29.5	84	30	185	10

L2CRSH • Credenza Shell, Flush Back, Cut Out Modesty, Full End Gables on Both Sides

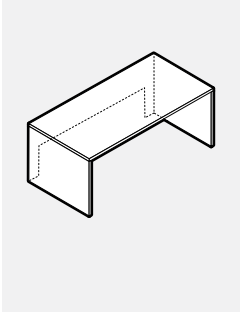

PRODUCT CODE	FINISH LP	B	W	SIZE / INCHES			WEIGHT LBS	VOL FT ³	
				H (LP/B)	H (W)	D			
L2CRSH2030	546	633	691	29	29.5	30	20	77	3
L2CRSH2036	586	681	756	29	29.5	36	20	87	3
L2CRSH2042	625	737	820	29	29.5	42	20	94	3
L2CRSH2048	668	793	884	29	29.5	48	20	102	4
L2CRSH2054	705	847	948	29	29.5	54	20	109	4
L2CRSH2060	756	909	1021	29	29.5	60	20	118	4
L2CRSH2066	799	965	1085	29	29.5	66	20	127	6
L2CRSH2072	838	1020	1148	29	29.5	72	20	135	6
L2CRSH2078	879	1074	1217	29	29.5	78	20	151	7
L2CRSH2084	926	1135	1286	29	29.5	84	20	160	8
L2CRSH2430	565	652	718	29	29.5	30	24	77	3
L2CRSH2436	609	710	787	29	29.5	36	24	87	3
L2CRSH2442	650	768	853	29	29.5	42	24	94	3
L2CRSH2448	696	826	921	29	29.5	48	24	102	4
L2CRSH2454	736	882	987	29	29.5	54	24	109	4
L2CRSH2460	787	945	1062	29	29.5	60	24	118	4
L2CRSH2466	828	1003	1131	29	29.5	66	24	127	6
L2CRSH2472	870	1058	1197	29	29.5	72	24	135	6
L2CRSH2478	914	1118	1262	29	29.5	78	24	151	7
L2CRSH2484	963	1179	1335	29	29.5	84	24	160	8
L2CRSH3030	620	724	796	29	29.5	30	30	90	3
L2CRSH3036	667	787	869	29	29.5	36	30	99	3
L2CRSH3042	710	847	943	29	29.5	42	30	109	4
L2CRSH3048	756	909	1019	29	29.5	48	30	119	4
L2CRSH3054	801	971	1089	29	29.5	54	30	127	6
L2CRSH3060	853	1041	1169	29	29.5	60	30	139	6
L2CRSH3066	898	1102	1247	29	29.5	66	30	145	7
L2CRSH3072	943	1165	1317	29	29.5	72	30	155	7
L2CRSH3078	963	1227	1389	29	29.5	78	30	175	9
L2CRSH3084	1038	1293	1471	29	29.5	84	30	185	10

L2RC-R • Return, Connecting Right, Full Gable on Right and Narrow Gable on Left

• Units are non-handed. They can be configured as either lefts or rights.

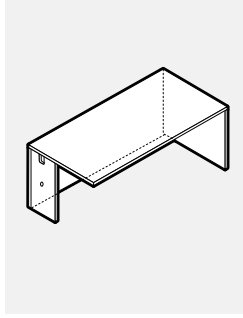

PRODUCT CODE	FINISH			SIZE / INCHES				WEIGHT LBS	VOL FT ³
	LP	B	W	H (LP/B)	H (W)	W	D		
L2RC2024R	472	545	592	29	29.5	24	20	64	3
L2RC2030R	519	601	663	29	29.5	30	20	69	3
L2RC2036R	560	656	730	29	29.5	36	20	79	3
L2RC2042R	605	715	796	29	29.5	42	20	86	3
L2RC2048R	647	771	865	29	29.5	48	20	95	4
L2RC2054R	691	829	931	29	29.5	54	20	102	4
L2RC2060R	744	899	1010	29	29.5	60	20	110	4
L2RC2066R	792	957	1077	29	29.5	66	20	119	6
L2RC2072R	838	1020	1148	29	29.5	72	20	128	6
L2RC2078R	882	1076	1220	29	29.5	78	20	143	7
L2RC2084R	926	1134	1286	29	29.5	84	20	152	8
L2RC2424R	492	562	617	29	29.5	24	24	64	3
L2RC2430R	537	622	688	29	29.5	30	24	69	3
L2RC2436R	584	681	760	29	29.5	36	24	79	3
L2RC2442R	626	741	828	29	29.5	42	24	86	3
L2RC2448R	673	802	899	29	29.5	48	24	95	4
L2RC2454R	718	865	969	29	29.5	54	24	102	4
L2RC2460R	777	935	1052	29	29.5	60	24	110	4
L2RC2466R	821	996	1122	29	29.5	66	24	119	6
L2RC2472R	870	1058	1197	29	29.5	72	24	128	6
L2RC2478R	916	1119	1264	29	29.5	78	24	143	7
L2RC2484R	963	1179	1335	29	29.5	84	24	152	8
L2RC3030R	586	686	761	29	29.5	30	30	83	3
L2RC3036R	635	752	837	29	29.5	36	30	91	3
L2RC3042R	679	817	911	29	29.5	42	30	101	4
L2RC3048R	729	882	988	29	29.5	48	30	111	4
L2RC3054R	777	945	1063	29	29.5	54	30	119	6
L2RC3060R	837	1024	1154	29	29.5	60	30	129	6
L2RC3066R	884	1088	1229	29	29.5	66	30	138	7
L2RC3072R	935	1159	1310	29	29.5	72	30	147	7
L2RC3078R	983	1223	1464	29	29.5	78	30	167	9
L2RC3084R	1032	1287	1544	29	29.5	84	30	177	10
L2RC3660R	903	1124	1271	29	29.5	60	36	145	7
L2RC3666R	957	1198	1356	29	29.5	66	36	157	9
L2RC3672R	1011	1272	1447	29	29.5	72	36	169	9
L2RC3678R	1063	1345	1531	29	29.5	78	36	190	11
L2RC3684R	1115	1417	1618	29	29.5	84	36	201	12

L2RCH-R • Half Modesty Return, Connecting Right, Full Gable on Right and Narrow Gable on Left

- Units are non-handed. They can be configured as either lefts or rights.

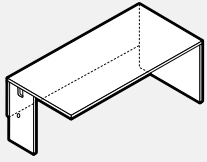

PRODUCT CODE	FINISH LP	B	W	SIZE / INCHES			WEIGHT LBS	VOL FT ³	
				H (LP/B)	H (W)	D			
L2RCH2024R	420	486	539	29	29.5	24	20	55	3
L2RCH2030R	450	530	591	29	29.5	30	20	57	3
L2RCH2036R	484	576	647	29	29.5	36	20	65	3
L2RCH2042R	513	619	702	29	29.5	42	20	69	3
L2RCH2048R	546	667	756	29	29.5	48	20	76	4
L2RCH2054R	576	706	809	29	29.5	54	20	81	4
L2RCH2060R	617	767	879	29	29.5	60	20	86	4
L2RCH2066R	650	809	931	29	29.5	66	20	92	6
L2RCH2072R	684	859	991	29	29.5	72	20	99	6
L2RCH2078R	715	903	1043	29	29.5	78	20	112	7
L2RCH2084R	748	947	1099	29	29.5	84	20	119	8
L2RCH2424R	437	505	560	29	29.5	24	24	56	3
L2RCH2430R	469	552	616	29	29.5	30	24	57	3
L2RCH2436R	502	601	673	29	29.5	36	24	65	3
L2RCH2442R	534	642	730	29	29.5	42	24	69	3
L2RCH2448R	565	691	787	29	29.5	48	24	76	4
L2RCH2454R	601	737	842	29	29.5	54	24	81	4
L2RCH2460R	642	799	911	29	29.5	60	24	86	4
L2RCH2466R	675	842	969	29	29.5	66	24	92	6
L2RCH2472R	712	893	1031	29	29.5	72	24	99	6
L2RCH2478R	743	941	1086	29	29.5	78	24	112	7
L2RCH2484R	777	987	1141	29	29.5	84	24	119	8
L2RCH3030R	521	617	691	29	29.5	30	30	77	3
L2RCH3036R	556	671	755	29	29.5	36	30	83	3
L2RCH3042R	590	722	817	29	29.5	42	30	87	4
L2RCH3048R	625	773	882	29	29.5	48	30	92	4
L2RCH3054R	663	826	944	29	29.5	54	30	98	6
L2RCH3060R	706	890	1021	29	29.5	60	30	105	6
L2RCH3066R	743	943	1084	29	29.5	66	30	111	7
L2RCH3072R	782	997	1148	29	29.5	72	30	119	7
L2RCH3078R	818	1051	1282	29	29.5	78	30	136	9
L2RCH3084R	854	1101	1348	29	29.5	84	30	144	10
L2RCH3660R	777	992	1139	29	29.5	60	36	123	7
L2RCH3666R	817	1052	1209	29	29.5	66	36	129	9
L2RCH3672R	859	1114	1287	29	29.5	72	36	141	9
L2RCH3678R	899	1170	1357	29	29.5	78	36	154	11
L2RCH3684R	938	1181	1430	29	29.5	84	36	162	12

L2RC-L • Return, Connecting Left, Full Gable on Left and Narrow Gable on Right

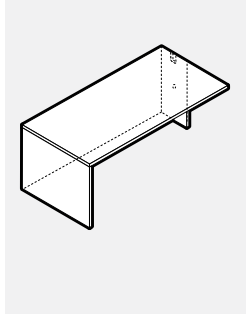

• Units are non-handed. They can be configured as either lefts or rights.

PRODUCT CODE	FINISH			SIZE / INCHES				WEIGHT LBS	VOL FT ³
	LP	B	W	H (LP/B)	H (W)	W	D		
L2RC2024L	472	545	592	29	29.5	24	20	64	3
L2RC2030L	519	601	663	29	29.5	30	20	69	3
L2RC2036L	560	656	730	29	29.5	36	20	79	3
L2RC2042L	605	715	796	29	29.5	42	20	86	3
L2RC2048L	647	771	865	29	29.5	48	20	95	4
L2RC2054L	691	829	931	29	29.5	54	20	102	4
L2RC2060L	744	899	1010	29	29.5	60	20	110	4
L2RC2066L	792	957	1077	29	29.5	66	20	119	6
L2RC2072L	838	1020	1148	29	29.5	72	20	128	6
L2RC2078L	882	1076	1220	29	29.5	78	20	143	7
L2RC2084L	926	1134	1286	29	29.5	84	20	152	8
L2RC2424L	492	562	617	29	29.5	24	24	64	3
L2RC2430L	537	622	688	29	29.5	30	24	69	3
L2RC2436L	584	681	760	29	29.5	36	24	79	3
L2RC2442L	626	741	828	29	29.5	42	24	86	3
L2RC2448L	673	802	899	29	29.5	48	24	95	4
L2RC2454L	718	865	969	29	29.5	54	24	102	4
L2RC2460L	777	935	1052	29	29.5	60	24	110	4
L2RC2466L	821	996	1122	29	29.5	66	24	119	6
L2RC2472L	870	1058	1197	29	29.5	72	24	128	6
L2RC2478L	916	1119	1264	29	29.5	78	24	143	7
L2RC2484L	963	1179	1335	29	29.5	84	24	152	8
L2RC3030L	586	686	761	29	29.5	30	30	83	3
L2RC3036L	635	752	837	29	29.5	36	30	91	3
L2RC3042L	679	817	911	29	29.5	42	30	101	4
L2RC3048L	729	882	988	29	29.5	48	30	111	4
L2RC3054L	777	945	1063	29	29.5	54	30	119	6
L2RC3060L	837	1024	1154	29	29.5	60	30	129	6
L2RC3066L	884	1088	1229	29	29.5	66	30	138	7
L2RC3072L	935	1159	1310	29	29.5	72	30	147	7
L2RC3078L	983	1223	1464	29	29.5	78	30	167	9
L2RC3084L	1032	1287	1544	29	29.5	84	30	177	10
L2RC3660L	903	1124	1271	29	29.5	60	36	145	7
L2RC3666L	957	1198	1356	29	29.5	66	36	157	9
L2RC3672L	1011	1272	1447	29	29.5	72	36	169	9
L2RC3678L	1063	1345	1531	29	29.5	78	36	190	11
L2RC3684L	1115	1417	1618	29	29.5	84	36	201	12

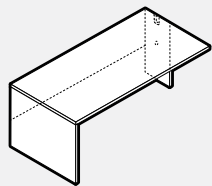
L2RCH-L • Half Modesty Return, Connecting Left, Full Gable on Left and Narrow Gable on Right

- Units are non-handed. They can be configured as either lefts or rights.

PRODUCT CODE	FINISH			SIZE / INCHES				WEIGHT		VOL FT ³
	LP	B	W	H (LP/B)	H (W)	W	D	LBS		
L2RCH2024L	420	486	539	29	29.5	24	20	55	3	
L2RCH2030L	450	530	591	29	29.5	30	20	57	3	
L2RCH2036L	484	576	647	29	29.5	36	20	65	3	
L2RCH2042L	513	619	702	29	29.5	42	20	69	3	
L2RCH2048L	546	667	756	29	29.5	48	20	76	4	
L2RCH2054L	576	706	809	29	29.5	54	20	81	4	
L2RCH2060L	617	767	879	29	29.5	60	20	86	4	
L2RCH2066L	650	809	931	29	29.5	66	20	92	5	
L2RCH2072L	684	859	991	29	29.5	72	20	99	5	
L2RCH2078L	715	903	1043	29	29.5	78	20	112	6	
L2RCH2084L	748	947	1099	29	29.5	84	20	119	7	
L2RCH2424L	437	505	560	29	29.5	24	24	56	3	
L2RCH2430L	469	552	616	29	29.5	30	24	57	3	
L2RCH2436L	502	601	673	29	29.5	36	24	65	3	
L2RCH2442L	534	642	730	29	29.5	42	24	69	3	
L2RCH2448L	565	691	787	29	29.5	48	24	76	4	
L2RCH2454L	601	737	842	29	29.5	54	24	81	4	
L2RCH2460L	642	799	911	29	29.5	60	24	86	4	
L2RCH2466L	675	842	969	29	29.5	66	24	92	5	
L2RCH2472L	712	893	1031	29	29.5	72	24	99	5	
L2RCH2478L	743	941	1086	29	29.5	78	24	112	6	
L2RCH2484L	777	987	1141	29	29.5	84	24	119	7	
L2RCH3030L	521	617	691	29	29.5	30	30	77	3	
L2RCH3036L	556	671	755	29	29.5	36	30	83	3	
L2RCH3042L	590	722	817	29	29.5	42	30	87	4	
L2RCH3048L	625	773	882	29	29.5	48	30	92	4	
L2RCH3054L	663	826	944	29	29.5	54	30	98	5	
L2RCH3060L	706	890	1021	29	29.5	60	30	105	5	
L2RCH3066L	743	943	1084	29	29.5	66	30	111	6	
L2RCH3072L	782	997	1148	29	29.5	72	30	119	6	
L2RCH3078L	818	1051	1282	29	29.5	78	30	136	8	
L2RCH3084L	854	1101	1348	29	29.5	84	30	144	9	
L2RCH3660L	777	992	1139	29	29.5	60	36	123	6	
L2RCH3666L	817	1052	1209	29	29.5	66	36	129	8	
L2RCH3672L	859	1114	1287	29	29.5	72	36	141	8	
L2RCH3678L	899	1170	1357	29	29.5	78	36	154	10	
L2RCH3684L	938	1181	1430	29	29.5	84	36	162	11	

L2RC-C • Return, Connecting Narrow Gables on Both Sides

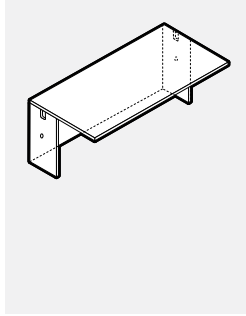

PRODUCT CODE	FINISH			SIZE / INCHES				WEIGHT LBS	VOL FT ³
	LP	B	W	H (LP/B)	H (W)	W	D		
L2RC2024C	420	488	539	29	29.5	24	20	56	3
L2RC2030C	463	524	584	29	29.5	30	20	62	3
L2RC2036C	507	576	647	29	29.5	36	20	72	3
L2RC2042C	551	634	710	29	29.5	42	20	78	3
L2RC2048C	592	686	774	29	29.5	48	20	87	4
L2RC2054C	638	739	838	29	29.5	54	20	95	4
L2RC2060C	696	806	914	29	29.5	60	20	102	4
L2RC2066C	737	860	977	29	29.5	66	20	111	6
L2RC2072C	785	919	1047	29	29.5	72	20	120	6
L2RC2078C	828	972	1109	29	29.5	78	20	135	7
L2RC2084C	870	1029	1173	29	29.5	84	20	144	8
L2RC2424C	438	507	560	29	29.5	24	24	56	3
L2RC2430C	484	546	608	29	29.5	30	24	62	3
L2RC2436C	527	603	673	29	29.5	36	24	72	3
L2RC2442C	574	656	739	29	29.5	42	24	78	3
L2RC2448C	617	713	805	29	29.5	48	24	87	4
L2RC2454C	666	769	870	29	29.5	54	24	95	4
L2RC2460C	722	839	949	29	29.5	60	24	102	4
L2RC2466C	767	895	1019	29	29.5	66	24	111	6
L2RC2472C	817	956	1088	29	29.5	72	24	120	6
L2RC2478C	862	1011	1154	29	29.5	78	24	135	7
L2RC2484C	908	1069	1222	29	29.5	84	24	144	8
L2RC3030C	541	639	712	29	29.5	30	30	75	3
L2RC3036C	587	703	788	29	29.5	36	30	84	3
L2RC3042C	636	768	866	29	29.5	42	30	94	4
L2RC3048C	681	796	899	29	29.5	48	30	103	4
L2RC3054C	732	858	970	29	29.5	54	30	116	6
L2RC3060C	792	931	1056	29	29.5	60	30	121	6
L2RC3066C	839	992	1126	29	29.5	66	30	130	7
L2RC3072C	891	1057	1201	29	29.5	72	30	140	7
L2RC3078C	938	1119	1277	29	29.5	78	30	160	9
L2RC3084C	987	1177	1349	29	29.5	84	30	169	10

L2RCH-C • Half Modesty Return, Connecting Narrow Gables on Both Sides

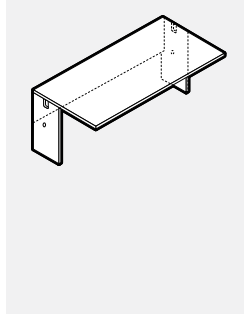

PRODUCT CODE	FINISH			SIZE/INCHES				WEIGHT LBS	VOL FT³
	LP	B	W	H (LP/B)	H (W)	W	D		
L2RCH2024C	366	430	485	29	29.5	24	20	46	3
L2RCH2030C	398	476	537	29	29.5	30	20	50	3
L2RCH2036C	429	523	591	29	29.5	36	20	57	3
L2RCH2042C	461	564	647	29	29.5	42	20	62	3
L2RCH2048C	493	611	701	29	29.5	48	20	68	4
L2RCH2054C	507	652	756	29	29.5	54	20	74	4
L2RCH2060C	551	712	825	29	29.5	60	20	78	4
L2RCH2066C	584	756	877	29	29.5	66	20	85	6
L2RCH2072C	616	803	934	29	29.5	72	20	91	6
L2RCH2078C	647	849	991	29	29.5	78	20	105	7
L2RCH2084C	678	893	1043	29	29.5	84	20	111	8
L2RCH2424C	383	449	503	29	29.5	24	24	46	3
L2RCH2430C	417	495	560	29	29.5	30	24	50	3
L2RCH2436C	447	541	616	29	29.5	36	24	57	3
L2RCH2442C	480	587	673	29	29.5	42	24	62	3
L2RCH2448C	512	636	730	29	29.5	48	24	68	4
L2RCH2454C	527	679	787	29	29.5	54	24	74	4
L2RCH2460C	574	739	857	29	29.5	60	24	78	4
L2RCH2466C	607	787	911	29	29.5	66	24	85	6
L2RCH2472C	640	837	971	29	29.5	72	24	91	6
L2RCH2478C	673	883	1029	29	29.5	78	24	105	7
L2RCH2484C	704	928	1085	29	29.5	84	24	111	8
L2RCH3030C	473	573	642	29	29.5	30	30	72	3
L2RCH3036C	509	620	704	29	29.5	36	30	80	3
L2RCH3042C	546	673	768	29	29.5	42	30	85	4
L2RCH3048C	583	727	832	29	29.5	48	30	90	4
L2RCH3054C	616	778	895	29	29.5	54	30	95	6
L2RCH3060C	666	842	971	29	29.5	60	30	97	6
L2RCH3066C	700	894	1035	29	29.5	66	30	103	7
L2RCH3072C	737	949	1102	29	29.5	72	30	111	7
L2RCH3078C	773	1003	1165	29	29.5	78	30	129	9
L2RCH3084C	807	1055	1228	29	29.5	84	30	136	10

L2RCS • Return Connecting Swerve Left

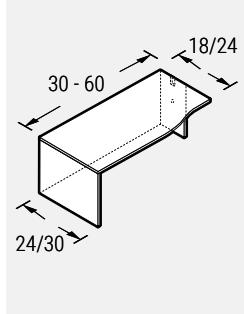

PRODUCT CODE	FINISH			SIZE/INCHES				WEIGHT LBS	VOL FT³
	LP	B	W	H (LP/B)	H (W)	W	D		
L2RCS243018	569	652	761	29	29.5	30	24	70	2
L2RCS243618	612	712	828	29	29.5	36	24	79	3
L2RCS244218	653	769	895	29	29.5	42	24	88	3
L2RCS244818	700	827	963	29	29.5	48	24	97	4
L2RCS245418	741	884	1031	29	29.5	54	24	106	4
L2RCS246018	800	955	1110	29	29.5	60	24	114	4
L2RCS303024	619	724	839	29	29.5	30	30	81	3
L2RCS303624	668	788	915	29	29.5	36	30	91	3
L2RCS304224	715	853	992	29	29.5	42	30	109	4
L2RCS304824	763	916	1069	29	29.5	48	30	119	4
L2RCS305424	809	982	1143	29	29.5	54	30	127	6
L2RCS306024	859	1048	1222	29	29.5	60	30	136	6

L2RCS • Return Connecting Swerve Right

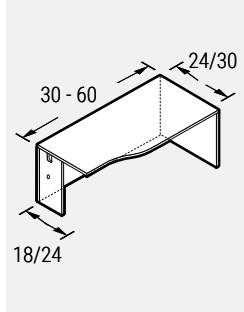

PRODUCT CODE	FINISH			SIZE/INCHES				WEIGHT LBS	VOL FT³
	LP	B	W	H (LP/B)	H (W)	W	D		
L2RCS183024	569	652	761	29	29.9	30	24	70	2
L2RCS183624	612	712	828	29	29.5	36	24	79	3
L2RCS184224	653	769	895	29	29.5	42	24	88	3
L2RCS184824	700	827	963	29	29.5	48	24	97	4
L2RCS185424	741	884	1031	29	29.5	54	24	106	4
L2RCS186024	800	955	1110	29	29.5	60	24	114	4
L2RCS243030	619	724	839	29	29.5	30	30	81	3
L2RCS243630	668	788	915	29	29.5	36	30	91	3
L2RCS244230	715	853	992	29	29.5	42	30	109	4
L2RCS244830	763	916	1069	29	29.5	48	30	119	4
L2RCS245430	809	982	1143	29	29.5	54	30	127	6
L2RCS246030	859	1048	1222	29	29.5	60	30	136	6

L2RCSH • Return Connecting Swerve Left with Half Modesty Panel

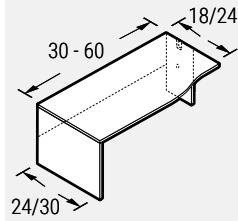

PRODUCT CODE	FINISH LP	B	W	SIZE/INCHES			D	WEIGHT LBS	VOL FT ³
				H(LP/B)	H(W)	W			
L2RCSH243018	503	586	693	29	29.5	30	24	61	2
L2RCSH243618	534	633	744	29	29.5	36	24	65	3
L2RCSH244218	564	674	801	29	29.5	42	24	72	3
L2RCSH244818	596	719	857	29	29.5	48	24	77	4
L2RCSH245418	626	763	909	29	29.5	54	24	84	4
L2RCSH246018	672	821	975	29	29.5	60	24	90	4
L2RCSH303024	553	652	771	29	29.5	30	30	78	3
L2RCSH303624	589	704	835	29	29.5	36	30	88	3
L2RCSH304224	624	757	898	29	29.5	42	30	105	4
L2RCSH304824	660	809	959	29	29.5	48	30	114	4
L2RCSH305424	697	862	1024	29	29.5	54	30	121	5
L2RCSH306024	732	914	1086	29	29.5	60	30	130	5

L2RCSH • Return Connecting Swerve Right with Half Modesty Panel

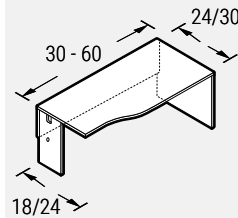

PRODUCT CODE	FINISH LP	B	W	SIZE/INCHES			D	WEIGHT LBS	VOL FT ³
				H(LP/B)	H(W)	W			
L2RCSH183024	503	586	693	29	29.5	30	24	61	2
L2RCSH183624	534	633	744	29	29.5	36	24	65	3
L2RCSH184224	564	674	801	29	29.5	42	24	72	3
L2RCSH184824	596	719	857	29	29.5	48	24	77	4
L2RCSH185424	626	763	909	29	29.5	54	24	84	4
L2RCSH186024	672	821	975	29	29.5	60	24	90	4
L2RCSH243030	553	652	771	29	29.5	30	30	78	3
L2RCSH243630	589	704	835	29	29.5	36	30	88	3
L2RCSH244230	624	757	898	29	29.5	42	30	105	4
L2RCSH244830	660	809	959	29	29.5	48	30	114	4
L2RCSH245430	697	862	1024	29	29.5	54	30	121	6
L2RCSH246030	732	914	1086	29	29.5	60	30	130	6

L2RCW • Return Connecting Wedge Left

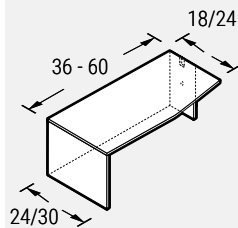

PRODUCT CODE	FINISH LP	B	W	SIZE/INCHES			D	WEIGHT LBS	VOL FT ³
				H(LP/B)	H(W)	W			
L2RCW243018	569	652	761	29	29.5	30	24	70	2
L2RCW243618	612	712	828	29	29.5	36	24	79	3
L2RCW244218	653	769	895	29	29.5	42	24	88	3
L2RCW244818	700	827	963	29	29.5	48	24	97	4
L2RCW245418	741	884	1031	29	29.5	54	24	106	4
L2RCW246018	800	955	1110	29	29.5	60	24	114	4
L2RCW303024	619	724	839	29	29.5	30	30	81	3
L2RCW303624	668	788	915	29	29.5	36	30	91	3
L2RCW304224	715	853	992	29	29.5	42	30	109	4
L2RCW304824	763	916	1069	29	29.5	48	30	119	4
L2RCW305424	809	982	1143	29	29.5	54	30	127	6
L2RCW306024	859	1048	1222	29	29.5	60	30	136	6

L2RCW • Return Connecting Wedge Right

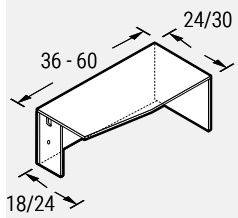

PRODUCT CODE	FINISH LP	B	W	SIZE/INCHES			D	WEIGHT LBS	VOL FT ³
				H(LP/B)	H(W)	W			
L2RCW183024	569	652	761	29	29.5	30	24	70	2
L2RCW183624	612	712	828	29	29.5	36	24	79	3
L2RCW184224	653	769	895	29	29.5	42	24	88	3
L2RCW184824	700	827	963	29	29.5	48	24	97	4
L2RCW185424	741	884	1031	29	29.5	54	24	106	4
L2RCW186024	800	955	1110	29	29.5	60	24	114	4
L2RCW243030	619	724	839	29	29.5	30	30	81	3
L2RCW243630	668	788	915	29	29.5	36	30	91	3
L2RCW244230	715	853	992	29	29.5	42	30	109	4
L2RCW244830	763	916	1069	29	29.5	48	30	119	4
L2RCW245430	809	982	1143	29	29.5	54	30	127	6
L2RCW246030	859	1048	1222	29	29.5	60	30	136	6

L2RCWH • Return Connecting Wedge Left with Half Modesty

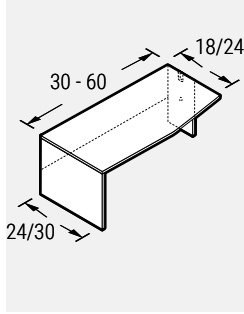

PRODUCT CODE	FINISH LP	B	W	SIZE/INCHES				WEIGHT		VOL FT ³
				H (LP/B)	H (W)	W	D	LBS		
L2RCWH243018	503	586	693	29	29.5	30	24	61	2	
L2RCWH243618	534	633	744	29	29.5	36	24	65	3	
L2RCWH244218	564	674	801	29	29.5	42	24	72	3	
L2RCWH244818	596	719	857	29	29.5	48	24	77	4	
L2RCWH245418	626	763	909	29	29.5	54	24	84	4	
L2RCWH246018	672	821	975	29	29.5	60	24	90	4	
L2RCWH303024	553	652	771	29	29.5	30	30	78	3	
L2RCWH303624	589	704	835	29	29.5	36	30	88	3	
L2RCWH304224	624	757	898	29	29.5	42	30	105	4	
L2RCWH304824	660	809	959	29	29.5	48	30	114	4	
L2RCWH305424	697	862	1024	29	29.5	54	30	121	6	
L2RCWH306024	732	914	1086	29	29.5	60	30	130	6	

L2RCWH • Return Connecting Wedge Right with Half Modesty

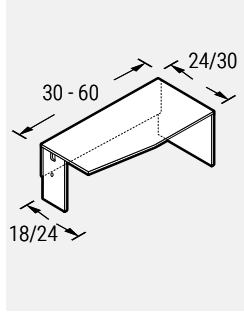

PRODUCT CODE	FINISH LP	B	W	SIZE/INCHES				WEIGHT		VOL FT ³
				H (LP/B)	H (W)	W	D	LBS		
L2RCWH183024	503	586	693	29	29.5	30	24	61	2	
L2RCWH183624	534	633	744	29	29.5	36	24	65	3	
L2RCWH184224	564	674	801	29	29.5	42	24	72	3	
L2RCWH184824	596	719	857	29	29.5	48	24	77	4	
L2RCWH185424	626	763	909	29	29.5	54	24	84	4	
L2RCWH186024	672	821	975	29	29.5	60	24	90	4	
L2RCWH243030	553	652	771	29	29.5	30	30	78	3	
L2RCWH243630	589	704	835	29	29.5	36	30	88	3	
L2RCWH244230	624	757	898	29	29.5	42	30	105	4	
L2RCWH244830	660	809	959	29	29.5	48	30	114	4	
L2RCWH245430	697	862	1024	29	29.5	54	30	121	6	
L2RCWH246030	732	914	1086	29	29.5	60	30	130	6	

L2ER-L • Executive Return Left

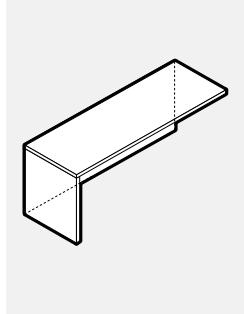

• Units are non-handed. They can be configured as either lefts or rights.

PRODUCT CODE	FINISH LP	B	W	SIZE/INCHES				WEIGHT		VOL FT ³
				H (LP/B)	H (W)	W	D	LBS		
L2ER2024L	378	442	493	29	29.5	24	20	25	3	
L2ER2030L	421	501	560	29	29.5	30	20	29	3	
L2ER2036L	469	561	637	29	29.5	36	20	32	3	
L2ER2042L	520	625	706	29	29.5	42	20	35	3	
L2ER2048L	561	681	777	29	29.5	48	20	37	4	
L2ER2054L	607	740	843	29	29.5	54	20	40	4	
L2ER2060L	663	809	926	29	29.5	60	20	44	4	
L2ER2066L	704	868	992	29	29.5	66	20	46	6	
L2ER2072L	750	927	1062	29	29.5	72	20	50	6	
L2ER2424L	393	461	512	29	29.5	24	24	25	3	
L2ER2430L	438	521	583	29	29.5	30	24	29	3	
L2ER2436L	488	585	663	29	29.5	36	24	32	3	
L2ER2442L	539	650	737	29	29.5	42	24	35	3	
L2ER2448L	585	710	806	29	29.5	48	24	37	4	
L2ER2454L	633	769	879	29	29.5	54	24	40	4	
L2ER2460L	688	842	959	29	29.5	60	24	44	4	
L2ER2466L	733	903	1032	29	29.5	66	24	46	6	
L2ER2472L	778	965	1106	29	29.5	72	24	50	6	

L2ERH-L • Executive Return Left, Half Modesty

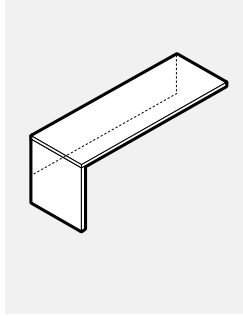

• Units are non-handed. They can be configured as either lefts or rights.

PRODUCT CODE	FINISH			SIZE/INCHES				WEIGHT LBS	VOL FT ³
	LP	B	W	H (LP/B)	H (W)	W	D		
L2ERH2024L	326	387	438	29	29.5	24	20	25	3
L2ERH2030L	356	430	492	29	29.5	30	20	29	3
L2ERH2036L	397	486	560	29	29.5	36	20	32	3
L2ERH2042L	428	530	615	29	29.5	42	20	35	3
L2ERH2048L	459	576	671	29	29.5	48	20	37	4
L2ERH2054L	492	619	724	29	29.5	54	20	40	4
L2ERH2060L	534	677	792	29	29.5	60	20	44	4
L2ERH2066L	564	722	843	29	29.5	66	20	46	6
L2ERH2072L	594	767	902	29	29.5	72	20	50	6
L2ERH2424L	337	400	457	29	29.5	24	24	25	3
L2ERH2430L	369	449	509	29	29.5	30	24	29	3
L2ERH2436L	413	505	584	29	29.5	36	24	32	3
L2ERH2442L	446	552	639	29	29.5	42	24	35	3
L2ERH2448L	477	601	697	29	29.5	48	24	37	4
L2ERH2454L	509	646	752	29	29.5	54	24	40	4
L2ERH2460L	556	703	821	29	29.5	60	24	44	4
L2ERH2466L	587	751	879	29	29.5	66	24	46	6
L2ERH2472L	619	799	941	29	29.5	72	24	50	6

L2ER-R • Executive Return Right

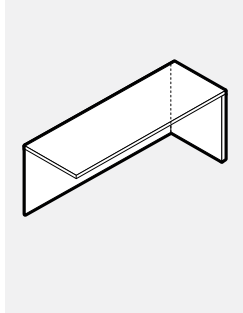

• Units are non-handed. They can be configured as either lefts or rights.

PRODUCT CODE	FINISH			SIZE/INCHES				WEIGHT LBS	VOL FT ³
	LP	B	W	H (LP/B)	H (W)	W	D		
L2ER2024R	378	442	493	29	29.5	24	20	55	3
L2ER2030R	421	501	560	29	29.5	30	20	63	3
L2ER2036R	469	561	637	29	29.5	36	20	70	3
L2ER2042R	520	625	706	29	29.5	42	20	77	3
L2ER2048R	561	681	777	29	29.5	48	20	87	4
L2ER2054R	607	740	843	29	29.5	54	20	92	4
L2ER2060R	663	809	926	29	29.5	60	20	102	4
L2ER2066R	704	868	992	29	29.5	66	20	110	6
L2ER2072R	750	927	1062	29	29.5	72	20	119	6
L2ER2424R	393	461	512	29	29.5	24	24	55	3
L2ER2430R	438	521	583	29	29.5	30	24	63	3
L2ER2436R	488	585	663	29	29.5	36	24	70	3
L2ER2442R	539	650	737	29	29.5	42	24	77	3
L2ER2448R	585	710	806	29	29.5	48	24	87	4
L2ER2454R	633	769	879	29	29.5	54	24	92	4
L2ER2460R	688	842	959	29	29.5	60	24	102	4
L2ER2466R	733	903	1032	29	29.5	66	24	110	6
L2ER2472R	778	965	1106	29	29.5	72	24	119	6

L2ERH-R • Executive Return Right, Half Modesty

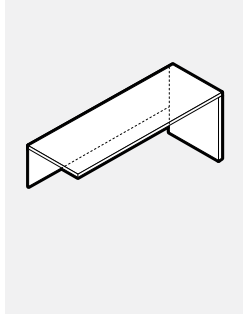

• Units are non-handed. They can be configured as either lefts or rights.

PRODUCT CODE	FINISH			SIZE/INCHES				WEIGHT LBS	VOL FT ³
	LP	B	W	H (LP/B)	H (W)	W	D		
L2ERH2024R	326	387	438	29	29.5	24	20	45	3
L2ERH2030R	356	430	492	29	29.5	30	20	53	3
L2ERH2036R	397	486	560	29	29.5	36	20	62	3
L2ERH2042R	428	530	615	29	29.5	42	20	67	3
L2ERH2048R	459	576	671	29	29.5	48	20	77	4
L2ERH2054R	492	619	724	29	29.5	54	20	83	4
L2ERH2060R	534	677	792	29	29.5	60	20	94	4
L2ERH2066R	564	722	843	29	29.5	66	20	101	6
L2ERH2072R	594	767	902	29	29.5	72	20	110	6
L2ERH2424R	337	400	457	29	29.5	24	24	45	3
L2ERH2430R	369	449	509	29	29.5	30	24	53	3
L2ERH2436R	413	505	584	29	29.5	36	24	62	3
L2ERH2442R	446	552	639	29	29.5	42	24	67	3
L2ERH2448R	477	601	697	29	29.5	48	24	77	4
L2ERH2454R	509	646	752	29	29.5	54	24	83	4
L2ERH2460R	556	703	821	29	29.5	60	24	94	4
L2ERH2466R	587	751	879	29	29.5	66	24	101	6
L2ERH2472R	619	799	941	29	29.5	72	24	110	6

L2B • Bridge with Flush Mounted Modesty

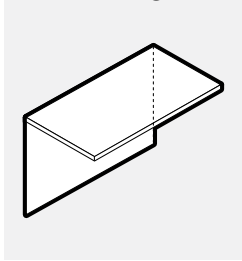

PRODUCT CODE	FINISH			SIZE / INCHES				WEIGHT		VOL FT ³
	LP	B	W	H (LP/B)	H (W)	W	D	LBS		
L2B2024	259	318	372	29	29.5	24	20	39	2	
L2B2030	303	377	439	29	29.5	30	20	42	3	
L2B2036	352	439	512	29	29.5	36	20	68	3	
L2B2042	394	495	579	29	29.5	42	20	77	3	
L2B2048	438	553	647	29	29.5	48	20	86	4	
L2B2054	481	612	715	29	29.5	54	20	94	4	
L2B2424	270	331	386	29	29.5	24	24	39	2	
L2B2430	315	392	458	29	29.5	30	24	44	3	
L2B2436	364	457	532	29	29.5	36	24	68	3	
L2B2442	409	519	605	29	29.5	42	24	77	3	
L2B2448	457	576	673	29	29.5	48	24	86	4	
L2B2454	501	637	741	29	29.5	54	24	94	4	

L2BH • Bridge with Flush Mounted Half Modesty

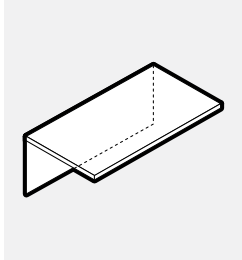

PRODUCT CODE	FINISH			SIZE / INCHES				WEIGHT		VOL FT ³
	LP	B	W	H (LP/B)	H (W)	W	D	LBS		
L2BH2024	206	263	317	29	29.5	24	20	36	2	
L2BH2030	238	309	369	29	29.5	30	20	36	2	
L2BH2036	272	358	430	29	29.5	36	20	54	3	
L2BH2042	303	400	486	29	29.5	42	20	61	3	
L2BH2048	334	446	539	29	29.5	48	20	66	4	
L2BH2054	366	492	592	29	29.5	54	20	72	4	
L2BH2424	215	275	329	29	29.5	24	24	36	2	
L2BH2430	246	319	385	29	29.5	30	24	42	3	
L2BH2436	284	372	449	29	29.5	36	24	54	3	
L2BH2442	317	419	505	29	29.5	42	24	61	3	
L2BH2448	350	463	561	29	29.5	48	24	66	4	
L2BH2454	381	509	617	29	29.5	54	24	72	4	

L2EC-R • Extended Corner Desk with 10" End Panel on Left, Full Modesty & Full Gable on Right

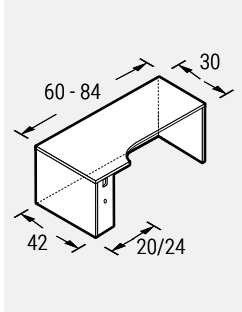

PRODUCT CODE	FINISH			SIZE / INCHES				WEIGHT		VOL FT ³
	LP	B	W	H (LP/B)	H (W)	W	D	LBS		
For 20" Return Connection										
L2EC20426030R	1077	1334	1516	29	29.5	60	42	187	8	
L2EC20426630R	1133	1414	1607	29	29.5	66	42	209	9	
L2EC20427230R	1187	1488	1697	29	29.5	72	42	231	10	
L2EC20427830R	1236	1566	1788	29	29.5	78	42	253	11	
L2EC20428430R	1290	1641	1879	29	29.5	84	42	275	12	
For 24" Return Connection										
L2EC24426030R	1077	1334	1516	29	29.5	60	42	187	8	
L2EC24426630R	1133	1414	1607	29	29.5	66	42	209	9	
L2EC24427230R	1187	1488	1697	29	29.5	72	42	231	10	
L2EC24427830R	1236	1566	1788	29	29.5	78	42	253	11	
L2EC24428430R	1290	1641	1879	29	29.5	84	42	275	12	

L2EC-L • Extended Corner Desk with 10" End Panel on Right, Full Modesty & Full Gable on Left

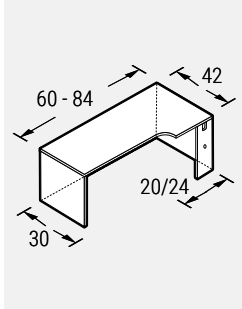

PRODUCT CODE	FINISH			SIZE / INCHES				WEIGHT		VOL FT ³
	LP	B	W	H (LP/B)	H (W)	W	D	LBS		
For 20" Return Connection										
L2EC30604220L	1077	1334	1516	29	29.5	60	42	187	8	
L2EC30664220L	1133	1414	1607	29	29.5	66	42	209	9	
L2EC30724220L	1187	1488	1697	29	29.5	72	42	231	10	
L2EC30784220L	1236	1566	1788	29	29.5	78	42	253	11	
L2EC30844220L	1290	1641	1879	29	29.5	84	42	275	12	
For 24" Return Connection										
L2EC30604224L	1077	1334	1516	29	29.5	60	42	187	8	
L2EC30664224L	1133	1414	1607	29	29.5	66	42	209	9	
L2EC30724224L	1187	1488	1697	29	29.5	72	42	231	10	
L2EC30784224L	1236	1566	1788	29	29.5	78	42	253	11	
L2EC30844224L	1290	1641	1879	29	29.5	84	42	275	12	

L2EC-R • Extended Corner Desk with 10" End Panel on Left, Full Modesty & Full Gable on Right

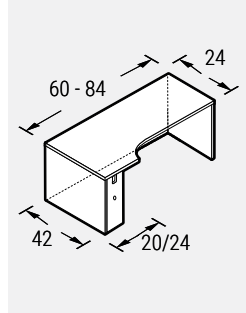

PRODUCT CODE	FINISH LP	B	W	SIZE/INCHES				WEIGHT LBS	VOL FT ³
				H(LP/B)	H(W)	W	D		
For 20" Return Connection									
L2EC20426024R	1056	1313	1494	29	29.5	60	42	187	8
L2EC20426624R	1109	1389	1584	29	29.5	66	42	209	9
L2EC20427224R	1163	1465	1674	29	29.5	72	42	231	10
L2EC20427824R	1218	1542	1764	29	29.5	78	42	253	11
L2EC20428424R	1266	1619	1858	29	29.5	84	42	275	12
For 24" Return Connection									
L2EC24426024R	1056	1313	1494	29	29.5	60	42	187	8
L2EC24426624R	1109	1389	1584	29	29.5	66	42	209	9
L2EC24427224R	1163	1465	1674	29	29.5	72	42	231	10
L2EC24427824R	1218	1542	1764	29	29.5	78	42	253	11
L2EC24428424R	1266	1619	1858	29	29.5	84	42	275	12

L2EC-L • Extended Corner Desk with 10" End Panel on Left, Full Modesty & Full Gable on Right

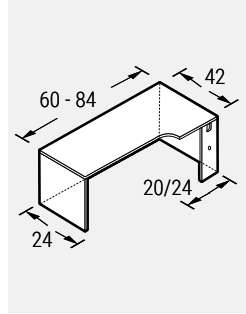

PRODUCT CODE	FINISH LP	B	W	SIZE/INCHES				WEIGHT LBS	VOL FT ³
				H(LP/B)	H(W)	W	D		
For 20" Return Connection									
L2EC24604220L	1056	1313	1494	29	29.5	60	42	187	8
L2EC24664220L	1109	1389	1584	29	29.5	66	42	209	9
L2EC24724220L	1163	1465	1674	29	29.5	72	42	231	10
L2EC24784220L	1218	1542	1764	29	29.5	78	42	253	11
L2EC24844220L	1266	1619	1858	29	29.5	84	42	275	12
For 24" Return Connection									
L2EC24604224L	1056	1313	1494	29	29.5	60	42	187	8
L2EC24664224L	1109	1389	1584	29	29.5	66	42	209	9
L2EC24724224L	1163	1465	1674	29	29.5	72	42	231	10
L2EC24784224L	1218	1542	1764	29	29.5	78	42	253	11
L2EC24844224L	1266	1619	1858	29	29.5	84	42	275	12

L2DEC-R • Extended Corner Desk with 10" End Panel on Left, Full Modesty and Full Gable Right

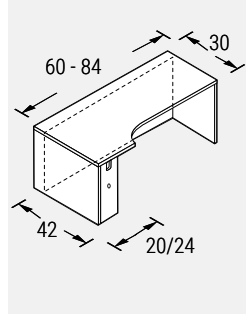

• All recessed modesties are inset 6" from the visitor edge.

PRODUCT CODE	FINISH LP	B	W	SIZE/INCHES				WEIGHT LBS	VOL FT ³
				H(LP/B)	H(W)	W	D		
For 20" Connection									
L2DEC20426030R	1077	1334	1516	29	29.5	60	42	187	8
L2DEC20426630R	1133	1414	1607	29	29.5	66	42	209	9
L2DEC20427230R	1187	1488	1697	29	29.5	72	42	231	10
L2DEC20427830R	1236	1566	1788	29	29.5	78	42	253	11
L2DEC20428430R	1290	1641	1879	29	29.5	84	42	275	12
For 24" Connection									
L2DEC24426030R	1077	1334	1516	29	29.5	60	42	187	8
L2DEC24426630R	1133	1414	1607	29	29.5	66	42	209	9
L2DEC24427230R	1187	1488	1697	29	29.5	72	42	231	10
L2DEC24427830R	1236	1566	1788	29	29.5	78	42	253	11
L2DEC24428430R	1290	1641	1879	29	29.5	84	42	275	12

L2DEC-L • Extended Corner Desk with 10" End Panel on Right, Full Modesty and Full Gable Left

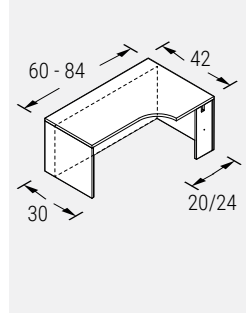

• All recessed modesties are inset 6" from the visitor edge.

PRODUCT CODE	FINISH LP	B	W	SIZE/INCHES				WEIGHT LBS	VOL FT ³
				H(LP/B)	H(W)	W	D		
For 20" Connection									
L2DEC30604220L	1077	1334	1516	29	29.5	60	42	187	8
L2DEC30664220L	1133	1414	1607	29	29.5	66	42	209	9
L2DEC30724220L	1187	1488	1697	29	29.5	72	42	231	10
L2DEC30784220L	1236	1566	1788	29	29.5	78	42	253	11
L2DEC30844220L	1290	1641	1879	29	29.5	84	42	275	12
For 24" Connection									
L2DEC30604224L	1077	1334	1516	29	29.5	60	42	187	8
L2DEC30664224L	1133	1414	1607	29	29.5	66	42	209	9
L2DEC30724224L	1187	1488	1697	29	29.5	72	42	231	10
L2DEC30784224L	1236	1566	1788	29	29.5	78	42	253	11
L2DEC30844224L	1290	1641	1879	29	29.5	84	42	275	12

L2DEC-R • Extended Corner Desk with 10" End Panel on Left, Full Modesty and Full Gable Right

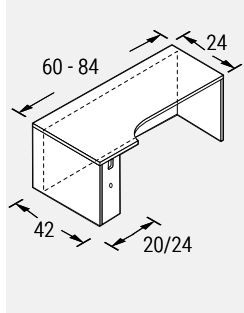

• All recessed modesties are inset 6" from the visitor edge.

PRODUCT CODE	FINISH			SIZE/INCHES				WEIGHT LBS	VOL FT ³
	LP	B	W	H(LP/B)	H(W)	W	D		
For 20" Connection									
L2DEC20426024R	1056	1313	1494	29	29.5	60	42	187	8
L2DEC20426624R	1109	1389	1584	29	29.5	66	42	209	9
L2DEC20427224R	1163	1465	1674	29	29.5	72	42	231	10
L2DEC20427824R	1218	1542	1764	29	29.5	78	42	253	11
L2DEC20428424R	1266	1619	1858	29	29.5	84	42	275	12
For 24" Connection									
L2DEC24426024R	1056	1313	1494	29	29.5	60	42	187	8
L2DEC24426624R	1109	1389	1584	29	29.5	66	42	209	9
L2DEC24427224R	1163	1465	1674	29	29.5	72	42	231	10
L2DEC24427824R	1218	1542	1764	29	29.5	78	42	253	11
L2DEC24428424R	1266	1619	1858	29	29.5	84	42	275	12

L2DEC-L • Extended Corner Desk with 10" End Panel on Right, Full Modesty and Full Gable Left

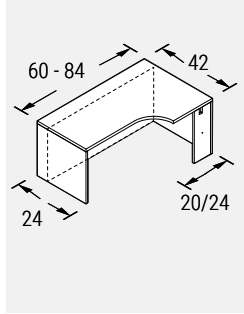

• All recessed modesties are inset 6" from the visitor edge.

PRODUCT CODE	FINISH			SIZE/INCHES				WEIGHT LBS	VOL FT ³
	LP	B	W	H(LP/B)	H(W)	W	D		
For 20" Connection									
L2DEC24604220L	1056	1313	1494	29	29.5	60	42	187	8
L2DEC24664220L	1109	1389	1584	29	29.5	66	42	209	9
L2DEC24724220L	1163	1465	1674	29	29.5	72	42	231	10
L2DEC24784220L	1218	1542	1764	29	29.5	78	42	253	11
L2DEC24844220L	1266	1619	1858	29	29.5	84	42	275	12
For 24" Connection									
L2DEC24604224L	1056	1313	1494	29	29.5	60	42	187	8
L2DEC24664224L	1109	1389	1584	29	29.5	66	42	209	9
L2DEC24724224L	1163	1465	1674	29	29.5	72	42	231	10
L2DEC24784224L	1218	1542	1764	29	29.5	78	42	253	11
L2DEC24844224L	1266	1619	1858	29	29.5	84	42	275	12

L2CS • Corner with Straight Front, Full Back Panel & Narrow End Gables

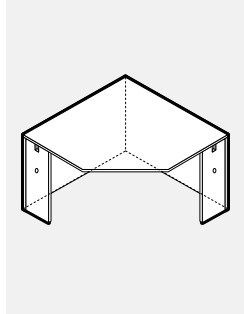

• For grain direction on surfaces larger than 42", please see grain direction chart at beginning of the Price List

PRODUCT CODE	FINISH			SIZE/INCHES				WEIGHT LBS	VOL FT ³
	LP	B	W	H(LP/B)	H(W)	W	D		
L2CS183618	862	1063	1329	29	29.5	36	36	79	3
L2CS183620	884	1089	1364	29	29.5	36	36	84	3
L2CS183624	884	1089	1364	29	29.5	36	36	84	3
L2CS203618	884	1089	1364	29	29.5	36	36	84	3
L2CS203620	921	1148	1480	29	29.5	36	36	88	3
L2CS203624	942	1174	1514	29	29.5	36	36	88	3
L2CS243618	884	1089	1364	29	29.5	36	36	84	3
L2CS243620	942	1174	1514	29	29.5	36	36	88	3
L2CS243624	942	1174	1514	29	29.5	36	36	88	3
L2CS184218	944	1168	1452	29	29.5	42	42	87	4
L2CS184220	970	1198	1488	29	29.5	42	42	92	4
L2CS184224	970	1198	1488	29	29.5	42	42	92	4
L2CS204218	970	1198	1488	29	29.5	42	42	92	4
L2CS204220	970	1198	1488	29	29.5	42	42	97	4
L2CS204224	994	1227	1570	29	29.5	42	42	97	4
L2CS244218	970	1198	1488	29	29.5	42	42	92	4
L2CS244220	994	1227	1570	29	29.5	42	42	97	4
L2CS244224	994	1227	1570	29	29.5	42	42	97	4
L2CS184818	1000	1225	1507	29	29.5	48	48	97	6
L2CS184820	1026	1254	1544	29	29.5	48	48	101	6
L2CS184824	1026	1254	1544	29	29.5	48	48	101	6
L2CS204818	1026	1254	1544	29	29.5	48	48	101	6
L2CS204820	1026	1254	1544	29	29.5	48	48	107	6
L2CS204824	1052	1285	1626	29	29.5	48	48	107	6
L2CS244818	1026	1254	1544	29	29.5	48	48	101	6
L2CS244820	1052	1285	1626	29	29.5	48	48	107	6
L2CS244824	1052	1285	1626	29	29.5	48	48	107	6

L2CSH • Corner with Straight Front, Cut Out Back Panel & Narrow End Gables

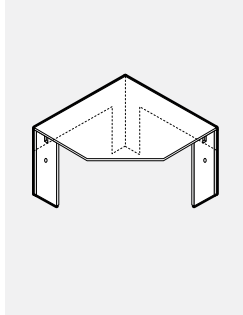

• For grain direction on surfaces larger than 42", please see grain direction chart at beginning of the Price List

PRODUCT CODE	FINISH LP	B	W	SIZE/INCHES			D	WEIGHT LBS	VOL FT ³
				H(LP/B)	H(W)	W			
L2CSH183618	891	1093	1357	29	29.5	36	36	51	3
L2CSH183620	915	1120	1394	29	29.5	36	36	55	3
L2CSH183624	915	1120	1394	29	29.5	36	36	55	3
L2CSH203618	915	1120	1394	29	29.5	36	36	55	3
L2CSH203620	949	1177	1509	29	29.5	36	36	59	3
L2CSH203624	971	1203	1542	29	29.5	36	36	59	3
L2CSH243618	915	1120	1394	29	29.5	36	36	55	3
L2CSH243620	971	1203	1542	29	29.5	36	36	59	3
L2CSH243624	971	1203	1542	29	29.5	36	36	59	3
L2CSH184218	977	1201	1484	29	29.5	42	42	57	4
L2CSH184220	1004	1230	1524	29	29.5	42	42	63	4
L2CSH184224	1004	1230	1524	29	29.5	42	42	63	4
L2CSH204218	1004	1230	1524	29	29.5	42	42	63	4
L2CSH204220	1004	1230	1524	29	29.5	42	42	68	4
L2CSH204224	1029	1262	1606	29	29.5	42	42	68	4
L2CSH244218	1004	1230	1524	29	29.5	42	42	63	4
L2CSH244220	1029	1262	1606	29	29.5	42	42	68	4
L2CSH244224	1029	1262	1606	29	29.5	42	42	68	4
L2CSH184818	1034	1260	1541	29	29.5	48	48	65	6
L2CSH184820	1060	1288	1581	29	29.5	48	48	70	6
L2CSH184824	1060	1288	1581	29	29.5	48	48	70	6
L2CSH204818	1060	1288	1581	29	29.5	48	48	70	6
L2CSH204820	1060	1288	1581	29	29.5	48	48	76	6
L2CSH204824	1085	1318	1663	29	29.5	48	48	76	6
L2CSH244818	1060	1288	1581	29	29.5	48	48	70	6
L2CSH244820	1085	1318	1663	29	29.5	48	48	76	6
L2CSH244824	1085	1318	1663	29	29.5	48	48	76	6

L2CC • Corner with Curved Front, Full Back Panel & Narrow End Gables

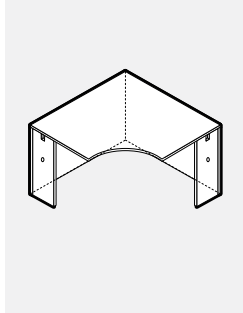

• For grain direction on surfaces larger than 42", please see grain direction chart at beginning of the Price List

PRODUCT CODE	FINISH LP	B	W	SIZE/INCHES			D	WEIGHT LBS	VOL FT ³
				H(LP/B)	H(W)	W			
L2CC183618	872	1082	1355	29	29.5	36	36	79	3
L2CC183620	898	1109	1392	29	29.5	36	36	84	3
L2CC183624	898	1109	1392	29	29.5	36	36	84	3
L2CC203618	898	1109	1392	29	29.5	36	36	84	3
L2CC203620	934	1169	1509	29	29.5	36	36	88	3
L2CC203624	956	1197	1542	29	29.5	36	36	88	3
L2CC243618	898	1109	1392	29	29.5	36	36	84	3
L2CC243620	956	1197	1542	29	29.5	36	36	88	3
L2CC243624	956	1197	1542	29	29.5	36	36	88	3
L2CC184218	958	1189	1481	29	29.5	42	42	87	4
L2CC184220	983	1221	1518	29	29.5	42	42	92	4
L2CC184224	983	1221	1518	29	29.5	42	42	92	4
L2CC204218	983	1221	1518	29	29.5	42	42	92	4
L2CC204220	983	1221	1518	29	29.5	42	42	97	4
L2CC204224	1008	1251	1604	29	29.5	42	42	97	4
L2CC244218	983	1221	1518	29	29.5	42	42	92	4
L2CC244220	1008	1251	1604	29	29.5	42	42	97	4
L2CC244224	1008	1251	1604	29	29.5	42	42	97	4
L2CC184818	1015	1247	1537	29	29.5	48	48	97	6
L2CC184820	1038	1277	1575	29	29.5	48	48	101	6
L2CC184824	1038	1277	1575	29	29.5	48	48	101	6
L2CC204818	1038	1277	1575	29	29.5	48	48	101	6
L2CC204820	1038	1277	1575	29	29.5	48	48	107	6
L2CC204824	1064	1305	1660	29	29.5	48	48	107	6
L2CC244818	1038	1277	1575	29	29.5	48	48	101	6
L2CC244820	1064	1305	1660	29	29.5	48	48	107	6
L2CC244824	1064	1305	1660	29	29.5	48	48	107	6

L2CCH • Corner with Curved Front, Cut Out Back Panel & Narrow End Gables

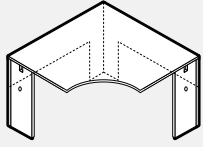

• For grain direction on surfaces larger than 42", please see grain direction chart at beginning of the Price List

PRODUCT CODE	FINISH LP	B	W	SIZE / INCHES				WEIGHT		VOL FT ³
				H (LP/B)	H (W)	W	D	LBS		
L2CCH183618	903	1110	1482	29	29.5	36	36	51	3	
L2CCH183620	928	1139	1485	29	29.5	36	36	55	3	
L2CCH183624	928	1139	1485	29	29.5	36	36	55	3	
L2CCH203618	928	1139	1485	29	29.5	36	36	55	3	
L2CCH203620	965	1199	1608	29	29.5	36	36	59	3	
L2CCH203624	987	1227	1608	29	29.5	36	36	59	3	
L2CCH243618	928	1139	1485	29	29.5	36	36	55	3	
L2CCH243620	987	1227	1608	29	29.5	36	36	59	3	
L2CCH243624	987	1227	1608	29	29.5	36	36	59	3	
L2CCH184218	993	1223	1515	29	29.5	42	42	57	4	
L2CCH184220	1020	1253	1554	29	29.5	42	42	63	4	
L2CCH184224	1020	1253	1554	29	29.5	42	42	63	4	
L2CCH204218	1020	1253	1554	29	29.5	42	42	63	4	
L2CCH204220	1020	1253	1554	29	29.5	42	42	68	4	
L2CCH204224	1042	1285	1637	29	29.5	42	42	68	4	
L2CCH244218	1020	1253	1554	29	29.5	42	42	63	4	
L2CCH244220	1042	1285	1637	29	29.5	42	42	68	4	
L2CCH244224	1042	1285	1637	29	29.5	42	42	68	4	
L2CCH184818	1051	1280	1570	29	29.5	48	48	65	6	
L2CCH184820	1075	1310	1608	29	29.5	48	48	70	6	
L2CCH184824	1075	1310	1608	29	29.5	48	48	70	6	
L2CCH204818	1075	1310	1608	29	29.5	48	48	70	6	
L2CCH204820	1075	1310	1608	29	29.5	48	48	76	6	
L2CCH204824	1099	1341	1693	29	29.5	48	48	76	6	
L2CCH244818	1075	1310	1608	29	29.5	48	48	70	6	
L2CCH244820	1099	1341	1693	29	29.5	48	48	76	6	
L2CCH244824	1099	1341	1693	29	29.5	48	48	76	6	

L2CK • Split Corner Desk w/Curved Front Keyboard, Full Back Panel & Narrow End Gables

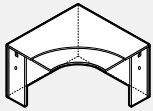

• For grain direction on surfaces larger than 42", please see grain direction chart at beginning of the Price List

PRODUCT CODE	FINISH LP	B	W	SIZE / INCHES				WEIGHT		VOL FT ³
				H (LP/B)	H (W)	W	D	LBS		
L2CK244224	1717	2014	2389	29	29.5	42	42	97	4	
L2CK244824	1773	2069	2448	29	29.5	48	48	107	6	

L2CHK • Split Corner Desk w/Curved Front Keyboard, Cut Out Back Panel & Narrow End Gables

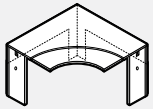

• For grain direction on surfaces larger than 42", please see grain direction chart at beginning of the Price List

PRODUCT CODE	FINISH LP	B	W	SIZE / INCHES				WEIGHT		VOL FT ³
				H (LP/B)	H (W)	W	D	LBS		
L2CHK244224	1750	2030	2405	29	29.5	42	42	68	4	
L2CHK244824	1807	2088	2462	29	29.5	48	48	76	6	

Technical Information

- All Shaped tables are Shipped knocked down (KD).
- Monoleg or square leg ships in a separate box.
- All Units must be connected to an adjoining unit with flat brackets.
- For 24" deep returns that connect to an adjoining unit with included flat brackets.
- For 24" deep returns that connect to the corner units, the narrow panel is 10" and for 30" deep returns, the narrow panel is 14".
- All bottom edges are edge banded.
- Monolegs are drilled to accept shoulder screws to attach to the modesty.
- Modesty are offered 10" high only.
- Top plate with cut-out for 3" monoleg will accept modesty panel 1" thick.
- 8 x 8" plate is attached to surface with #10 3/4 wood screws, included.
- 1" height adjustment range.

TABLES • GUIDELINES FOR ORDERING PRODUCT

CODES: The price list uses a numbering system with meaningful alphanumeric characters to create a simple-to-understand product number. This makes specifying the product much easier and more accurate.

SPECIFICATION EXAMPLE OF A SHAPED TABLE

PRODUCT CODE: L2TDH3060
 L2 = New Licence
 T = Table
 D = D Shape Worksurface
 H = Half Modesty (10"High)
 3060 = Size: Depth x Width

OPTIONS:
 Top: LP - LPL (Low Pressure Laminate) Thickness 1"
 HP B - B Thickness 1 1/16"
 HP W - W Thickness 1 7/16"

Leg Option: L2BHML03 (DEFAULT) Round Monoleg
 L2LSQ3X3 - Square Leg

Top Finish Laminate: Choose Colour

Top PVC Edging: Choose Colour

Chassis Laminate: Choose Colour

Chassis PVC Edging: Choose Colour

Metal Leg Finish: Choose Colour

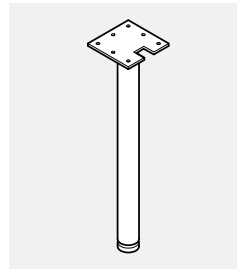

L2BHML03

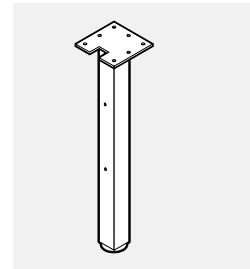

L2LSQ3X3

L2TD • D-Shaped Top with T-Base & Leg

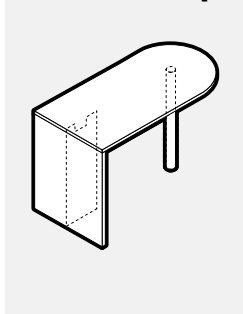

• Add \$118 to list price for chrome leg option.

PRODUCT CODE	FINISH		SIZE/INCHES				WEIGHT LBS	VOL FT ³	
	LP	B	W	H (LP/B)	H (W)	W			
L2TD2442	760	877	965	29	29.5	42	24	64	3
L2TD2448	779	910	1007	29	29.5	48	24	68	3
L2TD2454	802	945	1054	29	29.5	54	24	72	3
L2TD2460	825	982	1098	29	29.5	60	24	76	4
L2TD2466	845	1015	1140	29	29.5	66	24	79	4
L2TD2472	867	1052	1188	29	29.5	72	24	84	4
L2TD2478	890	1085	1229	29	29.5	78	24	87	6
L2TD2484	910	1120	1277	29	29.5	84	24	91	6
L2TD3054	870	1047	1169	29	29.5	54	30	97	4
L2TD3060	898	1088	1224	29	29.5	60	30	107	7
L2TD3066	926	1132	1279	29	29.5	66	30	117	8
L2TD3072	949	1170	1329	29	29.5	72	30	127	9
L2TD3078	975	1217	1384	29	29.5	78	30	136	9
L2TD3084	1003	1256	1438	29	29.5	84	30	146	10
L2TD3654	935	1139	1282	29	29.5	54	36	107	4
L2TD3660	967	1190	1343	29	29.5	60	36	111	10
L2TD3666	996	1238	1406	29	29.5	66	36	116	9
L2TD3672	1026	1288	1467	29	29.5	72	36	153	10
L2TD3678	1057	1338	1529	29	29.5	78	36	165	11
L2TD3684	1086	1387	1591	29	29.5	84	36	176	12

L2TDH • D-Shaped Top with Half Modesty & Leg

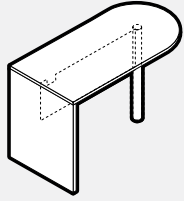

• Add \$118 to list price for chrome leg option.

PRODUCT CODE	FINISH LP	B	W	SIZE / INCHES				WEIGHT LBS	VOL FT ³
				H(LP/B)	H(W)	W	D		
L2TDH2442	741	860	947	29	29.5	42	24	63	3
L2TDH2448	774	904	1000	29	29.5	48	24	69	3
L2TDH2454	805	948	1056	29	29.5	54	24	75	3
L2TDH2460	837	994	1110	29	29.5	60	24	81	4
L2TDH2466	868	1036	1164	29	29.5	66	24	87	4
L2TDH2472	899	1084	1221	29	29.5	72	24	94	4
L2TDH2478	930	1126	1272	29	29.5	78	24	99	6
L2TDH2484	959	1170	1327	29	29.5	84	24	106	6
L2TDH3054	871	1047	1169	29	29.5	54	30	95	4
L2TDH3060	908	1098	1232	29	29.5	60	30	102	7
L2TDH3066	943	1151	1294	29	29.5	66	30	112	8
L2TDH3072	977	1201	1357	29	29.5	72	30	122	9
L2TDH3078	1013	1254	1421	29	29.5	78	30	132	9
L2TDH3084	1051	1305	1485	29	29.5	84	30	142	10
L2TDH3654	935	1140	1284	29	29.5	54	36	145	4
L2TDH3660	975	1199	1353	29	29.5	60	36	151	10
L2TDH3666	1005	1251	1416	29	29.5	66	36	154	9
L2TDH3672	1047	1309	1485	29	29.5	72	36	156	10
L2TDH3678	1085	1366	1559	29	29.5	78	36	161	11
L2TDH3684	1124	1427	1632	29	29.5	84	36	172	12

L2TR • Rectangular Top with T-Base & Mono Leg

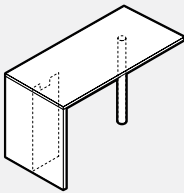

• Add \$118 to list price for chrome leg option.

PRODUCT CODE	FINISH LP	B	W	SIZE / INCHES				WEIGHT LBS	VOL FT ³
				H(LP/B)	H(W)	W	D		
L2TR2442	760	877	965	29	29.5	42	24	64	3
L2TR2448	779	910	1007	29	29.5	48	24	68	3
L2TR2454	802	945	1054	29	29.5	54	24	72	3
L2TR2460	825	982	1098	29	29.5	60	24	76	4
L2TR2466	845	1015	1140	29	29.5	66	24	79	4
L2TR2472	867	1052	1188	29	29.5	72	24	84	4
L2TR2478	890	1085	1229	29	29.5	78	24	87	6
L2TR2484	910	1120	1277	29	29.5	84	24	91	6
L2TR3054	870	1047	1169	29	29.5	54	30	97	4
L2TR3060	898	1088	1224	29	29.5	60	30	107	7
L2TR3066	926	1132	1279	29	29.5	66	30	112	8
L2TR3072	949	1170	1329	29	29.5	72	30	127	9
L2TR3078	975	1217	1384	29	29.5	78	30	136	9
L2TR3084	1003	1256	1438	29	29.5	84	30	146	10
L2TR3654	935	1139	1282	29	29.5	54	36	107	4
L2TR3660	967	1190	1343	29	29.5	60	36	111	7
L2TR3666	996	1238	1406	29	29.5	66	36	116	8
L2TR3672	1026	1288	1467	29	29.5	72	36	153	9
L2TR3678	1057	1338	1529	29	29.5	78	36	165	9
L2TR3684	1086	1387	1591	29	29.5	84	36	176	10

L2TRH • Rectangular Top with Half Modesty & Mono Leg

• Add \$118 to list price for chrome leg option.

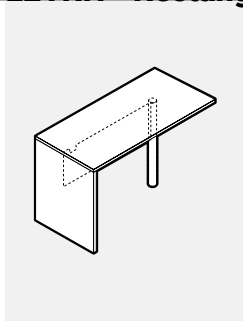

PRODUCT CODE	FINISH LP	B	W	SIZE/INCHES			D	WEIGHT LBS	VOL FT ³
				H(LP/B)	H(W)	W			
L2TRH2442	741	860	947	29	29.5	42	24	63	3
L2TRH2448	774	904	1010	29	29.5	48	24	69	3
L2TRH2454	805	948	1056	29	29.5	54	24	75	3
L2TRH2460	837	994	1110	29	29.5	60	24	81	4
L2TRH2466	868	1036	1164	29	29.5	66	24	87	4
L2TRH2472	899	1084	1221	29	29.5	72	24	94	4
L2TRH2478	930	1126	1272	29	29.5	78	24	99	6
L2TRH2484	959	1170	1327	29	29.5	84	24	100	6
L2TRH3054	871	1047	1169	29	29.5	54	30	95	4
L2TRH3060	908	1098	1232	29	29.5	60	30	102	7
L2TRH3066	943	1151	1294	29	29.5	66	30	112	8
L2TRH3072	977	1201	1357	29	29.5	72	30	132	9
L2TRH3078	1013	1254	1421	29	29.5	78	30	142	9
L2TRH3084	1051	1305	1485	29	29.5	84	30	145	10
L2TRH3654	935	1140	1284	29	29.5	54	36	145	4
L2TRH3660	975	1199	1353	29	29.5	60	36	151	7
L2TRH3666	1005	1251	1416	29	29.5	66	36	154	8
L2TRH3672	1047	1309	1485	29	29.5	72	36	156	9
L2TRH3678	1085	1366	1559	29	29.5	78	36	161	9
L2TRH3684	1124	1427	1632	29	29.5	84	36	172	10

L2TA • Axe Shaped Top with T-Base & Leg

• Add \$118 to list price for chrome leg option.

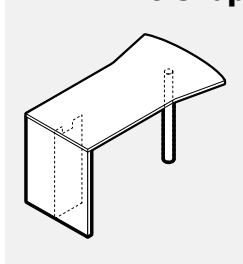

PRODUCT CODE	FINISH LP	B	W	SIZE/INCHES			D	WEIGHT LBS	VOL FT ³
				H(LP/B)	H(W)	W			
L2TA3060	996	1252	1427	29	29.50	60	42	131	10
L2TA3066	1032	1309	1497	29	29.50	66	42	140	11
L2TA3072	1064	1364	1569	29	29.50	72	42	149	12
L2TA3078	1099	1420	1639	29	29.50	78	42	157	12
L2TA3084	1134	1476	1711	29	29.50	84	42	166	13
L2TA3672	1140	1481	1706	29	29.50	72	48	153	13
L2TA3678	1179	1544	1786	29	29.50	78	48	163	14
L2TA3684	1221	1607	1866	29	29.50	84	48	173	15

L2TAH • Axe Shaped Top with Half Modesty & Leg

• Add \$118 to list price for chrome leg option.

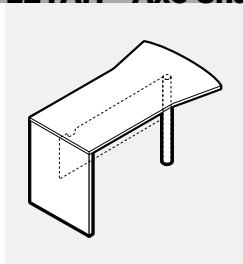

PRODUCT CODE	FINISH LP	B	W	SIZE/INCHES			D	WEIGHT LBS	VOL FT ³
				H(LP/B)	H(W)	W			
L2TAH3060	1005	1261	1438	29	29.50	60	42	127	10
L2TAH3066	1051	1327	1517	29	29.50	66	42	135	11
L2TAH3072	1093	1393	1598	29	29.50	72	42	144	12
L2TAH3078	1136	1460	1680	29	29.50	78	42	153	12
L2TAH3084	1179	1527	1759	29	29.50	84	42	162	13
L2TAH3672	1162	1498	1725	29	29.50	72	48	149	13
L2TAH3678	1207	1573	1815	29	29.50	78	48	158	14
L2TAH3684	1256	1648	1903	29	29.50	84	48	168	15

L2TP-L • P-Shaped Top Left with T-Base & Leg

• Add \$118 to list price for chrome leg option.

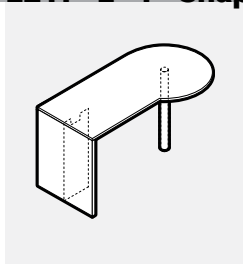

PRODUCT CODE	FINISH LP	B	W	SIZE/INCHES			D	WEIGHT LBS	VOL FT ³
				H(LP/B)	H(W)	W			
L2TP3060L	948	1170	1329	29	29.50	60	36	121	9
L2TP3066L	978	1223	1392	29	29.50	66	36	135	9
L2TP3072L	1010	1268	1454	29	29.50	72	36	150	10
L2TP3078L	1038	1320	1516	29	29.50	78	36	164	11
L2TP3084L	1070	1370	1580	29	29.50	84	36	178	12
L2TP3672L	1086	1387	1591	29	29.50	72	42	188	12
L2TP3678L	1122	1442	1663	29	29.50	78	42	202	12
L2TP3684L	1158	1502	1733	29	29.50	84	42	217	13

L2TP-R • P-Shaped Top Right with T-Base & Leg

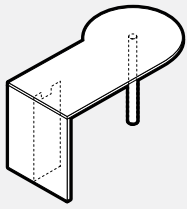

• Add \$118 to list price for chrome leg option.

PRODUCT CODE	FINISH LP	B	W	SIZE / INCHES				WEIGHT		VOL FT ³
				H (LP/B)	H (W)	W	D	LBS		
L2TP3060R	948	1170	1329	29	29.50	60	36	121	9	
L2TP3066R	978	1223	1392	29	29.50	66	36	135	9	
L2TP3072R	1010	1268	1454	29	29.50	72	36	150	10	
L2TP3078R	1038	1320	1516	29	29.50	78	36	164	11	
L2TP3084R	1070	1370	1580	29	29.50	84	36	178	12	
L2TP3672R	1086	1387	1591	29	29.50	72	42	188	12	
L2TP3678R	1122	1442	1663	29	29.50	78	42	202	12	
L2TP3684R	1158	1502	1733	29	29.50	84	42	217	13	

L2TPH-L • P-Shaped Top Left with Half Modesty & Leg

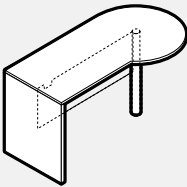

• Add \$118 to list price for chrome leg option.

PRODUCT CODE	FINISH LP	B	W	SIZE / INCHES				WEIGHT		VOL FT ³
				H (LP/B)	H (W)	W	D	LBS		
L2TPH3060L	958	1181	1338	29	29.50	60	36	117	9	
L2TPH3066L	997	1238	1412	29	29.50	66	36	131	9	
L2TPH3072L	1036	1299	1482	29	29.50	72	36	145	10	
L2TPH3078L	1076	1357	1555	29	29.50	78	36	160	11	
L2TPH3084L	1118	1417	1626	29	29.50	84	36	174	12	
L2TPH3672L	1104	1406	1608	29	29.50	72	42	184	12	
L2TPH3678L	1147	1472	1692	29	29.50	78	42	198	12	
L2TPH3684L	1191	1539	1773	29	29.50	84	42	212	13	

L2TPH-R • P-Shaped Top Right with Half Modesty & Leg

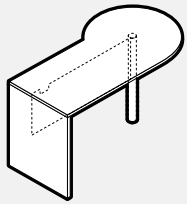

• Add \$118 to list price for chrome leg option.

PRODUCT CODE	FINISH LP	B	W	SIZE / INCHES				WEIGHT		VOL FT ³
				H (LP/B)	H (W)	W	D	LBS		
L2TPH3060R	958	1181	1338	29	29.50	60	36	117	9	
L2TPH3066R	997	1238	1412	29	29.50	66	36	131	9	
L2TPH3072R	1036	1299	1482	29	29.50	72	36	145	10	
L2TPH3078R	1076	1357	1555	29	29.50	78	36	160	11	
L2TPH3084R	1118	1417	1626	29	29.50	84	36	174	12	
L2TPH3672R	1104	1406	1608	29	29.50	72	42	184	12	
L2TPH3678R	1147	1472	1692	29	29.50	78	42	198	12	
L2TPH3684R	1191	1539	1773	29	29.50	84	42	212	13	

L2TH-L • Hockey Shaped Top Left with T-Base & Leg

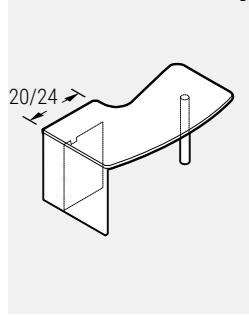

• Add \$118 to list price for chrome leg option.

PRODUCT CODE	FINISH LP	B	W	SIZE/INCHES			D	WEIGHT LBS	VOL FT ³
				H(LP/B)	H(W)	W			
For 20" Return Connection									
L2TH203060L	988	1218	1388	29	29.50	60	36	121	9
L2TH203066L	1020	1264	1452	29	29.50	66	36	135	9
L2TH203072L	1051	1316	1515	29	29.50	72	36	150	10
L2TH203078L	1080	1365	1580	29	29.50	78	36	164	11
L2TH203084L	1110	1417	1641	29	29.50	84	36	178	12
L2TH203660L	1057	1318	1511	29	29.50	60	42	188	10
L2TH203666L	1093	1376	1584	29	29.50	66	42	202	11
L2TH203672L	1131	1433	1656	29	29.50	72	42	217	12
L2TH203678L	1164	1494	1728	29	29.50	78	42	220	12
L2TH203684L	1198	1552	1802	29	29.50	84	42	237	13
For 24" Return Connection									
L2TH3060L	988	1218	1388	29	29.50	60	36	121	9
L2TH3066L	1020	1264	1452	29	29.50	66	36	135	9
L2TH3072L	1051	1316	1515	29	29.50	72	36	150	10
L2TH3078L	1080	1365	1580	29	29.50	78	36	164	11
L2TH3084L	1110	1417	1641	29	29.50	84	36	178	12
L2TH3660L	1057	1318	1511	29	29.50	60	42	188	10
L2TH3666L	1093	1376	1584	29	29.50	66	42	202	11
L2TH3672L	1131	1433	1656	29	29.50	72	42	217	12
L2TH3678L	1164	1494	1728	29	29.50	78	42	220	12
L2TH3684L	1198	1552	1802	29	29.50	84	42	237	13

L2TH-R • Hockey Shaped Top Right with T-Base & Leg

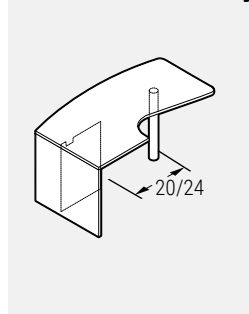

• Add \$118 to list price for chrome leg option.

PRODUCT CODE	FINISH LP	B	W	SIZE/INCHES			D	WEIGHT LBS	VOL FT ³
				H(LP/B)	H(W)	W			
For 20" Return Connection									
L2TH203060R	988	1218	1388	29	29.50	60	36	121	9
L2TH203066R	1020	1264	1452	29	29.50	66	36	135	9
L2TH203072R	1051	1316	1515	29	29.50	72	36	150	10
L2TH203078R	1080	1365	1580	29	29.50	78	36	164	11
L2TH203084R	1110	1417	1641	29	29.50	84	36	178	12
L2TH203660R	1057	1318	1511	29	29.50	60	42	188	10
L2TH203666R	1093	1376	1584	29	29.50	66	42	202	11
L2TH203672R	1131	1433	1656	29	29.50	72	42	217	12
L2TH203678R	1164	1494	1728	29	29.50	78	42	220	12
L2TH203684R	1198	1552	1802	29	29.50	84	42	237	13
For 24" Return Connection									
L2TH3060R	988	1218	1388	29	29.50	60	36	121	9
L2TH3066R	1020	1264	1452	29	29.50	66	36	135	9
L2TH3072R	1051	1316	1515	29	29.50	72	36	150	10
L2TH3078R	1080	1365	1580	29	29.50	78	36	164	11
L2TH3084R	1110	1417	1641	29	29.50	84	36	178	12
L2TH3660R	1057	1318	1511	29	29.50	60	42	188	10
L2TH3666R	1093	1376	1584	29	29.50	66	42	202	11
L2TH3672R	1131	1433	1656	29	29.50	72	42	217	12
L2TH3678R	1164	1494	1728	29	29.50	78	42	220	12
L2TH3684R	1198	1552	1802	29	29.50	84	42	237	13

L2THH-L • Hockey Shaped Top Left with Half Modesty & Leg

• Add \$118 to list price for chrome leg option.

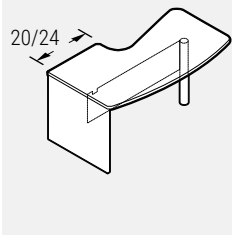

PRODUCT CODE	FINISH LP	B	W	SIZE / INCHES				WEIGHT LBS	VOL FT ³
				H (LP/B)	H (W)	W	D		
For 20" Return Connection									
L2THH203060L	997	1225	1396	29	29.50	60	36	117	9
L2THH203066L	1036	1286	1472	29	29.50	66	36	131	9
L2THH203072L	1077	1348	1544	29	29.50	72	36	145	10
L2THH203078L	1119	1406	1619	29	29.50	78	36	160	11
L2THH203084L	1161	1467	1692	29	29.50	84	36	174	12
L2THH203660L	1058	1318	1511	29	29.50	60	42	184	10
L2THH203666L	1102	1387	1592	29	29.50	66	42	198	11
L2THH203672L	1147	1454	1674	29	29.50	72	42	212	12
L2THH203678L	1195	1522	1759	29	29.50	78	42	220	12
L2THH203684L	1235	1591	1840	29	29.50	84	42	237	13
For 24" Return Connection									
L2THH3060L	997	1225	1396	29	29.50	60	36	117	9
L2THH3066L	1036	1286	1472	29	29.50	66	36	131	9
L2THH3072L	1077	1348	1544	29	29.50	72	36	145	10
L2THH3078L	1119	1406	1619	29	29.50	78	36	160	11
L2THH3084L	1161	1467	1692	29	29.50	84	36	174	12
L2THH3660L	1058	1318	1511	29	29.50	60	42	184	10
L2THH3666L	1102	1387	1592	29	29.50	66	42	198	11
L2THH3672L	1147	1454	1674	29	29.50	72	42	212	12
L2THH3678L	1195	1522	1759	29	29.50	78	42	220	12
L2THH3684L	1235	1591	1840	29	29.50	84	42	237	13

L2THH-R • Hockey Shaped Top Right with Half Modesty & Leg

• Add \$118 to list price for chrome leg option.

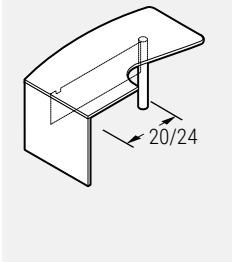

PRODUCT CODE	FINISH LP	B	W	SIZE / INCHES				WEIGHT LBS	VOL FT ³
				H (LP/B)	H (W)	W	D		
For 20" Return Connection									
L2THH203060R	997	1225	1396	29	29.50	60	36	117	9
L2THH203066R	1036	1286	1472	29	29.50	66	36	131	9
L2THH203072R	1077	1348	1544	29	29.50	72	36	145	10
L2THH203078R	1119	1406	1619	29	29.50	78	36	160	11
L2THH203084R	1161	1467	1692	29	29.50	84	36	174	12
L2THH203660R	1058	1318	1511	29	29.50	60	42	184	10
L2THH203666R	1102	1387	1592	29	29.50	66	42	198	11
L2THH203672R	1147	1454	1674	29	29.50	72	42	212	12
L2THH203678R	1195	1522	1759	29	29.50	78	42	220	12
L2THH203684R	1235	1591	1840	29	29.50	84	42	237	13
For 24" Return Connection									
L2THH3060R	997	1225	1396	29	29.50	60	36	117	9
L2THH3066R	1036	1286	1472	29	29.50	66	36	131	9
L2THH3072R	1077	1348	1544	29	29.50	72	36	145	10
L2THH3078R	1119	1406	1619	29	29.50	78	36	160	11
L2THH3084R	1161	1467	1692	29	29.50	84	36	174	12
L2THH3660R	1058	1318	1511	29	29.50	60	42	184	10
L2THH3666R	1102	1387	1592	29	29.50	66	42	198	11
L2THH3672R	1147	1454	1674	29	29.50	72	42	212	12
L2THH3678R	1195	1522	1759	29	29.50	78	42	220	12
L2THH3684R	1235	1591	1840	29	29.50	84	42	237	13

L2TEDH-L • Extended “D” with Half Modesty & Leg

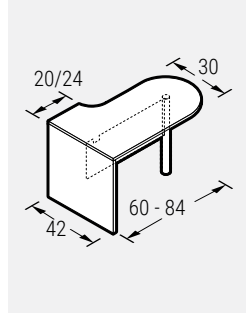

• Add \$118 to list price for chrome leg option.

PRODUCT CODE	FINISH LP	B	W	SIZE/INCHES			D	WEIGHT LBS	VOL FT ³
				H(LP/B)	H(W)	W			
For 20" Return Connection									
L2TEDH603020L	1082	1288	1475	29	29.50	60	42	110	8
L2TEDH663020L	1126	1353	1555	29	29.50	66	42	121	9
L2TEDH723020L	1170	1418	1635	29	29.50	72	42	132	10
L2TEDH783020L	1220	1484	1715	29	29.50	78	42	143	11
L2TEDH843020L	1261	1552	1794	29	29.50	84	42	154	12
For 24" Return Connection									
L2TEDH603024L	1082	1288	1475	29	29.50	60	42	110	8
L2TEDH663024L	1126	1353	1555	29	29.50	66	42	121	9
L2TEDH723024L	1170	1418	1635	29	29.50	72	42	132	10
L2TEDH783024L	1220	1484	1715	29	29.50	78	42	143	11
L2TEDH843024L	1261	1552	1794	29	29.50	84	42	154	12

L2TED-L • Extended “D” with T-Base & Leg

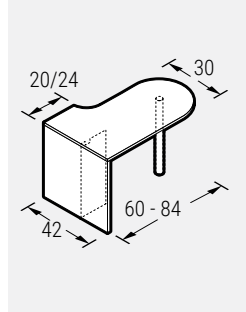

• Add \$118 to list price for chrome leg option.

PRODUCT CODE	FINISH LP	B	W	SIZE/INCHES			D	WEIGHT LBS	VOL FT ³
				H(LP/B)	H(W)	W			
For 20" Return Connection									
L2TED603020L	1070	1263	1448	29	29.50	60	42	110	8
L2TED663020L	1106	1318	1517	29	29.50	66	42	121	9
L2TED723020L	1140	1375	1587	29	29.50	72	42	132	10
L2TED783020L	1175	1430	1658	29	29.50	78	42	143	11
L2TED843020L	1210	1484	1727	29	29.50	84	42	154	12
For 24" Return Connection									
L2TED603024L	1070	1263	1448	29	29.50	60	42	110	8
L2TED663024L	1106	1318	1517	29	29.50	66	42	121	9
L2TED723024L	1140	1375	1587	29	29.50	72	42	132	10
L2TED783024L	1175	1430	1658	29	29.50	78	42	143	11
L2TED843024L	1210	1484	1727	29	29.50	84	42	154	12

L2TEDH-R • Extended “D” with Half Modesty & Leg

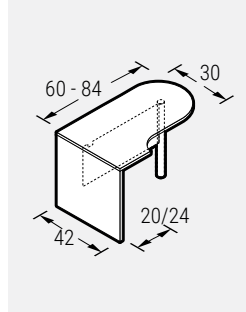

• Add \$118 to list price for chrome leg option.

PRODUCT CODE	FINISH LP	B	W	SIZE/INCHES			D	WEIGHT LBS	VOL FT ³
				H(LP/B)	H(W)	W			
For 20" Return Connection									
L2TEDH603020R	1082	1288	1475	29	29.50	60	42	110	8
L2TEDH663020R	1126	1353	1555	29	29.50	66	42	121	9
L2TEDH723020R	1170	1418	1635	29	29.50	72	42	132	10
L2TEDH783020R	1220	1484	1715	29	29.50	78	42	143	11
L2TEDH843020R	1261	1552	1794	29	29.50	84	42	154	12
For 24" Return Connection									
L2TEDH603024R	1082	1288	1475	29	29.50	60	42	110	8
L2TEDH663024R	1126	1353	1555	29	29.50	66	42	121	9
L2TEDH723024R	1170	1418	1635	29	29.50	72	42	132	10
L2TEDH783024R	1220	1484	1715	29	29.50	78	42	143	11
L2TEDH843024R	1261	1552	1794	29	29.50	84	42	154	12

L2TED-R • Extended “D” with T-Base & Leg

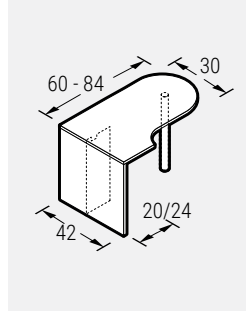

• Add \$118 to list price for chrome leg option.

PRODUCT CODE	FINISH LP	B	W	SIZE/INCHES			D	WEIGHT LBS	VOL FT ³
				H(LP/B)	H(W)	W			
For 20" Return Connection									
L2TED603020R	1070	1263	1448	29	29.50	60	42	110	8
L2TED663020R	1106	1318	1517	29	29.50	66	42	121	9
L2TED723020R	1140	1375	1587	29	29.50	72	42	132	10
L2TED783020R	1175	1430	1658	29	29.50	78	42	143	11
L2TED843020R	1210	1484	1727	29	29.50	84	42	154	12
For 24" Return Connection									
L2TED603024R	1070	1263	1448	29	29.50	60	42	110	8
L2TED663024R	1106	1318	1517	29	29.50	66	42	121	9
L2TED723024R	1140	1375	1587	29	29.50	72	42	132	10
L2TED783024R	1175	1430	1658	29	29.50	78	42	143	11
L2TED843024R	1210	1484	1727	29	29.50	84	42	154	12

L2TROL • Licence 2 Top with “O” Leg and T base

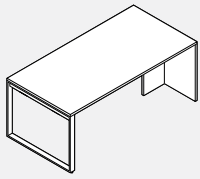

- Includes worksurface, loop leg and laminate T base.
- BG5 grommet please specify TC only.
- Loop leg is painted please specify standard paint colour.

PRODUCT CODE	FINISH				WEIGHT		VOL FT ³
	LP	B	W	D	W	LBS	
L2TROL2442	889	953	1041	24	42	138	5
L2TROL2448	927	1005	1086	24	48	153	5
L2TROL2454	969	1057	1132	24	54	168	6
L2TROL2460	1003	1102	1176	24	60	183	6
L2TROL2466	1016	1121	1221	24	66	198	6
L2TROL2472	1031	1140	1266	24	72	213	7
L2TROL2478	1056	1169	1307	24	78	228	7
L2TROL2484	1085	1205	1351	24	84	243	7
L2TROL3042	1041	1124	1200	30	42	168	7
L2TROL3048	1056	1143	1210	30	48	187	7
L2TROL3054	1081	1168	1307	30	54	206	8
L2TROL3060	1102	1207	1363	30	60	225	8
L2TROL3066	1114	1225	1417	30	66	243	8
L2TROL3072	1136	1251	1470	30	72	262	9
L2TROL3078	1159	1277	1522	30	78	281	9
L2TROL3084	1201	1331	1579	30	84	300	10
L2TROL3642	1143	1223	1351	36	42	200	7
L2TROL3648	1186	1274	1418	36	48	222	8
L2TROL3654	1225	1327	1484	36	54	245	8
L2TROL3660	1268	1378	1554	36	60	267	9
L2TROL3666	1310	1431	1620	36	66	290	9
L2TROL3672	1351	1482	1687	36	72	312	10
L2TROL3678	1392	1533	1753	36	78	335	10
L2TROL3684	1433	1586	1821	36	84	357	11

L2TCROL • Licence 2 Return with “O” Leg

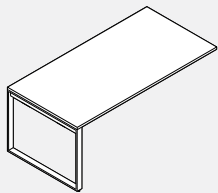

- Includes worksurface, loop leg and connecting brackets and connecting flat brackets
- HAT channel is standard on all tops except 42 and 48 wide
- BG5 grommet please specify TL,TC,TR
- Loop leg is painted please specify standard paint colour
- Worksurface supporting pedestals and laterals will not fit due to the metal channel under the surface.

PRODUCT CODE	FINISH				WEIGHT		VOL FT ³
	LP	B	W	D	W	LBS	
L2TCROL2442	662	726	816	24	42	110	4
L2TCROL2448	701	779	860	24	48	125	5
L2TCROL2454	804	892	967	24	54	140	5
L2TCROL2460	845	947	1021	24	60	155	5
L2TCROL2466	868	972	1071	24	66	170	6
L2TCROL2472	891	1000	1126	24	72	185	6
L2TCROL2478	924	1037	1176	24	78	200	6
L2TCROL2484	959	1082	1227	24	84	215	7
L2TCROL3042	790	872	949	30	42	137	6
L2TCROL3048	804	892	959	30	48	156	6
L2TCROL3054	891	978	1119	30	54	175	7
L2TCROL3060	922	1026	1181	30	60	194	7
L2TCROL3066	942	1054	1243	30	66	212	8
L2TCROL3072	971	1086	1305	30	72	231	8
L2TCROL3078	1003	1121	1366	30	78	250	8
L2TCROL3084	1054	1183	1428	30	84	269	9
L2TCROL3642	892	971	1099	36	42	164	7
L2TCROL3648	934	1024	1166	36	48	186	7
L2TCROL3654	1035	1136	1294	36	54	209	8
L2TCROL3660	1088	1198	1371	36	60	231	8
L2TCROL3666	1137	1260	1448	36	66	254	9
L2TCROL3672	1187	1317	1522	36	72	276	9
L2TCROL3678	1235	1376	1597	36	78	299	10
L2TCROL3684	1286	1438	1671	36	84	321	10

L2TDOL • Licence 2 Top with Two "O" Legs

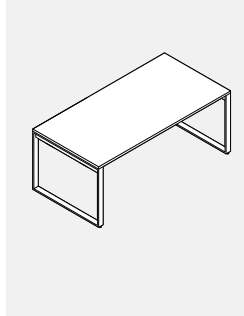

- Includes worksurface, 2 loop legs
- HAT channel is standard on all tops except 42 and 48 wide
- BG5 grommet please specify TL,TC,TR
- Loop leg is painted please specify standard paint colour
- Worksurface supporting pedestals and laterals will not fit due to the metal channel under the surface.

PRODUCT CODE	FINISH			D	W	WEIGHT		VOL FT ³
	LP	B	W			LBS		
L2TDOL2442	1055	1119	1207	24	42	115	6	
L2TDOL2448	1093	1170	1252	24	48	130	7	
L2TDOL2454	1197	1285	1357	24	54	145	7	
L2TDOL2460	1238	1338	1414	24	60	160	7	
L2TDOL2466	1261	1365	1464	24	66	175	8	
L2TDOL2472	1284	1393	1520	24	72	190	8	
L2TDOL2478	1316	1430	1568	24	78	205	8	
L2TDOL2484	1353	1473	1619	24	84	220	9	
L2TDOL3042	1243	1328	1401	30	42	143	9	
L2TDOL3048	1258	1345	1415	30	48	162	9	
L2TDOL3054	1343	1431	1570	30	54	181	10	
L2TDOL3060	1374	1480	1634	30	60	200	10	
L2TDOL3066	1394	1505	1696	30	66	218	11	
L2TDOL3072	1426	1539	1758	30	72	237	11	
L2TDOL3078	1455	1573	1819	30	78	256	11	
L2TDOL3084	1505	1635	1880	30	84	275	12	
L2TDOL3642	1392	1471	1598	36	42	170	10	
L2TDOL3648	1432	1522	1667	36	48	192	10	
L2TDOL3654	1535	1635	1794	36	54	215	11	
L2TDOL3660	1586	1696	1871	36	60	237	11	
L2TDOL3666	1637	1758	1947	36	66	260	12	
L2TDOL3672	1685	1816	2022	36	72	282	12	
L2TDOL3678	1734	1877	2096	36	78	305	13	
L2TDOL3684	1785	1936	2170	36	84	327	13	

Technical Information

- All units must be connected to an adjoining unit with flat brackets included.
 - Grommet option for Runoff tables are "TC" only.
- NOTE: All Runoff tables includes HAT CHANNEL support.

OPTIONS:

- Top: LP - LPL (Low Pressure Laminate) Thickness 1"
 HP B - B Thickness 1 1/16"
 HP W - W Thickness 1 7/16"
- Leg Option: BHML03 (DEFAULT) Round Monoleg
 LLSQ3X3H28 - Square Leg
- Top Finish Laminate: Choose Colour
- Top PVC Edging: Choose Colour
- Metal Leg Finish: Choose Colour

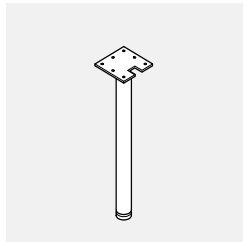

BHML03

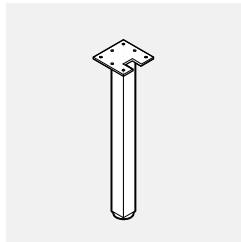

LLSQ3X3H28

L2TCD • "D" Shaped Runoff with Leg

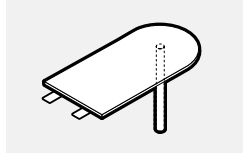

- Add \$118 to list price for chrome leg option.

PRODUCT CODE	FINISH			SIZE/INCHES				WEIGHT		VOL FT ³
	LP	B	W	H (LP/B)	H (W)	W	D	LBS		
L2TCD3060	713	895	947	29	29.5	60	30	97	4	
L2TCD3066	757	956	1021	29	29.5	66	30	106	6	
L2TCD3660	777	992	1069	29	29.5	60	36	97	4	
L2TCD3666	811	1047	1133	29	29.5	66	36	106	6	

L2TCR1L • Rectangular Shaped Runoff

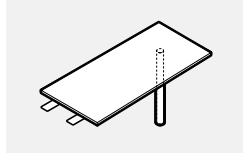

- Add \$118 to list price for chrome leg option.

PRODUCT CODE	FINISH			SIZE/INCHES				WEIGHT		VOL FT ³
	LP	B	W	H (LP/B)	H (W)	W	D	LBS		
L2TCR1L3060	690	862	919	29	29.5	60	30	97	4	
L2TCR1L3066	718	908	969	29	29.5	66	30	106	6	
L2TCR1L3660	736	942	1013	29	29.5	60	36	97	4	
L2TCR1L3666	769	993	1074	29	29.5	66	36	106	6	

L2TCA1L • Axe Shaped Runoff

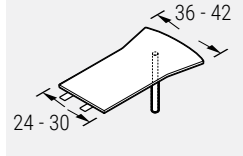

- Add \$118 to list price for chrome leg option.

PRODUCT CODE	FINISH			SIZE/INCHES				WEIGHT		VOL FT ³
	LP	B	W	H (LP/B)	H (W)	W	D	LBS		
L2TCA1L2460	739	944	1022	29	29.5	60	36	119	4	
L2TCA1L2466	773	996	1081	29	29.5	66	36	130	6	
L2TCA1L3060	785	1020	1114	29	29.5	60	42	119	4	
L2TCA1L3066	824	1077	1181	29	29.5	66	42	130	6	

L2TCP • "P" Shaped Runoff with Leg

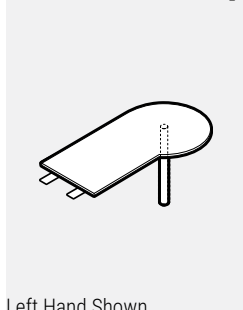

- Add \$118 to list price for chrome leg option.

PRODUCT CODE	FINISH			SIZE/INCHES				WEIGHT		VOL FT ³
	LP	B	W	H (LP/B)	H (W)	W	D	LBS		
Right										
L2TCP3060R	774	988	1069	29	29.5	60	36	119	4	
L2TCP3066R	809	1043	1133	29	29.5	66	36	130	6	
L2TCP3660R	826	1071	1169	29	29.5	60	42	119	4	
L2TCP3666R	866	1134	1239	29	29.5	66	42	130	6	
Left										
L2TCP3060L	774	988	1069	29	29.5	60	36	119	4	
L2TCP3066L	809	1043	1133	29	29.5	66	36	130	6	
L2TCP3660L	826	1071	1169	29	29.5	60	42	119	4	
L2TCP3666L	866	1134	1239	29	29.5	66	42	130	6	

Left Hand Shown

L2TCW • Wedge Shaped Runoff with Leg

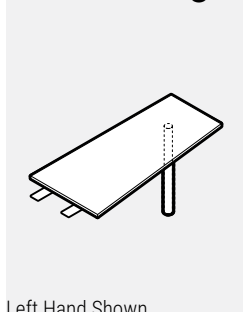

- Add \$118 to list price for chrome leg option.

PRODUCT CODE	FINISH			SIZE/INCHES				WEIGHT		VOL FT ³
	LP	B	W	H (LP/B)	H (W)	W	D	LBS		
Right										
L2TCW3060R	733	915	982	29	29.5	60	30	119	4	
L2TCW3066R	765	965	1034	29	29.5	66	30	130	6	
L2TCW3660R	785	999	1084	29	29.5	60	36	119	4	
L2TCW3666R	820	1055	1143	29	29.5	66	36	130	6	
Left										
L2TCW3060L	733	915	982	29	29.5	60	30	119	4	
L2TCW3066L	765	965	1034	29	29.5	66	30	130	6	
L2TCW3660L	785	999	1084	29	29.5	60	36	119	4	
L2TCW3666L	820	1055	1143	29	29.5	66	36	130	6	

Left Hand Shown

Floating Tops

- Monolegs and Support channel ships in a separate box.
- Floating tops are not pre-drilled to accept monolegs or spacers.
- Grommet locations (TC only) must be specified at the time of order or it will default to "No Grommet" option.
- Floating top must be placed on top of 1H credenza or 1H lateral open.
- Grommet Option **TC** only
- All Floating tables include HAT CHANNEL support.

LLSQ3X3 • "Spacer" Leg

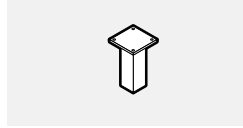

PRODUCT CODE	PRICE	CHROME OPT	SIZE/INCHES			WEIGHT LBS	VOL FT ³
			H	W	D		
LLSQ3X3	135	230	8	3	3	4	0.09

LLSQ3X3H28 • Square Leg

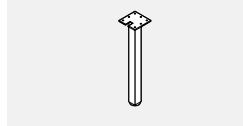

PRODUCT CODE	PRICE	CHROME OPT	SIZE/INCHES			WEIGHT LBS	VOL FT ³
			H	W	D		
LLSQ3X3H28	255	338	28	3	3	4	0.17

L2FD • Floating "D" Shaped with Legs and Spacers

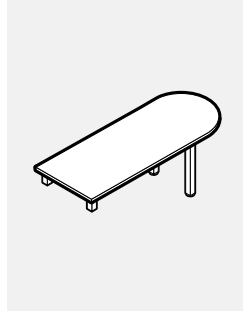

- Add \$469 to list price for chrome leg option.

PRODUCT CODE	FINISH			SIZE/INCHES				WEIGHT LBS	VOL FT ³
	LP	B	W	H(LP/B)	H(W)	W	D		
L2FD3060	941	1133	1151	29	29.5	60	30	53	7
L2FD3066	971	1179	1201	29	29.5	66	30	57	7
L2FD3072	1003	1227	1254	29	29.5	72	30	62	8
L2FD3078	1036	1282	1305	29	29.5	78	30	64	8
L2FD3084	1082	1341	1355	29	29.5	84	30	68	9
L2FD3660	987	1235	1328	29	29.5	60	36	57	8
L2FD3666	1022	1291	1393	29	29.5	66	36	63	8
L2FD3672	1057	1350	1455	29	29.5	72	36	68	9
L2FD3678	1098	1412	1520	29	29.5	78	36	70	9
L2FD3684	1143	1480	1585	29	29.5	84	36	75	10

L2FR • Floating Rectangular Shaped with Legs and Spacers

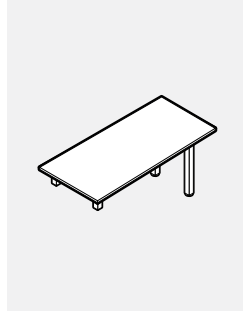

- Add \$469 to list price for chrome leg option.

PRODUCT CODE	FINISH			SIZE/INCHES				WEIGHT LBS	VOL FT ³
	LP	B	W	H(LP/B)	H(W)	W	D		
L2FR2460	890	1051	1076	29	29.5	60	24	51	6
L2FR2466	916	1092	1120	29	29.5	66	24	55	6
L2FR2472	945	1133	1164	29	29.5	72	24	59	7
L2FR2478	975	1175	1205	29	29.5	78	24	62	7
L2FR2484	1015	1228	1252	29	29.5	84	24	66	8
L2FR3060	935	1131	1173	29	29.5	60	30	53	7
L2FR3066	969	1175	1225	29	29.5	66	30	57	7
L2FR3072	1000	1225	1280	29	29.5	72	30	62	8
L2FR3078	1035	1279	1329	29	29.5	78	30	64	8
L2FR3084	1077	1335	1383	29	29.5	84	30	68	9
L2FR3660	983	1205	1297	29	29.5	60	36	57	8
L2FR3666	1020	1262	1357	29	29.5	66	36	63	8
L2FR3672	1056	1318	1421	29	29.5	72	36	68	9
L2FR3678	1095	1376	1484	29	29.5	78	36	70	9
L2FR3684	1141	1444	1548	29	29.5	84	36	75	10

L2FA • Floating Axe Shaped with Legs and Spacers

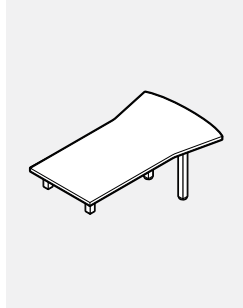

- Add \$469 to list price for chrome leg option.

PRODUCT CODE	FINISH			SIZE/INCHES				WEIGHT LBS	VOL FT ³
	LP	B	W	H(LP/B)	H(W)	W	D		
L2FA3060	1036	1293	1378	29	29.5	60	42	77	8
L2FA3066	1077	1356	1448	29	29.5	66	42	81	8
L2FA3072	1119	1420	1518	29	29.5	72	42	84	9
L2FA3078	1163	1485	1587	29	29.5	78	42	88	9
L2FA3084	1217	1560	1658	29	29.5	84	42	95	10
L2FA3660	1106	1394	1507	29	29.5	60	48	83	9
L2FA3666	1148	1464	1586	29	29.5	66	48	88	9
L2FA3672	1196	1535	1667	29	29.5	72	48	90	10
L2FA3678	1239	1608	1746	29	29.5	78	48	95	11
L2FA3684	1297	1690	1821	29	29.5	84	48	101	11

L2FP • Floating “P” Shaped with Legs and Spacers

• Add \$469 to list price for chrome leg option.

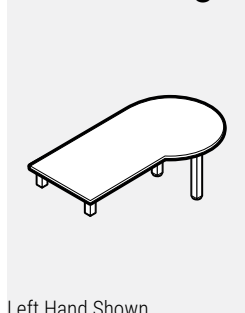

Left Hand Shown

PRODUCT CODE	FINISH LP	B	W	SIZE/INCHES				WEIGHT LBS	VOL FT ³
				H(LP/B)	H(W)	W	D		
Right									
L2FP3060R	1004	1228	1301	29	29.5	60	36	66	8
L2FP3066R	1038	1286	1364	29	29.5	66	36	70	8
L2FP3072R	1076	1341	1426	29	29.5	72	36	75	9
L2FP3078R	1115	1399	1484	29	29.5	78	36	77	9
L2FP3084R	1163	1467	1546	29	29.5	84	36	81	10
L2FP3660R	1055	1312	1401	29	29.5	60	42	70	9
L2FP3666R	1093	1374	1472	29	29.5	66	42	76	9
L2FP3672R	1134	1438	1542	29	29.5	72	42	81	10
L2FP3678R	1177	1503	1612	29	29.5	78	42	84	11
L2FP3684R	1228	1579	1684	29	29.5	84	42	88	11
Left									
L2FP3060L	1004	1228	1301	29	29.5	60	36	66	8
L2FP3066L	1038	1286	1364	29	29.5	66	36	70	8
L2FP3072L	1076	1341	1426	29	29.5	72	36	75	9
L2FP3078L	1115	1399	1484	29	29.5	78	36	77	9
L2FP3084L	1163	1467	1546	29	29.5	84	36	81	10
L2FP3660L	1055	1312	1401	29	29.5	60	42	70	9
L2FP3666L	1093	1374	1472	29	29.5	66	42	76	9
L2FP3672L	1134	1438	1542	29	29.5	72	42	81	10
L2FP3678L	1177	1503	1612	29	29.5	78	42	84	11
L2FP3684L	1228	1579	1684	29	29.5	84	42	88	11

L2FW • Floating Wedge Shaped with Legs and Spacers

• Add \$469 to list price for chrome leg option.

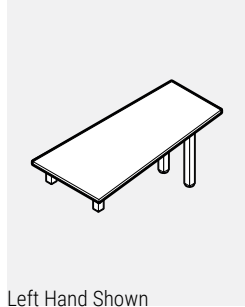

Left Hand Shown

PRODUCT CODE	FINISH LP	B	W	SIZE/INCHES				WEIGHT LBS	VOL FT ³
				H(LP/B)	H(W)	W	D		
Right									
L2FW3060R	941	1133	1175	29	29.5	60	30	53	7
L2FW3066R	971	1179	1229	29	29.5	66	30	57	7
L2FW3072R	1003	1227	1284	29	29.5	72	30	62	8
L2FW3078R	1036	1282	1334	29	29.5	78	30	64	8
L2FW3084R	1082	1341	1387	29	29.5	84	30	68	9
L2FW3660R	983	1205	1268	29	29.5	60	36	57	8
L2FW3666R	1020	1262	1329	29	29.5	66	36	63	8
L2FW3672R	1056	1318	1392	29	29.5	72	36	68	9
L2FW3678R	1095	1376	1453	29	29.5	78	36	70	9
L2FW3684R	1141	1444	1515	29	29.5	84	36	75	10
Left									
L2FW3060L	941	1133	1175	29	29.5	60	30	53	7
L2FW3066L	971	1179	1229	29	29.5	66	30	57	7
L2FW3072L	1003	1227	1284	29	29.5	72	30	62	8
L2FW3078L	1036	1282	1334	29	29.5	78	30	64	8
L2FW3084L	1082	1341	1387	29	29.5	84	30	68	9
L2FW3660L	983	1205	1268	29	29.5	60	36	57	8
L2FW3666L	1020	1262	1329	29	29.5	66	36	63	8
L2FW3672L	1056	1318	1392	29	29.5	72	36	68	9
L2FW3678L	1095	1376	1453	29	29.5	78	36	70	9
L2FW3684L	1141	1444	1515	29	29.5	84	36	75	10

L2FBR • Floating top Rectangular with Legs / SPACERS SOLD SEPARATELY

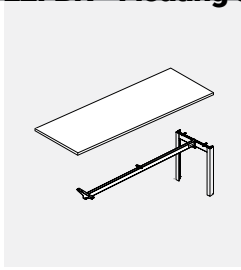

- Anodized aluminum leg upcharge \$55.
- Due to beam location, grommet is only available as a special request, please contact your customer service representative.
- Worksurface supporting pedestals and laterals will not fit due to the metal channel under the surface.

PRODUCT CODE	FINISH LP	B	W	SIZE / INCHES			D	WEIGHT LBS	VOL FT ³
				H (LP/B)	H (W)	W			
L2FBR2466	828	953	1052	1	1.44	66	24	51	6
L2FBR2472	854	987	1095	1	1.44	72	24	55	6
L2FBR2478	888	1032	1147	1	1.44	78	24	59	7
L2FBR2484	926	1081	1203	1	1.44	84	24	62	7
L2FBR3066	895	1049	1166	1	1.44	66	30	53	8
L2FBR3072	924	1092	1220	1	1.44	72	30	57	8
L2FBR3078	963	1141	1280	1	1.44	78	30	62	9
L2FBR3084	1004	1199	1345	1	1.44	84	30	64	9

L2SPBOX • Laminate Spacers with Glass Shelf

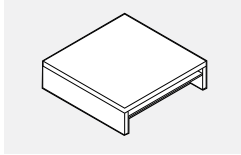

- Glazing is clear.

PRODUCT CODE	PRICE LP	SIZE / INCHES			WEIGHT LBS	VOL FT ³
		H	W	D		
L2SPBOX1620	547	8	16	20	15	1
L2SPBOX1626	612	8	16	26	18	2
L2SPBOX1634	696	8	16	34	22	5

L2FFL • Licence Floating Tops with "O" Leg

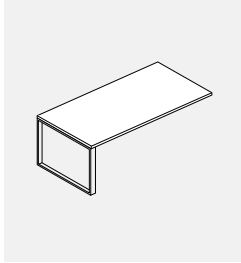

- Kit includes a worksurface, "O" leg and channel.
- Option for grommet - BG5, TC only.
- Painted loop leg, please specify standard paint colour.
- Worksurface supporting pedestals and laterals will not fit due to the metal channel under the surface.

PRODUCT CODE	FINISH LP	B	W	SIZE / INCHES			D	WEIGHT LBS	VOL FT ³
				H (LP/B)	H (W)	W			
L2FFL2466	805	910	1009	1	1.44	66	24	55	6
L2FFL2472	826	935	1062	1	1.44	72	24	59	7
L2FFL2478	857	970	1104	1	1.44	78	24	62	7
L2FFL2484	892	1013	1158	1	1.44	84	24	66	8
L2FFL3066	879	991	1181	1	1.44	66	30	57	7
L2FFL3072	906	1021	1239	1	1.44	72	30	62	8
L2FFL3078	934	1054	1299	1	1.44	78	30	64	8
L2FFL3084	985	1114	1360	1	1.44	84	30	68	9
L2FFL3666	1075	1197	1386	1	1.44	66	36	63	8
L2FFL3672	1121	1252	1455	1	1.44	72	36	68	9
L2FFL3678	1166	1309	1529	1	1.44	78	36	70	9
L2FFL3684	1218	1368	1604	1	1.44	84	36	75	10

L2HGAMP • Hanging Aluminum Framed Frosted Glazing Modesty

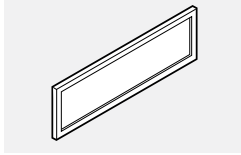

- Framed is anodize aluminum.
- Glazing is frosted acrylic.
- Hanging brackets are included.

PRODUCT CODE	PRICE	SIZE / INCHES			WEIGHT LBS	VOL FT ³
		H	W	D		
L2HGAMP36	490	14	35.50	0.75	12	1
L2HGAMP42	526	14	41.50	0.75	13	1
L2HGAMP48	562	14	47.50	0.75	14	1
L2HGAMP54	601	14	53.50	0.75	16	1

L2HGMP • Hanging Laminate Modesty

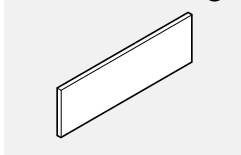

- Hanging brackets are included.

PRODUCT CODE	PRICE LP	SIZE / INCHES			WEIGHT LBS	VOL FT ³
		H	W	D		
L2HGMP36	286	14	36	0.75	9	1
L2HGMP42	294	14	42	0.75	11	1
L2HGMP48	305	14	48	0.75	13	1
L2HGMP54	311	14	54	0.75	14	1

General Notes

Pedestals

• Pedestals are shipped assembled.

- Pedestals are offered in three types of applications: Worksurface Supporting, Freestanding, and Mobile.
- Pedestal front width is 15-1/2" with a deep size variation 18" 23" 24" 29" 30" 36"
- If specifying a pedestal for a desk or credenza, please ensure you specify next depth lower ie. 23" deep pedestal for a 24" deep credenza or desk.
- Worksurface supporting Pedestals are 28"high
- Freestanding pedestals come with the choice of "LP", "B" for 29"high or "W" thickness top for 29.5"high
- Pedestals Freestanding are on adjustable levelers
- Mobile pedestals come with a top with the choice of "LP", "B" for 29"high or "W" thickness top for 29.5"high and have front locking casters to support the pedestal.
- Pencil tray included in the top box drawer of each pedestal.
- Box drawers mounted on full extension ball bearing slides
- File drawers mounted on full extension ball bearing slides
- All file drawers come with adjustable rails for legal or letter size hanging folders. See File Drawer Capacity chart page G2.
- Pull out shelf for CPU and printer units can support 75 lbs. per shelf and has telescopic extension.
- CPU and printer units have ventilation grommet on back panel.
- Interior clearance of printer shelf is 11".
- Printer pedestals have 2 pull out shelves and the back panel has four round grommets.
- CPU pedestals have 1 pull out shelf and the back panel has two round grommets.
- Both CPU and printer units must be installed under a worksurface to prevent tipping.
- All pedestals with a door, include 1 adjustable shelf.
- Cases and fronts are finished in low pressure laminate.
- Specify thickness of the top to match the thickness of the worksurface.
- Locks are standard on all units. Available in black or silver finish. The lock will match the handle finish.

Hutches and Overheads

• Hutches and overheads are shipped assembled.

- Hutches and overheads are offered in "LP" and "W" thickness with three option heights. See Storage Technical Info page G3.
- Specify thickness of hutch or overhead top to match the thickness of the worksurface.
- Cases and fronts are finished in low pressure laminate.
- Hutches and overheads with hinged doors (laminate or aluminum), flip up fronts have no handle option.
- Hutches with pigeon holes come with touch latch mechanism.
- Hutches and overheads with sliding laminate doors have standard handle options
- Hutches and overheads with sliding glass doors are offered with recessed handle only. The recessed handle is in chrome finish
- Hutches and wall mounted overheads are offered in 4 styles: Open storage, Hinged doors - laminate or anodized aluminum frame doors with the option for glazing: frosted or clear, sliding doors are laminate or glass doors and flip-up doors.
- Once installed, the bottom of the flip-up door overhead will not line up with the bottom of the open or hinged door overhead.
- Wall mounted storage cabinets must be securely attached to wall studs.
- Panel mounted overheads include attachment brackets for Boulevard panels.
- Back panels on hutches comes with a center round grommet for wire access.
- Top on hutch and overhead storage cabinets with flip-up doors is 3/4" thick Low Pressure Laminate. Doors slides on top of the unit.
- Inside dimension for hutches and wall mounted units with flip-up doors is 13 1/4" high x 14 1/2" deep
- Inside dimension for hutches and wall mounted with hinged doors is 12 3/4" high x 15 1/4" deep
- Inside dimension for open hutches and wall mounted is 12 3/4" high x 15 1/4" deep
- Inside dimension for hutches and wall mounted with sliding doors is 12-3/4"high x 13" deep
- Use double sided tape to attach hutches to worksurface.
- Locks are standard on all units. Available in black or silver finish. The lock will match the handle finish.
- Recommended to be installed against and fixed to a wall using appropriate hardware (not included).

Credenzas

• Credenzas are shipped assembled.

- Credenza model # L2CR2H2H or L2CR1H1H must be ordered with counterweights to avoid tipping.
- Credenza come with the choice of "LP", "B" or "W" thickness top
- Credenzas are offered with the choice of "LP", "B" for 20"h. or 29"high and "W" thickness top for 20.5"h or 29.5"high
- Credenza come with hinged doors, laminate or anodized aluminum frame doors with the option for glazing: frosted or clear
- Locks are standard on all units. Available in black or silver finish. The lock will match the handle finish.

Bookcases

• Bookcases are Shipped knocked down (KD).

- Available in 30" or 36" widths and 12.685" and 16.685"depths dimension at base-board with range in height from 29" to 72" with 12" clearance between shelves.
- Bottom shelf is fixed and all other shelves are adjustable.
- Specify thickness of the top to match the thickness and profile of the worksurface.
- Tops are offered "LP" or "B" or "W".
- Up to 42"h, Bookcases are offered in "LP", "B", "W".
- 54"h. and up are offered in "LP" and "W".
- Recommended to be installed against and fixed to a wall using appropriate hardware (not included).

Laterals

• Laterals are shipped assembled.

- Laterals are available in three widths, 30" 36", 42" with a height variation of 28" to 54" and a depth of 20" and 24".
- Tops are offered LP, B or W
- Worksurface supporting units do not come with a top.
- Up to 42"h, laterals are offered in "LP", "B", "W".
- 54"h and up are offered in "LP" and "W".
- Cases and fronts are finished in low pressure laminate.
- Laterals with hinged doors, laminate or anodized aluminum frame doors with the option for glazing: frosted or clear
- Lateral files are offered in 2 types of applications: Worksurface Supporting and Freestanding.
- All lateral files feature a drawer interlocking mechanism
- Up to 42"h, Laterals are offered in "LP", "B", "W".
- 54"h, and up are offered in "LP" and "W".
- All file drawer come with adjustable rails for legal or letter size hanging folders.
- Counterweights must be specified in a lateral configurations except worksurface supporting.
- "C" combo lateral have a pencil drawer included in the box drawer. The penciltray is parallel with the depth of the drawer.
- In "C" combo lateral, only one side can be locked.
- All laterals with a door, include 1 adjustable shelf.
- File drawers mounted on full extension ball bearing slides
- Locks are standard on all units. Available in black or silver finish. The lock will match the handle finish.

Towers and cabinets

• Towers and cabinets are shipped assembled.

- Towers offered 24"w and cabinets 30"w and 36"w are offered in "LP" and "W".
- Cases are finished in low pressure laminate.
- Towers or cabinets are offered with hinged doors, laminate or anodized aluminum frame with the option for glazing: frosted or clear
- Towers or cabinets with anodized aluminum doors are offered without handles. Touch latch mechanism is included.
- Storage tower with the cupboard above FF or BBF and wardrobe will lock only the wardrobe and drawers.
- Storage tower with the wardrobe include a coat rod.
- Locks are standard on all units. Available in black or silver finish. The lock will match the handle finish.
- Counterweights must be specified for units 20" deep by 60" to 72" high with 2H2D or 2H/Open, please order 2 x LACWB for each unit.

LATERAL FILE DRAWERS

Lateral File Drawer:

36W & 42W

Legal Filing - front to back

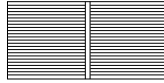

- Drawer file with plastic rail
- 30"W Size 9.44"H x 25.75"W x 16"L
- 36"W Size 9.44"H x 31.75"W x 16"L
- 42"W Size 9.44"H x 37.75"W x 16"L

Lateral File Drawer:

36W & 42W

Legal Filing - side to side

Letter Filing - front to back

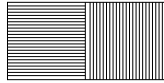
**Lateral File Drawer:**

30W, 36W & 42W

Letter Filing - front to back

**Lateral File Drawer:**

36W & 42W

Letter & Legal Filing - front to back

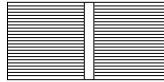
**Lateral File Drawer:**

30W, 36W & 42W

Legal Filing - side to side

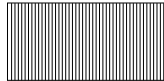

PEDESTAL DRAWERS

Box Drawer:

15.5W

Legal Filing - side to side



- 18"D Drawer Box Size 3.93"H x 13"W x 16"L
- 20.23.24.29.30.36"D Drawer Box Size 3.93"H x 13"W x 20"L

File Drawer:

15.5W

Letter Filing - front to back



- 18"D Drawer File with plastic rail Size 9.4"H x 13"W x 16"L
- 20"D and up Drawer File with plastic rail Size 9.4"H x 13"W x 20"L

File Drawer:

15.5W

Legal Filing - side to side



- 18"D Drawer File with plastic rail Size 9.4"H x 13"W x 16"L
- 20"D and up Drawer File with plastic rail Size 9.4"H x 13"W x 20"L

COMBO LATERAL FILE DRAWERS

- For 30" wide units: Drawer width is 11 3/4" and can accommodate only side to side legal or letter filing.
- For 36" wide units: Drawer width is 14 3/4" and can accommodate only side to side legal or letter filing.

STORAGE TECHNICAL INFORMATION

1" LPL TOP
LP HUTCH
LP DESK 29H
LP CABINET

1-1/16" HPL TOP
LP HUTCH
B TOP DESK 29H
LP CABINET

1-7/16" HPL TOP
W TOP HUTCH
W TOP DESK 29.5H
W CABINET

NO TACKBOARD
LTB
50" High

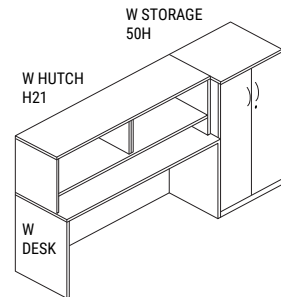
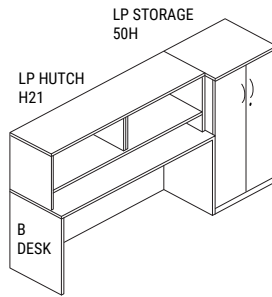
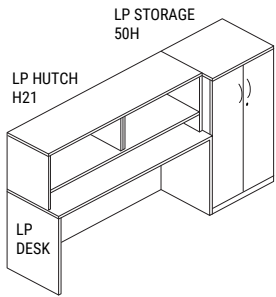

TACKBOARD
LTB21
66" High

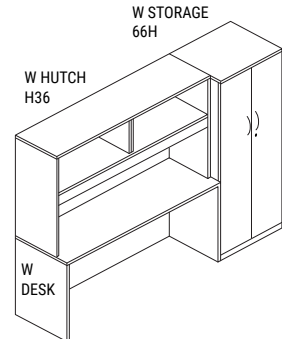
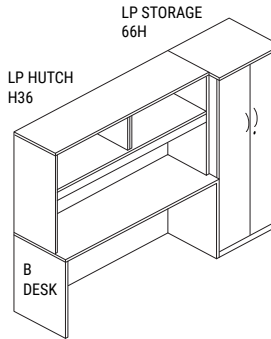
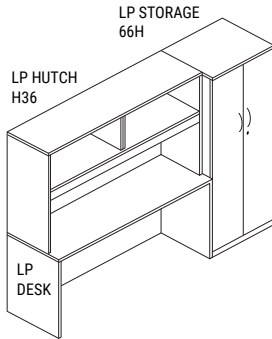

TACKBOARD
LTB27
72" High

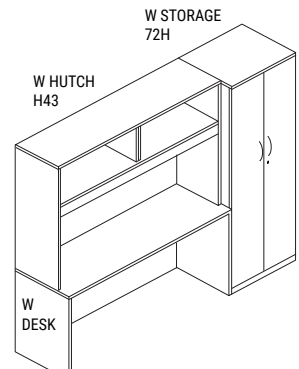
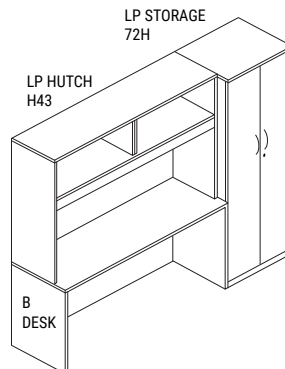
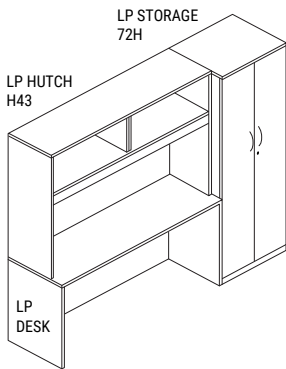

STACK ON TWO HEIGHT CABINET IS TO BE PLACED ON 1H CRENZANA

50" High
Only

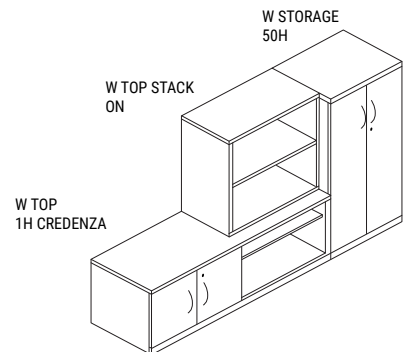
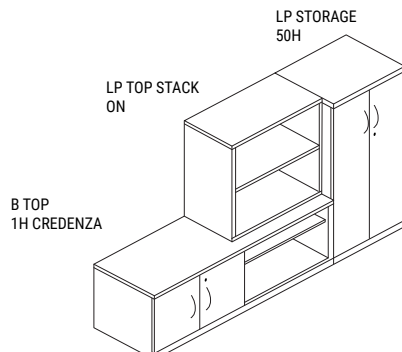
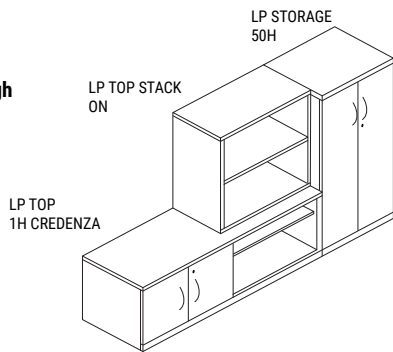

L2PBBF • Worksurface Supporting Box, Box, File Pedestal

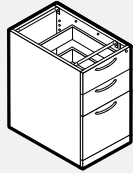

- One lock included.
- Optional e-lock available in the vertical position. Please specify V - Vertical and add \$224 list.
- Counter weight must be ordered separately.

PRODUCT CODE	PRICE LP	SIZE/INCHES			WEIGHT LBS	VOL FT ³
		H	W	D		
L2PBBF18	821	28	15.5	18	94	8
L2PBBF20	895	28	15.5	20	94	8
L2PBBF23	909	28	15.5	23	94	8
L2PBBF24	909	28	15.5	24	99	10
L2PBBF29	943	28	15.5	29	105	10
L2PBBF30	943	28	15.5	30	110	10
L2PBBF36	991	28	15.5	36	116	11

L2PFF • Worksurface Supporting File, File Pedestal

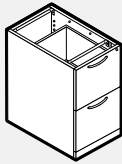

- One lock included.
- Optional e-lock available in the vertical position. Please specify V - Vertical and add \$224 list.

PRODUCT CODE	PRICE LP	SIZE/INCHES			WEIGHT LBS	VOL FT ³
		H	W	D		
L2PFF18	748	28	15.5	18	94	8
L2PFF20	837	28	15.5	20	94	8
L2PFF23	847	28	15.5	23	94	8
L2PFF24	847	28	15.5	24	99	8
L2PFF29	891	28	15.5	29	105	10
L2PFF30	891	28	15.5	30	110	10
L2PFF36	927	28	15.5	36	116	11

L2P1D • Worksurface Supporting 1 Door Pedestal

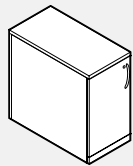

- Includes one adjustable shelf.
- One lock included.
- Optional e-lock available in the horizontal position. Please specify HL - Horizontal Left and add \$204 list.

PRODUCT CODE	PRICE LP	SIZE/INCHES			WEIGHT LBS	VOL FT ³
		H	W	D		
L2P1D18	626	28	15.5	18	66	8
L2P1D20	675	28	15.5	20	74	8
L2P1D23	693	28	15.5	23	74	8
L2P1D24	693	28	15.5	24	75	10
L2P1D29	761	28	15.5	29	84	10
L2P1D30	761	28	15.5	30	85	10

L2PBBF-F • Freestanding Box, Box, File Pedestal

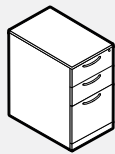

- One lock included.
- Optional e-lock available in the vertical position. Please specify V - Vertical and add \$224 list.
- Counter weight must be ordered separately.

PRODUCT CODE	FINISH LP	B	W	SIZE/INCHES				WEIGHT LBS	VOL FT ³
				H (LP/B)	H (W)	W	D		
L2PBBF20F	972	1000	1038	29	29.5	15.5	20	94	8
L2PBBF24F	987	1015	1055	29	29.5	15.5	24	99	8
L2PBBF30F	1029	1062	1106	29	29.5	15.5	30	105	10
L2PBBF36F	1077	1120	1168	29	29.5	15.5	36	116	11

L2PFF-F • Freestanding File, File Pedestal

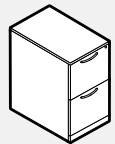

- One lock included.
- Optional e-lock available in the vertical position. Please specify V - Vertical and add \$224 list.
- Counter weight must be ordered separately.

PRODUCT CODE	FINISH LP	B	W	SIZE/INCHES				WEIGHT LBS	VOL FT ³
				H (LP/B)	H (W)	W	D		
L2PFF20F	882	909	972	29	29.5	15.5	20	99	8
L2PFF24F	894	923	988	29	29.5	15.5	24	99	8
L2PFF30F	969	1003	1043	29	29.5	15.5	30	110	10
L2PFF36F	1054	1095	1109	29	29.5	15.5	36	116	11

L2P1D-F • Freestanding 1 Door Pedestal

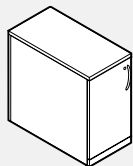

- Includes one adjustable shelf.
- One lock included.
- Optional e-lock available in the horizontal position. Please specify HL - Horizontal Left and add \$224 list.
- Counter weight must be ordered separately.

PRODUCT CODE	FINISH LP	B	W	SIZE/INCHES				WEIGHT LBS	VOL FT ³
				H (LP/B)	H (W)	W	D		
L2P1D20F	752	803	839	29	29.5	15.5	20	78	8
L2P1D24F	763	816	851	29	29.5	15.5	24	98	8
L2P1D30F	839	903	945	29	29.5	15.5	30	103	10
L2P1D36F	921	997	1047	29	29.5	15.5	36	110	11

L2PBBF-MIT • Mobile Box, Box, File Pedestal to fit under Worksurface



- One lock included.
- Optional e-lock available in the vertical position. Please specify V - Vertical and add \$224 list.
- Counter weight must be ordered separately.
- 18" deep mobile pedestal has a fifth caster at center bottom.

PRODUCT CODE	PRICE LP	SIZE/INCHES			WEIGHT LBS	VOL FT ³
		H	W	D		
L2PBBF18MIT	1187	28	15.5	18	99	8
L2PBBF23MIT	1254	28	15.5	23	105	8
L2PBBF29MIT	1316	28	15.5	29	110	10

L2PBBF-M • Mobile Box, Box, File Pedestal with Standard Top

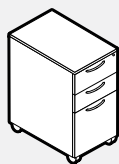

- One lock included.
- Optional e-lock available in the vertical position. Please specify V - Vertical and add \$224 list.
- Counter weight must be ordered separately.
- 20" deep mobile pedestal has a fifth caster at center bottom.

PRODUCT CODE	FINISH LP	B	W	SIZE / INCHES				WEIGHT		VOL FT ³
				H (LP/B)	H (W)	W	D	LBS	FT ³	
L2PBBF20M	1280	1287	1348	29	29.5	15.5	20	99	8	
L2PBBF24M	1299	1309	1366	29	29.5	15.5	24	99	8	
L2PBBF30M	1327	1356	1400	29	29.5	15.5	30	105	10	
L2PBBF36M	1381	1417	1458	29	29.5	15.5	36	110	11	

L2PFF-MIT • Mobile File, File Pedestal to fit under Worksurface



- One lock included.
- Optional e-lock available in the vertical position. Please specify V - Vertical and add \$224 list.
- Counter weight must be ordered separately.
- 18" deep mobile pedestal has a fifth caster at center bottom.

PRODUCT CODE	PRICE LP	SIZE / INCHES				WEIGHT		VOL FT ³
		H	W	D	LBS	FT ³		
L2PFF18MIT	1011	28	15.5	18	99	8		
L2PFF23MIT	1076	28	15.5	23	105	8		
L2PFF29MIT	1133	28	15.5	29	110	10		

L2PFF-M • Mobile File, File Pedestal with Standard Top

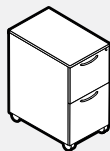

- One lock included.
- Optional e-lock available in the vertical position. Please specify V - Vertical and add \$224 list.
- Counter weight must be ordered separately.
- 20" deep mobile pedestal has a fifth caster at center bottom.

PRODUCT CODE	FINISH LP	B	W	SIZE / INCHES				WEIGHT		VOL FT ³
				H (LP/B)	H (W)	W	D	LBS	FT ³	
L2PFF20M	1084	1109	1141	29	29.5	15.5	20	99	8	
L2PFF24M	1099	1126	1162	29	29.5	15.5	24	99	8	
L2PFF30M	1139	1169	1230	29	29.5	15.5	30	105	10	
L2PFF36M	1198	1233	1280	29	29.5	15.5	36	110	11	

L2PBF-M • Mobile Box, File Pedestal with Standard Top

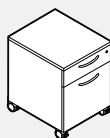

- One lock included.
- Optional e-lock available in the vertical position. Please specify V - Vertical and add \$224 list.
- Counter weight must be ordered separately.
- 20" deep mobile pedestal has a fifth caster at center bottom.

PRODUCT CODE	FINISH LP	B	W	SIZE / INCHES				WEIGHT		VOL FT ³
				H (LP/B)	H (W)	W	D	LBS	FT ³	
L2PBF20M	944	972	1026	22.69	23.15	15.5	20	78	7	
L2PBF24M	957	987	1038	22.69	23.15	15.5	24	80	7	
L2PBF30M	991	1025	1064	22.69	23.15	15.5	30	90	9	

L2PBF-MIT • Mobile Box, File Pedestal with Inset Top



- One lock included.
- Optional e-lock available in the vertical position. Please specify V - Vertical and add \$224 list.
- Counter weight must be ordered separately.
- 18" deep mobile pedestal has a fifth caster at center bottom.

PRODUCT CODE	PRICE LP	SIZE / INCHES				WEIGHT		VOL FT ³
		H	W	D	LBS	FT ³		
L2PBF18MIT	884	22	15.5	18	99	8		
L2PBF23MIT	941	22	15.5	23	99	8		
L2PBF24MIT	941	22	15.5	24	105	8		
L2PBF29MIT	994	22	15.5	29	105	8		
L2PBF30MIT	994	22	15.5	30	110	10		

L2PU • Printer Unit with 2 Pull Out Shelves

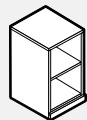

PRODUCT CODE	PRICE LP	SIZE / INCHES				WEIGHT		VOL FT ³
		H (LP/B)	W	D	LBS	FT ³		
L2PU18	904	28	22	18	83	8		
L2PU22	986	28	22	22	88	9		
L2PU24	1029	28	22	24	94	10		

L2L2H • Worksurface Supporting File, File Lateral for 18" deep and 22" deep units

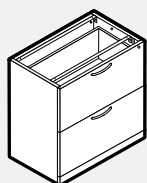

- One lock included.
- Optional e-lock available in the vertical position. Please specify V - Vertical and add \$224 list.

PRODUCT CODE	PRICE LP	SIZE / INCHES				WEIGHT		VOL FT ³
		H (LP/B)	W	D	LBS	FT ³		
L2L2H1830	1205	28	30	18	189	12		
L2L2H1836	1285	28	36	18	209	14		
L2L2H1842	1334	28	42	18	216	20		
L2L2H2230	1238	28	30	22	189	12		
L2L2H2236	1320	28	36	22	209	14		
L2L2H2242	1414	28	42	22	216	20		

L2L2D • Worksurface Supporting 2 Door Storage Lateral with 1 Adjustable Shelf

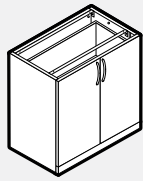

- One lock included.
- Optional e-lock available in the horizontal position. Please specify HR - Horizontal Right and add \$224 list.

PRODUCT CODE	PRICE LP	SIZE / INCHES			WEIGHT LBS	VOL FT ³
		H (LP/B)	W	D		
L2L2D1830	842	28	30	18	171	12
L2L2D1836	889	28	36	18	178	14
L2L2D1842	974	28	42	18	180	20
L2L2D2230	910	28	30	22	171	12
L2L2D2236	935	28	36	22	178	14
L2L2D2242	1077	28	42	22	180	20

L2L2AD • Worksurface Supporting 2 Aluminum Door Storage Lateral with 1 Adjustable Shelf

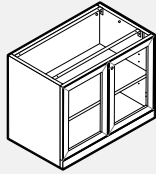

- One lock included.
- E-lock not available for aluminum framed glass doors.

PRODUCT CODE	PRICE LP	SIZE / INCHES			WEIGHT LBS	VOL FT ³
		H (LP/B)	W	D		
L2L2AD1830	1432	28	30	18	165	12
L2L2AD1836	1535	28	36	18	172	14
L2L2AD1842	1676	28	42	18	174	20
L2L2AD2230	1500	28	30	22	165	12
L2L2AD2236	1584	28	36	22	172	14
L2L2AD2242	1781	28	42	22	174	20

L2LCR • Worksurface Supporting Lateral File Combo

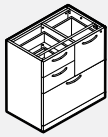

- One lock included.
- Optional e-lock available in the vertical position. Please specify V - Vertical and add \$224 list.

PRODUCT CODE	PRICE LP	SIZE / INCHES			WEIGHT LBS	VOL FT ³
		H (LP/B)	W	D		
L2LCR1830	1480	28	30	18	204	12
L2LCR1836	1727	28	36	18	215	14
L2LCR2230	1722	28	30	22	204	12
L2LCR2236	1808	28	36	22	215	14

L2LCL • Worksurface Supporting Lateral File Combo

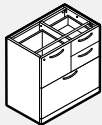

- One lock included.
- E-lock not available.

PRODUCT CODE	PRICE LP	SIZE / INCHES			WEIGHT LBS	VOL FT ³
		H (LP/B)	W	D		
L2LCL1830	1480	28	30	18	204	12
L2LCL1836	1727	28	36	18	215	14
L2LCL2230	1722	28	30	22	204	12
L2LCL2236	1808	28	36	22	215	14

L2LCR • Lateral File Combo with Top

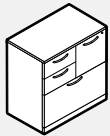

- One lock included.
- Optional e-lock available in the vertical position. Please specify V - Vertical and add \$224 list.

PRODUCT CODE	FINISH LP	B	W	SIZE / INCHES				WEIGHT LBS	VOL FT ³
				H (LP/B)	H (W)	W	D		
L2LCR2030	1827	1869	1916	29	29.5	30	20	204	12
L2LCR2036	1915	1940	2039	29	29.5	36	20	215	14
L2LCR2430	1900	1943	1995	29	29.5	30	24	204	12
L2LCR2436	1991	2020	2123	29	29.5	36	24	215	14

L2LCL • Lateral File Combo with Top

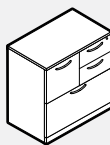

- One lock included.
- E-lock not available.

PRODUCT CODE	FINISH LP	B	W	SIZE / INCHES				WEIGHT LBS	VOL FT ³
				H (LP/B)	H (W)	W	D		
L2LCL2030	1827	1869	1916	29	29.5	30	20	204	12
L2LCL2036	1915	1940	2039	29	29.5	36	20	215	14
L2LCL2430	1900	1943	1995	29	29.5	30	24	204	12
L2LCL2436	1991	2020	2123	29	29.5	36	24	215	14

L2LO • Freestanding 1 High Open Unit

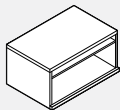

PRODUCT CODE	FINISH LP	B	W	SIZE / INCHES				WEIGHT LBS	VOL FT ³
				H (LP/B)	H (W)	W	D		
L2LO2030	651	740	803	19.94	20.4	30	20	75	11
L2LO2036	773	881	915	19.94	20.4	36	20	86	13
L2LO2430	677	769	837	19.94	20.4	30	24	75	11
L2LO2436	805	915	954	19.94	20.4	36	24	86	13

L2L2D-H20 • Freestanding 2 Doors, 1 High Unit

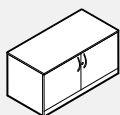

- One lock included.
- Includes one adjustable shelf.
- Optional e-lock available in the horizontal position. Please specify HR - Horizontal Right and add \$224 list.

PRODUCT CODE	FINISH LP	B	W	SIZE / INCHES				WEIGHT LBS	VOL FT ³
				H (LP/B)	H (W)	W	D		
L2L2D2030H20	894	972	1022	19.94	20.4	30	20	95	11
L2L2D2036H20	972	1067	1122	19.94	20.4	36	20	106	13
L2L2D2430H20	931	1011	1063	19.94	20.4	30	24	95	11
L2L2D2436H20	1011	1109	1166	19.94	20.4	36	24	106	13

L2L2AD • Freestanding 2 Aluminum Doors, 1 High

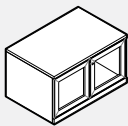

- One lock included.
- Includes one adjustable shelf.
- E-lock not available for aluminum framed glass doors.

PRODUCT CODE	FINISH LP	B	W	SIZE / INCHES				D	WEIGHT LBS	VOL FT³
				H(LP/B)	H(W)	W	D			
L2L2AD2030H20	1370	1448	1497	19.5	20	30	20	86	10	
L2L2AD2036H20	1488	1582	1637	19.5	20	36	20	96	12	
L2L2AD2430H20	1406	1485	1539	19.5	20	30	24	86	10	
L2L2AD2436H20	1527	1623	1682	19.5	20	36	24	96	12	

L2L2D • Freestanding 2 Doors, 2 High Unit

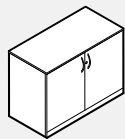

- One lock included.
- Includes one adjustable shelf.
- Optional e-lock available in the horizontal position. Please specify HR - Horizontal Right and add \$224 list.

PRODUCT CODE	FINISH LP	B	W	SIZE / INCHES				D	WEIGHT LBS	VOL FT³
				H(LP/B)	H(W)	W	D			
L2L2D2030	987	1096	1124	29	29.5	30	20	171	12	
L2L2D2036	1088	1181	1236	29	29.5	36	20	178	14	
L2L2D2042	1220	1327	1388	29	29.5	42	20	208	20	
L2L2D2430	1025	1140	1169	29	29.5	30	24	171	12	
L2L2D2436	1133	1229	1287	29	29.5	36	24	178	14	
L2L2D2442	1264	1378	1444	29	29.5	42	24	208	20	

L2L2AD • Freestanding 2 Aluminum Doors, 2 High Unit

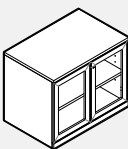

- One lock included.
- Includes one adjustable shelf.
- E-lock not available for aluminum framed glass doors.

PRODUCT CODE	FINISH LP	B	W	SIZE / INCHES				D	WEIGHT LBS	VOL FT³
				H(LP/B)	H(W)	W	D			
L2L2AD2030	1579	1687	1717	29	29.5	30	20	165	12	
L2L2AD2036	1734	1830	1884	29	29.5	36	20	172	14	
L2L2AD2042	1920	2028	2090	29	29.5	42	20	174	20	
L2L2AD2430	1617	1730	1759	29	29.5	30	24	165	12	
L2L2AD2436	1779	1877	1933	29	29.5	36	24	172	14	
L2L2AD2442	1967	2082	2147	29	29.5	42	24	174	20	

L2L1H • Freestanding 1 High Lateral

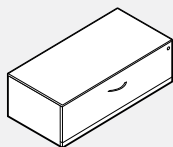

- One lock included.
- Optional e-lock available in the vertical position. Please specify V - Vertical and add \$224 list.

PRODUCT CODE	FINISH LP	B	W	SIZE / INCHES				D	WEIGHT LBS	VOL FT³
				H(LP/B)	H(W)	W	D			
L2L1H2030	890	938	971	19.94	20.4	30	20	105	11	
L2L1H2036	949	1008	1062	19.94	20.4	36	20	114	13	
L2L1H2042	1029	1095	1158	19.94	20.4	42	20	133	15	
L2L1H2430	926	974	1010	19.94	20.4	30	24	105	11	
L2L1H2436	991	1051	1104	19.94	20.4	36	24	114	13	
L2L1H2442	1069	1137	1200	19.94	20.4	42	24	133	15	

L2LBFH20 • Freestanding Box File Lateral

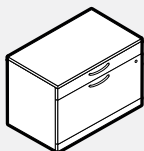

- One lock included.
- Optional e-lock available in the vertical position. Please specify V - Vertical and add \$224 list.

PRODUCT CODE	FINISH LP	B	W	SIZE / INCHES				D	WEIGHT LBS	VOL FT³
				H(LP/B)	H(W)	W	D			
L2LBF2030H20	1201	1233	1298	19.94	20	30	20	108	11	
L2LBF2036H20	1293	1330	1405	19.94	20	36	20	117	13	
L2LBF2042H20	1377	1419	1504	19.94	20	42	20	136	15	
L2LBF2430H20	1245	1277	1342	19.94	20	30	24	108	11	
L2LBF2436H20	1337	1374	1449	19.94	20	36	24	117	13	
L2LBF2442H20	1421	1463	1548	19.94	20	42	24	136	15	

L2L2H • Freestanding 2 High Lateral

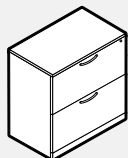

- One lock included.
- Optional e-lock available in the vertical position. Please specify V - Vertical and add \$224 list.

PRODUCT CODE	FINISH LP	B	W	SIZE / INCHES				D	WEIGHT LBS	VOL FT³
				H(LP/B)	H(W)	W	D			
L2L2H2030	1348	1393	1442	29	29.5	30	20	189	12	
L2L2H2036	1441	1496	1552	29	29.5	36	20	209	14	
L2L2H2042	1549	1616	1669	29	29.5	42	20	242	20	
L2L2H2430	1400	1448	1502	29	29.5	30	24	189	12	
L2L2H2436	1497	1557	1612	29	29.5	36	24	209	14	
L2L2H2442	1610	1680	1736	29	29.5	42	24	242	20	

L2L3H • Freestanding 3 High Lateral



- One lock included.
- Optional e-lock available in the vertical position. Please specify V - Vertical and add \$224 list.

PRODUCT CODE	FINISH LP	B	W	SIZE / INCHES				D	WEIGHT LBS	VOL FT³
				H(LP/B)	H(W)	W	D			
L2L3H2030	1838	1884	1935	41.75	42.18	30	20	252	18	
L2L3H2036	1980	2034	2047	41.75	42.18	36	20	264	21	
L2L3H2430	1913	1960	2012	41.75	42.18	30	24	252	18	
L2L3H2436	2059	2118	2130	41.75	42.18	36	24	264	21	

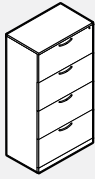
L2L4H • Freestanding 4 High Lateral

- One lock included.
- Optional e-lock available in the vertical position. Please specify V - Vertical and add \$224 list.

PRODUCT CODE	FINISH		SIZE/INCHES				WEIGHT LBS	VOL FT ³
	LP	W	H(LP/B)	H(W)	W	D		
L2L4H2030	2377	2476	54.5	54.94	30	20	315	23
L2L4H2036	2496	2641	54.5	54.94	36	20	336	28
L2L4H2430	2471	2574	54.5	54.94	30	24	315	23
L2L4H2436	2595	2745	54.5	54.94	36	24	336	28

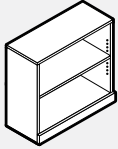
L2B2H • Bookcase 1 Adjustable Shelf

- Shipped knocked down (KD).

PRODUCT CODE	FINISH			SIZE/INCHES				WEIGHT LBS	VOL FT ³
	LP	B	W	H(LP/B)	H(W)	W	D		
L2B2H3012	526	575	619	29	29.5	30	12	95	8
L2B2H3612	611	669	727	29	29.5	36	12	106	9
L2B2H30	626	699	769	29	29.5	30	17	95	11
L2B2H36	725	781	839	29	29.5	36	17	106	13

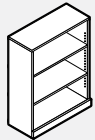
L2B3H • Bookcase 2 Adjustable Shelves

- Shipped knocked down (KD).

PRODUCT CODE	FINISH			SIZE/INCHES				WEIGHT LBS	VOL FT ³
	LP	B	W	H(LP/B)	H(W)	W	D		
L2B3H3012	673	722	752	41.75	42.18	30	12	160	9
L2B3H3612	739	811	849	41.75	42.18	36	12	171	12
L2B3H30	838	908	967	41.75	42.18	30	17	160	15
L2B3H36	944	1026	1084	41.75	42.18	36	17	171	18

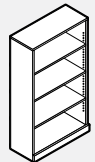
L2B4H • Bookcase 3 Adjustable Shelves

- Shipped knocked down (KD).

PRODUCT CODE	FINISH		SIZE/INCHES				WEIGHT LBS	VOL FT ³
	LP	W	H(LP/B)	H(W)	W	D		
L2B4H3012	803	915	54.5	54.94	30	12	178	13
L2B4H3612	902	1031	54.5	54.94	36	12	189	15
L2B4H30	1024	1140	54.5	54.94	30	17	178	19
L2B4H36	1119	1227	54.5	54.94	36	17	189	22

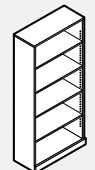
L2B5H • Bookcase 4 Adjustable Shelves

- Shipped knocked down (KD).

PRODUCT CODE	FINISH		SIZE/INCHES				WEIGHT LBS	VOL FT ³
	LP	W	H(LP/B)	H(W)	W	D		
L2B5H3012	969	1032	65.81	66.25	30	12	193	15
L2B5H3612	1057	1189	65.81	66.25	36	12	204	19
L2B5H30	1147	1239	65.81	66.25	30	17	193	23
L2B5H36	1285	1421	65.81	66.25	36	17	204	28

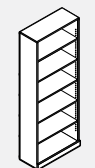
L2B6H • Bookcase 5 Adjustable Shelves

- Shipped knocked down (KD).

PRODUCT CODE	FINISH		SIZE/INCHES				WEIGHT LBS	VOL FT ³
	LP	W	H(LP/B)	H(W)	W	D		
L2B6H3012	1043	1154	72.81	73.24	30	12	237	17
L2B6H3612	1169	1300	72.81	73.24	36	12	248	20
L2B6H30	1175	1297	72.81	73.24	30	17	242	25
L2B6H36	1406	1608	72.81	73.24	36	17	253	30

L2BC • Corner Bookcase 20”D x 20”W /24”D x 24”W

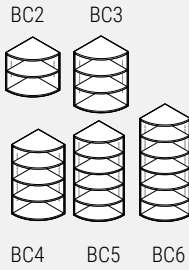

- Shipped knocked down (KD).

PRODUCT CODE	FINISH LP	FINISH B	FINISH W	SIZE/INCHES				WEIGHT LBS	VOL FT³
				H(LP/B)	H(W)	W	D		
L2BC2H20	847	994	1031	29.00	29.50	20	20	90	11
L2BC2H24	882	1034	1070	29.00	29.50	24	24	90	11
L2BC3H20	1074	1222	1261	41.75	42.18	20	20	125	15
L2BC3H24	1118	1266	1312	41.75	42.18	24	24	125	15
L2BC4H20	1301	-	1494	54.50	54.94	20	20	158	20
L2BC4H24	1354	-	1554	54.50	54.94	24	24	158	20
L2BC5H20	1529	-	1725	65.81	66.25	20	20	188	24
L2BC5H24	1591	-	1794	65.81	66.25	24	24	188	24
L2BC6H20	1720	-	1927	72.81	73.24	20	20	218	26
L2BC6H24	1788	-	2002	72.81	73.24	24	24	218	26

L2TW2D-D • Storage Tower with 2 Doors and 4 Adjustable Shelves

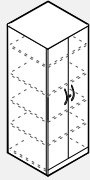

- 50” High Tower comes with 3 adjustable shelves.
- One lock on right door included.
- Optional e-lock available in the horizontal position. Please specify HR - Horizontal Right and add \$224 list.

PRODUCT CODE	FINISH LP	FINISH W	FINISH D	SIZE/INCHES				WEIGHT LBS	VOL FT³
				H(LP/B)	H(W)	W	D		
L2TW2D50H20D	1480	1586	20	49.56	50.00	24	20	211	22
L2TW2D66H20D	1635	1782	20	65.81	66.25	24	20	268	24
L2TW2D72H20D	1706	1847	20	72.81	73.24	24	20	283	26
L2TW2D50H24D	1535	1648	24	49.56	50.00	24	24	211	22
L2TW2D66H24D	1697	1850	24	65.81	66.25	24	24	268	24
L2TW2D72H24D	1773	1916	24	72.81	73.24	24	24	283	26

L2TW2DCS-D • Storage Tower with 2 Doors, Coat Rod and Hat Shelf

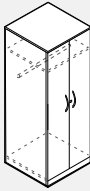

- 50” High Tower comes with one shelf.
- One lock on right door included.
- Optional e-lock available in the horizontal position. Please specify HR - Horizontal Right and add \$224 list.

PRODUCT CODE	FINISH LP	FINISH W	FINISH D	SIZE/INCHES				WEIGHT LBS	VOL FT³
				H(LP/B)	H(W)	W	D		
L2TW2DCS50H20D	1322	1475	20	49.56	50.00	24	20	178	22
L2TW2DCS66H20D	1496	1606	20	65.81	66.25	24	20	268	24
L2TW2DCS72H20D	1560	1670	20	72.81	73.24	24	20	284	26
L2TW2DCS50H24D	1374	1531	24	49.56	50.00	24	24	178	22
L2TW2DCS66H24D	1555	1668	24	65.81	66.25	24	24	268	24
L2TW2DCS72H24D	1621	1733	24	72.81	73.24	24	24	284	26

L2TW2H2D-D • Storage Tower with a 3 High Cupboard over a 2 High Lateral

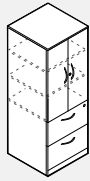

- 50” High Tower comes with one adjustable shelf.
- Two locks included.
- Optional e-lock available in the vertical position for the file drawers. Please specify V - Vertical and add \$224 list.
- Optional e-lock available in the horizontal position for the upper storage cabinet. Please specify HR- Horizontal Right and add \$224 list.

PRODUCT CODE	FINISH LP	FINISH W	FINISH D	SIZE/INCHES				WEIGHT LBS	VOL FT³
				H(LP/B)	H(W)	W	D		
L2TW2H2D50H20D	2001	2043	20	49.56	50.00	24	20	222	22
L2TW2H2D66H20D	2223	2259	20	65.81	66.25	24	20	279	24
L2TW2H2D72H20D	2287	2448	20	72.81	73.24	24	20	295	26
L2TW2H2D50H24D	2083	2126	24	49.56	50.00	24	24	222	22
L2TW2H2D66H24D	2314	2349	24	65.81	66.25	24	24	279	24
L2TW2H2D72H24D	2379	2543	24	72.81	73.24	24	24	295	26

L2TW3H2D-D • Storage Tower with a 2 High Cupboard over a 3 High Lateral

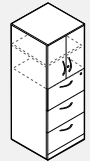

- Two locks included.
- Optional e-lock available in the vertical position for the file drawers. Please specify V - Vertical and add \$224 list.
- Optional e-lock available in the horizontal position for the upper storage cabinet. Please specify HR- Horizontal Right and add \$224 list.

PRODUCT CODE	FINISH LP	FINISH W	FINISH D	SIZE/INCHES				WEIGHT LBS	VOL FT³
				H(LP/B)	H(W)	W	D		
L2TW3H2D66H20D	2452	2558	20	65.81	66.25	24	20	296	24
L2TW3H2D72H20D	2526	2603	20	72.81	73.24	24	20	311	26
L2TW3H2D66H24D	2550	2660	24	65.81	66.25	24	24	296	24
L2TW3H2D72H24D	2625	2708	24	72.81	73.24	24	24	311	26

L2TW4H2D-D • Tower with a 2 Door Storage Cabinet over a 4 High Lateral

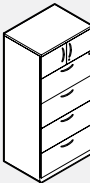

- Two locks included.
- Lock on cupboard is not available for UB, UC or RN handles.
- Optional e-lock available in the vertical position for the file drawers. Please specify V - Vertical and add \$224 list.
- Optional e-lock available in the horizontal position for the upper storage cabinet. Please specify HR- Horizontal Right and add \$224 list.

PRODUCT CODE	FINISH LP	FINISH W	FINISH D	SIZE/INCHES				WEIGHT LBS	VOL FT³
				H(LP/B)	H(W)	W	D		
L2TW4H2D66H20D	2784	2894	20	65.81	66.25	24	20	307	24
L2TW4H2D72H20D	2872	2908	20	72.81	73.24	24	20	322	26
L2TW4H2D66H24D	2895	3011	24	65.81	66.25	24	24	307	24
L2TW4H2D72H24D	2989	3023	24	72.81	73.24	24	24	322	26

L2TWBBF2DL • Storage Tower with a 3 High Cupboard, BBF Drawers and Wardrobe

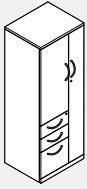

Right Hand Shown

- Storage compartment includes 1 adjustable shelves for 50”h. unit and 2 adjustable shelves for 66”h. and 72”h. units
- Two locks included.
- Optional e-lock available in the vertical position for the box, box, file drawers. Please specify V - Vertical and add \$224 list.
- Optional e-lock available in the horizontal position for the wardrobe. Please specify HR - Horizontal Right or HL - Horizontal Left and add \$224 list.

PRODUCT CODE	FINISH		SIZE / INCHES				WEIGHT LBS	VOL FT ³
	LP	W	H (LP/B)	H (W)	W	D		
Left								
L2TWBBF2DL50H20D	2047	2199	49.56	50.00	24	20	288	20
L2TWBBF2DL66H20D	2280	2385	65.81	66.25	24	20	348	22
L2TWBBF2DL72H20D	2363	2467	72.81	73.25	24	20	378	24
L2TWBBF2DL50H24D	2129	2286	49.5	50.00	24	24	288	20
L2TWBBF2DL66H24D	2369	2481	65.81	66.25	24	24	348	22
L2TWBBF2DL72H24D	2455	2567	72.81	73.25	24	24	378	24
Right								
L2TWBBF2DR50H20D	2047	2199	49.56	50.00	24	20	288	20
L2TWBBF2DR66H20D	2280	2385	65.81	66.25	24	20	348	22
L2TWBBF2DR72H20D	2363	2467	72.81	73.25	24	20	378	24
L2TWBBF2DR50H24D	2129	2286	49.5	50.00	24	24	288	20
L2TWBBF2DR66H24D	2369	2481	65.81	66.25	24	24	348	22
L2TWBBF2DR72H24D	2455	2567	72.81	73.25	24	24	378	24

L2TW2F2D-D • Storage Tower with a 3 High Cupboard, FF Drawers and Wardrobe

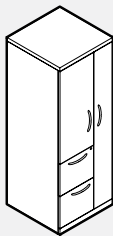

Right Hand Shown

- Wardrobe has a coat rod.
- Two locks included.
- Optional e-lock available in the vertical position for the file drawers. Please specify V - Vertical and add \$224 list.
- Optional e-lock available in the horizontal position for the wardrobe. Please specify HR - Horizontal Right or HL - Horizontal Left and add \$224 list.

PRODUCT CODE	FINISH		SIZE / INCHES				WEIGHT LBS	VOL FT ³
	LP	W	H (LP/B)	H (W)	W	D		
Left								
L2TW2F2DL50H20D	1925	2079	49.56	50.00	24	20	222	22
L2TW2F2DL66H20D	2156	2261	65.81	66.25	24	20	279	24
L2TW2F2DL72H20D	2239	2345	72.81	73.24	24	20	295	26
L2TW2F2DL50H24D	2001	2158	49.56	50.00	24	24	222	22
L2TW2F2DL66H24D	2245	2351	65.81	66.25	24	24	279	24
L2TW2F2DL72H24D	2331	2438	72.81	73.24	24	24	295	26
Right								
L2TW2F2DR50H20D	1925	2079	49.56	50.00	24	20	222	22
L2TW2F2DR66H20D	2156	2261	65.81	66.25	24	20	279	24
L2TW2F2DR72H20D	2239	2345	72.81	73.24	24	20	295	26
L2TW2F2DR50H24D	2001	2158	49.56	50.00	24	24	222	22
L2TW2F2DR66H24D	2245	2351	65.81	66.25	24	24	279	24
L2TW2F2DR72H24D	2331	2438	72.81	73.24	24	24	295	26

L2TW3F2D-D • Storage Tower with a 2 High Cupboard, FFF Drawers and Wardrobe

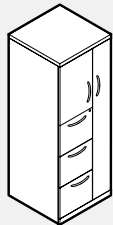

Right Hand Shown

- Two locks included.
- Optional e-lock available in the vertical position for the file drawers. Please specify V - Vertical and add \$224 list.
- Optional e-lock available in the horizontal position for the wardrobe. Please specify HR - Horizontal Right or HL - Horizontal Left and add \$224 list.

PRODUCT CODE	FINISH		SIZE / INCHES				WEIGHT LBS	VOL FT ³
	LP	W	H (LP/B)	H (W)	W	D		
Left								
L2TW3F2DL66H20D	2281	2394	65.81	66.25	24	20	296	24
L2TW3F2DL72H20D	2364	2453	72.81	73.24	24	20	311	26
L2TW3F2DL66H24D	2372	2489	65.81	66.25	24	24	296	24
L2TW3F2DL72H24D	2460	2552	72.81	73.24	24	24	311	26
Right								
L2TW3F2DR66H20D	2281	2394	65.81	66.25	24	20	296	24
L2TW3F2DR72H20D	2364	2453	72.81	73.24	24	20	311	26
L2TW3F2DR66H24D	2372	2489	65.81	66.25	24	24	296	24
L2TW3F2DR72H24D	2460	2552	72.81	73.24	24	24	311	26

L2TWBBFDO • Storage Tower with 3 High Side Open Cupboard, BBF Drawers and Wardrobe

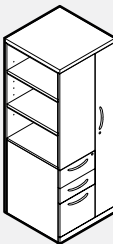

Right Hand Shown

- Open bookcase compartment includes 1 adjustable shelves for 50”h unit and 2 adjustable shelves for 66”h and 72”h units
- Two locks included.
- Optional e-lock available in the vertical position for the box, box, file drawers. Please specify V - Vertical and add \$224 list.
- Optional e-lock available in the horizontal position for the wardrobe. Please specify HR - Horizontal Right or HL - Horizontal Left and add \$224 list.

PRODUCT CODE	FINISH		SIZE / INCHES				WEIGHT LBS	VOL FT ³
	LP	W	H (LP/B)	H (W)	W	D		
Left								
L2TWBBFDOL50H20D	1903	2024	49.50	50.00	24	20	285	20
L2TWBBFDOL66H20D	2107	2175	65.81	66.25	24	20	345	22
L2TWBBFDOL72H20D	2177	2242	72.81	73.25	24	20	375	24
L2TWBBFDOL50H24D	1981	2103	49.50	50.00	24	24	285	20
L2TWBBFDOL66H24D	2191	2262	65.81	66.25	24	24	345	22
L2TWBBFDOL72H24D	2263	2331	72.81	73.25	24	24	375	24
Right								
L2TWBBFDOR50H20D	1903	2024	49.50	50.00	24	20	285	20
L2TWBBFDOR66H20D	2107	2175	65.81	66.25	24	20	345	22
L2TWBBFDOR72H20D	2177	2242	72.81	73.25	24	20	375	24
L2TWBBFDOR50H24D	1981	2103	49.50	50.00	24	24	285	20
L2TWBBFDOR66H24D	2191	2262	65.81	66.25	24	24	345	22
L2TWBBFDOR72H24D	2263	2331	72.81	73.25	24	24	375	24

L2TW2FDO-D • Storage Tower with a 3 High Side Open Cupboard, FF Drawers and Wardrobe

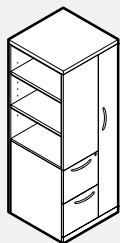

Right Hand Shown

- 50" High Tower comes with one adjustable shelf.
- Two locks included.
- Optional e-lock available in the vertical position for the file drawers. Please specify V - Vertical and add \$224 list.
- Optional e-lock available in the horizontal position for the wardrobe. Please specify HR - Horizontal Right or HL - Horizontal Left and add \$224 list.

PRODUCT CODE	FINISH		SIZE/INCHES				WEIGHT LBS	VOL FT ³
	LP	W	H(LP/B)	H(W)	W	D		
Left								
L2TW2FDOL50H20D	1782	1900	49.56	50.00	24	20	211	22
L2TW2FDOL66H20D	1983	2053	65.81	66.25	24	20	268	24
L2TW2FDOL72H20D	2054	2118	72.81	73.24	24	20	284	26
L2TW2FDOL50H24D	1851	1975	49.56	50.00	24	24	211	22
L2TW2FDOL66H24D	2063	2133	65.81	66.25	24	24	268	24
L2TW2FDOL72H24D	2134	2202	72.81	73.24	24	24	284	26
Right								
L2TW2FDOR50H20D	1782	1900	49.56	50.00	24	20	211	22
L2TW2FDOR66H20D	1983	2053	65.81	66.25	24	20	268	24
L2TW2FDOR72H20D	2054	2118	72.81	73.24	24	20	284	26
L2TW2FDOR50H24D	1851	1975	49.56	50.00	24	24	211	22
L2TW2FDOR66H24D	2063	2133	65.81	66.25	24	24	268	24
L2TW2FDOR72H24D	2134	2202	72.81	73.24	24	24	284	26

L2TW3FDO-D • Storage Tower with a 2 High Side Open Cupboard, FFF Drawers and Wardrobe

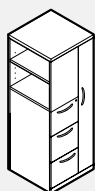

Right Hand Shown

- Two locks included.
- Optional e-lock available in the vertical position for the file drawers. Please specify V - Vertical and add \$224 list.
- Optional e-lock available in the horizontal position for the wardrobe. Please specify HR - Horizontal Right or HL - Horizontal Left and add \$224 list.

PRODUCT CODE	FINISH		SIZE/INCHES				WEIGHT LBS	VOL FT ³
	LP	W	H(LP/B)	H(W)	W	D		
Left								
L2TW3FDOL66H20D	2143	2248	65.81	66.25	24	20	285	24
L2TW3FDOL72H20D	2277	2292	72.81	73.24	24	20	300	26
L2TW3FDOL66H24D	2225	2335	65.81	66.25	24	24	285	24
L2TW3FDOL72H24D	2365	2383	72.81	73.24	24	24	300	26
Right								
L2TW3FDOR66H20D	2143	2248	65.81	66.25	24	20	285	24
L2TW3FDOR72H20D	2277	2292	72.81	73.24	24	20	300	26
L2TW3FDOR66H24D	2225	2335	65.81	66.25	24	24	285	24
L2TW3FDOR72H24D	2365	2383	72.81	73.24	24	24	300	26

L2TWA2DCS • Storage Tower with 2 Aluminum Doors, Coat Rod and Hat Shelf

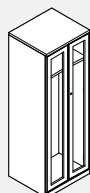

- 50" High Tower comes with 1 shelf above hang rod.
- One lock included.
- E-locks not available for aluminum framed glass doors.

PRODUCT CODE	FINISH		SIZE/INCHES				WEIGHT LBS	VOL FT ³
	LP	W	H(LP/B)	H(W)	W	D		
L2TWA2DCS50H20D	2136	2290	49.56	50.00	24	20	162	20
L2TWA2DCS66H20D	2490	2602	65.81	66.25	24	20	244	22
L2TWA2DCS72H20D	2624	2734	72.81	73.25	24	20	258	24
L2TWA2DCS50H24D	2190	2345	49.56	50.00	24	24	162	20
L2TWA2DCS66H24D	2550	2664	65.81	66.25	24	24	244	22
L2TWA2DCS72H24D	2684	2797	72.81	73.25	24	24	258	24

L2TWA2D • Storage Tower with 2 Aluminum Doors and 4 Adjustable Shelves

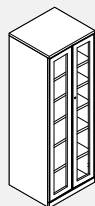

- 50" High Tower comes with 3 adjustable shelves.
- One lock included.
- E-locks not available for aluminum framed glass doors.

PRODUCT CODE	FINISH		SIZE/INCHES				WEIGHT LBS	VOL FT ³
	LP	W	H(LP/B)	H(W)	W	D		
L2TWA2D50H20D	2294	2400	49.56	50.00	24	20	192	20
L2TWA2D66H20D	2631	2779	65.81	66.25	24	20	244	22
L2TWA2D72H20D	2769	2910	72.81	73.25	24	20	257	24
L2TWA2D50H24D	2349	2462	49.56	50.00	24	24	192	20
L2TWA2D66H24D	2695	2847	65.81	66.25	24	24	244	22
L2TWA2D72H24D	2835	2981	72.81	73.25	24	24	257	24

L2TWA2H2D • Storage Tower with a 3 High Cupboard over a 2 High Lateral

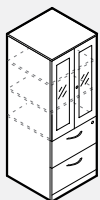

- 50" High Tower comes with 1 adjustable shelf.
- Lock is on the upper drawer.
- Two locks included.
- Optional e-lock available in the vertical position. Please specify V - Vertical and add \$224 list.
- E-locks not available for aluminum framed glass doors.

PRODUCT CODE	FINISH		SIZE/INCHES				WEIGHT LBS	VOL FT ³
	LP	W	H(LP/B)	H(W)	W	D		
L2TWA2H2D50H20D	2499	2543	49.56	50.00	24	20	202	20
L2TWA2H2D66H20D	2902	2938	65.81	66.25	24	20	254	22
L2TWA2H2D72H20D	3036	3192	72.81	73.25	24	20	258	24
L2TWA2H2D50H24D	2582	2625	49.56	50.00	24	24	202	20
L2TWA2H2D66H24D	2992	3031	65.81	66.25	24	24	254	22
L2TWA2H2D72H24D	3127	3289	72.81	73.25	24	24	258	24

L2TWA3H2D • Storage Tower with a 2 High Cupboard with Aluminum Doors over a 3 High Lateral

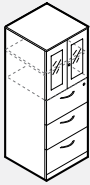

- Lock is on the upper drawer.
- Two locks included.
- Optional e-lock available in the vertical position. Please specify V - Vertical and add \$224 list.
- E-locks not available for aluminum framed glass doors.

PRODUCT CODE	FINISH		SIZE/INCHES				WEIGHT		VOL FT ³
	LP	W	H (LP/B)	H (W)	W	D	LBS		
L2TWA3H2D66H20D	2988	3097	65.81	66.25	24	20	269	22	
L2TWA3H2D72H20D	3128	3208	72.81	73.25	24	20	283	24	
L2TWA3H2D66H24D	3086	3196	65.81	66.25	24	24	269	22	
L2TWA3H2D72H24D	3229	3313	72.81	73.25	24	24	283	24	

L2TWA4H2D • Storage Tower with Cupboard with Aluminum Doors over a 4 High Lateral

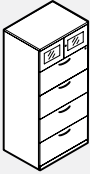

- Lock is on the upper drawer.
- Two locks included.
- Optional e-lock available in the vertical position. Please specify V - Vertical and add \$224 list.
- E-locks not available for aluminum framed glass doors.

PRODUCT CODE	FINISH		SIZE/INCHES				WEIGHT		VOL FT ³
	LP	W	H (LP/B)	H (W)	W	D	LBS		
L2TWA4H2D66H20D	3123	3231	65.81	66.25	24	20	279	22	
L2TWA4H2D72H20D	3289	3324	72.81	73.25	24	20	293	24	
L2TWA4H2D66H24D	3232	3347	65.81	66.25	24	24	293	22	
L2TWA4H2D72H24D	3406	3442	72.81	73.25	24	24	293	24	

L2TWA2F2D • Storage Tower with a 3 High Cupboard, FF Drawers and Wardrobe

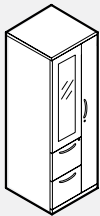

Right Hand Shown

- Storage compartment includes 1 adjustable shelves for 50" h unit and 2 adjustable shelves for 66" h and 72" h units
- Two locks included.
- Optional e-lock available in the vertical position for the file drawers. Please specify V - Vertical and add \$224 list.
- Optional e-lock available in the horizontal position for the wardrobe. Please specify HR - Horizontal Right or HL - Horizontal Left and add \$224 list.
- E-locks not available for aluminum framed glass doors.

PRODUCT CODE	FINISH		SIZE/INCHES				WEIGHT		VOL FT ³
	LP	W	H (LP/B)	H (W)	W	D	LBS		
L2TWA2F2DR50H20D	2177	2330	49.56	50.00	24	20	219	20	
L2TWA2F2DR66H20D	2516	2620	65.81	66.25	24	20	276	22	
L2TWA2F2DR72H20D	2640	2745	72.81	73.25	24	20	292	24	
L2TWA2F2DR50H24D	2254	2410	49.56	50.00	24	24	219	20	
L2TWA2F2DR66H24D	2603	2710	65.81	66.25	24	24	276	22	
L2TWA2F2DR72H24D	2729	2839	72.81	73.25	24	24	292	24	
L2TWA2F2DL50H20D	2177	2330	49.56	50.00	24	20	219	20	
L2TWA2F2DL66H20D	2516	2620	65.81	66.25	24	20	276	22	
L2TWA2F2DL72H20D	2640	2745	72.81	73.25	24	20	292	24	
L2TWA2F2DL50H24D	2254	2410	49.56	50.00	24	24	219	20	
L2TWA2F2DL66H24D	2603	2710	65.81	66.25	24	24	276	22	
L2TWA2F2DL72H24D	2729	2839	72.81	73.25	24	24	292	24	

L2TWABBF2D • Storage Tower with a 3 High Cupboard, BBF Drawers and Wardrobe

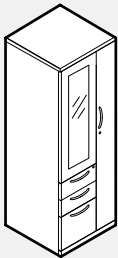

Right Hand Shown

- Storage compartment includes 1 adjustable shelves for 50" h unit and 2 adjustable shelves for 66" h and 72" h units
- Two locks included.
- Optional e-lock available in the vertical position for the box, box, file drawers. Please specify V - Vertical and add \$224 list.
- Optional e-lock available in the horizontal position for the wardrobe. Please specify HR - Horizontal Right or HL - Horizontal Left and add \$224 list.
- E-locks not available for aluminum framed glass doors.

PRODUCT CODE	FINISH		SIZE/INCHES				WEIGHT		VOL FT ³
	LP	W	H (LP/B)	H (W)	W	D	LBS		
L2TWABBF2DL50H20D	2300	2452	49.56	50.00	24	20	288	20	
L2TWABBF2DL66H20D	2640	2743	65.81	66.25	24	20	348	22	
L2TWABBF2DL72H20D	2761	2868	72.81	73.25	24	20	378	24	
L2TWABBF2DL50H24D	2376	2534	49.56	50.00	24	24	288	20	
L2TWABBF2DL66H24D	2727	2834	65.81	66.25	24	24	348	22	
L2TWABBF2DL72H24D	2851	2960	72.81	73.25	24	24	378	24	
L2TWABBF2DR50H20D	2300	2452	49.56	50.00	24	20	288	20	
L2TWABBF2DR66H20D	2640	2743	65.81	66.25	24	20	348	22	
L2TWABBF2DR72H20D	2761	2868	72.81	73.25	24	20	378	24	
L2TWABBF2DR50H24D	2376	2534	49.56	50.00	24	24	288	20	
L2TWABBF2DR66H24D	2727	2834	65.81	66.25	24	24	348	22	
L2TWABBF2DR72H24D	2851	2960	72.81	73.25	24	24	378	24	

L2TW3F2D-D • Storage Tower with a 2 High Cupboard, FFF Drawers and Wardrobe

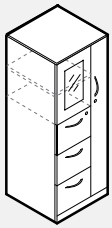

- Lock is on the upper drawer.
- Storage compartment includes 1 adjustable shelf.
- Two locks included.
- Optional e-lock available in the vertical position for the file drawers. Please specify V - Vertical and add \$224 list.
- Optional e-lock available in the horizontal position for the wardrobe. Please specify HR - Horizontal Right or HL - Horizontal Left and add \$224 list.
- E-locks not available for aluminum framed glass doors.

PRODUCT CODE	FINISH		SIZE/INCHES				WEIGHT		VOL FT ³
	LP	W	H (LP/B)	H (W)	W	D	LBS		
L2TWA3F2DR66H20D	2577	2692	65.81	66.25	24	20	340	22	
L2TWA3F2DR72H20D	2697	2786	72.81	73.25	24	20	370	24	
L2TWA3F2DR66H24D	2670	2786	65.81	66.25	24	24	340	22	
L2TWA3F2DR72H24D	2792	2886	72.81	73.25	24	24	370	24	
L2TWA3F2DL66H20D	2577	2692	65.81	66.25	24	20	340	22	
L2TWA3F2DL72H20D	2697	2786	72.81	73.25	24	20	370	24	
L2TWA3F2DL66H24D	2670	2786	65.81	66.25	24	24	340	22	
L2TWA3F2DL72H24D	2792	2886	72.81	73.25	24	24	370	24	

L2CB • Storage Cabinet with 2 Doors and 4 Adjustable Shelves

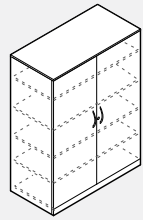

- 50"h. cabinet comes with 3 adjustable shelves.
- 66"h. and 72"h. Cabinet comes with 4 adjustable shelves.
- One lock included.
- Optional e-lock available in the horizontal position. Please specify HR - Horizontal Right and add \$224 list.

PRODUCT CODE	FINISH		SIZE/INCHES				WEIGHT		VOL FT ³
	LP	W	H (LP/B)	H (W)	W	D	LBS		
L2CB20302D50H	1684	1821	49.56	50.00	30	20	245	21	
L2CB20362D50H	1803	1964	49.56	50.00	36	20	281	25	
L2CB20302D66H	1913	2047	65.81	66.25	30	20	310	28	
L2CB20362D66H	2056	2213	65.81	66.25	36	20	354	33	
L2CB20302D72H	1988	2120	72.81	73.24	30	20	327	30	
L2CB20362D72H	2133	2287	72.81	73.24	36	20	372	36	
L2CB24302D50H	1751	1896	49.56	50.00	30	24	245	25	
L2CB24362D50H	1874	2041	49.56	50.00	36	24	281	30	
L2CB24302D66H	1990	2130	65.81	66.25	30	24	310	33	
L2CB24362D66H	2138	2301	65.81	66.25	36	24	354	39	
L2CB24302D72H	2067	2206	72.81	73.24	30	24	327	36	
L2CB24362D72H	2220	2379	72.81	73.24	36	24	372	43	

L2CB • Storage Cabinet with 2 Doors Coat Rod and 1 Fixed Shelf

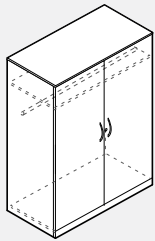

- One lock included.
- Optional e-lock available in the horizontal position. Please specify HR - Horizontal Right and add \$224 list.

PRODUCT CODE	FINISH		SIZE/INCHES				WEIGHT		VOL FT ³
	LP	W	H (LP/B)	H (W)	W	D	LBS		
L2CB20302DCS50H	1540	1668	49.56	50.00	30	20	204	21	
L2CB20362DCS50H	1625	1781	49.56	50.00	36	20	231	25	
L2CB20302DCS66H	1689	1849	65.81	66.25	30	20	249	28	
L2CB20362DCS66H	1778	1933	65.81	66.25	36	20	281	33	
L2CB20302DCS72H	1761	2025	72.81	73.24	30	20	265	30	
L2CB20362DCS72H	1858	2014	72.81	73.24	36	20	298	36	
L2CB24302DCS50H	1601	1734	49.56	50.00	30	24	204	25	
L2CB24362DCS50H	1690	1850	49.56	50.00	36	24	231	30	
L2CB24302DCS66H	1756	1925	65.81	66.25	30	24	249	33	
L2CB24362DCS66H	1848	2009	65.81	66.25	36	24	281	39	
L2CB24302DCS72H	1835	2103	72.81	73.24	30	24	265	36	
L2CB24362DCS72H	1932	2094	72.81	73.24	36	24	298	43	

L2CB • Storage Cabinet with 3 High Cupboard, 2 Adjustable Shelves over a 2 High Lateral

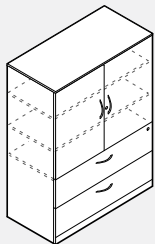

- 50"h. cabinet comes with one adjustable shelf.
- 66" and 72" Cabinet comes with 2 adjustable shelves.
- Two locks included.
- Optional e-lock available for the file drawers vertical position. Please specify V - Vertical and add \$224 list.
- Optional e-lock available in the horizontal position for upper storage cabinet. Please specify HR - Horizontal Right and add \$224 list.

PRODUCT CODE	FINISH		SIZE/INCHES				WEIGHT		VOL FT ³
	LP	W	H (LP/B)	H (W)	W	D	LBS		
L2CB20302H2D50H	2190	2312	49.56	50.00	30	20	256	21	
L2CB20362H2D50H	2324	2435	49.56	50.00	36	20	292	25	
L2CB20302H2D66H	2451	2575	65.81	66.25	30	20	321	28	
L2CB20362H2D66H	2611	2756	65.81	66.25	36	20	365	33	
L2CB20302H2D72H	2527	2652	72.81	73.24	30	20	338	30	
L2CB20362H2D72H	2665	2790	72.81	73.24	36	20	383	36	
L2CB24302H2D50H	2277	2401	49.56	50.00	30	24	256	25	
L2CB24362H2D50H	2421	2534	49.56	50.00	36	24	292	30	
L2CB24302H2D66H	2549	2677	65.81	66.25	30	24	321	33	
L2CB24362H2D66H	2715	2867	65.81	66.25	36	24	365	39	
L2CB24302H2D72H	2629	2757	72.81	73.24	30	24	338	36	
L2CB24362H2D72H	2770	2902	72.81	73.24	36	24	383	43	

L2CB • Storage Cabinet with a 2 High Cupboard, 1 Adjustable Shelf over a 3 High Lateral

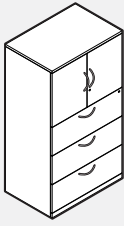

- One lock on right door.
- Two locks included.
- Optional e-lock available for the file drawers vertical position. Please specify V - Vertical and add \$224 list.
- Optional e-lock available in the horizontal position for upper storage cabinet. Please specify HR - Horizontal Right and add \$224 list.

PRODUCT CODE	FINISH LP	W	SIZE/INCHES				WEIGHT		VOL FT ³
			H (LP/B)	H (W)	W	D	LBS		
L2CB20303H2D66H	2569	2694	65.81	66.25	30	20	337	28	
L2CB20363H2D66H	2729	2877	65.81	66.25	36	20	381	33	
L2CB20303H2D72H	2670	2795	72.81	73.25	30	20	354	30	
L2CB20363H2D72H	2830	2982	72.81	73.25	36	20	399	36	
L2CB24303H2D66H	2671	2800	65.81	66.25	30	24	337	28	
L2CB24363H2D66H	2839	2991	65.81	66.25	36	24	381	33	
L2CB24303H2D72H	2779	2907	72.81	73.25	30	24	354	30	
L2CB24363H2D72H	2946	3101	72.81	73.25	36	24	399	36	

L2CB • Storage Cabinet with a 2 Door Storage Cupboard above a 4 High Lateral

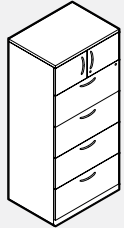

- Two locks included.
- Lock on cupboard is not available for UB, UC or RN handles.
- Optional e-lock available for the file drawers vertical position. Please specify V - Vertical and add \$224 list.
- Optional e-lock available in the horizontal position for upper storage cabinet. Please specify HR - Horizontal Right and add \$224 list.

PRODUCT CODE	FINISH LP	W	SIZE/INCHES				WEIGHT		VOL FT ³
			H (LP/B)	H (W)	W	D	LBS		
L2CB20304H2D66H	2957	3106	65.81	66.25	30	20	343	28	
L2CB20364H2D66H	3189	3345	65.81	66.25	36	20	387	33	
L2CB20304H2D72H	3035	3165	72.81	73.24	30	20	360	30	
L2CB20364H2D72H	3222	3375	72.81	73.24	36	20	405	36	
L2CB24304H2D66H	3076	3231	65.81	66.25	30	24	278	33	
L2CB24364H2D66H	3317	3479	65.81	66.25	36	24	314	39	
L2CB24304H2D72H	3156	3291	72.81	73.24	30	24	343	36	
L2CB24364H2D72H	3348	3510	72.81	73.24	36	24	387	43	

L2CB • Storage Cabinet with Open Bookcase and 2 Adjustable Shelves & 2 Door Cupboard

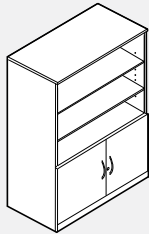

- 50" h. cabinet comes with one adjustable shelf.
- 66" h. and 72" h. Cabinet comes with 2 adjustable Shelves.
- One lock included.
- Optional e-lock available in the horizontal position. Please specify HR - Horizontal Right and add \$224 list.

PRODUCT CODE	FINISH LP	W	SIZE/INCHES				WEIGHT		VOL FT ³
			H (LP/B)	H (W)	W	D	LBS		
L2CB20302D050H	1414	1601	49.56	50.00	30	20	212	21	
L2CB20362D050H	1509	1773	49.56	50.00	36	20	248	25	
L2CB20302D066H	1585	1823	65.81	66.25	30	20	277	28	
L2CB20362D066H	1944	2068	65.81	66.25	36	20	321	33	
L2CB20302D072H	1638	1898	72.81	73.24	30	20	294	30	
L2CB20362D072H	1786	2145	72.81	73.24	36	20	339	36	
L2CB24302D050H	1483	1681	49.56	50.00	30	24	212	25	
L2CB24362D050H	1585	1862	49.56	50.00	36	24	248	30	
L2CB24302D066H	1664	1915	65.81	66.25	30	24	277	33	
L2CB24362D066H	1795	2171	65.81	66.25	36	24	321	39	
L2CB24302D072H	1720	1990	72.81	73.24	30	24	294	36	
L2CB24362D072H	1874	2254	72.81	73.24	36	24	339	43	

L2CB • Storage Cabinet with Open Bookcase and 2 Adjustable Shelves over a 2 High Lateral

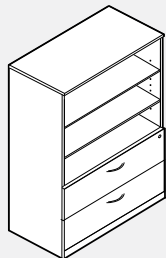

- 50" h. cabinet comes with one adjustable shelf.
- 66" h. and 72" h. Cabinet comes with 2 adjustable Shelves.
- One lock included.
- Optional e-lock available in the vertical position. Please specify V - Vertical and add \$224 list.

PRODUCT CODE	FINISH LP	W	SIZE/INCHES				WEIGHT		VOL FT ³
			H (LP/B)	H (W)	W	D	LBS		
L2CB20302H050H	1706	1833	49.56	50.00	30	20	226	21	
L2CB20362H050H	1791	1925	49.56	50.00	36	20	261	25	
L2CB20302H066H	1879	2003	65.81	66.25	30	20	290	28	
L2CB20362H066H	2031	2113	65.81	66.25	36	20	334	33	
L2CB20302H072H	1955	1989	72.81	73.24	30	20	307	30	
L2CB20362H072H	2085	2165	72.81	73.24	36	20	352	36	
L2CB24302H050H	1789	1924	49.56	50.00	30	24	226	25	
L2CB24362H050H	1879	2022	49.56	50.00	36	24	261	30	
L2CB24302H066H	1973	2103	65.81	66.25	30	24	290	33	
L2CB24362H066H	2133	2219	65.81	66.25	36	24	334	39	
L2CB24302H072H	2052	2089	72.81	73.24	30	24	307	36	
L2CB24362H072H	2190	2273	72.81	73.24	36	24	352	43	

L2CBA • Storage Cabinet with 2 Doors and 4 Adjustable Shelves

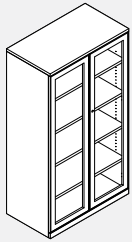

- One lock included.
- Door frame is anodized aluminum.
- Glazing is frosted acrylic.
- Doors standard with no handles.
- E-locks not available for aluminum framed glass doors.

PRODUCT CODE	FINISH LP	W	SIZE / INCHES				D	WEIGHT LBS	VOL FT ³
			H (LP/B)	H (W)	W	D			
L2CBA20302D50H	2594	2731	49.56	50.00	30	20	235	21	
L2CBA20362D50H	2809	2973	49.56	50.00	36	20	281	25	
L2CBA20302D66H	3031	3165	65.81	66.25	30	20	300	28	
L2CBA20362D66H	3296	3454	65.81	66.25	36	20	344	33	
L2CBA20302D72H	3183	3317	72.81	73.25	30	20	317	30	
L2CBA20362D72H	3461	3617	72.81	73.25	36	20	362	36	
L2CBA24302D50H	2663	2807	49.56	50.00	30	24	235	21	
L2CBA24362D50H	2882	3047	49.56	50.00	36	24	281	25	
L2CBA24302D66H	3106	3249	65.81	66.25	30	24	300	28	
L2CBA24362D66H	3378	3541	65.81	66.25	36	24	344	33	
L2CBA24302D72H	3263	3400	72.81	73.25	30	24	317	30	
L2CBA24362D72H	3546	3710	72.81	73.25	36	24	362	36	

L2CBA • Storage Cabinet with 2 Doors, Coat Rod and 1 Adjustable Shelf

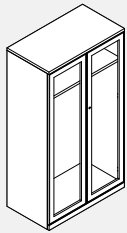

- One lock included.
- Door frame is anodized aluminum.
- Glazing is frosted acrylic.
- Doors standard with no handles.
- E-locks not available for aluminum framed glass doors.

PRODUCT CODE	FINISH LP	W	SIZE / INCHES				D	WEIGHT LBS	VOL FT ³
			H (LP/B)	H (W)	W	D			
L2CBA20302DCS50H	2452	2580	49.56	50.00	30	20	195	21	
L2CBA20362DCS50H	2631	2786	49.56	50.00	36	20	221	25	
L2CBA20302DCS66H	2806	2966	65.81	66.25	30	20	239	28	
L2CBA20362DCS66H	3016	3174	65.81	66.25	36	20	271	33	
L2CBA20302DCS72H	2958	3221	72.81	73.25	30	20	255	30	
L2CBA20362DCS72H	3187	3342	72.81	73.25	36	20	288	36	
L2CBA24302DCS50H	2514	2646	49.56	50.00	30	24	195	21	
L2CBA24362DCS50H	2696	2858	49.56	50.00	36	24	221	25	
L2CBA24302DCS66H	2872	3042	65.81	66.25	30	24	239	28	
L2CBA24362DCS66H	3087	3251	65.81	66.25	36	24	271	33	
L2CBA24302DCS72H	3031	3298	72.81	73.25	30	24	255	30	
L2CBA24362DCS72H	3258	3422	72.81	73.25	36	24	288	36	

L2CBA • Storage Cabinet with 3 High Cupboard, 2 Adjustable Shelves over a 2 High Lateral

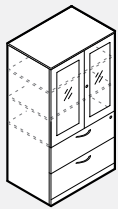

- Cabinet 2h2d.
- One lock on right door.
- One lock on upper drawer.
- Door frame is anodized aluminum with lock(s).
- Glazing is frosted acrylic.
- Doors standard with no handles.
- Two locks included.
- Optional e-lock available in the vertical position. Please specify V-Vertical and add \$224 list.
- E-locks not available for aluminum framed glass doors.

PRODUCT CODE	FINISH LP	W	SIZE / INCHES				D	WEIGHT LBS	VOL FT ³
			H (LP/B)	H (W)	W	D			
L2CBA20302H2D50H	2740	2862	49.56	50.00	30	20	233	19	
L2CBA20362H2D50H	2925	3038	49.56	50.00	36	20	265	22	
L2CBA20302H2D66H	3207	3330	65.81	66.25	30	20	292	25	
L2CBA20362H2D66H	3444	3588	65.81	66.25	36	20	332	29	
L2CBA20302H2D72H	3359	3484	72.81	73.25	30	20	307	27	
L2CBA20362H2D72H	3585	3710	72.81	73.25	36	20	348	32	
L2CBA24302H2D50H	2826	2952	49.56	50.00	30	24	233	22	
L2CBA24362H2D50H	3017	3132	49.56	50.00	36	24	265	27	
L2CBA24302H2D66H	3307	3433	65.81	66.25	30	24	292	29	
L2CBA24362H2D66H	3546	3698	65.81	66.25	36	24	332	35	
L2CBA24302H2D72H	3461	3589	72.81	73.25	30	24	307	32	
L2CBA24362H2D72H	3689	3821	72.81	73.25	36	24	348	38	

L2CBA • Storage Cabinet with 2 High Cupboard, 1 Adjustable Shelves over a 3 High Lateral

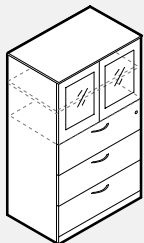

- Cabinet 3h2d.
- One lock on right door.
- One lock on upper drawer.
- Door frame is anodized aluminum with lock(s).
- Glazing is frosted acrylic.
- Doors standard with no handles.
- Two locks included.
- Optional e-lock available in the vertical position. Please specify V-Vertical and add \$224 list.
- E-locks not available for aluminum framed glass doors.

PRODUCT CODE	FINISH LP	W	SIZE / INCHES				D	WEIGHT LBS	VOL FT ³
			H (LP/B)	H (W)	W	D			
L2CBA20303H2D66H	3160	3285	65.81	66.25	30	20	337	28	
L2CBA20363H2D66H	3377	3523	65.81	66.25	36	20	381	33	
L2CBA20303H2D72H	3341	3463	72.81	73.25	30	20	354	30	
L2CBA20363H2D72H	3564	3716	72.81	73.25	36	20	399	36	
L2CBA24303H2D66H	3263	3392	65.81	66.25	30	24	337	28	
L2CBA24363H2D66H	3485	3639	65.81	66.25	36	24	381	33	
L2CBA24303H2D72H	3446	3575	72.81	73.25	30	24	354	30	
L2CBA24363H2D72H	3678	3838	72.81	73.25	36	24	399	36	

L2CBA • Storage Cabinet with 2 Aluminum Door Storage Cupboard above a 4 high Lateral

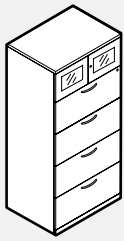

- Two locks included.
- Door frame is anodized aluminum.
- Glazing is frosted acrylic.
- Doors standard with no handles.
- One lock on right door.
- One lock on upper drawer.
- Optional e-lock available in the vertical position. Please specify V - Vertical and add \$224 list.
- E-locks not available for aluminum framed glass doors.

PRODUCT CODE	FINISH		SIZE/INCHES				WEIGHT VOL	
	LP	W	H (LP/B)	H (W)	W	D	LBS	FT ³
L2CBA20304H2D66H	3362	3512	65.81	66.25	30	20	343	28
L2CBA20364H2D66H	3696	3852	65.81	66.25	36	20	387	33
L2CBA20304H2D72H	3524	3655	72.81	73.25	30	20	360	30
L2CBA20364H2D72H	3755	3909	72.81	73.25	36	20	345	36
L2CBA24304H2D66H	3482	3637	65.81	66.25	30	24	343	28
L2CBA24364H2D66H	3824	3985	65.81	66.25	36	24	387	33
L2CBA24304H2D72H	3649	3783	72.81	73.25	30	24	360	30
L2CBA24364H2D72H	3883	4046	72.81	73.25	36	24	345	36

L2HH • Hutch with Hinged Doors

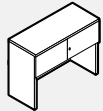

30" - 42" units



48" units

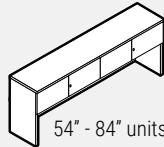

54" - 84" units

- 30" - 42" units come with one lock.
- 48" - 84" units come with two locks.
- Optional e-lock available in the horizontal position. Please specify HR - Horizontal Right and add \$224 list.
- Hutches 48" or longer require two e-locks.

PRODUCT CODE	FINISH		SIZE/INCHES				WEIGHT VOL	
	LP	W	H (LP/B)	W	D	LBS	FT ³	
L2HH30H36	851	954	36.81	30	16	138	17	
L2HH36H36	899	1015	36.81	36	16	145	18	
L2HH42H36	974	1119	36.81	42	16	163	19	
L2HH48H36	1230	1381	36.81	48	16	180	22	
L2HH54H36	1456	1608	36.81	54	16	208	26	
L2HH60H36	1488	1676	36.81	60	16	216	29	
L2HH66H36	1568	1779	36.81	66	16	233	30	
L2HH72H36	1610	1836	36.81	72	16	251	32	
L2HH78H36	1702	1988	36.81	78	16	264	46	
L2HH84H36	1751	2012	36.81	84	16	277	50	
L2HH30H43	915	1008	43.81	30	16	158	19	
L2HH36H43	945	1062	43.81	36	16	166	20	
L2HH42H43	1043	1197	43.81	42	16	175	22	
L2HH48H43	1286	1432	43.81	48	16	191	24	
L2HH54H43	1495	1669	43.81	54	16	209	31	
L2HH60H43	1548	1736	43.81	60	16	227	32	
L2HH66H43	1632	1843	43.81	66	16	249	33	
L2HH72H43	1708	1936	43.81	72	16	259	36	
L2HH78H43	1773	2056	43.81	78	16	272	48	
L2HH84H43	1819	2089	43.81	84	16	285	53	

L2HH-A • Hutch with Aluminum Hinged Doors

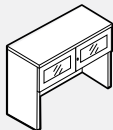

30" - 42" units

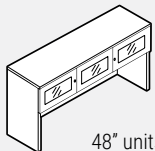

48" units

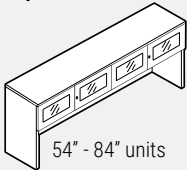

54" - 84" units

- 30" - 42" units come with one lock.
- 48" - 84" units come with two locks.
- Door frame is anodized aluminum.
- Glazing is frosted acrylic.
- Doors standard with no handles.
- E-locks not available for aluminum framed glass doors.

PRODUCT CODE	FINISH		SIZE/INCHES				WEIGHT VOL	
	LP	W	H (LP/B)	W	D	LBS	FT ³	
L2HH30H36A	1351	1451	36.81	30	16	138	17	
L2HH36H36A	1430	1546	36.81	36	16	145	18	
L2HH42H36A	1522	1635	36.81	42	16	163	19	
L2HH48H36A	1997	2145	36.81	48	16	180	22	
L2HH54H36A	2432	2586	36.81	54	16	208	26	
L2HH60H36A	2496	2684	36.81	60	16	216	29	
L2HH66H36A	2587	2614	36.81	66	16	233	30	
L2HH72H36A	2655	2881	36.81	72	16	251	32	
L2HH78H36A	2749	3035	36.81	78	16	264	46	
L2HH84H36A	2826	3101	36.81	84	16	277	50	
L2HH30H43A	1415	1509	43.81	30	16	158	19	
L2HH36H43A	1480	1594	43.81	36	16	166	20	
L2HH42H43A	1591	1748	43.81	42	16	175	22	
L2HH48H43A	2052	2198	43.81	48	16	191	24	
L2HH54H43A	2490	2646	43.81	54	16	209	31	
L2HH60H43A	2556	2747	43.81	60	16	227	32	
L2HH66H43A	2651	2769	43.81	66	16	249	33	
L2HH72H43A	2760	2989	43.81	72	16	259	36	
L2HH78H43A	2819	3102	43.81	78	16	272	48	
L2HH84H43A	2900	3167	43.81	84	16	285	53	

L2HO • Open Hutch

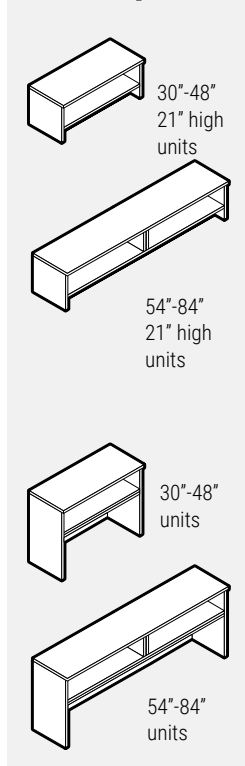

PRODUCT CODE	FINISH LP	W	SIZE/INCHES			WEIGHT LBS	VOL FT ³
			H(LP/B)	W	D		
L2HO30H21	472	579	20.56	30	16	73	11
L2HO36H21	518	605	20.56	36	16	81	13
L2HO42H21	575	727	20.56	42	16	96	15
L2HO48H21	639	799	20.56	48	16	100	18
L2HO54H21	769	931	20.56	54	16	124	20
L2HO60H21	796	997	20.56	60	16	134	22
L2HO66H21	849	1075	20.56	66	16	144	24
L2HO72H21	882	1122	20.56	72	16	152	26
L2HO78H21	932	1170	20.56	78	16	161	29
L2HO84H21	977	1262	20.56	84	16	169	31
L2HO30H36	576	681	36.81	30	16	91	18
L2HO36H36	626	751	36.81	36	16	109	19
L2HO42H36	691	842	36.81	42	16	127	22
L2HO48H36	799	956	36.81	48	16	131	24
L2HO54H36	903	1064	36.81	54	16	145	29
L2HO60H36	935	1137	36.81	60	16	138	31
L2HO66H36	996	1225	36.81	66	16	142	33
L2HO72H36	1041	1284	36.81	72	16	149	36
L2HO78H36	1096	1399	36.81	78	16	154	46
L2HO84H36	1153	1431	36.81	84	16	158	50
L2HO30H43	642	681	43.81	30	16	99	22
L2HO36H43	677	751	43.81	36	16	108	26
L2HO42H43	801	842	43.81	42	16	122	31
L2HO48H43	854	956	43.81	48	16	127	35
L2HO54H43	972	1064	43.81	54	16	151	40
L2HO60H43	1063	1137	43.81	60	16	161	44
L2HO66H43	1126	1225	43.81	66	16	171	48
L2HO72H43	1209	1284	43.81	72	16	178	53
L2HO78H43	1233	1399	43.81	78	16	187	57
L2HO84H43	1293	1431	43.81	84	16	196	62

L2HF • Hutch with Flip Up Doors

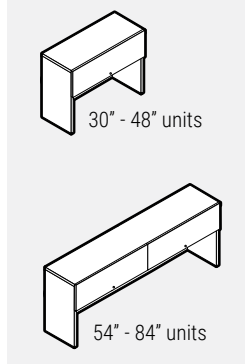

- 30" - 48" units come with one lock.
- 54" - 84" units come with two locks.
- Optional e-lock available in the horizontal position. Please specify HR - Horizontal Right and add \$224 list.
- Hutches 48" or longer require two e-locks.

PRODUCT CODE	FINISH LP	W	SIZE/INCHES			WEIGHT LBS	VOL FT ³
			H(LP/B)	W	D		
L2HF30H36	857	890	36.81	30	16	142	18
L2HF36H36	914	949	36.81	36	16	146	19
L2HF42H36	983	1022	36.81	42	16	158	22
L2HF48H36	988	1029	36.81	48	16	180	24
L2HF54H36	1483	1541	36.81	54	16	182	29
L2HF60H36	1573	1637	36.81	60	16	220	31
L2HF66H36	1647	1713	36.81	66	16	253	33
L2HF72H36	1696	1764	36.81	72	16	259	36
L2HF78H36	1774	1845	36.81	78	16	264	46
L2HF84H36	1839	1913	36.81	84	16	275	50
L2HF30H43	943	978	43.81	30	16	150	22
L2HF36H43	948	988	43.81	36	16	154	26
L2HF42H43	1021	1060	43.81	42	16	166	31
L2HF48H43	1093	1136	43.81	48	16	188	35
L2HF54H43	1498	1559	43.81	54	16	194	40
L2HF60H43	1619	1684	43.81	60	16	232	44
L2HF66H43	1702	1772	43.81	66	16	265	48
L2HF72H43	1749	1816	43.81	72	16	271	53
L2HF78H43	1878	1956	43.81	78	16	276	57
L2HF84H43	1948	2026	43.81	84	16	287	62

L2HHP • Hutch with Laminate Doors and Pigeon Holes

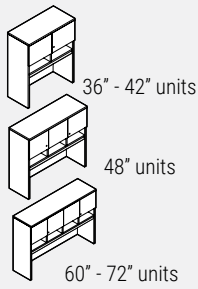

- For tackboards, please use LTB21xx.
- 36" - 42" units come with one lock.
- 48" - 72" units come with two locks.
- Optional e-lock available in the horizontal position. Please specify HR - Horizontal Right or HL - Horizontal Left for the 48" wide unit and add \$224 list.
- Hutches 48" or longer require two e-locks.

PRODUCT CODE	FINISH		SIZE/INCHES			WEIGHT		VOL FT ³
	LP	W	H (LP/B)	W	D	LBS		
L2HHP36	1092	1203	43.81	36	16	145	17	
L2HHP42	1159	1289	43.81	42	16	163	19	
L2HHP48	1561	1715	43.81	48	16	180	22	
L2HHP60	1890	2068	43.81	60	16	216	26	
L2HHP66	1949	2169	43.81	66	16	233	30	
L2HHP72	2030	2254	43.81	72	16	251	32	

L2HHP-A • Hutch with Aluminum Hinged Doors and Pigeon Holes

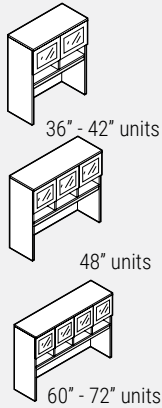

- For tackboards, please use LTB21xx.
- 36" - 42" units come with one lock.
- 48" - 72" units come with two locks.
- Door frame is anodized aluminum.
- Glazing is frosted acrylic.
- Doors standard with no handles.
- E-locks not available for aluminum framed glass doors.

PRODUCT CODE	FINISH		SIZE/INCHES			WEIGHT		VOL FT ³
	LP	W	H (LP/B)	W	D	LBS		
L2HHP36A	1531	1646	43.81	36	16.8	132	15	
L2HHP42A	1670	1803	43.81	42	16.8	148	17	
L2HHP48A	2239	2391	43.81	48	16.8	164	20	
L2HHP60A	2768	2949	43.81	60	16.8	196	24	
L2HHP66A	2864	3084	43.81	66	16.8	212	27	
L2HHP72A	2983	3207	43.81	72	16.8	228	29	

L2HSD • Hutch with Sliding Laminate Doors

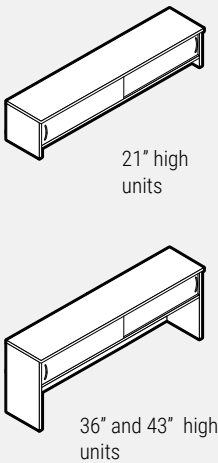

- One lock included.

PRODUCT CODE	FINISH		SIZE/INCHES			WEIGHT		VOL FT ³
	LP	W	H (LP/B)	W	D	LBS		
L2HSD48H21	1062	1225	20.56	48	16	122	18	
L2HSD54H21	1165	1349	20.56	54	16	146	20	
L2HSD60H21	1205	1409	20.56	60	16	156	22	
L2HSD66H21	1285	1509	20.56	66	16	166	24	
L2HSD72H21	1322	1540	20.56	72	16	174	26	
L2HSD78H21	1387	1671	20.56	78	16	183	29	
L2HSD84H21	1428	1708	20.56	84	16	191	31	
L2HSD48H36	1316	1484	36.81	48	16	141	24	
L2HSD54H36	1454	1621	36.81	54	16	165	29	
L2HSD60H36	1488	1697	36.81	60	16	175	31	
L2HSD66H36	1579	1813	36.81	66	16	185	33	
L2HSD72H36	1619	1850	36.81	72	16	193	36	
L2HSD78H36	1706	2026	36.81	78	16	201	46	
L2HSD84H36	1745	2055	36.81	84	16	210	50	
L2HSD48H43	1394	1562	43.81	48	16	149	35	
L2HSD54H43	1540	1700	43.81	54	16	173	40	
L2HSD60H43	1581	1789	43.81	60	16	183	44	
L2HSD66H43	1672	1905	43.81	66	16	193	48	
L2HSD72H43	1763	1997	43.81	72	16	200	53	
L2HSD78H43	1812	2127	43.81	78	16	209	57	
L2HSD84H43	1869	2158	43.81	84	16	218	62	

L2HGSD • Hutch with Sliding Glass Doors

- One lock included.
- Glass is frosted tempered.

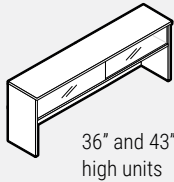
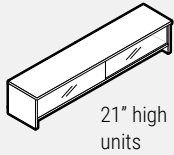

PRODUCT CODE	FINISH LP	SIZE/INCHES				D	WEIGHT LBS	VOL FT ³
		W	H (LP/B)	W	D			
L2HGSD48H21	2281	2451	20.56	48	16	139	18	
L2HGSD54H21	2404	2593	20.56	54	16	163	20	
L2HGSD60H21	2452	2660	20.56	60	16	184	22	
L2HGSD66H21	2543	2779	20.56	66	16	194	24	
L2HGSD72H21	2602	2850	20.56	72	16	201	26	
L2HGSD78H21	2698	2991	20.56	78	16	210	29	
L2HGSD84H21	2764	3055	20.56	84	16	219	31	
L2HGSD48H36	2424	2593	36.81	48	16	157	24	
L2HGSD54H36	2576	2743	36.81	54	16	182	29	
L2HGSD60H36	2614	2822	36.81	60	16	202	31	
L2HGSD66H36	2714	2949	36.81	66	16	212	33	
L2HGSD72H36	2779	3050	36.81	72	16	220	36	
L2HGSD78H36	2890	3204	36.81	78	16	229	46	
L2HGSD84H36	2966	3256	36.81	84	16	238	50	
L2HGSD48H43	2481	2721	43.81	48	16	165	35	
L2HGSD54H43	2614	2875	43.81	54	16	189	40	
L2HGSD60H43	2675	2957	43.81	60	16	210	44	
L2HGSD66H43	2779	3050	43.81	66	16	220	48	
L2HGSD72H43	2850	3192	43.81	72	16	228	53	
L2HGSD78H43	2960	3328	43.81	78	16	237	57	
L2HGSD84H43	3042	3403	43.81	84	16	245	62	

L2DSH • Double Sided Hutch with Laminate Doors

- Two locks included.

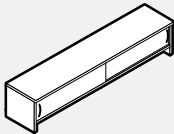

PRODUCT CODE	FINISH LP	SIZE/INCHES				D	WEIGHT LBS	VOL FT ³
		W	H (LP/B)	W	D			
L2DSH60H21	1268	1472	20.56	60	16	156	22	
L2DSH66H21	1350	1575	20.56	66	16	166	24	
L2DSH72H21	1392	1585	20.56	72	16	201	26	
L2DSH78H21	1464	1748	20.56	78	16	210	29	
L2DSH84H21	1509	1786	20.56	84	16	219	31	

LTB27 • Tackboards for 43" High Hutches

- Provides a tackable surface for notes and memos.
- Velcro for installation is included.
- Tackboards for hutches are 3" shorter than the overall size of the hutch.

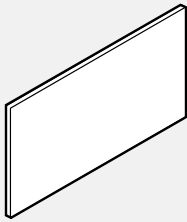

PRODUCT CODE	FABRIC		SIZE/INCHES				WEIGHT LBS	VOL FT ³
	GR1	GR2	H	W	D			
LTB2727	298	315	27	27	1	7	0.46	
LTB2733	323	344	27	33	1	7	0.57	
LTB2739	352	378	27	39	1	7	0.67	
LTB2745	399	428	27	45	1	8	0.78	
LTB2751	459	486	27	51	1	8	0.88	
LTB2757	512	539	27	57	1	9	0.98	
LTB2763	564	592	27	63	1	9	1.09	
LTB2769	620	652	27	69	1	10	1.19	
LTB2775	696	730	27	75	1	10	1.30	
LTB2781	777	811	27	81	1	11	1.40	

LTB21 • Tackboards for 36" High Hutches

- Provides a tackable surface for notes and memos.
- Velcro for installation is included.
- Tackboards for hutches are 3" shorter than the overall size of the hutch.

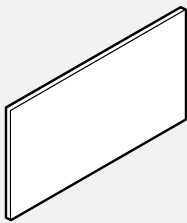

PRODUCT CODE	FABRIC		SIZE/INCHES				WEIGHT LBS	VOL FT ³
	GR1	GR2	H	W	D			
LTB2127	233	252	21	27	1	4	0.38	
LTB2133	253	273	21	33	1	4	0.42	
LTB2139	275	303	21	39	1	4	0.49	
LTB2145	314	341	21	45	1	5	0.56	
LTB2151	359	372	21	51	1	5	0.63	
LTB2157	399	428	21	57	1	6	0.69	
LTB2163	442	474	21	63	1	6	0.76	
LTB2169	486	513	21	69	1	7	0.83	
LTB2175	545	572	21	75	1	7	0.89	
LTB2181	608	636	21	81	1	8	0.96	

L2HC • Corner Curved Bookcase

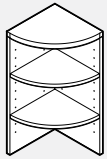

- Shipped knocked down (KD).

PRODUCT CODE	FINISH		SIZE/INCHES			WEIGHT		VOL FT ³
	LP	W	H (LP/B)	W	D	LBS		
L2HC1637	617	712	36.81	16.87	16.87	57	7	
L2HC1644	656	752	43.81	16.87	16.87	63	8	

L2HBK • Open Hutch Bookcase

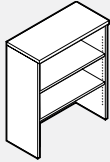

- Shipped knocked down (KD).

PRODUCT CODE	FINISH		SIZE/INCHES			WEIGHT		VOL FT ³
	LP	W	H (LP/B)	W	D	LBS		
L2HBK303	724	845	36.81	30	16.875	109	12	
L2HBK363	782	928	36.81	36	16.875	123	14	
L2HBK304	793	915	43.81	30	16.875	119	13	
L2HBK364	837	982	43.81	36	16.875	135	17	

L2WHO • Wall Mounted Open Storage

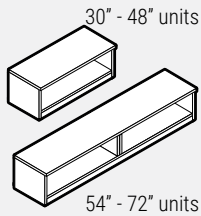

PRODUCT CODE	FINISH		SIZE/INCHES				WEIGHT		VOL FT ³
	LP	W	H (LP/B)	H (W)	W	D	LBS		
L2WHO30	520	617	16.75	17.18	30	16	69	7	
L2WHO36	553	696	16.75	17.18	36	16	78	8	
L2WHO42	639	777	16.75	17.18	42	16	87	9	
L2WHO48	678	831	16.75	17.18	48	16	97	10	
L2WHO54	733	924	16.75	17.18	54	16	106	11	
L2WHO60	915	1032	16.75	17.18	60	16	117	12	
L2WHO66	959	1064	16.75	17.18	66	16	125	13	
L2WHO72	1003	1170	16.75	17.18	72	16	139	14	

L2WHH • Wall Mounted Hinged Door

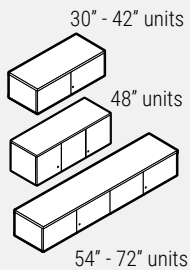

- 30" - 42" units come with one lock.
- 48" - 72" units come with two locks.
- Optional e-lock available in the horizontal position. Please specify HR - Horizontal Right or HL - Horizontal Left for the 48" wide unit and add \$224 list.
- Hutches 48" or longer require two e-locks.

PRODUCT CODE	FINISH		SIZE/INCHES				WEIGHT		VOL FT ³
	LP	W	H (LP/B)	H (W)	W	D	LBS		
L2WHH30	701	777	16.75	17.18	30	16	120	7	
L2WHH36	752	842	16.75	17.18	36	16	139	8	
L2WHH42	821	932	16.75	17.18	42	16	143	9	
L2WHH48	1029	1148	16.75	17.18	48	16	145	10	
L2WHH54	1220	1354	16.75	17.18	54	16	155	11	
L2WHH60	1262	1368	16.75	17.18	60	16	165	12	
L2WHH66	1320	1444	16.75	17.18	66	16	175	13	
L2WHH72	1376	1559	16.75	17.18	72	16	187	14	

L2WHF • Wall Mounted Flip-up Door

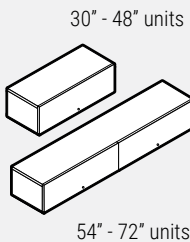

- 30" - 48" units come with one lock.
- 54" - 72" units come with two locks.
- Optional e-lock available in the horizontal position. Please specify HR - Horizontal Right or HL - Horizontal Left add \$224 list.
- Hutches 54" or longer require two e-locks.

PRODUCT CODE	FINISH		SIZE/INCHES				WEIGHT		VOL FT ³
	LP	W	H (LP/B)	H (W)	W	D	LBS		
L2WHF30	782		17.63	17.63	30	16	94	7	
L2WHF36	829		17.63	17.63	36	16	103	8	
L2WHF42	903		17.63	17.63	42	16	113	9	
L2WHF48	948		17.63	17.63	48	16	123	10	
L2WHF54	1399		17.63	17.63	54	16	130	11	
L2WHF60	1441		17.63	17.63	60	16	141	12	
L2WHF66	1527		17.63	17.63	66	16	151	13	
L2WHF72	1566		17.63	17.63	72	16	163	14	

L2WHH • Wall Mounted Unit with Aluminum Doors

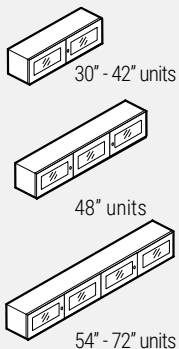

- Horizontal wall rails included.
- 30" - 42" units come with one lock.
- 48" - 72" units come with two locks.
- Door frame is anodized aluminum.
- Glazing is frosted acrylic.
- Doors standard with no handles.
- E-locks not available for aluminum framed glass doors.

PRODUCT CODE	FINISH LP	W	SIZE/INCHES				WEIGHT		VOL FT ³
			H(LP/B)	H(W)	W	D	LBS		
L2WHH30A	1166	1241	16.75	17.19	30	16	109	6	
L2WHH36A	1258	1349	16.75	17.19	36	16	126	7	
L2WHH42A	1366	1480	16.75	17.19	42	16	130	8	
L2WHH48A	1748	1867	16.75	17.19	48	16	132	9	
L2WHH54A	2110	2246	16.75	17.19	54	16	141	10	
L2WHH60A	2193	2300	16.75	17.19	60	16	150	11	
L2WHH66A	2279	2401	16.75	17.19	66	16	159	12	
L2WHH72A	2389	2570	16.75	17.19	72	16	170	13	

L2WSD • Wall Mounted Unit with Sliding Laminate Doors

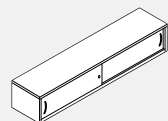

- Wall mounting horizontal rails included.
- One lock included.

PRODUCT CODE	FINISH LP	W	SIZE/INCHES				WEIGHT		VOL FT ³
			H(LP/B)	H(W)	W	D	LBS		
L2WSD36	1024	1151	16.75	17.19	36	16	128	7	
L2WSD42	1118	1266	16.75	17.19	42	16	130	8	
L2WSD48	1159	1309	16.75	17.19	48	16	132	9	
L2WSD54	1284	1464	16.75	17.19	54	16	141	10	
L2WSD60	1339	1539	16.75	17.19	60	16	150	11	
L2WSD66	1430	1661	16.75	17.19	66	16	159	12	
L2WSD72	1471	1717	16.75	17.19	72	16	170	13	

L2WGSD • Wall Mounted Unit with Sliding Glass Doors

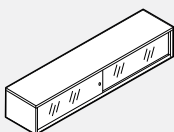

- Wall mounting horizontal rails included.
- Standard recessed chrome pull.
- Lock is included and must be installed at time of manufacturing, please specify key number.
- Frosted tempered glass.

PRODUCT CODE	FINISH LP	W	SIZE/INCHES				WEIGHT		VOL FT ³
			H(LP/B)	H(W)	W	D	LBS		
L2WGSD36	1902	2206	16.75	17.19	36	16	128	7	
L2WGSD42	2223	2378	16.75	17.19	42	16	130	8	
L2WGSD48	2279	2448	16.75	17.19	48	16	132	9	
L2WGSD54	2383	2570	16.75	17.19	54	16	141	10	
L2WGSD60	2446	2652	16.75	17.19	60	16	150	11	
L2WGSD66	2549	2785	16.75	17.19	66	16	159	12	
L2WGSD72	2646	2896	16.75	17.19	72	16	170	13	

LTB20 • Tackboards for Wall Mounted Units

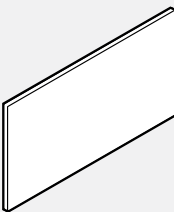

- Please specify wall rails BHV01 and BHV02 separately, see Boulevard Price List.
- Provides a tackable surface for notes and memos.
- Mounting brackets for installation included.
- Tackboards for Wall Mounted Unit. Wall Rails (BHV01 and BHV02) must be ordered separately.
- For tackboards longer than 60", please include an additional BHV01 at the centre.

PRODUCT CODE	FABRIC		SIZE/INCHES				WEIGHT		VOL FT ³
	GR1	GR2	H	W	D	LBS			
LTB2030	233	256	19.5	30	1	4	0.38		
LTB2036	253	276	19.5	36	1	4	0.42		
LTB2042	275	289	19.5	42	1	4	0.49		
LTB2048	314	329	19.5	48	1	5	0.56		
LTB2054	359	369	19.5	54	1	5	0.63		
LTB2060	399	420	19.5	60	1	6	0.69		
LTB2066	442	469	19.5	66	1	6	0.76		
LTB2072	486	513	19.5	72	1	7	0.83		
LTB2078	545	578	19.5	78	1	7	0.89		
LTB2084	608	650	19.5	84	1	8	0.96		

BHV • Component Wall Adapter - Single and Double

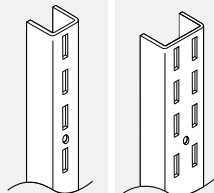

- **Used to attach system components to fixed wall.**
- Panel frame finish.
- The vertical wall adapter is a "U" shaped channel with a vertical row of slots with 1" centers.
- The double Component Wall Adapter has a double row of slots with 1" centers.
- Comes in 60" length only.
- Care should be taken to mount adapters only to wall studs using correct fasteners.
- Does not include mounting hardware. Mounting hardware selection to be based on wall material.
- Failure to do this may result in collapse of the unit and subsequent possible personal injury.
- Sold in pairs.

PRODUCT CODE	PRICE	SIZE/INCHES			WEIGHT		VOL FT ³
		H	W	D	LBS		
BHV01	99	60	0.75	0.5	4	0.009	
BHV02	114	60	1.50	0.5	5	0.026	

L2PHH • Boulevard Panel Mounted Unit with Aluminum Doors

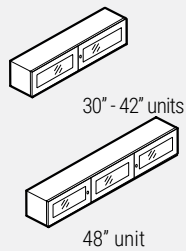

- 30" - 42" units comes with one lock
- 48" Unit comes with two locks.
- Door frame is anodized aluminum.
- Glazing is frosted acrylic.
- Doors standard with no handles.
- E-locks not available for aluminum framed glass doors.

PRODUCT CODE	FINISH LP	W	SIZE/INCHES				WEIGHT		VOL FT ³
			H (LP/B)	H (W)	W	D	LBS		
L2PHH30A	1300	1430	16.75	17.19	30	14.75	111	6	
L2PHH36A	1384	1539	16.75	17.19	36	14.75	128	7	
L2PHH42A	1484	1662	16.75	17.19	42	14.75	132	8	
L2PHH48A	1850	2091	16.75	17.19	48	14.75	134	9	

L2PSD • Boulevard Panel Mounted Unit with Sliding Laminate Doors

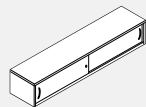

- Hardware included to mount the unit on the panel.
- One lock included.

PRODUCT CODE	FINISH LP	W	SIZE/INCHES				WEIGHT		VOL FT ³
			H (LP/B)	H (W)	W	D	LBS		
L2PSD36	1080	1201	16.75	17.19	36	14.75	123	7	
L2PSD42	1153	1304	16.75	17.19	42	14.75	132	8	
L2PSD48	1179	1330	16.75	17.19	48	14.75	141	9	

L2PGSD • Boulevard Panel Mounted Unit with Sliding Glass Doors

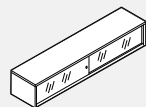

- Hardware included to mount the unit on the panel.
- One lock included.
- Standard recessed chrome pull.

PRODUCT CODE	FINISH LP	W	SIZE/INCHES				WEIGHT		VOL FT ³
			H (LP/B)	H (W)	W	D	LBS		
L2PGSD36	2171	2294	16.75	17.19	36	14.75	123	7	
L2PGSD42	2261	2418	16.75	17.19	42	14.75	132	8	
L2PGSD48	2302	2468	16.75	17.19	48	14.75	141	9	

L2PHO • Boulevard Panel Mounted Unit Open Overhead

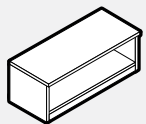

- Hardware included to mount the unit on the panel.

PRODUCT CODE	FINISH LP	W	SIZE/INCHES				WEIGHT		VOL FT ³
			H (LP/B)	H (W)	W	D	LBS		
L2PHO30	541	622	16.75	17.18	30	14.75	72	7	
L2PHO36	575	702	16.75	17.18	36	14.75	80	8	
L2PHO42	590	761	16.75	17.18	42	14.75	89	9	
L2PHO48	624	827	16.75	17.18	48	14.75	99	10	

L2PHH • Boulevard Panel Mounted Hinged Door Overhead

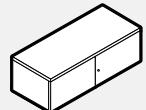

30" - 42" units

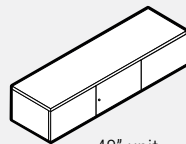

48" unit

- Hardware included to mount the unit on the panel.
- One lock included.
- Optional e-lock available in the horizontal position. Please specify HR - Horizontal Right or HL - Horizontal Left for the 48" wide unit and add \$224 list.
- Hutches 48" or longer require two e-locks.

PRODUCT CODE	FINISH LP	W	SIZE/INCHES				WEIGHT		VOL FT ³
			H (LP/B)	H (W)	W	D	LBS		
L2PHH30	835	965	16.75	17.18	30	14.75	122	7	
L2PHH36	879	1033	16.75	17.18	36	14.75	141	8	
L2PHH42	941	1115	16.75	17.18	42	14.75	145	9	
L2PHH48	1134	1374	16.75	17.18	48	14.75	147	10	

L2PHF • Boulevard Panel Mounted Flip-up Door Overhead

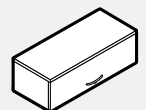

- Hardware included to mount the unit on the panel.
- One lock included.
- Optional e-lock available in the horizontal position. Please specify HR - Horizontal Right and add \$224 list.

PRODUCT CODE	FINISH LP	SIZE/INCHES			WEIGHT		VOL FT ³
		H (LP)	W	D	LBS		
L2PHF30	851	17.63	30	16	94	7	
L2PHF36	893	17.63	36	16	103	8	
L2PHF42	943	17.63	42	16	113	9	
L2PHF48	993	17.63	48	16	123	10	

L2SOHD • Stack On 2H Cabinet with Hinged Doors & Adjustable Shelf for 1H Storage

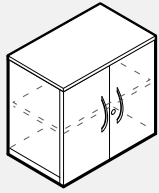

- One lock included.
- Optional e-lock available in the horizontal position. Please specify HR - Horizontal Right and add \$224 list.

PRODUCT CODE	FINISH LP	W	SIZE/INCHES				WEIGHT LBS	VOL FT³
			H(LP)	H(W)	W	D		
one door								
L2SOHDL15	626	697	29.63	29.63	15	16	95	7
L2SOHDR15	626	697	29.63	29.63	15	16	95	7
L2SOHDL18	642	713	29.63	29.63	18	16	99	9
L2SOHDR18	642	713	29.63	29.63	18	16	99	9
double door								
L2SOHD30	901	1007	29.63	29.63	30	16	171	11
L2SOHD36	1004	1134	29.63	29.63	36	16	178	13

L2SOALD • Stack On 2H Cabinet with Aluminum Hinged Doors & Adjustable Shelf for 1H Storage

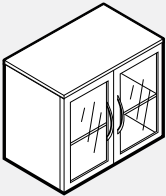

- No lock available for the one door units, one lock included for the double door units.
- Door frame is anodized aluminum.
- Glazing is frosted acrylic.
- Doors standard with no handles.
- E-locks not available for aluminum framed glass doors.

PRODUCT CODE	FINISH LP	W	SIZE/INCHES				WEIGHT LBS	VOL FT³
			H(LP)	H(W)	W	D		
one door								
L2SOALDL15	1043	1111	29.63	29.63	15	16	88	7
L2SOALDR15	1043	1111	29.63	29.63	15	16	88	7
L2SOALDL18	1089	1159	29.63	29.63	18	16	94	9
L2SOALDR18	1089	1159	29.63	29.63	18	16	94	9
double door								
L2SOALD30	1764	1872	29.63	29.63	30	16	164	11
L2SOALD36	1913	2038	29.63	29.63	36	16	172	13

L2S00 • Stack On 2H Cabinet with Adjustable Shelf for 1H Storage

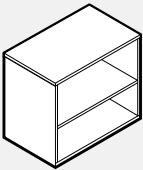

PRODUCT CODE	FINISH LP	W	SIZE/INCHES				WEIGHT LBS	VOL FT³
			H(LP)	H(W)	W	D		
L2S0015	459	532	29.63	29.63	15	16	61	7
L2S0018	470	546	29.63	29.63	18	16	72	8
L2S0030	604	719	29.63	29.63	30	16	88	14
L2S0036	704	845	29.63	29.63	36	16	94	19

L2SOSD • Stack On 2H Cabinet with Sliding Door, Divider & Adjustable Shelves for 1H Storage

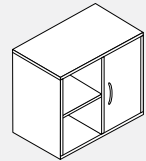

- Includes one sliding door.
- Lock not included.

PRODUCT CODE	FINISH LP	W	SIZE/INCHES				WEIGHT LBS	VOL FT³
			H(LP)	H(W)	W	D		
L2SOSD30	924	1031	29.63	29.63	30	16	116	14
L2SOSD36	1086	1218	29.63	29.63	36	16	121	19

L2SOGSD • Stack On 2H Cabinet with Sliding Glass Doors & Adjustable Shelf for 1H Storage

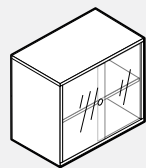

- One lock included.
- Standard recessed chrome pull.
- Glass is frosted tempered.

PRODUCT CODE	FINISH LP	W	SIZE/INCHES				WEIGHT LBS	VOL FT³
			H(LP)	H(W)	W	D		
L2SOGSD30	2175	2269	29.63	29.63	30	16	116	14
L2SOGSD36	2379	2493	29.63	29.63	36	16	121	19

L2CR1H1H • Credenza, 1 High File / File

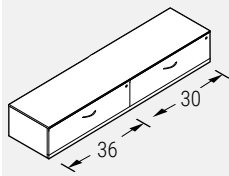

- Two locks included.
- Optional e-lock available in the vertical position. Please specify V - Vertical and add \$224 list.
- Hutches 48" or longer require two e-locks.

PRODUCT CODE	FINISH LP	B	W	SIZE/INCHES				WEIGHT LBS	VOL FT³
				H(LP/B)	H(W)	W	D		
L2CR1H1H2060	1664	1750	1788	19.94	20.5	60	20	189	22
L2CR1H1H2066	1745	1837	1877	19.94	20.5	66	20	209	24
L2CR1H1H2072	1769	1872	1916	19.94	20.5	72	20	246	26
L2CR1H1H2460	1730	1819	1862	19.94	20.5	60	24	189	22
L2CR1H1H2466	1813	1906	1955	19.94	20.5	66	24	209	24
L2CR1H1H2472	1839	1948	1993	19.94	20.5	72	24	246	26

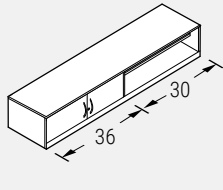
L2CR2DO • Credenza, 1 High 2 Doors / Open Shelf

- One lock included.
- One height adjustable shelf included.
- Optional e-lock available in the horizontal position. Please specify HR - Horizontal Right and add \$224 list.

PRODUCT CODE	FINISH LP	B	W	SIZE/INCHES				D	WEIGHT LBS	VOL FT ³
				H(LP/B)	H(W)	W	D			
L2CR2DO2060	1426	1582	1668	19.94	20.5	60	20	169	22	
L2CR2DO2066	1488	1661	1752	19.94	20.5	66	20	180	24	
L2CR2DO2072	1554	1745	1845	19.94	20.5	72	20	191	26	
L2CR2DO2460	1482	1646	1733	19.94	20.5	60	24	169	22	
L2CR2DO2466	1548	1727	1823	19.94	20.5	66	24	180	24	
L2CR2DO2472	1617	1812	1918	19.94	20.5	72	24	191	26	

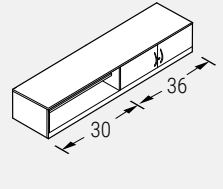
L2CRO2D • Credenza, 1 High Open Shelf / 2 Doors

- One lock included.
- One height adjustable shelf included.
- Optional e-lock available in the horizontal position. Please specify HR - Horizontal Right and add \$224 list.

PRODUCT CODE	FINISH LP	B	W	SIZE/INCHES				D	WEIGHT LBS	VOL FT ³
				H(LP/B)	H(W)	W	D			
L2CRO2D2060	1426	1582	1668	19.94	20.5	60	20	169	22	
L2CRO2D2066	1488	1661	1752	19.94	20.5	66	20	180	24	
L2CRO2D2072	1554	1745	1845	19.94	20.5	72	20	191	26	
L2CRO2D2460	1482	1646	1733	19.94	20.5	60	24	169	22	
L2CRO2D2466	1548	1727	1823	19.94	20.5	66	24	180	24	
L2CRO2D2472	1617	1812	1918	19.94	20.5	72	24	191	26	

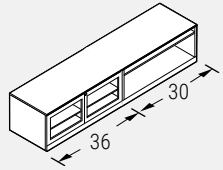
L2CR2ADO • Credenza, 2 Aluminum Doors / 1 High Open Shelf

- One lock included.
- One height adjustable shelf included.
- Door frame is anodized aluminum.
- Glazing is frosted acrylic.
- Doors standard with no handles.

PRODUCT CODE	FINISH LP	B	W	SIZE/INCHES				D	WEIGHT LBS	VOL FT ³
				H(LP/B)	H(W)	W	D			
L2CR2ADO2060	1900	2056	2144	19.94	20.5	60	20	154	20	
L2CR2ADO2066	2002	2175	2266	19.94	20.5	66	20	164	22	
L2CR2ADO2072	2067	2256	2361	19.94	20.5	72	20	174	24	
L2CR2ADO2460	1957	2119	2209	19.94	20.5	60	24	154	20	
L2CR2ADO2466	2063	2243	2339	19.94	20.5	66	24	164	22	
L2CR2ADO2472	2130	2324	2430	19.94	20.5	72	24	174	24	

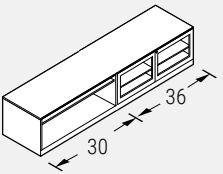
L2CRO2AD • Credenza, 1 High Open Shelf / 2 Aluminum Doors

- One lock included.
- One height adjustable shelf included.
- Door frame is anodized aluminum.
- Glazing is frosted acrylic.
- Doors standard with no handles.

PRODUCT CODE	FINISH LP	B	W	SIZE/INCHES				D	WEIGHT LBS	VOL FT ³
				H(LP/B)	H(W)	W	D			
L2CRO2AD2060	1900	2056	2144	19.94	20.5	60	20	154	20	
L2CRO2AD2066	2002	2175	2266	19.94	20.5	66	20	164	22	
L2CRO2AD2072	2067	2256	2361	19.94	20.5	72	20	174	24	
L2CRO2AD2460	1957	2119	2209	19.94	20.5	60	24	154	20	
L2CRO2AD2466	2063	2243	2339	19.94	20.5	66	24	164	22	
L2CRO2AD2472	2130	2324	2430	19.94	20.5	72	24	174	24	

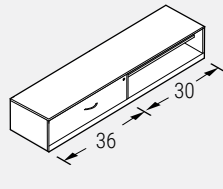
L2CR1HO • Credenza, 1 High File / Open Shelf

- One lock included.
- One height adjustable shelf included.
- Optional e-lock available in the vertical position. Please specify V - Vertical and add \$224 list.

PRODUCT CODE	FINISH LP	B	W	SIZE/INCHES				D	WEIGHT LBS	VOL FT ³
				H(LP/B)	H(W)	W	D			
L2CR1HO2060	1448	1575	1667	19.94	20.5	60	20	179	22	
L2CR1HO2066	1509	1647	1756	19.94	20.5	66	20	189	24	
L2CR1HO2072	1619	1772	1858	19.94	20.5	72	20	200	26	
L2CR1HO2460	1505	1638	1731	19.94	20.5	60	24	179	22	
L2CR1HO2466	1569	1711	1824	19.94	20.5	66	24	189	24	
L2CR1HO2472	1684	1840	1932	19.94	20.5	72	24	200	26	

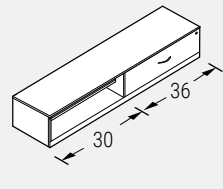
L2CRO1H • Credenza, Open Shelf / 1 High File

- One lock included.
- One height adjustable shelf included.
- Optional e-lock available in the vertical position. Please specify V - Vertical and add \$224 list.

PRODUCT CODE	FINISH LP	B	W	SIZE/INCHES				D	WEIGHT LBS	VOL FT ³
				H(LP/B)	H(W)	W	D			
L2CRO1H2060	1448	1575	1667	19.94	20.5	60	20	179	22	
L2CRO1H2066	1509	1647	1756	19.94	20.5	66	20	189	24	
L2CRO1H2072	1619	1772	1858	19.94	20.5	72	20	200	26	
L2CRO1H2460	1505	1638	1731	19.94	20.5	60	24	179	22	
L2CRO1H2466	1569	1711	1824	19.94	20.5	66	24	189	24	
L2CRO1H2472	1684	1840	1932	19.94	20.5	72	24	200	26	

L2CR01H • Credenza, 1 High File / 2 Door

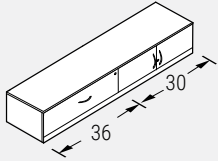

- Two locks included.
- Optional e-lock available in the vertical position for the file drawer. Please specify V - Vertical and add \$224 list.
- Optional e-lock available in the horizontal position. Please specify HR - Horizontal Right and add \$224 list.

PRODUCT CODE	FINISH			SIZE / INCHES				WEIGHT		VOL FT ³
	LP	B	W	H (LP/B)	H (W)	W	D	LBS		
L2CR1H2D2060	1761	1850	1970	19.94	20.5	60	20	199	22	
L2CR1H2D2066	1779	1880	2129	19.94	20.5	66	20	209	24	
L2CR1H2D2072	1890	2080	2181	19.94	20.5	72	20	220	26	
L2CR1H2D2460	1834	1926	2053	19.94	20.5	60	24	199	22	
L2CR1H2D2466	1849	1958	2215	19.94	20.5	66	24	209	24	
L2CR1H2D2472	1962	2162	2266	19.94	20.5	72	24	220	26	

L2CR2D1H • Credenza, 2 Door / 1 High File

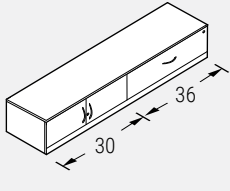

- Two locks included.
- Optional e-lock available in the vertical position for the file drawer. Please specify V - Vertical and add \$224 list.
- Optional e-lock available in the horizontal position. Please specify HR - Horizontal Right and add \$224 list.

PRODUCT CODE	FINISH			SIZE / INCHES				WEIGHT		VOL FT ³
	LP	B	W	H (LP/B)	H (W)	W	D	LBS		
L2CR2D1H2060	1761	1850	1970	19.94	20.5	60	20	199	22	
L2CR2D1H2066	1779	1880	2129	19.94	20.5	66	20	209	24	
L2CR2D1H2072	1890	2080	2181	19.94	20.5	72	20	220	26	
L2CR2D1H2460	1834	1926	2053	19.94	20.5	60	24	199	22	
L2CR2D1H2466	1849	1958	2215	19.94	20.5	66	24	209	24	
L2CR2D1H2472	1962	2162	2266	19.94	20.5	72	24	220	26	

L2CR1H2AD • Credenza, 1 High File / 2 Aluminum Door

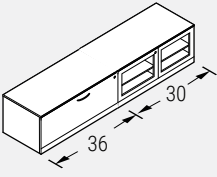

- Two locks included.
- One height adjustable shelf included.
- Door frame is anodized aluminum.
- Glazing is frosted acrylic.
- Doors standard with no handles.
- Optional e-lock available in the vertical position. Please specify V - Vertical and add \$224 list.
- E-locks not available for aluminum framed glass doors.

PRODUCT CODE	FINISH			SIZE / INCHES				WEIGHT		VOL FT ³
	LP	B	W	H (LP/B)	H (W)	W	D	LBS		
L2CR1H2AD2060	2236	2324	2449	19.94	20.5	60	20	181	20	
L2CR1H2AD2066	2294	2397	2643	19.94	20.5	66	20	190	22	
L2CR1H2AD2072	2402	2593	2696	19.94	20.5	72	20	200	24	
L2CR1H2AD2460	2308	2400	2527	19.94	20.5	60	24	181	20	
L2CR1H2AD2466	2364	2472	2729	19.94	20.5	66	24	190	22	
L2CR1H2AD2472	2478	2677	2783	19.94	20.5	72	24	200	24	

L2CR2AD1H • Credenza, 2 Aluminum Door / 1 High File

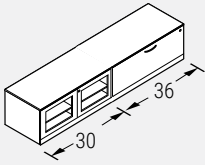

- Two locks included.
- One height adjustable shelf included.
- Door frame is anodized aluminum.
- Glazing is frosted acrylic.
- Doors standard with no handles.
- Optional e-lock available in the vertical position. Please specify V - Vertical and add \$224 list.
- E-locks not available for aluminum framed glass doors.

PRODUCT CODE	FINISH			SIZE / INCHES				WEIGHT		VOL FT ³
	LP	B	W	H (LP/B)	H (W)	W	D	LBS		
L2CR2AD1H2060	2236	2324	2449	19.94	20.5	60	20	181	20	
L2CR2AD1H2066	2294	2397	2643	19.94	20.5	66	20	190	22	
L2CR2AD1H2072	2402	2593	2696	19.94	20.5	72	20	200	24	
L2CR2AD1H2460	2308	2400	2527	19.94	20.5	60	24	181	20	
L2CR2AD1H2466	2364	2472	2729	19.94	20.5	66	24	190	22	
L2CR2AD1H2472	2478	2677	2783	19.94	20.5	72	24	200	24	

L2DSCR1H • Double Sided 1H Credenza Lateral

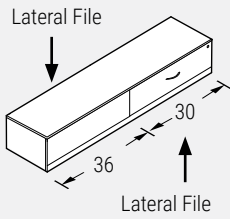

- Two locks included.
- Optional e-lock available in the vertical position. Please specify V - Vertical and add \$224 list.
- Credenzas require two e-locks.

PRODUCT CODE	FINISH			SIZE / INCHES				WEIGHT		VOL FT ³
	LP	B	W	H (LP/B)	H (W)	W	D	LBS		
L2DSCR1H2060	1961	2056	2124	19.94	20.5	60	20	196	22	
L2DSCR1H2066	2024	2127	2215	19.94	20.5	66	20	206	24	
L2DSCR1H2072	2085	2198	2305	19.94	20.5	72	20	217	26	
L2DSCR1H2460	2039	2138	2209	19.94	20.5	60	24	196	22	
L2DSCR1H2466	2102	2213	2302	19.94	20.5	66	24	206	24	
L2DSCR1H2472	2168	2285	2397	19.94	20.5	72	24	217	26	

L2CRBFBF • Credenza, BF / BF

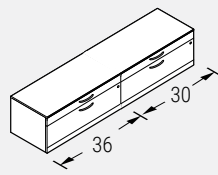

- Two locks included.
- Optional e-lock available in the vertical position. Please specify V - Vertical and add \$224 list.
- Credenzas require two e-locks.

PRODUCT CODE	FINISH			SIZE / INCHES				WEIGHT		VOL FT ³
	LP	B	W	H (LP/B)	H (W)	W	D	LBS		
L2CRBFBF2060	2225	2312	2349	19.94	20.5	60	20	218	20	
L2CRBFBF2066	2314	2409	2451	19.94	20.5	66	20	228	22	
L2CRBFBF2072	2352	2455	2499	19.94	20.5	72	20	239	24	
L2CRBFBF2460	2294	2383	2424	19.94	20.5	60	24	218	20	
L2CRBFBF2466	2387	2484	2527	19.94	20.5	66	24	228	22	
L2CRBFBF2472	2424	2530	2577	19.94	20.5	72	24	239	24	

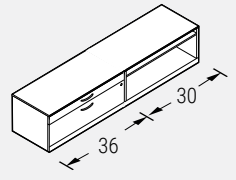
L2CRBFO • Credenza, BF / Open

- One lock included.
- One height adjustable shelf included.
- Optional e-lock available in the vertical position. Please specify V - Vertical and add \$224 list.

PRODUCT CODE	FINISH LP	B	W	SIZE/INCHES				D	WEIGHT LBS	VOL FT ³
				H(LP/B)	H(W)	W	D			
L2CRBFO2060	1728	1856	1948	19.94	20.5	60	20	202	20	
L2CRBFO2066	1802	1938	2047	19.94	20.5	66	20	220	22	
L2CRBFO2072	1912	2063	2149	19.94	20.5	72	20	254	24	
L2CRBFO2460	1799	1929	2026	19.94	20.5	60	24	202	20	
L2CRBFO2466	1873	2016	2129	19.94	20.5	66	24	220	22	
L2CRBFO2472	1988	2146	2235	19.94	20.5	72	24	254	24	

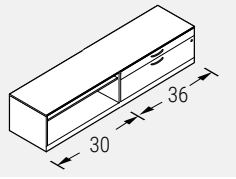
L2CROBF • Credenza, Open / BF

- One lock included.
- One height adjustable shelf included.
- Optional e-lock available in the vertical position. Please specify V - Vertical and add \$224 list.

PRODUCT CODE	FINISH LP	B	W	SIZE/INCHES				D	WEIGHT LBS	VOL FT ³
				H(LP/B)	H(W)	W	D			
L2CROBF2060	1728	1856	1948	19.94	20.5	60	20	202	20	
L2CROBF2066	1802	1938	2047	19.94	20.5	66	20	220	22	
L2CROBF2072	1912	2063	2149	19.94	20.5	72	20	254	24	
L2CROBF2460	1799	1929	2026	19.94	20.5	60	24	202	20	
L2CROBF2466	1873	2016	2129	19.94	20.5	66	24	220	22	
L2CROBF2472	1988	2146	2235	19.94	20.5	72	24	254	24	

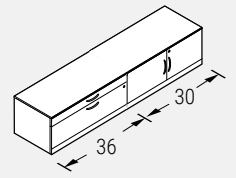
L2CRBF • Credenza, Box File / 2 Doors

- Two locks included.
- One height adjustable shelf included.
- Optional e-lock available in the vertical position for the file drawer. Please specify V - Vertical and add \$224 list.
- Optional e-lock available in the horizontal position. Please specify HR - Horizontal Right and add \$224 list.

PRODUCT CODE	FINISH LP	B	W	SIZE/INCHES				D	WEIGHT LBS	VOL FT ³
				H(LP/B)	H(W)	W	D			
L2CRBF2D2060	2045	2131	2254	19.94	20.5	60	20	214	20	
L2CRBF2D2066	2069	2173	2422	19.94	20.5	66	20	224	22	
L2CRBF2D2072	2181	2369	2472	19.94	20.5	72	20	235	24	
L2CRBF2D2460	2126	2218	2344	19.94	20.5	60	24	214	20	
L2CRBF2D2466	2154	2261	2517	19.94	20.5	66	24	224	22	
L2CRBF2D2472	2269	2464	2571	19.94	20.5	72	24	235	24	

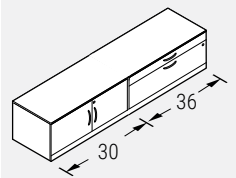
L2CR2DBF • Credenza, 2 Doors / Box File

- Two locks included.
- One height adjustable shelf included.
- Optional e-lock available in the vertical position for the file drawer. Please specify V - Vertical and add \$224 list.
- Optional e-lock available in the horizontal position. Please specify HR - Horizontal Right and add \$224 list.

PRODUCT CODE	FINISH LP	B	W	SIZE/INCHES				D	WEIGHT LBS	VOL FT ³
				H(LP/B)	H(W)	W	D			
L2CR2DBF2060	2045	2131	2254	19.94	20.5	60	20	214	20	
L2CR2DBF2066	2069	2173	2422	19.94	20.5	66	20	224	22	
L2CR2DBF2072	2181	2369	2472	19.94	20.5	72	20	235	24	
L2CR2DBF2460	2126	2218	2344	19.94	20.5	60	24	214	20	
L2CR2DBF2466	2154	2261	2517	19.94	20.5	66	24	224	22	
L2CR2DBF2472	2269	2464	2571	19.94	20.5	72	24	235	24	

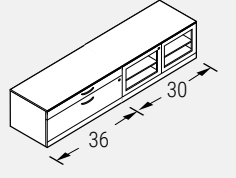
L2CRBF2AD • Credenza, Box File / 2 Aluminum Door

- Two locks included.
- One height adjustable shelf included.
- Door frame is anodized aluminum.
- Glazing is frosted acrylic.
- Doors standard with no handles.
- Optional e-lock available in the vertical position. Please specify V - Vertical and add \$224 list.
- E-locks not available for aluminum framed glass doors.

PRODUCT CODE	FINISH LP	B	W	SIZE/INCHES				D	WEIGHT LBS	VOL FT ³
				H(LP/B)	H(W)	W	D			
L2CRBF2AD2060	2518	2608	2728	19.94	20.5	60	20	214	20	
L2CRBF2AD2066	2586	2687	2935	19.94	20.5	66	20	224	22	
L2CRBF2AD2072	2696	2886	2988	19.94	20.5	72	20	235	24	
L2CRBF2AD2460	2618	2709	2836	19.94	20.5	60	24	214	20	
L2CRBF2AD2466	2692	2795	3054	19.94	20.5	66	24	224	22	
L2CRBF2AD2472	2804	3001	3106	19.94	20.5	72	24	235	24	

L2CR2ADBF • Credenza, 2 Aluminum Doors, Box File

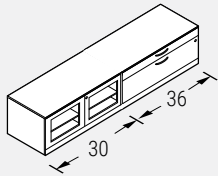

- Two locks included.
- One height adjustable shelf included.
- Door frame is anodized aluminum.
- Glazing is frosted acrylic.
- Doors standard with no handles.
- Optional e-lock available in the vertical position. Please specify V - Vertical and add \$224 list.
- E-locks not available for aluminum framed glass doors.

PRODUCT CODE	FINISH LP	B	W	SIZE/INCHES				D	WEIGHT LBS	VOL FT³
				H(LP/B)	H(W)	W	D			
L2CR2ADBF2060	2518	2608	2728	19.94	20.5	60	20	214	20	
L2CR2ADBF2066	2586	2687	2935	19.94	20.5	66	20	224	22	
L2CR2ADBF2072	2696	2886	2988	19.94	20.5	72	20	235	24	
L2CR2ADBF2460	2618	2709	2836	19.94	20.5	60	24	214	20	
L2CR2ADBF2466	2692	2795	3054	19.94	20.5	66	24	224	22	
L2CR2ADBF2472	2804	3001	3106	19.94	20.5	72	24	235	24	

L2CR2H2D • Credenza, 2 High File / 2 Door

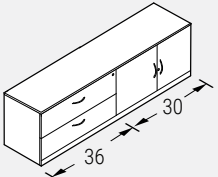

- Two locks included.
- Optional e-lock available in the vertical position for the file drawer. Please specify V - Vertical and add \$224 list.
- Optional e-lock available in the horizontal position. Please specify HR - Horizontal Right and add \$224 list.

PRODUCT CODE	FINISH LP	B	W	SIZE/INCHES				D	WEIGHT LBS	VOL FT³
				H(LP/B)	H(W)	W	D			
L2CR2H2D2060	2296	2453	2529	29	29.5	60	20	363	24	
L2CR2H2D2066	2390	2555	2640	29	29.5	66	20	374	26	
L2CR2H2D2072	2490	2642	2752	29	29.5	72	20	396	30	
L2CR2H2D2460	2388	2552	2632	29	29.5	60	24	363	24	
L2CR2H2D2466	2486	2657	2745	29	29.5	66	24	374	26	
L2CR2H2D2472	2592	2747	2862	29	29.5	72	24	396	30	

L2CR2D2H • Credenza, 2 Door / 2 High File

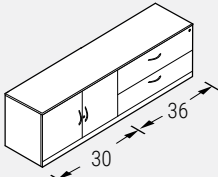

- Two locks included.
- Optional e-lock available in the vertical position for the file drawer. Please specify V - Vertical and add \$224 list.
- Optional e-lock available in the horizontal position. Please specify HR - Horizontal Right and add \$224 list.

PRODUCT CODE	FINISH LP	B	W	SIZE/INCHES				D	WEIGHT LBS	VOL FT³
				H(LP/B)	H(W)	W	D			
L2CR2D2H2060	2296	2453	2529	29	29.5	60	20	363	24	
L2CR2D2H2066	2390	2555	2640	29	29.5	66	20	374	26	
L2CR2D2H2072	2490	2642	2752	29	29.5	72	20	396	30	
L2CR2D2H2460	2388	2552	2632	29	29.5	60	24	363	24	
L2CR2D2H2466	2486	2657	2745	29	29.5	66	24	374	26	
L2CR2D2H2472	2592	2747	2862	29	29.5	72	24	396	30	

L2CR2H2H • Credenza, 2 High File / File

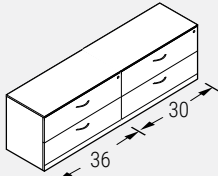

- Two locks included.
- Optional e-lock available in the vertical position. Please specify V - Vertical and add \$224 list.
- Credenzas require two e-locks.

PRODUCT CODE	FINISH LP	B	W	SIZE/INCHES				D	WEIGHT LBS	VOL FT³
				H(LP/B)	H(W)	W	D			
L2CR2H2H2060	2664	2756	2855	29	29.5	60	20	385	24	
L2CR2H2H2066	2757	2860	2961	29	29.5	66	20	407	26	
L2CR2H2H2072	2849	2960	3072	29	29.5	72	20	418	30	
L2CR2H2H2460	2769	2864	2970	29	29.5	60	24	385	24	
L2CR2H2H2466	2867	2974	3079	29	29.5	66	24	407	26	
L2CR2H2H2472	2962	3079	3193	29	29.5	72	24	418	30	

L2CR2D2D • Credenza, 2 High 4 Doors

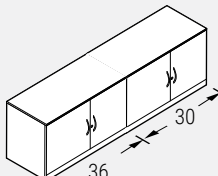

- Two locks included.
- Optional e-lock available in the horizontal position. Please specify HR - Horizontal Right and add \$224 list.
- Credenzas require two e-locks.

PRODUCT CODE	FINISH LP	B	W	SIZE/INCHES				D	WEIGHT LBS	VOL FT³
				H(LP/B)	H(W)	W	D			
L2CR2D2D2060	1935	2156	2215	29	29.5	60	20	341	24	
L2CR2D2D2066	2037	2242	2324	29	29.5	66	20	352	26	
L2CR2D2D2072	2140	2328	2438	29	29.5	72	20	363	30	
L2CR2D2D2460	2012	2245	2301	29	29.5	60	24	341	24	
L2CR2D2D2466	2119	2333	2421	29	29.5	66	24	352	26	
L2CR2D2D2472	2224	2422	2537	29	29.5	72	24	363	30	

L2CR4AD • Credenza, 2 High 4 Aluminum Doors

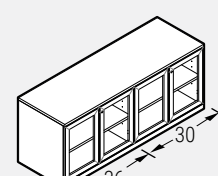

- Two locks included.
- Door frame is anodized aluminum.
- Glazing is frosted acrylic.
- Doors standard with no handles.
- E-lock not available for aluminum framed glass doors.

PRODUCT CODE	FINISH LP	B	W	SIZE/INCHES				D	WEIGHT LBS	VOL FT³
				H(LP/B)	H(W)	W	D			
L2CR4AD2060	3116	3340	3397	29	29.5	60	20	336	24	
L2CR4AD2066	3329	3533	3620	29	29.5	66	20	347	26	
L2CR4AD2072	3544	3730	3843	29	29.5	72	20	358	30	
L2CR4AD2460	3193	3424	3483	29	29.5	60	24	336	24	
L2CR4AD2466	3412	3625	3713	29	29.5	66	24	347	26	
L2CR4AD2472	3629	3825	3941	29	29.5	72	24	358	30	

LPSTC/LLSTC • Pedestal/Lateral Seat Cushion

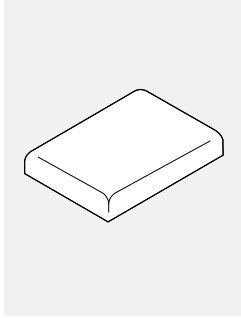

PRODUCT CODE	YRDS	SIZE/ INCHES			WEIGHT VOL	
		H	W	D	LBS	FT ³
LPSTC1518	0.75	2	15.5	18	2	0.34
LPSTC1520	0.75	2	15.5	20	2	0.40
LPSTC1523	0.75	2	15.5	23	3	0.44
LPSTC1524	0.75	2	15.5	24	3	0.46
LPSTC1529	1.00	2	15.5	29	3	0.55
LPSTC1530	1.00	2	15.5	30	3	0.24
LLSTC2030	1.00	2	20	30	5	0.76
LLSTC2036	1.25	2	20	36	6	0.91
LLSTC2230	1.00	2	22	30	6	0.84
LLSTC2236	1.25	2	22	36	7	1.01
LLSTC2430	1.00	2	24	30	6	0.91
LLSTC2436	1.25	2	24	36	7	1.10

PRODUCT CODE	PRICE																			
	GR1	GR2	GR3	GR4	GR5	GR6	GR7	GR8	GR9	GR10	GR11	GR12	GR13	GR14	GR15	GR16	GR17	GR18	GR19	GR20
LPSTC1518	196	226	245	272	314	353	389	422	463	503	557	633	703	779	944	1109	1274	1439	1604	1785
LPSTC1520	202	230	253	278	319	358	396	429	469	508	562	637	710	785	949	1114	1280	1444	1608	1790
LPSTC1523	206	233	256	283	323	361	399	435	472	513	565	640	715	789	955	1119	1285	1451	1613	1794
LPSTC1524	212	240	262	289	330	367	406	439	477	521	573	647	722	795	959	1123	1289	1455	1619	1801
LPSTC1529	259	296	326	360	414	466	518	562	613	668	737	839	936	1034	1256	1473	1696	1916	2134	2377
LPSTC1530	266	301	331	366	420	471	523	567	619	673	743	844	943	1041	1262	1481	1702	1923	2140	2383
LLSTC2030	281	318	345	383	437	488	536	585	636	691	760	860	958	1057	1279	1496	1720	1938	2156	2399
LLSTC2036	333	380	417	461	527	590	653	712	778	844	932	1057	1179	1304	1581	1852	2130	2402	2677	2981
LLSTC2230	286	322	353	386	441	493	541	589	639	694	763	866	965	1060	1284	1500	1724	1943	2160	2402
LLSTC2236	340	385	421	466	532	595	661	718	783	851	938	1062	1187	1309	1585	1860	2135	2409	2683	2987
LLSTC2430	289	326	355	389	443	495	546	591	641	697	767	868	967	1063	1286	1503	1726	1945	2165	2405
LLSTC2436	344	392	428	471	537	603	667	724	789	857	944	1069	1191	1315	1591	1865	2143	2417	2688	2991

LACWB • Counterweight Balance for use in Licence Storage Units

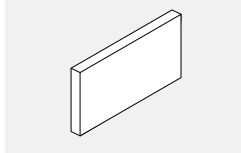

PRODUCT CODE	PRICE	SIZE/INCHES			WEIGHT LBS	VOL FT ³
		H	W	D		
LACWB	92	0.5	11.62	11.62	10	0.07

BHTP01 • Bracket to connect Licence Towers to Boulevard Panels

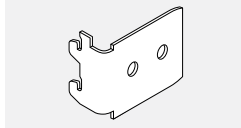

• Panel Frame Finish

PRODUCT CODE	PRICE	SIZE/ INCHES			WEIGHT VOL	
		H	W	D	LBS	FT ³
BHTP01	64	2	2.5	1	2	0.05

L2PO • Pantry Storage



Left Hand Shown

- The pull out cabinet serves as a multifunction, customizable storage unit that both defines space and enhances privacy in an open plan environment.
- Can be used in conjunction with Licence, Bridges, FreeFit and Boulevard.
- Internal organization consists of two fixed shelves top and bottom. The two middle shelves are adjustable. Two accessory rails are standard and will accept GC metal accessories
- Interior cabinet shelves and back are standard in Designer White. Cabinet shell, drawer and top can be specified in any standard laminate.
- L2PO-NL/R does not fit binders.
- Only available with FA handle.

Finish

While the Pantry Storage cabinet walls, top and pull-out drawer front door and back panel finish can be specified, the internal cabinet back and adjustable shelves are standard white. Please specify the cabinet top and pull-out drawer front finish.

Options

- Dual USB outlet kit - please add "USB" at the end of the code. Add \$377 to the list price
- When you specify dual USB outlet the top shelf will come with grey felt surface and grommet which allows for cable passage from the USB outlet (located below the top shelf). A two-prong power cord exits the cabinet through the floor at the back.
- Dry-erase marker board - Choose "DE" option. Please add \$266 to the list price. If specified the Dry-erase marker laminate will be applied to the external surface of the pull-out drawer side wall.

PRODUCT CODE	PRICE LP	SIZE/INCHES			H(LP/B)	H(W)	W	D	WEIGHT LBS	VOL FT ³
		B	W	D						
L2PO1224H42NL	1493	1511	1546	41.56	42	12	24	128	7	
L2PO1230H42NL	1568	1590	1631	41.56	42	12	30	143	9	
L2PO1236H42NL	1641	1668	1717	41.56	42	12	36	157	11	
L2PO1824H42NL	1716	1744	1790	41.56	42	18	24	156	11	
L2PO1830H42NL	1799	1833	1889	41.56	42	18	30	172	13	
L2PO1836H42NL	1881	1922	1987	41.56	42	18	36	187	16	
L2PO1224NL	1624	1640	1671	49.56	50	12	24	133	8	
L2PO1230NL	1702	1734	1760	49.56	50	12	30	148	10	
L2PO1236NL	1781	1827	1850	49.56	50	12	36	162	15	
L2PO1824NL	1885	1917	1950	49.56	50	18	24	161	12	
L2PO1830NL	1969	2022	2050	49.56	50	18	30	177	15	
L2PO1836NL	2055	2125	2149	49.56	50	18	36	192	18	
L2PO1224H54NL	1642	1659	1690	53.56	54	12	24	138	9	
L2PO1230H54NL	1720	1740	1760	53.56	54	12	30	153	11	
L2PO1236H54NL	1799	1823	1849	53.56	54	12	36	167	14	
L2PO1824H54NL	1904	1928	1970	53.56	54	18	24	166	14	
L2PO1830H54NL	1989	2020	2069	53.56	54	18	30	182	17	
L2PO1836H54NL	2075	2110	2168	53.56	54	18	36	197	20	
L2PO1224H42NR	1493	1511	1546	41.56	42	12	24	128	7	
L2PO1230H42NR	1568	1590	1631	41.56	42	12	30	143	9	
L2PO1236H42NR	1641	1668	1717	41.56	42	12	36	157	11	
L2PO1824H42NR	1716	1744	1790	41.56	42	18	24	156	11	
L2PO1830H42NR	1799	1833	1889	41.56	42	18	30	172	13	
L2PO1836H42NR	1881	1922	1987	41.56	42	18	36	187	16	
L2PO1224NR	1624	1640	1671	49.56	50	12	24	133	8	
L2PO1230NR	1702	1734	1760	49.56	50	12	30	148	10	
L2PO1236NR	1781	1827	1850	49.56	50	12	36	162	15	
L2PO1824NR	1885	1917	1950	49.56	50	18	24	161	12	
L2PO1830NR	1969	2022	2050	49.56	50	18	30	177	15	
L2PO1836NR	2055	2125	2149	49.56	50	18	36	192	18	
L2PO1224H54NR	1642	1659	1690	53.56	54	12	24	138	9	
L2PO1230H54NR	1720	1740	1760	53.56	54	12	30	153	11	
L2PO1236H54NR	1799	1823	1849	53.56	54	12	36	167	14	
L2PO1824H54NR	1904	1928	1970	53.56	54	18	24	166	14	
L2PO1830H54NR	1989	2020	2069	53.56	54	18	30	182	17	
L2PO1836H54NR	2075	2110	2168	53.56	54	18	36	197	20	

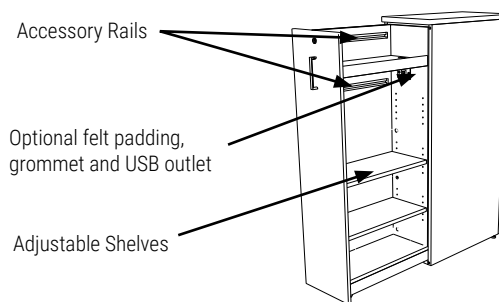
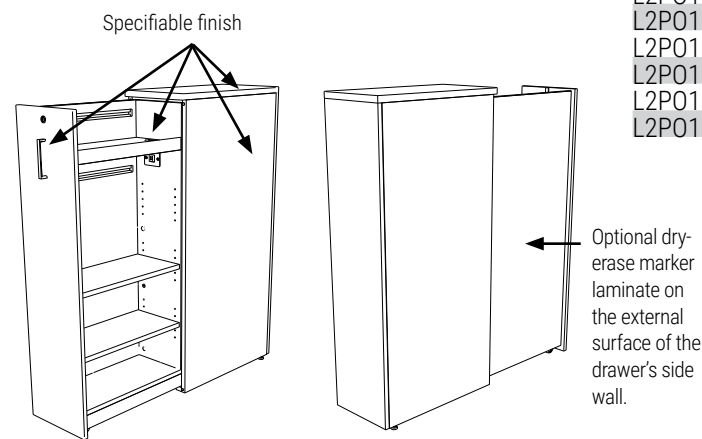

Integrated Accessory rails

Two accessory rails (each 18.25" long) are provided to further enhance customization with Global Contract metal accessories.

Upper Accessory Rail:

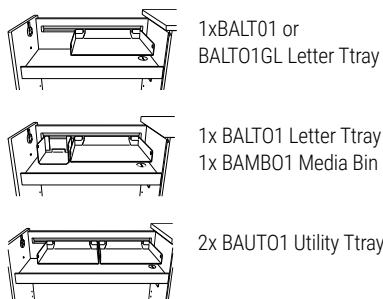

Lower Accessory Rail:

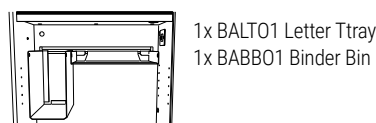
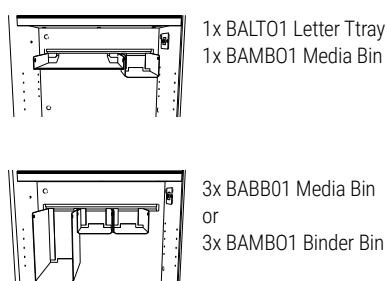

L2PW • Wardrobe Pantry Storage

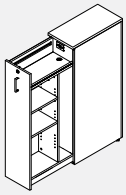

Left Hand Shown

- The pull out cabinet serves as a multifunction, customizable storage unit that both defines space and enhances privacy in an open plan environment.
- Can be used in conjunction with Licence,, FreeFit and Boulevard.
- Internal organization consists of one fixed shelf at the top. The two middle shelves are adjustable. Wardrobe includes coat hook.
- Interior cabinet shelves and back are standard in Designer White. Cabinet shell, drawer and top can be specified in any standard laminate.
- L2PW-NL/R does not fit binders.
- Only available with FA handle.

Finish

While the Pantry Storage cabinet walls, top and pull-out drawer front door and back panel finish can be specified, the internal cabinet back and adjustable shelves are standard white. Please specify the cabinet top and pull-out drawer front finish.

Options

- Dual USB outlet kit - please add "USB" at the end of the code. Add \$512 to the list price
- When you specify dual USB outlet the top shelf will come with grey felt surface and grommet which allows for cable passage from the USB outlet (located below the top shelf). A two-prong power cord exits the cabinet through the floor at the back.
- Dry-erase marker board - Choose "DE" option. Please add \$361 to the list price. If specified the Dry-erase marker laminate will be applied to the external surface of the pull-out drawer side wall.

PRODUCT CODE	PRICE			SIZE/INCHES				WEIGHT		VOL FT³
	LP	B	W	H (LP/B)	H (W)	W	D	LBS		
L2PW1224H42NL	1631	1649	1684	41.56	42	12	24	128	7	
L2PW1230H42NL	1706	1728	1769	41.56	42	12	30	143	9	
L2PW1236H42NL	1779	1806	1855	41.56	42	12	36	157	11	
L2PW1824H42NL	1889	1917	1963	41.56	42	18	24	156	11	
L2PW1830H42NL	1972	2006	2062	41.56	42	18	30	172	13	
L2PW1836H42NL	2054	2095	2160	41.56	42	18	36	187	16	
L2PW1224NL	1778	1794	1825	49.56	50	12	24	133	8	
L2PW1230NL	1856	1888	1914	49.56	50	12	30	148	10	
L2PW1236NL	1935	1981	2004	49.56	50	12	36	162	15	
L2PW1824NL	2078	2110	2143	49.56	50	18	24	161	12	
L2PW1830NL	2162	2215	2243	49.56	50	18	30	177	15	
L2PW1836NL	2248	2318	2342	49.56	50	18	36	192	18	
L2PW1224H54NL	1812	1829	1860	53.56	54	12	24	138	9	
L2PW1230H54NL	1890	1910	1930	53.56	54	12	30	153	11	
L2PW1236H54NL	1969	1993	2019	53.56	54	12	36	167	14	
L2PW1824H54NL	2118	2142	2184	53.56	54	18	24	166	14	
L2PW1830H54NL	2203	2234	2283	53.56	54	18	30	182	17	
L2PW1836H54NL	2289	2324	2382	53.56	54	18	36	197	20	
L2PW1224H42NR	1493	1511	1546	41.56	42	12	24	128	7	
L2PW1230H42NR	1706	1728	1769	41.56	42	12	30	143	9	
L2PW1236H42NR	1779	1806	1855	41.56	42	12	36	157	11	
L2PW1824H42NR	1854	1882	1928	41.56	42	18	24	156	11	
L2PW1830H42NR	1972	2006	2062	41.56	42	18	30	172	13	
L2PW1836H42NR	2054	2095	2160	41.56	42	18	36	187	16	
L2PW1224NR	1778	1794	1825	49.56	50	12	24	133	8	
L2PW1230NR	1856	1888	1914	49.56	50	12	30	148	10	
L2PW1236NR	1935	1981	2004	49.56	50	12	36	162	15	
L2PW1824NR	2078	2110	2143	49.56	50	18	24	161	12	
L2PW1830NR	2162	2215	2243	49.56	50	18	30	177	15	
L2PW1836NR	2248	2318	2342	49.56	50	18	36	192	18	
L2PW1224H54NR	1812	1829	1860	53.56	54	12	24	138	9	
L2PW1230H54NR	1890	1910	1930	53.56	54	12	30	153	11	
L2PW1236H54NR	1969	1993	2019	53.56	54	12	36	167	14	
L2PW1824H54NR	2118	2142	2184	53.56	54	18	24	166	14	
L2PW1830H54NR	2203	2234	2283	53.56	54	18	30	182	17	
L2PW1836H54NR	2289	2324	2382	53.56	54	18	36	197	20	

Specifiable finish

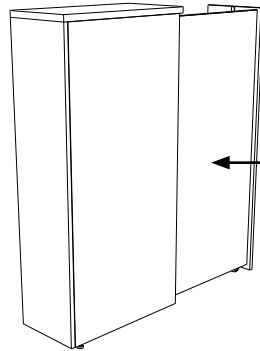
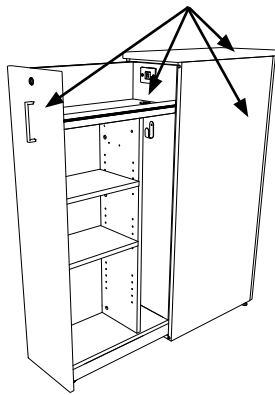

Optional dry-erase marker laminate on the external surface of the drawer's side wall.

Optional felt padding, grommet and USB outlet

Coathook

Adjustable Shelves

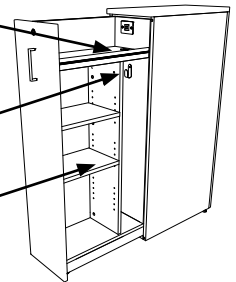

L2CT • Collaboration Tables with Integrated Wire Management

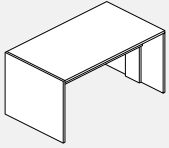

- Units Shipped knocked down (KD)
- Footrest to be ordered separately.
- Add "FR" to the end of the code for a footrail and add \$1,890 to the list price.
- Foot rail kit will include a quantity of two 2" diameter rails and 4 flanges.
- "W" thick (1 7/16") top and gables.
- Low pressure modesty panel.

Standard Grommet Location:

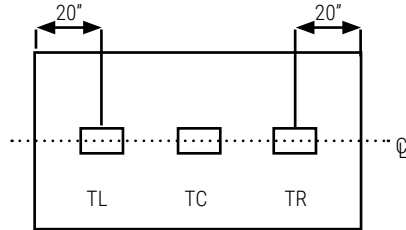

Please see Accessories Section for power grommets.

Half Modesty at 15" high.

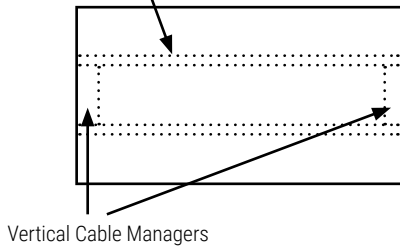

Vertical Cable Managers

PRODUCT CODE	FINISH "W"	H(W)	W	D	WEIGHT LBS	VOL FT ³
L2CT3060H29	1690	29.5	60	30	171	13
L2CT3066H29	1761	29.5	66	30	180	14
L2CT3072H29	1836	29.5	72	30	189	15
L2CT3078H29	1905	29.5	78	30	198	16
L2CT3084H29	1981	29.5	84	30	207	18
L2CT3096H29	2126	29.5	96	30	216	20
L2CT3060H36	1791	36	60	30	176	19
L2CT3066H36	1866	36	66	30	185	21
L2CT3072H36	1938	36	72	30	194	23
L2CT3078H36	2011	36	78	30	203	24
L2CT3084H36	2085	36	84	30	212	26
L2CT3096H36	2231	36	96	30	221	30
L2CT3060H42	1936	42	60	30	181	25
L2CT3066H42	2011	42	66	30	190	28
L2CT3072H42	2083	42	72	30	199	30
L2CT3078H42	2156	42	78	30	208	33
L2CT3084H42	2230	42	84	30	217	35
L2CT3096H42	2375	42	96	30	226	40
L2CT3660H29	1896	29.5	60	36	180	15
L2CT3666H29	1978	29.5	66	36	189	17
L2CT3672H29	2058	29.5	72	36	198	18
L2CT3678H29	2140	29.5	78	36	207	20
L2CT3684H29	2220	29.5	84	36	216	21
L2CT3696H29	2383	29.5	96	36	225	24
L2CT3660H36	2020	36	60	36	185	23
L2CT3666H36	2098	36	66	36	194	25
L2CT3672H36	2181	36	72	36	203	27
L2CT3678H36	2262	36	78	36	212	29
L2CT3684H36	2344	36	84	36	221	32
L2CT3696H36	2507	36	96	36	230	36
L2CT3660H42	2185	42	60	36	190	30
L2CT3666H42	2264	42	66	36	199	33
L2CT3672H42	2346	42	72	36	208	36
L2CT3678H42	2427	42	78	36	217	39
L2CT3684H42	2510	42	84	36	226	42
L2CT3696H42	2671	42	96	36	235	48
L2CT4260H29	2102	29.5	60	42	189	18
L2CT4266H29	2192	29.5	66	42	198	19
L2CT4272H29	2281	29.5	72	42	207	21
L2CT4278H29	2369	29.5	78	42	216	23
L2CT4284H29	2460	29.5	84	42	225	25
L2CT4296H29	2638	29.5	96	42	234	28
L2CT4260H36	2246	36	60	42	194	26
L2CT4266H36	2335	36	66	42	203	29
L2CT4272H36	2424	36	72	42	212	32
L2CT4278H36	2514	36	78	42	221	34
L2CT4284H36	2603	36	84	42	230	37
L2CT4296H36	2783	36	96	42	239	42
L2CT4260H42	2430	42	60	42	199	35
L2CT4266H42	2519	42	66	42	208	39
L2CT4272H42	2611	42	72	42	217	42
L2CT4278H42	2698	42	78	42	226	46
L2CT4284H42	2787	42	84	42	235	49
L2CT4296H42	2966	42	96	42	244	56

L2CTV • Collaboration Tables with Media Wall Integrated Wire Management

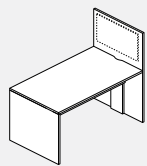

- Units Shipped knocked down (KD)
- Footrest to be ordered separately.
- Add "FR" to the end of the code for a foot rail and add \$1,890 to the list price.
- Foot rail kit will include a quantity of two 2" diameter rails and 4 flanges.
- Unit includes TV/Display bracket & mounting hardware.
- "W" thick (1 7/16") top and gables.
- Low pressure modesty panel.

Standard Grommet Location:

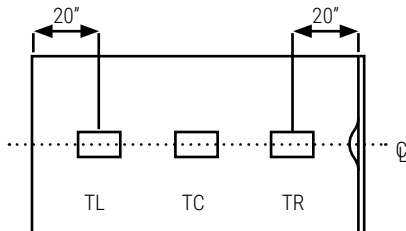

Please see Accessories Section for power grommets.

Half Modesty at 15" high.

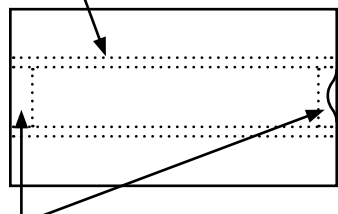

Vertical Cable Managers

PRODUCT CODE	FINISH "W"	H(W)	W	D	WEIGHT LBS	VOL FT ³
L2CTV4260H29H66	3110	29.5	60	42	192	18
L2CTV4266H29H66	3199	29.5	66	42	201	19
L2CTV4272H29H66	3288	29.5	72	42	210	21
L2CTV4278H29H66	3377	29.5	78	42	219	23
L2CTV4284H29H66	3464	29.5	84	42	228	25
L2CTV4296H29H66	3648	29.5	96	42	237	28
L2CTV4860H29H66	3377	29.5	60	48	198	20
L2CTV4866H29H66	3475	29.5	66	48	207	22
L2CTV4872H29H66	3572	29.5	72	48	216	24
L2CTV4878H29H66	3669	29.5	78	48	225	26
L2CTV4884H29H66	3769	29.5	84	48	234	28
L2CTV4896H29H66	3960	29.5	96	48	243	32
L2CTV4260H36H72	3253	36	60	42	197	26
L2CTV4266H36H72	3343	36	66	42	206	29
L2CTV4272H36H72	3432	36	72	42	215	32
L2CTV4278H36H72	3521	36	78	42	224	34
L2CTV4284H36H72	3609	36	84	42	233	37
L2CTV4296H36H72	3788	36	96	42	242	42
L2CTV4860H36H72	3540	36	60	48	203	30
L2CTV4866H36H72	3637	36	66	48	212	33
L2CTV4872H36H72	3737	36	72	48	221	36
L2CTV4878H36H72	3835	36	78	48	230	39
L2CTV4884H36H72	3929	36	84	48	239	42
L2CTV4896H36H72	3632	36	96	48	248	48
L2CTV4260H42H72	3367	42	60	42	202	35
L2CTV4266H42H72	3455	42	66	42	211	39
L2CTV4272H42H72	3544	42	72	42	220	42
L2CTV4278H42H72	3666	42	78	42	229	46
L2CTV4284H42H72	3724	42	84	42	238	49
L2CTV4296H42H72	3934	42	96	42	247	56
L2CTV4860H42H72	3663	42	60	48	208	40
L2CTV4866H42H72	3760	42	66	48	217	44
L2CTV4872H42H72	3859	42	72	48	226	48
L2CTV4878H42H72	3956	42	78	48	235	52
L2CTV4884H42H72	4055	42	84	48	244	56
L2CTV4896H42H72	4248	42	96	48	253	64