

# think global

## THE GLOBAL EDGE

### ERGONOMICS IN THE OFFICE

- Full range of ergonomically designed workplace, healthcare and office furniture with competitive pricing and built-in value.

### STRENGTH AND STABILITY

- Established in 1966.
- One of North America's largest office furniture manufacturers.
- Manufacturing and showrooms worldwide.

### QUICK SHIP PROGRAM

- Global's Quick Ship program offers the most comprehensive product offering across Canada.
- While we offer many additional products in a wide array of styles and colors, many items will be available to ship to you in as little as ten days.

### STRONG LOCAL REPRESENTATION

- Service and expert advice where you are, when you need it!

### MANUFACTURING CAPABILITY

- Vertical integration ensures "start to finish" control.
- Ongoing research and investment in new, innovative production technology.

### QUALITY ASSURANCE

- The quality program is registered to ISO 9001.
- On-site furniture testing facility.
- Products and components are tested to meet or exceed ANSI/BIFMA standards.
- Products backed by Global's Limited Lifetime Warranty.

### ENVIRONMENTAL COMMITMENT

- Continuous development of "earth friendly" programs.
- One of the first molded foam manufacturers to create ozone-friendly, CFC and HFC-free processes.
- Many seat and back pans are made from recyclable plastics and wood waste, enabling little waste and cost effective products.

## SYMBOL IDENTIFICATION

Each seating product with an RTA code identifies the assembly requirements.

**RTA 00** FULLY ASSEMBLED

**RTA 1** SIMPLE ASSEMBLY (no tools required)

- Parts to install:
- casters
  - base
  - pneumatic cylinder/cover can

**RTA 2** MODEST ASSEMBLY (tools supplied, if necessary)

- Parts to install:
- casters
  - base
  - pneumatic cylinder/cover can
  - back

**RTA 4** MODERATE ASSEMBLY (tools supplied)

- Parts to install:
- casters
  - base
  - pneumatic cylinder/cover can
  - back
  - armrest

**RTA 8** FULL ASSEMBLY (tools supplied)

- Parts to install:
- casters
  - base
  - pneumatic cylinder/cover can
  - back
  - armrest
  - mechanism



All products with this designation are suitable for courier shipment throughout Canada.

# TABLE OF CONTENTS

## A

Academic Task .....	362
Accord (Global Accord).....	33
Arm selections .....	353
Arturo .....	20
Aspen .....	21
Auburn.....	22
Aurora.....	23

## B

Bakhita .....	113
Ballara .....	224
Beach.....	116
Beam Seating.....	117
Braden .....	235

## C

Calidon .....	239
Camino .....	240
Caprice .....	125
Caster selections.....	356
Chap .....	127
Citi .....	245
Citi Square.....	249
Comet .....	129
Concorde .....	24
Concorde Executive 24HR .....	339

## D

Diplomat.....	131
Drift .....	258
Duet.....	132
Duet Beam.....	122

## E

Echo.....	25
Enterprise.....	26
Erin .....	148

## F

Factor.....	28
File Buddy.....	149
Flap.....	150

## G

G1 Ergo Select.....	30
G1 Ergo Select TS .....	340
G20.....	32
Global Accord.....	33
Granada.....	37
Granada TS.....	335
Granada Deluxe.....	39
Granada Deluxe TS .....	335
Granada with Schukra Lumbar.....	43
Graphic.....	44

## I

Industrial .....	364
Islands .....	152

## J

Jeo.....	269
----------	-----

## K

Kate .....	272
Key.....	153

## L

Layne.....	154
Lite.....	156
Locust.....	160
Loover.....	46
Luray.....	50
Lux.....	273

## M

Malaga .....	53
Malaga TS.....	336
Marche .....	161
Mayne .....	163
ML .....	275
ML Park .....	277
Moda .....	164

## N

Noetic.....	54
Novello.....	58

## O

ObusForme .....	61
ObusForme Comfort .....	62
ObusForme Comfort TS.....	337
ObusForme Comfort XL .....	342

## P

Popcorn.....	167
Popcorn Beam .....	124
Prairie .....	278
Prefer.....	65

## R

Rebound .....	172
River .....	279
River+ .....	293
Robust .....	347
Roma .....	67
Roma Nester .....	176

## S

Sas.....	178
Saxon.....	348
Score .....	71
Sidero .....	180
Sidero Beam .....	124
Sirena .....	316
Solar.....	73
Solo .....	75
Sonic.....	184
Sonic Beam .....	121
Sora .....	77
Spritz Task .....	83
Spritz Multi-Purpose & Nesting.....	199
Spyker.....	203
Stream.....	79, 204
Supra .....	84
Supra-X.....	86
Synopsis .....	89

## T

Traditional .....	92
Tritek Ergo Select .....	94
Triumph.....	96
Truform .....	97
Truform TS.....	337
Twilight.....	212
Tye .....	100

## V

Venture.....	319
Vion .....	102
Vion Beam .....	120
Vion TS .....	349
Vitrola.....	322

## W

Wind Seating .....	324
Wind Tables .....	326
Wind Linear Seating .....	328
Wind Linear Tables .....	332

## Y

Yorkdale.....	109
Yorkdale TS .....	338

## Z

Zoma.....	222
-----------	-----

## REFERENCES / PROGRAMS

How to order seating .....	4
Seating by category type .....	5
Ergonomic features and benefits.....	15
Mechanism adjustments.....	16
Arm selections .....	353
Caster selections.....	356
Glide selections - Duet and Popcorn .....	357
Base selections .....	358
Cylinder selections.....	360
Industrial caster selections.....	374
COM/GPM authorization form .....	379
Specialty seating.....	361
Textiles and Finishes .....	375
Metal leg, frame + base finish chart.....	378
Terms and Conditions.....	380
Limited Lifetime Warranty .....	383
Index.....	384

# HOW TO ORDER SEATING



**2676-2**

MODEL NUMBER

+



**TC74**

FABRIC CODE

+



**AMF**

ALUMINUM BASE + MEMORY FOAM

+



**CX**

CASTERS

+



**VU19**

MESH CODE

+



**4L**

CYLINDER

## FABRIC CHAIR EXAMPLE

If there are any options for the chair they would be inserted between the model number and frame finish. For example (see above):

### 2676-2 TC74 AMF CX VU19 4L

This would be the Global Accord Mesh HB Knee-Tilter **2676-2**. The seat is upholstered in Terrace, Echo (**TC74**) with a mesh back in Vue, Coal Black (**VU19**). The chair has fixed arms, optional aluminum base + memory foam seat (**AMF**), dual wheel carpet casters (**CX**) and a 4" cylinder, low rise (**4L**).

## CHAIR SAFETY TIPS











### Common sense guidelines to ensure that your Global chair will provide many years of comfort and service in a safe and productive environment:

- Always read and follow assembly instructions. Make sure that all the pieces of your Global chair are installed in the proper order to ensure structural integrity.
- Ensure that chair casters are fully inserted into the base of the unit.
- Inspect your chair for loose or worn parts at least once a year.
- Always keep the base of your chair completely on the floor.
- Most Global chairs are equipped with casters for use on carpeted surfaces. Other flooring surfaces may require different casters.
- Speak to your Global sales representative or refer to the Arm, Caster and Base section (page 351) of this price book for appropriate custom selections.
- Many Global office chairs are equipped with tilt tension controls on the seating mechanism. The tension control compensates for different body weights and postures. Always ensure that the control is properly adjusted for a smooth and controlled tilt motion. Your Global sales representative can demonstrate the proper use of all the adjustments on your office chair.
- Do not stand on your Global chair or sit on the arms of your chair.
- Do not put electrical appliances on chairs. Even fire retardant fabrics can be damaged when exposed to direct heat or flame.
- Choose the right chair for your work environment. Global offers a full line of intensive use, multi-shift and specialized chairs for environments with demanding health or safety requirements. Your Global sales representative is trained to help you make the right choice for your workplace.



**WORK / TASK SEATING**

**Task**





	Aspen.....21		Luray.....50		Spritz.....83
	Aurora.....23		Noetic.....54		Spritz Multi-Purpose.....199
	Echo.....25		Novello.....58		Stream.....79
	Enterprise.....26		ObusForme.....61		Supra-X.....86
	Factor.....28		ObusForme Comfort.....62		Synopsis.....89
	G1 Ergo Select.....30		Prefer.....65		Tritek Ergo Select.....94
	G20.....32		Robust.....347		Triumph.....96
	Granada.....37		Roma.....67		Truform.....97
	Granada Deluxe.....39		Score.....71		Tye.....100
	Granada with Schukra Lumbar.....43		Solar.....73		Vion.....102
	Graphic.....44		Sonic.....184		Yorkdale.....109
	Loover.....46		Sora.....77		

# SEATING BY CATEGORY TYPE

## Conference / Management

	Accord (Global Accord).....33
	Arturo.....20
	Aurora.....23
	Enterprise.....26
	Global Accord.....33
	Graphic.....44
	Kate.....272



	Luray.....50
	Novello.....58
	ObusForme Comfort.....62
	Prefer.....65
	Roma.....67
	Solar.....73
	Solo.....75

	Supra.....84
	Synopsis.....89
	Traditional.....92
	Tye.....100

## Executive

	Accord (Global Accord).....33
	Arturo.....20
	Auburn.....22
	Concorde.....24

	Global Accord.....33
	Luray.....50
	ObusForme Comfort.....62
	Robust.....347

	Traditional.....92
	Triumph.....96

Height Adjustable Stools



Factor .....28



File Buddy.....149



Global Accord.....33



Granada.....37



Granada Deluxe .....39



Graphic.....45



Loover.....46



Noetic.....56



Novello.....60



Prefer.....65



Roma.....67



Solar.....73



Spritz .....201



Stream.....79



Supra-X .....86



Tritek Ergo Select.....94



Truform .....97



Vion .....105

# SEATING BY CATEGORY TYPE



## MULTI-PURPOSE SEATING

### Stacking



Bakhita.....113



Key.....153



Rebound.....172



Spyker.....203



Comet.....129



Locust.....160



Sas.....178



Stream.....204



Duet.....132



Moda.....165



Sidero.....180



Zoma.....222



Flap.....150



Popcorn.....167



Sonic.....184

### Guest (Metal)



Aurora.....23



Kate.....272



Rebound.....172



Synopsis.....89



Caprice.....125



Key.....153



Sas.....178



Twilight.....212



Comet.....129



Lite.....156



Sidero.....180



Tye.....100



Diplomat.....131



Locust.....160



Solo.....75



Vion.....216



Enterprise.....26



Marche.....161



Sonic.....184



Erin.....148



Moda.....164



Stream.....204



Granada Deluxe.....39



ObusForme Comfort....62



Supra.....84



**Guest (Wood)**



Beach .....116



Chap .....127



Erin .....148



Islands .....152



Layne .....154



Mayne .....163



Traditional .....92



Twilight .....212

**Horizontal Nesting**



Roma Nester .....176



Spritz .....200

**Tandem / Beam / Pedestal**



Beam Seating .....117



Duet Beam .....122



Duet (pedestal) .....142



Global Accord (pedestal) .....34



Luray (pedestal) .....51



Novello (pedestal) .....58



Popcorn Beam .....124



Sidero Beam .....124



Sonic Beam .....121



Sonic (pedestal) .....196



Spritz (pedestal) .....200



Stream (pedestal) .....79



Synopsis (pedestal) .....90

















Vion Beam .....120



Vion (pedestal) .....103



















# SEATING BY CATEGORY TYPE

## Stools

	Bakhita.....114		Marche.....161		Sidero.....180
	Caprice.....125		ML.....275		Sonic.....184
	Diplomat.....131		Popcorn.....167		Stream.....204
	Duet.....132		Rebound.....172		Twilight.....212
	File Buddy.....149		Sas.....178		Vion.....216



## LOUNGE SEATING

	Ballara.....224		Jeo.....269		River+.....293
	Braden.....235		Kate.....272		Sirena.....316
	Calidon.....239		Lux.....273		Venture.....319
	Camino.....240		ML.....275		Vitrola.....322
	Citi.....245		ML Park.....277		Wind/Wind Linear.....324
	Citi Square.....249		Prairie.....278		
	Drift.....258		River.....279		



**HEAVY DUTY / 24HR SEATING**



Concorde Executive 24HR.....339



G1 Ergo Select TS.....340



Granada TS .....335



Granada Deluxe TS.....335



Malaga TS.....336



ObusForme Comfort TS.....337



ObusForme Comfort XL.....342



Robust.....347



Saxon .....348



Truform TS.....337



Vion TS.....349



Yorkdale TS.....338



**SPECIALTY SEATING**



Academic Task.....362



Industrial - 50.....365



Industrial Anti-Microbial - 62 .....370



Industrial Wipe Down - 64.....371



















Sidero (children's model) .....182

# SEATING BY CATEGORY TYPE



## EDUCATION















### Classroom Seating

	Academic Task .....362		Moda .....165		Spritz .....199
	Duet .....132		Popcorn .....167		Stream .....204
	Flap .....150		Rebound .....172		Supra-X .....86
	Graphic .....44		Roma Nester .....176		Vion .....102
	Noetic .....54		Sidero .....180		
	Novello .....58		Sonic .....184		

### Work + Task Seating

	Factor .....28		ObusForme Comfort .....62		Stream .....79
	Granada Deluxe .....39		Prefer .....65		Supra-X .....86
	Graphic .....44		Roma .....67		Tritek Ergo Select .....94
	Loover .....46		Solar .....73		Truform .....97
	Novello .....58		Spritz .....83		Vion .....102

### Guest Seating

	Beach .....116		Flap .....150		Sidero .....180
	Caprice .....125		Islands .....152		Sonic .....184
	Chap .....127		Moda .....164		Vion .....102
	Duet .....132		Rebound .....172		Zoma .....222
	Erin .....148		Roma .....176		

Lecture Hall Seating



Beam Seating.....117



Popcorn Beam.....124



Sonic Beam.....121



Duet Beam.....122



Sidero Beam.....124



Vion Beam.....120

Lab Seating + Stools



Caprice.....125



Novello.....60



Spritz.....201



Duet.....132



Rebound.....172



Stream.....204



Graphic.....45



Sidero.....180



Supra-X.....86



Noetic.....56



Sonic.....184



Vion.....105

Cafeteria Seating



Bakhita.....113



Popcorn.....167



Spyker.....203



Duet.....132



Rebound.....172



Stream.....204



Flap.....150



Sonic.....184

Lounge Seating



Ballara.....224



Drift.....258



Sirena.....316



Camino.....240



ML Park.....277



Venture.....319



Citi.....245



River.....279



Wind/Wind Linear.....324



Citi Square.....249



River+.....293

# SEATING BY CATEGORY TYPE

## Stacking + Nesting Chairs



Bakhita .....113



Duet .....132



Flap .....150



Moda .....165



Popcorn .....167



Rebound .....172



Roma .....176



Sidero .....180



Sonic .....184



Spritz .....200



Spyker .....203



Stream .....204



Zoma .....222

EACH GLOBAL CHAIR IS BUILT WITH FEATURES THAT ARE ERGONOMICALLY DESIGNED TO PROMOTE GOOD POSTURE AND PROVIDE MAXIMUM COMFORT. WHILE FULLY SUPPORTING YOUR BODY, THESE FEATURES SHOULD ALSO ALLOW YOU TO ADJUST YOUR CHAIR TO FIT YOU.



## A TENSION ADJUSTMENT

Increase or decrease to match body weight. Allows you to rock comfortably, without heavy pushing, reducing muscle fatigue.



## B CHAIR TILT LOCK

Lock the tilt movement in position(s) to accommodate your working posture. Allows you to lock your chair in a comfortable and supportive position. (Can be either single position, multiple position or infinite position.)



## C SEAT HEIGHT

Raise or lower to allow your feet to rest flat on the floor. Avoids pressure under your thighs, easing blood flow.



## D BACK/LUMBAR HEIGHT ADJUSTMENT

Raise or lower to position lumbar support in your lumbar area. Reduces likelihood of back pain.



## E SEAT DEPTH

Change the depth of the seat to accommodate the length of your thighs. Keeps your back in contact with the backrest while avoiding pressure behind your knees. Can be sliding (MD) or manual.



## F SEAT ANGLE ADJUSTMENT

Allows chair to tilt forward changing the angle of your thighs in relation to the floor. Helps reduce disc pressure during forward leaning tasks.



## G BACK ANGLE ADJUSTMENT

Adjust to change the angle of your torso in relation to your thighs. Helps reduce disc pressure and relaxes your back muscles.



## H ARM HEIGHT

Raise or lower to support your forearms. Reduces muscular effort in neck and shoulders, minimizing risk of pain.



## J KNEE-TILT MOVEMENT

Chair tilt pivot point is toward the front of the seat. Stability is maintained as the user reclines, keeping their feet on the floor and maintaining the same torso to thigh angle.



## L SYNCHRO-TILT MOVEMENT

The seat pivots at the center point, while the backrest reclines at a faster rate than the seat, increasing the angle between the user's torso and thighs. Enhances comfort and encourages dynamic body movement.



## M WATERFALL SEAT EDGE

Reduces pressure at the back of your knees, contributing to good blood flow.



## N CONTOURED CUSHION

Supports the body effectively, allowing you to sit longer without discomfort.



## P VIBRATING SEAT & BACK

Soothing effect contributes to your relaxation during work breaks.



## Q WIDTH ADJUSTABLE ARMS

Allows outward movement of armrests to match shoulder breadth. Ensures armrests properly support forearms, reducing muscular efforts in neck and shoulders.

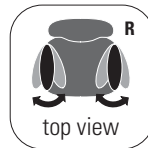

## R ARM ROTATION

Rotate armcaps to support your forearms in various positions. Reduces muscular effort in neck and shoulders minimizing risk of pain.



## S CENTER TILT

Chair tilts at the center point of the seat allowing you to recline while maintaining the same torso to thigh angle. When your feet are well supported, blood flow is enhanced.



## U SOFT DESCENT PNEUMATIC LIFT

Gently and gradually lowering the seat helps you easily select proper seat height without causing a jerking motion.



## V LUMBAR DEPTH ADJUSTMENT

Increase or decrease curvature of the back to match the profile of your lower back. Enhances comfort and support in the lower lumbar area.

## MAXIMIZING YOUR ERGONOMIC SEATING

- Always select a chair that is designed for the type of work you perform and make certain the chair is comfortable for the length of time spent using it.
- Ensure that the seat and back cushions are contoured to fit your body, which will help eliminate pressure points.
- An ergonomically designed chair should allow changing positions easily.
- As you work, reposition yourself throughout the day to reduce strain and stress on specific muscle groups. If you change job functions, adjust your chair to fit the new task.
- Proper ergonomic seating should help eliminate many of the work related injuries that result from poor posture and poorly designed chairs.

**TASK**



**ADJUSTMENTS**

- (2) Pneumatic seat height
- (8) Manual seat depth
- Back/lumbar height \*\*
- Swivel

**POSTURE TASK**



**ADJUSTMENTS**

- (2) Pneumatic seat height
- (3) Back angle
- (6) Back/lumbar height \*\*
- Seat depth \*
- Swivel

**TILTER**



**ADJUSTMENTS**

- (1) Tilt tension
- (2) Pneumatic seat height
- (9) Multiple position tilt lock \*
- Center tilt action
- Swivel

**KNEE-TILTER**



**ADJUSTMENTS**

- (1) Tilt tension
- (2) Pneumatic seat height
- (9) Multiple position tilt lock \*
- Knee tilt action
- Swivel
- Optional sliding seat depth adjustment (MD)
- Anti kick back

**MULTI-TILTER**



**ADJUSTMENTS**

- (1) Tilt tension
- (2) Pneumatic seat height
- (3) Back angle adjustment
- (4) Seat angle
- (8) Sliding seat depth adjustment (MD)
- (9) Infinite position tilt lock
- Back/lumbar height \*\*
- Center tilt action
- Swivel

**SYNCHRO-TILTER**



**ADJUSTMENTS**

- (1) Tilt tension
- (2) Pneumatic seat height
- (3) Back angle adjustment \*
- (8) Sliding seat depth adjustment (MD)
- (9) Multiple position tilt lock/ synchro tilt action
- Anti kick back \*
- Back/lumbar height \*\*
- Swivel

**POSTURE-TILTER**

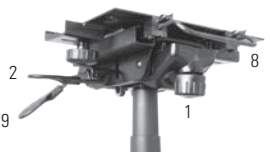

**ADJUSTMENTS**

- (1) Tilt tension
- (2) Pneumatic seat height
- (8) Sliding seat depth adjustment (MD)
- (9) Infinite position tilt lock
- Back/lumbar height \*\*
- Swivel

**FUNCTION-TILTER**



**ADJUSTMENTS**

- (1) Tilt tension
- (2) Pneumatic seat height
- (3) Back angle \*
- (9) Upright position tilt lock
- Back/lumbar height \*\*
- Swivel

**OPERATOR**



**ADJUSTMENTS**

- (2) Pneumatic seat height
- (3) Back angle \*(free float/lock)
- (4) Seat angle \*(free float/lock)
- Back/lumbar height \*\*
- With single lever operator mechanism, seat and back angle are controlled using lever 4 \*
- Swivel

**SYNCHRO KNEE-TILTER**



**ADJUSTMENTS**

- (1) Tilt tension
- (2) Pneumatic seat height
- (9) Multiple position tilt lock
- Back/lumbar height \*
- Synchro tilt action
- Anti kick back
- Knee tilt action
- Swivel

**SYNCHRO GLIDER**



**ADJUSTMENTS**

- (1) Tilt tension, dial
- (2) Pneumatic seat height
- (3) Back angle \*
- (8) Sliding seat depth adjustment (MD)
- (9) Multiple position tilt lock
- Back/lumbar height \*\*
- Swivel

- NOTES**
- \* Select models only.
  - \*\* Ratchet back height adjustment on select models.
  - Mechanisms shown are generic depictions and may differ from one chair to another.



GLOBAL FABRIC SAMPLE CARDS DISPLAY THE FOLLOWING ACT FABRIC PERFORMANCE SYMBOLS:

THE ASSOCIATION FOR CONTRACT TEXTILES (ACT) HAS DEVELOPED THE FOLLOWING PERFORMANCE GUIDELINES TO MAKE FABRIC SPECIFICATION EASIER. THE FIVE SYMBOLS GIVE ARCHITECTS, DESIGNERS AND END USERS A VAST AMOUNT OF PERFORMANCE INFORMATION IN A SUCCINCT, VISUAL WAY. THIS CHART LISTS THE REQUIRED TESTS THAT CORRESPOND TO SPECIFIC END USES. AN EXPLANATION OF THE SYMBOL ALSO APPEARS.

## FIRE RETARDANCY



Flammability testing determines a fabric's performance and resistance to burning.

### APPLICATION

Upholstery  
Panels and upholstered walls

### PASSES

California bulletin 117, section E.  
ASTM E 84-03 Class A or Class 1 (unadhered method).

## COLOR FASTNESS TO WET & DRY CROCKING



Color fastness to wet & dry crocking refers to the rubbing off of color from the fabric onto clothing, hands or other materials and can occur under wet or dry conditions.

### APPLICATION

Upholstery  
Panels and upholstered walls

### PASSES

AATCC 8-2001 Dry crocking. Class 4 minimum.  
Wet crocking, Class 3 minimum.  
AATCC 8-2001 E 84 (unadhered method).

## COLOR FASTNESS TO LIGHT



Color fastness to light is the degree to which fabric will retain its color when exposed to light.

### APPLICATION

Upholstery  
Panels and upholstered walls

### PASSES

AATCC option 2-2003 or AATCC - option 3-2003.  
Class 4 minimum of 40 hours.  
AATCC option 2-2003 or AATCC - option 3-2003.  
Class 4 minimum of 40 hours.

## PHYSICAL PROPERTIES



Three physical property tests include: 1 - Brush pill test to determine a fabric's pilling (the formation of fuzzy galls of fiber on the surface of a fabric). 2 - Breaking/tensile strength is the ability of a fabric to withstand tension without breaking or tearing. 3 - Seam slippage is the pulling apart of fabrics at the seams.

### APPLICATION

Upholstery  
Panels and upholstered walls

### PASSES

Brush pill ASTM D3511-02, 3 minimum.  
Breaking strength ASTM D5034-95 (2001) 50 lbs. minimum in warp & weft.  
Seam slippage ASTM D4034 25 lbs. minimum in warp & weft.  
Breaking strength ASTM D5034-95 (2001) (grab test).  
35 lbs. minimum in warp & weft.

## ABRASION



Abrasion is the ability of a fabric to withstand damage from wear and rubbing. There is a general contract specification as well as a heavy duty specification.

### APPLICATION

General contract upholstery  
Heavy duty upholstery

### PASSES

ASTM D4157-02 (#10 cotton duck) 15,000 double rubs, Wyzenbeek method.  
ASTM D4966-98 (12 KPA pressure) 20,000 double rubs, Martindale method.  
ASTM D4157-02 (#10 cotton duck) 30,000 double rubs, Wyzenbeek method.  
ASTM D4966-98 (12 KPA pressure) 40,000 double rubs, Martindale method.