





















lounge

	Ballara.....	225		Jeo.....	270		River+.....	294
	Braden.....	236		Kate.....	273		Sirena.....	317
	Calidon.....	240		Lux.....	274		Venture.....	320
	Camino.....	241		ML.....	276		Vitrola.....	323
	Citi.....	246		ML Park.....	278		Wind.....	325
	Citi Square.....	250		Prairie.....	279		Wind Linear.....	329
	Drift.....	259		River.....	280			

BALLARA



model 9751



model 9751NA & 9757L



Quilted seat option
4x4 Square grid pattern
See optional features
for more details.



model 9752NA Two Seat Sofa, 9755 Corner Table, 9751NA Lounge Chair, 9757L Left Tablet

STANDARD FEATURES

- Ballara is a modular series that includes seating, storage, power, tables and tablets.
- It can fulfill many space planning scenarios including corner, in-line, open concept, as well as traditional receptions.
- Furniture pieces, seating or tables can be used as standalone items or linked together with ganging brackets to create infinite configurations.
- Four high back (banquette) models available in two different heights (42" or 48") and two seat options (two-seat or three-seat armless sofas).
- Banquettes are available as table back models (TB) which are equipped with an 8" laminate back table shelf.
- Tablets can be mounted outside or between seats to accommodate various work/collaborative settings. Tablets have a 14" round surface and a 2-point locking mechanism for easy handling and stability.
- Fixed cushions are accented by a metal base and frame. Frames are standard in Black.
- Table frames and tablet metal components are standard in Black. Tables feature durable and matching 3mm edges.
- Ganging brackets and power units are standard in Black.
- Power units include one power outlet and two USB ports and can be mounted under any seat or table. Wire management is included.
- Upholstery options: fabric, vinyl or leather. Vinyl and leather models may feature stitch detail across the seat and/or back cushions, if applicable.
- All models are standard with Black polypropylene foot glides.

OPTIONAL FEATURES

- Quilted seat (**Q**) is available. Backless stools, add \$131 each. Single seat models, add \$131. Two seater sofa, add \$263. Three seater sofa, add \$395.
- All chair frames, table frames, tablet metal components, ganging brackets and metal brackets are available in paint and plated finishes. Please see page 379 for options. Chrome (**CHM**) or Brushed Chrome (**BCH**) are available with an upcharge. Add \$174 for counter height/bar height stools. Add \$174 for single seat lounge chairs and bench. Add \$231 for two seat sofas and bench. Add \$275 for three seat sofas and bench. Add \$174 for tables. Add \$231 for 2-seat length tables. Add \$85 for tablets. Add \$15 for ganging brackets. Add \$9 for metal brackets on floating tables (BCH finish only).
- Corner tables, storage tables, floating tables and tablets are offered in the following laminate finishes: Absolute Acajou (ACJ), Asian Night (ASN), Avant Cherry (AWC), Avant Honey (AWH), Black (BLK), Blizzard (BZD), Brushed Cobalt (BRC), Clear Maple (CMB), Custom Grey (CGY), Dark Espresso (DES), Designer White (DWT), Fashionista (FAS), First Class (FCL), Noce Biondo (NBL), Noce Grigio (NGL), Noce Leggero (NEL), Noce Medio (NML), Quartered Mahogany (QTM), Sheer Beauty (SBY), Stonedust (SDT), Storm Grey (SOG), Walnut Heights (WHE), White Chocolate (WHC) and Winter Cherry (WCR).

SAMPLE LAYOUTS

Layout A



Qty	Model Number	Description	Dimensions	List Price
1	9751L	Lounge Chair - Left Arm	28.5 x 31 x 30	1500
1	9751R	Lounge Chair - Right Arm	28.5 x 31 x 30	1500
1	9755	Corner Table	27.25 x 27.25 x 12.5	584
2	9759	Ganging Bracket	1 x 0.75 x 10	19 x 2

SAMPLE LAYOUT TOTAL IN STANDARD BLACK FRAME 3622
SAMPLE LAYOUT TOTAL IN OPTIONAL FRAME FINISHES 4174

Layout B



Qty	Model Number	Description	Dimensions	List Price
1	9751L	Lounge Chair - Left Arm	28.5 x 31 x 30	1500
1	9751R	Lounge Chair - Right Arm	28.5 x 31 x 30	1500
1	9755	Corner Table	27.25 x 27.25 x 12.5	584
2	9759	Ganging Bracket	1 x 0.75 x 10	19 x 2



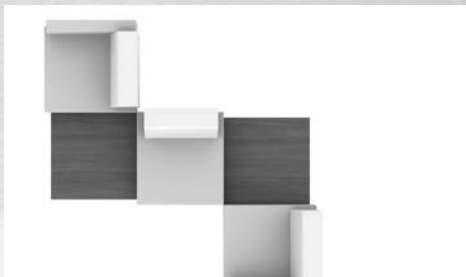

SAMPLE LAYOUT TOTAL IN STANDARD BLACK FRAME 3622
SAMPLE LAYOUT TOTAL IN OPTIONAL FRAME FINISHES 4174



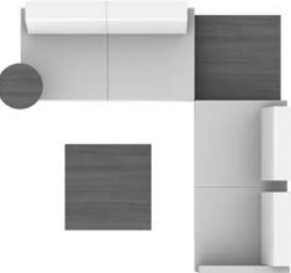

Layout C

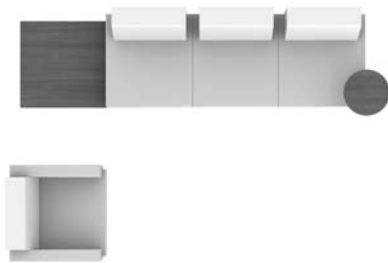

Qty	Model Number	Description	Dimensions	List Price
1	9751L	Lounge Chair - Left Arm	28.5 x 31 x 30	1500
1	9751R	Lounge Chair - Right Arm	28.5 x 31 x 30	1500
1	9751NA	Lounge Chair - No Arms	26.5 x 31 x 30	1229
2	9755	Corner Table	27.25 x 27.25 x 12.5	584 x 2
4	9759	Ganging Bracket	1 x 0.75 x 10	19 x 4

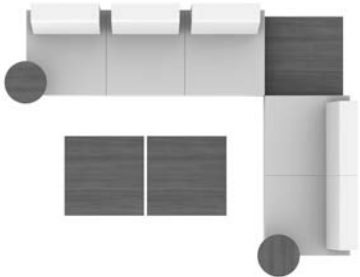
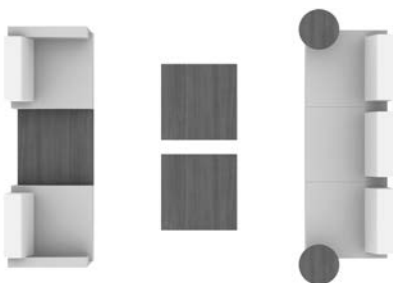
SAMPLE LAYOUT TOTAL IN STANDARD BLACK FRAME 5473
SAMPLE LAYOUT TOTAL IN OPTIONAL FRAME FINISHES 6403

DESCRIPTION	FEATURES	MODEL #	STANDARD TEXTILE GRADES			
Layout D 	Qty	Model Number	Description	Dimensions	List Price	
	1	9751L	Lounge Chair - Left Arm	28.5 x 31 x 30	1500	
	1	9751R	Lounge Chair - Right Arm	28.5 x 31 x 30	1500	
	1	9751NA	Lounge Chair - Armless	26.5 x 31 x 30	1229	
	2	9755	Corner Table	27.25 x 27.25 x 12.5	584 x 2	
	1	9757L	Left Tablet	14 x 17.25 x 14	460	
	1	9758R	Right Tablet	14 x 17.25 x 14	460	
	4	9759	Ganging Bracket	1 x 0.75 x 10	19 x 4	
	SAMPLE LAYOUT TOTAL IN STANDARD BLACK FRAME					6393
	SAMPLE LAYOUT TOTAL IN OPTIONAL FRAME FINISHES					7493
Layout E 	Qty	Model Number	Description	Dimensions	List Price	
	1	9752L-OB	Two Seat Sofa Open Back - Left Arm	54 x 31 x 30	2459	
	1	9752NA	Two Seat Sofa - Armless	52 x 31 x 30	2248	
	1	9754	Storage Table	27.25 x 27.25 x 16.5	953	
	1	9755	Corner Table	27.25 x 27.25 x 12.5	584	
	1	9758R	Right Tablet	14 x 17.25 x 14	460	
	2	9759	Ganging Bracket	1 x 0.75 x 10	19 x 2	
	SAMPLE LAYOUT TOTAL IN STANDARD BLACK FRAME					6742
SAMPLE LAYOUT TOTAL IN OPTIONAL FRAME FINISHES					7667	
Layout F 	Qty	Model Number	Description	Dimensions	List Price	
	1	9753NA-OB	Three Seat Sofa Open Back - Armless	80.5 x 31 x 30	3208	
	1	9751L	Lounge Chair - Left Arm	28.5 x 31 x 30	1500	
	1	9755	Corner Table	27.25 x 27.25 x 12.5	584	
	1	9757L	Left Tablet	14 x 17.25 x 14	460	
	1	9758R	Right Tablet	14 x 17.25 x 14	460	
	2	9759	Ganging Bracket	1 x 0.75 x 10	19 x 2	
	SAMPLE LAYOUT TOTAL IN STANDARD BLACK FRAME					6250
SAMPLE LAYOUT TOTAL IN OPTIONAL FRAME FINISHES					7073	
Layout G 	Qty	Model Number	Description	Dimensions	List Price	
	1	9753NA-OB	Three Seat Sofa Open Back - Armless	80.5 x 31 x 30	3208	
	1	9751	Lounge Chair	30.5 x 31 x 30	1771	
	1	9755	Corner Table	27.25 x 27.25 x 12.5	584	
	1	9757L	Left Tablet	14 x 17.25 x 14	460	
	1	9759	Ganging Bracket	1 x 0.75 x 10	19	
	SAMPLE LAYOUT TOTAL IN STANDARD BLACK FRAME					6061
SAMPLE LAYOUT TOTAL IN OPTIONAL FRAME FINISHES					6799	
Layout H 	Qty	Model Number	Description	Dimensions	List Price	
	1	9751L	Lounge Chair - Left Arm	28.5 x 31 x 30	1500	
	1	9751R	Lounge Chair - Right Arm	28.5 x 31 x 30	1500	
	1	9751NA	Lounge Chair - No Arms	26.5 x 31 x 30	1229	
	2	9755	Corner Table	27.25 x 27.25 x 12.5	584 x 2	
	4	9759	Ganging Bracket	1 x 0.75 x 10	19 x 4	
	SAMPLE LAYOUT TOTAL IN STANDARD BLACK FRAME					5473
SAMPLE LAYOUT TOTAL IN OPTIONAL FRAME FINISHES					6403	

DESCRIPTION	FEATURES	MODEL #	STANDARD TEXTILE GRADES		
Layout I 	Qty	Model Number	Description	Dimensions	List Price
	1	9753NA-OB	Three Seat Sofa Open Back - Armless	80.5 x 31 x 30	3208
	1	9752NA	Two Seat Sofa - Armless	52 x 31 x 30	2248
	2	9754	Storage Table	27.25 x 27.25 x 16.5	953 x 2
	1	9755	Corner Table	27.25 x 27.25 x 12.5	584
	1	9757L	Left Tablet	14 x 17.25 x 14	460
	1	9758R	Right Tablet	14 x 17.25 x 14	460
	2	9759	Ganging Bracket	1 x 0.75 x 10	19 x 2
SAMPLE LAYOUT TOTAL IN STANDARD BLACK FRAME					8904
SAMPLE LAYOUT TOTAL IN OPTIONAL FRAME FINISHES					10132
Layout J 	Qty	Model Number	Description	Dimensions	List Price
	1	9753NA-OB	Three Seat Sofa Open Back - Armless	80.5 x 31 x 30	3208
	1	9751L	Lounge Chair - Left Arm	28.5 x 31 x 30	1500
	1	9751R	Lounge Chair - Right Arm	28.5 x 31 x 30	1500
	2	9754	Storage Table	27.25 x 27.25 x 16.5	953 x 2
	1	9755	Corner Table	27.25 x 27.25 x 12.5	584
	1	9757L	Left Tablet	14 x 17.25 x 14	460
	1	9758R	Right Tablet	14 x 17.25 x 14	460
2	9759	Ganging Bracket	1 x 0.75 x 10	19 x 2	
SAMPLE LAYOUT TOTAL IN STANDARD BLACK FRAME					9656
SAMPLE LAYOUT TOTAL IN OPTIONAL FRAME FINISHES					11001
Layout K 	Qty	Model Number	Description	Dimensions	List Price
	2	9753NA-OB	Three Seat Sofa Open Back - Armless	80.5 x 31 x 30	3208 x 2
	2	9755	Corner Table	27.25 x 27.25 x 12.5	584 x 2
SAMPLE LAYOUT TOTAL IN STANDARD BLACK FRAME					7622
SAMPLE LAYOUT TOTAL IN OPTIONAL FRAME FINISHES					8550
Layout L 	Qty	Model Number	Description	Dimensions	List Price
	1	9752NA	Two Seat Sofa - Armless	52 x 31 x 30	2248
	1	9751L	Lounge Chair - Left Arm	28.5 x 31 x 30	1500
	1	9751R	Lounge Chair - Right Arm	28.5 x 31 x 30	1500
	2	9755	Corner Table	27.25 x 27.25 x 12.5	584 x 2
	4	9759	Ganging Bracket	1 x 0.75 x 10	19 x 4
SAMPLE LAYOUT TOTAL IN STANDARD BLACK FRAME					6492
SAMPLE LAYOUT TOTAL IN OPTIONAL FRAME FINISHES					7479
Layout M 	Qty	Model Number	Description	Dimensions	List Price
	1	9753NA-OB	Three Seat Sofa Open Back - Armless	80.5 x 31 x 30	3208
	1	9752L-OB	Two Seat Sofa Open Back - Left Arm	54 x 31 x 30	2459
	1	9752NA	Two Seat Sofa - Armless	52 x 31 x 30	2248
	2	9755	Corner Table	27.25 x 27.25 x 12.5	584 x 2
	1	9754	Storage Table	27.25 x 27.25 x 16.5	953
	1	9758R	Right Tablet	14 x 17.25 x 14	460
	4	9759	Ganging Bracket	1 x 0.75 x 10	19 x 4
SAMPLE LAYOUT TOTAL IN STANDARD BLACK FRAME					10572
SAMPLE LAYOUT TOTAL IN OPTIONAL FRAME FINISHES					11976

DESCRIPTION	FEATURES	MODEL #	STANDARD TEXTILE GRADES
-------------	----------	---------	-------------------------

Layout N



Qty	Model Number	Description	Dimensions	List Price
1	9753NA-OB	Three Seat Sofa Open Back - Armless	80.5 x 31 x 30	3208
1	9751L	Lounge Chair - Left Arm	28.5 x 31 x 30	1500
1	9751R	Lounge Chair - Right Arm	28.5 x 31 x 30	1500
2	9755	Corner Table	27.25 x 27.25 x 12.5	584 x 2
4	9759	Ganging Bracket	1 x 0.75 x 10	19 x 4

SAMPLE LAYOUT TOTAL IN STANDARD BLACK FRAME 7452
SAMPLE LAYOUT TOTAL IN OPTIONAL FRAME FINISHES 8483

Layout O

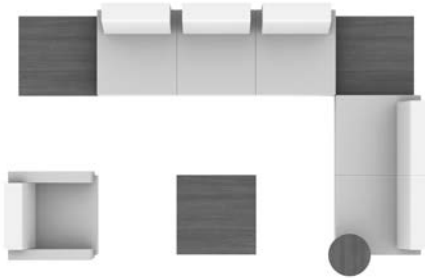

Qty	Model Number	Description	Dimensions	List Price
1	9753NA-OB	Three Seat Sofa Open Back - Armless	80.5 x 31 x 30	3208
1	9752NA	Two Seat Sofa - Armless	52 x 31 x 30	2248
1	9751	Lounge Chair	30.5 x 31 x 30	1771
1	9754	Storage Table	27.25 x 27.25 x 16.5	953
2	9755	Corner Table	27.25 x 27.25 x 12.5	584 x 2
1	9757L	Left Tablet	14 x 17.25 x 14	460
3	9759	Ganging Bracket	1 x 0.75 x 10	19 x 3

SAMPLE LAYOUT TOTAL IN STANDARD BLACK FRAME 9865
SAMPLE LAYOUT TOTAL IN OPTIONAL FRAME FINISHES 11197

Layout P

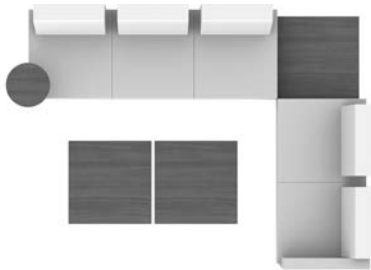

Qty	Model Number	Description	Dimensions	List Price
1	9753NA-OB	Three Seat Sofa Open Back - Armless	80.5 x 31 x 30	3208
1	9752L-OB	Two Seat Sofa Open Back - Left Arm	54 x 31 x 30	2459
2	9754	Storage Table	27.25 x 27.25 x 16.5	953 x 2
1	9755	Corner Table	27.25 x 27.25 x 12.5	584
1	9758R	Right Tablet	14 x 17.25 x 14	460
2	9759	Ganging Bracket	1 x 0.75 x 10	19 x 2

SAMPLE LAYOUT TOTAL IN STANDARD BLACK FRAME 8655
SAMPLE LAYOUT TOTAL IN OPTIONAL FRAME FINISHES 9798

	1	2	3	4	5	6	7	8	9	10	11	12
9751	1771	1907	2022	2154	2370	2570	2770	2944	3161	3365	3641	4032

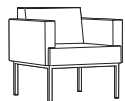

Lounge Chair
 COM: 4.25 YD | 3.89 M
 Unit weight: 61 LB | 27.7 KG
 Carton weight: 71 LB | 32.21 KG
 Carton volume: 21.5 FT³ | 0.6 MT³

	OVERALL DIMENSIONS			SEAT DIMENSIONS			BACK DIMENSIONS		
	W	D	H	W	D	H	W	H	
IN	30.5	31	30	24	20.5	18.5	22	12.5	
MM	775	787	762	610	521	470	559	318	
RTA 00	1 per carton								





Lounge Chair - One Arm
 COM: 3.25 YD | 2.97 M
 Unit weight: 51 LB | 23.2 KG
 Carton weight: 61 LB | 27.67 KG
 Carton volume: 20 FT³ | 0.56 MT³

Ganging clip required for sectional use.

R for right arm.
 L for left arm.

	1	2	3	4	5	6	7	8	9	10	11	12
9751R	1500	1604	1692	1793	1958	2111	2264	2397	2563	2719	2930	3229
9751L												
	OVERALL DIMENSIONS			SEAT DIMENSIONS			BACK DIMENSIONS					
	W	D	H	W	D	H	W	H				
IN	28.5	31	30	24	20.5	18.5	22	12.5				
MM	724	787	762	610	521	470	559	318				
RTA 00	1 per carton											

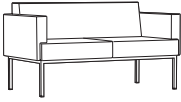
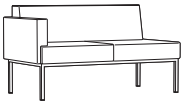
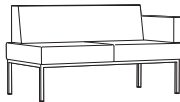
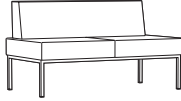
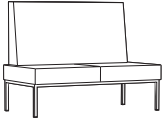
DESCRIPTION	FEATURES	MODEL #	STANDARD TEXTILE GRADES													
			1	2	3	4	5	6	7	8	9	10	11	12		
 <p>Lounge Chair - Armless COM: 2.25 YD 2.06 M Unit weight: 41 LB 18.6 KG Carton weight: 51 LB 23.13 KG Carton volume: 18.75 FT³ 0.53 MT³</p>	Ganging clip required for sectional use.	9751NA	1229	1301	1362	1432	1546	1652	1758	1850	1965	2073	2219	2426		
			OVERALL DIMENSIONS			SEAT DIMENSIONS			BACK DIMENSIONS							
			W	D	H	W	D	H	W	H						
			IN 26.5 MM 673	31 787	30 762	24 610	20.5 521	18.5 470	22 559	12.5 318						
			RTA 00	1 per carton												
 <p>Corner Unit COM: 3 YD 2.74 M Unit weight: 62 LB 28.2 KG Carton weight: 72 LB 32.66 KG Carton volume: 18.5 FT³ 0.52 MT³</p>	Ganging clip required for sectional use.	9764	1621	1717	1798	1891	2044	2185	2326	2449	2602	2746	2941	3217		
			OVERALL DIMENSIONS			SEAT DIMENSIONS			BACK DIMENSIONS							
			W	D	H	W	D	H	W	H						
			IN 28.5 MM 724	28.5 724	30 762	22 559	20.5 521	18.5 470	22 559	12.5 318						
			RTA 00	1 per carton												
 <p>Two Seat Sofa COM: 6.25 YD 5.72 M Unit weight: 99 LB 45 KG Carton weight: 111 LB 50.35 KG Carton volume: 37.5 FT³ 1.06 MT³</p>		9752	2794	2994	3163	3357	3675	3969	4263	4519	4838	5138	5544	6119		
			OVERALL DIMENSIONS			SEAT DIMENSIONS			BACK DIMENSIONS							
			W	D	H	W	D	H	W	H						
			IN 56 MM 1422	31 787	30 762	48 1219	20.5 521	18.5 470	44 1118	12.5 318						
			RTA 00	1 per carton												
  <p>Two Seat Sofa COM: 5 YD 4.57 M Unit weight: 89 LB 40.5 KG Carton weight: 101 LB 45.81 KG Carton volume: 36.25 FT³ 1.02 MT³</p>	Ganging clip required for sectional use.	9752R 9752L	2490	2650	2785	2940	3195	3430	3665	3870	4125	4365	4690	5150		
			OVERALL DIMENSIONS			SEAT DIMENSIONS			BACK DIMENSIONS							
			W	D	H	W	D	H	W	H						
			IN 54 MM 1372	31 787	30 762	48 1219	20.5 521	18.5 470	44 1118	12.5 318						
			RTA 00	1 per carton												
				R for right arm. L for left arm.												
 <p>Two Seat Sofa - Armless COM: 4 YD 3.66 M Unit weight: 79 LB 35.9 KG Carton weight: 91 LB 41.28 KG Carton volume: 35.5 FT³ 1 MT³</p>	Ganging clip required for sectional use.	9752NA	2248	2376	2484	2608	2812	3000	3188	3352	3556	3748	4008	4376		
			OVERALL DIMENSIONS			SEAT DIMENSIONS			BACK DIMENSIONS							
			W	D	H	W	D	H	W	H						
			IN 52 MM 1321	31 787	30 762	48 1219	20.5 521	18.5 470	44 1118	12.5 318						
			RTA 00	1 per carton												
 <p>Two Seat Sofa - 42" High Back COM: 8 YD 7.32 M Unit weight: 105 LB 47.7 KG Carton weight: 120 LB 54.43 KG Carton volume: 48.5 FT³ 1.37 MT³</p>	Ganging clip required for sectional use.	9752NAHB42	2563	2819	3035	3283	3691	4067	4443	4771	5179	5563	6083	6819		
			OVERALL DIMENSIONS			SEAT DIMENSIONS			BACK DIMENSIONS							
			W	D	H	W	D	H	W	H						
			IN 52 MM 1321	31 787	42 1067	48 1219	20.5 521	18.5 470	44 1118	24.5 622						
			RTA 00	1 per carton												

DESCRIPTION	FEATURES	MODEL #	STANDARD TEXTILE GRADES											
			1	2	3	4	5	6	7	8	9	10	11	12



Two Seat Sofa - 42" High Back w/36"H Table Shelf
 COM: 6 YD | 5.49 M
 Unit weight: 120 LB | 54.5 KG
 Carton weight: 135 LB | 61.23 KG
 Carton volume: 63.75 FT³ | 1.8 MT³

Ganging clip required for sectional use.

9752NAHB42TB	3388	3580	3742	3928	4234	4516	4798	5044	5350	5638	6028	6580
--------------	------	------	------	------	------	------	------	------	------	------	------	------

OVERALL DIMENSIONS			SEAT DIMENSIONS			BACK DIMENSIONS	
W	D	H	W	D	H	W	H

IN	52	41	42	48	20.5	18.5	44	24.5
MM	1321	1041	1067	1219	521	470	1118	622

RTA 00 1 per carton

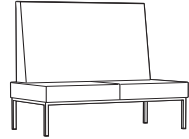

Two Seat Sofa - 48" High Back
 COM: 8.75 YD | 8 M
 Unit weight: 115 LB | 52.3 KG
 Carton weight: 130 LB | 58.97 KG
 Carton volume: 55 FT³ | 1.55 MT³

Ganging clip required for sectional use.

9752NAHB48	2671	2951	3187	3459	3905	4316	4727	5086	5532	5952	6521	7326
------------	------	------	------	------	------	------	------	------	------	------	------	------

OVERALL DIMENSIONS			SEAT DIMENSIONS			BACK DIMENSIONS	
W	D	H	W	D	H	W	H

IN	52	31	48	48	20.5	18.5	44	30.5
MM	1321	787	1219	1219	521	470	1118	775

RTA 00 1 per carton



Two Seat Sofa - 42" High Back w/42" H Table Shelf
 COM: 6 YD | 5.49 M
 Unit weight: 130 LB | 59.1 KG
 Carton weight: 145 LB | 65.77 KG
 Carton volume: 71.25 FT³ | 2.01 MT³

Ganging clip required for sectional use.

9752NAHB48TB	3496	3688	3850	4036	4342	4624	4906	5152	5458	5746	6136	6688
--------------	------	------	------	------	------	------	------	------	------	------	------	------

OVERALL DIMENSIONS			SEAT DIMENSIONS			BACK DIMENSIONS	
W	D	H	W	D	H	W	H

IN	52	41	48	48	20.5	18.5	44	30.5
MM	1321	1041	1219	1219	521	470	1118	775

RTA 00 1 per carton

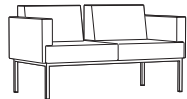

Two Seat Sofa - Open Back
 COM: 6.25 YD | 5.72 M
 Unit weight: 99 LB | 45 KG
 Carton weight: 111 LB | 50.35 KG
 Carton volume: 35.25 FT³ | 0.99 MT³

Ganging clip required for sectional use.

9752-OB	2761	2961	3130	3324	3642	3936	4230	4486	4805	5105	5511	6086
---------	------	------	------	------	------	------	------	------	------	------	------	------

OVERALL DIMENSIONS			SEAT DIMENSIONS			BACK DIMENSIONS	
W	D	H	W	D	H	W	H

IN	56	29.5	30	54	20.5	18.5	48	12.5
MM	1422	749	762	1372	521	470	1219	318

RTA 00 1 per carton

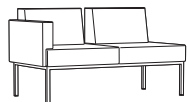

9752R-OB

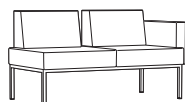

9752L-OB

Two Seat Sofa - Open Back - One Arm
 COM: 5.25 YD | 4.8 M
 Unit weight: 89 LB | 40.5 KG
 Carton weight: 101 LB | 45.81 KG
 Carton volume: 36.25 FT³ | 1.02 MT³

Ganging clip required for sectional use.

R for right arm.
 L for left arm.

9752R-OB	2459	2627	2769	2932	3199	3446	3693	3908	4176	4428	4769	5252
9752L-OB												

OVERALL DIMENSIONS			SEAT DIMENSIONS			BACK DIMENSIONS	
W	D	H	W	D	H	W	H

IN	54	31	30	48	20.5	18.5	44	12.5
MM	1372	787	762	1219	521	470	1118	318

RTA 00 1 per carton

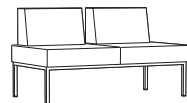

Two Seat Sofa - Open Back - Armless
 COM: 4.25 YD | 3.89 M
 Unit weight: 79 LB | 35.9 KG
 Carton weight: 91 LB | 41.28 KG
 Carton volume: 35.5 FT³ | 1 MT³

Ganging clip required for sectional use.

9752NA-OB	2218	2354	2469	2601	2817	3017	3217	3391	3608	3812	4088	4479
-----------	------	------	------	------	------	------	------	------	------	------	------	------

OVERALL DIMENSIONS			SEAT DIMENSIONS			BACK DIMENSIONS	
W	D	H	W	D	H	W	H

IN	52	31	30	48	20.5	18.5	44	12.5
MM	1321	787	762	1219	521	470	1118	318

RTA 00 1 per carton

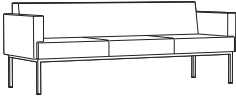
DESCRIPTION	FEATURES	MODEL #	STANDARD TEXTILE GRADES												
			1	2	3	4	5	6	7	8	9	10	11	12	
 <p>Three Seat Sofa COM: 9.5 YD 8.69 M Unit weight: 138 LB 62.7 KG Carton weight: 153 LB 69.4 KG Carton volume: 54.5 FT³ 1.54 MT³</p>			9753	3784	4088	4345	4639	5124	5570	6017	6406	6891	7347	7964	8838
	OVERALL DIMENSIONS			SEAT DIMENSIONS			BACK DIMENSIONS								
	W D H			W D H			W H								
	IN 82.5 31 30 MM 2096 787 762			76.5 20.5 18.5 1943 521 470			66 12.5 1676 318								
			RTA 00	1 per carton											

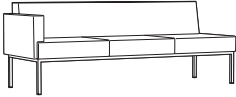

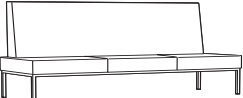

DESCRIPTION	FEATURES	MODEL #	STANDARD TEXTILE GRADES													
			1	2	3	4	5	6	7	8	9	10	11	12		
 <p>Three Seat Sofa - One Arm COM: 8.25 YD 7.54 M Unit weight: 128 LB 58.2 KG Carton weight: 143 LB 64.86 KG Carton volume: 54.5 FT³ 1.54 MT³</p>	Ganging clip required for sectional use. R for right arm. L for left arm.		9753R	3528	3792	4015	4271	4691	5079	5467	5805	6226	6622	7158	7917	
		OVERALL DIMENSIONS			SEAT DIMENSIONS			BACK DIMENSIONS								
		W D H			W D H			W H								
		IN 81.5 31 30 MM 2070 787 762			80.5 20.5 18.5 2045 521 470			74 12.5 1880 318								
			RTA 00	1 per carton												





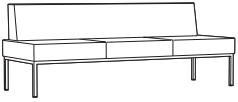
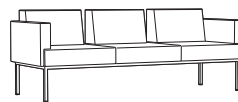
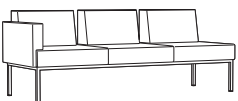
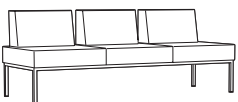





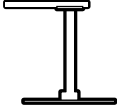





DESCRIPTION	FEATURES	MODEL #	STANDARD TEXTILE GRADES													
			1	2	3	4	5	6	7	8	9	10	11	12		
 <p>Three Seat Sofa - 42" High Back COM: 12.25 YD 11.2 M Unit weight: 128 LB 58.2 KG Carton weight: 143 LB 64.86 KG Carton volume: 72.5 FT³ 2.05 MT³</p>	Ganging clip required for sectional use.		9753NAHB42	3912	4304	4635	5015	5639	6215	6791	7293	7918	8506	9302	10429	
		OVERALL DIMENSIONS			SEAT DIMENSIONS			BACK DIMENSIONS								
		W D H			W D H			W H								
		IN 80.5 31 42 MM 2045 787 1067			74 20.5 18.5 1880 521 470			74 24.5 1880 622								
			RTA 00	1 per carton												









DESCRIPTION	FEATURES	MODEL #	STANDARD TEXTILE GRADES													
			1	2	3	4	5	6	7	8	9	10	11	12		
 <p>Three Seat Sofa - 42" High Back w/36" H Table Shelf COM: 9 YD 8.23 M Unit weight: 143 LB 65 KG Carton weight: 158 LB 71.67 KG Carton volume: 93.5 FT³ 2.64 MT³</p>	Ganging clip required for sectional use.		9753NAHB42TB	4874	5162	5405	5684	6143	6566	6989	7358	7817	8249	8834	9662	
		OVERALL DIMENSIONS			SEAT DIMENSIONS			BACK DIMENSIONS								
		W D H			W D H			W H								
		IN 80.5 41 42 MM 2045 1041 1067			80.5 20.5 18.5 2045 521 470			74 24.5 1880 622								
			RTA 00	1 per carton												

DESCRIPTION	FEATURES	MODEL #	STANDARD TEXTILE GRADES													
			1	2	3	4	5	6	7	8	9	10	11	12		
 <p>Three Seat Sofa - 48" High Back COM: 13.25 YD 12.12 M Unit weight: 153 LB 69.5 KG Carton weight: 168 LB 76.2 KG Carton volume: 82.25 FT³ 2.32 MT³</p>	Ganging clip required for sectional use.		9753NAHB48	4144	4568	4926	5337	6012	6635	7258	7801	8477	9113	9974	11193	
		OVERALL DIMENSIONS			SEAT DIMENSIONS			BACK DIMENSIONS								
		W D H			W D H			W H								
		IN 80.5 31 48 MM 2045 787 1219			80.5 20.5 18.5 2045 521 470			74 30.5 1880 775								
			RTA 00	1 per carton												

DESCRIPTION	FEATURES	MODEL #	STANDARD TEXTILE GRADES													
			1	2	3	4	5	6	7	8	9	10	11	12		
 <p>Three Seat Sofa - 48" High Back w/42" H Table Shelf COM: 13.25 YD 12.12 M Unit weight: 143 LB 65 KG Carton weight: 158 LB 71.67 KG Carton volume: 106 FT³ 3 MT³</p>	Ganging clip required for sectional use.		9753NAHB48TB	5107	5531	5889	6300	6975	7598	8221	8764	9440	10076	10937	12156	
		OVERALL DIMENSIONS			SEAT DIMENSIONS			BACK DIMENSIONS								
		W D H			W D H			W H								
		IN 80.5 41 48 MM 2045 1041 1219			80.5 20.5 18.5 2045 521 470			74 24.5 1880 622								
			RTA 00	1 per carton												

DESCRIPTION	FEATURES	MODEL #	STANDARD TEXTILE GRADES											
			1	2	3	4	5	6	7	8	9	10	11	12
 <p>Three Seat Sofa - Armless COM: 7 YD 6.4 M Unit weight: 118 LB 53.6 KG Carton weight: 133 LB 60.33 KG Carton volume: 51.5 FT³ 1.45 MT³</p>	Ganging clip required for sectional use.	9753NA	3240	3464	3653	3870	4227	4556	4885	5172	5529	5865	6320	6964
			OVERALL DIMENSIONS			SEAT DIMENSIONS			BACK DIMENSIONS					
			W	D	H	W	D	H	W	H				
			IN 80.5 MM 2045	31 787	30 762	80.5 2045	20.5 521	18.5 470	74 1880	12.5 318				
			RTA 00	1 per carton										
 <p>Three Seat Sofa - Open Back COM: 8 YD 7.32 M Unit weight: 138 LB 62.7 KG Carton weight: 153 LB 69.4 KG Carton volume: 54.5 FT³ 1.54 MT³</p>		9753-OB	3751	4007	4223	4471	4879	5255	5631	5959	6367	6751	7271	8007
			OVERALL DIMENSIONS			SEAT DIMENSIONS			BACK DIMENSIONS					
			W	D	H	W	D	H	W	H				
			IN 82.5 MM 2096	31 787	30 762	80.5 2045	20.5 521	18.5 470	74 1880	12.5 318				
			RTA 00	1 per carton										
 <p>Three Seat Sofa - Open Back - One Arm COM: 7 YD 6.4 M Unit weight: 128 LB 58.2 KG Carton weight: 143 LB 64.86 KG Carton volume: 54.5 FT³ 1.54 MT³</p>	Ganging clip required for sectional use.	9753R-OB 9753L-OB	3495	3719	3908	4125	4482	4811	5140	5427	5784	6120	6575	7219
			OVERALL DIMENSIONS			SEAT DIMENSIONS			BACK DIMENSIONS					
			W	D	H	W	D	H	W	H				
			IN 81.5 MM 2070	31 787	30 762	80.5 2045	20.5 521	18.5 470	74 1880	12.5 318				
			RTA 00	1 per carton										
			R for right arm. L for left arm.											
 <p>Three Seat Sofa - Open Back - Armless COM: 6.25 YD 5.72 M Unit weight: 118 LB 53.6 KG Carton weight: 133 LB 60.33 KG Carton volume: 51.5 FT³ 1.45 MT³</p>	Ganging clip required for sectional use.	9753NA-OB	3208	3408	3577	3771	4089	4383	4677	4933	5252	5552	5958	6533
			OVERALL DIMENSIONS			SEAT DIMENSIONS			BACK DIMENSIONS					
			W	D	H	W	D	H	W	H				
			IN 80.5 MM 2045	31 787	30 762	80.5 2045	20.5 521	18.5 470	74 1880	12.5 318				
			RTA 00	1 per carton										
			List price											
 <p>Storage Table COM: N/A Unit weight: 59 LB 26.8 KG Carton weight: 65 LB 29.48 KG Carton volume: 11.5 FT³ 0.32 MT³</p>	Ganging clip required for sectional use.	9754	953											
			OVERALL DIMENSIONS			SEAT DIMENSIONS			BACK DIMENSIONS					
			W	D	H	W	D	H	W	H				
			IN 27.25 MM 692	27.25 692	16.5 419	-	-	-	-	-				
			RTA 00		1 per carton									
			List price											
 <p>Corner Table COM: N/A Unit weight: 34 LB 15.5 KG Carton weight: 40 LB 18.14 KG Carton volume: 8 FT³ 0.22 MT³</p>	Ganging clip required for sectional use.	9755	584											
			OVERALL DIMENSIONS			SEAT DIMENSIONS			BACK DIMENSIONS					
			W	D	H	W	D	H	W	H				
			IN 27.25 MM 692	27.25 692	12.5 318	-	-	-	-	-				
			RTA 00		1 per carton									

DESCRIPTION	FEATURES	MODEL #	STANDARD TEXTILE GRADES																																					
 <p>Middle Tablet COM: N/A Unit weight: 9 LB 4.1 KG Carton weight: 12 LB 5.44 KG Carton volume: 2.5 FT³ 0.07 MT³</p>		9756	List price																																					
			476																																					
			OVERALL DIMENSIONS			SEAT DIMENSIONS			BACK DIMENSIONS																															
			W	D	H	W	D	H	W	H																														
IN 14	17.25	14	-	-	-	-	-																																	
MM 356	438	356	-	-	-	-	-																																	
  1 per carton																																								
 <p>Tablet COM: N/A Unit weight: 9 LB 4.1 KG Carton weight: 12 LB 5.44 KG Carton volume: 2.5 FT³ 0.07 MT³</p>	Mounts underneath of seating.	9757L 9758R	List price																																					
			460																																					
			OVERALL DIMENSIONS			SEAT DIMENSIONS			BACK DIMENSIONS																															
			W	D	H	W	D	H	W	H																														
IN 14	17.25	14	-	-	-	-	-																																	
MM 356	438	356	-	-	-	-	-																																	
  1 per carton																																								
 <p>Ganging Bracket COM: N/A Unit weight: 0.25 LB 0.1 KG Carton weight: 0.52 LB 0.24 KG Carton volume: 0.5 FT³ 0.01 MT³</p>	One bracket is required per connection.	9759	List price																																					
			19																																					
			OVERALL DIMENSIONS			SEAT DIMENSIONS			BACK DIMENSIONS																															
			W	D	H	W	D	H	W	H																														
IN 1	0.75	10	-	-	-	-	-																																	
MM 25	19	254	-	-	-	-	-																																	
  25 per carton																																								
 <p>Power Unit w/10 Ft. power cord COM: N/A Unit weight: 2 LB 0.9 KG Carton weight: 3 LB 1.36 KG Carton volume: 0.5 FT³ 0.01 MT³</p>	Mounts underneath of seating or tables. One power outlet and two USB ports.	9760	List price																																					
			375																																					
			OVERALL DIMENSIONS			SEAT DIMENSIONS			BACK DIMENSIONS																															
			W	D	H	W	D	H	W	H																														
IN 6	2.75	2.75	-	-	-	-	-																																	
MM 152	70	70	-	-	-	-	-																																	
  1 per carton																																								
 <p>One Seat Bench COM: 2 YD 1.83 M Unit weight: 31 LB 14.1 KG Carton weight: 37 LB 16.78 KG Carton volume: 10.75 FT³ 0.3 MT³</p>	Ganging clip required for sectional use.	9761	List price																																					
			<table border="1"> <tr> <td></td><td>1</td><td>2</td><td>3</td><td>4</td><td>5</td><td>6</td><td>7</td><td>8</td><td>9</td><td>10</td><td>11</td><td>12</td> </tr> <tr> <td>939</td><td>1003</td><td>1057</td><td>1119</td><td>1221</td><td>1315</td><td>1409</td><td>1491</td><td>1593</td><td>1689</td><td>1819</td><td>2003</td><td></td> </tr> </table>													1	2	3	4	5	6	7	8	9	10	11	12	939	1003	1057	1119	1221	1315	1409	1491	1593	1689	1819	2003	
				1	2	3	4	5	6	7	8	9	10	11	12																									
			939	1003	1057	1119	1221	1315	1409	1491	1593	1689	1819	2003																										
OVERALL DIMENSIONS			SEAT DIMENSIONS			BACK DIMENSIONS																																		
W	D	H	W	D	H	W	H																																	
IN 27.5	28.5	17.5	27.5	28.5	18.5	-	-																																	
MM 699	724	445	699	724	470	-	-																																	
 1 per carton																																								
 <p>Two Seat Bench COM: 4 YD 3.66 M Unit weight: 49 LB 22.3 KG Carton weight: 57 LB 25.85 KG Carton volume: 21.25 FT³ 0.6 MT³</p>	Ganging clip required for sectional use.	9762	List price																																					
			<table border="1"> <tr> <td></td><td>1</td><td>2</td><td>3</td><td>4</td><td>5</td><td>6</td><td>7</td><td>8</td><td>9</td><td>10</td><td>11</td><td>12</td> </tr> <tr> <td>1668</td><td>1796</td><td>1904</td><td>2028</td><td>2232</td><td>2420</td><td>2608</td><td>2772</td><td>2976</td><td>3168</td><td>3428</td><td>3796</td><td></td> </tr> </table>													1	2	3	4	5	6	7	8	9	10	11	12	1668	1796	1904	2028	2232	2420	2608	2772	2976	3168	3428	3796	
				1	2	3	4	5	6	7	8	9	10	11	12																									
			1668	1796	1904	2028	2232	2420	2608	2772	2976	3168	3428	3796																										
OVERALL DIMENSIONS			SEAT DIMENSIONS			BACK DIMENSIONS																																		
W	D	H	W	D	H	W	H																																	
IN 54	28.5	17.5	54	28.5	18.5	-	-																																	
MM 1372	724	445	1372	724	470	-	-																																	
 1 per carton																																								

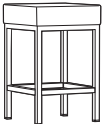
DESCRIPTION	FEATURES	MODEL #	STANDARD TEXTILE GRADES											
			1	2	3	4	5	6	7	8	9	10	11	12
 <p>Three Seat Bench COM: 6 YD 5.49 M Unit weight: 70 LB 31.8 KG Carton weight: 80 LB 36.29 KG Carton volume: 29.5 FT³ 0.83 MT³</p>	Ganging clip required for sectional use.	9763	2394	2586	2748	2934	3240	3522	3804	4050	4356	4644	5034	5586
			OVERALL DIMENSIONS			SEAT DIMENSIONS			BACK DIMENSIONS					
			W	D	H	W	D	H	W	H				
			IN 80.5 MM 2045	28.5 724	17.5 445	80.5 2045	28.5 724	18.5 470	-	-				
			RTA 00	1 per carton										
			List price											
		9765	1503											
 <p>Coffee Storage Table (2 Seat Length) COM: N/A Unit weight: 102 LB 46.4 KG Carton weight: 112 LB 50.8 KG Carton volume: 20.5 FT³ 0.58 MT³</p>	Ganging clip required for sectional use.	9765	513.75	27.25	16.5	-	-	-	-	-	-	-	-	-
			OVERALL DIMENSIONS			SEAT DIMENSIONS			BACK DIMENSIONS					
			W	D	H	W	D	H	W	H				
			IN 53.75 MM 1365	27.25 692	16.5 419	-	-	-	-	-				
			RTA 00		1 per carton									
			List price											
		9766	969											
 <p>Coffee Table (2 Seat Length) COM: N/A Unit weight: 56 LB 25.5 KG Carton weight: 68 LB 30.84 KG Carton volume: 17.75 FT³ 0.5 MT³</p>	Freestanding.	9766	54	27.5	13	-	-	-	-	-	-	-	-	
			OVERALL DIMENSIONS			SEAT DIMENSIONS			BACK DIMENSIONS					
			W	D	H	W	D	H	W	H				
			IN 54 MM 1372	27.5 699	13 330	-	-	-	-	-				
			RTA 00		1 per carton									
			List price											
		9767	501											
 <p>Floating Side Table COM: N/A Unit weight: 15 LB 6.8 KG Carton weight: 20 LB 9.07 KG Carton volume: 2.2 FT³ 0.06 MT³</p>	To be used in between chair/sofa models.	9767	13.5	27.25	1	-	-	-	-	-	-	-	-	
			OVERALL DIMENSIONS			SEAT DIMENSIONS			BACK DIMENSIONS					
			W	D	H	W	D	H	W	H				
			IN 13.5 MM 343	27.25 692	1 25	-	-	-	-	-				
			RTA 00		1 per carton									
			List price											
		9768	704											
 <p>Floating Storage Side Table COM: N/A Unit weight: 15 LB 6.8 KG Carton weight: 20 LB 9.07 KG Carton volume: 2.2 FT³ 0.06 MT³</p>	To be used in between chair/sofa models.	9768	13.5	27.25	5	-	-	-	-	-	-	-	-	
			OVERALL DIMENSIONS			SEAT DIMENSIONS			BACK DIMENSIONS					
			W	D	H	W	D	H	W	H				
			IN 13.5 MM 343	27.25 692	5 127	-	-	-	-	-				
			RTA 00		1 per carton									
			List price											
		9769S24	587	611	631	655	693	728	763	794	832	868	917	986
 <p>24" Stool COM: 0.75 YD 0.69 M Unit weight: 17 LB 7.7 KG Carton weight: 22 LB 9.98 KG Carton volume: 4.75 FT³ 0.13 MT³</p>		9769S24	587	611	631	655	693	728	763	794	832	868	917	986
			OVERALL DIMENSIONS			SEAT DIMENSIONS			BACK DIMENSIONS					
			W	D	H	W	D	H	W	H				
			IN 15 MM 381	15 381	24 610	-	-	24 610	-	-				
			RTA 00	1 per carton										

DESCRIPTION	FEATURES	MODEL #	STANDARD TEXTILE GRADES											
			1	2	3	4	5	6	7	8	9	10	11	12
 <p>30" Stool COM: 0.75 YD 0.69 M Unit weight: 18 LB 8.2 KG Carton weight: 23 LB 10.43 KG Carton volume: 5.5 FT³ 0.15 MT³</p>		9769S30	656	680	700	724	762	797	832	863	901	937	986	1055
			OVERALL DIMENSIONS			SEAT DIMENSIONS			BACK DIMENSIONS					
			W	D	H	W	D	H	W	H				
			IN 15	15	30	-	-	30	-	-				
			MM 381	381	762	-	-	762	-	-				
			RTA 00	1 per carton										

BRADEN



model 7871

models 7870R, 7870, 7870L, 7872, 7873

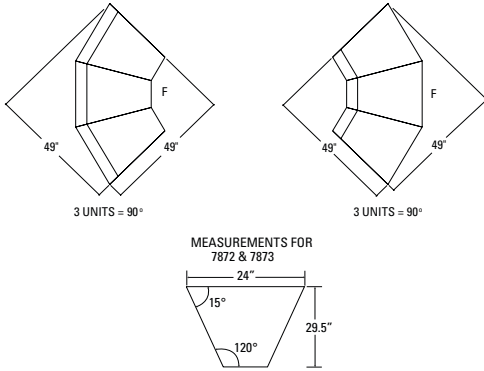

STANDARD FEATURES

- A flexible modular seating system that is exceptionally durable. Combine these seating components into a configuration that suits your space.
- Braden uses a unique ganging feature which locks units solidly together, but allows them to be separated and reconfigured when necessary.
- Locking "pins" will always be on the left side (seated) of a ganging unit, while the pin receptacle will always be on the right side.
- Ganging brackets can only be used on armless and single arm models. Model 7871 cannot be ganged.
- Three inside corner units create a 90° inside corner assembly.
- Three outside corner units create a 90° outside corner.
- Upholstery options: fabric, vinyl or leather. Vinyl and leather models may feature stitch detail across the seat and/or back cushions, if applicable.

OPTIONAL FEATURES

- For ganging hardware please use the following codes: add **(G)** for both sides, add **(GR)** for right side seated only, add **(GL)** for left side seated only.
- For highly resilient, high density Ultracell foam seat, please specify **(UC)**. Add \$96.
- For hard surface flooring use tiger paw non-slip glides, please specify **(NS)**. Add \$22.
- Model 7874 and 7880 table (tops) are offered in the following laminate finishes: Absolute Acajou (ACJ), Asian Night (ASN), Avant Cherry (AWC), Avant Honey (AWH), Black (BLK), Blizzard (BZD), Brushed Cobalt (BRC), Clear Maple (CMB), Custom Grey (CGY), Dark Espresso (DES), Designer White (DWT), Fashionista (FAS), First Class (FCL), Noce Biondo (NBL), Noce Grigio (NGL), Noce Leggero (NEL), Noce Medio (NML), Quartered Mahogany (QTM), Sheer Beauty (SBY), Stonedust (SDT), Storm Grey (SOG), Walnut Heights (WHE), White Chocolate (WHC) and Winter Cherry (WCR).

Typical Configurations and Applications:

Five seat linked sofa with arms only on ends:

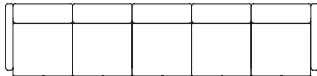

Five seat linked sofa with arms between each seat:

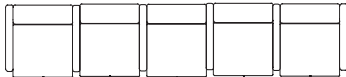

Three seats linked with two tables arms on ends:

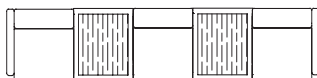

Tables and armless chairs in L shaped configuration:

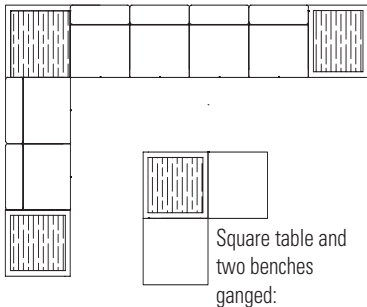

Ganged seating with corner units:

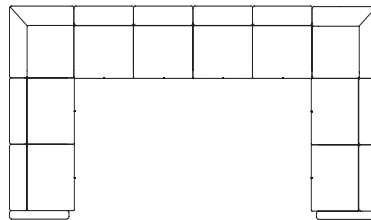

Two tables and 4 benches, ganged together:

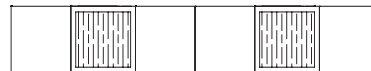

C shaped sectional with arms on ends and tables:

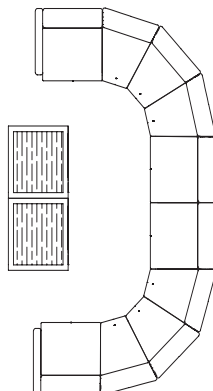

Circular configuration ganged seating:

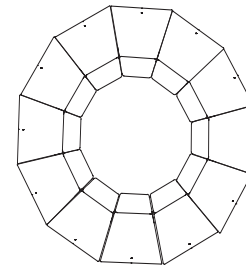



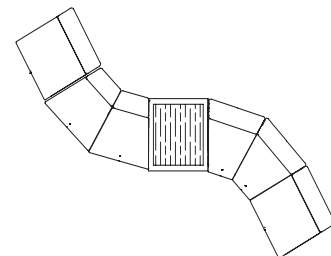





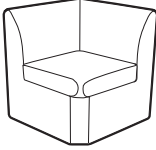

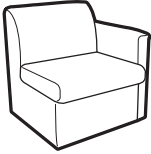

S shaped configuration ganged seating & table:



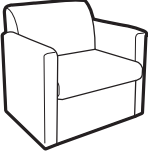

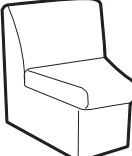
Three benches ganged:

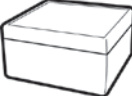

DESCRIPTION	FEATURES	MODEL#	STANDARD TEXTILE GRADES												
			1	2	3	4	5	6	7	8	9	10	11	12	
 <p>Corner Unit COM: 4 YD 3.66 M Unit weight: 42 LB 19.1 KG Carton weight: 50 LB 22.68 KG Carton volume: 16.5 FT³ 0.46 MT³</p>	Ganging hardware adjacent sides. Ergonomic features: M, N	7867	1040	1168	1276	1400	1604	1792	1980	2144	2348	2540	2800	3168	
		OVERALL DIMENSIONS			SEAT DIMENSIONS			BACK DIMENSIONS							
		W	D	H	W	D	H	W	H						
		IN 28	28	30	20	20.5	17	19.5	12.5						
		MM 711	711	762	508	521	432	495	318						
		RTA 00	1 per carton												
 <p>Single Arm COM: 1.75 YD 1.6 M Unit weight: 23 LB 10.5 KG Carton weight: 26 LB 11.79 KG Carton volume: 2.9 FT³ 0.08 MT³</p>	Ganging hardware both sides.	7868	355	411	458	513	602	684	766	838	927	1011	1125	1286	
		OVERALL DIMENSIONS			SEAT DIMENSIONS			BACK DIMENSIONS							
		W	D	H	W	D	H	W	H						
		IN 3.75	25	25	-	-	-	-	-						
		MM 95	635	635	-	-	-	-	-						
		RTA 00		1 per carton											
 <p>Single Seater COM: 2.75 YD 2.51 M Unit weight: 33 LB 15 KG Carton weight: 38 LB 17.24 KG Carton volume: 16.5 FT³ 0.46 MT³</p>	See notes for ganging hardware options. Ergonomic features: M, N	7870	553	641	715	801	941	1070	1199	1312	1452	1584	1763	2016	
		OVERALL DIMENSIONS			SEAT DIMENSIONS			BACK DIMENSIONS							
		W	D	H	W	D	H	W	H						
		IN 24	27.5	30	24	19.5	16.5	24	13.5						
		MM 610	699	762	610	495	419	610	343						
		RTA 00	1 per carton												
 <p>Single Seater - Left Arm COM: 3.75 YD 3.43 M Unit weight: 40 LB 18.2 KG Carton weight: 45 LB 20.41 KG Carton volume: 16.5 FT³ 0.46 MT³</p>	Ganging hardware right side. Ergonomic features: M, N	7870L	829	949	1050	1167	1358	1534	1710	1864	2055	2235	2479	2824	
		OVERALL DIMENSIONS			SEAT DIMENSIONS			BACK DIMENSIONS							
		W	D	H	W	D	H	W	H						
		IN 27	27.5	30	24	19.5	16.5	24	13.5						
		MM 686	699	762	610	495	419	610	343						
		RTA 00	1 per carton												
 <p>Single Seater - Right Arm COM: 3.75 YD 3.43 M Unit weight: 40 LB 18.2 KG Carton weight: 45 LB 20.41 KG Carton volume: 16.5 FT³ 0.46 MT³</p>	Ganging hardware left side. Ergonomic features: M, N	7870R	829	949	1050	1167	1358	1534	1710	1864	2055	2235	2479	2824	
		OVERALL DIMENSIONS			SEAT DIMENSIONS			BACK DIMENSIONS							
		W	D	H	W	D	H	W	H						
		IN 27	27.5	30	24	19.5	16.5	24	13.5						
		MM 686	699	762	610	495	419	610	343						
		RTA 00	1 per carton												

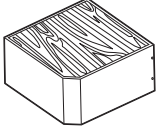
DESCRIPTION	FEATURES	MODEL#	STANDARD TEXTILE GRADES														
			1	2	3	4	5	6	7	8	9	10	11	12			
 <p>Single Seater - w/Arms COM: 4.75 YD 4.34 M Unit weight: 47 LB 21.4 KG Carton weight: 52 LB 23.59 KG Carton volume: 16.5 FT³ 0.46 MT³</p>	<p>Freestanding unit. No ganging hardware options.</p> <p>Ergonomic features: M, N</p>	7871	1103	1255	1383	1531	1773	1996	2219	2414	2656	2884	3193	3630			
			OVERALL DIMENSIONS			SEAT DIMENSIONS			BACK DIMENSIONS								
			W	D	H	W	D	H	W	H							
			IN 30 MM 762	27.5 699	30 762	24 610	19.5 495	16.5 419	24 610	13.5 343							
			RTA 00	1 per carton													
 <p>Corner Unit COM: 2.75 YD 2.51 M Unit weight: 26 LB 11.8 KG Carton weight: 31 LB 14.06 KG Carton volume: 16.5 FT³ 0.46 MT³</p>	<p>3 pieces make a 90° outside turn. Total of 49"L x 49"W.</p> <p>See notes for ganging hardware options.</p> <p>Ergonomic features: M, N</p>	7872	608	696	770	856	996	1125	1254	1367	1507	1639	1818	2071			
			OVERALL DIMENSIONS			SEAT DIMENSIONS			BACK DIMENSIONS								
			W	D	H	W	D	H	W	H							
			IN 24 MM 610	27.5 699	30 762	20 508	19.5 495	16.5 419	15 381	13.5 343							
			RTA 00	1 per carton													
 <p>Corner Unit COM: 2.75 YD 2.51 M Unit weight: 26 LB 11.8 KG Carton weight: 31 LB 14.06 KG Carton volume: 16.5 FT³ 0.46 MT³</p>	<p>3 pieces make a 90° inside turn. Total of 49"L x 49"W.</p> <p>See notes for ganging hardware options.</p> <p>Ergonomic features: M, N</p>	7873	608	696	770	856	996	1125	1254	1367	1507	1639	1818	2071			
			OVERALL DIMENSIONS			SEAT DIMENSIONS			BACK DIMENSIONS								
			W	D	H	W	D	H	W	H							
			IN 24 MM 610	27.5 699	30 762	16 406	19.5 495	16.5 419	21.5 546	13.5 343							
			RTA 00	1 per carton													
 <p>Table - 24" Square w/Upholstered Sides COM: 1.75 YD 1.6 M Unit weight: 35 LB 15.9 KG Carton weight: 38 LB 17.24 KG Carton volume: 6.25 FT³ 0.17 MT³</p>		7874	457	513	560	615	704	786	868	940	1029	1113	1227	1388			
			OVERALL DIMENSIONS			SEAT DIMENSIONS			BACK DIMENSIONS								
			W	D	H	W	D	H	W	H							
			IN 24 MM 610	24 610	14.5 368	-	-	-	-	-							
			RTA 00		1 per carton												
 <p>Footstool - 24" Square Fully Upholstered COM: 2.25 YD 2.06 M Unit weight: 40 LB 18.2 KG Carton weight: 44 LB 19.96 KG Carton volume: 8.5 FT³ 0.24 MT³</p>		7874FS	770	842	903	973	1087	1193	1299	1391	1506	1614	1760	1967			
			OVERALL DIMENSIONS			SEAT DIMENSIONS			BACK DIMENSIONS								
			W	D	H	W	D	H	W	H							
			IN 24 MM 610	24 610	17.5 445	-	-	-	-	-							
			RTA 00		1 per carton												

DESCRIPTION	FEATURES	MODEL#	STANDARD TEXTILE GRADES											
			1	2	3	4	5	6	7	8	9	10	11	12
 <p>Corner Table w/Upholstered Sides COM: 1.75 YD 1.6 M Unit weight: 40 LB 18.2 KG Carton weight: 45 LB 20.41 KG Carton volume: 7.5 FT³ 0.21 MT³</p>	<p>Ganging hardware adjacent sides.</p>	<p>7880</p>	710	766	813	868	957	1039	1121	1193	1282	1366	1480	1641
			OVERALL DIMENSIONS			SEAT DIMENSIONS			BACK DIMENSIONS					
			W	D	H	W	D	H	W	H				
			IN 27	27	14.5	-	-	-	-	-				
			MM 686	686	368	-	-	-	-	-				
					1 per carton									



Calidon™ seating and occasional tables share a distinctly modern appearance. With well-balanced and full-frame, solid hardwood construction, Calidon is a versatile solution combining comfort, style and durability for years to come. Fully upholstered lounge models include optional integrated power and USB charging for easy access in either front or side locations. Guest and lounge seating feature an integrated wipe-out design to support cleaning protocols from workplace and hospitality to healthcare environments.

To see the full Calidon series, please refer to the Healthcare price list at globalfurnituregroup.com/ca/healthcare/resources/price-lists.

Features and Benefits

- Calidon consists of wood frame guest, lounge, bariatric and bench seating.
- Freestanding and tandem/bridge tables available.
- Designed for the rigors of high use environments.
- Frame design features a wall saver leg to prevent back contact and damage to walls.
- All guest and lounge chairs feature a clean out between seat and back, and tall legs for ease of cleaning.
- Lounge chairs with closed arms are fully upholstered.
- For added comfort, seats are standard with high density Ultracell foam.
- Active weight capacity up to 400 lbs. per seat for standard seating; up to 600 lbs. per seat for bariatric seating.

CAMINO



models shown: 5471-CP Lounge Chair, 5475-W End Table, 5472-CP Two Seat Sofa.



model 5471-CP



model 5476-W



STANDARD FEATURES



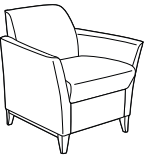
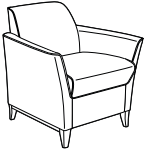

- A transitional soft seating series composed of one, two and three seat units. The series also offers tables with coordinating details and finishes.
- Frame is heavy duty, interlocking plywood, puzzle box construction suitable for public environments.
- The leg system utilizes a continuous visible frame between the front and rear leg. Each leg frame is bolted directly to the sofa frame, creating a very durable product.
- Legs are equipped with translucent non marking glides as standard. Suitable for both carpet and hard surface flooring.
- Seating units feature a decorative double stitch detail, which makes seams lay flat and adds extra seam strength.
- Cushions are highly resilient foam and seats are equipped with a synthetic rubberized sheet webbing suspension system for extra comfort. Cushions are fixed and non-removable.
- Tables are made with a choice of tops: genuine wood tops (**W**) with a reverse beveled edge, thermally fused laminate tops (**LP**) with matching PVC edging or high pressure laminate top (**HP**) with matching PVC edging. Custom high pressure laminate finishes will be considered upon request.
- Regardless of top chosen, all tables have wood aprons and a unique tapered leg design.
- Some table assembly is required, see RTA code with each item below.
- Upholstery options: fabric, vinyl or leather. Vinyl and leather models may feature stitch detail across the seat and/or back cushions, if applicable. If a two-tone fabric or a fabric/leather combination is required please fill in a fabric combination sketch showing where each fabric is to be applied. Please contact Customer Service.

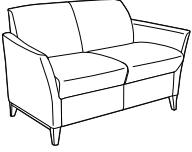
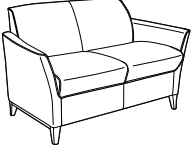
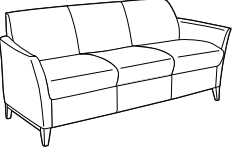
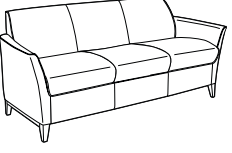
OPTIONAL FEATURES

- For piping made in fabric matching the rest of the upholstery, please use matching piping models, (**MP**) after the model number. No upcharge.
- For piping made in a fabric that does not match the rest of the upholstery, you can specify any grade 1 or 2 upholstery material. Please see model numbers ending in (**CP**) which reflect the appropriate upcharge.
- Contrast piping fabric in a grade higher than 2 requires a special quotation. Unit price will vary depending on the number of units being ordered.
- Seating units and tables come with a choice of wood legs or polished cast aluminum legs. The table leg finishes coordinate with the legs on the soft seating units; finish must be specified.
- Wood finishes are available in Absolute (AAM), Black (BKM), Cherry (ACM), Espresso Cafe (ECM), English Oak (EOM), Fruitwood (TFM), Gray (HGM), Honey (AHM), Mahogany (TMM), Maple (AVM), Medium Walnut (MWM), Natural Walnut (NLW), Night (ASM), Noce Biondo (NBM), Noce Grigio (NGM), Noce Leggero (NEM), Noce Medio (NMM), Shaker Cherry (SKM), Walnut (TWM), WC Cream (WTM), White (WHM) and Winter Cherry (WCM). Please specify.
- Seating and tables with polished aluminum legs are shown as separate SKUs.
- Laminate table tops (LP and HP) are offered in the following finishes: Absolute Acajou (ACJ), Asian Night (ASN), Avant Cherry (AVC), Avant Honey (AWH), Black (BLK), Blizzard (BZD), Brushed Cobalt (BRC), Clear Maple (CMB), Custom Grey (CGY), Dark Espresso (DES), Designer White (DWT), Fashionista (FAS), First Class (FCL), Noce Biondo (NBL), Noce Grigio (NGL), Noce Leggero (NEL), Noce Medio (NML), Quartered Mahogany (QTM), Sheer Beauty (SBY), Stonedust (SDT), Storm Grey (SOG), Walnut Heights (WHE), White Chocolate (WHC) and Winter Cherry (WCR). Please specify.

DESCRIPTION	FEATURES	MODEL#	STANDARD TEXTILE GRADES												
			1	2	3	4	5	6	7	8	9	10	11	12	
 <p>Lounge Chair w/Wood Legs COM: 4 YD 3.66 M Unit weight: 50 LB 22.7 KG Carton weight: 60 LB 27.22 KG Carton volume: 19.25 FT³ 0.54 MT³</p>	No piping.	5471	1990	2118	2226	2350	2554	2742	2930	3094	3298	3490	3750	4118	
					OVERALL DIMENSIONS W D H			SEAT DIMENSIONS W D H			BACK DIMENSIONS W H				
					IN 29.5	29	30.5	21	19.5	18	20	11.5			
					MM 749	737	775	533	495	457	508	292			
			RTA 00	1 per carton											
 <p>Lounge Chair w/Wood Legs & Piping COM: 4 YD 3.66 M Unit weight: 50 LB 22.7 KG Carton weight: 60 LB 27.22 KG Carton volume: 19.25 FT³ 0.54 MT³</p>	CP = contrast piping. MP = matching piping.	5471-CP	2132	2260	2368	2492	2696	2884	3072	3236	3440	3632	3892	4260	
		5471-MP	1990	2118	2226	2350	2554	2742	2930	3094	3298	3490	3750	4118	
					OVERALL DIMENSIONS W D H			SEAT DIMENSIONS W D H			BACK DIMENSIONS W H				
					IN 29.5	29	30.5	21	19.5	18	20	11.5			
			MM 749	737	775	533	495	457	508	292					
			RTA 00	1 per carton											

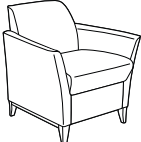
DESCRIPTION	FEATURES	MODEL#	STANDARD TEXTILE GRADES											
			1	2	3	4	5	6	7	8	9	10	11	12
 <p>Two Seat Sofa w/Wood Legs COM: 5.75 YD 5.26 M Unit weight: 72 LB 32.7 KG Carton weight: 84 LB 38.1 KG Carton volume: 36 FT³ 1.01 MT³</p>	No piping.	5472	2804	2988	3143	3322	3615	3885	4155	4391	4684	4960	5334	5863
			OVERALL DIMENSIONS			SEAT DIMENSIONS			BACK DIMENSIONS					
			W	D	H	W	D	H	W	H				
			IN 51	29	30.5	42	19.5	18	41	11.5				
			MM 1295	737	775	1067	495	457	1041	292				
		RTA 00	1 per carton											
 <p>Two Seat Sofa w/Wood Legs COM: 5.75 YD 5.26 M Unit weight: 72 LB 32.7 KG Carton weight: 84 LB 38.1 KG Carton volume: 36 FT³ 1.01 MT³</p>	CP = contrast piping. MP = matching piping.	5472-CP 5472-MP	2990	3174	3329	3507	3799	4069	4339	4574	4867	5143	5516	6044
			OVERALL DIMENSIONS			SEAT DIMENSIONS			BACK DIMENSIONS					
			W	D	H	W	D	H	W	H				
			IN 51	29	30.5	42	19.5	18	41	11.5				
			MM 1295	737	775	1067	495	457	1041	292				
		RTA 00	1 per carton											
 <p>Three Seat Sofa w/Wood Legs COM: 7.5 YD 6.86 M Unit weight: 95 LB 43.2 KG Carton weight: 110 LB 49.9 KG Carton volume: 50.25 FT³ 1.42 MT³</p>	No piping.	5473	3619	3859	4062	4294	4677	5029	5382	5689	6072	6432	6919	7609
			OVERALL DIMENSIONS			SEAT DIMENSIONS			BACK DIMENSIONS					
			W	D	H	W	D	H	W	H				
			IN 71	29	30.5	63	19.5	18	62	11.5				
			MM 1803	737	775	1600	495	457	1575	292				
		RTA 00	1 per carton											
 <p>Three Seat Sofa w/Wood Legs COM: 7.5 YD 6.86 M Unit weight: 95 LB 43.2 KG Carton weight: 110 LB 49.9 KG Carton volume: 50.25 FT³ 1.42 MT³</p>	CP = contrast piping. MP = matching piping.	5473-CP 5473-MP	3847	4087	4289	4521	4903	5255	5607	5914	6296	6656	7143	7832
			OVERALL DIMENSIONS			SEAT DIMENSIONS			BACK DIMENSIONS					
			W	D	H	W	D	H	W	H				
			IN 71	29	30.5	63	19.5	18	62	11.5				
			MM 1803	737	775	1600	495	457	1575	292				
		RTA 00	1 per carton											
 <p>Coffee Table - 22" x 48" Rectangle w/Wood Legs COM: N/A Unit weight: 32 LB 14.5 KG Carton weight: 40 LB 18.14 KG Carton volume: 4 FT³ 0.11 MT³</p>	List price													
	5474-LP	1508												
	5474-HP	1618												
	5474-W	1948												
	LP = Laminate top HP = High pressure laminate top W = Wood top													
OVERALL DIMENSIONS			SEAT DIMENSIONS			BACK DIMENSIONS								
W	D	H	W	D	H	W	H							
IN 22	48	17.5	-	-	-	-	-							
MM 559	1219	445	-	-	-	-	-							
		RTA 6	1 per carton											

DESCRIPTION	FEATURES	MODEL#	STANDARD TEXTILE GRADES																																																		
 <p>End Table - 21" x 21" Square w/Wood Legs COM: N/A Unit weight: 17 LB 7.7 KG Carton weight: 20 LB 9.07 KG Carton volume: 19.25 FT³ 0.05 MT³</p>		MODEL# 5475-LP 1124 5475-HP 1232 5475-W 1366 LP = Laminate top HP = High pressure laminate top W = Wood top	List price																																																		
			OVERALL DIMENSIONS			SEAT DIMENSIONS			BACK DIMENSIONS																																												
			W	D	H	W	D	H	W	H																																											
			IN 21	21	17.5	-	-	-	-	-																																											
			MM 533	533	445	-	-	-	-	-																																											
		RTA 8	1 per carton																																																		
 <p>Coffee Table - 24" Round w/Wood Legs COM: N/A Unit weight: 18 LB 8.2 KG Carton weight: 21 LB 9.53 KG Carton volume: 2.1 FT³ 0.05 MT³</p>		MODEL# 5476-LP 1152 5476-HP 1262 5476-W 1478 LP = Laminate top HP = High pressure laminate top W = Wood top	List price																																																		
			OVERALL DIMENSIONS			SEAT DIMENSIONS			BACK DIMENSIONS																																												
			W	D	H	W	D	H	W	H																																											
			IN 24	24	17.5	-	-	-	-	-																																											
			MM 610	610	445	-	-	-	-	-																																											
		RTA 8	1 per carton																																																		
 <p>Coffee Table - 32" Round w/Wood Legs COM: N/A Unit weight: 27 LB 12.3 KG Carton weight: 35 LB 15.88 KG Carton volume: 4.4 FT³ 0.12 MT³</p>		MODEL# 5477-LP 1750 5477-HP 1860 5477-W 2221 LP = Laminate top HP = High pressure laminate top W = Wood top	List price																																																		
			OVERALL DIMENSIONS			SEAT DIMENSIONS			BACK DIMENSIONS																																												
			W	D	H	W	D	H	W	H																																											
			IN 32	32	17.5	-	-	-	-	-																																											
			MM 813	813	445	-	-	-	-	-																																											
		RTA 8	1 per carton																																																		
 <p>Lounge Chair w/Aluminum Legs COM: 4 YD 3.66 M Unit weight: 52 LB 23.6 KG Carton weight: 62 LB 28.12 KG Carton volume: 19.25 FT³ 0.54 MT³</p>	No piping.	MODEL# 5481	List price																																																		
			<table border="1"> <tr> <td></td><td>1</td><td>2</td><td>3</td><td>4</td><td>5</td><td>6</td><td>7</td><td>8</td><td>9</td><td>10</td><td>11</td><td>12</td> </tr> <tr> <td>5481</td><td>1862</td><td>1990</td><td>2098</td><td>2222</td><td>2426</td><td>2614</td><td>2802</td><td>2966</td><td>3170</td><td>3362</td><td>3622</td><td>3990</td> </tr> </table>													1	2	3	4	5	6	7	8	9	10	11	12	5481	1862	1990	2098	2222	2426	2614	2802	2966	3170	3362	3622	3990													
				1	2	3	4	5	6	7	8	9	10	11	12																																						
			5481	1862	1990	2098	2222	2426	2614	2802	2966	3170	3362	3622	3990																																						
			OVERALL DIMENSIONS			SEAT DIMENSIONS			BACK DIMENSIONS																																												
W	D	H	W	D	H	W	H																																														
IN 29.5	29	30.5	21	19.5	18	20	11.5																																														
MM 749	737	775	533	495	457	508	292																																														
		RTA 00	1 per carton																																																		
 <p>Lounge Chair w/Aluminum Legs COM: 4 YD 3.66 M Unit weight: 52 LB 23.6 KG Carton weight: 62 LB 28.12 KG Carton volume: 19.25 FT³ 0.54 MT³</p>	CP = contrast piping. MP = matching piping.	MODEL# 5481-CP 5481-MP	List price																																																		
			<table border="1"> <tr> <td></td><td>1</td><td>2</td><td>3</td><td>4</td><td>5</td><td>6</td><td>7</td><td>8</td><td>9</td><td>10</td><td>11</td><td>12</td> </tr> <tr> <td>5481-CP</td><td>2004</td><td>2132</td><td>2239</td><td>2363</td><td>2567</td><td>2754</td><td>2942</td><td>3105</td><td>3309</td><td>3500</td><td>3760</td><td>4127</td> </tr> <tr> <td>5481-MP</td><td>1862</td><td>1990</td><td>2098</td><td>2222</td><td>2426</td><td>2614</td><td>2802</td><td>2966</td><td>3170</td><td>3362</td><td>3622</td><td>3990</td> </tr> </table>													1	2	3	4	5	6	7	8	9	10	11	12	5481-CP	2004	2132	2239	2363	2567	2754	2942	3105	3309	3500	3760	4127	5481-MP	1862	1990	2098	2222	2426	2614	2802	2966	3170	3362	3622	3990
				1	2	3	4	5	6	7	8	9	10	11	12																																						
			5481-CP	2004	2132	2239	2363	2567	2754	2942	3105	3309	3500	3760	4127																																						
			5481-MP	1862	1990	2098	2222	2426	2614	2802	2966	3170	3362	3622	3990																																						
OVERALL DIMENSIONS			SEAT DIMENSIONS			BACK DIMENSIONS																																															
W	D	H	W	D	H	W	H																																														
IN 29.5	29	30.5	21	19.5	18	20	11.5																																														
MM 749	737	775	533	495	457	508	292																																														
		RTA 00	1 per carton																																																		

DESCRIPTION FEATURES MODEL# STANDARD TEXTILE GRADES

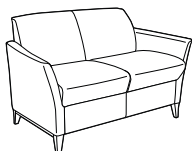

Two Seat Sofa w/Aluminum Legs
 COM: 5.75 YD | 5.26 M
 Unit weight: 74 LB | 33.6 KG
 Carton weight: 86 LB | 39.01 KG
 Carton volume: 36 FT³ | 1.01 MT³

No piping.

MODEL#	1	2	3	4	5	6	7	8	9	10	11	12
5482	2675	2859	3014	3193	3486	3756	4026	4262	4555	4831	5205	5734

OVERALL DIMENSIONS SEAT DIMENSIONS BACK DIMENSIONS
 W D H W D H W H

IN	51	29	30.5	42	19.5	18	41	11.5
MM	1295	737	775	1067	495	457	1041	292

RTA 00 1 per carton

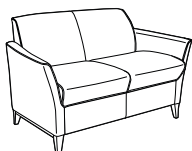

Two Seat Sofa w/Aluminum Legs
 COM: 5.75 YD | 5.26 M
 Unit weight: 74 LB | 33.6 KG
 Carton weight: 86 LB | 39.01 KG
 Carton volume: 36 FT³ | 1.01 MT³

CP = contrast piping.
 MP = matching piping.

MODEL#	1	2	3	4	5	6	7	8	9	10	11	12
5482-CP	2861	3045	3200	3378	3670	3940	4210	4445	4738	5014	5387	5915
5482-MP	2675	2859	3014	3193	3486	3756	4026	4262	4555	4831	5205	5734

OVERALL DIMENSIONS SEAT DIMENSIONS BACK DIMENSIONS
 W D H W D H W H

IN	51	29	30.5	42	19.5	18	41	11.5
MM	1295	737	775	1067	495	457	1041	292

RTA 00 1 per carton

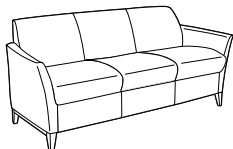

Three Seat Sofa w/Aluminum Legs
 COM: 7.5 YD | 6.86 M
 Unit weight: 97 LB | 44.1 KG
 Carton weight: 112 LB | 50.8 KG
 Carton volume: 50.25 FT³ | 1.42 MT³

No piping.

MODEL#	1	2	3	4	5	6	7	8	9	10	11	12
5483	3490	3730	3933	4165	4548	4900	5253	5560	5943	6303	6790	7480

OVERALL DIMENSIONS SEAT DIMENSIONS BACK DIMENSIONS
 W D H W D H W H

IN	71	29	30.5	63	19.5	18	62	11.5
MM	1803	737	775	1600	495	457	1575	292

RTA 00 1 per carton

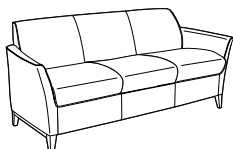

Three Seat Sofa w/Aluminum Legs
 COM: 7.5 YD | 6.86 M
 Unit weight: 97 LB | 44.1 KG
 Carton weight: 112 LB | 50.8 KG
 Carton volume: 50.25 FT³ | 1.42 MT³

CP = contrast piping.
 MP = matching piping.

MODEL#	1	2	3	4	5	6	7	8	9	10	11	12
5483-CP	3717	3957	4159	4391	4773	5125	5477	5784	6166	6526	7013	7702
5483-MP	3490	3730	3933	4165	4548	4900	5253	5560	5943	6303	6790	7480

OVERALL DIMENSIONS SEAT DIMENSIONS BACK DIMENSIONS
 W D H W D H W H

IN	71	29	30.5	63	19.5	18	62	11.5
MM	1803	737	775	1600	495	457	1575	292

RTA 00 1 per carton



Coffee Table - 22" x 48" Rectangle w/Aluminum Legs
 COM: N/A
 Unit weight: 38 LB | 17.3 KG
 Carton weight: 46 LB | 20.87 KG
 Carton volume: 4 FT³ | 0.11 MT³

List price

5484-LP	1606
5484-HP	1717
5484-W	2047

LP = Laminate top HP = High pressure laminate top W = Wood top

OVERALL DIMENSIONS SEAT DIMENSIONS BACK DIMENSIONS
 W D H W D H W H

IN	22	48	17.5	19.5	18	20	11.5
MM	559	1219	445	533	495	457	508

RTA 6 1 per carton

DESCRIPTION	FEATURES	MODEL#	STANDARD TEXTILE GRADES							
 <p>End Table - 21" x 21" Square w/Aluminum Legs COM: N/A Unit weight: 23 LB 10.5 KG Carton weight: 26 LB 11.79 KG Carton volume: 2.1 FT³ 0.05 MT³</p>			List price							
			5485-LP	1222						
			5485-HP	1332						
			5485-W	1465						
			LP = Laminate top HP = High pressure laminate top W = Wood top							
			OVERALL DIMENSIONS			SEAT DIMENSIONS			BACK DIMENSIONS	
			W	D	H	W	D	H	W	H
		IN	21	21	17.5	-	-	-	-	-
		MM	533	533	445	-	-	-	-	-
			RTA 8		1 per carton					

 <p>End Table - 24" Round w/Aluminum Legs COM: N/A Unit weight: 24 LB 10.9 KG Carton weight: 27 LB 12.25 KG Carton volume: 2.1 FT³ 0.05 MT³</p>			List price							
			5486-LP	1252						
			5486-HP	1361						
			5486-W	1577						
			LP = Laminate top HP = High pressure laminate top W = Wood top							
			OVERALL DIMENSIONS			SEAT DIMENSIONS			BACK DIMENSIONS	
			W	D	H	W	D	H	W	H
		IN	24	24	17.5	-	-	-	-	-
		MM	610	610	445	-	-	-	-	-
			RTA 8		1 per carton					

 <p>Coffee Table - 32" Round w/Aluminum Legs COM: N/A Unit weight: 33 LB 15 KG Carton weight: 41 LB 18.6 KG Carton volume: 4.4 FT³ 0.12 MT³</p>			List price							
			5487-LP	1848						
			5487-HP	1959						
			5487-W	2319						
			LP = Laminate top HP = High pressure laminate top W = Wood top							
			OVERALL DIMENSIONS			SEAT DIMENSIONS			BACK DIMENSIONS	
			W	D	H	W	D	H	W	H
		IN	32	32	17.5	-	-	-	-	-
		MM	813	813	445	-	-	-	-	-
			RTA 8		1 per carton					

CITI



model 7875RTL

model 7889



Citi Modular Group & Tables - shown in Tungsten

Leg options



5" tubular metal leg (shown in Tungsten finish)



5" tapered, softened edge, wood leg (shown in Maple finish)



STANDARD FEATURES

- Fully upholstered contemporary design, complements the timeless decor of many offices. Proportions are compact, 31" deep, work well in public spaces.
- All models have fixed, non-removable cushions.
- Arm height on all models is 25".
- Casters are not available on this series.
- Citi seat and table legs are 5" high tubular metal, standard in a Tungsten finish.
- Citi table tops are available in either tempered glass or laminate.
- Tablets are made from thermally fused laminate, 0.75" thick. Tablet arms measure 12"D x 16.5"W. Available right hand seated (RT), left hand seated (LT) or both right and left hand (LRT).
- Laminate tables and tablets are offered in the following finishes: Absolute Acajou (ACJ), Asian Night (ASN), Avant Cherry (AWC), Avant Honey (AWH), Black (BLK), Blizzard (BZD), Brushed Cobalt (BRC), Clear Maple (CMB), Custom Grey (CGY), Dark Espresso (DES), Designer White (DWT), Fashionista (FAS), First Class (FCL), Noce Biondo (NBL), Noce Grigio (NGL), Noce Leggero (NEL), Noce Medio (NML), Quartered Mahogany (QTM), Sheer Beauty (SBY), Stonedust (SDT), Storm Grey (SOG), Walnut Heights (WHE), White Chocolate (WHC) and Winter Cherry (WCR). Please specify.
- Ganging brackets (#7892) are sold separately. Ganging brackets are to be used on armless seating if interconnection to another armless seating unit is required. Bench and ottomans only gang to other benches/ottomans, cannot gang with seating units. Brackets come with a template for installation.
- Upholstery options: fabric, vinyl or leather. Vinyl and leather models may feature stitch detail across the seat and/or back cushions, if applicable.

OPTIONAL FEATURES

- For highly resilient, high density Ultracell foam on seat, please specify (UC) after the model number. One seater add \$99. Two seater add \$197. Three seater add \$295.
- Leg options:**
 - (MTL) Metal legs
For metal leg finish options, please see page 379. For Chrome (CHM) finish, add \$68.
 - (WDL) Wood legs
Non-cylindrical wood legs available in the following finishes. Add \$300.
 - (AAM) Absolute
 - (BKM) Black
 - (CJM) Charcoal Java
 - (ACM) Cherry
 - (EMM) Empire Mahogany
 - (EOM) English Oak
 - (ECM) Espresso Cafe
 - (TFM) Fruitwood
 - (HGM) Gray
 - (HOM) Harvest Oak
 - (AHM) Honey
 - (JOM) Jet Onyx
 - (LHM) Light Honey
 - (TMM) Mahogany
 - (AVM) Maple
 - (MWM) Medium Walnut
 - (NLW) Natural Walnut
 - (ASM) Night
 - (NBM) Noce Biondo
 - (NGM) Noce Grigio
 - (NEM) Noce Leggero
 - (NMM) Noce Medio
 - (SBM) Sandy Beach
 - (SKM) Shaker Cherry
 - (SOM) Silver Oak
 - (TWM) Walnut
 - (WTM) WC Cream
 - (WHM) White
 - (WCM) Winter Cherry
- Glide type** (wood legs only)
 - (NM) White non-marking nylon for most surfaces (standard)
 - (SG) steel cushioned glides for carpeted surfaces. Add \$17.
 - (RG) non-slip rubber glides for most hard floor surfaces. Add \$22.
 - (FG) felt glides for most hard floor surfaces. Add \$22.
- Table legs are available in Black (TBL), or Tungsten (TTU), please specify. For Chrome (CHM) finish. Add \$68.
- If you would like fabric/vinyl on the shell of a chair with leather seat + back cushions, please submit a [multi fabric form](#) (multi fabric grade will apply). Please note: the reverse is not available (leather on the shell of the chair with fabric/vinyl seat + back cushions).

DESCRIPTION FEATURES MODEL# STANDARD TEXTILE GRADES

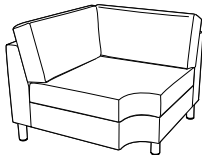

Corner Seat
COM: 6.25 YD | 5.72 M
Unit weight: 65 LB | 29.5 KG
Carton weight: 75 LB | 34.02 KG
Carton volume: 30.25 FT³ | 0.85 MT³

Ganging hardware not included.
Armless side(s) can be equipped with ganging brackets, model 7892.

	1	2	3	4	5	6	7	8	9	10	11	12
7862	-	-	-	-	1577	1871	2165	2421	2740	3040	3446	4021

OVERALL DIMENSIONS			SEAT DIMENSIONS			BACK DIMENSIONS		
W	D	H	W	D	H	W	H	

IN	37	37	31	26	26	17.5	26	13.5
MM	940	940	787	660	660	445	660	343

RTA 00 1 per carton

	1	2	3	4	5	6	7	8	9	10	11	12
7875	-	-	-	-	1124	1335	1548	1731	1962	2178	2469	2883

OVERALL DIMENSIONS			SEAT DIMENSIONS			BACK DIMENSIONS		
W	D	H	W	D	H	W	H	







IN	30	31	30	22	19.5	17.5	22	12.5
MM	762	787	762	559	495	445	559	318

RTA 00 1 per carton

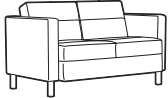

Lounge Chair
COM: 4.5 YD | 4.11 M
Unit weight: 57 LB | 25.9 KG
Carton weight: 67 LB | 30.39 KG
Carton volume: 21 FT³ | 0.59 MT³

Freestanding unit only.

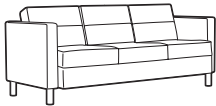
DESCRIPTION	FEATURES	MODEL#	STANDARD TEXTILE GRADES													
			1	2	3	4	5	6	7	8	9	10	11	12		
 7875LTL  7875RTL <p>Lounge Chair w/Laminate Tablet COM: 4.5 YD 4.11 M Unit weight: 65 LB 29.5 KG Carton weight: 75 LB 34.02 KG Carton volume: 22.5 FT³ 0.63 MT³</p>	Freestanding unit only.	7875LTL 7875RTL	-	-	-	-	1536	1747	1960	2143	2374	2590	2881	3295		
			OVERALL DIMENSIONS			SEAT DIMENSIONS			BACK DIMENSIONS							
			W	D	H	W	D	H	W	H						
			IN 31.5	33.5	30	22	19.5	17.5	22	12.5						
			MM 800	851	762	559	495	445	559	318						
			RTA 00	1 per carton												
 <p>Ganging Bracket Kit COM: N/A Unit weight: 0.25 LB 0.1 KG Carton weight: 0.25 LB 0.11 KG Carton volume: 0.02 FT³ 0.0003 MT³</p>	Kit includes 2 brackets, 4 screws and a template. Only one set is needed per unit.	7892	List price													
			17													
			OVERALL DIMENSIONS			SEAT DIMENSIONS			BACK DIMENSIONS							
			W	D	H	W	D	H	W	H						
			IN 0.5	3.87	2	-	-	-	-	-						
MM 13	98	51	-	-	-	-	-									
			RTA 00													
 <p>Lounge Chair - Armless COM: 3 YD 2.74 M Unit weight: 39 LB 17.7 KG Carton weight: 45 LB 20.41 KG Carton volume: 15.5 FT³ 0.43 MT³</p>	Ganging hardware not included. Armless side(s) can be equipped with ganging brackets, model 7892.	7895	1	2	3	4	5	6	7	8	9	10	11	12		
			-	-	-	-	1124	1265	1407	1529	1683	1827	2021	2297		
			OVERALL DIMENSIONS			SEAT DIMENSIONS			BACK DIMENSIONS							
			W	D	H	W	D	H	W	H						
			IN 22	31	30.75	22	18.5	17.5	22	12.5						
MM 559	787	781	559	470	445	559	318									
			RTA 00	1 per carton												
 <p>Two Seat Sofa COM: 6.25 YD 5.72 M Unit weight: 113 LB 51.4 KG Carton weight: 125 LB 56.7 KG Carton volume: 36 FT³ 1.01 MT³</p>	Freestanding unit only.	7876	1	2	3	4	5	6	7	8	9	10	11	12		
			-	-	-	-	1577	1871	2165	2421	2740	3040	3446	4021		
			OVERALL DIMENSIONS			SEAT DIMENSIONS			BACK DIMENSIONS							
			W	D	H	W	D	H	W	H						
			IN 51.25	31	30	43.25	19.5	17.5	43.25	12.5						
MM 1302	787	762	1099	495	445	1099	318									
			RTA 00	1 per carton												
 <p>Two Seat Sofa - Armless COM: 5 YD 4.57 M Unit weight: 81 LB 36.8 KG Carton weight: 93 LB 42.18 KG Carton volume: 36 FT³ 1.01 MT³</p>	Ganging hardware not included. Armless side(s) can be equipped with ganging brackets, model 7892.	7896	1	2	3	4	5	6	7	8	9	10	11	12		
			-	-	-	-	1577	1812	2047	2252	2507	2747	3072	3532		
			OVERALL DIMENSIONS			SEAT DIMENSIONS			BACK DIMENSIONS							
			W	D	H	W	D	H	W	H						
			IN 43.25	31	30.75	43.25	19.5	17.5	43.25	13.25						
MM 1099	787	781	1099	495	445	1099	337									
			RTA 00	1 per carton												
 <p>Three Seat Sofa COM: 8.75 YD 8 M Unit weight: 149 LB 67.7 KG Carton weight: 163 LB 73.94 KG Carton volume: 50.25 FT³ 1.42 MT³</p>	Freestanding unit only.	7877	1	2	3	4	5	6	7	8	9	10	11	12		
			-	-	-	-	2032	2444	2855	3214	3660	4080	4649	5454		
			OVERALL DIMENSIONS			SEAT DIMENSIONS			BACK DIMENSIONS							
			W	D	H	W	D	H	W	H						
			IN 72.5	31	30	64.5	19.5	17.5	64.5	12.5						
MM 1842	787	762	1638	495	445	1638	318									
			RTA 00	1 per carton												

DESCRIPTION	FEATURES	MODEL#	STANDARD TEXTILE GRADES											
			1	2	3	4	5	6	7	8	9	10	11	12



Three Seat Sofa - Armless
 COM: 7.25 YD | 6.63 M
 Unit weight: 117 LB | 53.2 KG
 Carton weight: 131 LB | 59.42 KG
 Carton volume: 50.25 FT³ | 1.42 MT³

Ganging hardware not included.
 Armless side(s) can be equipped with ganging brackets, model 7892.

7897	-	-	-	-	2032	2373	2714	3011	3381	3729	4200	4867
------	---	---	---	---	------	------	------	------	------	------	------	------

OVERALL DIMENSIONS			SEAT DIMENSIONS			BACK DIMENSIONS	
W	D	H	W	D	H	W	H

IN	64.5	31	30.75	64.5	19.5	17.5	64.5	13.25
MM	1638	787	781	1638	495	445	1638	337

RTA 00 1 per carton



Ottoman
 COM: 1.5 YD | 1.37 M
 Unit weight: 23 LB | 10.5 KG
 Carton weight: 27 LB | 12.25 KG
 Carton volume: 7.5 FT³ | 0.21 MT³

Ganging hardware not included.
 Side(s) can be equipped with ganging brackets, model 7892. Does not gang to seating units.

7879	-	-	-	-	562	633	703	765	841	913	1011	1149
------	---	---	---	---	-----	-----	-----	-----	-----	-----	------	------

OVERALL DIMENSIONS			SEAT DIMENSIONS			BACK DIMENSIONS	
W	D	H	W	D	H	W	H

IN	22	22	17	-	-	-	-	-
MM	559	559	432	-	-	-	-	-

RTA 00  1 per carton

List price

7885	715
------	-----

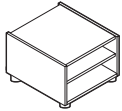

End Table - Laminate Top
 COM: N/A
 Unit weight: 45 LB | 20.5 KG
 Carton weight: 53 LB | 24.04 KG
 Carton volume: 6 FT³ | 0.16 MT³

OVERALL DIMENSIONS			SEAT DIMENSIONS			BACK DIMENSIONS	
W	D	H	W	D	H	W	H

IN	20	24	20	-	-	-	-	-
MM	508	610	508	-	-	-	-	-

RTA 1  1 per carton

List price

7886	934
------	-----

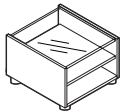

End Table - Glass Top
 COM: N/A
 Unit weight: 52 LB | 23.6 KG
 Carton weight: 60 LB | 27.22 KG
 Carton volume: 6 FT³ | 0.16 MT³

OVERALL DIMENSIONS			SEAT DIMENSIONS			BACK DIMENSIONS	
W	D	H	W	D	H	W	H

IN	20	24	20	-	-	-	-	-
MM	508	610	508	-	-	-	-	-

RTA 1 1 per carton

List price

7887	747
------	-----

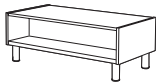

Coffee Table Rectangular - Laminate top
 COM: N/A
 Unit weight: 50 LB | 22.7 KG
 Carton weight: 60 LB | 27.22 KG
 Carton volume: 6.5 FT³ | 0.18 MT³

OVERALL DIMENSIONS			SEAT DIMENSIONS			BACK DIMENSIONS	
W	D	H	W	D	H	W	H

IN	40	20	15	-	-	-	-	-
MM	1016	508	381	-	-	-	-	-

RTA 1  1 per carton

List price

7888	1079
------	------

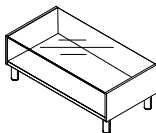





Coffee Table Rectangular - Glass Top
 COM: N/A
 Unit weight: 65 LB | 29.5 KG
 Carton weight: 75 LB | 34.02 KG
 Carton volume: 6.5 FT³ | 0.18 MT³

OVERALL DIMENSIONS			SEAT DIMENSIONS			BACK DIMENSIONS	
W	D	H	W	D	H	W	H

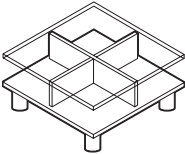
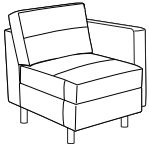
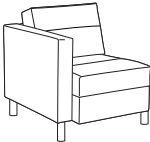
IN	40	20	15	-	-	-	-	-
MM	1016	508	381	-	-	-	-	-

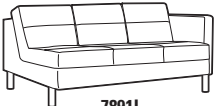
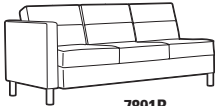
RTA 1 1 per carton

DESCRIPTION	FEATURES	MODEL#	STANDARD TEXTILE GRADES																																																		
 <p>Coffee Table Square COM: N/A Unit weight: 80 LB 36.4 KG Carton weight: 90 LB 40.82 KG Carton volume: 8.75 FT³ 0.24 MT³</p>			List price																																																		
			<p>7889 1283 Glass top</p>																																																		
			OVERALL DIMENSIONS W D H			SEAT DIMENSIONS W D H			BACK DIMENSIONS W H																																												
IN 33 33 15 MM 838 838 381			- - - - - -			- - - - - -																																															
			RTA 1			1 per carton																																															
 <p>7901L</p> <p>Lounge Chair - One Arm COM: 4 YD 3.66 M Unit weight: 55 LB 25 KG Carton weight: 65 LB 29.48 KG Carton volume: 21 FT³ 0.59 MT³</p>	 <p>7901R</p> <p>Ganging hardware not included. Armless side can be equipped with ganging brackets, model 7892.</p>		<table border="1"> <thead> <tr> <th></th> <th>1</th> <th>2</th> <th>3</th> <th>4</th> <th>5</th> <th>6</th> <th>7</th> <th>8</th> <th>9</th> <th>10</th> <th>11</th> <th>12</th> </tr> </thead> <tbody> <tr> <td>7901L</td> <td>-</td> <td>-</td> <td>-</td> <td>-</td> <td>1124</td> <td>1313</td> <td>1500</td> <td>1665</td> <td>1868</td> <td>2060</td> <td>2321</td> <td>2689</td> </tr> <tr> <td>7901R</td> <td>-</td> <td>-</td> <td>-</td> <td>-</td> <td>-</td> <td>-</td> <td>-</td> <td>-</td> <td>-</td> <td>-</td> <td>-</td> <td>-</td> </tr> </tbody> </table>													1	2	3	4	5	6	7	8	9	10	11	12	7901L	-	-	-	-	1124	1313	1500	1665	1868	2060	2321	2689	7901R	-	-	-	-	-	-	-	-	-	-	-	-
				1	2	3	4	5	6	7	8	9	10	11	12																																						
			7901L	-	-	-	-	1124	1313	1500	1665	1868	2060	2321	2689																																						
7901R	-	-	-	-	-	-	-	-	-	-	-	-																																									
OVERALL DIMENSIONS W D H			SEAT DIMENSIONS W D H			BACK DIMENSIONS W H																																															
IN 26 31 30 MM 660 787 762			22 19.5 17.5 559 495 445			22 12.5 559 318																																															
			RTA 00			1 per carton																																															
 <p>7890L</p> <p>Two Seat Sofa - One Arm COM: 5.25 YD 4.8 M Unit weight: 95 LB 43.2 KG Carton weight: 107 LB 48.53 KG Carton volume: 36 FT³ 1.01 MT³</p>	 <p>7890R</p> <p>Ganging hardware not included. Armless side can be equipped with ganging brackets, model 7892.</p>		<table border="1"> <thead> <tr> <th></th> <th>1</th> <th>2</th> <th>3</th> <th>4</th> <th>5</th> <th>6</th> <th>7</th> <th>8</th> <th>9</th> <th>10</th> <th>11</th> <th>12</th> </tr> </thead> <tbody> <tr> <td>7890L</td> <td>-</td> <td>-</td> <td>-</td> <td>-</td> <td>1577</td> <td>1824</td> <td>2071</td> <td>2286</td> <td>2554</td> <td>2806</td> <td>3147</td> <td>3630</td> </tr> <tr> <td>7890R</td> <td>-</td> <td>-</td> <td>-</td> <td>-</td> <td>-</td> <td>-</td> <td>-</td> <td>-</td> <td>-</td> <td>-</td> <td>-</td> <td>-</td> </tr> </tbody> </table>													1	2	3	4	5	6	7	8	9	10	11	12	7890L	-	-	-	-	1577	1824	2071	2286	2554	2806	3147	3630	7890R	-	-	-	-	-	-	-	-	-	-	-	-
				1	2	3	4	5	6	7	8	9	10	11	12																																						
			7890L	-	-	-	-	1577	1824	2071	2286	2554	2806	3147	3630																																						
7890R	-	-	-	-	-	-	-	-	-	-	-	-																																									
OVERALL DIMENSIONS W D H			SEAT DIMENSIONS W D H			BACK DIMENSIONS W H																																															
IN 47.25 31 30.75 MM 1200 787 781			43.25 19.5 17.5 1099 495 445			43.25 13.25 1099 337																																															
			RTA 00			1 per carton																																															
 <p>7891L</p> <p>Three Seat Sofa - One Arm COM: 7.25 YD 6.63 M Unit weight: 124 LB 56.4 KG Carton weight: 138 LB 62.6 KG Carton volume: 50.25 FT³ 1.42 MT³</p>	 <p>7891R</p> <p>Ganging hardware not included. Armless side can be equipped with ganging brackets, model 7892.</p>		<table border="1"> <thead> <tr> <th></th> <th>1</th> <th>2</th> <th>3</th> <th>4</th> <th>5</th> <th>6</th> <th>7</th> <th>8</th> <th>9</th> <th>10</th> <th>11</th> <th>12</th> </tr> </thead> <tbody> <tr> <td>7891L</td> <td>-</td> <td>-</td> <td>-</td> <td>-</td> <td>2032</td> <td>2373</td> <td>2714</td> <td>3011</td> <td>3381</td> <td>3729</td> <td>4200</td> <td>4867</td> </tr> <tr> <td>7891R</td> <td>-</td> <td>-</td> <td>-</td> <td>-</td> <td>-</td> <td>-</td> <td>-</td> <td>-</td> <td>-</td> <td>-</td> <td>-</td> <td>-</td> </tr> </tbody> </table>													1	2	3	4	5	6	7	8	9	10	11	12	7891L	-	-	-	-	2032	2373	2714	3011	3381	3729	4200	4867	7891R	-	-	-	-	-	-	-	-	-	-	-	-
				1	2	3	4	5	6	7	8	9	10	11	12																																						
			7891L	-	-	-	-	2032	2373	2714	3011	3381	3729	4200	4867																																						
7891R	-	-	-	-	-	-	-	-	-	-	-	-																																									
OVERALL DIMENSIONS W D H			SEAT DIMENSIONS W D H			BACK DIMENSIONS W H																																															
IN 68.5 31 30.75 MM 1740 787 781			64.5 19.5 17.5 1638 495 445			64.5 13.25 1638 337																																															
			RTA 00			1 per carton																																															
 <p>7893</p> <p>Two Seat Bench COM: 2.25 YD 2.06 M Unit weight: 36 LB 16.4 KG Carton weight: 42 LB 19.05 KG Carton volume: 11.5 FT³ 0.32 MT³</p>			<table border="1"> <thead> <tr> <th></th> <th>1</th> <th>2</th> <th>3</th> <th>4</th> <th>5</th> <th>6</th> <th>7</th> <th>8</th> <th>9</th> <th>10</th> <th>11</th> <th>12</th> </tr> </thead> <tbody> <tr> <td>7893</td> <td>-</td> <td>-</td> <td>-</td> <td>-</td> <td>822</td> <td>928</td> <td>1034</td> <td>1126</td> <td>1241</td> <td>1349</td> <td>1495</td> <td>1702</td> </tr> </tbody> </table>													1	2	3	4	5	6	7	8	9	10	11	12	7893	-	-	-	-	822	928	1034	1126	1241	1349	1495	1702													
				1	2	3	4	5	6	7	8	9	10	11	12																																						
			7893	-	-	-	-	822	928	1034	1126	1241	1349	1495	1702																																						
OVERALL DIMENSIONS W D H			SEAT DIMENSIONS W D H			BACK DIMENSIONS W H																																															
IN 43 21.5 17 MM 1092 546 432			- - - - - -			- - - - - -																																															
			RTA 00			1 per carton																																															
 <p>7894</p> <p>Three Seat Bench COM: 3.75 YD 3.43 M Unit weight: 54 LB 24.5 KG Carton weight: 62 LB 28.12 KG Carton volume: 16.75 FT³ 0.47 MT³</p>			<table border="1"> <thead> <tr> <th></th> <th>1</th> <th>2</th> <th>3</th> <th>4</th> <th>5</th> <th>6</th> <th>7</th> <th>8</th> <th>9</th> <th>10</th> <th>11</th> <th>12</th> </tr> </thead> <tbody> <tr> <td>7894</td> <td>-</td> <td>-</td> <td>-</td> <td>-</td> <td>1188</td> <td>1365</td> <td>1541</td> <td>1695</td> <td>1886</td> <td>2066</td> <td>2310</td> <td>2655</td> </tr> </tbody> </table>													1	2	3	4	5	6	7	8	9	10	11	12	7894	-	-	-	-	1188	1365	1541	1695	1886	2066	2310	2655													
				1	2	3	4	5	6	7	8	9	10	11	12																																						
			7894	-	-	-	-	1188	1365	1541	1695	1886	2066	2310	2655																																						
OVERALL DIMENSIONS W D H			SEAT DIMENSIONS W D H			BACK DIMENSIONS W H																																															
IN 64.5 21.5 17 MM 1638 546 432			- - - - - -			- - - - - -																																															
			RTA 00			1 per carton																																															

CITISQUARE



model S7875LT



Sample Layout A - Models shown: S7875FUC and S7911



Sample Layout B - Models shown: S7890RFUC, S7862FUC (2), S7897FUC, S7890LFUC and S7912.

STANDARD FEATURES

- Fully upholstered lounge series with a complete range of sectional components for all applications. Proportions are compact, 31" deep, work well in public spaces.
- All models have fixed, non-removable cushions.
- Arm height on all models is 25".
- Casters are not available on this series.
- Citi Square seat and table legs are 5" high, single-piece welded frames.
- Citi Square tables are made with high pressure laminate.
- Tablets are made from thermally fused laminate, 0.75" thick. Tablet arms measure 12"D x 16.5"W. Available right hand seated (RT), left hand seated (LT) or both right and left hand (LRT).
- Laminate tables and tablets are offered in the following finishes: Absolute Acajou (ACJ), Asian Night (ASN), Avant Cherry (AWC), Avant Honey (AWH), Black (BLK), Blizzard (BZD), Brushed Cobalt (BRC), Clear Maple (CMB), Custom Grey (CGY), Dark Espresso (DES), Designer White (DWT), Fashionista (FAS), First Class (FCL), Noce Biondo (NBL), Noce Grigio (NGL), Noce Leggero (NEL), Noce Medio (NML), Quartered Mahogany (QTM), Sheer Beauty (SBY), Stonedust (SDT), Storm Grey (SOG), Walnut Heights (WHE), White Chocolate (WHC) and Winter Cherry (WCR). Please specify. Custom high pressure laminate finishes will be considered upon request.
- Ganging brackets (#7892) are sold separately. Ganging brackets are to be used on armless seating if interconnection to another armless seating unit is required. Bench and ottomans only gang to other benches/ottomans, cannot gang with seating units. Brackets come with a template for installation.
- Upholstery options: fabric, vinyl or leather. Vinyl and leather models may feature stitch detail across the seat and/or back cushions, if applicable.

OPTIONAL FEATURES

- For highly resilient, high density Ultracell foam on seat, please specify (UC) after the model number. One seater add \$99. Two seater add \$197. Three seater add \$295. Four seater add \$395.
- For leg frame finish options, please see page 379. Upcharges apply for plated finishes:
 - (CHM) Chrome. Add \$131.
 - (BCH) Brushed Chrome. Add \$246 for corner units. Add \$177 for single seat units. Add \$220 for two seat units. Add \$270 for three seat units. Add \$320 for four seat units.
 - (SBR) Satin Brass. Add \$377 for corner units. Add \$281 for single seat units. Add \$381 for two seat units. Add \$481 for three seat units. Add \$581 for four seat units.
 - (ACO) Antique Copper. Add \$377 for corner units. Add \$281 for single seat units. Add \$381 for two seat units. Add \$481 for three seat units. Add \$581 for four seat units.
- For leg frame finish options on occasional tables, please see page 379. Upcharges apply for plated finishes (see models for upcharges).
- Power/USB units are available in tables. Each unit includes two power outlets and two double USB terminals and is equipped with a 6' long three-prong power cord. The power units are available in Jet Black (J1) or White (W1). Add \$729 per unit. Please see electrical placement below for predetermined locations.
- If you would like fabric/vinyl on the shell of a chair with leather seat + back cushions, please submit a multi fabric form (multi fabric grade will apply). Please note: the reverse is not available (leather on the shell of the chair with fabric/vinyl seat + back cushions).

ELECTRICAL PLACEMENT

Coffee/End Tables: Predetermined location is on the end/side of the unit J1 (Black) or W1 (White).

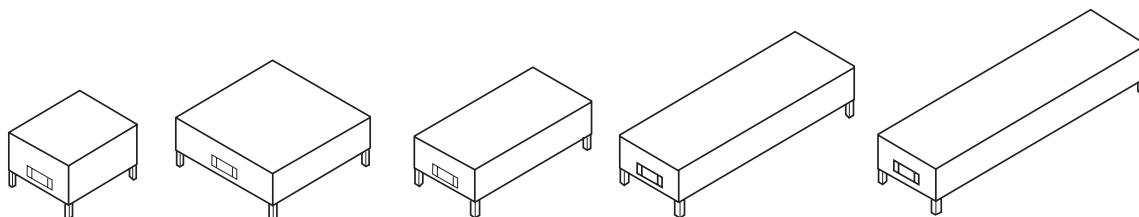

DESCRIPTION

FEATURES

MODEL #

STANDARD TEXTILE GRADES

List price

7892 17



Ganging Bracket Kit

COM: N/A

Unit weight: 0.25 LB | 0.1 KG

Carton weight: 0.25 LB | 0.11 KG

Carton volume: 0.01 FT³ | 0.0003 M³

Kit includes 2 brackets, 4 screws and a template. Only one set is needed per unit.

OVERALL DIMENSIONS

	W	D	H
IN	0.5	3.87	2
MM	13	98	51

SEAT DIMENSIONS



	W	D	H
	-	-	-
	-	-	-



BACK DIMENSIONS



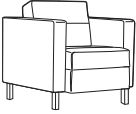

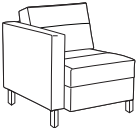
	W	H
	-	-
	-	-

RTA 00

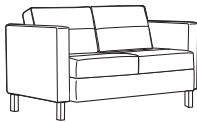
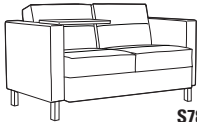
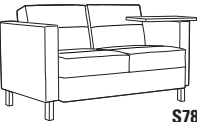
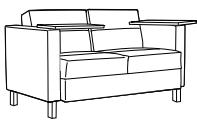
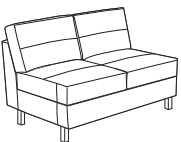

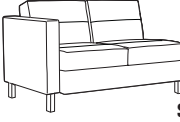
DESCRIPTION	FEATURES	MODEL#	STANDARD TEXTILE GRADES											
			1	2	3	4	5	6	7	8	9	10	11	12
 <p>Linking Corner Unit COM: 6.25 YD 5.72 M Unit weight: 65 LB 29.5 KG Carton weight: 75 LB 34.02 KG Carton volume: 30.25 FT³ 0.85 MT³</p>	<p>Ganging hardware not included.</p> <p>Armless side(s) can be equipped with ganging brackets, model 7892.</p>	S7862	-	-	-	-	1792	2086	2380	2636	2955	3255	3661	4236
			OVERALL DIMENSIONS			SEAT DIMENSIONS			BACK DIMENSIONS					
			W	D	H	W	D	H	W	H				
			IN 37	37	31	26	26	17.5	26	13.5				
			MM 940	940	787	660	660	445	660	343				
		RTA 00	1 per carton											
 <p>Single Seat w/Arms COM: 4.5 YD 4.11 M Unit weight: 71 LB 32.3 KG Carton weight: 81 LB 36.74 KG Carton volume: 21 FT³ 0.59 MT³</p>	<p>Freestanding unit only.</p>	S7875	-	-	-	-	1265	1477	1688	1873	2102	2318	2611	3025
			OVERALL DIMENSIONS			SEAT DIMENSIONS			BACK DIMENSIONS					
			W	D	H	W	D	H	W	H				
			IN 30	31	30	22	19.5	17.5	22	12.5				
			MM 762	787	762	559	495	445	559	318				
		RTA 00	1 per carton											
 <p>Single Seat w/Arms & Laminate Tablet COM: 4.5 YD 4.11 M Unit weight: 79 LB 35.9 KG Carton weight: 89 LB 40.37 KG Carton volume: 22.5 FT³ 0.63 MT³</p>	<p>Freestanding unit only.</p>	S7875LT	-	-	-	-	1676	1888	2099	2284	2513	2729	3022	3436
			OVERALL DIMENSIONS			SEAT DIMENSIONS			BACK DIMENSIONS					
			W	D	H	W	D	H	W	H				
			IN 31.5	33.5	30	22	19.5	17.5	22	12.5				
			MM 800	851	762	559	495	445	559	318				
		RTA 00	1 per carton											
 <p>Armless Single Seat COM: 3 YD 2.74 M Unit weight: 39 LB 17.7 KG Carton weight: 45 LB 20.41 KG Carton volume: 15.5 FT³ 0.43 MT³</p>	<p>Ganging hardware not included.</p> <p>Armless side(s) can be equipped with ganging brackets, model 7892.</p>	S7895	-	-	-	-	1265	1406	1547	1670	1823	1967	2162	2438
			OVERALL DIMENSIONS			SEAT DIMENSIONS			BACK DIMENSIONS					
			W	D	H	W	D	H	W	H				
			IN 22	31	30.75	22	18.5	17.5	22	12.5				
			MM 559	787	781	559	470	445	559	318				
		RTA 00	1 per carton											
 <p>Single Seat w/One Arm COM: 4 YD 3.66 M Unit weight: 55 LB 25 KG Carton weight: 65 LB 29.48 KG Carton volume: 21 FT³ 0.59 MT³</p>	<p>Ganging hardware not included.</p> <p>Armless side can be equipped with ganging brackets, model 7892.</p>	S7901L	-	-	-	-	1265	1453	1641	1805	2009	2201	2461	2829
			OVERALL DIMENSIONS			SEAT DIMENSIONS			BACK DIMENSIONS					
			W	D	H	W	D	H	W	H				
			IN 26	31	30.75	22	19.5	17.5	22	12.5				
			MM 660	787	781	559	495	445	559	318				
		RTA 00	1 per carton											

DESCRIPTION	FEATURES	MODEL#	STANDARD TEXTILE GRADES																																
			1	2	3	4	5	6	7	8	9	10	11	12																					
 <p>S7901RRT</p> <p>Single Seat w/One Arm & Laminate Tablet COM: 4 YD 3.66 M Unit weight: 63 LB 28.6 KG Carton weight: 73 LB 33.11 KG Carton volume: 22.5 FT³ 0.63 MT³</p>	 <p>S7901LLT</p> <p>Ganging hardware not included. Armless side(s) can be equipped with ganging brackets, model 7892.</p>	<p>S7901LLT S7901RRT</p> <table border="1"> <tr> <td>1</td><td>2</td><td>3</td><td>4</td><td>5</td><td>6</td><td>7</td><td>8</td><td>9</td><td>10</td><td>11</td><td>12</td> </tr> <tr> <td>-</td><td>-</td><td>-</td><td>-</td><td>1676</td><td>1864</td><td>2052</td><td>2216</td><td>2420</td><td>2612</td><td>2872</td><td>3240</td> </tr> </table>	1	2	3	4	5	6	7	8	9	10	11	12	-	-	-	-	1676	1864	2052	2216	2420	2612	2872	3240	<p>OVERALL DIMENSIONS</p> <p>W D H</p>			<p>SEAT DIMENSIONS</p> <p>W D H</p>			<p>BACK DIMENSIONS</p> <p>W H</p>		
			1	2	3	4	5	6	7	8	9	10	11	12																					
			-	-	-	-	1676	1864	2052	2216	2420	2612	2872	3240																					
			IN 27.5	31	30.75	22	19.5	17.5	22	12.5																									
MM 699	787	781	559	495	445	559	318																												
<p>RTA 00</p> <p>1 per carton</p>																																			
 <p>S7876</p> <p>Two Seater w/Arms COM: 6.25 YD 5.72 M Unit weight: 110 LB 50 KG Carton weight: 122 LB 55.34 KG Carton volume: 36 FT³ 1.01 MT³</p>	<p>Freestanding unit only.</p>	<p>S7876</p> <table border="1"> <tr> <td>1</td><td>2</td><td>3</td><td>4</td><td>5</td><td>6</td><td>7</td><td>8</td><td>9</td><td>10</td><td>11</td><td>12</td> </tr> <tr> <td>-</td><td>-</td><td>-</td><td>-</td><td>1792</td><td>2086</td><td>2380</td><td>2636</td><td>2955</td><td>3255</td><td>3661</td><td>4236</td> </tr> </table>	1	2	3	4	5	6	7	8	9	10	11	12	-	-	-	-	1792	2086	2380	2636	2955	3255	3661	4236	<p>OVERALL DIMENSIONS</p> <p>W D H</p>			<p>SEAT DIMENSIONS</p> <p>W D H</p>			<p>BACK DIMENSIONS</p> <p>W H</p>		
			1	2	3	4	5	6	7	8	9	10	11	12																					
			-	-	-	-	1792	2086	2380	2636	2955	3255	3661	4236																					
			IN 51.25	31	30	43.25	19.5	17.5	43.25	12.5																									
MM 1302	787	762	1099	495	445	1099	318																												
<p>RTA 00</p> <p>1 per carton</p>																																			
 <p>S7876RT</p>	 <p>S7876LT</p>	<p>S7876LT S7876RT</p> <table border="1"> <tr> <td>1</td><td>2</td><td>3</td><td>4</td><td>5</td><td>6</td><td>7</td><td>8</td><td>9</td><td>10</td><td>11</td><td>12</td> </tr> <tr> <td>-</td><td>-</td><td>-</td><td>-</td><td>2202</td><td>2496</td><td>2790</td><td>3046</td><td>3365</td><td>3665</td><td>4071</td><td>4646</td> </tr> </table>	1	2	3	4	5	6	7	8	9	10	11	12	-	-	-	-	2202	2496	2790	3046	3365	3665	4071	4646	<p>OVERALL DIMENSIONS</p> <p>W D H</p>			<p>SEAT DIMENSIONS</p> <p>W D H</p>			<p>BACK DIMENSIONS</p> <p>W H</p>		
			1	2	3	4	5	6	7	8	9	10	11	12																					
			-	-	-	-	2202	2496	2790	3046	3365	3665	4071	4646																					
			IN 52.75	33.5	30	43.25	19.5	17.5	43.25	12.5																									
MM 1340	851	762	1099	495	445	1099	318																												
<p>RTA 00</p> <p>1 per carton</p>																																			
 <p>S7876LRT</p>	<p>Freestanding unit only.</p> <p>Left and right tablets.</p>	<p>S7876LRT</p> <table border="1"> <tr> <td>1</td><td>2</td><td>3</td><td>4</td><td>5</td><td>6</td><td>7</td><td>8</td><td>9</td><td>10</td><td>11</td><td>12</td> </tr> <tr> <td>-</td><td>-</td><td>-</td><td>-</td><td>2614</td><td>2908</td><td>3202</td><td>3458</td><td>3777</td><td>4077</td><td>4483</td><td>5058</td> </tr> </table>	1	2	3	4	5	6	7	8	9	10	11	12	-	-	-	-	2614	2908	3202	3458	3777	4077	4483	5058	<p>OVERALL DIMENSIONS</p> <p>W D H</p>			<p>SEAT DIMENSIONS</p> <p>W D H</p>			<p>BACK DIMENSIONS</p> <p>W H</p>		
			1	2	3	4	5	6	7	8	9	10	11	12																					
			-	-	-	-	2614	2908	3202	3458	3777	4077	4483	5058																					
			IN 54.25	33.5	30	43.25	19.5	17.5	43.25	12.5																									
MM 1378	851	762	1099	495	445	1099	318																												
<p>RTA 00</p> <p>1 per carton</p>																																			
 <p>S7896</p> <p>Armless Two Seater COM: 5 YD 4.57 M Unit weight: 78 LB 35.5 KG Carton weight: 90 LB 40.82 KG Carton volume: 36 FT³ 1.01 MT³</p>	<p>Ganging hardware not included.</p> <p>Armless side(s) can be equipped with ganging brackets, model 7892.</p>	<p>S7896</p> <table border="1"> <tr> <td>1</td><td>2</td><td>3</td><td>4</td><td>5</td><td>6</td><td>7</td><td>8</td><td>9</td><td>10</td><td>11</td><td>12</td> </tr> <tr> <td>-</td><td>-</td><td>-</td><td>-</td><td>1792</td><td>2027</td><td>2262</td><td>2467</td><td>2722</td><td>2962</td><td>3287</td><td>3747</td> </tr> </table>	1	2	3	4	5	6	7	8	9	10	11	12	-	-	-	-	1792	2027	2262	2467	2722	2962	3287	3747	<p>OVERALL DIMENSIONS</p> <p>W D H</p>			<p>SEAT DIMENSIONS</p> <p>W D H</p>			<p>BACK DIMENSIONS</p> <p>W H</p>		
			1	2	3	4	5	6	7	8	9	10	11	12																					
			-	-	-	-	1792	2027	2262	2467	2722	2962	3287	3747																					
			IN 43.25	31	30.75	43.25	19.5	17.5	43.25	13.25																									
MM 1099	787	781	1099	495	445	1099	337																												
<p>RTA 00</p> <p>1 per carton</p>																																			

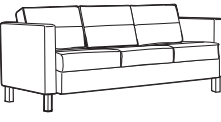
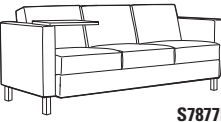
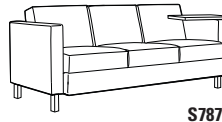
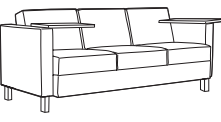
DESCRIPTION	FEATURES	MODEL#	STANDARD TEXTILE GRADES																													
			1	2	3	4	5	6	7	8	9	10	11	12																		
 <p>S7890L</p> <p>Two Seater w/One Arm COM: 5.25 YD 4.8 M Unit weight: 94 LB 42.7 KG Carton weight: 106 LB 48.08 KG Carton volume: 36 FT³ 1.01 MT³</p>	 <p>S7890L</p> <p>Ganging hardware not included. Armless side can be equipped with ganging brackets, model 7892.</p>	S7890L	-	-	-	-	1792	2039	2286	2501	2769	3021	3362	3845																		
		<table border="1"> <thead> <tr> <th colspan="3">OVERALL DIMENSIONS</th> <th colspan="3">SEAT DIMENSIONS</th> <th colspan="2">BACK DIMENSIONS</th> </tr> <tr> <th>W</th><th>D</th><th>H</th> <th>W</th><th>D</th><th>H</th> <th>W</th><th>H</th> </tr> </thead> <tbody> <tr> <td>IN 47.25</td><td>31</td><td>30.75</td> <td>43.25</td><td>19.5</td><td>17.5</td> <td>43.25</td><td>13.25</td> </tr> <tr> <td>MM 1200</td><td>787</td><td>781</td> <td>1099</td><td>495</td><td>445</td> <td>1099</td><td>337</td> </tr> </tbody> </table> <p>RTA 00 1 per carton</p>	OVERALL DIMENSIONS			SEAT DIMENSIONS			BACK DIMENSIONS		W	D	H	W	D	H	W	H	IN 47.25	31	30.75	43.25	19.5	17.5	43.25	13.25	MM 1200	787	781	1099	495	445
OVERALL DIMENSIONS			SEAT DIMENSIONS			BACK DIMENSIONS																										
W	D	H	W	D	H	W	H																									
IN 47.25	31	30.75	43.25	19.5	17.5	43.25	13.25																									
MM 1200	787	781	1099	495	445	1099	337																									
 <p>S7890LLT</p> <p>Two Seater w/One Arm and Laminate Tablet COM: 5.25 YD 4.8 M Unit weight: 102 LB 46.4 KG Carton weight: 114 LB 51.71 KG Carton volume: 41.25 FT³ 1.16 MT³</p>	 <p>S7890LLT</p> <p>Ganging hardware not included. Armless side(s) can be equipped with ganging brackets, model 7892.</p>	S7890LLT	-	-	-	-	2202	2449	2696	2911	3179	3431	3772	4255																		
		<table border="1"> <thead> <tr> <th colspan="3">OVERALL DIMENSIONS</th> <th colspan="3">SEAT DIMENSIONS</th> <th colspan="2">BACK DIMENSIONS</th> </tr> <tr> <th>W</th><th>D</th><th>H</th> <th>W</th><th>D</th><th>H</th> <th>W</th><th>H</th> </tr> </thead> <tbody> <tr> <td>IN 48.75</td><td>33.5</td><td>30.75</td> <td>43.25</td><td>19.5</td><td>17.5</td> <td>43.25</td><td>13.25</td> </tr> <tr> <td>MM 1238</td><td>851</td><td>781</td> <td>1099</td><td>495</td><td>445</td> <td>1099</td><td>337</td> </tr> </tbody> </table> <p>RTA 00 1 per carton</p>	OVERALL DIMENSIONS			SEAT DIMENSIONS			BACK DIMENSIONS		W	D	H	W	D	H	W	H	IN 48.75	33.5	30.75	43.25	19.5	17.5	43.25	13.25	MM 1238	851	781	1099	495	445
OVERALL DIMENSIONS			SEAT DIMENSIONS			BACK DIMENSIONS																										
W	D	H	W	D	H	W	H																									
IN 48.75	33.5	30.75	43.25	19.5	17.5	43.25	13.25																									
MM 1238	851	781	1099	495	445	1099	337																									
 <p>S7877</p> <p>Three Seater w/Arms COM: 8.75 YD 8 M Unit weight: 149 LB 67.7 KG Carton weight: 163 LB 73.94 KG Carton volume: 50.25 FT³ 1.42 MT³</p>	<p>Freestanding unit only.</p>	S7877	-	-	-	-	2316	2727	3139	3497	3944	4364	4932	5737																		
		<table border="1"> <thead> <tr> <th colspan="3">OVERALL DIMENSIONS</th> <th colspan="3">SEAT DIMENSIONS</th> <th colspan="2">BACK DIMENSIONS</th> </tr> <tr> <th>W</th><th>D</th><th>H</th> <th>W</th><th>D</th><th>H</th> <th>W</th><th>H</th> </tr> </thead> <tbody> <tr> <td>IN 72.5</td><td>31</td><td>30</td> <td>64.5</td><td>19.5</td><td>17.5</td> <td>64.5</td><td>12.5</td> </tr> <tr> <td>MM 1842</td><td>787</td><td>762</td> <td>1638</td><td>495</td><td>445</td> <td>1638</td><td>318</td> </tr> </tbody> </table> <p>RTA 00 1 per carton</p>	OVERALL DIMENSIONS			SEAT DIMENSIONS			BACK DIMENSIONS		W	D	H	W	D	H	W	H	IN 72.5	31	30	64.5	19.5	17.5	64.5	12.5	MM 1842	787	762	1638	495	445
OVERALL DIMENSIONS			SEAT DIMENSIONS			BACK DIMENSIONS																										
W	D	H	W	D	H	W	H																									
IN 72.5	31	30	64.5	19.5	17.5	64.5	12.5																									
MM 1842	787	762	1638	495	445	1638	318																									
 <p>S7877LT</p> <p>Three Seater w/Arms and Laminate Tablet COM: 8.75 YD 8 M Unit weight: 157 LB 71.4 KG Carton weight: 171 LB 77.56 KG Carton volume: 55.5 FT³ 1.57 MT³</p>	 <p>S7877LT</p> <p>Freestanding unit only.</p>	S7877LT	-	-	-	-	2727	3138	3550	3908	4355	4775	5343	6148																		
		<table border="1"> <thead> <tr> <th colspan="3">OVERALL DIMENSIONS</th> <th colspan="3">SEAT DIMENSIONS</th> <th colspan="2">BACK DIMENSIONS</th> </tr> <tr> <th>W</th><th>D</th><th>H</th> <th>W</th><th>D</th><th>H</th> <th>W</th><th>H</th> </tr> </thead> <tbody> <tr> <td>IN 74</td><td>33.5</td><td>30</td> <td>64.5</td><td>19.5</td><td>17.5</td> <td>64.5</td><td>12.5</td> </tr> <tr> <td>MM 1880</td><td>851</td><td>762</td> <td>1638</td><td>495</td><td>445</td> <td>1638</td><td>318</td> </tr> </tbody> </table> <p>RTA 00 1 per carton</p>	OVERALL DIMENSIONS			SEAT DIMENSIONS			BACK DIMENSIONS		W	D	H	W	D	H	W	H	IN 74	33.5	30	64.5	19.5	17.5	64.5	12.5	MM 1880	851	762	1638	495	445
OVERALL DIMENSIONS			SEAT DIMENSIONS			BACK DIMENSIONS																										
W	D	H	W	D	H	W	H																									
IN 74	33.5	30	64.5	19.5	17.5	64.5	12.5																									
MM 1880	851	762	1638	495	445	1638	318																									
 <p>S7877LRT</p> <p>Three Seater w/Arms and Laminate Tablets COM: 8.75 YD 8 M Unit weight: 165 LB 75 KG Carton weight: 179 LB 81.19 KG Carton volume: 55.5 FT³ 1.57 MT³</p>	<p>Freestanding unit only. Left and right tablets.</p>	S7877LRT	-	-	-	-	3138	3549	3961	4319	4766	5186	5754	6559																		
		<table border="1"> <thead> <tr> <th colspan="3">OVERALL DIMENSIONS</th> <th colspan="3">SEAT DIMENSIONS</th> <th colspan="2">BACK DIMENSIONS</th> </tr> <tr> <th>W</th><th>D</th><th>H</th> <th>W</th><th>D</th><th>H</th> <th>W</th><th>H</th> </tr> </thead> <tbody> <tr> <td>IN 75.5</td><td>33.5</td><td>30</td> <td>64.5</td><td>19.5</td><td>17.5</td> <td>64.5</td><td>12.5</td> </tr> <tr> <td>MM 1918</td><td>851</td><td>762</td> <td>1638</td><td>495</td><td>445</td> <td>1638</td><td>318</td> </tr> </tbody> </table> <p>RTA 00 1 per carton</p>	OVERALL DIMENSIONS			SEAT DIMENSIONS			BACK DIMENSIONS		W	D	H	W	D	H	W	H	IN 75.5	33.5	30	64.5	19.5	17.5	64.5	12.5	MM 1918	851	762	1638	495	445
OVERALL DIMENSIONS			SEAT DIMENSIONS			BACK DIMENSIONS																										
W	D	H	W	D	H	W	H																									
IN 75.5	33.5	30	64.5	19.5	17.5	64.5	12.5																									
MM 1918	851	762	1638	495	445	1638	318																									

DESCRIPTION FEATURES MODEL# STANDARD TEXTILE GRADES

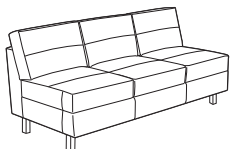

Armless Three Seater

COM: 8.25 YD | 7.54 M
 Unit weight: 117 LB | 53.2 KG
 Carton weight: 131 LB | 59.42 KG
 Carton volume: 50.25 FT³ | 1.42 MT³

Ganging hardware not included.
 Armless side(s) can be equipped with ganging brackets, model 7892.

MODEL#	1	2	3	4	5	6	7	8	9	10	11	12
S7897	-	-	-	-	2316	2704	3092	3430	3851	4247	4783	5542

OVERALL DIMENSIONS SEAT DIMENSIONS BACK DIMENSIONS

W D H W D H W H

IN	64.5	31	30.75	64.5	19.5	17.5	64.5	13.25
MM	1638	787	781	1638	495	445	1638	337

RTA 00 1 per carton

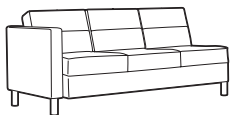

S7891R

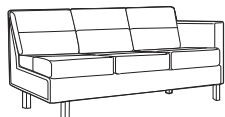

S7891L

Three Seater w/One Arm

COM: 7.25 YD | 6.63 M
 Unit weight: 133 LB | 60.5 KG
 Carton weight: 147 LB | 66.68 KG
 Carton volume: 50.25 FT³ | 1.42 MT³

Ganging hardware not included.
 Armless side can be equipped with ganging brackets, model 7892.

MODEL#	1	2	3	4	5	6	7	8	9	10	11	12
S7891L S7891R	-	-	-	-	2316	2657	2998	3295	3665	4013	4484	5151

OVERALL DIMENSIONS SEAT DIMENSIONS BACK DIMENSIONS

W D H W D H W H

IN	68.5	31	30.75	64.5	19.5	17.5	64.5	13.25
MM	1740	787	781	1638	495	445	1638	337

RTA 00 1 per carton

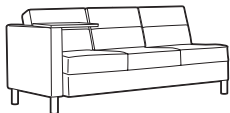

S7891RRT

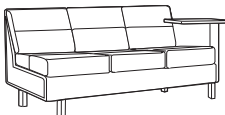

S7891LLT

Three Seater w/One Arm and Laminate Tablet

COM: 7.25 YD | 6.63 M
 Unit weight: 141 LB | 64.1 KG
 Carton weight: 155 LB | 70.31 KG
 Carton volume: 55.5 FT³ | 1.57 MT³

Ganging hardware not included.
 Armless side(s) can be equipped with ganging brackets, model 7892.

MODEL#	1	2	3	4	5	6	7	8	9	10	11	12
S7891LLT S7891RRT	-	-	-	-	2727	3068	3409	3706	4076	4424	4895	5562

OVERALL DIMENSIONS SEAT DIMENSIONS BACK DIMENSIONS

W D H W D H W H

IN	70	31	30.75	64.5	19.5	17.5	64.5	13.25
MM	1778	787	781	1638	495	445	1638	337

RTA 00 1 per carton

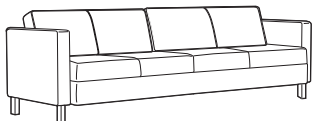

Four Seater w/Arms

COM: 10.25 YD | 9.37 M
 Unit weight: 188 LB | 85.5 KG
 Carton weight: 204 LB | 92.53 KG
 Carton volume: 69 FT³ | 1.95 MT³

Freestanding unit only.

MODEL#	1	2	3	4	5	6	7	8	9	10	11	12
S7884	-	-	-	-	3293	3775	4257	4677	5200	5692	6358	7301

OVERALL DIMENSIONS SEAT DIMENSIONS BACK DIMENSIONS

W D H W D H W H

IN	93.5	31	30	85.5	19.5	17.5	85.5	12.5
MM	2375	787	762	2172	495	445	2172	318

RTA 00 1 per carton

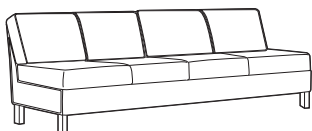

Armless Four Seater

COM: 8.75 YD | 8 M
 Unit weight: 156 LB | 70.9 KG
 Carton weight: 172 LB | 78.02 KG
 Carton volume: 61.5 FT³ | 1.74 MT³

Ganging hardware not included.
 Armless side(s) can be equipped with ganging brackets, model 7892.

MODEL#	1	2	3	4	5	6	7	8	9	10	11	12
S7884NA	-	-	-	-	3293	3704	4116	4474	4921	5341	5909	6714



OVERALL DIMENSIONS SEAT DIMENSIONS BACK DIMENSIONS

W D H W D H W H

IN	85.5	31	30.75	85.5	19.5	17.5	85.5	12.5
MM	2172	787	781	2172	495	445	2172	318

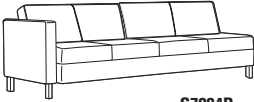
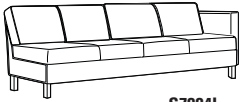
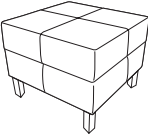
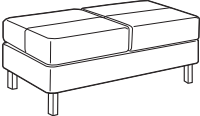
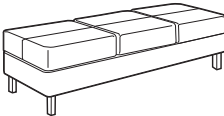
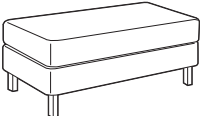
RTA 00 1 per carton

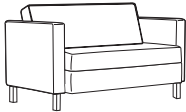
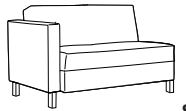
DESCRIPTION	FEATURES	MODEL#	STANDARD TEXTILE GRADES												
			1	2	3	4	5	6	7	8	9	10	11	12	
 <p>S7884R</p> <p>Four Seater w/One Arm COM: 9.5 YD 8.69 M Unit weight: 172 LB 78.2 KG Carton weight: 188 LB 85.28 KG Carton volume: 69 FT³ 1.95 MT³</p>	 <p>S7884L</p> <p>Ganging hardware not included. Armless side can be equipped with ganging brackets, model 7892.</p>	S7884L S7884R	-	-	-	-	3293	3740	4186	4576	5060	5516	6134	7008	
			OVERALL DIMENSIONS W D H			SEAT DIMENSIONS W D H			BACK DIMENSIONS W H						
			IN 89.5	31	30.75	85.8	19.5	17.5	85.8	12.5					
			MM 2273	787	781	2179	495	445	2179	318					
			RTA 00	1 per carton											
 <p>S7879</p> <p>Square Ottoman COM: 1.5 YD 1.37 M Unit weight: 23 LB 10.5 KG Carton weight: 27 LB 12.25 KG Carton volume: 7.5 FT³ 0.21 MT³</p>	<p>Ganging hardware not included. Side(s) can be equipped with ganging brackets, model 7892. Does not gang to seating units.</p>	S7879	-	-	-	-	704	775	845	907	983	1055	1153	1291	
			OVERALL DIMENSIONS W D H			SEAT DIMENSIONS W D H			BACK DIMENSIONS W H						
			IN 22	22	17	-	-	-	-	-					
			MM 559	559	432	-	-	-	-	-					
			RTA 00	1 per carton											
			courier												
 <p>S7893</p> <p>Two Seater Bench COM: 2.25 YD 2.06 M Unit weight: 36 LB 16.4 KG Carton weight: 42 LB 19.05 KG Carton volume: 11.5 FT³ 0.32 MT³</p>	<p>Ganging hardware not included. Side(s) can be equipped with ganging brackets, model 7892. Does not gang to seating units.</p>	S7893	-	-	-	-	1037	1143	1249	1341	1456	1564	1710	1917	
			OVERALL DIMENSIONS W D H			SEAT DIMENSIONS W D H			BACK DIMENSIONS W H						
			IN 43	21.5	17	-	-	-	-	-					
			MM 1092	546	432	-	-	-	-	-					
			RTA 00	1 per carton											
 <p>S7894</p> <p>Three Seater Bench COM: 3.75 YD 3.43 M Unit weight: 54 LB 24.5 KG Carton weight: 62 LB 28.12 KG Carton volume: 16.75 FT³ 0.47 MT³</p>	<p>Ganging hardware not included. Side(s) can be equipped with ganging brackets, model 7892. Does not gang to seating units.</p>	S7894	-	-	-	-	1473	1649	1826	1979	2171	2351	2594	2939	
			OVERALL DIMENSIONS W D H			SEAT DIMENSIONS W D H			BACK DIMENSIONS W H						
			IN 64.5	21.5	17	-	-	-	-	-					
			MM 1638	546	432	-	-	-	-	-					
			RTA 00	1 per carton											
 <p>S7905</p> <p>Two Seater Bench - Single Cushion COM: 2.25 YD 2.06 M Unit weight: 36 LB 16.4 KG Carton weight: 42 LB 19.05 KG Carton volume: 11.5 FT³ 0.32 MT³</p>	<p>Ganging hardware not included. Side(s) can be equipped with ganging brackets, model 7892. Does not gang to seating units.</p>	S7905	-	-	-	-	1037	1143	1249	1341	1456	1564	1710	1917	
			OVERALL DIMENSIONS W D H			SEAT DIMENSIONS W D H			BACK DIMENSIONS W H						
			IN 43	21.5	17	-	-	-	-	-					
			MM 1092	546	432	-	-	-	-	-					
			RTA 00	1 per carton											

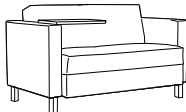
DESCRIPTION	FEATURES	MODEL#	STANDARD TEXTILE GRADES											
			1	2	3	4	5	6	7	8	9	10	11	12
 <p>Two Seater w/Arms - Single Cushion COM: 6.5 YD 5.94 M Unit weight: 110 LB 50 KG Carton weight: 122 LB 55.34 KG Carton volume: 36 FT³ 1.01 MT³</p>	Freestanding unit only.	S7902	-	-	-	-	1873	2179	2484	2751	3082	3394	3817	4415
			OVERALL DIMENSIONS			SEAT DIMENSIONS			BACK DIMENSIONS					
			W	D	H	W	D	H	W	H				
			IN 51.25 MM 1302	31 787	30 762	43.25 1099	19.5 495	17.5 445	43.25 1099	12.5 318				
		RTA 00	1 per carton											
 <p>Two Seater w/One Arm - Single Cushion COM: 6.5 YD 5.94 M Unit weight: 102 LB 46.4 KG Carton weight: 114 LB 51.71 KG Carton volume: 36 FT³ 1.01 MT³</p>	Ganging hardware not included. Armless side can be equipped with ganging brackets, model 7892.	S7902L S7902R	-	-	-	-	1873	2179	2484	2751	3082	3394	3817	4415
			OVERALL DIMENSIONS			SEAT DIMENSIONS			BACK DIMENSIONS					
			W	D	H	W	D	H	W	H				
			IN 47.25 MM 1200	31 787	30.75 781	43.25 1099	19.5 495	17.5 445	43.25 1099	13.25 337				
		RTA 00	1 per carton											
 <p>Two Seater w/One Arm & Lam. Tablet - Single Cushion COM: 5.25 YD 4.8 M Unit weight: 102 LB 46.4 KG Carton weight: 114 LB 51.71 KG Carton volume: 36 FT³ 1.01 MT³</p>	Ganging hardware not included. Armless side can be equipped with ganging brackets, model 7892.	S7902LLT S7902RRT	-	-	-	-	2285	2532	2779	2994	3262	3514	3855	4338
			OVERALL DIMENSIONS			SEAT DIMENSIONS			BACK DIMENSIONS					
			W	D	H	W	D	H	W	H				
			IN 48.75 MM 1238	33.5 851	30.75 781	43.25 1099	19.5 495	17.5 445	43.25 1099	13.25 337				
		RTA 00	1 per carton											
 <p>Armless Two Seater - Single Cushion COM: 4.5 YD 4.11 M Unit weight: 78 LB 35.5 KG Carton weight: 90 LB 40.82 KG Carton volume: 36 FT³ 1.01 MT³</p>	Ganging hardware not included. Armless side(s) can be equipped with ganging brackets, model 7892.	S7902NA	-	-	-	-	1873	2085	2296	2481	2710	2926	3219	3633
			OVERALL DIMENSIONS			SEAT DIMENSIONS			BACK DIMENSIONS					
			W	D	H	W	D	H	W	H				
			IN 43.25 MM 1099	31 787	30.75 781	43.25 1099	19.5 495	17.5 445	43.25 1099	13.25 337				
		RTA 00	1 per carton											
 <p>Two Seater w/Arms & Lam. Tablet - Single Cushion COM: 6.5 YD 5.94 M Unit weight: 118 LB 53.6 KG Carton weight: 130 LB 58.97 KG Carton volume: 41.25 FT³ 1.16 MT³</p>	Freestanding unit only.	S7902LT S7902RT	-	-	-	-	2285	2591	2896	3163	3494	3806	4229	4827
			OVERALL DIMENSIONS			SEAT DIMENSIONS			BACK DIMENSIONS					
			W	D	H	W	D	H	W	H				
			IN 52.75 MM 1340	33.5 851	30 762	43.25 1099	19.5 495	17.5 445	43.25 1099	12.5 318				
		RTA 00	1 per carton											

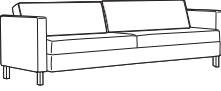
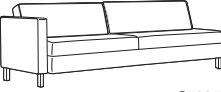
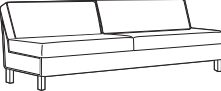
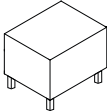
DESCRIPTION	FEATURES	MODEL#	STANDARD TEXTILE GRADES											
			1	2	3	4	5	6	7	8	9	10	11	12
 <p>Two Seater w/Arms & Lam. Tablets - Single Cushion COM: 5.25 YD 4.8 M Unit weight: 115 LB 52.3 KG Carton weight: 127 LB 57.61 KG Carton volume: 41.25 FT³ 1.16 MT³</p>	Freestanding unit only. Left and right tablets.	S7902LRT	-	-	-	-	2694	2941	3188	3403	3671	3923	4264	4747
			OVERALL DIMENSIONS			SEAT DIMENSIONS			BACK DIMENSIONS					
			W	D	H	W	D	H	W	H				
			IN 54.25	33.5	30	43.25	19.5	17.5	43.25	12.5				
			MM 1378	851	762	1099	495	445	1099	318				
		RTA 00	1 per carton											
 <p>Four Seater w/Arms - Duo Cushion COM: 10.25 YD 9.37 M Unit weight: 188 LB 85.5 KG Carton weight: 204 LB 92.53 KG Carton volume: 69 FT³ 1.95 MT³</p>	Freestanding unit only.	S7904	-	-	-	-	3323	3805	4287	4707	5230	5722	6388	7331
			OVERALL DIMENSIONS			SEAT DIMENSIONS			BACK DIMENSIONS					
			W	D	H	W	D	H	W	H				
			IN 93.5	31	30	85.5	19.5	17.5	85.5	12.5				
			MM 2375	787	762	2172	495	445	2172	318				
		RTA 00	1 per carton											
 <p>Four Seater w/One Arm - Duo Cushion COM: 9.5 YD 8.69 M Unit weight: 172 LB 78.2 KG Carton weight: 188 LB 85.29 KG Carton volume: 61.5 FT³ 1.74 MT³</p>	Ganging hardware not included. Armless side can be equipped with ganging brackets, model 7892.	S7904L	-	-	-	-	3323	3770	4216	4606	5090	5546	6164	7038
			OVERALL DIMENSIONS			SEAT DIMENSIONS			BACK DIMENSIONS					
			W	D	H	W	D	H	W	H				
			IN 89.5	31	30.75	89.5	19.5	17.5	89.5	12.5				
			MM 2273	787	781	2273	495	445	2273	318				
		RTA 00	1 per carton											
 <p>Armless Four Seater - Duo Cushion COM: 8.75 YD 8 M Unit weight: 156 LB 70.9 KG Carton weight: 172 LB 78.02 KG Carton volume: 61.5 FT³ 1.74 MT³</p>	Ganging hardware not included. Armless side(s) can be equipped with ganging brackets, model 7892.	S7904NA	-	-	-	-	3323	3734	4146	4504	4951	5371	5939	6744
			OVERALL DIMENSIONS			SEAT DIMENSIONS			BACK DIMENSIONS					
			W	D	H	W	D	H	W	H				
			IN 85.5	31	30.75	85.5	19.5	17.5	85.5	12.5				
			MM 2172	787	781	2172	495	445	2172	318				
		RTA 00	1 per carton											
 <p>Cube End Table COM: N/A Unit weight: 41 LB 18.6 KG Carton weight: 51 LB 23.13 KG Carton volume: 5.5 FT³ 0.15 MT³</p>	Leg finish upcharges: Chrome (CHM) - add \$64 Brushed Chrome (BCH) - add \$104 Satin Brass (SBR) - add \$198 Antique Copper (ACO) - add \$198 Freestanding unit only. For power/USB unit please see electrical placement chart.	S7911	List price											
			1208											
			OVERALL DIMENSIONS			SEAT DIMENSIONS			BACK DIMENSIONS					
			W	D	H	W	D	H	W	H				
			IN 20	24	16	-	-	-	-	-				
MM 508	610	406	-	-	-	-	-							
		RTA 00	1 per carton											

DESCRIPTION FEATURES MODEL# STANDARD TEXTILE GRADES

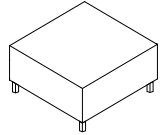

Cube Square Coffee Table
 COM: N/A
 Unit weight: 74 LB | 33.6 KG
 Carton weight: 86 LB | 39.01 KG
 Carton volume: 10.75 FT³ | 0.3 MT³

Leg finish upcharges:
 Chrome (CHM) - add \$46
 Brushed Chrome (BCH) - add \$221
 Satin Brass (SBR) - add \$315
 Antique Copper (ACO) - add \$315

Freestanding unit only.

For power/USB unit please see electrical placement chart.

List price							
S7912	1539						
OVERALL DIMENSIONS			SEAT DIMENSIONS			BACK DIMENSIONS	
W	D	H	W	D	H	W	H
IN 33	33	14	-	-	-	-	-
MM 838	838	356	-	-	-	-	-
RTA 00		1 per carton					

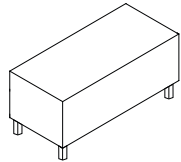

Cube 40" Coffee Table
 COM: N/A
 Unit weight: 56 LB | 25.5 KG
 Carton weight: 66 LB | 29.94 KG
 Carton volume: 8 FT³ | 0.22 MT³

Leg finish upcharges:
 Chrome (CHM) - add \$67
 Brushed Chrome (BCH) - add \$115
 Satin Brass (SBR) - add \$246
 Antique Copper (ACO) - add \$246

Freestanding unit only.

For power/USB unit please see electrical placement chart.

List price							
S7913	1461						
OVERALL DIMENSIONS			SEAT DIMENSIONS			BACK DIMENSIONS	
W	D	H	W	D	H	W	H
IN 40	20	14	-	-	-	-	-
MM 1016	508	356	-	-	-	-	-
RTA 00		1 per carton					

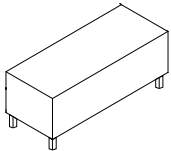

Cube Extended 60" Coffee Table
 COM: N/A
 Unit weight: 81 LB | 36.8 KG
 Carton weight: 93 LB | 42.18 KG
 Carton volume: 12 FT³ | 0.33 MT³

Leg finish upcharges:
 Chrome (CHM) - add \$67
 Brushed Chrome (BCH) - add \$99
 Satin Brass (SBR) - add \$230
 Antique Copper (ACO) - add \$230

Freestanding unit only.

For power/USB unit please see electrical placement chart.

List price							
S7915	1911						
OVERALL DIMENSIONS			SEAT DIMENSIONS			BACK DIMENSIONS	
W	D	H	W	D	H	W	H
IN 60	20	14	-	-	-	-	-
MM 1524	508	356	-	-	-	-	-
RTA 00		1 per carton					

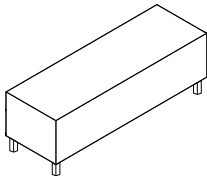

Cube Extended 72" Coffee Table
 COM: N/A
 Unit weight: 107 LB | 48.53 KG
 Carton weight: 107 LB | 48.53 KG
 Carton volume: 14.25 FT³ | 0.4 MT³

Leg finish upcharges:
 Chrome (CHM) - add \$81
 Brushed Chrome (BCH) - add \$188
 Satin Brass (SBR) - add \$313
 Antique Copper (ACO) - add \$313

Freestanding unit only.

For power/USB unit please see electrical placement chart.

List price							
S7916	1988						
OVERALL DIMENSIONS			SEAT DIMENSIONS			BACK DIMENSIONS	
W	D	H	W	D	H	W	H
IN 72	20	14	-	-	-	-	-
MM 1829	508	356	-	-	-	-	-
RTA 00		1 per carton					

DRIFT SEATING



model 8034



model 8037



model 8030



model 8052



model 8022



model 8026

Drift Tables



For Drift tables, please see page 266.

EXAMPLE DRIFT SEATING ORDER CODE:

8030P	-S2	-WA50	-SE	-WA50	-R11
Model number	Sealed Seams (back)	Back/arm textile	Sealed seams (seat)	Seat textile	Patch color
-AAM	-NM	-NB			
Base finish	Glide type	Moisture barrier			

Release vinyl for arm and head patches

(R11) White	(R21) Red Barn	(R31) Green
(R12) Chalk	(R22) Brave Red	(R32) Blue
(R13) Stone	(R23) Gypsy Red	(R33) Black
(R14) Taupe	(R24) Cajun	(R34) Cool Grey
(R15) Orange	(R25) Vineyard	(R35) Thunder Grey
(R16) Country	(R26) Olive	(R36) Navy
(R17) Tuscan	(R27) Bonsai	(R37) Dark Chocolate
(R18) Cottage	(R28) Summer's Dream	(R38) Espresso
(R19) Yellow	(R29) Calico	

MECHANISM OPTIONS:

Tilter mechanism (-4)

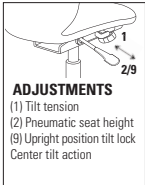

Ergonomic features:

B, C, S, U

STANDARD FEATURES

- The soft seat, contoured back and arms provide the perfect balance of style and comfort.
- Wood fixed bases are made from beechwood and available in all standard wood finishes.
- Wood fixed and swivel base models are standard with White non-marking polycarbonate glides (see right column for additional glide options).
- Sled bases are standard in paint or plated finishes (see right column for upcharges).
- Sled base models are standard with clear polycarbonate glides (see right column for additional glide options).
- For increased durability on side and lounge chairs, select P and PH suffix models which are available with arm and head patches made from Global's Release vinyl. Please specify color.
- For ease of cleaning on side and lounge chairs, models with F suffix have flip-forward seats (material under seat matches chosen seat textile).
- Sealed seams are available on chair backs and/or seats (with upcharge). For sealed seams on Ottoman, choose model 8026S which is available in sealed seam approved textiles only.
- Moisture barrier can be added to seat cushions only (with upcharge) but cannot be combined with sealed seams.
- Assembled using tamperproof screws and comes shipped fully assembled.
- Upholstery options: fabric, vinyl or leather. Vinyl and leather models may feature stitch detail across the seat and/or back cushions, if applicable.
- Active weight capacity for this series is 300 lbs

SIDE CHAIRS

- Available with six base options: sled, wood fixed, wood four star swivel, Chrome four star swivel, high four star swivel and five star base on casters.
- High four star swivel base is polished aluminum with White non-marking glides (see right column for additional glide options).
- Chairs on casters with five star 360° base swivel, are height adjustable with a 4" seat height range and include a tilting mechanism with upright tilt lock. Carpet and hard floor casters are available (see right column for caster options).

LOUNGE CHAIRS

- Available with four base options: sled, wood fixed, wood four star swivel and Chrome four star swivel.
- Chrome four star swivel models are available with 360° self-centering or swivel option. Base only available in polished Chrome.
- Available in two seat heights: 17" with a classic lounge angle or 18" with a reduced back angle for ease of sitting and standing.

STOOLS

- Counter or bar height stools are available with three base options: sled, wood fixed and metal four star swivel.

OTTOMAN

- Features a weighted bottom to always maintain an upright position and White non-marking glides.

Please add option codes in the following order:

- Model number**
specify model number
- Back seams and textile**
(NS) no sealed back seams
(S2) sealed back seams. See model for upcharge. Specify textile code.
- Seat seams and textile**
(NS) no sealed seat seams
(SE) sealed seat seams. See model for upcharge. Specify textile code.
- Arm and head patch textile**
(for P and PH suffix models) See bottom left for Release vinyl arm and head patches color chart.
- Base height** (lounge seating only)
(S17) 17" seat height
(S18) 18" seat height
- Wood base finish** (wood base models only)

(AAM) Absolute	(NLW) Natural Walnut
(BKM) Black	(ASM) Night
(ACM) Cherry	(NBM) Noce Biondo
(EOM) English Oak	(NGM) Noce Grigio
(ECM) Espresso Cafe	(NEM) Noce Leggero
(TFM) Fruitwood	(NMM) Noce Medio
(HGM) Gray	(SKM) Shaker Cherry
(AHM) Honey	(TWM) Walnut
(TMM) Mahogany	(WTM) WC Cream
(AVM) Maple	(WHM) White
(MWM) Medium Walnut	(WCM) Winter Cherry
- Frame finish** (sled base models only)
For leg frame finish options, please see page 379. Upcharges apply for the following plated finish:
(CHM) Chrome. Add \$41 for side/lounge. Add \$79 for counter. Add \$79 for bar.
- Base finish** (five star base side chair only)
(A7) polished aluminum
- Cylinder selection**
(Chrome swivel lounge models only)
(DSC) swivel cylinder
(DAC) self-centering
- Glide type** (wood base seating only)
(NM) White non-marking nylon for most surfaces (standard)
(SG) steel cushioned glides for carpeted surfaces. Add \$17.
(RG) non-slip rubber glides for most hard floor surfaces. Add \$22.
(FG) felt glides for most hard floor surfaces. Add \$22.
- Glide type** (wire sled base seating)
(CG) clear polycarbonate glides for most surfaces (standard)
(XG) no glides
(SG) steel cushioned glides for carpeted surfaces. Add \$19.
(RG) rubber glides for most hard floor surfaces. Add \$19.
(FG) felt glides for most hard floor surfaces. Add \$19.
- Glide type** (high four star base chairs)
(NM) White polyethylene non-marking for most surfaces (standard)
(FG) felt glides for most hard floor surfaces. Add \$22.
- Caster type** (five star base chairs)
(DC) 2" casters for carpeted surfaces.
(RC) 2" casters for most hard floor surfaces. Add \$17.
- Moisture barrier** (not available with sealed seams)
(NB) no moisture barrier.
(MB) moisture barrier (seat only). Add \$81.

DESCRIPTION FEATURES MODEL # STANDARD TEXTILE GRADES



Ottoman
COM: 2 YD | 1.83 M
Unit weight: 25 LB | 11.4 KG
Carton weight: 31 LB | 14.06 KG
Carton volume: 8.5 FT³ | 0.24 MT³

MODEL #	1	2	3	4	5	6	7	8	9	10	11	12
8026	803	867	922	983	1086	1179	1274	1355	1458	1554	1683	1867
8026S	905	969	1024	1085	1188	1281	1376	1457	1560	1656	1785	1969

	OVERALL DIMENSIONS			SEAT DIMENSIONS			BACK DIMENSIONS	
	W	D	H	W	D	H	W	H
IN	18.5	18.5	18	-	-	-	-	-
MM	470	470	457	-	-	-	-	-

RTA 00 1 per carton



Side Chair w/Sled Base
COM: 2 YD | 1.83 M
Unit weight: 22 LB | 10 KG
Carton weight: 31 LB | 14.06 KG
Carton volume: 13.25 FT³ | 0.37 MT³

	sealed seam upcharges	
	(S2)	(SE)
8023	Add \$33	Add \$25
8023F	Add \$33	Add \$40
8023P	Add \$49	Add \$25
8023PF	Add \$49	Add \$40

MODEL #	1	2	3	4	5	6	7	8	9	10	11	12
8023	1389	1453	1507	1570	1671	1765	1859	1941	2043	2139	2269	2453
8023F	1489	1561	1622	1692	1806	1912	2018	2110	2225	2333	2479	2686
8023P	1409	1473	1527	1590	1691	1785	1879	1961	2063	2159	2289	2473
8023PF	1509	1581	1642	1712	1826	1932	2038	2130	2245	2353	2499	2706

	OVERALL DIMENSIONS			SEAT DIMENSIONS			BACK DIMENSIONS	
	W	D	H	W	D	H	W	H
IN	24.5	23	31	18	17.5	18	15	13
MM	622	584	787	457	445	457	381	330

RTA 00 1 per carton



Side Chair w/Four-Legged Wood Base
COM: 2 YD | 1.83 M
Unit weight: 24 LB | 10.9 KG
Carton weight: 31 LB | 14.06 KG
Carton volume: 15.75 FT³ | 0.44 MT³

	sealed seam upcharges	
	(S2)	(SE)
8030	Add \$33	Add \$25
8030F	Add \$33	Add \$40
8030P	Add \$49	Add \$25
8030PF	Add \$49	Add \$40

MODEL #	1	2	3	4	5	6	7	8	9	10	11	12
8030	1469	1533	1587	1650	1751	1845	1939	2021	2123	2219	2349	2533
8030F	1569	1641	1702	1772	1886	1992	2098	2190	2305	2413	2559	2766
8030P	1489	1553	1607	1670	1771	1865	1959	2041	2143	2239	2369	2553
8030PF	1589	1661	1722	1792	1906	2012	2118	2210	2325	2433	2579	2786

	OVERALL DIMENSIONS			SEAT DIMENSIONS			BACK DIMENSIONS	
	W	D	H	W	D	H	W	H
IN	24.5	23	31	18	17.5	18	15	13
MM	622	584	787	457	445	457	381	330

RTA 00 1 per carton



Side Chair w/Wood Swivel Base
COM: 2 YD | 1.83 M
Unit weight: 24 LB | 10.9 KG
Carton weight: 31 LB | 14.06 KG
Carton volume: 15.75 FT³ | 0.44 MT³

	sealed seam upcharges	
	(S2)	(SE)
8031	Add \$33	Add \$25
8031F	Add \$33	Add \$40
8031P	Add \$49	Add \$25
8031PF	Add \$49	Add \$40

MODEL #	1	2	3	4	5	6	7	8	9	10	11	12
8031	1706	1770	1824	1887	1988	2082	2176	2258	2360	2456	2586	2770
8031F	1806	1878	1939	2009	2123	2229	2335	2427	2542	2650	2796	3003
8031P	1726	1790	1844	1907	2008	2102	2196	2278	2380	2476	2606	2790
8031PF	1826	1898	1959	2029	2143	2249	2355	2447	2562	2670	2816	3023

	OVERALL DIMENSIONS			SEAT DIMENSIONS			BACK DIMENSIONS	
	W	D	H	W	D	H	W	H
IN	24.5	23	31	18	17.5	18	15	13
MM	622	584	787	457	445	457	381	330

RTA 00 1 per carton

DESCRIPTION	FEATURES	MODEL #	STANDARD TEXTILE GRADES																																																																																																													
			1	2	3	4	5	6	7	8	9	10	11	12																																																																																																		
 <p>Side Chair w/Chrome Swivel Base COM: 2 YD 1.83 M Unit weight: 24 LB 10.9 KG Carton weight: 31 LB 14.06 KG Carton volume: 15.75 FT³ 0.44 MT³</p>	sealed seam upcharges <table border="1"> <thead> <tr> <th></th> <th>(S2)</th> <th>(SE)</th> </tr> </thead> <tbody> <tr> <td>8032</td> <td>Add \$33</td> <td>Add \$25</td> </tr> <tr> <td>8032F</td> <td>Add \$33</td> <td>Add \$40</td> </tr> <tr> <td>8032P</td> <td>Add \$49</td> <td>Add \$25</td> </tr> <tr> <td>8032PF</td> <td>Add \$49</td> <td>Add \$40</td> </tr> </tbody> </table>		(S2)	(SE)	8032	Add \$33	Add \$25	8032F	Add \$33	Add \$40	8032P	Add \$49	Add \$25	8032PF	Add \$49	Add \$40	8032	1748	1812	1866	1929	2030	2124	2218	2300	2402	2498	2628	2812																																																																																			
			(S2)	(SE)																																																																																																												
		8032	Add \$33	Add \$25																																																																																																												
		8032F	Add \$33	Add \$40																																																																																																												
		8032P	Add \$49	Add \$25																																																																																																												
8032PF	Add \$49	Add \$40																																																																																																														
8032F	1848	1920	1981	2051	2165	2271	2377	2469	2584	2692	2838	3045																																																																																																				
flip-forward seat																																																																																																																
8032P	1768	1832	1886	1949	2050	2144	2238	2320	2422	2518	2648	2832																																																																																																				
with arm patches																																																																																																																
8032PF	1868	1940	2001	2071	2185	2291	2397	2489	2604	2712	2858	3065																																																																																																				
with arm patches + flip-forward seat																																																																																																																
<table border="1"> <thead> <tr> <th colspan="3">OVERALL DIMENSIONS</th> <th colspan="3">SEAT DIMENSIONS</th> <th colspan="3">BACK DIMENSIONS</th> </tr> <tr> <th>W</th><th>D</th><th>H</th> <th>W</th><th>D</th><th>H</th> <th>W</th><th>H</th> </tr> </thead> <tbody> <tr> <td>IN 24.5</td><td>23</td><td>31</td> <td>18</td><td>17.5</td><td>18</td> <td>15</td><td>13</td> </tr> <tr> <td>MM 622</td><td>584</td><td>787</td> <td>457</td><td>445</td><td>457</td> <td>381</td><td>330</td> </tr> </tbody> </table>			OVERALL DIMENSIONS			SEAT DIMENSIONS			BACK DIMENSIONS			W	D	H	W	D	H	W	H	IN 24.5	23	31	18	17.5	18	15	13	MM 622	584	787	457	445	457	381	330	<table border="1"> <thead> <tr> <th>1</th><th>2</th><th>3</th><th>4</th><th>5</th><th>6</th><th>7</th><th>8</th><th>9</th><th>10</th><th>11</th><th>12</th> </tr> </thead> <tbody> <tr> <td colspan="12"> <table border="1"> <thead> <tr> <th>OVERALL DIMENSIONS</th> <th>SEAT DIMENSIONS</th> <th>BACK DIMENSIONS</th> </tr> <tr> <th>W</th><th>D</th><th>H</th> <th>W</th><th>D</th><th>H</th> <th>W</th><th>H</th> </tr> </thead> <tbody> <tr> <td>IN 24.5</td><td>23</td><td>31</td> <td>18</td><td>17.5</td><td>18</td> <td>15</td><td>13</td> </tr> <tr> <td>MM 622</td><td>584</td><td>787</td> <td>457</td><td>445</td><td>457</td> <td>381</td><td>330</td> </tr> </tbody> </table> </td> </tr> <tr> <td colspan="12"> <table border="1"> <thead> <tr> <th>RTA 00</th> </tr> </thead> <tbody> <tr> <td>1 per carton</td> </tr> </tbody> </table> </td> </tr> </tbody> </table>												1	2	3	4	5	6	7	8	9	10	11	12	<table border="1"> <thead> <tr> <th>OVERALL DIMENSIONS</th> <th>SEAT DIMENSIONS</th> <th>BACK DIMENSIONS</th> </tr> <tr> <th>W</th><th>D</th><th>H</th> <th>W</th><th>D</th><th>H</th> <th>W</th><th>H</th> </tr> </thead> <tbody> <tr> <td>IN 24.5</td><td>23</td><td>31</td> <td>18</td><td>17.5</td><td>18</td> <td>15</td><td>13</td> </tr> <tr> <td>MM 622</td><td>584</td><td>787</td> <td>457</td><td>445</td><td>457</td> <td>381</td><td>330</td> </tr> </tbody> </table>												OVERALL DIMENSIONS	SEAT DIMENSIONS	BACK DIMENSIONS	W	D	H	W	D	H	W	H	IN 24.5	23	31	18	17.5	18	15	13	MM 622	584	787	457	445	457	381	330	<table border="1"> <thead> <tr> <th>RTA 00</th> </tr> </thead> <tbody> <tr> <td>1 per carton</td> </tr> </tbody> </table>												RTA 00	1 per carton
OVERALL DIMENSIONS			SEAT DIMENSIONS			BACK DIMENSIONS																																																																																																										
W	D	H	W	D	H	W	H																																																																																																									
IN 24.5	23	31	18	17.5	18	15	13																																																																																																									
MM 622	584	787	457	445	457	381	330																																																																																																									
1	2	3	4	5	6	7	8	9	10	11	12																																																																																																					
<table border="1"> <thead> <tr> <th>OVERALL DIMENSIONS</th> <th>SEAT DIMENSIONS</th> <th>BACK DIMENSIONS</th> </tr> <tr> <th>W</th><th>D</th><th>H</th> <th>W</th><th>D</th><th>H</th> <th>W</th><th>H</th> </tr> </thead> <tbody> <tr> <td>IN 24.5</td><td>23</td><td>31</td> <td>18</td><td>17.5</td><td>18</td> <td>15</td><td>13</td> </tr> <tr> <td>MM 622</td><td>584</td><td>787</td> <td>457</td><td>445</td><td>457</td> <td>381</td><td>330</td> </tr> </tbody> </table>												OVERALL DIMENSIONS	SEAT DIMENSIONS	BACK DIMENSIONS	W	D	H	W	D	H	W	H	IN 24.5	23	31	18	17.5	18	15	13	MM 622	584	787	457	445	457	381	330																																																																										
OVERALL DIMENSIONS	SEAT DIMENSIONS	BACK DIMENSIONS																																																																																																														
W	D	H	W	D	H	W	H																																																																																																									
IN 24.5	23	31	18	17.5	18	15	13																																																																																																									
MM 622	584	787	457	445	457	381	330																																																																																																									
<table border="1"> <thead> <tr> <th>RTA 00</th> </tr> </thead> <tbody> <tr> <td>1 per carton</td> </tr> </tbody> </table>												RTA 00	1 per carton																																																																																																			
RTA 00																																																																																																																
1 per carton																																																																																																																

 <p>Side Chair w/High Four Star Swivel Base COM: 2 YD 1.83 M Unit weight: 26.5 LB 12 KG Carton weight: 35.5 LB 16.1 KG Carton volume: 13.25 FT³ 0.37 MT³</p>	sealed seam upcharges <table border="1"> <thead> <tr> <th></th> <th>(S2)</th> <th>(SE)</th> </tr> </thead> <tbody> <tr> <td>8021</td> <td>Add \$33</td> <td>Add \$25</td> </tr> <tr> <td>8021P</td> <td>Add \$49</td> <td>Add \$25</td> </tr> </tbody> </table>		(S2)	(SE)	8021	Add \$33	Add \$25	8021P	Add \$49	Add \$25	8021	1558	1622	1676	1739	1840	1934	2028	2110	2212	2308	2438	2622																																																																																									
			(S2)	(SE)																																																																																																												
		8021	Add \$33	Add \$25																																																																																																												
		8021P	Add \$49	Add \$25																																																																																																												
		8021P	1578	1642	1696	1759	1860	1954	2048	2130	2232	2328	2458	2642																																																																																																		
with arm patches																																																																																																																
<table border="1"> <thead> <tr> <th colspan="3">OVERALL DIMENSIONS</th> <th colspan="3">SEAT DIMENSIONS</th> <th colspan="3">BACK DIMENSIONS</th> </tr> <tr> <th>W</th><th>D</th><th>H</th> <th>W</th><th>D</th><th>H</th> <th>W</th><th>H</th> </tr> </thead> <tbody> <tr> <td>IN 24.5</td><td>23</td><td>32</td> <td>18</td><td>17.5</td><td>18.5</td> <td>15</td><td>13</td> </tr> <tr> <td>MM 622</td><td>584</td><td>813</td> <td>457</td><td>445</td><td>470</td> <td>381</td><td>330</td> </tr> </tbody> </table>			OVERALL DIMENSIONS			SEAT DIMENSIONS			BACK DIMENSIONS			W	D	H	W	D	H	W	H	IN 24.5	23	32	18	17.5	18.5	15	13	MM 622	584	813	457	445	470	381	330	<table border="1"> <thead> <tr> <th>1</th><th>2</th><th>3</th><th>4</th><th>5</th><th>6</th><th>7</th><th>8</th><th>9</th><th>10</th><th>11</th><th>12</th> </tr> </thead> <tbody> <tr> <td colspan="12"> <table border="1"> <thead> <tr> <th>OVERALL DIMENSIONS</th> <th>SEAT DIMENSIONS</th> <th>BACK DIMENSIONS</th> </tr> <tr> <th>W</th><th>D</th><th>H</th> <th>W</th><th>D</th><th>H</th> <th>W</th><th>H</th> </tr> </thead> <tbody> <tr> <td>IN 24.5</td><td>23</td><td>32</td> <td>18</td><td>17.5</td><td>18.5</td> <td>15</td><td>13</td> </tr> <tr> <td>MM 622</td><td>584</td><td>813</td> <td>457</td><td>445</td><td>470</td> <td>381</td><td>330</td> </tr> </tbody> </table> </td> </tr> <tr> <td colspan="12"> <table border="1"> <thead> <tr> <th>RTA 00</th> </tr> </thead> <tbody> <tr> <td>1 per carton</td> </tr> </tbody> </table> </td> </tr> </tbody> </table>												1	2	3	4	5	6	7	8	9	10	11	12	<table border="1"> <thead> <tr> <th>OVERALL DIMENSIONS</th> <th>SEAT DIMENSIONS</th> <th>BACK DIMENSIONS</th> </tr> <tr> <th>W</th><th>D</th><th>H</th> <th>W</th><th>D</th><th>H</th> <th>W</th><th>H</th> </tr> </thead> <tbody> <tr> <td>IN 24.5</td><td>23</td><td>32</td> <td>18</td><td>17.5</td><td>18.5</td> <td>15</td><td>13</td> </tr> <tr> <td>MM 622</td><td>584</td><td>813</td> <td>457</td><td>445</td><td>470</td> <td>381</td><td>330</td> </tr> </tbody> </table>												OVERALL DIMENSIONS	SEAT DIMENSIONS	BACK DIMENSIONS	W	D	H	W	D	H	W	H	IN 24.5	23	32	18	17.5	18.5	15	13	MM 622	584	813	457	445	470	381	330	<table border="1"> <thead> <tr> <th>RTA 00</th> </tr> </thead> <tbody> <tr> <td>1 per carton</td> </tr> </tbody> </table>												RTA 00	1 per carton
OVERALL DIMENSIONS			SEAT DIMENSIONS			BACK DIMENSIONS																																																																																																										
W	D	H	W	D	H	W	H																																																																																																									
IN 24.5	23	32	18	17.5	18.5	15	13																																																																																																									
MM 622	584	813	457	445	470	381	330																																																																																																									
1	2	3	4	5	6	7	8	9	10	11	12																																																																																																					
<table border="1"> <thead> <tr> <th>OVERALL DIMENSIONS</th> <th>SEAT DIMENSIONS</th> <th>BACK DIMENSIONS</th> </tr> <tr> <th>W</th><th>D</th><th>H</th> <th>W</th><th>D</th><th>H</th> <th>W</th><th>H</th> </tr> </thead> <tbody> <tr> <td>IN 24.5</td><td>23</td><td>32</td> <td>18</td><td>17.5</td><td>18.5</td> <td>15</td><td>13</td> </tr> <tr> <td>MM 622</td><td>584</td><td>813</td> <td>457</td><td>445</td><td>470</td> <td>381</td><td>330</td> </tr> </tbody> </table>												OVERALL DIMENSIONS	SEAT DIMENSIONS	BACK DIMENSIONS	W	D	H	W	D	H	W	H	IN 24.5	23	32	18	17.5	18.5	15	13	MM 622	584	813	457	445	470	381	330																																																																										
OVERALL DIMENSIONS	SEAT DIMENSIONS	BACK DIMENSIONS																																																																																																														
W	D	H	W	D	H	W	H																																																																																																									
IN 24.5	23	32	18	17.5	18.5	15	13																																																																																																									
MM 622	584	813	457	445	470	381	330																																																																																																									
<table border="1"> <thead> <tr> <th>RTA 00</th> </tr> </thead> <tbody> <tr> <td>1 per carton</td> </tr> </tbody> </table>												RTA 00	1 per carton																																																																																																			
RTA 00																																																																																																																
1 per carton																																																																																																																

 <p>Side Chair w/Five Star Swivel Tilt Base on Casters COM: 2 YD 1.83 M Unit weight: 28.5 LB 13 KG Carton weight: 37.5 LB 17.01 KG Carton volume: 15.75 FT³ 0.44 MT³</p>	sealed seam upcharges <table border="1"> <thead> <tr> <th></th> <th>(S2)</th> <th>(SE)</th> </tr> </thead> <tbody> <tr> <td>8022</td> <td>Add \$33</td> <td>Add \$25</td> </tr> <tr> <td>8022P</td> <td>Add \$49</td> <td>Add \$25</td> </tr> </tbody> </table>		(S2)	(SE)	8022	Add \$33	Add \$25	8022P	Add \$49	Add \$25	8022	1701	1765	1819	1882	1983	2077	2171	2253	2355	2451	2581	2765																																																																																									
			(S2)	(SE)																																																																																																												
		8022	Add \$33	Add \$25																																																																																																												
		8022P	Add \$49	Add \$25																																																																																																												
		8022P	1721	1785	1839	1902	2003	2097	2191	2273	2375	2471	2601	2785																																																																																																		
with arm patches																																																																																																																
<table border="1"> <thead> <tr> <th colspan="3">OVERALL DIMENSIONS</th> <th colspan="3">SEAT DIMENSIONS</th> <th colspan="3">BACK DIMENSIONS</th> </tr> <tr> <th>W</th><th>D</th><th>H</th> <th>W</th><th>D</th><th>H</th> <th>W</th><th>H</th> </tr> </thead> <tbody> <tr> <td>IN 24.5</td><td>23</td><td>32.5</td> <td>18</td><td>17.5</td><td>15</td> <td>15</td><td>13</td> </tr> <tr> <td>MM 622</td><td>584</td><td>826</td> <td>457</td><td>445</td><td>381</td> <td>381</td><td>330</td> </tr> </tbody> </table>			OVERALL DIMENSIONS			SEAT DIMENSIONS			BACK DIMENSIONS			W	D	H	W	D	H	W	H	IN 24.5	23	32.5	18	17.5	15	15	13	MM 622	584	826	457	445	381	381	330	<table border="1"> <thead> <tr> <th>1</th><th>2</th><th>3</th><th>4</th><th>5</th><th>6</th><th>7</th><th>8</th><th>9</th><th>10</th><th>11</th><th>12</th> </tr> </thead> <tbody> <tr> <td colspan="12"> <table border="1"> <thead> <tr> <th>OVERALL DIMENSIONS</th> <th>SEAT DIMENSIONS</th> <th>BACK DIMENSIONS</th> </tr> <tr> <th>W</th><th>D</th><th>H</th> <th>W</th><th>D</th><th>H</th> <th>W</th><th>H</th> </tr> </thead> <tbody> <tr> <td>IN 24.5</td><td>23</td><td>32.5</td> <td>18</td><td>17.5</td><td>15</td> <td>15</td><td>13</td> </tr> <tr> <td>MM 622</td><td>584</td><td>826</td> <td>457</td><td>445</td><td>381</td> <td>381</td><td>330</td> </tr> </tbody> </table> </td> </tr> <tr> <td colspan="12"> <table border="1"> <thead> <tr> <th>RTA 00</th> </tr> </thead> <tbody> <tr> <td>1 per carton</td> </tr> </tbody> </table> </td> </tr> </tbody> </table>												1	2	3	4	5	6	7	8	9	10	11	12	<table border="1"> <thead> <tr> <th>OVERALL DIMENSIONS</th> <th>SEAT DIMENSIONS</th> <th>BACK DIMENSIONS</th> </tr> <tr> <th>W</th><th>D</th><th>H</th> <th>W</th><th>D</th><th>H</th> <th>W</th><th>H</th> </tr> </thead> <tbody> <tr> <td>IN 24.5</td><td>23</td><td>32.5</td> <td>18</td><td>17.5</td><td>15</td> <td>15</td><td>13</td> </tr> <tr> <td>MM 622</td><td>584</td><td>826</td> <td>457</td><td>445</td><td>381</td> <td>381</td><td>330</td> </tr> </tbody> </table>												OVERALL DIMENSIONS	SEAT DIMENSIONS	BACK DIMENSIONS	W	D	H	W	D	H	W	H	IN 24.5	23	32.5	18	17.5	15	15	13	MM 622	584	826	457	445	381	381	330	<table border="1"> <thead> <tr> <th>RTA 00</th> </tr> </thead> <tbody> <tr> <td>1 per carton</td> </tr> </tbody> </table>												RTA 00	1 per carton
OVERALL DIMENSIONS			SEAT DIMENSIONS			BACK DIMENSIONS																																																																																																										
W	D	H	W	D	H	W	H																																																																																																									
IN 24.5	23	32.5	18	17.5	15	15	13																																																																																																									
MM 622	584	826	457	445	381	381	330																																																																																																									
1	2	3	4	5	6	7	8	9	10	11	12																																																																																																					
<table border="1"> <thead> <tr> <th>OVERALL DIMENSIONS</th> <th>SEAT DIMENSIONS</th> <th>BACK DIMENSIONS</th> </tr> <tr> <th>W</th><th>D</th><th>H</th> <th>W</th><th>D</th><th>H</th> <th>W</th><th>H</th> </tr> </thead> <tbody> <tr> <td>IN 24.5</td><td>23</td><td>32.5</td> <td>18</td><td>17.5</td><td>15</td> <td>15</td><td>13</td> </tr> <tr> <td>MM 622</td><td>584</td><td>826</td> <td>457</td><td>445</td><td>381</td> <td>381</td><td>330</td> </tr> </tbody> </table>												OVERALL DIMENSIONS	SEAT DIMENSIONS	BACK DIMENSIONS	W	D	H	W	D	H	W	H	IN 24.5	23	32.5	18	17.5	15	15	13	MM 622	584	826	457	445	381	381	330																																																																										
OVERALL DIMENSIONS	SEAT DIMENSIONS	BACK DIMENSIONS																																																																																																														
W	D	H	W	D	H	W	H																																																																																																									
IN 24.5	23	32.5	18	17.5	15	15	13																																																																																																									
MM 622	584	826	457	445	381	381	330																																																																																																									
<table border="1"> <thead> <tr> <th>RTA 00</th> </tr> </thead> <tbody> <tr> <td>1 per carton</td> </tr> </tbody> </table>												RTA 00	1 per carton																																																																																																			
RTA 00																																																																																																																
1 per carton																																																																																																																

 <p>Low Back Lounge Chair w/Sled Base COM: 3.25 YD 2.97 M Unit weight: 42 LB 19.1 KG Carton weight: 52 LB 23.59 KG Carton volume: 19.25 FT³ 0.54 MT³</p>	sealed seam upcharges <table border="1"> <thead> <tr> <th></th> <th>(S2)</th> <th>(SE)</th> </tr> </thead> <tbody> <tr> <td>8024</td> <td>Add \$68</td> <td>Add \$29</td> </tr> <tr> <td>8024F</td> <td>Add \$68</td> <td>Add \$44</td> </tr> <tr> <td>8024P</td> <td>Add \$84</td> <td>Add \$29</td> </tr> <tr> <td>8024PF</td> <td>Add \$84</td> <td>Add \$44</td> </tr> </tbody> </table>		(S2)	(SE)	8024	Add \$68	Add \$29	8024F	Add \$68	Add \$44	8024P	Add \$84	Add \$29	8024PF	Add \$84	Add \$44	8024	1829	1933	2021	2122	2287	2440	2593	2726	2892	3048	3259	3558																																																																																			
			(S2)	(SE)																																																																																																												
		8024	Add \$68	Add \$29																																																																																																												
		8024F	Add \$68	Add \$44																																																																																																												
		8024P	Add \$84	Add \$29																																																																																																												
8024PF	Add \$84	Add \$44																																																																																																														
8024F	1954	2082	2190	2315	2518	2706	2894	3058	3262	3454	3714	4082																																																																																																				
flip-forward seat																																																																																																																
8024P	1849	1953	2041	2142	2307	2460	2613	2746	2912	3068	3279	3578																																																																																																				
with arm patches																																																																																																																
8024PF	1974	2102	2210	2335	2538	2726	2914	3078	3282	3474	3734	4102																																																																																																				
with arm patches + flip-forward seat																																																																																																																
<table border="1"> <thead> <tr> <th colspan="3">OVERALL DIMENSIONS</th> <th colspan="3">SEAT DIMENSIONS</th> <th colspan="3">BACK DIMENSIONS</th> </tr> <tr> <th>W</th><th>D</th><th>H</th> <th>W</th><th>D</th><th>H</th> <th>W</th><th>H</th> </tr> </thead> <tbody> <tr> <td>IN 29</td><td>30</td><td>33</td> <td>21.5</td><td>20</td><td>17</td> <td>21</td><td>16</td> </tr> <tr> <td>MM 737</td><td>762</td><td>838</td> <td>546</td><td>508</td><td>432</td> <td>533</td><td>406</td> </tr> </tbody> </table>			OVERALL DIMENSIONS			SEAT DIMENSIONS			BACK DIMENSIONS			W	D	H	W	D	H	W	H	IN 29	30	33	21.5	20	17	21	16	MM 737	762	838	546	508	432	533	406	<table border="1"> <thead> <tr> <th>1</th><th>2</th><th>3</th><th>4</th><th>5</th><th>6</th><th>7</th><th>8</th><th>9</th><th>10</th><th>11</th><th>12</th> </tr> </thead> <tbody> <tr> <td colspan="12"> <table border="1"> <thead> <tr> <th>OVERALL DIMENSIONS</th> <th>SEAT DIMENSIONS</th> <th>BACK DIMENSIONS</th> </tr> <tr> <th>W</th><th>D</th><th>H</th> <th>W</th><th>D</th><th>H</th> <th>W</th><th>H</th> </tr> </thead> <tbody> <tr> <td>IN 29</td><td>30</td><td>33</td> <td>21.5</td><td>20</td><td>17</td> <td>21</td><td>16</td> </tr> <tr> <td>MM 737</td><td>762</td><td>838</td> <td>546</td><td>508</td><td>432</td> <td>533</td><td>406</td> </tr> </tbody> </table> </td> </tr> <tr> <td colspan="12"> <table border="1"> <thead> <tr> <th>RTA 00</th> </tr> </thead> <tbody> <tr> <td>1 per carton</td> </tr> </tbody> </table> </td> </tr> </tbody> </table>												1	2	3	4	5	6	7	8	9	10	11	12	<table border="1"> <thead> <tr> <th>OVERALL DIMENSIONS</th> <th>SEAT DIMENSIONS</th> <th>BACK DIMENSIONS</th> </tr> <tr> <th>W</th><th>D</th><th>H</th> <th>W</th><th>D</th><th>H</th> <th>W</th><th>H</th> </tr> </thead> <tbody> <tr> <td>IN 29</td><td>30</td><td>33</td> <td>21.5</td><td>20</td><td>17</td> <td>21</td><td>16</td> </tr> <tr> <td>MM 737</td><td>762</td><td>838</td> <td>546</td><td>508</td><td>432</td> <td>533</td><td>406</td> </tr> </tbody> </table>												OVERALL DIMENSIONS	SEAT DIMENSIONS	BACK DIMENSIONS	W	D	H	W	D	H	W	H	IN 29	30	33	21.5	20	17	21	16	MM 737	762	838	546	508	432	533	406	<table border="1"> <thead> <tr> <th>RTA 00</th> </tr> </thead> <tbody> <tr> <td>1 per carton</td> </tr> </tbody> </table>												RTA 00	1 per carton
OVERALL DIMENSIONS			SEAT DIMENSIONS			BACK DIMENSIONS																																																																																																										
W	D	H	W	D	H	W	H																																																																																																									
IN 29	30	33	21.5	20	17	21	16																																																																																																									
MM 737	762	838	546	508	432	533	406																																																																																																									
1	2	3	4	5	6	7	8	9	10	11	12																																																																																																					
<table border="1"> <thead> <tr> <th>OVERALL DIMENSIONS</th> <th>SEAT DIMENSIONS</th> <th>BACK DIMENSIONS</th> </tr> <tr> <th>W</th><th>D</th><th>H</th> <th>W</th><th>D</th><th>H</th> <th>W</th><th>H</th> </tr> </thead> <tbody> <tr> <td>IN 29</td><td>30</td><td>33</td> <td>21.5</td><td>20</td><td>17</td> <td>21</td><td>16</td> </tr> <tr> <td>MM 737</td><td>762</td><td>838</td> <td>546</td><td>508</td><td>432</td> <td>533</td><td>406</td> </tr> </tbody> </table>												OVERALL DIMENSIONS	SEAT DIMENSIONS	BACK DIMENSIONS	W	D	H	W	D	H	W	H	IN 29	30	33	21.5	20	17	21	16	MM 737	762	838	546	508	432	533	406																																																																										
OVERALL DIMENSIONS	SEAT DIMENSIONS	BACK DIMENSIONS																																																																																																														
W	D	H	W	D	H	W	H																																																																																																									
IN 29	30	33	21.5	20	17	21	16																																																																																																									
MM 737	762	838	546	508	432	533	406																																																																																																									
<table border="1"> <thead> <tr> <th>RTA 00</th> </tr> </thead> <tbody> <tr> <td>1 per carton</td> </tr> </tbody> </table>												RTA 00	1 per carton																																																																																																			
RTA 00																																																																																																																
1 per carton																																																																																																																

DESCRIPTION FEATURES MODEL # STANDARD TEXTILE GRADES



Low Back Lounge Chair w/Four-Legged Wood Base
 COM: 3.25 YD | 2.97 M
 Unit weight: 43.5 LB | 19.8 KG
 Carton weight: 53.5 LB | 24.27 KG
 Carton volume: 19 FT³ | 0.53 MT³

	sealed seam upcharges	
	(S2)	(SE)
8025	Add \$68	Add \$29
8025F	Add \$68	Add \$44
8025P	Add \$84	Add \$29
8025PF	Add \$84	Add \$44

	1	2	3	4	5	6	7	8	9	10	11	12
8025	2329	2433	2521	2622	2787	2940	3093	3226	3392	3548	3759	4058
8025F	2454	2582	2690	2815	3018	3206	3394	3558	3762	3954	4214	4582
flip-forward seat												
8025P	2349	2453	2541	2642	2807	2960	3113	3246	3412	3568	3779	4078
with arm patches												
8025PF	2474	2602	2710	2835	3038	3226	3414	3578	3782	3974	4234	4602
with arm patches + flip-forward seat												

	OVERALL DIMENSIONS			SEAT DIMENSIONS			BACK DIMENSIONS					
	W	D	H	W	D	H	W	H				
IN	29	30	33	21.5	20	17	21	16				
MM	737	762	838	546	508	432	533	406				
RTA 00	1 per carton											



Low Back Lounge Chair w/Wood Swivel Base
 COM: 3.25 YD | 2.97 M
 Unit weight: 43 LB | 19.5 KG
 Carton weight: 53 LB | 24.04 KG
 Carton volume: 19 FT³ | 0.53 MT³

	sealed seam upcharges	
	(S2)	(SE)
8033	Add \$68	Add \$29
8033F	Add \$68	Add \$44
8033P	Add \$84	Add \$29
8033PF	Add \$84	Add \$44

	1	2	3	4	5	6	7	8	9	10	11	12
8033	2329	2433	2521	2622	2787	2940	3093	3226	3392	3548	3759	4058
8033F	2454	2582	2690	2815	3018	3206	3394	3558	3762	3954	4214	4582
flip-forward seat												
8033P	2349	2453	2541	2642	2807	2960	3113	3246	3412	3568	3779	4078
with arm patches												
8033PF	2474	2602	2710	2835	3038	3226	3414	3578	3782	3974	4234	4602
with arm patches + flip-forward seat												

	OVERALL DIMENSIONS			SEAT DIMENSIONS			BACK DIMENSIONS					
	W	D	H	W	D	H	W	H				
IN	29	30	33	21.5	20	17	21	16				
MM	737	762	838	546	508	432	533	406				
RTA 00	1 per carton											



Low Back Lounge Chair w/Chrome Swivel Base
 COM: 3.25 YD | 2.97 M
 Unit weight: 49 LB | 22.3 KG
 Carton weight: 59 LB | 26.76 KG
 Carton volume: 19.25 FT³ | 0.54 MT³

	sealed seam upcharges	
	(S2)	(SE)
8034	Add \$68	Add \$29
8034F	Add \$68	Add \$44
8034P	Add \$84	Add \$29
8034PF	Add \$84	Add \$44

	1	2	3	4	5	6	7	8	9	10	11	12
8034	2344	2448	2536	2637	2802	2955	3108	3241	3407	3563	3774	4073
8034F	2469	2597	2705	2830	3033	3221	3409	3573	3777	3969	4229	4597
flip-forward seat												
8034P	2364	2468	2556	2657	2822	2975	3128	3261	3427	3583	3794	4093
with arm patches												
8034PF	2489	2617	2725	2850	3053	3241	3429	3593	3797	3989	4249	4617
with arm patches + flip-forward seat												

	OVERALL DIMENSIONS			SEAT DIMENSIONS			BACK DIMENSIONS					
	W	D	H	W	D	H	W	H				
IN	29	30	33	21.5	20	17	21	16				
MM	737	762	838	546	508	432	533	406				
RTA 00	1 per carton											





Mid Back Lounge Chair w/Sled Base
 COM: 3.5 YD | 3.2 M
 Unit weight: 42 LB | 19.1 KG
 Carton weight: 52 LB | 23.59 KG
 Carton volume: 25.5 FT³ | 0.72 MT³

	sealed seam upcharges	
	(S2)	(SE)
8016	Add \$74	Add \$29
8016F	Add \$74	Add \$44
8016P	Add \$90	Add \$29
8016PF	Add \$90	Add \$44

	1	2	3	4	5	6	7	8	9	10	11	12
8016	1923	2035	2130	2238	2417	2581	2746	2889	3068	3236	3463	3785
8016F	2073	2209	2324	2456	2672	2872	3072	3246	3463	3667	3943	4334
flip-forward seat												
8016P	1943	2055	2150	2258	2437	2601	2766	2909	3088	3256	3483	3805
with arm patches												
8016PF	2093	2229	2344	2476	2692	2892	3092	3266	3483	3687	3963	4354
with arm patches + flip-forward seat												

	OVERALL DIMENSIONS			SEAT DIMENSIONS			BACK DIMENSIONS					
	W	D	H	W	D	H	W	H				
IN	29	31.5	38.5	21.5	20	17	21	21.5				
MM	737	800	978	546	508	432	533	546				
RTA 00	1 per carton											

DESCRIPTION	FEATURES	MODEL #	STANDARD TEXTILE GRADES																										
			1	2	3	4	5	6	7	8	9	10	11	12															
 <p>Mid Back Lounge Chair w/Four-Legged Wood Base COM: 3.5 YD 3.2 M Unit weight: 43.5 LB 19.8 KG Carton weight: 53.5 LB 24.27 KG Carton volume: 25.5 FT³ 0.72 MT³</p>	sealed seam upcharges <table border="1"> <thead> <tr> <th></th> <th>(S2)</th> <th>(SE)</th> </tr> </thead> <tbody> <tr> <td>8027</td> <td>Add \$74</td> <td>Add \$29</td> </tr> <tr> <td>8027F</td> <td>Add \$74</td> <td>Add \$44</td> </tr> <tr> <td>8027P</td> <td>Add \$90</td> <td>Add \$29</td> </tr> <tr> <td>8027PF</td> <td>Add \$90</td> <td>Add \$44</td> </tr> </tbody> </table>		(S2)	(SE)	8027	Add \$74	Add \$29	8027F	Add \$74	Add \$44	8027P	Add \$90	Add \$29	8027PF	Add \$90	Add \$44	8027	2423	2535	2630	2738	2917	3081	3246	3389	3568	3736	3963	4285
			(S2)	(SE)																									
		8027	Add \$74	Add \$29																									
		8027F	Add \$74	Add \$44																									
8027P	Add \$90	Add \$29																											
8027PF	Add \$90	Add \$44																											
8027F	2573	2709	2824	2956	3172	3372	3572	3746	3963	4167	4443	4834																	
flip-forward seat																													
8027P	2443	2555	2650	2758	2937	3101	3266	3409	3588	3756	3983	4305																	
with arm patches																													
8027PF	2593	2729	2844	2976	3192	3392	3592	3766	3983	4187	4463	4854																	
with arm patches + flip-forward seat																													
OVERALL DIMENSIONS			SEAT DIMENSIONS						BACK DIMENSIONS																				
			W	D	H	W	D	H	W	H																			
IN	29	31.5	38.5	21.5	20	17			21	21.5																			
MM	737	800	978	546	508	432			533	546																			
RTA 00			1 per carton																										

DESCRIPTION	FEATURES	MODEL #	STANDARD TEXTILE GRADES																										
			1	2	3	4	5	6	7	8	9	10	11	12															
 <p>Mid Back Lounge Chair w/Wood Swivel Base COM: 3.5 YD 3.2 M Unit weight: 44 LB 20 KG Carton weight: 54 LB 24.49 KG Carton volume: 25.5 FT³ 0.72 MT³</p>	sealed seam upcharges <table border="1"> <thead> <tr> <th></th> <th>(S2)</th> <th>(SE)</th> </tr> </thead> <tbody> <tr> <td>8035</td> <td>Add \$74</td> <td>Add \$29</td> </tr> <tr> <td>8035F</td> <td>Add \$74</td> <td>Add \$44</td> </tr> <tr> <td>8035P</td> <td>Add \$90</td> <td>Add \$29</td> </tr> <tr> <td>8035PF</td> <td>Add \$90</td> <td>Add \$44</td> </tr> </tbody> </table>		(S2)	(SE)	8035	Add \$74	Add \$29	8035F	Add \$74	Add \$44	8035P	Add \$90	Add \$29	8035PF	Add \$90	Add \$44	8035	2423	2535	2630	2738	2917	3081	3246	3389	3568	3736	3963	4285
			(S2)	(SE)																									
		8035	Add \$74	Add \$29																									
		8035F	Add \$74	Add \$44																									
8035P	Add \$90	Add \$29																											
8035PF	Add \$90	Add \$44																											
8035F	2573	2709	2824	2956	3172	3372	3572	3746	3963	4167	4443	4834																	
flip-forward seat																													
8035P	2443	2555	2650	2758	2937	3101	3266	3409	3588	3756	3983	4305																	
with arm patches																													
8035PF	2593	2729	2844	2976	3192	3392	3592	3766	3983	4187	4463	4854																	
with arm patches + flip-forward seat																													
OVERALL DIMENSIONS			SEAT DIMENSIONS						BACK DIMENSIONS																				
			W	D	H	W	D	H	W	H																			
IN	29	31.5	38.5	21.5	20	17			21	21.5																			
MM	737	800	978	546	508	432			533	546																			
RTA 00			1 per carton																										

DESCRIPTION	FEATURES	MODEL #	STANDARD TEXTILE GRADES																										
			1	2	3	4	5	6	7	8	9	10	11	12															
 <p>Mid Back Lounge Chair w/Chrome Swivel Base COM: 3.5 YD 3.2 M Unit weight: 50 LB 22.7 KG Carton weight: 60 LB 27.22 KG Carton volume: 25.5 FT³ 0.72 MT³</p>	sealed seam upcharges <table border="1"> <thead> <tr> <th></th> <th>(S2)</th> <th>(SE)</th> </tr> </thead> <tbody> <tr> <td>8036</td> <td>Add \$74</td> <td>Add \$29</td> </tr> <tr> <td>8036F</td> <td>Add \$74</td> <td>Add \$44</td> </tr> <tr> <td>8036P</td> <td>Add \$90</td> <td>Add \$29</td> </tr> <tr> <td>8036PF</td> <td>Add \$90</td> <td>Add \$44</td> </tr> </tbody> </table>		(S2)	(SE)	8036	Add \$74	Add \$29	8036F	Add \$74	Add \$44	8036P	Add \$90	Add \$29	8036PF	Add \$90	Add \$44	8036	2439	2551	2646	2754	2933	3097	3262	3405	3584	3752	3979	4301
			(S2)	(SE)																									
		8036	Add \$74	Add \$29																									
		8036F	Add \$74	Add \$44																									
8036P	Add \$90	Add \$29																											
8036PF	Add \$90	Add \$44																											
8036F	2589	2725	2840	2972	3188	3388	3588	3762	3979	4183	4459	4850																	
flip-forward seat																													
8036P	2459	2571	2666	2774	2953	3117	3282	3425	3604	3772	3999	4321																	
with arm patches																													
8036PF	2609	2745	2860	2992	3208	3408	3608	3782	3999	4203	4479	4870																	
with arm patches + flip-forward seat																													
OVERALL DIMENSIONS			SEAT DIMENSIONS						BACK DIMENSIONS																				
			W	D	H	W	D	H	W	H																			
IN	29	31.5	38.5	21.5	20	17			21	21.5																			
MM	737	800	978	546	508	432			533	546																			
RTA 00			1 per carton																										

DESCRIPTION	FEATURES	MODEL #	STANDARD TEXTILE GRADES																																
			1	2	3	4	5	6	7	8	9	10	11	12																					
 <p>High Back Lounge Chair w/Sled Base COM: 3.75 YD 3.43 M Unit weight: 46 LB 20.9 KG Carton weight: 56 LB 25.4 KG Carton volume: 28.25 FT³ 0.79 MT³</p>	sealed seam upcharges <table border="1"> <thead> <tr> <th></th> <th>(S2)</th> <th>(SE)</th> </tr> </thead> <tbody> <tr> <td>8028</td> <td>Add \$76</td> <td>Add \$29</td> </tr> <tr> <td>8028F</td> <td>Add \$76</td> <td>Add \$44</td> </tr> <tr> <td>8028P</td> <td>Add \$93</td> <td>Add \$29</td> </tr> <tr> <td>8028PF</td> <td>Add \$93</td> <td>Add \$44</td> </tr> <tr> <td>8028PH</td> <td>Add \$112</td> <td>Add \$29</td> </tr> <tr> <td>8028PHF</td> <td>Add \$112</td> <td>Add \$44</td> </tr> </tbody> </table>		(S2)	(SE)	8028	Add \$76	Add \$29	8028F	Add \$76	Add \$44	8028P	Add \$93	Add \$29	8028PF	Add \$93	Add \$44	8028PH	Add \$112	Add \$29	8028PHF	Add \$112	Add \$44	8028	2150	2270	2371	2488	2679	2855	3031	3185	3376	3556	3800	4145
			(S2)	(SE)																															
		8028	Add \$76	Add \$29																															
		8028F	Add \$76	Add \$44																															
8028P	Add \$93	Add \$29																																	
8028PF	Add \$93	Add \$44																																	
8028PH	Add \$112	Add \$29																																	
8028PHF	Add \$112	Add \$44																																	
8028F	2325	2469	2591	2731	2959	3171	3383	3567	3797	4013	4305	4719																							
flip-forward seat																																			
8028P	2170	2290	2391	2508	2699	2875	3051	3205	3396	3576	3820	4165																							
with arm patches																																			
8028PF	2345	2489	2611	2751	2979	3191	3403	3587	3817	4033	4325	4739																							
with arm patches + flip-forward seat																																			
8028PH	2200	2320	2421	2538	2729	2905	3081	3235	3426	3606	3850	4195																							
with arm + head patches																																			
8028PHF	2375	2519	2641	2781	3009	3221	3433	3617	3847	4063	4355	4769																							
with arm + head patches + flip-forward seat																																			
OVERALL DIMENSIONS			SEAT DIMENSIONS						BACK DIMENSIONS																										
			W	D	H	W	D	H	W	H																									
IN	29	31.5	44.5	21.5	20	17			21	27.5																									
MM	737	800	1130	546	508	432			533	699																									
RTA 00			1 per carton																																

DESCRIPTION FEATURES MODEL # STANDARD TEXTILE GRADES



High Back Lounge Chair w/Four-Legged Wood Base
 COM: 3.75 YD | 3.43 M
 Unit weight: 46.5 LB | 21.1 KG
 Carton weight: 56.5 LB | 25.63 KG
 Carton volume: 28.25 FT³ | 0.79 MT³

	sealed seam upcharges	
	(S2)	(SE)
8029	Add \$76	Add \$29
8029F	Add \$76	Add \$44
8029P	Add \$93	Add \$29
8029PF	Add \$93	Add \$44
8029PH	Add \$112	Add \$29
8029PHF	Add \$112	Add \$44

	1	2	3	4	5	6	7	8	9	10	11	12
8029	2650	2770	2871	2988	3179	3355	3531	3685	3876	4056	4300	4645
8029F	2825	2969	3091	3231	3459	3671	3883	4067	4297	4513	4805	5219
flip-forward seat												
8029P	2670	2790	2891	3008	3199	3375	3551	3705	3896	4076	4320	4665
with arm patches												
8029PF	2845	2989	3111	3251	3479	3691	3903	4087	4317	4533	4825	5239
with arm patches + flip-forward seat												
8029PH	2700	2820	2921	3038	3229	3405	3581	3735	3926	4106	4350	4695
with arm + head patches												
8029PHF	2875	3019	3141	3281	3509	3721	3933	4117	4347	4563	4855	5269
with arm + head patches + flip-forward seat												

	OVERALL DIMENSIONS			SEAT DIMENSIONS			BACK DIMENSIONS		
	W	D	H	W	D	H	W	H	
IN	29	31.5	44.5	21.5	20	17	21	27.5	
MM	737	800	1130	546	508	432	533	699	

RTA 00 1 per carton



High Back Lounge Chair w/Wood Swivel Base
 COM: 3.75 YD | 3.43 M
 Unit weight: 47 LB | 21.4 KG
 Carton weight: 57 LB | 25.85 KG
 Carton volume: 28.25 FT³ | 0.79 MT³

	sealed seam upcharges	
	(S2)	(SE)
8037	Add \$76	Add \$29
8037F	Add \$76	Add \$44
8037P	Add \$93	Add \$29
8037PF	Add \$93	Add \$44
8037PH	Add \$112	Add \$29
8037PHF	Add \$112	Add \$44

	1	2	3	4	5	6	7	8	9	10	11	12
8037	2650	2770	2871	2988	3179	3355	3531	3685	3876	4056	4300	4645
8037F	2825	2969	3091	3231	3459	3671	3883	4067	4297	4513	4805	5219
flip-forward seat												
8037P	2670	2790	2891	3008	3199	3375	3551	3705	3896	4076	4320	4665
with arm patches												
8037PF	2845	2989	3111	3251	3479	3691	3903	4087	4317	4533	4825	5239
with arm patches + flip-forward seat												
8037PH	2700	2820	2921	3038	3229	3405	3581	3735	3926	4106	4350	4695
with arm + head patches												
8037PHF	2875	3019	3141	3281	3509	3721	3933	4117	4347	4563	4855	5269
with arm + head patches + flip-forward seat												

	OVERALL DIMENSIONS			SEAT DIMENSIONS			BACK DIMENSIONS		
	W	D	H	W	D	H	W	H	
IN	29	31.5	44.5	21.5	20	17	21	27.5	
MM	737	800	1130	546	508	432	533	699	

RTA 00 1 per carton









High Back Lounge Chair w/Chrome Swivel Base
 COM: 3.75 YD | 3.43 M
 Unit weight: 53 LB | 24.1 KG
 Carton weight: 63 LB | 28.58 KG
 Carton volume: 28.25 FT³ | 0.79 MT³

	sealed seam upcharges	
	(S2)	(SE)
8038	Add \$76	Add \$29
8038F	Add \$76	Add \$44
8038P	Add \$93	Add \$29
8038PF	Add \$93	Add \$44
8038PH	Add \$112	Add \$29
8038PHF	Add \$112	Add \$44

	1	2	3	4	5	6	7	8	9	10	11	12
8038	2666	2786	2887	3004	3195	3371	3547	3701	3892	4072	4316	4661
8038F	2841	2985	3107	3247	3475	3687	3899	4083	4313	4529	4821	5235
flip-forward seat												
8038P	2686	2806	2907	3024	3215	3391	3567	3721	3912	4092	4336	4681
with arm patches												
8038PF	2861	3005	3127	3267	3495	3707	3919	4103	4333	4549	4841	5255
with arm patches + flip-forward seat												
8038PH	2716	2836	2937	3054	3245	3421	3597	3751	3942	4122	4366	4711
with arm + head patches												
8038PHF	2891	3035	3157	3297	3525	3737	3949	4133	4363	4579	4871	5285
with arm + head patches + flip-forward seat												

	OVERALL DIMENSIONS			SEAT DIMENSIONS			BACK DIMENSIONS		
	W	D	H	W	D	H	W	H	
IN	29	31.5	44.5	21.5	20	17	21	27.5	
MM	737	800	1130	546	508	432	533	699	

RTA 00 1 per carton

DESCRIPTION	FEATURES	MODEL #	STANDARD TEXTILE GRADES																																																	
			1	2	3	4	5	6	7	8	9	10	11	12																																						
 <p>Counter Stool w/Sled Base COM: 1.5 YD 1.37 M Unit weight: 23.5 LB 10.7 KG Carton weight: 30 LB 13.61 KG Carton volume: 9 FT³ 0.25 MT³</p>	<table border="1"> <tr> <td>sealed seam upcharges</td> <td>(S2)</td> <td>(SE)</td> </tr> <tr> <td>8051</td> <td>Add \$26</td> <td>Add \$17</td> </tr> </table>	sealed seam upcharges	(S2)	(SE)	8051	Add \$26	Add \$17	<table border="1"> <tr> <th colspan="3">OVERALL DIMENSIONS</th> <th colspan="3">SEAT DIMENSIONS</th> <th colspan="2">BACK DIMENSIONS</th> </tr> <tr> <th>W</th> <th>D</th> <th>H</th> <th>W</th> <th>D</th> <th>H</th> <th>W</th> <th>H</th> </tr> <tr> <td>IN 19.25 MM 489</td> <td>19 483</td> <td>34.5 876</td> <td>15.5 394</td> <td>15.75 400</td> <td>24.5 622</td> <td>12.5 318</td> <td>10 254</td> </tr> <tr> <td colspan="8"> RTA 00 1 per carton </td> </tr> </table>	OVERALL DIMENSIONS			SEAT DIMENSIONS			BACK DIMENSIONS		W	D	H	W	D	H	W	H	IN 19.25 MM 489	19 483	34.5 876	15.5 394	15.75 400	24.5 622	12.5 318	10 254	RTA 00 1 per carton								1135	1183	1224	1270	1347	1417	1488	1549	1626	1698	1795	1933
		sealed seam upcharges	(S2)	(SE)																																																
		8051	Add \$26	Add \$17																																																
		OVERALL DIMENSIONS			SEAT DIMENSIONS				BACK DIMENSIONS																																											
W	D	H	W	D	H	W	H																																													
IN 19.25 MM 489	19 483	34.5 876	15.5 394	15.75 400	24.5 622	12.5 318	10 254																																													
RTA 00 1 per carton																																																				
 <p>Counter Stool w/Four-Legged Wood Base COM: 1.5 YD 1.37 M Unit weight: 22 LB 10 KG Carton weight: 28 LB 12.7 KG Carton volume: 9 FT³ 0.25 MT³</p>	<table border="1"> <tr> <td>sealed seam upcharges</td> <td>(S2)</td> <td>(SE)</td> </tr> <tr> <td>8052</td> <td>Add \$26</td> <td>Add \$17</td> </tr> </table>	sealed seam upcharges	(S2)	(SE)	8052	Add \$26	Add \$17	<table border="1"> <tr> <th colspan="3">OVERALL DIMENSIONS</th> <th colspan="3">SEAT DIMENSIONS</th> <th colspan="2">BACK DIMENSIONS</th> </tr> <tr> <th>W</th> <th>D</th> <th>H</th> <th>W</th> <th>D</th> <th>H</th> <th>W</th> <th>H</th> </tr> <tr> <td>IN 19.25 MM 489</td> <td>19 483</td> <td>34.5 876</td> <td>15.5 394</td> <td>15.75 400</td> <td>24.5 622</td> <td>12.5 318</td> <td>10 254</td> </tr> <tr> <td colspan="8"> RTA 00 1 per carton </td> </tr> </table>	OVERALL DIMENSIONS			SEAT DIMENSIONS			BACK DIMENSIONS		W	D	H	W	D	H	W	H	IN 19.25 MM 489	19 483	34.5 876	15.5 394	15.75 400	24.5 622	12.5 318	10 254	RTA 00 1 per carton								1685	1733	1774	1820	1897	1967	2038	2099	2176	2248	2345	2483
		sealed seam upcharges	(S2)	(SE)																																																
		8052	Add \$26	Add \$17																																																
		OVERALL DIMENSIONS			SEAT DIMENSIONS				BACK DIMENSIONS																																											
W	D	H	W	D	H	W	H																																													
IN 19.25 MM 489	19 483	34.5 876	15.5 394	15.75 400	24.5 622	12.5 318	10 254																																													
RTA 00 1 per carton																																																				
 <p>Counter Stool w/Chrome Swivel Base COM: 1.5 YD 1.37 M Unit weight: 36.5 LB 16.6 KG Carton weight: 43 LB 19.5 KG Carton volume: 11.5 FT³ 0.32 MT³</p>	<table border="1"> <tr> <td>sealed seam upcharges</td> <td>(S2)</td> <td>(SE)</td> </tr> <tr> <td>8053</td> <td>Add \$26</td> <td>Add \$17</td> </tr> </table>	sealed seam upcharges	(S2)	(SE)	8053	Add \$26	Add \$17	<table border="1"> <tr> <th colspan="3">OVERALL DIMENSIONS</th> <th colspan="3">SEAT DIMENSIONS</th> <th colspan="2">BACK DIMENSIONS</th> </tr> <tr> <th>W</th> <th>D</th> <th>H</th> <th>W</th> <th>D</th> <th>H</th> <th>W</th> <th>H</th> </tr> <tr> <td>IN 19.25 MM 489</td> <td>20 508</td> <td>34.5 876</td> <td>15.5 394</td> <td>15.75 400</td> <td>24.5 622</td> <td>12.5 318</td> <td>10 254</td> </tr> <tr> <td colspan="8"> RTA 00 1 per carton </td> </tr> </table>	OVERALL DIMENSIONS			SEAT DIMENSIONS			BACK DIMENSIONS		W	D	H	W	D	H	W	H	IN 19.25 MM 489	20 508	34.5 876	15.5 394	15.75 400	24.5 622	12.5 318	10 254	RTA 00 1 per carton								2185	2233	2274	2320	2397	2467	2538	2599	2676	2748	2845	2983
		sealed seam upcharges	(S2)	(SE)																																																
		8053	Add \$26	Add \$17																																																
		OVERALL DIMENSIONS			SEAT DIMENSIONS				BACK DIMENSIONS																																											
W	D	H	W	D	H	W	H																																													
IN 19.25 MM 489	20 508	34.5 876	15.5 394	15.75 400	24.5 622	12.5 318	10 254																																													
RTA 00 1 per carton																																																				
 <p>Bar Stool w/Sled Base COM: 1.5 YD 1.37 M Unit weight: 25 LB 11.4 KG Carton weight: 33 LB 14.97 KG Carton volume: 11 FT³ 0.31 MT³</p>	<table border="1"> <tr> <td>sealed seam upcharges</td> <td>(S2)</td> <td>(SE)</td> </tr> <tr> <td>8054</td> <td>Add \$26</td> <td>Add \$17</td> </tr> </table>	sealed seam upcharges	(S2)	(SE)	8054	Add \$26	Add \$17	<table border="1"> <tr> <th colspan="3">OVERALL DIMENSIONS</th> <th colspan="3">SEAT DIMENSIONS</th> <th colspan="2">BACK DIMENSIONS</th> </tr> <tr> <th>W</th> <th>D</th> <th>H</th> <th>W</th> <th>D</th> <th>H</th> <th>W</th> <th>H</th> </tr> <tr> <td>IN 19.25 MM 489</td> <td>20 508</td> <td>40 1016</td> <td>15.5 394</td> <td>15.75 400</td> <td>29.5 749</td> <td>12.5 318</td> <td>10 254</td> </tr> <tr> <td colspan="8"> RTA 00 1 per carton </td> </tr> </table>	OVERALL DIMENSIONS			SEAT DIMENSIONS			BACK DIMENSIONS		W	D	H	W	D	H	W	H	IN 19.25 MM 489	20 508	40 1016	15.5 394	15.75 400	29.5 749	12.5 318	10 254	RTA 00 1 per carton								1210	1258	1299	1345	1422	1492	1563	1624	1701	1773	1870	2008
		sealed seam upcharges	(S2)	(SE)																																																
		8054	Add \$26	Add \$17																																																
		OVERALL DIMENSIONS			SEAT DIMENSIONS				BACK DIMENSIONS																																											
W	D	H	W	D	H	W	H																																													
IN 19.25 MM 489	20 508	40 1016	15.5 394	15.75 400	29.5 749	12.5 318	10 254																																													
RTA 00 1 per carton																																																				
 <p>Bar Stool w/Four-Legged Wood Base COM: 1.5 YD 1.37 M Unit weight: 22.5 LB 10.2 KG Carton weight: 30 LB 13.61 KG Carton volume: 11 FT³ 0.31 MT³</p>	<table border="1"> <tr> <td>sealed seam upcharges</td> <td>(S2)</td> <td>(SE)</td> </tr> <tr> <td>8055</td> <td>Add \$26</td> <td>Add \$17</td> </tr> </table>	sealed seam upcharges	(S2)	(SE)	8055	Add \$26	Add \$17	<table border="1"> <tr> <th colspan="3">OVERALL DIMENSIONS</th> <th colspan="3">SEAT DIMENSIONS</th> <th colspan="2">BACK DIMENSIONS</th> </tr> <tr> <th>W</th> <th>D</th> <th>H</th> <th>W</th> <th>D</th> <th>H</th> <th>W</th> <th>H</th> </tr> <tr> <td>IN 19.25 MM 489</td> <td>20 508</td> <td>40 1016</td> <td>15.5 394</td> <td>15.75 400</td> <td>29.5 749</td> <td>12.5 318</td> <td>10 254</td> </tr> <tr> <td colspan="8"> RTA 00 1 per carton </td> </tr> </table>	OVERALL DIMENSIONS			SEAT DIMENSIONS			BACK DIMENSIONS		W	D	H	W	D	H	W	H	IN 19.25 MM 489	20 508	40 1016	15.5 394	15.75 400	29.5 749	12.5 318	10 254	RTA 00 1 per carton								1760	1808	1849	1895	1972	2042	2113	2174	2251	2323	2420	2558
		sealed seam upcharges	(S2)	(SE)																																																
		8055	Add \$26	Add \$17																																																
		OVERALL DIMENSIONS			SEAT DIMENSIONS				BACK DIMENSIONS																																											
W	D	H	W	D	H	W	H																																													
IN 19.25 MM 489	20 508	40 1016	15.5 394	15.75 400	29.5 749	12.5 318	10 254																																													
RTA 00 1 per carton																																																				
 <p>Bar Stool w/Chrome Swivel Base COM: 1.5 YD 1.37 M Unit weight: 38 LB 17.3 KG Carton weight: 45.5 LB 20.64 KG Carton volume: 13.25 FT³ 0.37 MT³</p>	<table border="1"> <tr> <td>sealed seam upcharges</td> <td>(S2)</td> <td>(SE)</td> </tr> <tr> <td>8056</td> <td>Add \$26</td> <td>Add \$17</td> </tr> </table>	sealed seam upcharges	(S2)	(SE)	8056	Add \$26	Add \$17	<table border="1"> <tr> <th colspan="3">OVERALL DIMENSIONS</th> <th colspan="3">SEAT DIMENSIONS</th> <th colspan="2">BACK DIMENSIONS</th> </tr> <tr> <th>W</th> <th>D</th> <th>H</th> <th>W</th> <th>D</th> <th>H</th> <th>W</th> <th>H</th> </tr> <tr> <td>IN 19.25 MM 489</td> <td>20 508</td> <td>40 1016</td> <td>15.5 394</td> <td>15.75 400</td> <td>29.5 749</td> <td>12.5 318</td> <td>10 254</td> </tr> <tr> <td colspan="8"> RTA 00 1 per carton </td> </tr> </table>	OVERALL DIMENSIONS			SEAT DIMENSIONS			BACK DIMENSIONS		W	D	H	W	D	H	W	H	IN 19.25 MM 489	20 508	40 1016	15.5 394	15.75 400	29.5 749	12.5 318	10 254	RTA 00 1 per carton								2260	2308	2349	2395	2472	2542	2613	2674	2751	2823	2920	3058
		sealed seam upcharges	(S2)	(SE)																																																
		8056	Add \$26	Add \$17																																																
		OVERALL DIMENSIONS			SEAT DIMENSIONS				BACK DIMENSIONS																																											
W	D	H	W	D	H	W	H																																													
IN 19.25 MM 489	20 508	40 1016	15.5 394	15.75 400	29.5 749	12.5 318	10 254																																													
RTA 00 1 per carton																																																				

DRIFT TABLES



model 8041R2616C



model 8042SQ2816I



model 8042SQ2816WSF

Drift Seating



For Drift seating, please see page 259.

DRIFT TABLE FINISHES COORDINATION CHART			
TFL/HPL TOP FINISH		COORDINATING WOOD BASE FINISH	
ACJ	Absolute Acajou	AAM	Absolute
		MWM	Medium Walnut
ASN	Asian Night	ASM	Night
AWC	Avant Cherry	ACM	Cherry
AWH	Avant Honey	AHM	Honey
BLK	Black	BKM	Black
CMB	Clear Maple	AVM	Maple
DES	Dark Espresso	ECM	Espresso Cafe
DWT	Designer White	WHM	White
NBL	Noce Biondo	NBM	Noce Biondo
NEL	Noce Leggero	NEM	Noce Leggero
NGL	Noce Grigio	NGM	Noce Grigio
NML	Noce Medio	NMM	Noce Medio
QTM	Quartered Mahogany	TMM	Mahogany
WCR	Winter Cherry	WCM	Winter Cherry
WHC	White Chocolate	WTM	WC Cream
WHE	Walnut Heights	NLW	Natural Walnut
TFL/HPL TOP FINISHES WITH NO COORDINATING WOOD BASE FINISHES		WOOD BASE FINISHES WITH NO COORDINATING HPL TOP FINISHES	
BRC**	Brushed Cobalt	EOM	English Oak
FAS**	Fashionista	NLW	Natural Walnut
FCL**	First Class	SKM	Shaker Cherry
SBY**	Sheer Beauty		
SOG**	Storm Grey		

**Chrome base models are available for all TFL/HPL top finishes

STANDARD FEATURES

- Tables are available in three shapes, multiple sizes, two edge styles and three top materials. All offer three base options: sled, four-legged wood and a polished chrome base.
- Table bases are fixed and do not swivel.
- Sled bases are available in two heights.
- Wood bases are made from beechwood and are available in all standard wood finishes.
- Sled bases are standard in paint and optionally available in Chrome. See upcharges.
- Chrome bases are available in polished chrome only.
- Table tops are available in either laminate or solid surface.
- Laminate flat edge tops are available in either a 1" thick thermally fused laminate (TFL) with 2mm edgeband or 1-1/16" thick high pressure laminate (HPL) with 2mm edgeband (see upcharge).
- Laminate knife edge tops are only available in 1-3/16" thick high pressure laminate (HPL) with 2.5mm edgeband.
- Solid surface tops are 1.25" thick, available with flat or knife edge tops.
- Polished chrome bases are equipped with White non-marking polycarbonate glides that are suitable for most hard and carpeted floor surfaces.
- Tables are shipped fully assembled.

Please specify based on the following criteria:

- **Model number** (suffix determines edge detail)
 - sled base models**
 - _____ **I** laminate flat edge
 - _____ **K** laminate knife edge
 - _____ **SF** solid surface flat edge
 - _____ **SK** solid surface knife edge
 - polished chrome base models**
 - _____ **C** laminate flat edge
 - _____ **CK** laminate knife edge
 - _____ **CSF** solid surface flat edge
 - _____ **CSK** solid surface knife edge
 - four-legged wood base models**
 - _____ **W** laminate flat edge
 - _____ **WK** laminate knife edge
 - _____ **WSF** solid surface flat edge
 - _____ **WSK** solid surface knife edge

• Top details

LAMINATE

Surface type (laminate flat edge tables only)
(TFL) Thermally fused laminate
(HPL) High pressure laminate

Top finish (see model for HPL upcharges)

- | | |
|------------------------------|---------------------------------|
| (ACJ) Absolute Acajou | (FCL) First Class |
| (ASN) Asian Night | (NBL) Noce Biondo |
| (AWC) Avant Cherry | (NGL) Noce Grigio |
| (AWH) Avant Honey | (NEL) Noce Leggero |
| (BLK) Black | (NML) Noce Medio |
| (BZD) Blizzard | (QTM) Quartered Mahogany |
| (BRC) Brushed Cobalt | (SBY) Sheer Beauty |
| (CMB) Clear Maple | (SDT) Stonedust |
| (CGY) Custom Grey | (SOG) Storm Grey |
| (DES) Dark Espresso | (WHE) Walnut Heights |
| (DWT) Designer White | (WHC) White Chocolate |
| (FAS) Fashionista | (WCR) Winter Cherry |

SOLID SURFACE

Top finish (see model for grade 2 upcharges)

- (SWH)** Designer White - grade 1
- (SBT)** Beige Tempest - grade 2
- (SBX)** Black Onyx Mirage - grade 2
- (SFW)** Frosty White Mirage - grade 2
- (SHS)** Hot Stone - grade 2
- (SMG)** Milk Glass Spectra - grade 2
- (SNM)** Northern Melange - grade 2

• Base finish

SLED BASE

For leg frame finish options, please see page 379. Upcharges apply for the following plated finish:

(CHM) Chrome. Add \$33.

WOOD BASE (see coordination chart)

- | | |
|----------------------------|-----------------------------|
| (AAM) Absolute | (NLW) Natural Walnut |
| (BKM) Black | (ASM) Night |
| (ACM) Cherry | (NBM) Noce Biondo |
| (EOM) English Oak | (NGM) Noce Grigio |
| (ECM) Espresso Cafe | (NEM) Noce Leggero |
| (TFM) Fruitwood | (NMM) Noce Medio |
| (HGM) Gray | (SKM) Shaker Cherry |
| (AHM) Honey | (TWM) Walnut |
| (TMM) Mahogany | (WTM) WC Cream |
| (AVM) Maple | (WHM) White |
| (MWM) Medium Walnut | (WCM) Winter Cherry |

POLISHED CHROME BASE

(CHM) Chrome.

• Glide type

SLED BASE GLIDES

- (CG)** clear polycarbonate glides for most surfaces (standard)
- (XG)** no glides (carpeted surface)
- (SG)** steel cushioned glides for carpeted surfaces. Add \$19.
- (RG)** rubber glides for most hard floor surfaces. Add \$19.
- (FG)** felt glides for most hard floor surfaces. Add \$19.

WOOD BASE GLIDES

- (NM)** White non-marking nylon for most surfaces (standard)
- (SG)** steel cushioned glides for carpeted surfaces. Add \$17.
- (RG)** non-slip rubber glides for most hard floor surfaces. Add \$22.
- (FG)** felt glides for most hard floor surfaces. Add \$22.

Please note that these finishes are coordinating and not exact matches. Please reach out to your Global Sales representative for physical samples of finishes prior to ordering.

DESCRIPTION	MODEL #	DIMENSIONS	WT/LB.	CUBIC FT.	LIST PRICE	HP ADD	GRADE 2+	
 Round Table w/Polished Chrome Four Star Base	W x D x H							
	Laminate Flat Edge							
	8041R2616C	26 x 26 x 16	30	10.75	\$865	\$91	N/A	
	8041R3016C	30 x 30 x 16	34	13	\$898	\$108	N/A	
	Laminate Knife Edge							
	8041R2616CK	26 x 26 x 16	30	10.75	\$1504	N/A	N/A	
	8041R3016CK	30 x 30 x 16	34	13	\$1697	N/A	N/A	
	Solid Surface Flat Edge							
	8041R2616CSF	26 x 26 x 16	43	10.75	\$2789	N/A	\$171	
	8041R3016CSF	30 x 30 x 16	51.5	13	\$2982	N/A	\$235	
Solid Surface Knife Edge								
8041R2616CSK	26 x 26 x 16	43	10.75	\$2847	N/A	\$183		
8041R3016CSK	30 x 30 x 16	51.5	13	\$3070	N/A	\$253		

Finished height will vary depending on material top. Shipped fully assembled in 1 carton.



Round Table w/Sled Base

Laminate Flat Edge							
8041R2616I	26 x 26 x 16	28	10.25	\$489	\$91	N/A	
8041R3016I	30 x 30 x 16	33	13	\$522	\$108	N/A	
8041R2120I	21 x 21 x 20	23	8.75	\$487	\$89	N/A	
Laminate Knife Edge							
8041R2616IK	26 x 26 x 16	28	10.25	\$1128	N/A	N/A	
8041R3016IK	30 x 30 x 16	33	13	\$1321	N/A	N/A	
8041R2120IK	21 x 21 x 20	23	8.75	\$941	N/A	N/A	
Solid Surface Flat Edge							
8041R2616ISF	26 x 26 x 16	41	10.25	\$2413	N/A	\$171	
8041R3016ISF	30 x 30 x 16	50	13	\$2606	N/A	\$235	
8041R2120ISF	21 x 21 x 20	31.5	8.75	\$2263	N/A	\$118	
Solid Surface Knife Edge							
8041R2616ISK	26 x 26 x 16	41	10.25	\$2471	N/A	\$183	
8041R3016ISK	30 x 30 x 16	50	13	\$2694	N/A	\$253	
8041R2120ISK	21 x 21 x 20	31.5	8.75	\$2369	N/A	\$123	

Finished height will vary depending on material top. Shipped fully assembled in 1 carton.



Round Table w/Wood Four Star Base

Laminate Flat Edge							
8041R2616W	26 x 26 x 16	24	10.75	\$975	\$91	N/A	
8041R3016W	30 x 30 x 16	29	13	\$1008	\$108	N/A	
Laminate Knife Edge							
8041R2616WK	26 x 26 x 16	24	10.75	\$1614	N/A	N/A	
8041R3016WK	30 x 30 x 16	29	13	\$1807	N/A	N/A	
Solid Surface Flat Edge							
8041R2616WSF	26 x 26 x 16	37.5	10.75	\$2899	N/A	\$171	
8041R3016WSF	30 x 30 x 16	46.5	13	\$3092	N/A	\$235	
Solid Surface Knife Edge							
8041R2616WSK	26 x 26 x 16	37.5	10.75	\$2957	N/A	\$183	
8041R3016WSK	30 x 30 x 16	46.5	13	\$3180	N/A	\$253	

Finished height will vary depending on material top. Shipped fully assembled in 1 carton.

DESCRIPTION	MODEL #	DIMENSIONS	WT/LB.	CUBIC FT.	LIST PRICE	HP ADD	GRADE 2+
-------------	---------	------------	--------	-----------	------------	--------	----------



Square Table w/Polished Chrome Four Star Base

		W x D x H					
Laminate Flat Edge							
8042SQ2216C		22.75 x 22.75 x 16	29	7.75	\$865	\$91	N/A
8042SQ2816C		28.5 x 28.5 x 16	36	11.5	\$898	\$108	N/A
Laminate Knife Edge							
8042SQ2216CK		22.75 x 22.75 x 16	29	7.75	\$1300	N/A	N/A
8042SQ2816CK		28.5 x 28.5 x 16	36	11.5	\$1493	N/A	N/A
Solid Surface Flat Edge							
8042SQ2216CSF		22.75 x 22.75 x 16	34	7.75	\$2488	N/A	\$147
8042SQ2816CSF		28.5 x 28.5 x 16	48.5	11.5	\$2832	N/A	\$235
Solid Surface Knife Edge							
8042SQ2216CSK		22.75 x 22.75 x 16	34	7.75	\$2847	N/A	\$176
8042SQ2816CSK		28.5 x 28.5 x 16	48.5	11.5	\$3421	N/A	\$265

Finished height will vary depending on material top. Shipped fully assembled in 1 carton.



Square Table w/Sled Base

Laminate Flat Edge							
8042SQ2216I		22.5 x 22.5 x 16	27	8	\$489	\$91	N/A
8042SQ2816I		28.5 x 28.5 x 16	35	11.75	\$522	\$108	N/A
8042SQ1920I		19.5 x 19.5 x 20	23.5	7.75	\$487	\$89	N/A
Laminate Knife Edge							
8042SQ2216IK		22.5 x 22.5 x 16	27	8	\$924	N/A	N/A
8042SQ2816IK		28.5 x 28.5 x 16	35	11.75	\$1117	N/A	N/A
8042SQ1920IK		19.5 x 19.5 x 20	23.5	7.75	\$881	N/A	N/A
Solid Surface Flat Edge							
8042SQ2216ISF		22.5 x 22.5 x 16	32.5	8	\$2112	N/A	\$147
8042SQ2816ISF		28.5 x 28.5 x 16	53.5	11.75	\$2456	N/A	\$235
8042SQ1920ISF		19.5 x 19.5 x 20	31.5	7.75	\$2017	N/A	\$123
Solid Surface Knife Edge							
8042SQ2216ISK		22.5 x 22.5 x 16	32.5	8	\$2471	N/A	\$176
8042SQ2816ISK		28.5 x 28.5 x 16	53.5	11.75	\$3045	N/A	\$265
8042SQ1920ISK		19.5 x 19.5 x 20	31.5	7.75	\$2369	N/A	\$130

Finished height will vary depending on material top. Shipped fully assembled in 1 carton.



Square Table w/Wood Four Star Base

Laminate Flat Edge							
8042SQ2216W		22.75 x 22.75 x 16	23	7.75	\$975	\$91	N/A
8042SQ2816W		28.5 x 28.5 x 16	30	11.5	\$1008	\$108	N/A
Laminate Knife Edge							
8042SQ2216WK		22.75 x 22.75 x 16	23	7.75	\$1410	N/A	N/A
8042SQ2816WK		28.5 x 28.5 x 16	30	11.5	\$1603	N/A	N/A
Solid Surface Flat Edge							
8042SQ2216WSF		22.75 x 22.75 x 16	29	7.75	\$2598	N/A	\$147
8042SQ2816WSF		28.5 x 28.5 x 16	50	11.5	\$2942	N/A	\$235
Solid Surface Knife Edge							
8042SQ2216WSK		22.75 x 22.75 x 16	29	7.75	\$2957	N/A	\$176
8042SQ2816WSK		28.5 x 28.5 x 16	50	11.5	\$3531	N/A	\$265

Finished height will vary depending on material top. Shipped fully assembled in 1 carton.

DESCRIPTION	MODEL #	DIMENSIONS	WT/LB.	CUBIC FT.	LIST PRICE	HP ADD	GRADE 2+	
 Oval Table w/Polished Chrome Four Star Base	W x D x H							
	Laminate Flat Edge							
		80430V2616C	26 x 22 x 16	30	9.25	\$865	\$91	N/A
		80430V3116C	31 x 26 x 16	34	11.75	\$898	\$108	N/A
	Laminate Knife Edge							
		80430V2616CK	26 x 22 x 16	30	9.25	\$1504	N/A	N/A
		80430V3116CK	31 x 26 x 16	34	11.75	\$1697	N/A	N/A
	Solid Surface Flat Edge							
		80430V2616CSF	26 x 22 x 16	41.5	9.25	\$2789	N/A	\$171
		80430V3116CSF	31 x 26 x 16	51.5	11.75	\$2982	N/A	\$235
	Solid Surface Knife Edge							
		80430V3116CSK	31 x 26 x 16	51.5	11.75	\$3070	N/A	\$253
	80430V3116CSK	31 x 26 x 16	51.5	11.75	\$3070	N/A	\$253	

Finished height will vary depending on material top. Shipped fully assembled in 1 carton.

 Oval Table w/Sled Base	Laminate Flat Edge							
		80430V2616I	22 x 26 x 16	28.5	8.75	\$489	\$91	N/A
		80430V3116I	31 x 26 x 16	36	11.75	\$522	\$108	N/A
		80430V2220I	18 x 22 x 20	28	10.75	\$487	\$89	N/A
	Laminate Knife Edge							
		80430V2616IK	22 x 26 x 16	28.5	8.75	\$1128	N/A	N/A
		80430V3116IK	31 x 26 x 16	36	11.75	\$1321	N/A	N/A
		80430V2220IK	18 x 22 x 20	28	10.75	\$941	N/A	N/A
	Solid Surface Flat Edge							
		80430V2616ISF	22 x 26 x 16	34	8.75	\$2413	N/A	\$171
		80430V3116ISF	31 x 26 x 16	50	11.75	\$2606	N/A	\$235
		80430V2220ISF	18 x 22 x 20	32	10.75	\$2263	N/A	\$118
Solid Surface Knife Edge								
	80430V2616ISK	22 x 26 x 16	38	8.75	\$2471	N/A	\$183	
	80430V3116ISK	31 x 26 x 16	50	11.75	\$2694	N/A	\$253	
	80430V2220ISK	18 x 22 x 20	32	10.75	\$2369	N/A	\$123	

Finished height will vary depending on material top. Shipped fully assembled in 1 carton.

 Oval Table w/Wood Four Star Base	Laminate Flat Edge							
		80430V2616W	26 x 22 x 16	24	9.25	\$975	\$91	N/A
		80430V3116W	31 x 26 x 16	29	11.75	\$1008	\$108	N/A
	Laminate Knife Edge							
		80430V2616WK	26 x 22 x 16	24	9.25	\$1614	N/A	N/A
		80430V3116WK	31 x 26 x 16	29	11.75	\$1807	N/A	N/A
	Solid Surface Flat Edge							
		80430V2616WSF	26 x 22 x 16	36.5	9.25	\$2899	N/A	\$171
		80430V3116WSF	31 x 26 x 16	46.5	11.75	\$3092	N/A	\$235
	Solid Surface Knife Edge							
		80430V3116WSK	31 x 26 x 16	46.5	11.75	\$3180	N/A	\$253
		80430V3116WSK	31 x 26 x 16	46.5	11.75	\$3180	N/A	\$253

Finished height will vary depending on material top. Shipped fully assembled in 1 carton.

JEO



model 8434



model 8433-4



Optional quilted stitch back (Q)



model 8435-2224



model 8436-1530





Optional five prong base with glides (G)

STANDARD FEATURES

- Jeo is a contemporary, retro-inspired series with versatility for a variety of workplace applications.
- The tailored box styling functions well in lounge, conferencing, collaboration and side/guest environments.
- Three seating models: a swivel tilter with a five prong caster base, a swivel self-centering return with a stationary round pedestal base or a matching four legged arm chair.
- Model 8433-4 is standard with a five prong Black nylon base with carpet casters (CX).
- Model 8437 is standard with Black (TBL) four-legged frame.
- Jeo also offers two styles of matching pedestal base occasional tables with a round or square laminate top, available in two height sizes (15" and 22" high).
- Upholstery options: fabric, vinyl, leather or a combination of two or more materials. Vinyl and leather models may feature stitch detail across the seat and/or back cushions, if applicable. The upholstery surfaces are seamed together with tailored double stitch detailing.

OPTIONAL FEATURES

- Chairs are available with an optional quilted stitch back, specify (Q). Add \$131.
- Model 8433-4 has an optional five prong aluminum base, specify (PA). Add \$175.
- Optional five prong aluminum base with hard glides, specify (HG). Add \$49.
- Optional soft casters are available on the five prong base, specify (ID). Add \$21.
- Model 8434 round pedestal base available in Chrome (CHM) or Brushed Chrome (BCH), please specify.
- Model 8437 has an optional Tungsten (TTU) or Designer White (TDW) four-legged frame. No upcharge. For Chrome (CHM) or Brushed Chrome (BCH) finish, add \$175.
- Occasional tables are available in the following laminate finishes to coordinate with Global desking and wood seating: Absolute Acajou (ACJ), Asian Night (ASN), Avant Cherry (AWC), Avant Honey (AWH), Black (BLK), Blizzard (BZD), Brushed Cobalt (BRC), Clear Maple (CMB), Custom Grey (CGY), Dark Espresso (DES), Designer White (DWT), Fashionista (FAS), First Class (FCL), Noce Biondo (NBL), Noce Grigio (NGL), Noce Leggero (NEL), Noce Medio (NML), Quartered Mahogany (QTM), Sheer Beauty (SBY), Stonedust (SDT), Storm Grey (SOG), Walnut Heights (WHE), White Chocolate (WHC) and Winter Cherry (WCR). Please specify.

DESCRIPTION	FEATURES	MODEL #	STANDARD TEXTILE GRADES											
			1	2	3	4	5	6	7	8	9	10	11	12
 <p>Self-Centering Lounge Chair on Pedestal Base COM: 2.75 YD 2.51 M Unit weight: 50 LB 22.7 KG Carton weight: 56 LB 25.4 KG Carton volume: 14.25 FT³ 0.4 MT³</p>	Ergonomic features: C	8434	1945	2033	2107	2193	2333	2462	2591	2704	2844	2976	3155	3408
		OVERALL DIMENSIONS			SEAT DIMENSIONS			BACK DIMENSIONS						
		W	D	H	W	D	H	W	H					
		IN 26 MM 660	25 635	30 762	20 508	19 483	16.5 419	20 508	15 381					
		RTA 00	1 per carton											
 <p>Swivel Tilter Chair COM: 2.75 YD 2.51 M Unit weight: 50 LB 22.7 KG Carton weight: 56 LB 25.4 KG Carton volume: 14.25 FT³ 0.4 MT³</p>	Ergonomic features: A, B, C, S	8433-4	1295	1383	1457	1543	1683	1812	1941	2054	2194	2326	2505	2758
		OVERALL DIMENSIONS			SEAT DIMENSIONS			BACK DIMENSIONS						
		W	D	H	W	D	H	W	H					
		IN 26 MM 660	25 635	30 762	20 508	19 483	16.5 419	20 508	15 381					
		RTA 00	1 per carton											
 <p>Armchair COM: 2.75 YD 2.51 M Unit weight: 50 LB 22.7 KG Carton weight: 57 LB 25.85 KG Carton volume: 15.75 FT³ 0.44 MT³</p>		8437	1432	1520	1594	1680	1820	1949	2078	2191	2331	2463	2642	2895
		OVERALL DIMENSIONS			SEAT DIMENSIONS			BACK DIMENSIONS						
		W	D	H	W	D	H	W	H					
		IN 26 MM 660	25 635	32.5 826	20 508	19 483	18 457	20 508	15 381					
		RTA 00	1 per carton											

DESCRIPTION	FEATURES	MODEL #	STANDARD TEXTILE GRADES						
	<p>15\"/> </p>	8435-1524	List price						
		939							
		OVERALL DIMENSIONS			SEAT DIMENSIONS			BACK DIMENSIONS	
		W	D	H	W	D	H	W	H
IN 24	24	15	-	-	-	-	-		
MM 610	610	381	-	-	-	-	-		
<p>COM: N/A </p>		<p>RTA 00 1 per carton</p>							
	<p>15\"/> </p>	8435-1530	List price						
		1120							
		OVERALL DIMENSIONS			SEAT DIMENSIONS			BACK DIMENSIONS	
		W	D	H	W	D	H	W	H
IN 30	30	15	-	-	-	-	-		
MM 762	762	381	-	-	-	-	-		
<p>COM: N/A </p>		<p>RTA 00 1 per carton</p>							
	<p>22\"/> </p>	8435-2224	List price						
		975							
		OVERALL DIMENSIONS			SEAT DIMENSIONS			BACK DIMENSIONS	
		W	D	H	W	D	H	W	H
IN 24	24	22	-	-	-	-	-		
MM 610	610	559	-	-	-	-	-		
<p>COM: N/A </p>		<p>RTA 00 1 per carton</p>							
	<p>22\"/> </p>	8435-2230	List price						
		1155							
		OVERALL DIMENSIONS			SEAT DIMENSIONS			BACK DIMENSIONS	
		W	D	H	W	D	H	W	H
IN 30	30	22	-	-	-	-	-		
MM 762	762	559	-	-	-	-	-		
<p>COM: N/A </p>		<p>RTA 00 1 per carton</p>							
	<p>15\"/> </p>	8436-1524	List price						
		939							
		OVERALL DIMENSIONS			SEAT DIMENSIONS			BACK DIMENSIONS	
		W	D	H	W	D	H	W	H
IN 24	24	15	-	-	-	-	-		
MM 610	610	381	-	-	-	-	-		
<p>COM: N/A </p>		<p>RTA 00 1 per carton</p>							
	<p>15\"/> </p>	8436-1530	List price						
		1120							
		OVERALL DIMENSIONS			SEAT DIMENSIONS			BACK DIMENSIONS	
		W	D	H	W	D	H	W	H
IN 30	30	15	-	-	-	-	-		
MM 762	762	381	-	-	-	-	-		
<p>COM: N/A </p>		<p>RTA 00 1 per carton</p>							

DESCRIPTION FEATURES MODEL # STANDARD TEXTILE GRADES



22"H Square End Table - 24" Top on Pedestal Base
 COM: N/A
 Unit weight: 35 LB | 15.9 KG
 Carton weight: 40 LB | 18.14 KG
 Carton volume: 11.5 FT³ | 0.32 MT³

List price							
8436-2224	975						
OVERALL DIMENSIONS			SEAT DIMENSIONS			BACK DIMENSIONS	
W	D	H	W	D	H	W	H
IN 24	24	22	-	-	-	-	-
MM 610	610	559	-	-	-	-	-
RTA 00		1 per carton					



22"H Square End Coffee - 30" Top on Pedestal Base
 COM: N/A
 Unit weight: 39 LB | 17.7 KG
 Carton weight: 44 LB | 19.96 KG
 Carton volume: 16.75 FT³ | 0.47 MT³

List price							
8436-2230	1155						
OVERALL DIMENSIONS			SEAT DIMENSIONS			BACK DIMENSIONS	
W	D	H	W	D	H	W	H
IN 30	30	22	-	-	-	-	-
MM 762	762	559	-	-	-	-	-
RTA 00		1 per carton					

KATE



model 2811-4



model 2811-8







STANDARD FEATURES

- A contemporary, yet retro series featuring sculpted seat and back cushions.
- Fully upholstered closed arms offer a unique style and function in the workplace.
- Tilter and swivel are standard with a five prong, polished aluminum base with dual wheel carpet casters (**C10**).
- Armchair and ottoman are standard with steel frame and leg in Chrome finish. These bases are equipped with a Black polypropylene glide as standard.
- Upholstery options: fabric, vinyl or leather. Vinyl and leather models may feature stitch detail across the seat and/or back cushions, if applicable.

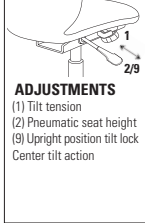
OPTIONAL FEATURES

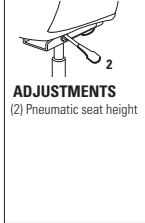
- There are no arm options for this series.
- An optional Black injection molded base (**BLK**) is available, please specify. No upcharge.
- (**C7**) glides are available, please specify. No upcharge.
- For hard surface flooring casters, please specify (**C10R**). Add \$20.
- For additional caster options, please refer to the Arm and Caster section (page 352). *Optional casters may be priced higher than the standard casters for your chair and the difference will be charged. Lower priced optional casters will not be credited.*



DESCRIPTION	FEATURES	MODEL #	STANDARD TEXTILE GRADES													
			1	2	3	4	5	6	7	8	9	10	11	12		
 <p>MB Tilter COM: 3.75 YD 3.43 M Unit weight: 40 LB 18.2 KG Carton weight: 50 LB 22.68 KG Carton volume: 19.25 FT³ 0.54 MT³</p>	 <p>ADJUSTMENTS (1) Tilt tension (2) Pneumatic seat height (9) Upright position tilt lock Center tilt action</p> <p>Ergonomic features: A, B, C, N</p>	2811-4	1187	1307	1408	1525	1716	1892	2068	2222	2413	2593	2837	3182		
		OVERALL DIMENSIONS			SEAT DIMENSIONS			BACK DIMENSIONS								
		W	D	H	W	D	H	W	H							
		IN 26 MM 660	24.5 622	33 838	17.5 445	18 457	17.5-22.5 445-572	19 483	15.5 394							
		RTA 00	1 per carton													
 <p>MB Swivel COM: 3.75 YD 3.43 M Unit weight: 36 LB 16.4 KG Carton weight: 46 LB 20.87 KG Carton volume: 19.5 FT³ 0.55 MT³</p>	 <p>ADJUSTMENTS (2) Pneumatic seat height</p> <p>Ergonomic features: C, N</p>	2811-8	1161	1281	1382	1499	1690	1866	2042	2196	2387	2567	2811	3156		
		OVERALL DIMENSIONS			SEAT DIMENSIONS			BACK DIMENSIONS								
		W	D	H	W	D	H	W	H							
		IN 26 MM 660	24.5 622	33 838	17.5 445	18 457	17.5-22.5 445-572	19 483	15.5 394							
		RTA 00	1 per carton													
 <p>MB Armchair COM: 3.75 YD 3.43 M Unit weight: 36 LB 16.4 KG Carton weight: 46 LB 20.87 KG Carton volume: 19.5 FT³ 0.55 MT³</p>	<p>Ergonomic features: N</p>	2813	1128	1248	1349	1466	1657	1833	2009	2163	2354	2534	2778	3123		
		OVERALL DIMENSIONS			SEAT DIMENSIONS			BACK DIMENSIONS								
		W	D	H	W	D	H	W	H							
		IN 26.5 MM 673	26.5 673	33.5 851	17.5 445	18 457	18 457	19 483	15.5 394							
		RTA 00	1 per carton													
 <p>Ottoman COM: 1.5 YD 1.37 M Unit weight: 17 LB 7.7 KG Carton weight: 22 LB 9.98 KG Carton volume: 6 FT³ 0.16 MT³</p>	<p>Ergonomic features: N</p>	2814	740	788	829	875	952	1022	1093	1154	1231	1303	1400	1538		
		OVERALL DIMENSIONS			SEAT DIMENSIONS			BACK DIMENSIONS								
		W	D	H	W	D	H	W	H							
		IN 23.5 MM 597	18.75 476	17.75 451	- -	- -	17.75 451	- -	- -							
		RTA 00		1 per carton												

LUX



model LX2426AC







model LX8033S



STANDARD FEATURES

- Lux features contemporary styling with luxurious cushions.
- Sofa cushions are removable.
- Fully upholstered.
- Wood legs with non-marking, clear glides.
- Cylindrical bolsters are included with lounge chair models. One bolster on single seat lounge chair and two bolsters on two-seat and three-seat sofas.
- Upholstery options: fabric, vinyl or leather. Vinyl and leather models may feature stitch detail across the seat and/or back cushions, if applicable.

OPTIONAL FEATURES

- Wood frames available in Absolute (AAM), Black (BKM), Cherry (ACM), English Oak (EOM), Espresso Cafe (ECM), Fruitwood (TFM), Gray (HGM), Honey (AHM), Mahogany (TMM), Maple (AVM), Medium Walnut (MWM), Natural Walnut (NLW), Night (ASM), Noce Biondo (NBM), Noce Grigio (NGM), Noce Leggero (NEM), Noce Medio (NMM), Shaker Cherry (SKM), Walnut (TWM), WC Cream (WTM), White (WHM) and Winter Cherry (WCM). Please specify.

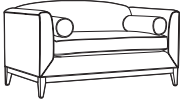
DESCRIPTION	FEATURES	MODEL #	STANDARD TEXTILE GRADES												
			1	2	3	4	5	6	7	8	9	10	11	12	
 <p>Side Chair COM: 3 YD 2.74 M Unit weight: 26 LB 11.8 KG Carton weight: 36 LB 16.33 KG Carton volume: 17.75 FT³ 0.5 MT³</p>		LX2226SC	1410	1506	1587	1680	1833	1974	2115	2238	2391	2535	2730	3006	
			OVERALL DIMENSIONS			SEAT DIMENSIONS			BACK DIMENSIONS						
				W	D	H	W	D	H	W	H				
				IN 25	27.75	36	18	19.5	19	24	17				
				MM 635	705	914	457	495	483	610	432				
			RTA 00	1 per carton											
 <p>Armchair COM: 3.25 YD 2.97 M Unit weight: 30 LB 13.6 KG Carton weight: 40 LB 18.14 KG Carton volume: 17.75 FT³ 0.5 MT³</p>		LX2426AC	1778	1882	1970	2071	2236	2389	2542	2675	2841	2997	3208	3507	
			OVERALL DIMENSIONS			SEAT DIMENSIONS			BACK DIMENSIONS						
				W	D	H	W	D	H	W	H				
				IN 26	27.75	36	18	19.5	19	24	17				
				MM 660	705	914	457	495	483	610	432				
			RTA 00	1 per carton											
 <p>Lounge Chair COM: 8.5 YD 7.77 M Unit weight: 65 LB 29.5 KG Carton weight: 77 LB 34.93 KG Carton volume: 30.25 FT³ 0.85 MT³</p>		LX3433CH	2869	3141	3371	3634	4068	4467	4867	5215	5649	6057	6609	7391	
			OVERALL DIMENSIONS			SEAT DIMENSIONS			BACK DIMENSIONS						
				W	D	H	W	D	H	W	H				
				IN 35	34	33	22	20.5	21	22	11				
				MM 889	864	838	559	521	533	559	279				
			RTA 00	1 per carton											
 <p>Ottoman COM: 2.5 YD 2.29 M Unit weight: 40 LB 18.2 KG Carton weight: 48 LB 21.77 KG Carton volume: 18.25 FT³ 0.51 MT³</p>		LX3636OTT	1915	1995	2063	2140	2268	2385	2503	2605	2733	2853	3015	3245	
			OVERALL DIMENSIONS			SEAT DIMENSIONS			BACK DIMENSIONS						
				W	D	H	W	D	H	W	H				
				IN 36	36	16	36	-	16	-	-				
				MM 914	914	406	914	-	406	-	-				
			RTA 00	1 per carton											

DESCRIPTION	FEATURES	MODEL #	STANDARD TEXTILE GRADES											
			1	2	3	4	5	6	7	8	9	10	11	12
 <p>Two Seat Sofa w/Cylindrical Bolsters COM: 12 YD 10.97 M Unit weight: 90 LB 40.9 KG Carton weight: 105 LB 47.63 KG Carton volume: 50.25 FT³ 1.42 MT³</p>		LX6033S	4100	4484	4808	5180	5792	6356	6920	7412	8024	8600	9380	10484
			OVERALL DIMENSIONS			SEAT DIMENSIONS			BACK DIMENSIONS					
			W	D	H	W	D	H	W	H				
			IN 61	34	33	47.75	20.5	21	47.75	11				
			MM 1549	864	838	1213	521	533	1213	279				
		RTA 00	1 per carton											
 <p>Three Seat Sofa w/Cylindrical Bolsters COM: 14.75 YD 13.49 M Unit weight: 105 LB 47.7 KG Carton weight: 125 LB 56.7 KG Carton volume: 66.25 FT³ 1.87 MT³</p>		LX8033S	4948	5420	5818	6276	7028	7721	8414	9019	9771	10479	11438	12795
			OVERALL DIMENSIONS			SEAT DIMENSIONS			BACK DIMENSIONS					
			W	D	H	W	D	H	W	H				
			IN 81	34	33	68	20.5	21	68	11				
			MM 2057	864	838	1727	521	533	1727	279				
		RTA 00	1 per carton											

ML









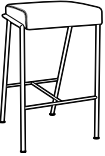

model ML2630

STANDARD FEATURES

- Modern seating with a distinctive retro design featuring a steel tube frame, legs and arms.
- Fully upholstered continuous seat and back cushions.
- Standard with non-marking Black glides.
- Upholstery options: fabric, vinyl or leather. Vinyl and leather models may feature stitch detail across the seat and/or back cushions, if applicable.

OPTIONAL FEATURES

- Available in five frame finish options: Chrome (**CHM**), Brushed Chrome (**BCH**), Black (**TBL**), Designer White (**TDW**) or Tungsten (**TTU**), please specify. No upcharge.

DESCRIPTION	FEATURES	MODEL #	STANDARD TEXTILE GRADES												
			1	2	3	4	5	6	7	8	9	10	11	12	
 <p>Counter Height Stool - 24" Seat Height COM: 0.5 YD 0.46 M Unit weight: 17 LB 7.7 KG Carton weight: 24 LB 10.89 KG Carton volume: 9.5 FT³ 0.26 MT³</p>		ML171724	1483	1499	1513	1528	1554	1577	1601	1621	1647	1671	1703	1749	
				OVERALL DIMENSIONS			SEAT DIMENSIONS			BACK DIMENSIONS					
				W	D	H	W	D	H	W	H				
			IN 18	19	24	-	-	-	-	-	-	-	-	-	
			MM 457	483	610	-	-	-	-	-	-	-	-	-	
			RTA 00		1 per carton										
 <p>Bar Height Stool - 30" Seat Height COM: 0.5 YD 0.46 M Unit weight: 18 LB 8.2 KG Carton weight: 26 LB 11.79 KG Carton volume: 13.75 FT³ 0.38 MT³</p>		ML171730	1517	1533	1547	1562	1588	1611	1635	1655	1681	1705	1737	1783	
				OVERALL DIMENSIONS			SEAT DIMENSIONS			BACK DIMENSIONS					
				W	D	H	W	D	H	W	H				
			IN 18	20.5	30	-	-	-	-	-	-	-	-	-	
			MM 457	521	762	-	-	-	-	-	-	-	-	-	
			RTA 00		1 per carton										
 <p>Bar Height Stool - 33" Seat Height COM: 0.5 YD 0.46 M Unit weight: 19 LB 8.6 KG Carton weight: 27 LB 12.25 KG Carton volume: 13.75 FT³ 0.38 MT³</p>		ML171733	1550	1566	1580	1595	1621	1644	1668	1688	1714	1738	1770	1816	
				OVERALL DIMENSIONS			SEAT DIMENSIONS			BACK DIMENSIONS					
				W	D	H	W	D	H	W	H				
			IN 18	21.5	33	-	-	-	-	-	-	-	-	-	
			MM 457	546	838	-	-	-	-	-	-	-	-	-	
			RTA 00		1 per carton										
 <p>Ottoman COM: 1.25 YD 1.14 M Unit weight: 23 LB 10.5 KG Carton weight: 28 LB 12.7 KG Carton volume: 5.75 FT³ 0.16 MT³</p>		ML2121	1454	1494	1528	1567	1630	1689	1748	1799	1863	1923	2004	2119	
				OVERALL DIMENSIONS			SEAT DIMENSIONS			BACK DIMENSIONS					
				W	D	H	W	D	H	W	H				
			IN 21	21	17	-	-	-	-	-	-	-	-	-	
			MM 533	533	432	-	-	-	-	-	-	-	-	-	
			RTA 00		1 per carton										

DESCRIPTION	FEATURES	MODEL #	STANDARD TEXTILE GRADES															
			1	2	3	4	5	6	7	8	9	10	11	12				
 <p>Dining Chair COM: 1.75 YD 1.6 M Unit weight: 26 LB 11.8 KG Carton weight: 33 LB 14.97 KG Carton volume: 14.75 FT³ 0.41 MT³</p>		ML2326	2083	2139	2186	2241	2330	2412	2494	2566	2655	2739	2853	3014				
			OVERALL DIMENSIONS			SEAT DIMENSIONS			BACK DIMENSIONS									
			W	D	H	W	D	H	W	H								
			IN 23.25	29.5	29.75	20.5	17	18	17	11.5								
			MM 591	749	756	521	432	457	432	292								
			RTA 00			1 per carton												
						1	2	3	4	5	6	7	8	9	10	11	12	
						ML2630	2328	2408	2476	2553	2681	2798	2916	3018	3146	3266	3428	3658
						OVERALL DIMENSIONS			SEAT DIMENSIONS			BACK DIMENSIONS						
						W	D	H	W	D	H	W	H					
			IN 26	34.5	35	23	20	18	18	17.5								
			MM 660	876	889	584	508	457	457	445								
			RTA 00			1 per carton												

ML PARK



model ML4634CH



model ML8634

STANDARD FEATURES

- ML Park is a modern armless lounge seating series with a distinctive retro design.
- Features aluminum legs with non-marking Black glides.
- Fully upholstered continuous seat and back cushions with distinctive seams.
- Upholstery options: fabric, vinyl or leather. Vinyl and leather models may feature stitch detail across the seat and/or back cushions, if applicable.

OPTIONAL FEATURES

- Optional fixed back cushion (FC) is available on lounge models, please specify. Model ML4634, add \$157. Model ML8634, add \$210. Model ML8634, add \$263.
- Available in five leg finish options: Black (TBL), Brushed Aluminum (BAL), Designer White (TDW), Polished Aluminum (ALU) or Tungsten (TTU), please specify. No upcharge.

DESCRIPTION	FEATURES	MODEL #	STANDARD TEXTILE GRADES												
			1	2	3	4	5	6	7	8	9	10	11	12	
		ML2634	1525	1573	1614	1660	1737	1807	1878	1939	2016	2088	2185	2323	
			OVERALL DIMENSIONS			SEAT DIMENSIONS			BACK DIMENSIONS						
			W	D	H	W	D	H	W	H					
			IN 26.75	26.75	18.25	-	-	-	-	-					
			MM 679	679	464	-	-	-	-	-					
			RTA 00		1 per carton										
		ML4634	2932	3164	3360	3585	3954	4295	4636	4933	5303	5651	6122	6789	
			OVERALL DIMENSIONS			SEAT DIMENSIONS			BACK DIMENSIONS						
			W	D	H	W	D	H	W	H					
			IN 42.75	36	32	42.75	24	20	20	12					
			MM 1086	914	813	1086	610	508	508	305					
			RTA 00	1 per carton											
		ML6634	5018	5258	5461	5693	6076	6428	6781	7088	7471	7831	8318	9008	
			OVERALL DIMENSIONS			SEAT DIMENSIONS			BACK DIMENSIONS						
			W	D	H	W	D	H	W	H					
			IN 66	36	32	66	24	20	20	12					
			MM 1676	914	813	1676	610	508	508	305					
			RTA 00	1 per carton											
		ML8634	5916	6268	6565	6906	7467	7984	8501	8952	9513	10041	10756	11768	
			OVERALL DIMENSIONS			SEAT DIMENSIONS			BACK DIMENSIONS						
			W	D	H	W	D	H	W	H					
			IN 86	36	32	86	24	20	40	12					
			MM 2184	914	813	2184	610	508	1016	305					
			RTA 00	1 per carton											

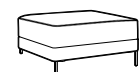

Ottoman

COM: 1.5 YD | 1.37 M
 Unit weight: 35 LB | 15.9 KG
 Carton weight: 41 LB | 18.6 KG
 Carton volume: 9.75 FT³ | 0.27 MT³



Lounge Chair

COM: 7.25 YD | 6.63 M
 Unit weight: 85 LB | 38.6 KG
 Carton weight: 95 LB | 43.09 KG
 Carton volume: 35.5 FT³ | 1 MT³

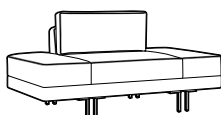

Two Seat Sofa

COM: 7.5 YD | 6.86 M
 Unit weight: 120 LB | 54.5 KG
 Carton weight: 132 LB | 59.87 KG
 Carton volume: 52 FT³ | 1.47 MT³

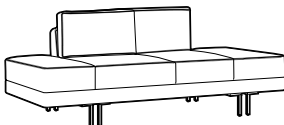

Three Seat Sofa

COM: 11 YD | 10.06 M
 Unit weight: 145 LB | 65.9 KG
 Carton weight: 160 LB | 72.57 KG
 Carton volume: 67.25 FT³ | 1.9 MT³

PRAIRIE



model 3481



model 3482

STANDARD FEATURES

- Features barrel shaped arms that provide an attractive and enticing appearance.
- Fully upholstered. Tapered wood skirt and legs.
- Fixed, non-removable cushions.
- Elasticized seat suspension system for extra comfort.
- Series includes lounge chair, two seat and three seat sofa.
- Upholstery options: fabric, vinyl or leather. Vinyl and leather models may feature stitch detail across the seat and/or back cushions, if applicable.

OPTIONAL FEATURES

- Tapered wood legs are available in Absolute (AAM), Black (BKM), Cherry (ACM), Espresso Cafe (ECM), English Oak (EOM), Fruitwood (TFM), Gray (HGM), Honey (AHM), Mahogany (TMM), Maple (AVM), Medium Walnut (MWM), Natural Walnut (NLW), Night (ASM), Noce Biondo (NBM), Noce Grigio (NGM), Noce Leggero (NEM), Noce Medio (NMM), Shaker Cherry (SKM), Walnut (TWM), WC Cream (WTM), White (WHM) and Winter Cherry (WCM). Please specify. Genuine maple faced veneers and solids are used.

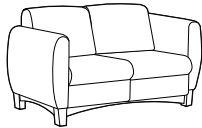
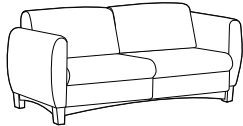
DESCRIPTION	FEATURES	MODEL #	STANDARD TEXTILE GRADES											
			1	2	3	4	5	6	7	8	9	10	11	12
 Lounge Chair COM: 4.25 YD 3.89 M Unit weight: 70 LB 31.8 KG Carton weight: 80 LB 36.29 KG Carton volume: 19.25 FT³ 0.54 MT³		3481	1502	1638	1753	1885	2101	2301	2501	2675	2892	3096	3372	3763
			OVERALL DIMENSIONS			SEAT DIMENSIONS			BACK DIMENSIONS					
			W	D	H	W	D	H	W	H				
			IN 32	29	30.5	21	19	16	21	14.5				
		MM 813	737	775	533	483	406	533	368					
		RTA 00	1 per carton											
 Two Seat Sofa COM: 6.25 YD 5.72 M Unit weight: 96 LB 43.6 KG Carton weight: 106 LB 48.08 KG Carton volume: 41.25 FT³ 1.16 MT³		3482	2050	2250	2419	2613	2931	3225	3519	3775	4094	4394	4800	5375
			OVERALL DIMENSIONS			SEAT DIMENSIONS			BACK DIMENSIONS					
			W	D	H	W	D	H	W	H				
			IN 52.5	29	30.5	42	19	16	42	14.5				
		MM 1334	737	775	1067	483	406	1067	368					
		RTA 00	1 per carton											
 Three Seat Sofa COM: 9.5 YD 8.69 M Unit weight: 135 LB 61.4 KG Carton weight: 150 LB 68.04 KG Carton volume: 55.5 FT³ 1.57 MT³		3483	2599	2903	3160	3454	3939	4385	4832	5221	5706	6162	6779	7653
			OVERALL DIMENSIONS			SEAT DIMENSIONS			BACK DIMENSIONS					
			W	D	H	W	D	H	W	H				
			IN 73.5	29	30.5	63.5	19	16	63.5	14.5				
		MM 1867	737	775	1613	483	406	1613	368					
		RTA 00	1 per carton											

RIVER



Sample Layout



Sample Layout

STANDARD FEATURES

- A seating series that is composed of modular units in straight, curved and corner sections, as well as freestanding units. Soft seating models are available with standard height, high and extended high backs. Linking units can be used together in any combination to create a wide variety of layouts.
- Armless units can be ganged together with a quick connect, disconnect feature. Ganging hardware is standard and is factory installed. Ganging hardware swivels out of sight when not in use.
- Front edge of the seat angles slightly inward, so feet have freedom of movement and don't rub on the seat. This inward slant matches the inward angles of the back. Benches and connecting end tables also reflect the inward angles on the front and back faces, so all units coordinate in visual appearance.
- The unique tapered legs are made of welded steel, with each leg bolted directly to the unit frame. All units except for the laptop tables have the same leg height of 6.5". The leg height makes it easier to clean under the product.
- Legs are standard in Chrome with Black nylon non-marking height adjustable glides.
- All cushions are fixed and non-removable. Perimeter seams feature a decorative single stitch detail, which makes seams lay flat and adds extra seam strength.
- Seating frames are heavy duty with interlocking plywood, puzzle box construction, and are made for active environments. Seats are high density with highly resilient foam.
- Personal Harbor high traffic units are rated at 350 lbs., suitable for 24/7 use and should be specified in textiles that meet or exceed 100,000 double rubs (for the fabric portion of the warranty to apply). These units have the same puzzle box frame construction as other River models except the framing wood is 1" thick, rotary cut, birch plywood.
- Upholstery options: fabric, vinyl or leather. Leather only recommended on seat and may feature a horizontal stitch detail.

OPTIONAL FEATURES

- Most tables and seating units (except round benches) can be specified with power/USB units, which include two power outlets, two double USB terminals and a Black 5' three-prong power cord. Each power/USB unit is set in predetermined locations, as shown in the electrical illustrations below. Electrical units must be factory installed.
- Power/USB units are available with either Jet Black (J) face plate with Black power/USB receptacles or with a White (W) face plate with White power/USB receptacles.
- To add a power/USB unit, please specify (J1), (W1), (J2), (W2), (J3), (W3), (J4), (W4), (J6) or (W6) after the product model number. Please note on seating units, if both right and left locations are required, add both (J1/J3) or (W1/W3) to the model number. Add \$729 each.
- Tables are made with high pressure laminate and are offered in the following finishes: Absolute Acajou (ACJ), Asian Night (ASN), Avant Cherry (AWC), Avant Honey (AWH), Blizzard (BZD), Clear Maple (CMB), Custom Grey (CGY), Dark Espresso (DES), Designer White (DWT), Stonedust (SDT), Walnut Heights (WHE), White Chocolate (WHC) and Winter Cherry (WCR). Please specify. Custom high pressure laminate finishes will be considered upon request.
- For leg finish options, please see page 379. No upcharges.
- If more than one fabric or a fabric/vinyl and leather combination is required, please fill out a "Seating Multiple Textile" form, specifying each fabric location. Please contact Customer Service for more information.

ELECTRICAL PLACEMENT

Soft Seating

Locations available on left side J1 (Black) or W1 (White), right side J3 (Black), or W3 (White) or both sides J1/J3 (Black) or W1/W3 (White).

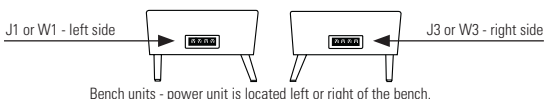
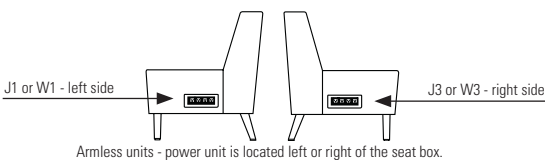
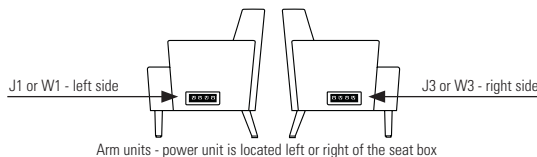
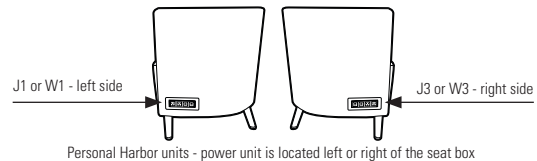



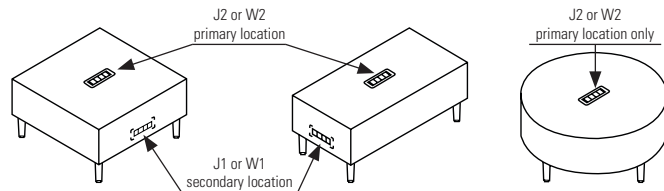

Coffee/End Tables

Primary location is on the top of the unit, centered J2 (Black) or W2 (White). Secondary Location is end/side of the unit J1 (Black) or W1 (White).

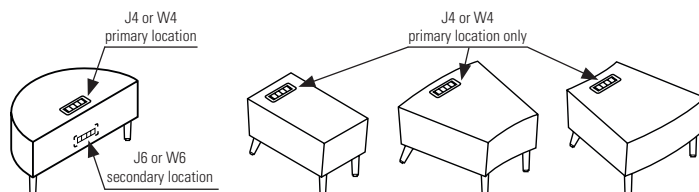

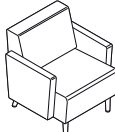
Primary location is on the top rear/edge of the unit J4 (Black) or W4 (White). Secondary Location is the back side of the unit J6 (Black) or W6 (White).

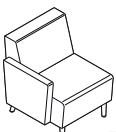

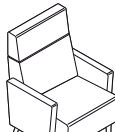
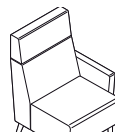
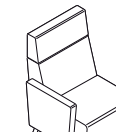

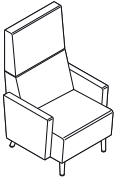
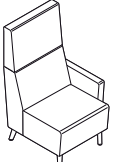
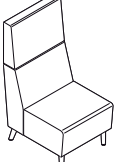
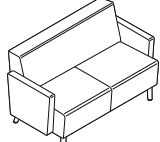
DESCRIPTION	FEATURES	MODEL#	STANDARD TEXTILE GRADES														
			1	2	3	4	5	6	7	8	9	10	11	12			
 <p>Lounge Chair - Standard Back w/Arms COM: 4 YD 3.66 M Unit weight: 46 LB 20.9 KG Carton weight: 57 LB 25.85 KG Carton volume: 22.5 FT³ 0.63 MT³</p>	<p>For power/USB unit please see electrical placement chart. Freestanding unit only.</p>	7701	1920	2048	2156	2280	2484	2672	2860	3024	3228	3420	3680	4048			
			OVERALL DIMENSIONS			SEAT DIMENSIONS			BACK DIMENSIONS								
			W	D	H	W	D	H	W	H							
			IN 29.5 MM 749	29.5 749	32 813	24 610	19 483	18 457	24 610	14 356							
			<div style="border: 1px solid black; padding: 2px; display: inline-block;">RTA 00</div> 1 per carton														
  <p>7701L (Left arm) 7701R (Right arm)</p> <p>Lounge Chair - Standard w/One Arm COM: 3.25 YD 2.97 M Unit weight: 36 LB 16.4 KG Carton weight: 47 LB 21.32 KG Carton volume: 22.5 FT³ 0.63 MT³</p>	<p>For power/USB unit please see electrical placement chart. Includes ganging hardware (1 side).</p>	7701L 7701R	1676	1780	1868	1969	2134	2287	2440	2573	2739	2895	3106	3405			
			OVERALL DIMENSIONS			SEAT DIMENSIONS			BACK DIMENSIONS								
			W	D	H	W	D	H	W	H							
			IN 27 MM 686	29.5 749	32 813	24 610	19 483	18 457	24 610	14 356							
			<div style="border: 1px solid black; padding: 2px; display: inline-block;">RTA 00</div> 1 per carton														
 <p>Armless Lounge Chair - Standard Back COM: 2.5 YD 2.29 M Unit weight: 26 LB 11.8 KG Carton weight: 37 LB 16.78 KG Carton volume: 22.5 FT³ 0.63 MT³</p>	<p>For power/USB unit please see electrical placement chart. Includes ganging hardware (2 sides).</p>	7701NA	1432	1512	1580	1657	1785	1902	2020	2122	2250	2370	2532	2762			
			OVERALL DIMENSIONS			SEAT DIMENSIONS			BACK DIMENSIONS								
			W	D	H	W	D	H	W	H							
			IN 24.5 MM 622	29.5 749	32 813	24 610	19 483	18 457	24 610	14 356							
			<div style="border: 1px solid black; padding: 2px; display: inline-block;">RTA 00</div> 1 per carton														
 <p>Lounge Chair - High Back w/Arms COM: 4.5 YD 4.11 M Unit weight: 48 LB 21.8 KG Carton weight: 61 LB 27.67 KG Carton volume: 28.25 FT³ 0.79 MT³</p>	<p>For power/USB unit please see electrical placement chart. Freestanding unit only.</p>	7702	2154	2298	2420	2559	2789	3000	3212	3396	3626	3842	4134	4548			
			OVERALL DIMENSIONS			SEAT DIMENSIONS			BACK DIMENSIONS								
			W	D	H	W	D	H	W	H							
			IN 29.5 MM 749	29.5 749	41.5 1054	24 610	19 483	18 457	24 610	24 610							
			<div style="border: 1px solid black; padding: 2px; display: inline-block;">RTA 00</div> 1 per carton														
  <p>7702L (Left arm) 7702R (Right arm)</p> <p>Lounge Chair - High Back w/One Arm COM: 3.75 YD 3.43 M Unit weight: 38 LB 17.3 KG Carton weight: 51 LB 23.13 KG Carton volume: 28.25 FT³ 0.79 MT³</p>	<p>For power/USB unit please see electrical placement chart. Includes ganging hardware (1 side).</p>	7702L 7702R	1913	2033	2134	2251	2442	2618	2794	2948	3139	3319	3563	3908			
			OVERALL DIMENSIONS			SEAT DIMENSIONS			BACK DIMENSIONS								
			W	D	H	W	D	H	W	H							
			IN 27 MM 686	29.5 749	41.5 1054	24 610	19 483	18 457	24 610	24 610							
			<div style="border: 1px solid black; padding: 2px; display: inline-block;">RTA 00</div> 1 per carton														

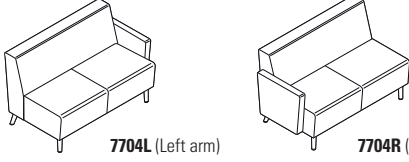
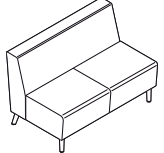
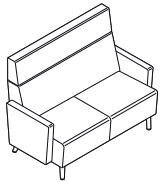
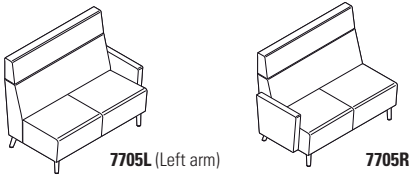
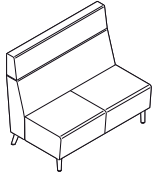

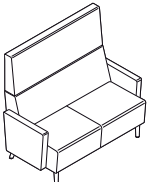
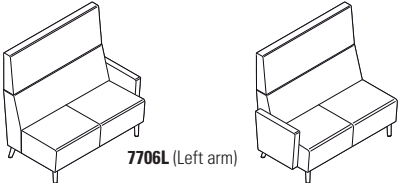
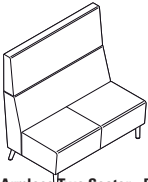
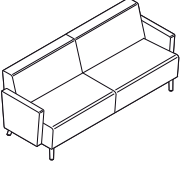
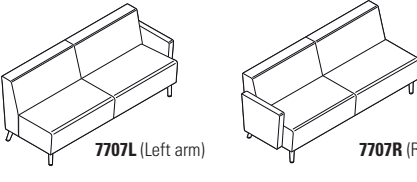
DESCRIPTION	FEATURES	MODEL#	STANDARD TEXTILE GRADES											
			1	2	3	4	5	6	7	8	9	10	11	12
 <p>Armless Lounge Chair - High Back COM: 3 YD 2.74 M Unit weight: 28 LB 12.7 KG Carton weight: 41 LB 18.6 KG Carton volume: 28.25 FT³ 0.79 MT³</p>	<p>For power/USB unit please see electrical placement chart. Includes ganging hardware (2 sides).</p>	7702NA	1669	1765	1846	1939	2092	2233	2374	2497	2650	2794	2989	3265
			OVERALL DIMENSIONS			SEAT DIMENSIONS			BACK DIMENSIONS					
			W	D	H	W	D	H	W	H				
			IN 24.5 MM 622	29.5 749	41.5 1054	24 610	19 483	18 457	24 610	24 610				
			RTA 00		1 per carton									
 <p>Lounge Chair - Extended Back w/Arms COM: 4.75 YD 4.34 M Unit weight: 51 LB 23.2 KG Carton weight: 68 LB 30.84 KG Carton volume: 32.75 FT³ 0.92 MT³</p>	<p>For power/USB unit please see electrical placement chart. Freestanding unit only.</p>	7703	2247	2399	2527	2675	2917	3140	3363	3558	3800	4028	4337	4774
			OVERALL DIMENSIONS			SEAT DIMENSIONS			BACK DIMENSIONS					
			W	D	H	W	D	H	W	H				
			IN 29.5 MM 749	29.5 749	47 1194	24 610	19 483	18 457	24 610	29 737				
			RTA 00		1 per carton									
 <p>Lounge Chair-Extended Back w/One Arm COM: 4 YD 3.66 M Unit weight: 41 LB 18.6 KG Carton weight: 58 LB 26.31 KG Carton volume: 32.75 FT³ 0.92 MT³</p>	<p>For power/USB unit please see electrical placement chart. Includes ganging hardware (1 side).</p>	7703L 7703R	2004	2132	2240	2364	2568	2756	2944	3108	3312	3504	3764	4132
			OVERALL DIMENSIONS			SEAT DIMENSIONS			BACK DIMENSIONS					
			W	D	H	W	D	H	W	H				
			IN 27 MM 686	29.5 749	47 1194	24 610	19 483	18 457	24 610	29 737				
			RTA 00		1 per carton									
 <p>Armless Lounge Chair - Extended Back COM: 3.25 YD 2.97 M Unit weight: 31 LB 14.1 KG Carton weight: 48 LB 21.77 KG Carton volume: 32.75 FT³ 0.92 MT³</p>	<p>For power/USB unit please see electrical placement chart. Includes ganging hardware (2 sides).</p>	7703NA	1761	1865	1953	2054	2219	2372	2525	2658	2824	2980	3191	3490
			OVERALL DIMENSIONS			SEAT DIMENSIONS			BACK DIMENSIONS					
			W	D	H	W	D	H	W	H				
			IN 24.5 MM 622	29.5 749	47 1194	24 610	19 483	18 457	24 610	29 737				
			RTA 00		1 per carton									
 <p>Two Seater - Standard Back w/Arms COM: 5.5 YD 5.03 M Unit weight: 73 LB 33.2 KG Carton weight: 95 LB 43.09 KG Carton volume: 39 FT³ 1.1 MT³</p>	<p>For power/USB unit please see electrical placement chart. Freestanding unit only.</p>	7704	2702	2878	3027	3197	3478	3736	3995	4220	4501	4765	5122	5628
			OVERALL DIMENSIONS			SEAT DIMENSIONS			BACK DIMENSIONS					
			W	D	H	W	D	H	W	H				
			IN 53.5 MM 1359	29.5 749	32 813	48 1219	19 483	18 457	48 1219	14 356				
			RTA 00		1 per carton									

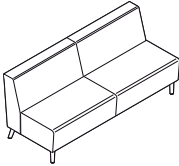
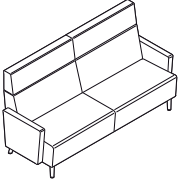
DESCRIPTION	FEATURES	MODEL#	STANDARD TEXTILE GRADES											
			1	2	3	4	5	6	7	8	9	10	11	12
 <p>7704L (Left arm) 7704R (Right arm)</p> <p>Two Seater - Standard Back w/One Arm COM: 4.75 YD 4.34 M Unit weight: 63 LB 28.6 KG Carton weight: 85 LB 38.56 KG Carton volume: 39 FT³ 1.1 MT³</p>	<p>For power/USB unit please see electrical placement chart. Includes ganging hardware (1 side).</p>	<p>7704L 7704R</p>	1	2	3	4	5	6	7	8	9	10	11	12
			2460	2612	2740	2888	3130	3353	3576	3771	4013	4241	4550	4987
			OVERALL DIMENSIONS			SEAT DIMENSIONS			BACK DIMENSIONS					
			W	D	H	W	D	H	W	H				
			IN 51	29.5	32	48	19	18	48	14				
			MM 1295	749	813	1219	483	457	1219	356				
			RTA 00	1 per carton										
 <p>7704NA</p> <p>Armless Two Seater - Standard Back COM: 4.25 YD 3.89 M Unit weight: 53 LB 24.1 KG Carton weight: 75 LB 34.02 KG Carton volume: 39 FT³ 1.1 MT³</p>	<p>For power/USB unit please see electrical placement chart. Includes ganging hardware (2 sides).</p>	<p>7704NA</p>	1	2	3	4	5	6	7	8	9	10	11	12
			2217	2353	2468	2600	2816	3016	3216	3390	3607	3811	4087	4478
			OVERALL DIMENSIONS			SEAT DIMENSIONS			BACK DIMENSIONS					
			W	D	H	W	D	H	W	H				
			IN 48.5	29.5	32	48	19	18	48	14				
			MM 1232	749	813	1219	483	457	1219	356				
			RTA 00	1 per carton										
 <p>7705</p> <p>Two Seater - High Back w/Arms COM: 6.5 YD 5.94 M Unit weight: 77 LB 35 KG Carton weight: 101 LB 45.81 KG Carton volume: 49 FT³ 1.38 MT³</p>	<p>For power/USB unit please see electrical placement chart. Freestanding unit only.</p>	<p>7705</p>	1	2	3	4	5	6	7	8	9	10	11	12
			3172	3380	3556	3757	4089	4394	4700	4966	5298	5610	6032	6630
			OVERALL DIMENSIONS			SEAT DIMENSIONS			BACK DIMENSIONS					
			W	D	H	W	D	H	W	H				
			IN 53.5	29.5	41.5	48	19	18	48	24				
			MM 1359	749	1054	1219	483	457	1219	610				
			RTA 00	1 per carton										
 <p>7705L (Left arm) 7705R (Right arm)</p> <p>Two Seater - High Back w/One Arm COM: 5.75 YD 5.26 M Unit weight: 67 LB 30.5 KG Carton weight: 91 LB 41.28 KG Carton volume: 49 FT³ 1.38 MT³</p>	<p>For power/USB unit please see electrical placement chart. Includes ganging hardware (1 side).</p>	<p>7705L 7705R</p>	1	2	3	4	5	6	7	8	9	10	11	12
			2929	3113	3268	3447	3740	4010	4280	4516	4809	5085	5459	5988
			OVERALL DIMENSIONS			SEAT DIMENSIONS			BACK DIMENSIONS					
			W	D	H	W	D	H	W	H				
			IN 51	29.5	41.5	48	19	18	48	24				
			MM 1295	749	1054	1219	483	457	1219	610				
			RTA 00	1 per carton										
 <p>7705NA</p> <p>Armless Two Seater - High Back COM: 5.25 YD 4.8 M Unit weight: 57 LB 25.9 KG Carton weight: 81 LB 36.74 KG Carton volume: 49 FT³ 1.38 MT³</p>	<p>For power/USB unit please see electrical placement chart. Includes ganging hardware (2 sides).</p>	<p>7705NA</p>	1	2	3	4	5	6	7	8	9	10	11	12
			2687	2855	2997	3160	3427	3674	3921	4136	4404	4656	4997	5480
			OVERALL DIMENSIONS			SEAT DIMENSIONS			BACK DIMENSIONS					
			W	D	H	W	D	H	W	H				
			IN 48.5	29.5	41.5	48	19	18	48	24				
			MM 1232	749	1054	1219	483	457	1219	610				
			RTA 00	1 per carton										

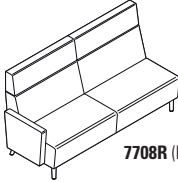
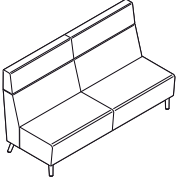
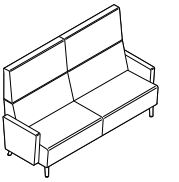
DESCRIPTION	FEATURES	MODEL#	STANDARD TEXTILE GRADES											
			1	2	3	4	5	6	7	8	9	10	11	12
 <p>Two Seater - Extended Back w/Arms COM: 7 YD 6.4 M Unit weight: 81 LB 36.8 KG Carton weight: 107 LB 48.53 KG Carton volume: 56.75 FT³ 1.6 MT³</p>	For power/USB unit please see electrical placement chart. Freestanding unit only.	7706	3358	3582	3771	3988	4345	4674	5003	5290	5647	5983	6438	7082
			OVERALL DIMENSIONS			SEAT DIMENSIONS			BACK DIMENSIONS					
			W	D	H	W	D	H	W	H				
			IN 53.5 MM 1359	29.5 749	47 1194	48 1219	19 483	18 457	48 1219	29 737				
			RTA 00		1 per carton									
 <p>Two Seater - Extended Back w/One Arm COM: 6.25 YD 5.72 M Unit weight: 71 LB 32.3 KG Carton weight: 97 LB 44 KG Carton volume: 56.75 FT³ 1.6 MT³</p>	For power/USB unit please see electrical placement chart. Includes ganging hardware (1 side).	7706L 7706R	3115	3315	3484	3678	3996	4290	4584	4840	5159	5459	5865	6440
			OVERALL DIMENSIONS			SEAT DIMENSIONS			BACK DIMENSIONS					
			W	D	H	W	D	H	W	H				
			IN 51 MM 1295	29.5 749	47 1194	48 1219	19 483	18 457	48 1219	29 737				
			RTA 00		1 per carton									
 <p>Armless Two Seater - Extended Back COM: 5.75 YD 5.26 M Unit weight: 61 LB 27.7 KG Carton weight: 87 LB 39.46 KG Carton volume: 56.75 FT³ 1.6 MT³</p>	For power/USB unit please see electrical placement chart. Includes ganging hardware (2 sides).	7706NA	2871	3055	3210	3389	3682	3952	4222	4458	4751	5027	5401	5930
			OVERALL DIMENSIONS			SEAT DIMENSIONS			BACK DIMENSIONS					
			W	D	H	W	D	H	W	H				
			IN 48.5 MM 1232	29.5 749	47 1194	48 1219	19 483	18 457	48 1219	29 737				
			RTA 00		1 per carton									
 <p>Three Seater - Standard Back w/Arms COM: 8.25 YD 7.54 M Unit weight: 108 LB 49.1 KG Carton weight: 139 LB 63.05 KG Carton volume: 55.5 FT³ 1.57 MT³</p>	For power/USB unit please see electrical placement chart. Freestanding unit only.	7707	4268	4532	4755	5011	5431	5819	6207	6545	6966	7362	7898	8657
			OVERALL DIMENSIONS			SEAT DIMENSIONS			BACK DIMENSIONS					
			W	D	H	W	D	H	W	H				
			IN 77.5 MM 1969	29.5 749	32 813	72 1829	19 483	18 457	72 1829	14 356				
			RTA 00		1 per carton									
 <p>Three Seater - Standard Back w/One Arm COM: 7.75 YD 7.09 M Unit weight: 98 LB 44.5 KG Carton weight: 129 LB 58.51 KG Carton volume: 55.5 FT³ 1.57 MT³</p>	For power/USB unit please see electrical placement chart. Includes ganging hardware (1 side).	7707L 7707R	4025	4273	4482	4723	5118	5482	5846	6164	6559	6931	7435	8148
			OVERALL DIMENSIONS			SEAT DIMENSIONS			BACK DIMENSIONS					
			W	D	H	W	D	H	W	H				
			IN 75 MM 1905	29.5 749	32 813	72 1829	19 483	18 457	72 1829	14 356				
			RTA 00		1 per carton									

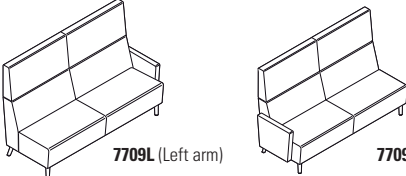
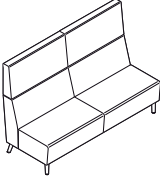
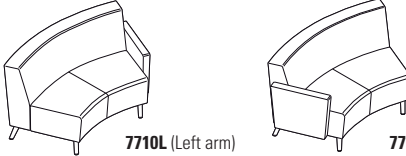
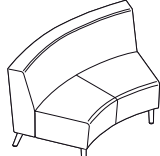
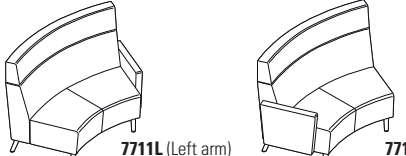
DESCRIPTION	FEATURES	MODEL#	STANDARD TEXTILE GRADES														
			1	2	3	4	5	6	7	8	9	10	11	12			
 <p>Armless Three Seater - Standard Back COM: 7 YD 6.4 M Unit weight: 88 LB 40 KG Carton weight: 119 LB 53.98 KG Carton volume: 55.5 FT³ 1.57 MT³</p>	For power/USB unit please see electrical placement chart. Includes ganging hardware (2 sides).	7707NA	3783	4007	4196	4413	4770	5099	5428	5715	6072	6408	6863	7507			
			OVERALL DIMENSIONS			SEAT DIMENSIONS			BACK DIMENSIONS								
			W	D	H	W	D	H	W	H							
			IN 72.5	29.5	32	72	19	18	72	14							
MM 1842	749	813	1829	483	457	1829	356										
		RTA 00		1 per carton													
 <p>Three Seater - High Back w/Arms COM: 10.5 YD 9.6 M Unit weight: 112 LB 50.9 KG Carton weight: 148 LB 67.13 KG Carton volume: 69.75 FT³ 1.97 MT³</p>	For power/USB unit please see electrical placement chart. Freestanding unit only.	7708	4973	5309	5593	5918	6454	6947	7441	7871	8407	8911	9593	10559			
			OVERALL DIMENSIONS			SEAT DIMENSIONS			BACK DIMENSIONS								
			W	D	H	W	D	H	W	H							
			IN 77.5	29.5	41.5	72	19	18	72	24							
MM 1969	749	1054	1829	483	457	1829	610										
		RTA 00		1 per carton													
 <p>7708L (Left arm)</p>  <p>7708R (Right arm)</p> <p>Three Seater - High Back w/One Arm COM: 9.75 YD 8.92 M Unit weight: 102 LB 46.4 KG Carton weight: 139 LB 63.05 KG Carton volume: 69.75 FT³ 1.97 MT³</p>	For power/USB unit please see electrical placement chart. Includes ganging hardware (1 side).	7708L 7708R	4731	5043	5306	5609	6106	6564	7022	7422	7919	8387	9021	9918			
			OVERALL DIMENSIONS			SEAT DIMENSIONS			BACK DIMENSIONS								
			W	D	H	W	D	H	W	H							
			IN 75	29.5	41.5	72	19	18	72	24							
MM 1905	749	1054	1829	483	457	1829	610										
		RTA 00		1 per carton													
 <p>Armless Three Seater - High Back COM: 9.25 YD 8.46 M Unit weight: 92 LB 41.8 KG Carton weight: 126 LB 57.15 KG Carton volume: 69.75 FT³ 1.97 MT³</p>	For power/USB unit please see electrical placement chart. Includes ganging hardware (2 sides).	7708NA	4486	4782	5032	5319	5790	6225	6660	7039	7511	7955	8556	9407			
			OVERALL DIMENSIONS			SEAT DIMENSIONS			BACK DIMENSIONS								
			W	D	H	W	D	H	W	H							
			IN 72.5	29.5	41.5	72	19	18	72	24							
MM 1842	749	1054	1829	483	457	1829	610										
		RTA 00		1 per carton													
 <p>Three Seater - Extended Back w/Arms COM: 11 YD 10.06 M Unit weight: 116 LB 52.7 KG Carton weight: 144 LB 65.32 KG Carton volume: 78.75 FT³ 2.22 MT³</p>	For power/USB unit please see electrical placement chart. Freestanding unit only.	7709	5250	5602	5899	6240	6801	7318	7835	8286	8847	9375	10090	11102			
			OVERALL DIMENSIONS			SEAT DIMENSIONS			BACK DIMENSIONS								
			W	D	H	W	D	H	W	H							
			IN 77.5	29.5	47	72	19	18	72	29							
MM 1969	749	1194	1829	483	457	1829	737										
		RTA 00		1 per carton													

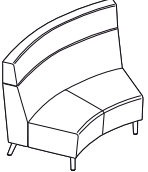
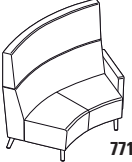
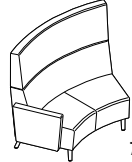
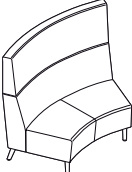
DESCRIPTION	FEATURES	MODEL#	STANDARD TEXTILE GRADES											
			1	2	3	4	5	6	7	8	9	10	11	12
 <p>7709L (Left arm) 7709R (Right arm)</p> <p>Three Seater - Extended Back w/One Arm COM: 10.5 YD 9.6 M Unit weight: 106 LB 48.2 KG Carton weight: 134 LB 60.78 KG Carton volume: 78.75 FT³ 2.22 MT³</p>	<p>For power/USB unit please see electrical placement chart. Includes ganging hardware (1 side).</p>	<p>7709L 7709R</p>	5007	5343	5627	5952	6488	6981	7475	7905	8441	8945	9627	10593
			<p>OVERALL DIMENSIONS W D H</p>			<p>SEAT DIMENSIONS W D H</p>			<p>BACK DIMENSIONS W H</p>					
			IN 75	29.5	47	72	19	18	72	29				
			MM 1905	749	1194	1829	483	457	1829	737				
			RTA 00	1 per carton										
 <p>7709NA</p> <p>Armless Three Seater - Extended Back COM: 9.75 YD 8.92 M Unit weight: 96 LB 43.6 KG Carton weight: 124 LB 56.25 KG Carton volume: 78.75 FT³ 2.22 MT³</p>	<p>For power/USB unit please see electrical placement chart. Includes ganging hardware (2 sides).</p>	<p>7709NA</p>	4764	5076	5339	5642	6139	6597	7055	7455	7952	8420	9054	9951
			<p>OVERALL DIMENSIONS W D H</p>			<p>SEAT DIMENSIONS W D H</p>			<p>BACK DIMENSIONS W H</p>					
			IN 72.5	29.5	47	72	19	18	72	29				
			MM 1842	749	1194	1829	483	457	1829	737				
			RTA 00	1 per carton										
 <p>7710L (Left arm) 7710R (Right arm)</p> <p>IS Curve - Two Seater - Standard Back w/One Arm COM: 5.25 YD 4.8 M Unit weight: 68 LB 30.9 KG Carton weight: 88 LB 39.92 KG Carton volume: 43 FT³ 1.21 MT³</p>	<p>For power/USB unit please see electrical placement chart. Includes ganging hardware (2 sides).</p>	<p>7710L 7710R</p>	2886	3054	3196	3359	3626	3873	4120	4335	4603	4855	5196	5679
			<p>OVERALL DIMENSIONS W D H</p>			<p>SEAT DIMENSIONS W D H</p>			<p>BACK DIMENSIONS W H</p>					
			IN 57	29.5	32	42	19	18	51	14				
			MM 1448	749	813	1067	483	457	1295	356				
			RTA 00	1 per carton										
 <p>7710NA</p> <p>Armless IS Curve - Two Seat - Standard Back COM: 4.5 YD 4.11 M Unit weight: 58 LB 26.4 KG Carton weight: 78 LB 35.38 KG Carton volume: 43 FT³ 1.21 MT³</p>	<p>For power/USB unit please see electrical placement chart. Includes ganging hardware (2 sides).</p>	<p>7710NA</p>	2643	2787	2909	3048	3278	3489	3701	3885	4115	4331	4623	5037
			<p>OVERALL DIMENSIONS W D H</p>			<p>SEAT DIMENSIONS W D H</p>			<p>BACK DIMENSIONS W H</p>					
			IN 55	29.5	32	42	19	18	51	14				
			MM 1397	749	813	1067	483	457	1295	356				
			RTA 00	1 per carton										
 <p>7711L (Left arm) 7711R (Right arm)</p> <p>IS Curve - Two Seater - High Back w/One Arm COM: 6.5 YD 5.94 M Unit weight: 72 LB 32.7 KG Carton weight: 94 LB 42.64 KG Carton volume: 54 FT³ 1.52 MT³</p>	<p>For power/USB unit please see electrical placement chart. Includes ganging hardware (2 sides).</p>	<p>7711L 7711R</p>	3428	3636	3812	4013	4345	4650	4956	5222	5554	5866	6288	6886
			<p>OVERALL DIMENSIONS W D H</p>			<p>SEAT DIMENSIONS W D H</p>			<p>BACK DIMENSIONS W H</p>					
			IN 57	29.5	41.5	42	19	18	51	24				
			MM 1448	749	1054	1067	483	457	1295	610				
			RTA 00	1 per carton										

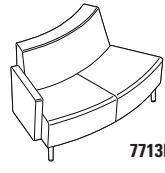
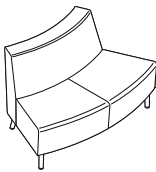
DESCRIPTION	FEATURES	MODEL#	STANDARD TEXTILE GRADES											
			1	2	3	4	5	6	7	8	9	10	11	12
 <p>Armless IS Curve - Two Seater - High Back COM: 6 YD 5.49 M Unit weight: 62 LB 28.2 KG Carton weight: 84 LB 38.1 KG Carton volume: 54 FT³ 1.52 MT³</p>	<p>For power/USB unit please see electrical placement chart. Includes ganging hardware (2 sides).</p>	<p>7711NA</p>	3185	3377	3539	3725	4031	4313	4595	4841	5147	5435	5825	6377
			<p>OVERALL DIMENSIONS</p>			<p>SEAT DIMENSIONS</p>			<p>BACK DIMENSIONS</p>					
			W	D	H	W	D	H	W		H			
			IN 55 MM 1397	29.5 749	41.5 1054	42 1067	19 483	18 457	51 1295		24 610			
			<p>RTA 00 1 per carton</p>											
 <p>7712L (Left arm)</p>  <p>7712R (Right arm)</p>	<p>For power/USB unit please see electrical placement chart. Includes ganging hardware (2 sides).</p>	<p>7712L 7712R</p>	3741	3965	4154	4371	4728	5057	5386	5673	6030	6366	6821	7465
			<p>OVERALL DIMENSIONS</p>			<p>SEAT DIMENSIONS</p>			<p>BACK DIMENSIONS</p>					
			W	D	H	W	D	H	W		H			
			IN 57 MM 1448	29.5 749	47 1194	42 1067	19 483	18 457	51 1295		29 737			
			<p>RTA 00 1 per carton</p>											
 <p>Armless IS Curve - Two Seater - Extended Back COM: 6.75 YD 6.17 M Unit weight: 66 LB 30 KG Carton weight: 89 LB 40.37 KG Carton volume: 62.75 FT³ 1.77 MT³</p>	<p>For power/USB unit please see electrical placement chart. Includes ganging hardware (2 sides).</p>	<p>7712NA</p>	3498	3714	3896	4106	4450	4767	5084	5361	5705	6029	6468	7089
			<p>OVERALL DIMENSIONS</p>			<p>SEAT DIMENSIONS</p>			<p>BACK DIMENSIONS</p>					
			W	D	H	W	D	H	W		H			
			IN 55 MM 1397	29.5 749	47 1194	42 1067	19 483	18 457	51 1295		29 737			
			<p>RTA 00 1 per carton</p>											
 <p>7713L (Left arm)</p>  <p>7713R (Right arm)</p>	<p>For power/USB unit please see electrical placement chart. Includes ganging hardware (1 side).</p>	<p>7713L 7713R</p>	2943	3111	3253	3416	3683	3930	4177	4392	4660	4912	5253	5736
			<p>OVERALL DIMENSIONS</p>			<p>SEAT DIMENSIONS</p>			<p>BACK DIMENSIONS</p>					
			W	D	H	W	D	H	W		H			
			IN 54.5 MM 1384	29.5 749	32 813	48 1219	19 483	18 457	36 914		14 356			
			<p>RTA 00 1 per carton</p>											
 <p>Armless OS Curve - Two Seater - Standard Back COM: 4.5 YD 4.11 M Unit weight: 52 LB 23.6 KG Carton weight: 72 LB 32.66 KG Carton volume: 43 FT³ 1.21 MT³</p>	<p>For power/USB unit please see electrical placement chart. Includes ganging hardware (2 sides).</p>	<p>7713NA</p>	2699	2843	2965	3104	3334	3545	3757	3941	4171	4387	4679	5093
			<p>OVERALL DIMENSIONS</p>			<p>SEAT DIMENSIONS</p>			<p>BACK DIMENSIONS</p>					
			W	D	H	W	D	H	W		H			
			IN 54 MM 1372	29.5 749	32 813	48 1219	19 483	18 457	36 914		14 356			
			<p>RTA 00 1 per carton</p>											

DESCRIPTION FEATURES MODEL# STANDARD TEXTILE GRADES

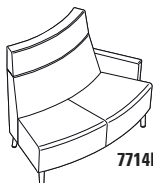

7714L (Left arm)

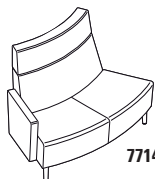

7714R (Right arm)

OS Curve - Two Seater - High Back w/One Arm
 COM: 6.5 YD | 5.94 M
 Unit weight: 66 LB | 30 KG
 Carton weight: 88 LB | 39.92 KG
 Carton volume: 54 FT³ | 1.52 MT³

For power/USB unit please see electrical placement chart. Includes ganging hardware (1 side).

MODEL#	1	2	3	4	5	6	7	8	9	10	11	12
7714L 7714R	3486	3694	3870	4071	4403	4708	5014	5280	5612	5924	6346	6944

OVERALL DIMENSIONS			SEAT DIMENSIONS			BACK DIMENSIONS	
W	D	H	W	D	H	W	H
IN 54.5	29.5	41.5	48	19	18	36	24
MM 1384	749	1054	1219	483	457	914	610

RTA 00 1 per carton

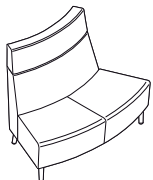

Armless OS Curve - Two Seater - High Back
 COM: 6 YD | 5.49 M
 Unit weight: 56 LB | 25.5 KG
 Carton weight: 78 LB | 35.38 KG
 Carton volume: 54 FT³ | 1.52 MT³

For power/USB unit please see electrical placement chart. Includes ganging hardware (2 sides).

MODEL#	1	2	3	4	5	6	7	8	9	10	11	12
7714NA	3242	3434	3596	3782	4088	4370	4652	4898	5204	5492	5882	6434

OVERALL DIMENSIONS			SEAT DIMENSIONS			BACK DIMENSIONS	
W	D	H	W	D	H	W	H
IN 54	29.5	41.5	48	19	18	36	24
MM 1372	749	1054	1219	483	457	914	610

RTA 00 1 per carton

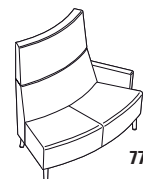

7715L (Left arm)

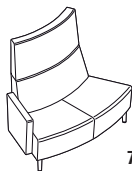

7715R (Right arm)

OS Curve - Two Seater - Extended Back w/One Arm
 COM: 7 YD | 6.4 M
 Unit weight: 70 LB | 31.8 KG
 Carton weight: 93 LB | 42.18 KG
 Carton volume: 62.75 FT³ | 1.77 MT³

For power/USB unit please see electrical placement chart. Includes ganging hardware (1 side).

MODEL#	1	2	3	4	5	6	7	8	9	10	11	12
7715L 7715R	3797	4021	4210	4427	4784	5113	5442	5729	6086	6422	6877	7521

OVERALL DIMENSIONS			SEAT DIMENSIONS			BACK DIMENSIONS	
W	D	H	W	D	H	W	H
IN 54.5	29.5	47	48	19	18	36	29
MM 1384	749	1194	1219	483	457	914	737

RTA 00 1 per carton

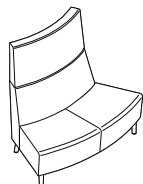

Armless OS Curve - Two Seater - Ext. High Back
 COM: 6.75 YD | 6.17 M
 Unit weight: 60 LB | 27.3 KG
 Carton weight: 83 LB | 37.65 KG
 Carton volume: 62.75 FT³ | 1.77 MT³

For power/USB unit please see electrical placement chart. Includes ganging hardware (2 sides).

MODEL#	1	2	3	4	5	6	7	8	9	10	11	12
7715NA	3553	3769	3951	4161	4505	4822	5139	5416	5760	6084	6523	7144

OVERALL DIMENSIONS			SEAT DIMENSIONS			BACK DIMENSIONS	
W	D	H	W	D	H	W	H
IN 54	29.5	47	48	19	18	36	29
MM 1372	749	1194	1219	483	457	914	737

RTA 00 1 per carton

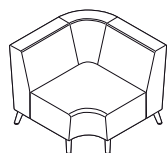

Armless Corner Unit - Standard Back
 COM: 5.5 YD | 5.03 M
 Unit weight: 55 LB | 25 KG
 Carton weight: 75 LB | 34.02 KG
 Carton volume: 49 FT³ | 1.38 MT³

For power/USB unit please see electrical placement chart. Includes ganging hardware (2 sides).

MODEL#	1	2	3	4	5	6	7	8	9	10	11	12
7716	3676	3852	4001	4171	4452	4710	4969	5194	5475	5739	6096	6602

OVERALL DIMENSIONS			SEAT DIMENSIONS			BACK DIMENSIONS	
W	D	H	W	D	H	W	H
IN 38	38	32	24	19	18	24	14
MM 965	965	813	610	483	457	610	356

RTA 00 1 per carton

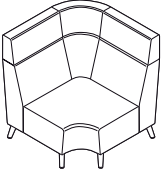
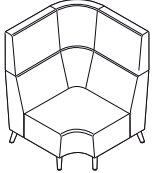
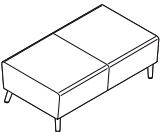
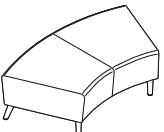
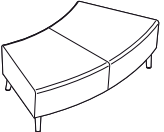
DESCRIPTION	FEATURES	MODEL#	STANDARD TEXTILE GRADES													
			1	2	3	4	5	6	7	8	9	10	11	12		
 <p>Armless Corner Unit - High Back COM: 7.75 YD 7.09 M Unit weight: 60 LB 27.3 KG Carton weight: 82 LB 37.19 KG Carton volume: 49 FT³ 1.38 MT³</p>	For power/USB unit please see electrical placement chart. Includes ganging hardware (2 sides).	7717	4666	4914	5123	5364	5759	6123	6487	6805	7200	7572	8076	8789		
			OVERALL DIMENSIONS			SEAT DIMENSIONS			BACK DIMENSIONS							
			W	D	H	W	D	H	W	H						
			IN 38	38	41.5	24	19	18	24	24						
			MM 965	965	1054	610	483	457	610	610						
RTA 00	1 per carton															
 <p>Armless Corner Unit - Extended Back COM: 8.5 YD 7.77 M Unit weight: 65 LB 29.5 KG Carton weight: 88 LB 39.92 KG Carton volume: 49 FT³ 1.38 MT³</p>	For power/USB unit please see electrical placement chart. Includes ganging hardware (2 sides).	7718	5181	5453	5683	5946	6380	6779	7179	7527	7961	8369	8921	9703		
			OVERALL DIMENSIONS			SEAT DIMENSIONS			BACK DIMENSIONS							
			W	D	H	W	D	H	W	H						
			IN 38	38	47	24	19	18	24	29						
			MM 965	965	1194	610	483	457	610	737						
RTA 00	1 per carton															
 <p>Two Seater Bench COM: 2.25 YD 2.06 M Unit weight: 31 LB 14.1 KG Carton weight: 41 LB 18.6 KG Carton volume: 21.25 FT³ 0.6 MT³</p>	For power/USB unit please see electrical placement chart. Includes ganging hardware (2 sides).	7725	1796	1868	1929	1999	2113	2219	2325	2417	2532	2640	2786	2993		
			OVERALL DIMENSIONS			SEAT DIMENSIONS			BACK DIMENSIONS							
			W	D	H	W	D	H	W	H						
			IN 48.5	28	17.5	-	-	-	-	-						
			MM 1232	711	445	-	-	-	-	-						
RTA 00	1 per carton															
 <p>IS Curve - Two Seater Bench COM: 3 YD 2.74 M Unit weight: 31 LB 14.1 KG Carton weight: 41 LB 18.6 KG Carton volume: 21.25 FT³ 0.6 MT³</p>	For power/USB unit please see electrical placement chart. Includes ganging hardware (2 sides).	7726	2609	2705	2786	2879	3032	3173	3314	3437	3590	3734	3929	4205		
			OVERALL DIMENSIONS			SEAT DIMENSIONS			BACK DIMENSIONS							
			W	D	H	W	D	H	W	H						
			IN 54	28	17.5	-	-	-	-	-						
			MM 1372	711	445	-	-	-	-	-						
RTA 00	1 per carton															
 <p>OS Curve - Two Seater Bench COM: 3 YD 2.74 M Unit weight: 31 LB 14.1 KG Carton weight: 41 LB 18.6 KG Carton volume: 21.25 FT³ 0.6 MT³</p>	For power/USB unit please see electrical placement chart. Includes ganging hardware (2 sides).	7727	2597	2693	2774	2867	3020	3161	3302	3425	3578	3722	3917	4193		
			OVERALL DIMENSIONS			SEAT DIMENSIONS			BACK DIMENSIONS							
			W	D	H	W	D	H	W	H						
			IN 54	28	17.5	-	-	-	-	-						
			MM 1372	711	445	-	-	-	-	-						
RTA 00	1 per carton															

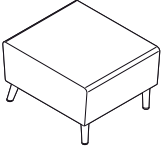
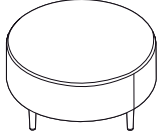
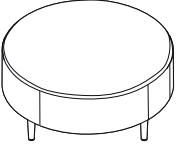
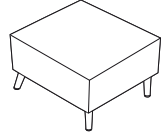
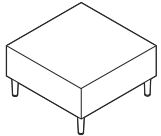
DESCRIPTION	FEATURES	MODEL#	STANDARD TEXTILE GRADES											
			1	2	3	4	5	6	7	8	9	10	11	12
 <p>Square Single Seater Bench COM: 1.75 YD 1.6 M Unit weight: 25 LB 11.4 KG Carton weight: 30 LB 13.61 KG Carton volume: 9.25 FT³ 0.26 MT³</p>	<p>For power/USB unit please see electrical placement chart. Includes ganging hardware (2 sides).</p>	7728	1157	1213	1260	1315	1404	1486	1568	1640	1729	1813	1927	2088
			OVERALL DIMENSIONS			SEAT DIMENSIONS			BACK DIMENSIONS					
			W	D	H	W	D	H	W	H				
			IN 24.5	28	17.5	-	-	-	-	-				
			MM 622	711	445	-	-	-	-	-				
			RTA 00	1 per carton										
 <p>36" Dia. - Round Bench COM: 3 YD 2.74 M Unit weight: 41 LB 18.6 KG Carton weight: 46 LB 20.87 KG Carton volume: 18.25 FT³ 0.51 MT³</p>	<p>No power/USB unit. Freestanding unit only.</p>	7729	1546	1642	1723	1816	1969	2110	2251	2374	2527	2671	2866	3142
			OVERALL DIMENSIONS			SEAT DIMENSIONS			BACK DIMENSIONS					
			W	D	H	W	D	H	W	H				
			IN 36	36	17.5	-	-	-	-	-				
			MM 914	914	445	-	-	-	-	-				
			RTA 00	1 per carton										
 <p>42" Dia. - Round Bench COM: 3.25 YD 2.97 M Unit weight: 45 LB 20.5 KG Carton weight: 50 LB 22.68 KG Carton volume: 22 FT³ 0.62 MT³</p>	<p>No power/USB unit. Freestanding unit only.</p>	7730	1813	1917	2005	2106	2271	2424	2577	2710	2876	3032	3243	3542
			OVERALL DIMENSIONS			SEAT DIMENSIONS			BACK DIMENSIONS					
			W	D	H	W	D	H	W	H				
			IN 42	42	17.5	-	-	-	-	-				
			MM 1067	1067	445	-	-	-	-	-				
			RTA 00	1 per carton										
 <p>30" Square Laminated Coffee Table COM: N/A Unit weight: 48 LB 21.8 KG Carton weight: 61 LB 27.67 KG Carton volume: 11.5 FT³ 0.32 MT³</p>	<p>For power/USB unit please see electrical placement chart. Freestanding unit only.</p>	7731	List price											
			1392											
			OVERALL DIMENSIONS			SEAT DIMENSIONS			BACK DIMENSIONS					
			W	D	H	W	D	H	W	H				
			IN 30	30	17	-	-	-	-	-				
			MM 762	762	432	-	-	-	-	-				
			RTA 00	1 per carton										
 <p>36" Square Laminated Coffee Table COM: N/A Unit weight: 70 LB 31.8 KG Carton weight: 85 LB 38.56 KG Carton volume: 16.5 FT³ 0.46 MT³</p>	<p>For Power/USB unit please see electrical placement chart. Freestanding unit only.</p>	7732	List price											
			1582											
			OVERALL DIMENSIONS			SEAT DIMENSIONS			BACK DIMENSIONS					
			W	D	H	W	D	H	W	H				
			IN 36	36	17	-	-	-	-	-				
			MM 914	914	432	-	-	-	-	-				
			RTA 00	1 per carton										

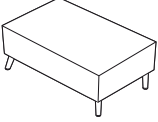
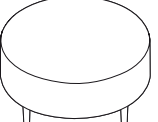
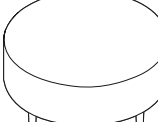
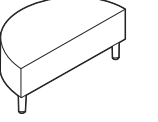
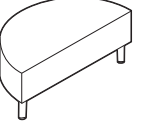
DESCRIPTION	FEATURES	MODEL#	STANDARD TEXTILE GRADES							
 <p>Rectangular Laminate Coffee Table COM: N/A Unit weight: 50 LB 22.7 KG Carton weight: 55 LB 24.95 KG Carton volume: 11.5 FT³ 0.32 MT³</p>	<p>For power/USB unit please see electrical placement chart.</p> <p>Freestanding unit only.</p>	<p>7733</p>	List price							
			1400							
			OVERALL DIMENSIONS			SEAT DIMENSIONS			BACK DIMENSIONS	
			W	D	H	W	D	H	W	H
			IN 40	20	17	-	-	-	-	-
MM 1016	508	432	-	-	-	-	-			
		RTA 00	1 per carton							
 <p>36" Dia. - Round Laminate Coffee Table COM: N/A Unit weight: 58 LB 26.4 KG Carton weight: 63 LB 28.58 KG Carton volume: 16.5 FT³ 0.46 MT³</p>	<p>For power/USB unit please see electrical placement chart.</p> <p>Freestanding unit only.</p>	<p>7734</p>	List price							
			1729							
			OVERALL DIMENSIONS			SEAT DIMENSIONS			BACK DIMENSIONS	
			W	D	H	W	D	H	W	H
			IN 36	36	17	-	-	-	-	-
MM 914	914	432	-	-	-	-	-			
		RTA 00	1 per carton							
 <p>42" Dia. - Round Laminate Coffee Table COM: N/A Unit weight: 80 LB 36.4 KG Carton weight: 85 LB 38.56 KG Carton volume: 22 FT³ 0.62 MT³</p>	<p>For power/USB unit please see electrical placement chart.</p> <p>Freestanding unit only.</p>	<p>7735</p>	List price							
			1889							
			OVERALL DIMENSIONS			SEAT DIMENSIONS			BACK DIMENSIONS	
			W	D	H	W	D	H	W	H
			IN 42	42	17	-	-	-	-	-
MM 1067	1067	432	-	-	-	-	-			
		RTA 00	1 per carton							
 <p>36" Half Round Laminate Coffee Table COM: N/A Unit weight: 32 LB 14.5 KG Carton weight: 37 LB 16.78 KG Carton volume: 8.5 FT³ 0.24 MT³</p>	<p>For power/USB unit please see electrical placement chart.</p> <p>Freestanding unit only.</p>	<p>7736</p>	List price							
			1223							
			OVERALL DIMENSIONS			SEAT DIMENSIONS			BACK DIMENSIONS	
			W	D	H	W	D	H	W	H
			IN 36	18	17	-	-	-	-	-
MM 914	457	432	-	-	-	-	-			
		RTA 00	1 per carton							
 <p>42" Half Round Laminate Coffee Table COM: N/A Unit weight: 44 LB 20 KG Carton weight: 48 LB 21.77 KG Carton volume: 11.5 FT³ 0.32 MT³</p>	<p>For power/USB unit please see electrical placement chart.</p> <p>Freestanding unit only.</p>	<p>7737</p>	List price							
			1483							
			OVERALL DIMENSIONS			SEAT DIMENSIONS			BACK DIMENSIONS	
			W	D	H	W	D	H	W	H
			IN 42	21	17	-	-	-	-	-
MM 1067	533	432	-	-	-	-	-			
		RTA 00	1 per carton							

DESCRIPTION FEATURES MODEL# STANDARD TEXTILE GRADES

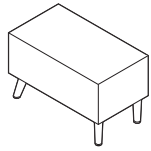

Rectangular Laminate End Table

COM: N/A
 Unit weight: 28 LB | 12.7 KG
 Carton weight: 34 LB | 15.42 KG
 Carton volume: 5.5 FT³ | 0.15 MT³

For power/USB unit please see electrical placement chart.
 Includes ganging hardware (2 sides).

List price							
7738	1401						
OVERALL DIMENSIONS			SEAT DIMENSIONS			BACK DIMENSIONS	
W	D	H	W	D	H	W	H
IN 15	27.25	17	-	-	-	-	-
MM 381	692	432	-	-	-	-	-
RTA 00		1 per carton					

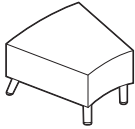

IS Curve Wide Wedge Laminate End Table

COM: N/A
 Unit weight: 40 LB | 18.2 KG
 Carton weight: 50 LB | 22.68 KG
 Carton volume: 9.5 FT³ | 0.26 MT³

For power/USB unit please see electrical placement chart.
 Includes ganging hardware (2 sides).

List price							
7739	1850						
OVERALL DIMENSIONS			SEAT DIMENSIONS			BACK DIMENSIONS	
W	D	H	W	D	H	W	H
IN 27.25	27.25	17	-	-	-	-	-
MM 692	692	432	-	-	-	-	-
RTA 00		1 per carton					

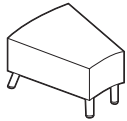

IS Curve Narrow Wedge Laminate End Table

COM: N/A
 Unit weight: 28 LB | 12.7 KG
 Carton weight: 34 LB | 15.42 KG
 Carton volume: 6.5 FT³ | 0.18 MT³

For power/USB unit please see electrical placement chart.
 Includes ganging hardware (2 sides).

List price							
7740	1499						
OVERALL DIMENSIONS			SEAT DIMENSIONS			BACK DIMENSIONS	
W	D	H	W	D	H	W	H
IN 18.25	27.25	17	-	-	-	-	-
MM 464	692	432	-	-	-	-	-
RTA 00		1 per carton					

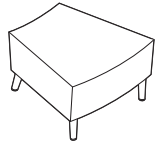

OS Curve - Wide Wedge Laminate End Table

COM: N/A
 Unit weight: 40 LB | 18.2 KG
 Carton weight: 50 LB | 22.68 KG
 Carton volume: 9.5 FT³ | 0.26 MT³

For power/USB unit please see electrical placement chart.
 Includes ganging hardware (2 sides).

List price							
7741	1850						
OVERALL DIMENSIONS			SEAT DIMENSIONS			BACK DIMENSIONS	
W	D	H	W	D	H	W	H
IN 27.25	27.25	17	-	-	-	-	-
MM 692	692	432	-	-	-	-	-
RTA 00		1 per carton					

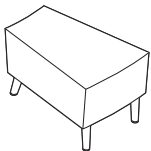

OS Curve - Narrow Wedge Laminate End Table

COM: N/A
 Unit weight: 28 LB | 12.7 KG
 Carton weight: 34 LB | 15.42 KG
 Carton volume: 6.5 FT³ | 0.18 MT³

For power/USB unit please see electrical placement chart.
 Includes ganging hardware (2 sides).

List price							
7742	1499						
OVERALL DIMENSIONS			SEAT DIMENSIONS			BACK DIMENSIONS	
W	D	H	W	D	H	W	H
IN 18.25	27.25	17	-	-	-	-	-
MM 464	692	432	-	-	-	-	-
RTA 00		1 per carton					

DESCRIPTION	FEATURES	MODEL#	STANDARD TEXTILE GRADES																																																		
 18" Round Laminate Laptop Table w/14" Base COM: N/A Unit weight: 22 LB 10 KG Carton weight: 32 LB 14.51 KG Carton volume: 6 FT³ 0.16 MT³	No power/USB unit.	7743	List price																																																		
			1063																																																		
			OVERALL DIMENSIONS			SEAT DIMENSIONS			BACK DIMENSIONS																																												
			W	D	H	W	D	H	W	H																																											
			IN 18	18	25.25	-	-	-	-	-																																											
 16" Square Laminate Laptop Table w/14" Base COM: N/A Unit weight: 26 LB 11.8 KG Carton weight: 36 LB 16.33 KG Carton volume: 6 FT³ 0.16 MT³	No power/USB unit.	7745	List price																																																		
			1035																																																		
			OVERALL DIMENSIONS			SEAT DIMENSIONS			BACK DIMENSIONS																																												
			W	D	H	W	D	H	W	H																																											
			IN 16	16	25.25	-	-	-	-	-																																											
 Personal Harbor - Standard Back COM: 5.5 YD 5.03 M Unit weight: 70 LB 31.8 KG Carton weight: 85 LB 38.56 KG Carton volume: 31.75 FT³ 0.89 MT³	For power/USB unit please see electrical placement chart. Freestanding unit only. *High traffic model.	7746	List price																																																		
			1 per carton																																																		
			<table border="1"> <thead> <tr> <th></th> <th>1</th> <th>2</th> <th>3</th> <th>4</th> <th>5</th> <th>6</th> <th>7</th> <th>8</th> <th>9</th> <th>10</th> <th>11</th> <th>12</th> </tr> </thead> <tbody> <tr> <td>7746</td> <td>3124</td> <td>3300</td> <td>3449</td> <td>3619</td> <td>3900</td> <td>4158</td> <td>4417</td> <td>4642</td> <td>4923</td> <td>5187</td> <td>5544</td> <td>6050</td> </tr> <tr> <td>7786*</td> <td>3568</td> <td>3744</td> <td>3893</td> <td>4063</td> <td>4344</td> <td>4602</td> <td>4861</td> <td>5086</td> <td>5367</td> <td>5631</td> <td>5988</td> <td>6494</td> </tr> </tbody> </table>													1	2	3	4	5	6	7	8	9	10	11	12	7746	3124	3300	3449	3619	3900	4158	4417	4642	4923	5187	5544	6050	7786*	3568	3744	3893	4063	4344	4602	4861	5086	5367	5631	5988	6494
				1	2	3	4	5	6	7	8	9	10	11	12																																						
			7746	3124	3300	3449	3619	3900	4158	4417	4642	4923	5187	5544	6050																																						
7786*	3568	3744	3893	4063	4344	4602	4861	5086	5367	5631	5988	6494																																									
OVERALL DIMENSIONS			SEAT DIMENSIONS			BACK DIMENSIONS																																															
W	D	H	W	D	H	W	H																																														
IN 45	29.5	32	24	19	18	27	14																																														
 Personal Harbor - High Back COM: 7.75 YD 7.09 M Unit weight: 86 LB 39.1 KG Carton weight: 101 LB 45.81 KG Carton volume: 40.25 FT³ 1.13 MT³	For power/USB unit please see electrical placement chart. Freestanding unit only. *High traffic model.	7747	List price																																																		
			1 per carton																																																		
			<table border="1"> <thead> <tr> <th></th> <th>1</th> <th>2</th> <th>3</th> <th>4</th> <th>5</th> <th>6</th> <th>7</th> <th>8</th> <th>9</th> <th>10</th> <th>11</th> <th>12</th> </tr> </thead> <tbody> <tr> <td>7747</td> <td>4397</td> <td>4645</td> <td>4854</td> <td>5095</td> <td>5490</td> <td>5854</td> <td>6218</td> <td>6536</td> <td>6931</td> <td>7303</td> <td>7807</td> <td>8520</td> </tr> <tr> <td>7787*</td> <td>4970</td> <td>5218</td> <td>5427</td> <td>5668</td> <td>6063</td> <td>6427</td> <td>6791</td> <td>7109</td> <td>7504</td> <td>7876</td> <td>8380</td> <td>9093</td> </tr> </tbody> </table>													1	2	3	4	5	6	7	8	9	10	11	12	7747	4397	4645	4854	5095	5490	5854	6218	6536	6931	7303	7807	8520	7787*	4970	5218	5427	5668	6063	6427	6791	7109	7504	7876	8380	9093
				1	2	3	4	5	6	7	8	9	10	11	12																																						
			7747	4397	4645	4854	5095	5490	5854	6218	6536	6931	7303	7807	8520																																						
7787*	4970	5218	5427	5668	6063	6427	6791	7109	7504	7876	8380	9093																																									
OVERALL DIMENSIONS			SEAT DIMENSIONS			BACK DIMENSIONS																																															
W	D	H	W	D	H	W	H																																														
IN 45	29.5	41.5	24	19	18	27	24																																														
 Personal Harbor - Extended Back COM: 8.5 YD 7.77 M Unit weight: 102 LB 46.4 KG Carton weight: 117 LB 53.07 KG Carton volume: 45.75 FT³ 1.29 MT³	For power/USB unit please see electrical placement chart. Freestanding unit only. *High traffic model.	7748	List price																																																		
			1 per carton																																																		
			<table border="1"> <thead> <tr> <th></th> <th>1</th> <th>2</th> <th>3</th> <th>4</th> <th>5</th> <th>6</th> <th>7</th> <th>8</th> <th>9</th> <th>10</th> <th>11</th> <th>12</th> </tr> </thead> <tbody> <tr> <td>7748</td> <td>4946</td> <td>5218</td> <td>5448</td> <td>5711</td> <td>6145</td> <td>6544</td> <td>6944</td> <td>7292</td> <td>7726</td> <td>8134</td> <td>8686</td> <td>9468</td> </tr> <tr> <td>7788*</td> <td>5389</td> <td>5661</td> <td>5891</td> <td>6154</td> <td>6588</td> <td>6987</td> <td>7387</td> <td>7735</td> <td>8169</td> <td>8577</td> <td>9129</td> <td>9911</td> </tr> </tbody> </table>													1	2	3	4	5	6	7	8	9	10	11	12	7748	4946	5218	5448	5711	6145	6544	6944	7292	7726	8134	8686	9468	7788*	5389	5661	5891	6154	6588	6987	7387	7735	8169	8577	9129	9911
				1	2	3	4	5	6	7	8	9	10	11	12																																						
			7748	4946	5218	5448	5711	6145	6544	6944	7292	7726	8134	8686	9468																																						
7788*	5389	5661	5891	6154	6588	6987	7387	7735	8169	8577	9129	9911																																									
OVERALL DIMENSIONS			SEAT DIMENSIONS			BACK DIMENSIONS																																															
W	D	H	W	D	H	W	H																																														
IN 45	29.5	47	24	19	18	27	29																																														

RIVER+ SEATING

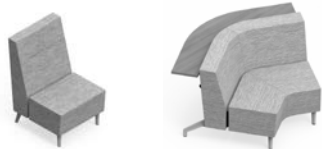

model R27802

model R27824S

River+ Benches & Tables



For River+ benches, please see page 308.
For River+ tables, please see page 313.

EXAMPLE RIVER+ SEATING ORDER CODE:

R27802	-NS	-CE90	-NS	-CE90	-	-FO
Model number	Sealed Seams (back)	Back textile	Sealed seams (seat)	Seat textile	Shelf finish	Connector finish
-CHM	-S6	-NC				
Leg finish	Leg selection	Additional weight				

Additional Options specify at end of order code.	SPECIFY CODE
Additional weight See each model for amount of added weight and upcharge. For models ending in S, applies only to leg selection (S6).	CW
Bottom selection Black lining (standard) Vinyl sealed bottom w/staple strip. Upcharges vary, see model.* Steel bottom. Upcharges vary, see model.**	SB SU BS
Power unit finish Jet Black White	J W
Power/USB unit position (see electrical placement images, not available on corner units) Front left Front right Side left Side right Power/USB unit position (models with shelf only) Center back	\$717 per unit F1 F2 S1 S2 CB
Tamperproof fasteners Upcharges vary, see model.	TP
Moisture barrier Upcharges vary, see model.	MB
Accessory hook finish (for models with shelf) Night. No Upcharge. Fog. No Upcharge. Latte. No Upcharge.	BK FO LB

*linking hardware is lowered to clear the staple strip.
Units will only gang with other units with sealed bottom.
**cannot be combined with linking hardware or power units

STANDARD FEATURES

- A modular series that is composed of straight, curved and corner sections.
- Same seat height units with no upholstered arms can be linked together to create a variety of layouts. Ganging hardware is standard (factory installed) and swivels out of the way when not in use.
- The unique tapered legs are made of welded steel, with each leg bolted directly to the unit frame. Standard leg height is 6.5". The leg height makes it easy to clean under the product.
- Legs are standard in Chrome (CHM) with Black nylon non-marking height adjustable glides.
- Modular, aluminum loop arms are sold separately (with or without nylon armcaps). These relocatable arms are field installed at any seat to back connector.
- Seating frames are heavy duty with interlocking plywood, puzzle box construction, and are made for active environments. Seats are high density with highly resilient foam.
- Seat to back connector components join back and seat; maintaining offset for cleanout. Connector is available in three finishes.
- All River+ seating models meet or exceed the applicable ANSI/BIFMA standards and are backed by Global's Heavy Duty warranty.
- River+ seating is rated for an active weight up to 600 lbs. per seat and 24/7 use.
- For heavy duty application, Global's Limited Lifetime Warranty is applicable only on fabrics that are rated for 100,000+ double rubs.
- Upholstery options: fabric, vinyl or leather. Leather only recommended on seat and may feature a horizontal stitch detail.
- All units are shipped fully assembled.

OPTIONAL FEATURES

- To add sealed seams to your product, please specify (S2), (SE) - see each model for upcharges.
- A 10" deep, 1" thick back shelf is available on corner, two and three seater units in many low pressure laminate finishes. Shelf supports are aluminum with accessory hook in three finishes. Weight capacity: Shelf - 50 lbs. per seat; Hook - 20 lbs. each.
- Units with shelf available with 6.5" leg. Back legs on these models are (E6) extended legs, as standard.
- To specify tapered legs on shelf models to match models without shelf, select (C6) leg with counterweight. Available on models ending in "S". Upcharges vary.
- Floor mount legs are available. Please specify (F6). Models with shelf will have extended legs. Fastening hardware not included.
- Products can be weighted to reduce the ease of movement. For additional weight options, please specify (CW) - see each model for available additional weight and upcharge.
- Underside of seat is standard with black lining (SB). For improved housekeeping and infection control practices, the underside of the seat can be finished with PVC (vinyl) and sealed to prevent penetration of liquids. Please specify (SU) - see each model for upcharge.
- Steel bottom provides tamperproof protection (includes tamperproof screws). Please specify (BS) - see each model for upcharge. Note: electrical option and ganging are not available with steel bottom.
- Most seating (except corner units) can be specified with power/USB units, which include one power outlet, one double USB terminal with a matching 120" three-prong power cord.
- Power/USB units can be specified in a variety predetermined locations, as shown in the electrical illustrations. Electrical units must be factory installed.

- Power/USB units are available with either Jet Black (J) face plate with Black power/USB receptacles or with a White (W) face plate with White power/USB receptacles.
- Tamperproof fasteners can be requested for a higher level of safety (ganging brackets are not included). Please specify (TP) - see each model for upcharge.
- For moisture barrier on seat, please specify (MB) - see each model for upcharge.

Please add option codes in the following order:

- **Model number**
R27801 to R27803 Lounge chairs
R27804 to R27806 Two seaters
R27807 to R27809 Three seaters
R27810 to R27812 Bariatric lounge chairs
R27815 to R27817 Inside curve two seaters
R27818 to R27820 Outside curve two seaters
R27821 to R27823 90 degree corners
R27824 to R27826 120 degree corners
- Add (S) to model # if ordering with a back shelf (excludes lounge chairs and bariatric models).
- **Back + upholstered arms sealed seams (NS)** Standard seams.
(S2) Back sealed seams. Upcharges vary, see model.
- **Back + upholstered arms textile**
Specify textile code.
- **Seat sealed seams (NS)** Standard seams.
(SE) Seat sealed seams. Upcharges vary, see model.
- **Seat textile**
Specify textile code.
- **Back shelf finish** (for models ending in S) (colors shown on website)
(ACJ) Absolute Acajou (FCL) First Class
(ASN) Asian Night (NBL) Noce Biondo
(AWC) Avant Cherry (NGL) Noce Grigio
(AWH) Avant Honey (NEL) Noce Leggero
(BLK) Black (NML) Noce Medio
(BZD) Blizzard (OTM) Quartered Mahogany
(BRC) Brushed Cobalt (SBY) Sheer Beauty
(CMB) Clear Maple (SDT) Stonedust
(CGY) Custom Grey (SOG) Storm Grey
(DES) Dark Espresso (WHE) Walnut Heights
(DWT) Designer White (WHC) White Chocolate
(FAS) Fashionista (WCR) Winter Cherry
- **Seat to back connector finish**
(BK) Night. No upcharge.
(FO) Fog. No upcharge.
(LB) Latte. No upcharge.
- **Leg finish**
For leg finish options, please see page 379. No upcharges.
- **Leg selection** (models without shelf)
(S6) Standard seat height (17.5"), 6.5" leg w/ adjustable glides. No upcharge.
(S8) High seat (19"), 8" leg w/adjustable glides. No upcharge.
(F6) Standard seat height (17.5"), 6.5" leg w/floor mount. Add \$90 for straight units; \$113 for curved, corner units.
(F8) High seat (19"), 8" leg w/floor mount. Add \$90 for straight units; \$113 for curved, corner units.
- **Leg selection** (models with shelf)
(E6) Standard seat height (17.5"), 6.5" extended leg w/adjustable glides.
(F6) Standard seat height (17.5"), 6.5" extended leg w/floor mount. Add \$90 for straight units; \$113 for curved, corner units.
(C6) Standard seat height (17.5"), 6.5" leg w/adjustable glides and counterweight. Upcharges vary, see model.
- **Additional weight** (not available on all models)
(NC) No added weight. No upcharge.
(CW) Counterweight. See each model for weight added and upcharge.

SHELF HEIGHTS

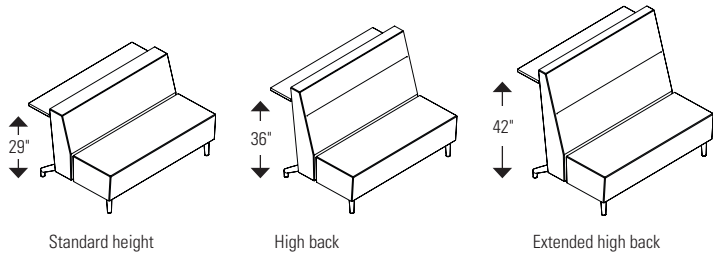

DIMENSIONS

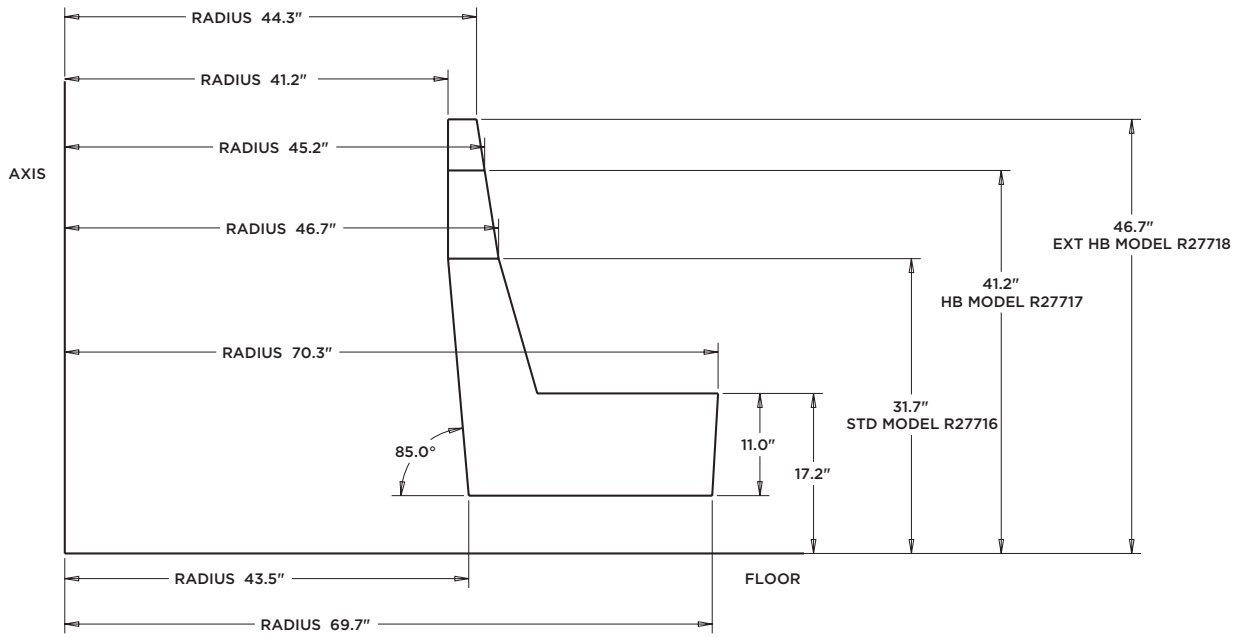

ELECTRICAL PLACEMENT

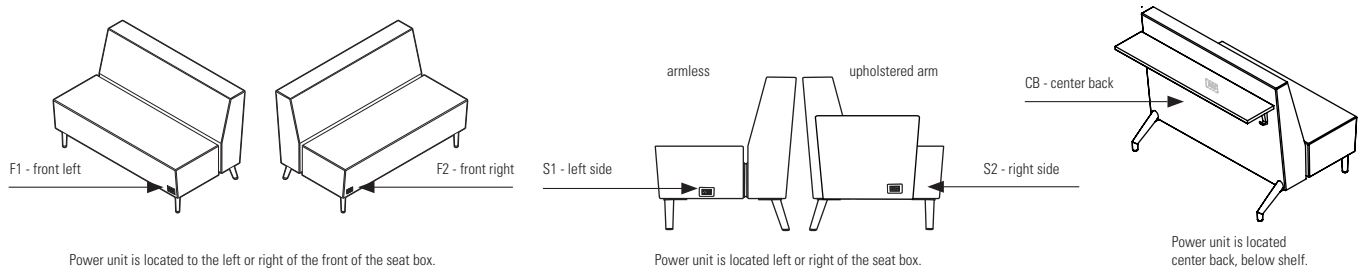

DESCRIPTION FEATURES MODEL# STANDARD TEXTILE GRADES



R27801

Lounge Chair - Standard Back
 COM: 3.75 YD | 3.43 M
 Unit weight: 47 LB | 21.4 KG
 Carton weight: 61 LB | 27.67 KG
 Carton volume: 19.75 FT³ | 0.55 MT³

For power/USB unit, please see electrical placement chart.

Includes ganging hardware (2 sides).

Add \$52, \$46 for (S2), (SE)
 Add \$533 for 36 lbs. (CW)
 Add \$59 for (SU) or \$298 for (BS)
 Add \$28 for (TP)
 Add \$81 for (MB)

MODEL#	STANDARD TEXTILE GRADES											
	1	2	3	4	5	6	7	8	9	10	11	12
R27801	1691	1811	1912	2029	2220	2396	2572	2726	2917	3097	3341	3686
OVERALL DIMENSIONS			SEAT DIMENSIONS			BACK DIMENSIONS						
W	D	H	W	D	H	W	H					
IN 26	30	32	26	19	18	26	14					
MM 660	762	813	660	483	457	660	356					
RTA 00		1 per carton										

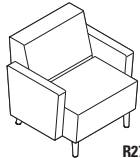

R27801B

Lounge Chair - Standard Back w/Uph Arms
 COM: 5.75 YD | 5.26 M
 Unit weight: 67 LB | 30.5 KG
 Carton weight: 82 LB | 37.19 KG
 Carton volume: 24.5 FT³ | 0.69 MT³

For power/USB unit, please see electrical placement chart.

Ganging not available.

Add \$91, \$46 for (S2), (SE)
 Add \$533 for 36 lbs. (CW)
 Add \$57 for (SU) or \$285 for (BS)
 Add \$28 for (TP)
 Add \$77 for (MB)

MODEL#	STANDARD TEXTILE GRADES											
	1	2	3	4	5	6	7	8	9	10	11	12
R27801B	2285	2469	2624	2803	3096	3366	3636	3872	4165	4441	4815	5344
OVERALL DIMENSIONS			SEAT DIMENSIONS			BACK DIMENSIONS						
W	D	H	W	D	H	W	H					
IN 33	30	32	26	19	18	26	14					
MM 838	762	813	660	483	457	660	356					
RTA 00		1 per carton										

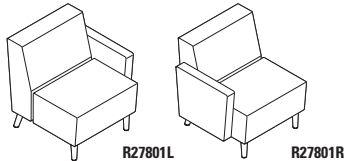

R27801L

R27801R

Lounge Chair - Standard Back w/Uph Arms (Left/Right)
 COM: 4.75 YD | 4.34 M
 Unit weight: 57 LB | 25.9 KG
 Carton weight: 72 LB | 32.66 KG
 Carton volume: 24.5 FT³ | 0.69 MT³

For power/USB unit, please see electrical placement chart.

Includes ganging hardware (1 side only).

Add \$71, \$46 for (S2), (SE)
 Add \$533 for 36 lbs. (CW)
 Add \$57 for (SU) or \$285 for (BS)
 Add \$28 for (TP)
 Add \$77 for (MB)

MODEL#	STANDARD TEXTILE GRADES											
	1	2	3	4	5	6	7	8	9	10	11	12
R27801L R27801R	1988	2140	2268	2416	2658	2881	3104	3299	3541	3769	4078	4515
OVERALL DIMENSIONS			SEAT DIMENSIONS			BACK DIMENSIONS						
W	D	H	W	D	H	W	H					
IN 29.5	30	32	26	19	18	26	14					
MM 749	762	813	660	483	457	660	356					
RTA 00		1 per carton										

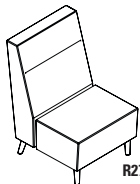

R27802

Lounge Chair - High Back
 COM: 4.5 YD | 4.11 M
 Unit weight: 52 LB | 23.6 KG
 Carton weight: 71 LB | 32.21 KG
 Carton volume: 24.75 FT³ | 0.7 MT³

For power/USB unit, please see electrical placement chart.

Includes ganging hardware (2 sides).

Add \$72, \$46 for (S2), (SE)
 Add \$533 for 36 lbs. (CW)
 Add \$59 for (SU) or \$298 for (BS)
 Add \$28 for (TP)
 Add \$81 for (MB)

MODEL#	STANDARD TEXTILE GRADES											
	1	2	3	4	5	6	7	8	9	10	11	12
R27802	1878	2022	2143	2284	2513	2724	2935	3120	3349	3565	3858	4272
OVERALL DIMENSIONS			SEAT DIMENSIONS			BACK DIMENSIONS						
W	D	H	W	D	H	W	H					
IN 26	30.5	41.5	26	19	18	26	23.5					
MM 660	775	1054	660	483	457	660	597					
RTA 00		1 per carton										

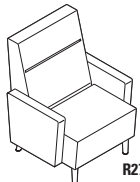

R27802B

Lounge Chair - High Back w/Uph Arms
 COM: 6.5 YD | 5.94 M
 Unit weight: 72 LB | 32.7 KG
 Carton weight: 88.5 LB | 40.14 KG
 Carton volume: 31.25 FT³ | 0.88 MT³

For power/USB unit, please see electrical placement chart.

Ganging not available.

Add \$112, \$46 for (S2), (SE)
 Add \$533 for 36 lbs. (CW)
 Add \$59 for (SU) or \$298 for (BS)
 Add \$28 for (TP)
 Add \$81 for (MB)

MODEL#	STANDARD TEXTILE GRADES											
	1	2	3	4	5	6	7	8	9	10	11	12
R27802B	2472	2680	2855	3058	3389	3694	3999	4266	4597	4909	5332	5930
OVERALL DIMENSIONS			SEAT DIMENSIONS			BACK DIMENSIONS						
W	D	H	W	D	H	W	H					
IN 33	30.5	41.5	26	19	18	26	23.5					
MM 838	775	1054	660	483	457	660	597					
RTA 00		1 per carton										

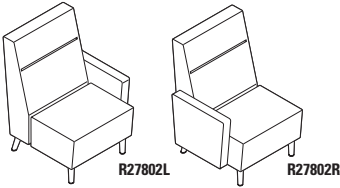
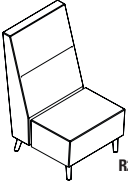
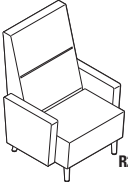
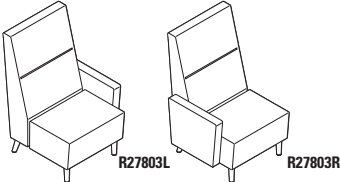
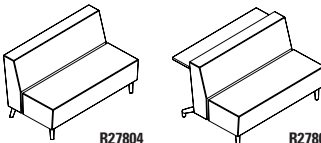
DESCRIPTION	FEATURES	MODEL#	STANDARD TEXTILE GRADES																					
			1	2	3	4	5	6	7	8	9	10	11	12										
 <p>Lounge Chair - High Back w/Up Arms (Left/Right) COM: 5.5 YD 5.03 M Unit weight: 62 LB 28.2 KG Carton weight: 78.5 LB 35.61 KG Carton volume: 31.25 FT³ 0.88 MT³</p>	<p>For power/USB unit, please see electrical placement chart.</p> <p>Includes ganging hardware (1 side only).</p> <p>Add \$91, \$46 for (S2), (SE) Add \$533 for 36 lbs. (CW) Add \$59 for (SU) or \$298 for (BS) Add \$28 for (TP) Add \$81 for (MB)</p>	R27802L	2175	2351	2499	2671	2951	3209	3467	3693	3973	4237	4595	5101										
		<p>OVERALL DIMENSIONS</p> <table border="1"> <tr> <th>W</th> <th>D</th> <th>H</th> <th>W</th> <th>D</th> <th>H</th> <th>W</th> <th>H</th> </tr> <tr> <td>IN 29.5</td> <td>30.5</td> <td>41.5</td> <td>26</td> <td>19</td> <td>18</td> <td>26</td> <td>23.5</td> </tr> <tr> <td>MM 749</td> <td>775</td> <td>1054</td> <td>660</td> <td>483</td> <td>457</td> <td>660</td> <td>597</td> </tr> </table> <p>RTA 00 1 per carton</p>	W	D	H	W	D	H	W	H	IN 29.5	30.5	41.5	26	19	18	26	23.5	MM 749	775	1054	660	483	457
W	D	H	W	D	H	W	H																	
IN 29.5	30.5	41.5	26	19	18	26	23.5																	
MM 749	775	1054	660	483	457	660	597																	
 <p>Lounge Chair - Extended Back COM: 4.75 YD 4.34 M Unit weight: 64 LB 29.1 KG Carton weight: 81 LB 36.74 KG Carton volume: 28 FT³ 0.79 MT³</p>	<p>For power/USB unit, please see electrical placement chart.</p> <p>Includes ganging hardware (2 sides).</p> <p>Add \$72, \$46 for (S2), (SE) Add \$533 for 36 lbs. (CW) Add \$59 for (SU) or \$298 for (BS) Add \$28 for (TP) Add \$81 for (MB)</p>	R27803	1972	2124	2252	2400	2642	2865	3088	3283	3525	3753	4062	4499										
		<p>OVERALL DIMENSIONS</p> <table border="1"> <tr> <th>W</th> <th>D</th> <th>H</th> <th>W</th> <th>D</th> <th>H</th> <th>W</th> <th>H</th> </tr> <tr> <td>IN 26</td> <td>31</td> <td>47</td> <td>26</td> <td>19</td> <td>18</td> <td>26</td> <td>29</td> </tr> <tr> <td>MM 660</td> <td>787</td> <td>1194</td> <td>660</td> <td>483</td> <td>457</td> <td>660</td> <td>597</td> </tr> </table> <p>RTA 00 1 per carton</p>	W	D	H	W	D	H	W	H	IN 26	31	47	26	19	18	26	29	MM 660	787	1194	660	483	457
W	D	H	W	D	H	W	H																	
IN 26	31	47	26	19	18	26	29																	
MM 660	787	1194	660	483	457	660	597																	
 <p>Lounge Chair - Extended Back w/Up Arms COM: 6.75 YD 6.17 M Unit weight: 84 LB 38.2 KG Carton weight: 101.5 LB 46.04 KG Carton volume: 35 FT³ 0.99 MT³</p>	<p>For power/USB unit, please see electrical placement chart.</p> <p>Ganging not available.</p> <p>Add \$117, \$46 for (S2), (SE) Add \$533 for 36 lbs. (CW) Add \$59 for (SU) or \$298 for (BS) Add \$28 for (TP) Add \$81 for (MB)</p>	R27803B	2566	2782	2964	3174	3518	3835	4152	4429	4773	5097	5536	6157										
		<p>OVERALL DIMENSIONS</p> <table border="1"> <tr> <th>W</th> <th>D</th> <th>H</th> <th>W</th> <th>D</th> <th>H</th> <th>W</th> <th>H</th> </tr> <tr> <td>IN 33</td> <td>31</td> <td>47</td> <td>26</td> <td>19</td> <td>18</td> <td>26</td> <td>29</td> </tr> <tr> <td>MM 838</td> <td>787</td> <td>1194</td> <td>660</td> <td>483</td> <td>457</td> <td>660</td> <td>737</td> </tr> </table> <p>RTA 00 1 per carton</p>	W	D	H	W	D	H	W	H	IN 33	31	47	26	19	18	26	29	MM 838	787	1194	660	483	457
W	D	H	W	D	H	W	H																	
IN 33	31	47	26	19	18	26	29																	
MM 838	787	1194	660	483	457	660	737																	
 <p>Lounge Chair - Extended Back w/Up Arms (Left/Right) COM: 5.75 YD 5.26 M Unit weight: 74 LB 33.6 KG Carton weight: 91.5 LB 41.5 KG Carton volume: 35 FT³ 0.99 MT³</p>	<p>For power/USB unit, please see electrical placement chart.</p> <p>Includes ganging hardware (1 side only).</p> <p>Add \$97, \$46 for (S2), (SE) Add \$533 for 36 lbs. (CW) Add \$59 for (SU) or \$298 for (BS) Add \$28 for (TP) Add \$81 for (MB)</p>	R27803L	2269	2453	2608	2787	3080	3350	3620	3856	4149	4425	4799	5328										
		<p>OVERALL DIMENSIONS</p> <table border="1"> <tr> <th>W</th> <th>D</th> <th>H</th> <th>W</th> <th>D</th> <th>H</th> <th>W</th> <th>H</th> </tr> <tr> <td>IN 29.5</td> <td>31</td> <td>47</td> <td>26</td> <td>19</td> <td>18</td> <td>26</td> <td>29</td> </tr> <tr> <td>MM 749</td> <td>787</td> <td>1194</td> <td>660</td> <td>483</td> <td>457</td> <td>660</td> <td>737</td> </tr> </table> <p>RTA 00 1 per carton</p>	W	D	H	W	D	H	W	H	IN 29.5	31	47	26	19	18	26	29	MM 749	787	1194	660	483	457
W	D	H	W	D	H	W	H																	
IN 29.5	31	47	26	19	18	26	29																	
MM 749	787	1194	660	483	457	660	737																	
 <p>Two Seater - Standard Back COM: 4.75 YD 4.34 M Unit weight: 91 LB 41.4 KG Carton weight: 113 LB 51.26 KG Carton volume: 28 FT³ 0.79 MT³</p>	<p>For power/USB unit, please see electrical placement chart.</p> <p>Includes ganging hardware (2 sides).</p> <p>Add \$85, \$71 for (S2), (SE) Add \$1067 for 72 lbs. (CW), (C6) Add \$119 for (SU) or \$476 for (BS) Add \$28 for (TP) Add \$161 for (MB)</p>	R27804	2647	2799	2927	3075	3317	3540	3763	3958	4200	4428	4737	5174										
		<p>R27804S</p> <p>shelf model in W52 D40.5 H32 MM W1321 D1029 H813</p> <p>OVERALL DIMENSIONS</p> <table border="1"> <tr> <th>W</th> <th>D</th> <th>H</th> <th>W</th> <th>D</th> <th>H</th> <th>W</th> <th>H</th> </tr> <tr> <td>IN 52</td> <td>30</td> <td>32</td> <td>52</td> <td>19</td> <td>18</td> <td>52</td> <td>14</td> </tr> <tr> <td>MM 1321</td> <td>762</td> <td>813</td> <td>1321</td> <td>483</td> <td>457</td> <td>1321</td> <td>356</td> </tr> </table> <p>RTA 00 1 per carton</p>	W	D	H	W	D	H	W	H	IN 52	30	32	52	19	18	52	14	MM 1321	762	813	1321	483	457
W	D	H	W	D	H	W	H																	
IN 52	30	32	52	19	18	52	14																	
MM 1321	762	813	1321	483	457	1321	356																	

DESCRIPTION FEATURES MODEL# STANDARD TEXTILE GRADES

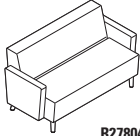
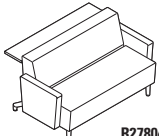
		STANDARD TEXTILE GRADES											
		1	2	3	4	5	6	7	8	9	10	11	12
 <p>R27804B</p>	 <p>R27804SB</p>	For power/USB unit, please see electrical placement chart. Ganging not available. Add \$127, \$71 for (S2), (SE) Add \$1067 for 72 lbs. (CW), (C6) Add \$119 for (SU) or \$476 for (BS) Add \$28 for (TP) Add \$161 for (MB)											
		Add \$127, \$71 for (S2), (SE) Add \$1067 for 72 lbs. (CW), (C6) Add \$119 for (SU) or \$476 for (BS) Add \$28 for (TP) Add \$161 for (MB)											
Two Seater - Standard Back w/Uph Arms COM: 6.75 YD 6.17 M Unit weight: 111 LB 50.5 KG Carton weight: 133 LB 60.33 KG Carton volume: 42.5 FT ³ 1.2 MT ³		shelf model in W59 D40.5 H32 MM W1499 D1029 H813											
		OVERALL DIMENSIONS W D H			SEAT DIMENSIONS W D H			BACK DIMENSIONS W H					
		IN 59	30	32	52	19	18	52	14				
		MM 1499	762	813	1321	483	457	1321	356				
		RTA 00 1 per carton											

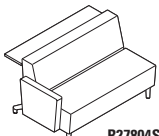
		STANDARD TEXTILE GRADES											
		1	2	3	4	5	6	7	8	9	10	11	12
 <p>R27804L</p>	 <p>R27804SR</p>	For power/USB unit, please see electrical placement chart. Includes ganging hardware (1 side only). Add \$106, \$71 for (S2), (SE) Add \$1067 for 72 lbs. (CW), (C6) Add \$119 for (SU) or \$476 for (BS) Add \$28 for (TP) Add \$161 for (MB)											
		Add \$106, \$71 for (S2), (SE) Add \$1067 for 72 lbs. (CW), (C6) Add \$119 for (SU) or \$476 for (BS) Add \$28 for (TP) Add \$161 for (MB)											
Two Seater - Standard Back w/Uph Arms (Left/Right) COM: 5.75 YD 5.26 M Unit weight: 101 LB 45.9 KG Carton weight: 123 LB 55.79 KG Carton volume: 42.5 FT ³ 1.2 MT ³		shelf model in W55.5 D40.5 H32 MM W1410 D1029 H813											
		OVERALL DIMENSIONS W D H			SEAT DIMENSIONS W D H			BACK DIMENSIONS W H					
		IN 55.5	30	32	52	19	18	52	14				
		MM 1410	762	813	1321	483	457	1321	356				
		RTA 00 1 per carton											

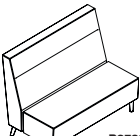
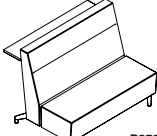
		STANDARD TEXTILE GRADES											
		1	2	3	4	5	6	7	8	9	10	11	12
 <p>R27805</p>	 <p>R27805S</p>	For power/USB unit, please see electrical placement chart. Includes ganging hardware (2 sides). Add \$115, \$71 for (S2), (SE) Add \$1067 for 72 lbs. (CW), (C6) Add \$119 for (SU) or \$476 for (BS) Add \$28 for (TP) Add \$161 for (MB)											
		Add \$115, \$71 for (S2), (SE) Add \$1067 for 72 lbs. (CW), (C6) Add \$119 for (SU) or \$476 for (BS) Add \$28 for (TP) Add \$161 for (MB)											
Two Seater - High Back COM: 5.5 YD 5.03 M Unit weight: 94 LB 42.7 KG Carton weight: 116 LB 52.62 KG Carton volume: 19.75 FT ³ 0.55 MT ³		shelf model in W52 D41 H41.5 MM W1321 D1041 H1054											
		OVERALL DIMENSIONS W D H			SEAT DIMENSIONS W D H			BACK DIMENSIONS W H					
		IN 52	30.5	41.5	52	19	18	52	23.5				
		MM 1321	775	1054	1321	483	457	1321	597				
		RTA 00 1 per carton											

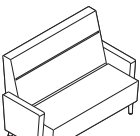
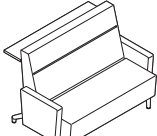
		STANDARD TEXTILE GRADES											
		1	2	3	4	5	6	7	8	9	10	11	12
 <p>R27805B</p>	 <p>R27805SB</p>	For power/USB unit, please see electrical placement chart. Ganging not available. Add \$155, \$71 for (S2), (SE) Add \$1067 for 72 lbs. (CW), (C6) Add \$119 for (SU) or \$476 for (BS) Add \$28 for (TP) Add \$161 for (MB)											
		Add \$155, \$71 for (S2), (SE) Add \$1067 for 72 lbs. (CW), (C6) Add \$119 for (SU) or \$476 for (BS) Add \$28 for (TP) Add \$161 for (MB)											
Two Seater - High Back w/Uph Arms COM: 7.5 YD 6.86 M Unit weight: 114 LB 51.8 KG Carton weight: 116 LB 52.62 KG Carton volume: 19.75 FT ³ 0.55 MT ³		shelf model in W59 D41 H41.5 MM W1499 D1041 H1054											
		OVERALL DIMENSIONS W D H			SEAT DIMENSIONS W D H			BACK DIMENSIONS W H					
		IN 59	30.5	41.5	52	19	18	52	23.5				
		MM 1499	775	1054	1321	483	457	1321	597				
		RTA 00 1 per carton											

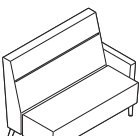
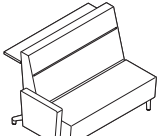
		STANDARD TEXTILE GRADES											
		1	2	3	4	5	6	7	8	9	10	11	12
 <p>R27805L</p>	 <p>R27805SR</p>	For power/USB unit, please see electrical placement chart. Includes ganging hardware (1 side only). Add \$134, \$71 for (S2), (SE) Add \$1067 for 72 lbs. (CW), (C6) Add \$119 for (SU) or \$476 for (BS) Add \$28 for (TP) Add \$161 for (MB)											
		Add \$134, \$71 for (S2), (SE) Add \$1067 for 72 lbs. (CW), (C6) Add \$119 for (SU) or \$476 for (BS) Add \$28 for (TP) Add \$161 for (MB)											
Two Seater - High Back w/Uph Arms (Left/Right) COM: 6.5 YD 5.94 M Unit weight: 104 LB 47.3 KG Carton weight: 128 LB 58.06 KG Carton volume: 54 FT ³ 1.52 MT ³		shelf model in W55.5 D41 H41.5 MM W1410 D1041 H1054											
		OVERALL DIMENSIONS W D H			SEAT DIMENSIONS W D H			BACK DIMENSIONS W H					
		IN 55.5	30.5	41.5	52	19	18	52	23.5				
		MM 1410	775	1054	1321	483	457	1321	597				
		RTA 00 1 per carton											

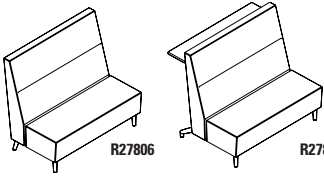
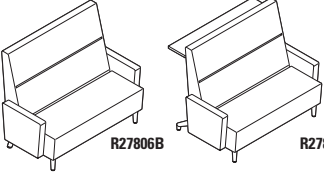
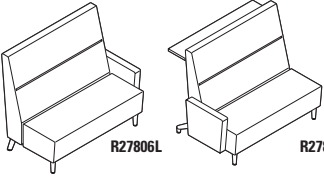
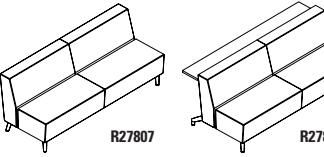
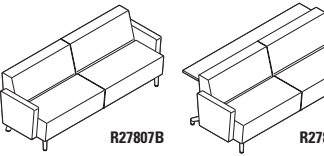
DESCRIPTION	FEATURES	MODEL#	STANDARD TEXTILE GRADES																																											
			1	2	3	4	5	6	7	8	9	10	11	12																																
 <p>Two Seater - Extended Back COM: 5.5 YD 5.03 M Unit weight: 106 LB 48.2 KG Carton weight: 71 LB 32.21 KG Carton volume: 24.75 FT³ 0.7 MT³</p>	<p>For power/USB unit, please see electrical placement chart.</p> <p>Includes ganging hardware (2 sides).</p> <p>Add \$123, \$71 for (S2), (SE) Add \$1067 for 72 lbs. (CW), (C6) Add \$119 for (SU) or \$476 for (BS) Add \$28 for (TP) Add \$161 for (MB)</p>	R27806	3117	3293	3442	3612	3893	4151	4410	4635	4916	5180	5537	6043																																
		R27806S	3678	3854	4003	4173	4454	4712	4971	5196	5477	5741	6098	6604																																
			shelf model IN W52 D41.5 H47 MM W1321 D1054 H1194																																											
			<table border="1"> <thead> <tr> <th colspan="3">OVERALL DIMENSIONS</th> <th colspan="3">SEAT DIMENSIONS</th> <th colspan="2">BACK DIMENSIONS</th> </tr> <tr> <th>W</th><th>D</th><th>H</th> <th>W</th><th>D</th><th>H</th> <th>W</th><th>H</th> </tr> </thead> <tbody> <tr> <td>IN 52</td><td>31</td><td>47</td> <td>52</td><td>19</td><td>18</td> <td>52</td><td>29</td> </tr> <tr> <td>MM 1321</td><td>787</td><td>1194</td> <td>1321</td><td>483</td><td>457</td> <td>1321</td><td>737</td> </tr> </tbody> </table>			OVERALL DIMENSIONS			SEAT DIMENSIONS			BACK DIMENSIONS		W	D	H	W	D	H	W	H	IN 52	31	47	52	19	18	52	29	MM 1321	787	1194	1321	483	457	1321	737									
OVERALL DIMENSIONS			SEAT DIMENSIONS			BACK DIMENSIONS																																								
W	D	H	W	D	H	W	H																																							
IN 52	31	47	52	19	18	52	29																																							
MM 1321	787	1194	1321	483	457	1321	737																																							
			<table border="1"> <thead> <tr> <th colspan="2">RTA 00</th> </tr> </thead> <tbody> <tr> <td>1 per carton</td> </tr> </tbody> </table>			RTA 00		1 per carton																																						
RTA 00																																														
1 per carton																																														
 <p>Two Seater - Extended Back w/Uph Arms COM: 8 YD 7.32 M Unit weight: 126 LB 57.3 KG Carton weight: 151 LB 68.49 KG Carton volume: 60.5 FT³ 1.71 MT³</p>	<p>For power/USB unit, please see electrical placement chart.</p> <p>Ganging not available.</p> <p>Add \$162, \$71 for (S2), (SE) Add \$1067 for 72 lbs. (CW), (C6) Add \$119 for (SU) or \$476 for (BS) Add \$28 for (TP) Add \$161 for (MB)</p>	R27806B	3711	3967	4183	4431	4839	5215	5591	5919	6327	6711	7231	7967																																
		R27806SB	4272	4528	4744	4992	5400	5776	6152	6480	6888	7272	7792	8528																																
			shelf model IN W59 D41.5 H47 MM W1499 D1054 H1194																																											
			<table border="1"> <thead> <tr> <th colspan="3">OVERALL DIMENSIONS</th> <th colspan="3">SEAT DIMENSIONS</th> <th colspan="2">BACK DIMENSIONS</th> </tr> <tr> <th>W</th><th>D</th><th>H</th> <th>W</th><th>D</th><th>H</th> <th>W</th><th>H</th> </tr> </thead> <tbody> <tr> <td>IN 59</td><td>31</td><td>47</td> <td>52</td><td>19</td><td>18</td> <td>52</td><td>29</td> </tr> <tr> <td>MM 1499</td><td>787</td><td>1194</td> <td>1321</td><td>483</td><td>457</td> <td>1321</td><td>737</td> </tr> </tbody> </table>			OVERALL DIMENSIONS			SEAT DIMENSIONS			BACK DIMENSIONS		W	D	H	W	D	H	W	H	IN 59	31	47	52	19	18	52	29	MM 1499	787	1194	1321	483	457	1321	737									
OVERALL DIMENSIONS			SEAT DIMENSIONS			BACK DIMENSIONS																																								
W	D	H	W	D	H	W	H																																							
IN 59	31	47	52	19	18	52	29																																							
MM 1499	787	1194	1321	483	457	1321	737																																							
			<table border="1"> <thead> <tr> <th colspan="2">RTA 00</th> </tr> </thead> <tbody> <tr> <td>1 per carton</td> </tr> </tbody> </table>			RTA 00		1 per carton																																						
RTA 00																																														
1 per carton																																														
 <p>Two Seater - Extended Back w/Uph Arms (Left/Right) COM: 7 YD 6.4 M Unit weight: 116 LB 52.7 KG Carton weight: 141 LB 63.96 KG Carton volume: 60.5 FT³ 1.71 MT³</p>	<p>For power/USB unit, please see electrical placement chart.</p> <p>Includes ganging hardware (1 side only).</p> <p>Add \$142, \$71 for (S2), (SE) Add \$1067 for 72 lbs. (CW), (C6) Add \$119 for (SU) or \$476 for (BS) Add \$28 for (TP) Add \$161 for (MB)</p>	R27806L	3414	3638	3827	4044	4401	4730	5059	5346	5703	6039	6494	7138																																
		R27806SR	3975	4199	4388	4605	4962	5291	5620	5907	6264	6600	7055	7699																																
			shelf model IN W55.5 D41.5 H47 MM W1410 D1054 H1194																																											
			<table border="1"> <thead> <tr> <th colspan="3">OVERALL DIMENSIONS</th> <th colspan="3">SEAT DIMENSIONS</th> <th colspan="2">BACK DIMENSIONS</th> </tr> <tr> <th>W</th><th>D</th><th>H</th> <th>W</th><th>D</th><th>H</th> <th>W</th><th>H</th> </tr> </thead> <tbody> <tr> <td>IN 55.5</td><td>31</td><td>47</td> <td>52</td><td>19</td><td>18</td> <td>52</td><td>29</td> </tr> <tr> <td>MM 1410</td><td>787</td><td>1194</td> <td>1321</td><td>483</td><td>457</td> <td>1321</td><td>737</td> </tr> </tbody> </table>			OVERALL DIMENSIONS			SEAT DIMENSIONS			BACK DIMENSIONS		W	D	H	W	D	H	W	H	IN 55.5	31	47	52	19	18	52	29	MM 1410	787	1194	1321	483	457	1321	737									
OVERALL DIMENSIONS			SEAT DIMENSIONS			BACK DIMENSIONS																																								
W	D	H	W	D	H	W	H																																							
IN 55.5	31	47	52	19	18	52	29																																							
MM 1410	787	1194	1321	483	457	1321	737																																							
			<table border="1"> <thead> <tr> <th colspan="2">RTA 00</th> </tr> </thead> <tbody> <tr> <td>1 per carton</td> </tr> </tbody> </table>			RTA 00		1 per carton																																						
RTA 00																																														
1 per carton																																														
 <p>Three Seater - Standard Back COM: 8 YD 7.32 M Unit weight: 120 LB 54.5 KG Carton weight: 152 LB 68.95 KG Carton volume: 55.5 FT³ 1.57 MT³</p>	<p>For power/USB unit, please see electrical placement chart.</p> <p>Includes ganging hardware (2 sides).</p> <p>Add \$101, \$84 for (S2), (SE) Add \$1067 for 72 lbs. (CW), (C6) Add \$179 for (SU) or \$655 for (BS) Add \$28 for (TP) Add \$243 for (MB)</p>	R27807	3783	4039	4256	4503	4912	5287	5664	5991	6400	6784	7303	8039																																
		R27807S	4531	4787	5004	5251	5660	6035	6412	6739	7148	7532	8051	8787																																
			shelf model IN W78 D40.5 H32 MM W1981 D1029 H813																																											
			<table border="1"> <thead> <tr> <th colspan="3">OVERALL DIMENSIONS</th> <th colspan="3">SEAT DIMENSIONS</th> <th colspan="2">BACK DIMENSIONS</th> </tr> <tr> <th>W</th><th>D</th><th>H</th> <th>W</th><th>D</th><th>H</th> <th>W</th><th>H</th> </tr> </thead> <tbody> <tr> <td>IN 78</td><td>30</td><td>32</td> <td>78</td><td>19</td><td>18</td> <td>78</td><td>14</td> </tr> <tr> <td>MM 1981</td><td>762</td><td>813</td> <td>1981</td><td>483</td><td>457</td> <td>1981</td><td>356</td> </tr> </tbody> </table>			OVERALL DIMENSIONS			SEAT DIMENSIONS			BACK DIMENSIONS		W	D	H	W	D	H	W	H	IN 78	30	32	78	19	18	78	14	MM 1981	762	813	1981	483	457	1981	356									
OVERALL DIMENSIONS			SEAT DIMENSIONS			BACK DIMENSIONS																																								
W	D	H	W	D	H	W	H																																							
IN 78	30	32	78	19	18	78	14																																							
MM 1981	762	813	1981	483	457	1981	356																																							
			<table border="1"> <thead> <tr> <th colspan="2">RTA 00</th> </tr> </thead> <tbody> <tr> <td>1 per carton</td> </tr> </tbody> </table>			RTA 00		1 per carton																																						
RTA 00																																														
1 per carton																																														
 <p>Three Seater - Standard Back w/Uph Arms COM: 10 YD 9.14 M Unit weight: 140 LB 63.6 KG Carton weight: 170 LB 77.11 KG Carton volume: 60.5 FT³ 1.71 MT³</p>	<p>For power/USB unit, please see electrical placement chart.</p> <p>Ganging not available.</p> <p>Add \$137, \$84 for (S2), (SE) Add \$1067 for 72 lbs. (CW), (C6) Add \$179 for (SU) or \$655 for (BS) Add \$28 for (TP) Add \$243 for (MB)</p>	R27807B	4377	4697	4968	5277	5788	6257	6728	7137	7648	8128	8777	9697																																
		R27807SB	5125	5445	5716	6025	6536	7005	7476	7885	8396	8876	9525	10445																																
			shelf model IN W85 D40.5 H32 MM W2159 D1029 H813																																											
			<table border="1"> <thead> <tr> <th colspan="3">OVERALL DIMENSIONS</th> <th colspan="3">SEAT DIMENSIONS</th> <th colspan="2">BACK DIMENSIONS</th> </tr> <tr> <th>W</th><th>D</th><th>H</th> <th>W</th><th>D</th><th>H</th> <th>W</th><th>H</th> </tr> </thead> <tbody> <tr> <td>IN 85</td><td>30</td><td>32</td> <td>78</td><td>19</td><td>18</td> <td>78</td><td>14</td> </tr> <tr> <td>MM 2159</td><td>762</td><td>813</td> <td>1981</td><td>483</td><td>457</td> <td>1981</td><td>356</td> </tr> </tbody> </table>			OVERALL DIMENSIONS			SEAT DIMENSIONS			BACK DIMENSIONS		W	D	H	W	D	H	W	H	IN 85	30	32	78	19	18	78	14	MM 2159	762	813	1981	483	457	1981	356									
OVERALL DIMENSIONS			SEAT DIMENSIONS			BACK DIMENSIONS																																								
W	D	H	W	D	H	W	H																																							
IN 85	30	32	78	19	18	78	14																																							
MM 2159	762	813	1981	483	457	1981	356																																							
			<table border="1"> <thead> <tr> <th colspan="2">RTA 00</th> </tr> </thead> <tbody> <tr> <td>1 per carton</td> </tr> </tbody> </table>			RTA 00		1 per carton																																						
RTA 00																																														
1 per carton																																														

DESCRIPTION FEATURES MODEL# STANDARD TEXTILE GRADES

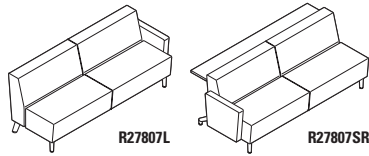

Three Seater - Standard Back w/Uph Arms (Left/Right)
 COM: 9 YD | 8.23 M
 Unit weight: 130 LB | 59.1 KG
 Carton weight: 160 LB | 72.57 KG
 Carton volume: 60.5 FT³ | 1.71 MT³

For power/USB unit, please see electrical placement chart.
 Includes ganging hardware (1 side only).
 Add \$120, \$84 for (S2), (SE)
 Add \$1067 for 72 lbs. (CW), (C6)
 Add \$179 for (SU) or \$655 for (BS)
 Add \$28 for (TP)
 Add \$243 for (MB)

	1	2	3	4	5	6	7	8	9	10	11	12
R27807L	4080	4368	4612	4890	5350	5772	6196	6564	7024	7456	8040	8868
R27807R												
R27807SL	4828	5116	5360	5638	6098	6520	6944	7312	7772	8204	8788	9616
R27807SR												

shelf model in W81.5 D40.5 H32 | MM W2070 D1029 H813

OVERALL DIMENSIONS			SEAT DIMENSIONS			BACK DIMENSIONS		
W	D	H	W	D	H	W	H	
IN 81.5	30	32	78	19	18	78	14	
MM 2070	762	813	1981	483	457	1981	356	

RTA 00 1 per carton

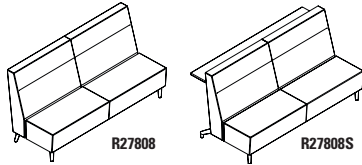

Three Seater - High Back
 COM: 9.25 YD | 8.46 M
 Unit weight: 138 LB | 62.7 KG
 Carton weight: 177 LB | 80.29 KG
 Carton volume: 69.75 FT³ | 1.97 MT³

For power/USB unit, please see electrical placement chart.
 Includes ganging hardware (2 sides).
 Add \$136, \$84 for (S2), (SE)
 Add \$1067 for 72 lbs. (CW), (C6)
 Add \$179 for (SU) or \$655 for (BS)
 Add \$28 for (TP)
 Add \$243 for (MB)

	1	2	3	4	5	6	7	8	9	10	11	12
R27808	4486	4782	5032	5319	5791	6225	6660	7039	7511	7955	8556	9407
R27808S	5234	5530	5780	6067	6539	6973	7408	7787	8259	8703	9304	10155

shelf model in W78 D41 H41.5 | MM W1981 D1041 H1054

OVERALL DIMENSIONS			SEAT DIMENSIONS			BACK DIMENSIONS		
W	D	H	W	D	H	W	H	
IN 78	30.5	41.5	78	19	18	78	23.5	
MM 1981	775	1054	1981	483	457	1981	597	

RTA 00 1 per carton

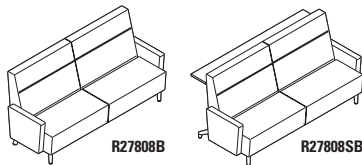

Three Seater - High Back w/Uph Arms
 COM: 11.25 YD | 10.29 M
 Unit weight: 158 LB | 71.8 KG
 Carton weight: 190.5 LB | 86.41 KG
 Carton volume: 69.75 FT³ | 1.97 MT³

For power/USB unit, please see electrical placement chart.
 Ganging not available.
 Add \$175, \$84 for (S2), (SE)
 Add \$1067 for 72 lbs. (CW), (C6)
 Add \$179 for (SU) or \$655 for (BS)
 Add \$28 for (TP)
 Add \$243 for (MB)

	1	2	3	4	5	6	7	8	9	10	11	12
R27808B	5080	5440	5744	6093	6667	7195	7724	8185	8759	9299	10030	11065
R27808SB	5828	6188	6492	6841	7415	7943	8472	8933	9507	10047	10778	11813

shelf model in W85 D41 H41.5 | MM W2159 D1041 H1054

OVERALL DIMENSIONS			SEAT DIMENSIONS			BACK DIMENSIONS		
W	D	H	W	D	H	W	H	
IN 85	30.5	41.5	78	19	18	78	23.5	
MM 2159	775	1054	1981	483	457	1981	597	

RTA 00 1 per carton

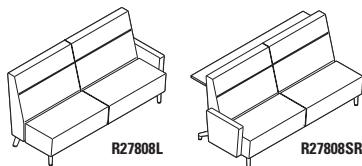

Three Seater - High Back w/Uph Arms (Left/Right)
 COM: 10.25 YD | 9.37 M
 Unit weight: 148 LB | 67.3 KG
 Carton weight: 180.5 LB | 81.87 KG
 Carton volume: 76.75 FT³ | 2.17 MT³

For power/USB unit, please see electrical placement chart.
 Includes ganging hardware (1 side only).
 Add \$155, \$84 for (S2), (SE)
 Add \$1067 for 72 lbs. (CW), (C6)
 Add \$179 for (SU) or \$655 for (BS)
 Add \$28 for (TP)
 Add \$243 for (MB)

	1	2	3	4	5	6	7	8	9	10	11	12
R27808L	4783	5111	5388	5706	6229	6710	7192	7612	8135	8627	9293	10236
R27808R												
R27808SL	5531	5859	6136	6454	6977	7458	7940	8360	8883	9375	10041	10984
R27808SR												

shelf model in W81.5 D41 H41.5 | MM W2070 D1041 H1054

OVERALL DIMENSIONS			SEAT DIMENSIONS			BACK DIMENSIONS		
W	D	H	W	D	H	W	H	
IN 81.5	30.5	41.5	78	19	18	78	23.5	
MM 2070	775	1054	1981	483	457	1981	597	

RTA 00 1 per carton

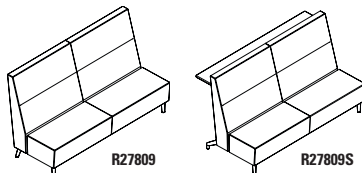

Three Seater - Extended Back
 COM: 10 YD | 9.14 M
 Unit weight: 135 LB | 61.4 KG
 Carton weight: 165 LB | 74.84 KG
 Carton volume: 79.25 FT³ | 2.24 MT³

For power/USB unit, please see electrical placement chart.
 Includes ganging hardware (2 sides).
 Add \$143, \$84 for (S2), (SE)
 Add \$1067 for 72 lbs. (CW), (C6)
 Add \$179 for (SU) or \$655 for (BS)
 Add \$28 for (TP)
 Add \$243 for (MB)

	1	2	3	4	5	6	7	8	9	10	11	12
R27809	4764	5084	5355	5664	6175	6644	7115	7524	8035	8515	9164	10084
R27809S	5512	5832	6103	6412	6923	7392	7863	8272	8783	9263	9912	10832

shelf model in W78 D41.5 H47 | MM W1981 D1054 H1194

OVERALL DIMENSIONS			SEAT DIMENSIONS			BACK DIMENSIONS		
W	D	H	W	D	H	W	H	
IN 78	31	47	78	19	18	78	29	
MM 1981	787	1194	1981	483	457	1981	737	

RTA 00 1 per carton

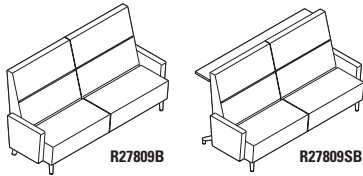
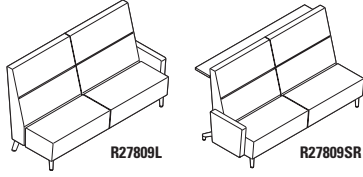
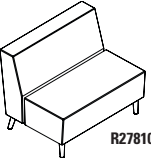
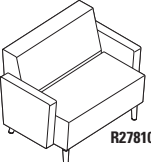
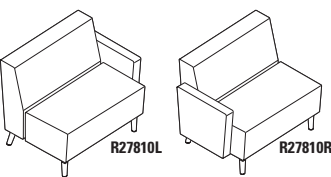
DESCRIPTION	FEATURES	MODEL#	STANDARD TEXTILE GRADES											
			1	2	3	4	5	6	7	8	9	10	11	12
 <p>R27809B R27809SB</p> <p>Three Seater - Extended Back w/Uph Arms COM: 12 YD 10.97 M Unit weight: 155 LB 70.5 KG Carton weight: 190 LB 86.18 KG Carton volume: 86.25 FT³ 2.44 MT³</p>	<p>For power/USB unit, please see electrical placement chart.</p> <p>Ganging not available.</p> <p>Add \$174, \$84 for (S2), (SE) Add \$1067 for 72 lbs. (CW), (C6) Add \$179 for (SU) or \$655 for (BS) Add \$28 for (TP) Add \$243 for (MB)</p>	<p>R27809B 5358 5742 6067 6438 7051 7614 8179 8670 9283 9859 10638 11742</p> <p>R27809SB 6106 6490 6815 7186 7799 8362 8927 9418 10031 10607 11386 12490</p> <p>shelf model in W85 D41.5 H47 MM W2159 D1054 H1194</p>	<p>OVERALL DIMENSIONS</p> <p>W D H</p>			<p>SEAT DIMENSIONS</p> <p>W D H</p>			<p>BACK DIMENSIONS</p> <p>W H</p>					
		<p>IN 85 31 47 78 19 18 78 29</p> <p>MM 2159 787 1194 1981 483 457 1981 737</p> <p>RTA 00 1 per carton</p>												
 <p>R27809L R27809SR</p> <p>Three Seater - Extended Back w/Uph Arms (Left/Right) COM: 11 YD 10.06 M Unit weight: 145 LB 65.9 KG Carton weight: 180 LB 81.65 KG Carton volume: 86.25 FT³ 2.44 MT³</p>	<p>For power/USB unit, please see electrical placement chart.</p> <p>Includes ganging hardware (1 side only).</p> <p>Add \$162, \$84 for (S2), (SE) Add \$1067 for 72 lbs. (CW), (C6) Add \$179 for (SU) or \$655 for (BS) Add \$28 for (TP) Add \$243 for (MB)</p>	<p>R27809L 5061 5413 5711 6051 6613 7129 7647 8097 8659 9187 9901 10913</p> <p>R27809R</p> <p>R27809SL 5809 6161 6459 6799 7361 7877 8395 8845 9407 9935 10649 11661</p> <p>R27809SR</p> <p>shelf model in W81.5 D41.5 H47 MM W2070 D1054 H1194</p>	<p>OVERALL DIMENSIONS</p> <p>W D H</p>			<p>SEAT DIMENSIONS</p> <p>W D H</p>			<p>BACK DIMENSIONS</p> <p>W H</p>					
		<p>IN 81.5 31 47 78 19 18 78 29</p> <p>MM 2070 787 1194 1981 483 457 1981 737</p> <p>RTA 00 1 per carton</p>												
 <p>R27810</p> <p>Bariatric Lounge Chair - Standard Back COM: 4.25 YD 3.89 M Unit weight: 69 LB 31.4 KG Carton weight: 90 LB 40.82 KG Carton volume: 28.75 FT³ 0.81 MT³</p>	<p>For power/USB unit, please see electrical placement chart.</p> <p>Includes ganging hardware (2 sides).</p> <p>Add \$61, \$52 for (S2), (SE) Add \$533 for 36 lbs. (CW), (C6) Add \$83 for (SU) or \$387 for (BS) Add \$28 for (TP) Add \$122 for (MB)</p>	<p>R27810 2303 2439 2554 2686 2902 3102 3302 3476 3693 3897 4173 4564</p>	<p>OVERALL DIMENSIONS</p> <p>W D H</p>			<p>SEAT DIMENSIONS</p> <p>W D H</p>			<p>BACK DIMENSIONS</p> <p>W H</p>					
		<p>IN 39 30 32 39 19 18 39 14</p> <p>MM 991 762 813 991 483 457 991 356</p> <p>RTA 00 1 per carton</p>												
 <p>R27810B</p> <p>Bariatric Lounge Chair - Standard Back w/Uph Arms COM: 6.25 YD 5.72 M Unit weight: 89 LB 40.5 KG Carton weight: 108 LB 48.99 KG Carton volume: 33 FT³ 0.93 MT³</p>	<p>For power/USB unit, please see electrical placement chart.</p> <p>Ganging not available.</p> <p>Add \$102, \$52 for (S2), (SE) Add \$533 for 36 lbs. (CW) Add \$83 for (SU) or \$387 for (BS) Add \$28 for (TP) Add \$122 for (MB)</p>	<p>R27810B 2897 3097 3266 3460 3778 4072 4366 4622 4941 5241 5647 6222</p>	<p>OVERALL DIMENSIONS</p> <p>W D H</p>			<p>SEAT DIMENSIONS</p> <p>W D H</p>			<p>BACK DIMENSIONS</p> <p>W H</p>					
		<p>IN 46 30 32 39 19 18 39 14</p> <p>MM 1168 762 813 991 483 457 991 356</p> <p>RTA 00 1 per carton</p>												
 <p>R27810L R27810R</p> <p>Bariatric Lounge Chair - Standard Back w/Uph Arms (Left/Right) COM: 5.25 YD 4.8 M Unit weight: 79 LB 35.9 KG Carton weight: 98 LB 44.45 KG Carton volume: 33 FT³ 0.93 MT³</p>	<p>For power/USB unit, please see electrical placement chart.</p> <p>Includes ganging hardware (1 side only).</p> <p>Add \$82, \$52 for (S2), (SE) Add \$533 for 36 lbs. (CW) Add \$83 for (SU) or \$387 for (BS) Add \$28 for (TP) Add \$122 for (MB)</p>	<p>R27810L 2600 2768 2910 3073 3340 3587 3834 4049 4317 4569 4910 5393</p> <p>R27810R</p>	<p>OVERALL DIMENSIONS</p> <p>W D H</p>			<p>SEAT DIMENSIONS</p> <p>W D H</p>			<p>BACK DIMENSIONS</p> <p>W H</p>					
		<p>IN 42.5 30 32 39 19 18 39 14</p> <p>MM 1080 762 813 991 483 457 991 356</p> <p>RTA 00 1 per carton</p>												

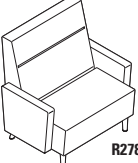
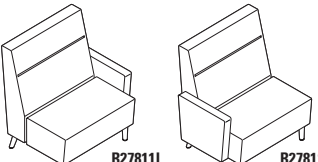
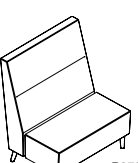
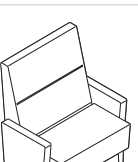
DESCRIPTION	FEATURES	MODEL#	STANDARD TEXTILE GRADES													
			1	2	3	4	5	6	7	8	9	10	11	12		
 <p>R27811</p> <p>Bariatric Lounge Chair - High Back COM: 4.75 YD 4.34 M Unit weight: 77 LB 35 KG Carton weight: 98 LB 44.45 KG Carton volume: 36 FT³ 1.01 MT³</p>	<p>For power/USB unit, please see electrical placement chart.</p> <p>Includes ganging hardware (2 sides).</p> <p>Add \$81, \$52 for (S2), (SE) Add \$533 for 36 lbs. (CW) Add \$83 for (SU) or \$387 for (BS) Add \$28 for (TP) Add \$122 for (MB)</p>	R27811	2585	2737	2865	3013	3255	3478	3701	3896	4138	4366	4675	5112		
		OVERALL DIMENSIONS			SEAT DIMENSIONS			BACK DIMENSIONS								
		W D H			W D H			W H								
		IN 39 30.5 41.5 MM 991 775 1054			39 19 18 991 483 457			39 23.5 991 597								
			RTA 00			1 per carton										
 <p>R27811B</p> <p>Bariatric Lounge Chair - High Back w/Uph Arms COM: 6.75 YD 6.17 M Unit weight: 97 LB 44.1 KG Carton weight: 117.5 LB 53.3 KG Carton volume: 42.25 FT³ 1.19 MT³</p>	<p>For power/USB unit, please see electrical placement chart.</p> <p>Ganging not available.</p> <p>Add \$120, \$52 for (S2), (SE) Add \$533 for 36 lbs. (CW) Add \$83 for (SU) or \$387 for (BS) Add \$28 for (TP) Add \$122 for (MB)</p>	R27811B	3179	3395	3577	3787	4131	4448	4765	5042	5386	5710	6149	6770		
		OVERALL DIMENSIONS			SEAT DIMENSIONS			BACK DIMENSIONS								
		W D H			W D H			W H								
		IN 46 30.5 41.5 MM 1168 775 1054			39 19 18 991 483 457			39 23.5 991 597								
			RTA 00			1 per carton										
 <p>R27811L R27811R</p> <p>Bariatric Lounge Chair - High Back w/Uph Arms (Left/Right) COM: 5.75 YD 5.26 M Unit weight: 87 LB 39.5 KG Carton weight: 107.5 LB 48.76 KG Carton volume: 42.25 FT³ 1.19 MT³</p>	<p>For power/USB unit, please see electrical placement chart.</p> <p>Includes ganging hardware (1 side only).</p> <p>Add \$100, \$52 for (S2), (SE) Add \$533 for 36 lbs. (CW) Add \$83 for (SU) or \$387 for (BS) Add \$28 for (TP) Add \$122 for (MB)</p>	R27811L	2882	3066	3221	3400	3693	3963	4233	4469	4762	5038	5412	5941		
		OVERALL DIMENSIONS			SEAT DIMENSIONS			BACK DIMENSIONS								
		W D H			W D H			W H								
		IN 42.5 30.5 41.5 MM 1080 775 1054			39 19 18 991 483 457			39 23.5 991 597								
			RTA 00			1 per carton										
 <p>R27812</p> <p>Bariatric Lounge Chair - Extended Back COM: 5.25 YD 4.8 M Unit weight: 91 LB 41.4 KG Carton weight: 115 LB 52.16 KG Carton volume: 41 FT³ 1.16 MT³</p>	<p>For power/USB unit, please see electrical placement chart.</p> <p>Includes ganging hardware (2 sides).</p> <p>Add \$85, \$52 for (S2), (SE) Add \$533 for 36 lbs. (CW) Add \$83 for (SU) or \$387 for (BS) Add \$28 for (TP) Add \$122 for (MB)</p>	R27812	2697	2865	3007	3170	3437	3684	3931	4146	4414	4666	5007	5490		
		OVERALL DIMENSIONS			SEAT DIMENSIONS			BACK DIMENSIONS								
		W D H			W D H			W H								
		IN 39 31 47 MM 991 787 1194			39 19 18 991 483 457			39 29 991 737								
			RTA 00			1 per carton										
 <p>R27812B</p> <p>Bariatric Lounge Chair - Extended Back w/Uph Arms COM: 7.25 YD 6.63 M Unit weight: 111 LB 50.5 KG Carton weight: 132.5 LB 60.1 KG Carton volume: 47.25 FT³ 1.33 MT³</p>	<p>For power/USB unit, please see electrical placement chart.</p> <p>Ganging not available.</p> <p>Add \$127, \$52 for (S2), (SE) Add \$533 for 36 lbs. (CW) Add \$83 for (SU) or \$387 for (BS) Add \$28 for (TP) Add \$122 for (MB)</p>	R27812B	3291	3523	3719	3944	4313	4654	4995	5292	5662	6010	6481	7148		
		OVERALL DIMENSIONS			SEAT DIMENSIONS			BACK DIMENSIONS								
		W D H			W D H			W H								
		IN 46 31 47 MM 1168 787 1194			39 19 18 991 483 457			39 29 991 737								
			RTA 00			1 per carton										

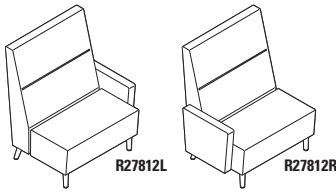
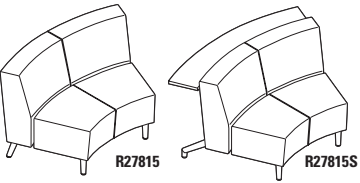
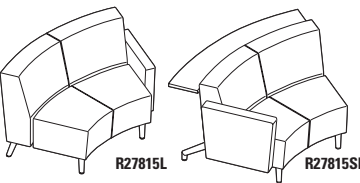
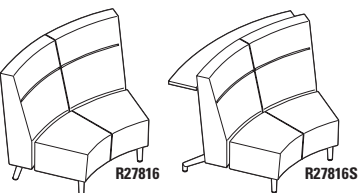
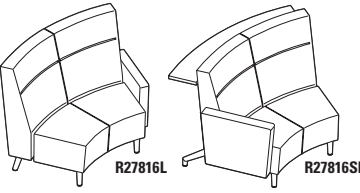
DESCRIPTION	FEATURES	MODEL#	STANDARD TEXTILE GRADES																					
			1	2	3	4	5	6	7	8	9	10	11	12										
 <p>Bariatric Lounge Chair - Extended Back w/Uph Arms (Left/Right) COM: 6.25 YD 5.72 M Unit weight: 101 LB 45.9 KG Carton weight: 122.5 LB 55.57 KG Carton volume: 47.25 FT³ 1.33 MT³</p>	<p>For power/USB unit, please see electrical placement chart.</p> <p>Includes ganging hardware (1 side only).</p> <p>Add \$106, \$52 for (S2), (SE) Add \$533 for 36 lbs. (CW) Add \$83 for (SU) or \$387 for (BS) Add \$28 for (TP) Add \$122 for (MB)</p>	R27812L	2994	3194	3363	3557	3875	4169	4463	4719	5038	5338	5744	6319										
		<p>OVERALL DIMENSIONS</p> <table border="1"> <tr> <th>W</th> <th>D</th> <th>H</th> <th>W</th> <th>D</th> <th>H</th> <th>W</th> <th>H</th> </tr> <tr> <td>IN 42.5</td> <td>31</td> <td>47</td> <td>39</td> <td>19</td> <td>18</td> <td>39</td> <td>29</td> </tr> <tr> <td>MM 1080</td> <td>787</td> <td>1194</td> <td>991</td> <td>483</td> <td>457</td> <td>991</td> <td>737</td> </tr> </table> <p>RTA 00 1 per carton</p>	W	D	H	W	D	H	W	H	IN 42.5	31	47	39	19	18	39	29	MM 1080	787	1194	991	483	457
W	D	H	W	D	H	W	H																	
IN 42.5	31	47	39	19	18	39	29																	
MM 1080	787	1194	991	483	457	991	737																	
 <p>IS Curve Two Seater - Standard Back COM: 5 YD 4.57 M Unit weight: 67 LB 30.5 KG Carton weight: 93 LB 42.18 KG Carton volume: 42.75 FT³ 1.21 MT³</p>	<p>For power/USB unit, please see electrical placement chart.</p> <p>Includes ganging hardware (2 sides).</p> <p>Add \$85, \$61 for (S2), (SE) Add \$1067 for 72 lbs. (CW), (C6) Add \$108 for (SU) or \$446 for (BS) Add \$35 for (TP) Add \$161 for (MB)</p>	R27815	2643	2803	2938	3093	3348	3583	3818	4023	4278	4518	4843	5303										
		<p>R27815S</p> <p>shelf model IN W58 D40.5 H32 MM W1473 D1029 H813</p> <p>OVERALL DIMENSIONS</p> <table border="1"> <tr> <th>W</th> <th>D</th> <th>H</th> <th>W</th> <th>D</th> <th>H</th> <th>W</th> <th>H</th> </tr> <tr> <td>IN 50.5</td> <td>30</td> <td>32</td> <td>42</td> <td>19</td> <td>18</td> <td>51</td> <td>14</td> </tr> <tr> <td>MM 1283</td> <td>762</td> <td>813</td> <td>1067</td> <td>483</td> <td>457</td> <td>1295</td> <td>356</td> </tr> </table> <p>RTA 00 1 per carton</p>	W	D	H	W	D	H	W	H	IN 50.5	30	32	42	19	18	51	14	MM 1283	762	813	1067	483	457
W	D	H	W	D	H	W	H																	
IN 50.5	30	32	42	19	18	51	14																	
MM 1283	762	813	1067	483	457	1295	356																	
 <p>IS Curve Two Seater - Standard Back w/Uph Arms (Left/Right) COM: 6 YD 5.49 M Unit weight: 77 LB 35 KG Carton weight: 102 LB 46.27 KG Carton volume: 43.5 FT³ 1.23 MT³</p>	<p>For power/USB unit, please see electrical placement chart.</p> <p>Includes ganging hardware (1 side only).</p> <p>Add \$106, \$61 for (S2), (SE) Add \$1067 for 72 lbs. (CW), (C6) Add \$108 for (SU) or \$446 for (BS) Add \$35 for (TP) Add \$161 for (MB)</p>	R27815L	2940	3132	3294	3480	3786	4068	4350	4596	4902	5190	5580	6132										
		<p>R27815SR</p> <p>shelf model IN W61.5 D40.5 H32 MM W1562 D1029 H813</p> <p>OVERALL DIMENSIONS</p> <table border="1"> <tr> <th>W</th> <th>D</th> <th>H</th> <th>W</th> <th>D</th> <th>H</th> <th>W</th> <th>H</th> </tr> <tr> <td>IN 54</td> <td>30</td> <td>32</td> <td>42</td> <td>19</td> <td>18</td> <td>51</td> <td>14</td> </tr> <tr> <td>MM 1372</td> <td>762</td> <td>813</td> <td>1067</td> <td>483</td> <td>457</td> <td>1295</td> <td>356</td> </tr> </table> <p>RTA 00 1 per carton</p>	W	D	H	W	D	H	W	H	IN 54	30	32	42	19	18	51	14	MM 1372	762	813	1067	483	457
W	D	H	W	D	H	W	H																	
IN 54	30	32	42	19	18	51	14																	
MM 1372	762	813	1067	483	457	1295	356																	
 <p>IS Curve Two Seater - High Back COM: 5.5 YD 5.03 M Unit weight: 78 LB 35.5 KG Carton weight: 106 LB 48.08 KG Carton volume: 53.75 FT³ 1.52 MT³</p>	<p>For power/USB unit, please see electrical placement chart.</p> <p>Includes ganging hardware (2 sides).</p> <p>Add \$115, \$61 for (S2), (SE) Add \$1067 for 72 lbs. (CW), (C6) Add \$108 for (SU) or \$446 for (BS) Add \$35 for (TP) Add \$161 for (MB)</p>	R27816	3185	3361	3510	3680	3961	4219	4478	4703	4984	5248	5605	6111										
		<p>R27816S</p> <p>shelf model IN W58.5 D41 H41.5 MM W1486 D1041 H1054</p> <p>OVERALL DIMENSIONS</p> <table border="1"> <tr> <th>W</th> <th>D</th> <th>H</th> <th>W</th> <th>D</th> <th>H</th> <th>W</th> <th>H</th> </tr> <tr> <td>IN 51</td> <td>30.5</td> <td>41.5</td> <td>42</td> <td>19</td> <td>18</td> <td>51</td> <td>23.5</td> </tr> <tr> <td>MM 1295</td> <td>775</td> <td>1054</td> <td>1067</td> <td>483</td> <td>457</td> <td>1295</td> <td>597</td> </tr> </table> <p>RTA 00 1 per carton</p>	W	D	H	W	D	H	W	H	IN 51	30.5	41.5	42	19	18	51	23.5	MM 1295	775	1054	1067	483	457
W	D	H	W	D	H	W	H																	
IN 51	30.5	41.5	42	19	18	51	23.5																	
MM 1295	775	1054	1067	483	457	1295	597																	
 <p>IS Curve Two Seater - High Back w/Uph Arms (Left/Right) COM: 6.5 YD 5.94 M Unit weight: 88 LB 40 KG Carton weight: 115 LB 52.16 KG Carton volume: 55.5 FT³ 1.57 MT³</p>	<p>For power/USB unit, please see electrical placement chart.</p> <p>Includes ganging hardware (1 side only).</p> <p>Add \$134, \$61 for (S2), (SE) Add \$1067 for 72 lbs. (CW), (C6) Add \$108 for (SU) or \$446 for (BS) Add \$35 for (TP) Add \$161 for (MB)</p>	R27816L	3482	3690	3866	4067	4399	4704	5010	5276	5608	5920	6342	6940										
		<p>R27816SR</p> <p>shelf model IN W62 D41 H41.5 MM W1575 D1041 H1054</p> <p>OVERALL DIMENSIONS</p> <table border="1"> <tr> <th>W</th> <th>D</th> <th>H</th> <th>W</th> <th>D</th> <th>H</th> <th>W</th> <th>H</th> </tr> <tr> <td>IN 54.5</td> <td>30.5</td> <td>41.5</td> <td>42</td> <td>19</td> <td>18</td> <td>51</td> <td>23.5</td> </tr> <tr> <td>MM 1384</td> <td>775</td> <td>1054</td> <td>1067</td> <td>483</td> <td>457</td> <td>1295</td> <td>597</td> </tr> </table> <p>RTA 00 1 per carton</p>	W	D	H	W	D	H	W	H	IN 54.5	30.5	41.5	42	19	18	51	23.5	MM 1384	775	1054	1067	483	457
W	D	H	W	D	H	W	H																	
IN 54.5	30.5	41.5	42	19	18	51	23.5																	
MM 1384	775	1054	1067	483	457	1295	597																	

DESCRIPTION FEATURES MODEL# STANDARD TEXTILE GRADES

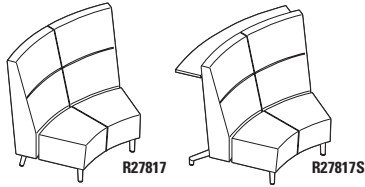

IS Curve Two Seater - Extended Back
 COM: 6 YD | 5.49 M
 Unit weight: 84 LB | 38.2 KG
 Carton weight: 118 LB | 53.52 KG
 Carton volume: 61 FT³ | 1.72 MT³

For power/USB unit, please see electrical placement chart.
 Includes ganging hardware (2 sides).
 Add \$123, \$61 for (S2), (SE)
 Add \$1067 for 72 lbs. (CW), (C6)
 Add \$108 for (SU) or \$446 for (BS)
 Add \$35 for (TP)
 Add \$161 for (MB)

	1	2	3	4	5	6	7	8	9	10	11	12
R27817	3498	3690	3852	4038	4344	4626	4908	5154	5460	5748	6138	6690
R27817S	4414	4606	4768	4954	5260	5542	5824	6070	6376	6664	7054	7606

shelf model in W59 D41.5 H47 | MM W1499 D1054 H1194

OVERALL DIMENSIONS			SEAT DIMENSIONS			BACK DIMENSIONS		
W	D	H	W	D	H	W	H	
IN 51.5	31	47	42	19	18	51	29	
MM 1308	787	1194	1067	483	457	1295	737	

RTA 00 1 per carton

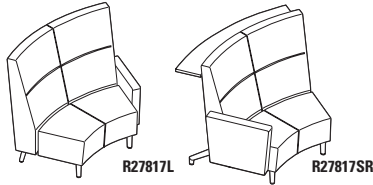

IS Curve Two Seater - Extended Back w/Uph Arms (Left/Right)
 COM: 7 YD | 6.4 M
 Unit weight: 94 LB | 42.7 KG
 Carton weight: 122 LB | 55.34 KG
 Carton volume: 62.25 FT³ | 1.76 MT³

For power/USB unit, please see electrical placement chart.
 Includes ganging hardware (1 side only).
 Add \$142, \$61 for (S2), (SE)
 Add \$1067 for 72 lbs. (CW), (C6)
 Add \$108 for (SU) or \$446 for (BS)
 Add \$35 for (TP)
 Add \$161 for (MB)

	1	2	3	4	5	6	7	8	9	10	11	12
R27817L	3795	4019	4208	4425	4782	5111	5440	5727	6084	6420	6875	7519
R27817R												
R27817SL	4711	4935	5124	5341	5698	6027	6356	6643	7000	7336	7791	8435
R27817SR												

shelf model in W62.5 D41.5 H47 | MM W1588 D1054 H1194

OVERALL DIMENSIONS			SEAT DIMENSIONS			BACK DIMENSIONS		
W	D	H	W	D	H	W	H	
IN 54	31	47	42	19	18	51	29	
MM 1372	787	1194	1067	483	457	1295	737	

RTA 00 1 per carton

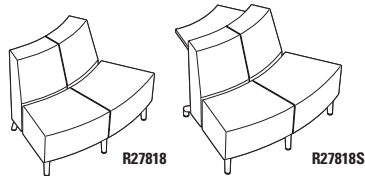

OS Curve Two Seater - Standard Back
 COM: 4.25 YD | 3.89 M
 Unit weight: 67 LB | 30.5 KG
 Carton weight: 93 LB | 42.18 KG
 Carton volume: 42.75 FT³ | 1.21 MT³

For power/USB unit, please see electrical placement chart.
 Includes ganging hardware (2 sides).
 Add \$75, \$68 for (S2), (SE)
 Add \$1067 for 72 lbs. (CW), (C6)
 Add \$108 for (SU) or \$536 for (BS)
 Add \$35 for (TP)
 Add \$161 for (MB)

	1	2	3	4	5	6	7	8	9	10	11	12
R27818	2699	2835	2950	3082	3298	3498	3698	3872	4089	4293	4569	4960
R27818S	3198	3334	3449	3581	3797	3997	4197	4371	4588	4792	5068	5459

shelf model in W50 D40.5 H32 | MM W1270 D1029 H813

OVERALL DIMENSIONS			SEAT DIMENSIONS			BACK DIMENSIONS		
W	D	H	W	D	H	W	H	
IN 50	30	32	50	19	18	36	14	
MM 1270	762	813	1270	483	457	914	356	

RTA 00 1 per carton

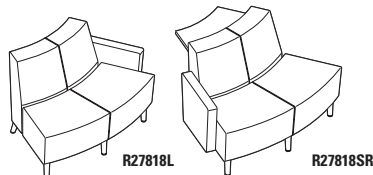

OS Curve Two Seater - Standard Back w/Uph Arms (Left/Right)
 COM: 5.25 YD | 4.8 M
 Unit weight: 77 LB | 35 KG
 Carton weight: 102 LB | 46.27 KG
 Carton volume: 43.5 FT³ | 1.23 MT³

For power/USB unit, please see electrical placement chart.
 Includes ganging hardware (1 side only).
 Add \$96, \$68 for (S2), (SE)
 Add \$1067 for 72 lbs. (CW), (C6)
 Add \$108 for (SU) or \$536 for (BS)
 Add \$35 for (TP)
 Add \$161 for (MB)

	1	2	3	4	5	6	7	8	9	10	11	12
R27818L	2996	3164	3306	3469	3736	3983	4230	4445	4713	4965	5306	5789
R27818R												
R27818SL	3495	3663	3805	3968	4235	4482	4729	4944	5212	5464	5805	6288
R27818SR												

shelf model in W53.5 D40.5 H32 | MM W1359 D1029 H813

OVERALL DIMENSIONS			SEAT DIMENSIONS			BACK DIMENSIONS		
W	D	H	W	D	H	W	H	
IN 53.5	30	32	50	19	18	36	14	
MM 1359	762	813	1270	483	457	914	356	

RTA 00 1 per carton

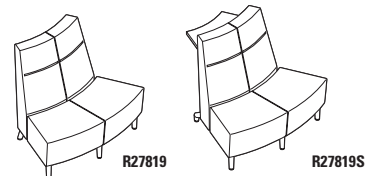

OS Curve Two Seater - High Back
 COM: 5.25 YD | 4.8 M
 Unit weight: 73 LB | 33.2 KG
 Carton weight: 101 LB | 45.81 KG
 Carton volume: 53.75 FT³ | 1.52 MT³

For power/USB unit, please see electrical placement chart.
 Includes ganging hardware (2 sides).
 Add \$99, \$68 for (S2), (SE)
 Add \$1067 for 72 lbs. (CW), (C6)
 Add \$108 for (SU) or \$536 for (BS)
 Add \$35 for (TP)
 Add \$161 for (MB)

	1	2	3	4	5	6	7	8	9	10	11	12
R27819	3242	3410	3552	3715	3982	4229	4476	4691	4959	5211	5552	6035
R27819S	3741	3909	4051	4214	4481	4728	4975	5190	5458	5710	6051	6534

shelf model in W50 D41 H41.5 | MM W1270 D1041 H1054

OVERALL DIMENSIONS			SEAT DIMENSIONS			BACK DIMENSIONS		
W	D	H	W	D	H	W	H	
IN 50	30.5	41.5	50	19	18	32	23.5	
MM 1270	775	1054	1270	483	457	813	597	

RTA 00 1 per carton

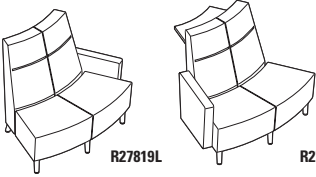
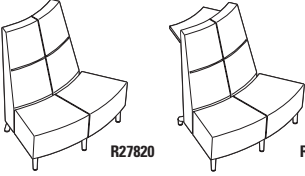
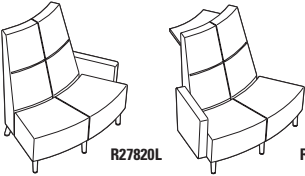
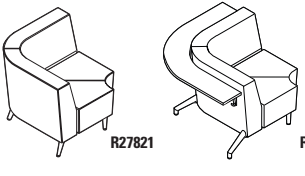
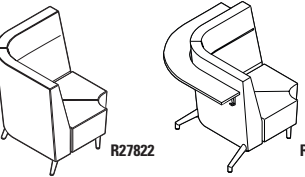
DESCRIPTION	FEATURES	MODEL#	STANDARD TEXTILE GRADES																																								
			1	2	3	4	5	6	7	8	9	10	11	12																													
 <p>OS Curve Two Seater - High Back w/Uph Arms (Left/Right) COM: 6.25 YD 5.72 M Unit weight: 83 LB 37.7 KG Carton weight: 110 LB 49.9 KG Carton volume: 55.5 FT³ 1.57 MT³</p>	<p>For power/USB unit, please see electrical placement chart.</p> <p>Includes ganging hardware (1 side only).</p> <p>Add \$118, \$68 for (S2), (SE) Add \$1067 for 72 lbs. (CW), (C6) Add \$108 for (SU) or \$536 for (BS) Add \$35 for (TP) Add \$161 for (MB)</p>	<p>R27819L 3539 3739 3908 4102 4420 4714 5008 5264 5583 5883 6289 6864</p> <p>R27819R 4038 4238 4407 4601 4919 5213 5507 5763 6082 6382 6788 7363</p> <p>R27819SL</p> <p>R27819SR</p> <p>shelf model IN W53.5 D41 H41.5 MM W1359 D1041 H1054</p>																																									
		<p>OVERALL DIMENSIONS</p> <table border="1"> <thead> <tr> <th>W</th> <th>D</th> <th>H</th> <th colspan="3">SEAT DIMENSIONS</th> <th colspan="2">BACK DIMENSIONS</th> </tr> <tr> <th>W</th> <th>D</th> <th>H</th> <th>W</th> <th>D</th> <th>H</th> <th>W</th> <th>H</th> </tr> </thead> <tbody> <tr> <td>IN 53.5</td> <td>30.5</td> <td>41.5</td> <td>50</td> <td>19</td> <td>18</td> <td>32</td> <td>23.5</td> </tr> <tr> <td>MM 1359</td> <td>775</td> <td>1054</td> <td>1270</td> <td>483</td> <td>457</td> <td>813</td> <td>597</td> </tr> </tbody> </table> <p>RTA 00 1 per carton</p>	W	D	H	SEAT DIMENSIONS			BACK DIMENSIONS		W	D	H	W	D	H	W	H	IN 53.5	30.5	41.5	50	19	18	32	23.5	MM 1359	775	1054	1270	483	457	813	597									
W	D	H	SEAT DIMENSIONS			BACK DIMENSIONS																																					
W	D	H	W	D	H	W	H																																				
IN 53.5	30.5	41.5	50	19	18	32	23.5																																				
MM 1359	775	1054	1270	483	457	813	597																																				
 <p>OS Curve Two Seater - Extended Back COM: 6.25 YD 5.72 M Unit weight: 75 LB 34.1 KG Carton weight: 109 LB 49.44 KG Carton volume: 61 FT³ 1.72 MT³</p>	<p>For power/USB unit, please see electrical placement chart.</p> <p>Includes ganging hardware (2 sides).</p> <p>Add \$104, \$68 for (S2), (SE) Add \$1067 for 72 lbs. (CW), (C6) Add \$108 for (SU) or \$536 for (BS) Add \$35 for (TP) Add \$161 for (MB)</p>	<p>R27820 3553 3753 3922 4116 4434 4728 5022 5278 5597 5897 6303 6878</p> <p>R27820S 4052 4252 4421 4615 4933 5227 5521 5777 6096 6396 6802 7377</p> <p>shelf model IN W50 D41.5 H47 MM W1270 D1054 H1194</p>																																									
		<p>OVERALL DIMENSIONS</p> <table border="1"> <thead> <tr> <th>W</th> <th>D</th> <th>H</th> <th colspan="3">SEAT DIMENSIONS</th> <th colspan="2">BACK DIMENSIONS</th> </tr> <tr> <th>W</th> <th>D</th> <th>H</th> <th>W</th> <th>D</th> <th>H</th> <th>W</th> <th>H</th> </tr> </thead> <tbody> <tr> <td>IN 50</td> <td>31</td> <td>47</td> <td>50</td> <td>19</td> <td>18</td> <td>28</td> <td>29</td> </tr> <tr> <td>MM 1270</td> <td>787</td> <td>1194</td> <td>1270</td> <td>483</td> <td>457</td> <td>711</td> <td>737</td> </tr> </tbody> </table> <p>RTA 00 1 per carton</p>	W	D	H	SEAT DIMENSIONS			BACK DIMENSIONS		W	D	H	W	D	H	W	H	IN 50	31	47	50	19	18	28	29	MM 1270	787	1194	1270	483	457	711	737									
W	D	H	SEAT DIMENSIONS			BACK DIMENSIONS																																					
W	D	H	W	D	H	W	H																																				
IN 50	31	47	50	19	18	28	29																																				
MM 1270	787	1194	1270	483	457	711	737																																				
 <p>OS Curve Two Seater - Extended Back w/Uph Arms (Left/Right) COM: 7.25 YD 6.63 M Unit weight: 85 LB 38.6 KG Carton weight: 113 LB 51.26 KG Carton volume: 62.25 FT³ 1.76 MT³</p>	<p>For power/USB unit, please see electrical placement chart.</p> <p>Includes ganging hardware (1 side only).</p> <p>Add \$126, \$68 for (S2), (SE) Add \$1067 for 72 lbs. (CW), (C6) Add \$108 for (SU) or \$536 for (BS) Add \$35 for (TP) Add \$161 for (MB)</p>	<p>R27820L 3850 4082 4278 4503 4872 5213 5554 5851 6221 6569 7040 7707</p> <p>R27820R 4349 4581 4777 5002 5371 5712 6053 6350 6720 7068 7539 8206</p> <p>R27820SL</p> <p>R27820SR</p> <p>shelf model IN W53.5 D41.5 H47 MM W1359 D1054 H1194</p>																																									
		<p>OVERALL DIMENSIONS</p> <table border="1"> <thead> <tr> <th>W</th> <th>D</th> <th>H</th> <th colspan="3">SEAT DIMENSIONS</th> <th colspan="2">BACK DIMENSIONS</th> </tr> <tr> <th>W</th> <th>D</th> <th>H</th> <th>W</th> <th>D</th> <th>H</th> <th>W</th> <th>H</th> </tr> </thead> <tbody> <tr> <td>IN 53.5</td> <td>31</td> <td>47</td> <td>50</td> <td>19</td> <td>18</td> <td>28</td> <td>29</td> </tr> <tr> <td>MM 1359</td> <td>787</td> <td>1194</td> <td>1270</td> <td>483</td> <td>457</td> <td>711</td> <td>737</td> </tr> </tbody> </table> <p>RTA 00 1 per carton</p>	W	D	H	SEAT DIMENSIONS			BACK DIMENSIONS		W	D	H	W	D	H	W	H	IN 53.5	31	47	50	19	18	28	29	MM 1359	787	1194	1270	483	457	711	737									
W	D	H	SEAT DIMENSIONS			BACK DIMENSIONS																																					
W	D	H	W	D	H	W	H																																				
IN 53.5	31	47	50	19	18	28	29																																				
MM 1359	787	1194	1270	483	457	711	737																																				
 <p>90° Corner - Standard Back COM: 6 YD 5.49 M Unit weight: 79 LB 35.9 KG Carton weight: 105 LB 47.63 KG Carton volume: 35.5 FT³ 1 MT³</p>	<p>No power/USB unit.</p> <p>Includes ganging hardware (2 sides).</p> <p>Add \$95, \$47 for (S2), (SE) Add \$533 for 36 lbs. (CW), (C6) Add \$108 for (SU) or \$536 for (BS) Add \$35 for (TP) Add \$161 for (MB)</p>	<p>R27821 3676 3868 4030 4216 4522 4804 5086 5332 5638 5926 6316 6868</p> <p>R27821S 4674 4866 5028 5214 5520 5802 6084 6330 6636 6924 7314 7866</p> <p>shelf model IN W48.5 D48.5 H32 MM W1232 D1232 H813</p>																																									
		<p>OVERALL DIMENSIONS</p> <table border="1"> <thead> <tr> <th>W</th> <th>D</th> <th>H</th> <th colspan="3">SEAT DIMENSIONS</th> <th colspan="2">BACK DIMENSIONS</th> </tr> <tr> <th>W</th> <th>D</th> <th>H</th> <th>W</th> <th>D</th> <th>H</th> <th>W</th> <th>H</th> </tr> </thead> <tbody> <tr> <td>IN 37.5</td> <td>37.5</td> <td>32</td> <td>24</td> <td>19</td> <td>18</td> <td>24</td> <td>14</td> </tr> <tr> <td>MM 953</td> <td>953</td> <td>813</td> <td>610</td> <td>483</td> <td>457</td> <td>610</td> <td>356</td> </tr> </tbody> </table> <p>RTA 00 1 per carton</p>	W	D	H	SEAT DIMENSIONS			BACK DIMENSIONS		W	D	H	W	D	H	W	H	IN 37.5	37.5	32	24	19	18	24	14	MM 953	953	813	610	483	457	610	356									
W	D	H	SEAT DIMENSIONS			BACK DIMENSIONS																																					
W	D	H	W	D	H	W	H																																				
IN 37.5	37.5	32	24	19	18	24	14																																				
MM 953	953	813	610	483	457	610	356																																				
 <p>90° Corner - High Back COM: 7.75 YD 7.09 M Unit weight: 95 LB 43.2 KG Carton weight: 119 LB 53.98 KG Carton volume: 44.5 FT³ 1.26 MT³</p>	<p>No power/USB unit.</p> <p>Includes ganging hardware (2 sides).</p> <p>Add \$127, \$47 for (S2), (SE) Add \$533 for 36 lbs. (CW), (C6) Add \$108 for (SU) or \$536 for (BS) Add \$35 for (TP) Add \$161 for (MB)</p>	<p>R27822 4666 4914 5123 5364 5759 6123 6487 6805 7200 7572 8076 8789</p> <p>R27822S 5664 5912 6121 6362 6757 7121 7485 7803 8198 8570 9074 9787</p> <p>shelf model IN W49 D49 H41.5 MM W1245 D1245 H1054</p>																																									
		<p>OVERALL DIMENSIONS</p> <table border="1"> <thead> <tr> <th>W</th> <th>D</th> <th>H</th> <th colspan="3">SEAT DIMENSIONS</th> <th colspan="2">BACK DIMENSIONS</th> </tr> <tr> <th>W</th> <th>D</th> <th>H</th> <th>W</th> <th>D</th> <th>H</th> <th>W</th> <th>H</th> </tr> </thead> <tbody> <tr> <td>IN 38.5</td> <td>38.5</td> <td>41.5</td> <td>24</td> <td>19</td> <td>18</td> <td>24</td> <td>23.5</td> </tr> <tr> <td>MM 978</td> <td>978</td> <td>1054</td> <td>610</td> <td>483</td> <td>457</td> <td>610</td> <td>597</td> </tr> </tbody> </table> <p>RTA 00 1 per carton</p>	W	D	H	SEAT DIMENSIONS			BACK DIMENSIONS		W	D	H	W	D	H	W	H	IN 38.5	38.5	41.5	24	19	18	24	23.5	MM 978	978	1054	610	483	457	610	597									
W	D	H	SEAT DIMENSIONS			BACK DIMENSIONS																																					
W	D	H	W	D	H	W	H																																				
IN 38.5	38.5	41.5	24	19	18	24	23.5																																				
MM 978	978	1054	610	483	457	610	597																																				

DESCRIPTION FEATURES MODEL# STANDARD TEXTILE GRADES

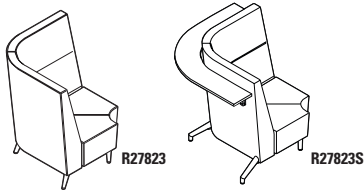

90° Corner - Extended Back
 COM: 8.25 YD | 7.54 M
 Unit weight: 100 LB | 45.5 KG
 Carton weight: 128 LB | 58.06 KG
 Carton volume: 50.5 FT³ | 1.43 MT³

No power/USB unit.
 Includes ganging hardware (2 sides).
 Add \$131, \$47 for **(S2)**, **(SE)**
 Add \$533 for 36 lbs. **(CW)**, **(C6)**
 Add \$108 for **(SU)** or \$536 for **(BS)**
 Add \$35 for **(TP)**
 Add \$161 for **(MB)**

	1	2	3	4	5	6	7	8	9	10	11	12
R27823	5181	5445	5668	5924	6344	6732	7120	7458	7879	8275	8811	9570
R27823S	6179	6443	6666	6922	7342	7730	8118	8456	8877	9273	9809	10568

shelf model IN W49.5 D49.5 H47 | MM W1257 D1257 H1194

	OVERALL DIMENSIONS			SEAT DIMENSIONS			BACK DIMENSIONS		
	W	D	H	W	D	H	W	H	
IN	39	39	47	24	19	18	24	29	
MM	991	991	1194	610	483	457	610	737	
RTA 00	1 per carton								

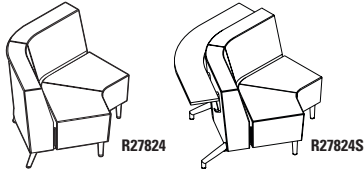

120° Corner - Standard Back
 COM: 6 YD | 5.49 M
 Unit weight: 80 LB | 36.4 KG
 Carton weight: 109 LB | 49.44 KG
 Carton volume: 48.25 FT³ | 1.36 MT³

No power/USB unit.
 Includes ganging hardware (2 sides).
 Add \$91, \$63 for **(S2)**, **(SE)**
 Add \$533 for 36 lbs. **(CW)**, **(C6)**
 Add \$117 for **(SU)** or \$596 for **(BS)**
 Add \$35 for **(TP)**
 Add \$161 for **(MB)**

	1	2	3	4	5	6	7	8	9	10	11	12
R27824	3676	3868	4030	4216	4522	4804	5086	5332	5638	5926	6316	6868
R27824S	4612	4804	4966	5152	5458	5740	6022	6268	6574	6862	7252	7804

shelf model IN W62.5 D40.5 H32 | MM W1588 D1029 H813

	OVERALL DIMENSIONS			SEAT DIMENSIONS			BACK DIMENSIONS		
	W	D	H	W	D	H	W	H	
IN	52.5	30	32	52	19	18	52	14	
MM	1334	762	813	1321	483	457	1321	356	
RTA 00	1 per carton								

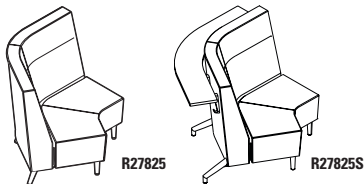

120° Corner - High Back
 COM: 7.75 YD | 7.09 M
 Unit weight: 89 LB | 40.5 KG
 Carton weight: 118 LB | 53.52 KG
 Carton volume: 60.5 FT³ | 1.71 MT³

No power/USB unit.
 Includes ganging hardware (2 sides).
 Add \$120, \$63 for **(S2)**, **(SE)**
 Add \$533 for 36 lbs. **(CW)**, **(C6)**
 Add \$117 for **(SU)** or \$596 for **(BS)**
 Add \$35 for **(TP)**
 Add \$161 for **(MB)**

	1	2	3	4	5	6	7	8	9	10	11	12
R27825	4666	4914	5123	5364	5759	6123	6487	6805	7200	7572	8076	8789
R27825S	5602	5850	6059	6300	6695	7059	7423	7741	8136	8508	9012	9725

shelf model IN W63.5 D41 H41.5 | MM W1613 D1041 H1054

	OVERALL DIMENSIONS			SEAT DIMENSIONS			BACK DIMENSIONS		
	W	D	H	W	D	H	W	H	
IN	53.5	30.5	41.5	41	21	18	51	23.5	
MM	1359	775	1054	1041	533	457	1295	597	
RTA 00	1 per carton								

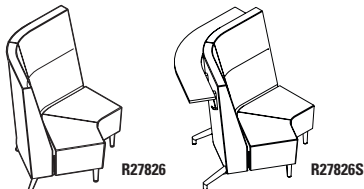

120° Corner - Extended Back
 COM: 8.25 YD | 7.54 M
 Unit weight: 91 LB | 41.4 KG
 Carton weight: 123 LB | 55.79 KG
 Carton volume: 68.75 FT³ | 1.94 MT³

No power/USB unit.
 Includes ganging hardware (2 sides).
 Add \$129, \$63 for **(S2)**, **(SE)**
 Add \$533 for 36 lbs. **(CW)**, **(C6)**
 Add \$117 for **(SU)** or \$596 for **(BS)**
 Add \$35 for **(TP)**
 Add \$161 for **(MB)**

	1	2	3	4	5	6	7	8	9	10	11	12
R27826	5181	5445	5668	5924	6344	6732	7120	7458	7879	8275	8811	9570
R27826S	6116	6380	6603	6859	7279	7667	8055	8393	8814	9210	9746	10505

shelf model IN W64 D41.5 H47 | MM W1626 D1054 H1194

	OVERALL DIMENSIONS			SEAT DIMENSIONS			BACK DIMENSIONS		
	W	D	H	W	D	H	W	H	
IN	54	31.5	47	41	21	18	51	29	
MM	1372	800	1194	1041	533	457	1295	737	
RTA 00	1 per carton								



Loop Arm
 COM: N/A
 Unit weight: 5 LB | 2.3 KG
 Carton weight: 7 LB | 3.18 KG
 Carton volume: 0.6 FT³ | 0.01 MT³

Arms sold separately (1 pc).

List price	
R2770	238

	OVERALL DIMENSIONS			SEAT DIMENSIONS			BACK DIMENSIONS		
	W	D	H	W	D	H	W	H	
IN	2.5	14	19.5	-	-	-	-	-	
MM	64	356	495	-	-	-	-	-	
RTA 1	1 per carton								

DESCRIPTION	FEATURES	MODEL#	STANDARD TEXTILE GRADES							
			List price							
		R2771	274							
			OVERALL DIMENSIONS			SEAT DIMENSIONS			BACK DIMENSIONS	
			W	D	H	W	D	H	W	H
Loop Arm w/Armcap COM: N/A Unit weight: 5 LB 2.3 KG Carton weight: 7 LB 3.18 KG Carton volume: 0.6 FT ³ 0.01 MT ³	Arms sold separately (1 pc). Armcap finish: (BK) Night, (FO) Fog, (LB) Latte		IN 2.5	14	19.5	-	-	-	-	-
		MM 64	356	495	-	-	-	-	-	
		RTA 1	1 per carton							

RIVER+ BENCHES

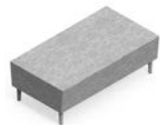

model R27832



model R27842



model R27845



model R27840

River+ Seating & Tables



For River+ seating, please see page 294.
For River+ tables, please see page 313.

EXAMPLE RIVER+ BENCH ORDER CODE:

R27832	-NS	-CE90	-CHM	-S6	-AS	-NC
--------	-----	-------	------	-----	-----	-----

Model number	Sealed Seams	Textile	Leg finish	Leg selection	Leg angle	Additional weight
--------------	--------------	---------	------------	---------------	-----------	-------------------

-SB	-W	-F1
-----	----	-----

Bottom selection	Power finish	Power/USB position
------------------	--------------	--------------------

Additional Options specify at end of order code.	SPECIFY CODE
Tamperproof fasteners Upcharges vary, see model.	TP
Moisture barrier Upcharges vary, see model.	MB

*linking hardware is lowered to clear the staple strip.
Units will only gang with other units with sealed bottom.
**cannot be combined with linking hardware or power units

STANDARD FEATURES

- A modular series that is composed of straight, and curved sections, as well as freestanding units.
- Linking units can be used together in any combination to create a wide variety of layouts. Ganging hardware is standard and is factory installed. Ganging hardware swivels out of the way when not in use.
- The unique tapered legs are made of welded steel, with each leg bolted directly to the unit frame. Standard leg height of 6.5". The leg height makes it easier to clean under the product.
- Legs are straight (vertical) as standard. Linking models are optionally available with angled back legs to match River+ seating units.
- Legs are standard in Chrome with Black nylon non-marking height adjustable glides.
- River+ is rated for an active weight up to 600 lbs. per seat and 24/7 use.
- For heavy duty application, Global's Limited Lifetime Warranty is applicable only on fabrics that are rated for 100,000 double rubs.
- Upholstery options: fabric, vinyl or leather. Vinyl and leather models may feature stitch detail across the seat and/or back cushions, if applicable.
- All units are shipped fully assembled.

OPTIONAL FEATURES

- To add sealed seams to your product, please specify **(SS)** - see each model for upcharge.
- Legs are available in 3" and 8" heights. All heights are available with fixed-to-floor option. Please specify. Upcharges vary. *Fastening hardware not included.*
- Products can be weighted to reduce the ease of movement. For additional weight options, please specify **(CW)** - see each model for available additional weight and upcharge.
- The underside of the seat can be finished with PVC (vinyl) and sealed to prevent penetration of liquids. Please specify **(SU)** - see each model for upcharge.
- Steel bottom provides tamperproof protection (includes tamperproof screws). Please specify **(BS)** - see each model for upcharge.
- Most benches (except corner and freestanding units) can be specified with power/USB units, which include one power outlet, one double USB terminal and a Black 120" three-prong power cord.
- Each power/USB unit is set in predetermined locations, as shown in the electrical illustrations below. Electrical units must be factory installed. Add \$717 per unit.
- Power/USB units are available with either Jet Black **(J)** face plate with Black power/USB receptacles or with a White **(W)** face plate with White power/USB receptacles.

Please add option codes in the following order:

- Model number**
R27831 to R27833 Straight benches
R27834 to R27835 Curved benches
R27836 to R27839 Corner benches
R27840 to R27841 Boomerang benches
R27842 Y bench
R27843 to R27846 Round non-linking benches
R27847 to R27850 Square non-linking benches
- Seat sealed seams**
(NS) Standard seams.
(SS) Sealed seams. Upcharges vary, see model.
- Textile**
Specify textile code.
- Leg finish**
For leg finish options, please see page 379. No upcharges.
- Leg selection**
(S6) Standard seat height (17.5"), 6.5" leg w/ adjustable glides. No upcharge.
(S3) Low seat (14"), 3" leg w/adjustable glides. No upcharge.
(S8) High seat (19"), 8" leg w/adjustable glides. No upcharge.
(F6) Standard seat height (17.5"), 6.5" leg, fixed to floor. Upcharges vary.
(F3) Low seat (14"), 3" leg, fixed to floor. Upcharges vary.
(F8) High seat (19"), 8" leg, fixed to floor. Upcharges vary.
- Leg angle**
(AS) Straight legs. No upcharge.
(SA) Straight front legs, angled back legs (available only for 6.5" and 8" high legs on straight, curved, corner and boomerang units). No upcharge.
- Additional weight**
(NC) No additional weight.
(CW) Additional weight. Upcharges vary, see model.
- Bottom selection**
(SB) Standard bottom.
(SU) Vinyl sealed bottom w/staple strip. Upcharges vary, see model.*
(BS) Steel bottom. Upcharges vary, see model.**
- Power unit finish**
(NP) No power
(J) Jet Black
(W) White
- Power/USB unit position** (straight, curved, boomerang and Y benches only, as shown below). Add \$717 per unit.
(F1) Front left
(F2) Front right
(B1) Back left
(B2) Back right

ELECTRICAL PLACEMENT

Straight benches

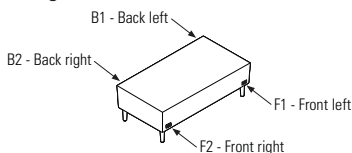

Y bench

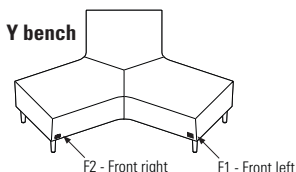



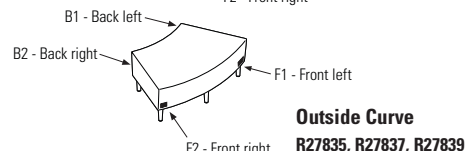
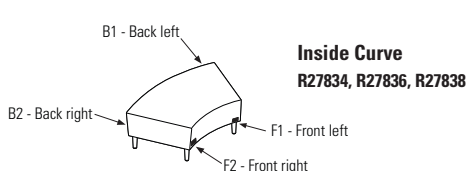

Curved benches

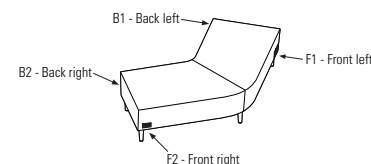
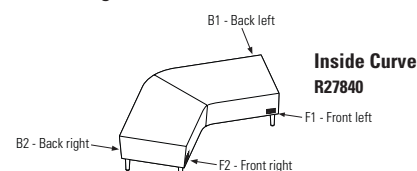

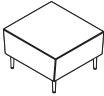
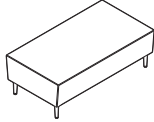
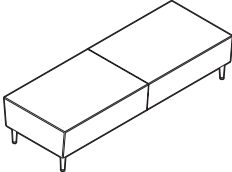
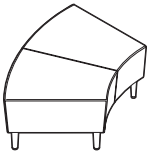

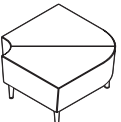

Boomerang benches

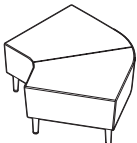
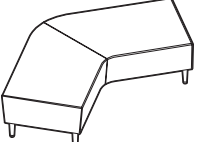

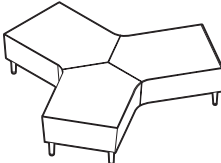
DESCRIPTION	FEATURES	MODEL#	STANDARD TEXTILE GRADES														
			1	2	3	4	5	6	7	8	9	10	11	12			
 <p>Single Seater Bench COM: 1.75 YD 1.6 M Unit weight: 40 LB 18.2 KG Carton weight: 48 LB 21.77 KG Carton volume: 10.5 FT³ 0.29 MT³</p>	<p>For power/USB unit, please see electrical placement chart.</p> <p>Includes ganging hardware (2 sides).</p> <p>Add \$47 for (SS) Add \$90 for (F_) Add \$533 for 36 lbs. (CW) Add \$47 for (SU) or \$247 for (BS) Add \$28 for (TP) Add \$81 for (MB)</p>	R27831	1157	1213	1260	1315	1404	1486	1568	1640	1729	1813	1927	2088			
			OVERALL DIMENSIONS			SEAT DIMENSIONS			BACK DIMENSIONS								
			W	D	H	W	D	H	W	H							
			IN 26	28.5	17.5	-	-	-	-	-							
MM 660	724	445	-	-	-	-	-										
			RTA 00	1 per carton													
 <p>Two Seater Bench COM: 2.75 YD 2.51 M Unit weight: 55 LB 25 KG Carton weight: 65 LB 29.48 KG Carton volume: 20.5 FT³ 0.58 MT³</p>	<p>For power/USB unit, please see electrical placement chart.</p> <p>Includes ganging hardware (2 sides).</p> <p>Add \$59 for (SS) Add \$90 for (F_) Add \$1067 for 72 lbs. (CW) Add \$72 for (SU) or \$407 for (BS) Add \$28 for (TP) Add \$161 for (MB)</p>	R27832	1796	1884	1958	2044	2184	2313	2442	2555	2695	2827	3006	3259			
			OVERALL DIMENSIONS			SEAT DIMENSIONS			BACK DIMENSIONS								
			W	D	H	W	D	H	W	H							
			IN 52	28.5	17.5	-	-	-	-	-							
MM 1321	724	445	-	-	-	-	-										
			RTA 00	1 per carton													
 <p>Three Seater Bench COM: 4.5 YD 4.11 M Unit weight: 88 LB 40 KG Carton weight: 103 LB 46.72 KG Carton volume: 30.25 FT³ 0.85 MT³</p>	<p>For power/USB unit, please see electrical placement chart.</p> <p>Includes ganging hardware (2 sides).</p> <p>Add \$88 for (SS) Add \$90 for (F_) Add \$1067 for 72 lbs. (CW) Add \$101 for (SU) or \$521 for (BS) Add \$28 for (TP) Add \$243 for (MB)</p>	R27833	2489	2633	2755	2894	3124	3335	3547	3731	3961	4177	4469	4883			
			OVERALL DIMENSIONS			SEAT DIMENSIONS			BACK DIMENSIONS								
			W	D	H	W	D	H	W	H							
			IN 78	28.5	17.5	-	-	-	-	-							
MM 1981	724	445	-	-	-	-	-										
			RTA 00	1 per carton													
 <p>Inside Curve Two Seater Bench COM: 3 YD 2.74 M Unit weight: 49 LB 22.3 KG Carton weight: 60 LB 27.22 KG Carton volume: 22.75 FT³ 0.64 MT³</p>	<p>For power/USB unit, please see electrical placement chart.</p> <p>Includes ganging hardware (2 sides).</p> <p>Add \$55 for (SS) Add \$113 for (F_) Add \$1067 for 72 lbs. (CW) Add \$72 for (SU) or \$327 for (BS) Add \$35 for (TP) Add \$161 for (MB)</p>	R27834	2609	2705	2786	2879	3032	3173	3314	3437	3590	3734	3929	4205			
			OVERALL DIMENSIONS			SEAT DIMENSIONS			BACK DIMENSIONS								
			W	D	H	W	D	H	W	H							
			IN 50	30.5	17.5	-	-	-	-	-							
MM 1270	775	445	-	-	-	-	-										
			RTA 00	1 per carton													
 <p>Outside Curve Two Seater Bench COM: 3 YD 2.74 M Unit weight: 49 LB 22.3 KG Carton weight: 60 LB 27.22 KG Carton volume: 22.75 FT³ 0.64 MT³</p>	<p>For power/USB unit, please see electrical placement chart.</p> <p>Includes ganging hardware (2 sides).</p> <p>Add \$55 for (SS) Add \$113 for (F_) Add \$1067 for 72 lbs. (CW) Add \$72 for (SU) or \$327 for (BS) Add \$35 for (TP) Add \$161 for (MB)</p>	R27835	2609	2705	2786	2879	3032	3173	3314	3437	3590	3734	3929	4205			
			OVERALL DIMENSIONS			SEAT DIMENSIONS			BACK DIMENSIONS								
			W	D	H	W	D	H	W	H							
			IN 50	30.5	17.5	-	-	-	-	-							
MM 1270	775	445	-	-	-	-	-										
			RTA 00	1 per carton													

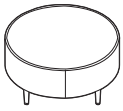
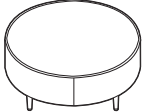
DESCRIPTION	FEATURES	MODEL#	STANDARD TEXTILE GRADES													
			1	2	3	4	5	6	7	8	9	10	11	12		
 <p>90° Inside Curve Corner Bench COM: 3.25 YD 2.97 M Unit weight: 49 LB 22.3 KG Carton weight: 60 LB 27.22 KG Carton volume: 17.25 FT³ 0.48 MT³</p>	<p>For power/USB unit, please see electrical placement chart.</p> <p>Includes ganging hardware (2 sides).</p> <p>Add \$55 for (SS) Add \$113 for (F_) Add \$533 for 36 lbs. (CW) Add \$83 for (SU) or \$382 for (BS) Add \$35 for (TP) Add \$161 for (MB)</p>	R27836	2609	2713	2801	2902	3067	3220	3373	3506	3672	3828	4039	4338		
		OVERALL DIMENSIONS			SEAT DIMENSIONS			BACK DIMENSIONS								
		W D H			W D H			W H								
		IN 36.5 36.5 17.5			- - -			- - -								
		MM 927 927 445			- - -			- - -								
			RTA 00			1 per carton										
 <p>90° Outside Curve Corner Bench COM: 3.25 YD 2.97 M Unit weight: 49 LB 22.3 KG Carton weight: 60 LB 27.22 KG Carton volume: 17.25 FT³ 0.48 MT³</p>	<p>For power/USB unit, please see electrical placement chart.</p> <p>Includes ganging hardware (2 sides).</p> <p>Add \$55 for (SS) Add \$113 for (F_) Add \$533 for 36 lbs. (CW) Add \$83 for (SU) or \$382 for (BS) Add \$35 for (TP) Add \$161 for (MB)</p>	R27837	2609	2713	2801	2902	3067	3220	3373	3506	3672	3828	4039	4338		
		OVERALL DIMENSIONS			SEAT DIMENSIONS			BACK DIMENSIONS								
		W D H			W D H			W H								
		IN 36.5 36.5 17.5			- - -			- - -								
		MM 927 927 445			- - -			- - -								
			RTA 00			1 per carton										
 <p>120° Inside Curve Corner Bench COM: 3.5 YD 3.2 M Unit weight: 46 LB 20.9 KG Carton weight: 57 LB 25.85 KG Carton volume: 26.75 FT³ 0.75 MT³</p>	<p>For power/USB unit, please see electrical placement chart.</p> <p>Includes ganging hardware (2 sides).</p> <p>Add \$57 for (SS) Add \$113 for (F_) Add \$533 for 36 lbs. (CW) Add \$83 for (SU) or \$421 for (BS) Add \$35 for (TP) Add \$161 for (MB)</p>	R27838	2609	2721	2816	2924	3103	3267	3432	3575	3754	3922	4149	4471		
		OVERALL DIMENSIONS			SEAT DIMENSIONS			BACK DIMENSIONS								
		W D H			W D H			W H								
		IN 36.5 51.5 17.5			- - -			- - -								
		MM 927 1308 445			- - -			- - -								
			RTA 00			1 per carton										
 <p>120° Outside Curve Corner Bench COM: 3.5 YD 3.2 M Unit weight: 46 LB 20.9 KG Carton weight: 57 LB 25.85 KG Carton volume: 26.75 FT³ 0.75 MT³</p>	<p>For power/USB unit, please see electrical placement chart.</p> <p>Includes ganging hardware (2 sides).</p> <p>Add \$57 for (SS) Add \$113 for (F_) Add \$533 for 36 lbs. (CW) Add \$83 for (SU) or \$421 for (BS) Add \$35 for (TP) Add \$161 for (MB)</p>	R27839	2609	2721	2816	2924	3103	3267	3432	3575	3754	3922	4149	4471		
		OVERALL DIMENSIONS			SEAT DIMENSIONS			BACK DIMENSIONS								
		W D H			W D H			W H								
		IN 36.5 51.5 17.5			- - -			- - -								
		MM 927 1308 445			- - -			- - -								
			RTA 00			1 per carton										
 <p>Inside Curve Boomerang Bench COM: 5.25 YD 4.8 M Unit weight: 84 LB 38.2 KG Carton weight: 126 LB 57.15 KG Carton volume: 47.75 FT³ 1.35 MT³</p>	<p>For power/USB unit, please see electrical placement chart.</p> <p>Includes ganging hardware (2 sides).</p> <p>Add \$84 for (SS) Add \$113 for (F_) Add \$1067 for 72 lbs. (CW) Add \$114 for (SU) or \$736 for (BS) Add \$35 for (TP) Add \$243 for (MB)</p>	R27840	3233	3401	3543	3706	3973	4220	4467	4682	4950	5202	5543	6026		
		OVERALL DIMENSIONS			SEAT DIMENSIONS			BACK DIMENSIONS								
		W D H			W D H			W H								
		IN 82 45 17.5			- - -			- - -								
		MM 2083 1143 445			- - -			- - -								
			RTA 00			1 per carton										

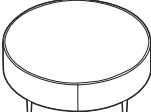
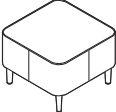
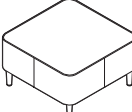
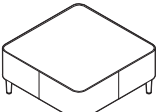
DESCRIPTION	FEATURES	MODEL#	STANDARD TEXTILE GRADES												
			1	2	3	4	5	6	7	8	9	10	11	12	
 <p>Outside Curve Boomerang Bench COM: 5.25 YD 4.8 M Unit weight: 84 LB 38.2 KG Carton weight: 126 LB 57.15 KG Carton volume: 47.75 FT³ 1.35 MT³</p>	<p>For power/USB unit, please see electrical placement chart.</p> <p>Includes ganging hardware (2 sides).</p> <p>Add \$84 for (SS) Add \$113 for (F_) Add \$1067 for 72 lbs. (CW) Add \$114 for (SU) or \$736 for (BS) Add \$35 for (TP) Add \$243 for (MB)</p>	R27841	3233	3401	3543	3706	3973	4220	4467	4682	4950	5202	5543	6026	
			OVERALL DIMENSIONS			SEAT DIMENSIONS			BACK DIMENSIONS						
			W	D	H	W	D	H	W	H					
			IN 82	45	17.5	-	-	-	-	-					
	MM 2083	1143	445	-	-	-	-	-							
		RTA 00	1 per carton												
 <p>Y Bench COM: 8 YD 7.32 M Unit weight: 122 LB 55.5 KG Carton weight: 203 LB 92.08 KG Carton volume: 101.25 FT³ 2.86 MT³</p>	<p>For power/USB unit, please see electrical placement chart.</p> <p>Includes ganging hardware (2 sides).</p> <p>Add \$141 for (SS) Add \$158 for (F_) Add \$800 for 54 lbs. (CW) Add \$179 for (SU) or \$917 for (BS) Add \$51 for (TP) Add \$324 for (MB)</p>	R27842	5623	5879	6095	6343	6751	7127	7503	7831	8239	8623	9143	9879	
			OVERALL DIMENSIONS			SEAT DIMENSIONS			BACK DIMENSIONS						
			W	D	H	W	D	H	W	H					
			IN 82	70	17.5	-	-	-	-	-					
	MM 2083	1778	445	-	-	-	-	-							
		RTA 00	1 per carton												
 <p>18" Dia. Round Bench COM: 1 YD 0.91 M Unit weight: 20 LB 9.1 KG Carton weight: 25 LB 11.34 KG Carton volume: 4.7 FT³ 0.13 MT³</p>	<p>No power/USB unit.</p> <p>Freestanding unit only.</p> <p>Add \$31 for (SS) Add \$90 for (F_) Not available (CW) Add \$35 for (SU), (BS) not available Add \$28 for (TP) Add \$81 for (MB)</p>	R27843	686	718	745	776	827	874	921	962	1013	1061	1126	1218	
			OVERALL DIMENSIONS			SEAT DIMENSIONS			BACK DIMENSIONS						
			W	D	H	W	D	H	W	H					
			IN 18	18	17.5	-	-	-	-	-					
	MM 457	457	445	-	-	-	-	-							
		RTA 00	1 per carton												
 <p>36" Dia. Round Bench COM: 3.25 YD 2.97 M Unit weight: 41 LB 18.6 KG Carton weight: 50 LB 22.68 KG Carton volume: 18.25 FT³ 0.51 MT³</p>	<p>No power/USB unit.</p> <p>Freestanding unit only.</p> <p>Add \$51 for (SS) Add \$90 for (F_) Add \$533 for 36 lbs. (CW) Add \$72 for (SU) or \$422 for (BS) Add \$28 for (TP) Add \$81 for (MB)</p>	R27844	1546	1650	1738	1839	2004	2157	2310	2443	2609	2765	2976	3275	
			OVERALL DIMENSIONS			SEAT DIMENSIONS			BACK DIMENSIONS						
			W	D	H	W	D	H	W	H					
			IN 36	36	17.5	-	-	-	-	-					
	MM 914	914	445	-	-	-	-	-							
		RTA 00	1 per carton												
 <p>42" Dia. Round Bench COM: 3.5 YD 3.2 M Unit weight: 45 LB 20.5 KG Carton weight: 55 LB 24.95 KG Carton volume: 23 FT³ 0.65 MT³</p>	<p>No power/USB unit.</p> <p>Freestanding unit only.</p> <p>Add \$55 for (SS) Add \$90 for (F_) Add \$1067 for 72 lbs. (CW) Add \$83 for (SU) or \$461 for (BS) Add \$28 for (TP) Add \$161 for (MB)</p>	R27845	1813	1925	2020	2128	2307	2471	2636	2779	2958	3126	3353	3675	
			OVERALL DIMENSIONS			SEAT DIMENSIONS			BACK DIMENSIONS						
			W	D	H	W	D	H	W	H					
			IN 42	42	17.5	-	-	-	-	-					
	MM 1067	1067	445	-	-	-	-	-							
		RTA 00	1 per carton												

DESCRIPTION	FEATURES	MODEL#	STANDARD TEXTILE GRADES											
			1	2	3	4	5	6	7	8	9	10	11	12
 <p>48" Dia. Round Bench COM: 3.75 YD 3.43 M Unit weight: 55 LB 25 KG Carton weight: 65 LB 29.48 KG Carton volume: 30 FT³ 0.84 MT³</p>	<p>No power/USB unit.</p> <p>Freestanding unit only.</p> <p>Add \$59 for (SS) Add \$90 for (F_) Add \$1067 for 72 lbs. (CW) Add \$101 for (SU) or \$491 for (BS) Add \$28 for (TP) Add \$243 for (MB)</p>	<p>R27846</p>	2130	2250	2351	2468	2659	2835	3011	3165	3356	3536	3780	4125
			OVERALL DIMENSIONS			SEAT DIMENSIONS			BACK DIMENSIONS					
			W	D	H	W	D	H	W	H				
			IN 48	48	17.5	-	-	-	-	-				
MM 1219	1219	445	-	-	-	-	-							
			RTA 00	1 per carton										
 <p>24" Square Bench COM: 1.5 YD 1.37 M Unit weight: 25 LB 11.4 KG Carton weight: 30 LB 13.61 KG Carton volume: 8 FT³ 0.22 MT³</p>	<p>No power/USB unit.</p> <p>Freestanding unit only.</p> <p>Add \$43 for (SS) Add \$90 for (F_) Add \$533 for 36 lbs. (CW) Add \$38 for (SU) or \$189 for (BS) Add \$28 for (TP) Add \$81 for (MB)</p>	<p>R27847</p>	968	1016	1057	1103	1180	1250	1321	1382	1459	1531	1628	1766
			OVERALL DIMENSIONS			SEAT DIMENSIONS			BACK DIMENSIONS					
			W	D	H	W	D	H	W	H				
			IN 24	24	17.5	-	-	-	-	-				
MM 610	610	445	-	-	-	-	-							
			RTA 00	1 per carton										
 <p>30" Square Bench COM: 2.75 YD 2.51 M Unit weight: 30 LB 13.6 KG Carton weight: 40 LB 18.14 KG Carton volume: 12.25 FT³ 0.34 MT³</p>	<p>No power/USB unit.</p> <p>Freestanding unit only.</p> <p>Add \$51 for (SS) Add \$90 for (F_) Add \$1067 for 36 lbs. (CW) Add \$72 for (SU) or \$233 for (BS) Add \$28 for (TP) Add \$81 for (MB)</p>	<p>R27848</p>	1290	1378	1452	1538	1678	1807	1936	2049	2189	2321	2500	2753
			OVERALL DIMENSIONS			SEAT DIMENSIONS			BACK DIMENSIONS					
			W	D	H	W	D	H	W	H				
			IN 30	30	17.5	-	-	-	-	-				
MM 762	762	445	-	-	-	-	-							
			RTA 00	1 per carton										
 <p>36" Square Bench COM: 3 YD 2.74 M Unit weight: 40 LB 18.2 KG Carton weight: 50 LB 22.68 KG Carton volume: 18.25 FT³ 0.51 MT³</p>	<p>No power/USB unit.</p> <p>Freestanding unit only.</p> <p>Add \$55 for (SS) Add \$90 for (F_) Add \$1067 for 72 lbs. (CW) Add \$77 for (SU) or \$311 for (BS) Add \$28 for (TP) Add \$161 for (MB)</p>	<p>R27849</p>	1598	1694	1775	1868	2021	2162	2303	2426	2579	2723	2918	3194
			OVERALL DIMENSIONS			SEAT DIMENSIONS			BACK DIMENSIONS					
			W	D	H	W	D	H	W	H				
			IN 36	36	17.5	-	-	-	-	-				
MM 914	914	445	-	-	-	-	-							
			RTA 00	1 per carton										
 <p>42" Square Bench COM: 3.25 YD 2.97 M Unit weight: 50 LB 22.7 KG Carton weight: 60 LB 27.22 KG Carton volume: 23 FT³ 0.65 MT³</p>	<p>No power/USB unit.</p> <p>Freestanding unit only.</p> <p>Add \$61 for (SS) Add \$90 for (F_) Add \$1067 for 72 lbs. (CW) Add \$96 for (SU) or \$430 for (BS) Add \$28 for (TP) Add \$243 for (MB)</p>	<p>R27850</p>	1955	2059	2147	2248	2413	2566	2719	2852	3018	3174	3385	3684
			OVERALL DIMENSIONS			SEAT DIMENSIONS			BACK DIMENSIONS					
			W	D	H	W	D	H	W	H				
			IN 42	42	17.5	-	-	-	-	-				
MM 1067	1067	445	-	-	-	-	-							
			RTA 00	1 per carton										

RIVER+ TABLES

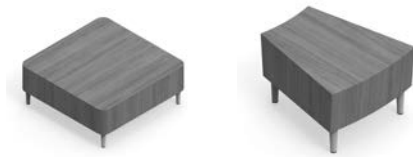

model R27858

model R27864



model 7743

River+ Seating & Benches



For River+ seating, please see page 294.
For River+ benches, please see page 308.

STANDARD FEATURES

- A modular series that is composed of straight and curved sections, as well as freestanding units.
- Linking units can be used together in any combination with River+ seating and bench units to create a wide variety of layouts. Ganging hardware is standard and is factory installed. Ganging hardware swivels out of the way when not in use.
- Front and back faces of end (linking) tables angles slightly inwards. This inward slant matches the inward angles of River seating so all units coordinate in visual appearance.
- The unique tapered legs are made of welded steel, with each leg bolted directly to the unit frame. All units have the same standard leg height of 6.5". The leg height makes it easier to clean under the product.
- Legs are straight (vertical) as standard. Linking models are optionally available with an angled back leg to visually align with River seating units.
- Legs are standard in Chrome with Black nylon non-marking height adjustable glides.

OPTIONAL FEATURES

- Tables are made with high pressure laminate and are offered in the finishes listed on the right. Please specify. Custom high pressure laminate finishes will be considered upon request.
- Legs of coffee and end (linking) tables are available in 3" and 8" heights. All heights are available with fixed-to-floor option. Please specify.
- Products can be weighted to reduce the ease of movement. For additional weight options, please specify (CW) - see each model for available additional weight and upcharge.
- Most tables (except freestanding units) can be specified with power/USB units, which include one power outlets, one double USB terminals and a Black 120" three-prong power cord.
- Each power/USB unit is set in predetermined locations, as shown in the electrical illustrations below. Electrical units must be factory installed. Add \$881 per unit.
- Power/USB units are available with either Jet Black (J) face plate with Black power/USB receptacles or with a White (W) face plate with White power/USB receptacles.

Please add option codes in the following order:

- **Model number**
R27855 to R27858 Square coffee tables
R27859 Rectangular coffee table
R27860 to R27861 Round coffee tables
R27862 to R27864 Linking/end tables
7443 and 7745 Freestanding tables
- **Laminate finishes** (colors shown on website)

(ACJ) Absolute Acajou	(FCL) First Class
(ASN) Asian Night	(NBL) Noce Biondo
(AWC) Avnt Cherry	(NGL) Noce Grigio
(AWH) Avnt Honey	(NEL) Noce Leggero
(BLK) Black	(NML) Noce Medio
(BZD) Blizzard	(QTM) Quartered Mahogany
(BRC) Brushed Cobalt	(SBY) Sheer Beauty
(CMB) Clear Maple	(SDT) Stonedust
(CGY) Custom Grey	(SOG) Storm Grey
(DES) Dark Espresso	(WHE) Walnut Heights
(DWT) Designer White	(WHC) White Chocolate
(FAS) Fashionista	(WCR) Winter Cherry
- **Leg finish**
For leg finish options, please see page 379. No upcharges.
- **Leg selection**
(S6) Standard height (6.5") w/adjustable glides. No upcharge.
(S3) Low (3") w/adjustable glides. No upcharge.
(S8) High (8") w/adjustable glides. No upcharge.
(F6) Standard height (6.5"), fixed to floor. Add \$90.
(F3) Low (3"), fixed to floor. Add \$90.
(F8) High (8"), fixed to floor. Add \$90.
- **Leg angle** (linking/end tables only)
(AS) Straight legs. No upcharge.
(SA) Straight front legs, angled back legs. No upcharge.
- **Additional weight**
(NC) No additional weight.
(CW) Additional weight. Upcharges vary, see model.
- **Power unit finish**
(J) Jet Black
(W) White
- **Power/USB unit position** (coffee and linking/end tables only, as shown below). Add \$881 per unit.
(NP) No power. No upcharge.
(E1) Left end (rectangular coffee table only)
(E2) Right end (rectangular coffee table only)
(F3) Front center (square coffee table only)
(T1) Top
- **Fasteners**
(RS) Standard
(TP) Tamperproof. Add \$119.

EXAMPLE RIVER+ TABLE ORDER CODE:

R27858	-ACJ	-CHM	-S6	-AS	-NC	-W	-T1	-RS
Model number	Laminate	Leg finish	Leg selection	Leg angle	Additional weight	Power finish	Power/USB	Fasteners

ELECTRICAL PLACEMENT

Coffee Tables

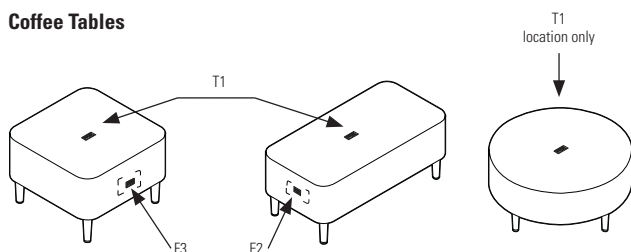

Linking Tables

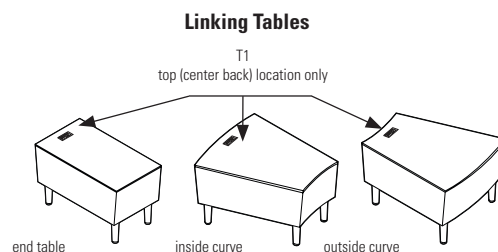

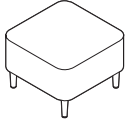
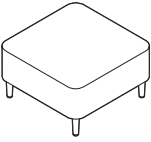
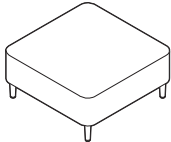
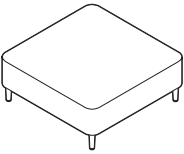
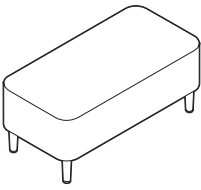
DESCRIPTION	FEATURES	MODEL#	STANDARD TEXTILE GRADES																																								
 <p>24" Square Laminate Coffee Table COM: N/A Unit weight: 40 LB 18.14 KG Carton weight: 40 LB 18.14 KG Carton volume: 10.7 FT³ 0.3 MT³</p>	<p>For power/USB unit, please see electrical placement chart.</p> <p>Freestanding unit only. Add \$533 for 36 lbs. (CW)</p>	List price																																									
		R27855	1329																																								
		<table border="1"> <thead> <tr> <th colspan="3">OVERALL DIMENSIONS</th> <th colspan="3">SEAT DIMENSIONS</th> <th colspan="2">BACK DIMENSIONS</th> </tr> <tr> <th>W</th> <th>D</th> <th>H</th> <th>W</th> <th>D</th> <th>H</th> <th>W</th> <th>H</th> </tr> </thead> <tbody> <tr> <td>IN 24</td> <td>24</td> <td>17</td> <td>-</td> <td>-</td> <td>-</td> <td>-</td> <td>-</td> </tr> <tr> <td>MM 610</td> <td>610</td> <td>432</td> <td>-</td> <td>-</td> <td>-</td> <td>-</td> <td>-</td> </tr> </tbody> </table>			OVERALL DIMENSIONS			SEAT DIMENSIONS			BACK DIMENSIONS		W	D	H	W	D	H	W	H	IN 24	24	17	-	-	-	-	-	MM 610	610	432	-	-	-	-	-	<table border="1"> <thead> <tr> <th colspan="2">RTA 00</th> <th></th> </tr> </thead> <tbody> <tr> <td></td> <td></td> <td>1 per carton</td> </tr> </tbody> </table>			RTA 00			
OVERALL DIMENSIONS			SEAT DIMENSIONS			BACK DIMENSIONS																																					
W	D	H	W	D	H	W	H																																				
IN 24	24	17	-	-	-	-	-																																				
MM 610	610	432	-	-	-	-	-																																				
RTA 00																																											
		1 per carton																																									
 <p>30" Square Laminate Coffee Table COM: N/A Unit weight: 53 LB 24.04 KG Carton weight: 53 LB 24.04 KG Carton volume: 15.3 FT³ 0.43 MT³</p>	<p>For power/USB unit, please see electrical placement chart.</p> <p>Freestanding unit only. Add \$400 for 27 lbs. (CW)</p>	List price																																									
		R27856	1392																																								
		<table border="1"> <thead> <tr> <th colspan="3">OVERALL DIMENSIONS</th> <th colspan="3">SEAT DIMENSIONS</th> <th colspan="2">BACK DIMENSIONS</th> </tr> <tr> <th>W</th> <th>D</th> <th>H</th> <th>W</th> <th>D</th> <th>H</th> <th>W</th> <th>H</th> </tr> </thead> <tbody> <tr> <td>IN 30</td> <td>30</td> <td>17</td> <td>-</td> <td>-</td> <td>-</td> <td>-</td> <td>-</td> </tr> <tr> <td>MM 762</td> <td>762</td> <td>432</td> <td>-</td> <td>-</td> <td>-</td> <td>-</td> <td>-</td> </tr> </tbody> </table>			OVERALL DIMENSIONS			SEAT DIMENSIONS			BACK DIMENSIONS		W	D	H	W	D	H	W	H	IN 30	30	17	-	-	-	-	-	MM 762	762	432	-	-	-	-	-	<table border="1"> <thead> <tr> <th colspan="2">RTA 00</th> <th></th> </tr> </thead> <tbody> <tr> <td></td> <td></td> <td>1 per carton</td> </tr> </tbody> </table>			RTA 00			
OVERALL DIMENSIONS			SEAT DIMENSIONS			BACK DIMENSIONS																																					
W	D	H	W	D	H	W	H																																				
IN 30	30	17	-	-	-	-	-																																				
MM 762	762	432	-	-	-	-	-																																				
RTA 00																																											
		1 per carton																																									
 <p>36" Square Laminate Coffee Table COM: N/A Unit weight: 75 LB 34.01 KG Carton weight: 75 LB 34.02 KG Carton volume: 20.6 FT³ 0.58 MT³</p>	<p>For power/USB unit, please see electrical placement chart.</p> <p>Freestanding unit only. No additional weight required.</p>	List price																																									
		R27857	1541																																								
		<table border="1"> <thead> <tr> <th colspan="3">OVERALL DIMENSIONS</th> <th colspan="3">SEAT DIMENSIONS</th> <th colspan="2">BACK DIMENSIONS</th> </tr> <tr> <th>W</th> <th>D</th> <th>H</th> <th>W</th> <th>D</th> <th>H</th> <th>W</th> <th>H</th> </tr> </thead> <tbody> <tr> <td>IN 36</td> <td>36</td> <td>17</td> <td>-</td> <td>-</td> <td>-</td> <td>-</td> <td>-</td> </tr> <tr> <td>MM 914</td> <td>914</td> <td>432</td> <td>-</td> <td>-</td> <td>-</td> <td>-</td> <td>-</td> </tr> </tbody> </table>			OVERALL DIMENSIONS			SEAT DIMENSIONS			BACK DIMENSIONS		W	D	H	W	D	H	W	H	IN 36	36	17	-	-	-	-	-	MM 914	914	432	-	-	-	-	-	<table border="1"> <thead> <tr> <th colspan="2">RTA 00</th> <th></th> </tr> </thead> <tbody> <tr> <td></td> <td></td> <td>1 per carton</td> </tr> </tbody> </table>			RTA 00			
OVERALL DIMENSIONS			SEAT DIMENSIONS			BACK DIMENSIONS																																					
W	D	H	W	D	H	W	H																																				
IN 36	36	17	-	-	-	-	-																																				
MM 914	914	432	-	-	-	-	-																																				
RTA 00																																											
		1 per carton																																									
 <p>42" Square Laminate Coffee Table COM: N/A Unit weight: 115 LB 52.16 KG Carton weight: 115 LB 52.16 KG Carton volume: 26.7 FT³ 0.75 MT³</p>	<p>For power/USB unit, please see electrical placement chart.</p> <p>Freestanding unit only. No additional weight required.</p>	List price																																									
		R27858	1706																																								
		<table border="1"> <thead> <tr> <th colspan="3">OVERALL DIMENSIONS</th> <th colspan="3">SEAT DIMENSIONS</th> <th colspan="2">BACK DIMENSIONS</th> </tr> <tr> <th>W</th> <th>D</th> <th>H</th> <th>W</th> <th>D</th> <th>H</th> <th>W</th> <th>H</th> </tr> </thead> <tbody> <tr> <td>IN 42</td> <td>42</td> <td>17</td> <td>-</td> <td>-</td> <td>-</td> <td>-</td> <td>-</td> </tr> <tr> <td>MM 1067</td> <td>1067</td> <td>432</td> <td>-</td> <td>-</td> <td>-</td> <td>-</td> <td>-</td> </tr> </tbody> </table>			OVERALL DIMENSIONS			SEAT DIMENSIONS			BACK DIMENSIONS		W	D	H	W	D	H	W	H	IN 42	42	17	-	-	-	-	-	MM 1067	1067	432	-	-	-	-	-	<table border="1"> <thead> <tr> <th colspan="2">RTA 00</th> <th></th> </tr> </thead> <tbody> <tr> <td></td> <td></td> <td>1 per carton</td> </tr> </tbody> </table>			RTA 00			
OVERALL DIMENSIONS			SEAT DIMENSIONS			BACK DIMENSIONS																																					
W	D	H	W	D	H	W	H																																				
IN 42	42	17	-	-	-	-	-																																				
MM 1067	1067	432	-	-	-	-	-																																				
RTA 00																																											
		1 per carton																																									
 <p>Rectangular Laminate Coffee Table COM: N/A Unit weight: 55 LB 24.94 KG Carton weight: 55 LB 24.95 KG Carton volume: 14.2 FT³ 0.4 MT³</p>	<p>For power/USB unit, please see electrical placement chart.</p> <p>Freestanding unit only. Add \$267 for 18 lbs. (CW)</p>	List price																																									
		R27859	1400																																								
		<table border="1"> <thead> <tr> <th colspan="3">OVERALL DIMENSIONS</th> <th colspan="3">SEAT DIMENSIONS</th> <th colspan="2">BACK DIMENSIONS</th> </tr> <tr> <th>W</th> <th>D</th> <th>H</th> <th>W</th> <th>D</th> <th>H</th> <th>W</th> <th>H</th> </tr> </thead> <tbody> <tr> <td>IN 40</td> <td>20</td> <td>17</td> <td>-</td> <td>-</td> <td>-</td> <td>-</td> <td>-</td> </tr> <tr> <td>MM 1016</td> <td>508</td> <td>432</td> <td>-</td> <td>-</td> <td>-</td> <td>-</td> <td>-</td> </tr> </tbody> </table>			OVERALL DIMENSIONS			SEAT DIMENSIONS			BACK DIMENSIONS		W	D	H	W	D	H	W	H	IN 40	20	17	-	-	-	-	-	MM 1016	508	432	-	-	-	-	-	<table border="1"> <thead> <tr> <th colspan="2">RTA 00</th> <th></th> </tr> </thead> <tbody> <tr> <td></td> <td></td> <td>1 per carton</td> </tr> </tbody> </table>			RTA 00			
OVERALL DIMENSIONS			SEAT DIMENSIONS			BACK DIMENSIONS																																					
W	D	H	W	D	H	W	H																																				
IN 40	20	17	-	-	-	-	-																																				
MM 1016	508	432	-	-	-	-	-																																				
RTA 00																																											
		1 per carton																																									

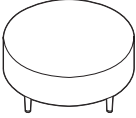
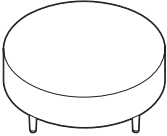
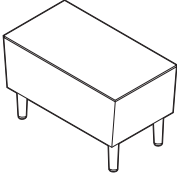
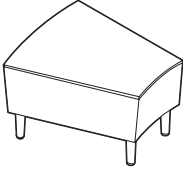
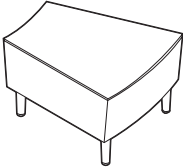
DESCRIPTION	FEATURES	MODEL#	STANDARD TEXTILE GRADES																															
 <p>36" Dia. Round Laminate Coffee Table COM: N/A Unit weight: 63 LB 28.57 KG Carton weight: 63 LB 28.58 KG Carton volume: 15.3 FT³ 0.43 MT³</p>	<p>For power/USB unit, please see electrical placement chart.</p> <p>Freestanding unit only. Add \$267 for 18 lbs. (CW)</p>	<p>R27860</p>	List price																															
			1729																															
			<table border="1"> <thead> <tr> <th colspan="3">OVERALL DIMENSIONS</th> <th colspan="3">SEAT DIMENSIONS</th> <th colspan="2">BACK DIMENSIONS</th> </tr> <tr> <th>W</th> <th>D</th> <th>H</th> <th>W</th> <th>D</th> <th>H</th> <th>W</th> <th>H</th> </tr> </thead> <tbody> <tr> <td>IN 36</td> <td>36</td> <td>17</td> <td>-</td> <td>-</td> <td>-</td> <td>-</td> <td>-</td> </tr> <tr> <td>MM 914</td> <td>914</td> <td>432</td> <td>-</td> <td>-</td> <td>-</td> <td>-</td> <td>-</td> </tr> </tbody> </table>		OVERALL DIMENSIONS			SEAT DIMENSIONS			BACK DIMENSIONS		W	D	H	W	D	H	W	H	IN 36	36	17	-	-	-	-	-	MM 914	914	432	-	-	-
OVERALL DIMENSIONS			SEAT DIMENSIONS			BACK DIMENSIONS																												
W	D	H	W	D	H	W	H																											
IN 36	36	17	-	-	-	-	-																											
MM 914	914	432	-	-	-	-	-																											
 <p>42" Dia. Round Laminate Coffee Table COM: N/A Unit weight: 85 LB 38.55 KG Carton weight: 85 LB 38.56 KG Carton volume: 20.6 FT³ 0.58 MT³</p>	<p>For power/USB unit, please see electrical placement chart.</p> <p>Freestanding unit only. No additional weight required.</p>	<p>R27861</p>	List price																															
			1889																															
			<table border="1"> <thead> <tr> <th colspan="3">OVERALL DIMENSIONS</th> <th colspan="3">SEAT DIMENSIONS</th> <th colspan="2">BACK DIMENSIONS</th> </tr> <tr> <th>W</th> <th>D</th> <th>H</th> <th>W</th> <th>D</th> <th>H</th> <th>W</th> <th>H</th> </tr> </thead> <tbody> <tr> <td>IN 42</td> <td>42</td> <td>17</td> <td>-</td> <td>-</td> <td>-</td> <td>-</td> <td>-</td> </tr> <tr> <td>MM 1067</td> <td>1067</td> <td>432</td> <td>-</td> <td>-</td> <td>-</td> <td>-</td> <td>-</td> </tr> </tbody> </table>		OVERALL DIMENSIONS			SEAT DIMENSIONS			BACK DIMENSIONS		W	D	H	W	D	H	W	H	IN 42	42	17	-	-	-	-	-	MM 1067	1067	432	-	-	-
OVERALL DIMENSIONS			SEAT DIMENSIONS			BACK DIMENSIONS																												
W	D	H	W	D	H	W	H																											
IN 42	42	17	-	-	-	-	-																											
MM 1067	1067	432	-	-	-	-	-																											
 <p>Rectangular Laminate End Table COM: N/A Unit weight: 40 LB 18.14 KG Carton weight: 40 LB 18.14 KG Carton volume: 20.6 FT³ 0.58 MT³</p>	<p>For power/USB unit, please see electrical placement chart.</p> <p>Includes ganging hardware (2 sides). Add \$533 for 36 lbs. (CW)</p>	<p>R27862</p>	List price																															
			1401																															
			<table border="1"> <thead> <tr> <th colspan="3">OVERALL DIMENSIONS</th> <th colspan="3">SEAT DIMENSIONS</th> <th colspan="2">BACK DIMENSIONS</th> </tr> <tr> <th>W</th> <th>D</th> <th>H</th> <th>W</th> <th>D</th> <th>H</th> <th>W</th> <th>H</th> </tr> </thead> <tbody> <tr> <td>IN 28</td> <td>15</td> <td>17</td> <td>-</td> <td>-</td> <td>-</td> <td>-</td> <td>-</td> </tr> <tr> <td>MM 711</td> <td>381</td> <td>432</td> <td>-</td> <td>-</td> <td>-</td> <td>-</td> <td>-</td> </tr> </tbody> </table>		OVERALL DIMENSIONS			SEAT DIMENSIONS			BACK DIMENSIONS		W	D	H	W	D	H	W	H	IN 28	15	17	-	-	-	-	-	MM 711	381	432	-	-	-
OVERALL DIMENSIONS			SEAT DIMENSIONS			BACK DIMENSIONS																												
W	D	H	W	D	H	W	H																											
IN 28	15	17	-	-	-	-	-																											
MM 711	381	432	-	-	-	-	-																											
 <p>Inside Curve Laminate End Table COM: N/A Unit weight: 47 LB 21.31 KG Carton weight: 47 LB 21.32 KG Carton volume: 13.3 FT³ 0.37 MT³</p>	<p>For power/USB unit, please see electrical placement chart.</p> <p>Includes ganging hardware (2 sides). Add \$533 for 36 lbs. (CW)</p>	<p>R27863</p>	List price																															
			1850																															
			<table border="1"> <thead> <tr> <th colspan="3">OVERALL DIMENSIONS</th> <th colspan="3">SEAT DIMENSIONS</th> <th colspan="2">BACK DIMENSIONS</th> </tr> <tr> <th>W</th> <th>D</th> <th>H</th> <th>W</th> <th>D</th> <th>H</th> <th>W</th> <th>H</th> </tr> </thead> <tbody> <tr> <td>IN 28</td> <td>17</td> <td>17</td> <td>-</td> <td>-</td> <td>-</td> <td>-</td> <td>-</td> </tr> <tr> <td>MM 711</td> <td>432</td> <td>432</td> <td>-</td> <td>-</td> <td>-</td> <td>-</td> <td>-</td> </tr> </tbody> </table>		OVERALL DIMENSIONS			SEAT DIMENSIONS			BACK DIMENSIONS		W	D	H	W	D	H	W	H	IN 28	17	17	-	-	-	-	-	MM 711	432	432	-	-	-
OVERALL DIMENSIONS			SEAT DIMENSIONS			BACK DIMENSIONS																												
W	D	H	W	D	H	W	H																											
IN 28	17	17	-	-	-	-	-																											
MM 711	432	432	-	-	-	-	-																											
 <p>Outside Curve Laminate End Table COM: N/A Unit weight: 47 LB 21.31 KG Carton weight: 47 LB 21.32 KG Carton volume: 13.3 FT³ 0.37 MT³</p>	<p>For power/USB unit, please see electrical placement chart.</p> <p>Includes ganging hardware (2 sides). Add \$533 for 36 lbs. (CW)</p>	<p>R27864</p>	List price																															
			1850																															
			<table border="1"> <thead> <tr> <th colspan="3">OVERALL DIMENSIONS</th> <th colspan="3">SEAT DIMENSIONS</th> <th colspan="2">BACK DIMENSIONS</th> </tr> <tr> <th>W</th> <th>D</th> <th>H</th> <th>W</th> <th>D</th> <th>H</th> <th>W</th> <th>H</th> </tr> </thead> <tbody> <tr> <td>IN 28</td> <td>17</td> <td>17</td> <td>-</td> <td>-</td> <td>-</td> <td>-</td> <td>-</td> </tr> <tr> <td>MM 711</td> <td>432</td> <td>432</td> <td>-</td> <td>-</td> <td>-</td> <td>-</td> <td>-</td> </tr> </tbody> </table>		OVERALL DIMENSIONS			SEAT DIMENSIONS			BACK DIMENSIONS		W	D	H	W	D	H	W	H	IN 28	17	17	-	-	-	-	-	MM 711	432	432	-	-	-
OVERALL DIMENSIONS			SEAT DIMENSIONS			BACK DIMENSIONS																												
W	D	H	W	D	H	W	H																											
IN 28	17	17	-	-	-	-	-																											
MM 711	432	432	-	-	-	-	-																											

DESCRIPTION FEATURES MODEL# STANDARD TEXTILE GRADES

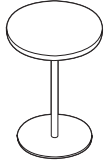

18" Dia. Round Laminate Laptop Table

COM: N/A

Unit weight: 22 LB | 10 KG

Carton weight: 32 LB | 14.51 KG

Carton volume: 6 FT³ | 0.16 MT³

No power/USB unit.

List price

7743 1063

OVERALL DIMENSIONS

W D H

IN 18 18 25.25
MM 457 457 641

SEAT DIMENSIONS

W D H

- - -
- - -

BACK DIMENSIONS

W H

- -
- -

RTA 00  1 per carton

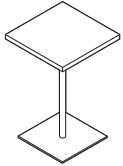

16" Square Laminate Laptop Table

COM: N/A

Unit weight: 26 LB | 11.8 KG

Carton weight: 36 LB | 16.33 KG

Carton volume: 6 FT³ | 0.16 MT³

No power/USB unit.

List price

7745 1035

OVERALL DIMENSIONS

W D H

IN 16 16 25.25
MM 406 406 641

SEAT DIMENSIONS

W D H

- - -
- - -

BACK DIMENSIONS

W H

- -
- -

RTA 00 1 per carton

SIRENA



models 3371 Lounge Chairs, 3373 Two Seat Sofa, 3400 Coffee Table and 3402 End Table



model 3371



model 3372CRTL







STANDARD FEATURES

- Modern club style seating includes: lounge chair, two and three seat sofas.
- Complete with modern tables for reception areas, meeting rooms and private office use.
- Distinctive round style feet are finished in Black only.
- All models have fixed, non-removable seat cushions with arm height at 25" in the front.
- When ordering models with tablet, please specify for left hand or for right hand tablet. See models below.
- Tablets rotate and are non-removable. Overall tablet size is 17"W by 14"D.
- Laminate tops are 1" thick.
- Table legs are 1.5" steel tubing, tapered toward the bottom to 7/8", equipped with self-leveling, pivoting steel glides.
- (C1M) dual wheel carpet casters are standard. Casters are available on lounge chairs only.
- Upholstery options: fabric, vinyl or leather. Vinyl and leather models may feature stitch detail across the seat and/or back cushions, if applicable.

OPTIONAL FEATURES

- Laminate tables, tablets and book shelves are offered in the following laminate finishes: Absolute Acajou (ACJ), Asian Night (ASN), Avant Cherry (AWC), Avant Honey (AWH), Black (BLK), Blizzard (BZD), Clear Maple (CMB), Custom Grey (CGY), Dark Espresso (DES), Designer White (DWT), Fashionista (FAS), First Class (FCL), Noce Biondo (NBL), Noce Grigio (NGL), Noce Leggero (NEL), Noce Medio (NML), Sheer Beauty (SBY), Quatered Mahogany (QTM), Stonedust (SDT), Walnut Heights (WHE), White Chocolate (WHC) and Winter Cherry (WCR). Please specify.
- Table legs are available in Black (TBL) or Tungsten (TTU). No upcharge.

DESCRIPTION	FEATURES	MODEL#	STANDARD TEXTILE GRADES											
			1	2	3	4	5	6	7	8	9	10	11	12
 <p>Lounge Chair Fabric COM: 4.25 YD 3.89 M Unit weight: 45 LB 20.5 KG Carton weight: 52 LB 23.59 KG Carton volume: 19.25 FT³ 0.54 MT³</p>		3371	-	1148	1263	1395	1611	1811	2011	2185	2402	2606	2882	3273
			OVERALL DIMENSIONS			SEAT DIMENSIONS			BACK DIMENSIONS					
				W	D	H	W	D	H	W	H			
				IN 30.5	29.5	28.5	20	20	17.5	19	11.5			
			MM 775	749	724	508	508	445	483	292				
			RTA 00	1 per carton										
 <p>Lounge Chair w/Casters COM: 4.25 YD 3.89 M Unit weight: 47 LB 21.4 KG Carton weight: 52 LB 23.59 KG Carton volume: 19.25 FT³ 0.54 MT³</p>		3371C	-	1242	1357	1489	1705	1905	2105	2279	2496	2700	2976	3367
			OVERALL DIMENSIONS			SEAT DIMENSIONS			BACK DIMENSIONS					
				W	D	H	W	D	H	W	H			
				IN 30.5	29.5	29.5	20	20	18	19	12.5			
			MM 775	749	749	508	508	457	483	318				
			RTA 00	1 per carton										
 <p>3371LTL</p>  <p>3371RTL</p> <p>Lounge Chair w/Laminate Tablet COM: 4.25 YD 3.89 M Unit weight: 53 LB 24.1 KG Carton weight: 58 LB 26.31 KG Carton volume: 19.25 FT³ 0.54 MT³</p>		3371LTL 3371RTL	-	1561	1676	1808	2024	2224	2424	2598	2815	3019	3295	3686
			OVERALL DIMENSIONS			SEAT DIMENSIONS			BACK DIMENSIONS					
				W	D	H	W	D	H	W	H			
				IN 32.5	29.5	28.5	20	20	17.5	19	11.5			
			MM 826	749	724	508	508	445	483	292				
			RTA 00	1 per carton										

DESCRIPTION FEATURES MODEL# STANDARD TEXTILE GRADES



3371CLTL



3371CRTL

Lounge Chair w/Casters & Laminate Tablet

COM: 4.25 YD | 3.89 M
 Unit weight: 57 LB | 25.9 KG
 Carton weight: 62 LB | 28.12 KG
 Carton volume: 19.25 FT³ | 0.54 MT³

1	2	3	4	5	6	7	8	9	10	11	12	
3371CLTL	-	1652	1767	1899	2115	2315	2515	2689	2906	3110	3386	3777
3371CRTL												

OVERALL DIMENSIONS			SEAT DIMENSIONS			BACK DIMENSIONS	
W	D	H	W	D	H	W	H

IN	32	29.5	29.5	20	20	18	19	12.5
MM	813	749	749	508	508	457	483	318

RTA 00 1 per carton



1	2	3	4	5	6	7	8	9	10	11	12	
3372	-	1371	1486	1618	1834	2034	2234	2408	2625	2829	3105	3496

OVERALL DIMENSIONS			SEAT DIMENSIONS			BACK DIMENSIONS	
W	D	H	W	D	H	W	H

IN	30.5	29.5	28.5	20	20	17.5	19	11.5
MM	775	749	724	508	508	445	483	292

RTA 00 1 per carton



1	2	3	4	5	6	7	8	9	10	11	12	
3372C	-	1464	1579	1711	1927	2127	2327	2501	2718	2922	3198	3589

OVERALL DIMENSIONS			SEAT DIMENSIONS			BACK DIMENSIONS	
W	D	H	W	D	H	W	H

IN	30.5	29.5	28.5	20	20	17.5	19	11.5
MM	775	749	724	508	508	445	483	292

RTA 00 1 per carton



3372LTL



3372RTL

Lounge Chair w/Laminate Tablet/Bookshelf

COM: 4.25 YD | 3.89 M
 Unit weight: 58 LB | 26.4 KG
 Carton weight: 66 LB | 29.94 KG
 Carton volume: 19.25 FT³ | 0.54 MT³

1	2	3	4	5	6	7	8	9	10	11	12	
3372LTL	-	1782	1897	2029	2245	2445	2645	2819	3036	3240	3516	3907
3372RTL												

OVERALL DIMENSIONS			SEAT DIMENSIONS			BACK DIMENSIONS	
W	D	H	W	D	H	W	H

IN	32.5	29.5	28.5	20	20	17.5	19	11.5
MM	826	749	724	508	508	445	483	292

RTA 00 1 per carton



3372CLTL



3372CRTL

Lounge Chair w/Casters & Laminate Tablet/Bookshelf





COM: 4.25 YD | 3.89 M
 Unit weight: 58 LB | 26.4 KG
 Carton weight: 66 LB | 29.94 KG
 Carton volume: 19.25 FT³ | 0.54 MT³

1	2	3	4	5	6	7	8	9	10	11	12	
3372CLTL	-	1874	1989	2121	2337	2537	2737	2911	3128	3332	3608	3999
3372CRTL												

OVERALL DIMENSIONS			SEAT DIMENSIONS			BACK DIMENSIONS	
W	D	H	W	D	H	W	H

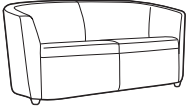
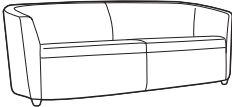
IN	32.5	29.5	28.5	20	20	17.5	19	11.5
MM	826	749	724	508	508	445	483	292

RTA 00 1 per carton

DESCRIPTION	FEATURES	MODEL#	STANDARD TEXTILE GRADES												
			1	2	3	4	5	6	7	8	9	10	11	12	
 <p>Two Seat Sofa COM: 7 YD 6.4 M Unit weight: 82 LB 37.3 KG Carton weight: 92 LB 41.73 KG Carton volume: 48 FT³ 1.35 MT³</p>		3373	-	2036	2225	2442	2799	3128	3457	3744	4101	4437	4892	5536	
				OVERALL DIMENSIONS			SEAT DIMENSIONS			BACK DIMENSIONS					
				W	D	H	W	D	H	W	H				
				IN 62	29.5	28.5	53	20	17.5	53	11.5				
				MM 1575	749	724	1346	508	445	1346	292				
			RTA 00	1 per carton											
 <p>Three Seat Sofa COM: 7.75 YD 7.09 M Unit weight: 97 LB 44.1 KG Carton weight: 107 LB 48.53 KG Carton volume: 55.5 FT³ 1.57 MT³</p>		3374	-	2405	2614	2855	3250	3614	3978	4296	4691	5063	5567	6280	
				OVERALL DIMENSIONS			SEAT DIMENSIONS			BACK DIMENSIONS					
				W	D	H	W	D	H	W	H				
				IN 81.5	29.5	28.5	72.5	20	17.5	72.5	11.5				
				MM 2070	749	724	1842	508	445	1842	292				
			RTA 00	1 per carton											
 <p>Coffee Table - 48" Laminate Top COM: N/A Unit weight: 44 LB 20 KG Carton weight: 52 LB 23.59 KG Carton volume: 17.25 FT³ 0.48 MT³</p>			List price												
		3400	1214												
				OVERALL DIMENSIONS			SEAT DIMENSIONS			BACK DIMENSIONS					
				W	D	H	W	D	H	W	H				
				IN 48	22	14.5	-	-	-	-	-				
			MM 1219	559	368	-	-	-	-	-					
			RTA 00	1 per carton											
 <p>Coffee Table - 56" Laminate Top COM: N/A Unit weight: 50 LB 22.7 KG Carton weight: 60 LB 27.22 KG Carton volume: 19 FT³ 0.53 MT³</p>			List price												
		3401	1346												
				OVERALL DIMENSIONS			SEAT DIMENSIONS			BACK DIMENSIONS					
				W	D	H	W	D	H	W	H				
				IN 56	22	14.5	-	-	-	-	-				
			MM 1422	559	368	-	-	-	-	-					
			RTA 00	1 per carton											
 <p>End Table - Laminate Top COM: N/A Unit weight: 20 LB 9.1 KG Carton weight: 26 LB 11.79 KG Carton volume: 7.75 FT³ 0.21 MT³</p>			List price												
		3402	1007												
				OVERALL DIMENSIONS			SEAT DIMENSIONS			BACK DIMENSIONS					
				W	D	H	W	D	H	W	H				
				IN 17	22	14.5	-	-	-	-	-				
			MM 432	559	368	-	-	-	-	-					
			RTA 00		1 per carton										

VENTURE



48\"/>



78\"/>



60\"/>

STANDARD FEATURES

- Venture is a solid and durable banquette seating series ideal for impromptu meetings.
- Banquettes are available with or without fully upholstered backs. Open back banquettes are intended to be placed against walls or in other layouts where the back will not be visible.
- Heavy duty frame with interlocking plywood, puzzle box construction suitable for public environments.
- Cushions are fixed and non-removable and made with highly resilient foam for extra comfort.
- Ganging bracket kit (8509) gangs two single back models back to back or side by side and double back models side by side. Kit contains two brackets.
- Standard with metal legs and Black glides, suitable for carpet and hard surface flooring.
- Closed back models are fully upholstered for use in open settings and to support reconfiguration.
- Open back models have a Black outer back protective dust cover to be use against walls or for ganging back to back.
- Double back models (#8508-48, #8508-60, #8508-72, #8508-78) measure 55\"/>



OPTIONAL FEATURES

- **Leg finish** (no upcharge)
 - (TBL) Black
 - (CHM) Chrome
 - (TTU) Tungsten
- **Packaging options** (no upcharge)
 - available on double back models only
 - (ST) fully assembled (standard)
 - (KD) knocked down

EXAMPLE VENTURE ORDER CODE:

8506-48	EL58	EL65	TBL	ST
Model #	Back Textile	Seat Textile	Leg Finish	Packaging

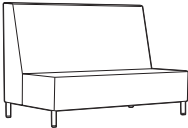
DESCRIPTION	FEATURES	MODEL #	STANDARD TEXTILE GRADES											
			1	2	3	4	5	6	7	8	9	10	11	12
<p>48\"/> COM: 6.75 YD 6.17 M Unit weight: 80 LB 36.4 KG Carton weight: 104 LB 47.17 KG Carton volume: 50.75 FT³ 1.43 MT³</p>		8506-48	3174	3390	3572	3782	4126	4443	4760	5037	5381	5705	6144	6765
			OVERALL DIMENSIONS			SEAT DIMENSIONS			BACK DIMENSIONS					
			W	D	H	W	D	H	W	H				
			IN 48	28	48	48	19	18	48	30				
			MM 1219	711	1219	1219	483	457	1219	762				
		RTA 00	1 per carton											
<p>60\"/> COM: 8 YD 7.32 M Unit weight: 100 LB 45.5 KG Carton weight: 127 LB 57.61 KG Carton volume: 62.75 FT³ 1.77 MT³</p>		8506-60	3703	3959	4175	4423	4831	5207	5583	5911	6319	6703	7223	7959
			OVERALL DIMENSIONS			SEAT DIMENSIONS			BACK DIMENSIONS					
			W	D	H	W	D	H	W	H				
			IN 60	28	48	60	19	18	60	30				
			MM 1524	711	1219	1524	483	457	1524	762				
		RTA 00	1 per carton											
<p>72\"/> COM: 9 YD 8.23 M Unit weight: 120 LB 54.5 KG Carton weight: 153 LB 69.4 KG Carton volume: 75 FT³ 2.12 MT³</p>		8506-72	4122	4410	4653	4932	5391	5814	6237	6606	7065	7497	8082	8910
			OVERALL DIMENSIONS			SEAT DIMENSIONS			BACK DIMENSIONS					
			W	D	H	W	D	H	W	H				
			IN 72	28	48	72	19	18	72	30				
			MM 1829	711	1219	1829	483	457	1829	762				
		RTA 00	1 per carton											

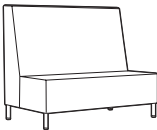
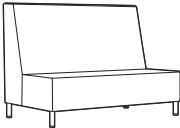
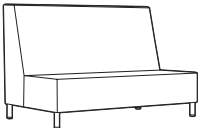
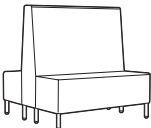
DESCRIPTION	FEATURES	MODEL #	STANDARD TEXTILE GRADES											
			1	2	3	4	5	6	7	8	9	10	11	12
 <p>78\"W Three Seater Banquette, Closed Back COM: 10 YD 9.14 M Unit weight: 130 LB 59.1 KG Carton weight: 163 LB 73.94 KG Carton volume: 79.75 FT³ 2.25 MT³</p>		8506-78	4409	4729	4999	5309	5819	6289	6759	7169	7679	8159	8809	9729
			OVERALL DIMENSIONS			SEAT DIMENSIONS			BACK DIMENSIONS					
			W	D	H	W	D	H	W	H				
			IN 78	28	48	78	19	18	78	30				
			MM 1981	711	1219	1981	483	457	1981	762				
		RTA 00	1 per carton											
 <p>48\"W Two Seater Banquette, Open Back COM: 5 YD 4.57 M Unit weight: 80 LB 36.4 KG Carton weight: 105 LB 47.63 KG Carton volume: 50.75 FT³ 1.43 MT³</p>		8507-48	3012	3172	3307	3462	3717	3952	4187	4392	4647	4887	5212	5672
			OVERALL DIMENSIONS			SEAT DIMENSIONS			BACK DIMENSIONS					
			W	D	H	W	D	H	W	H				
			IN 48	28	48	48	19	18	48	30				
			MM 1219	711	1219	1219	483	457	1219	762				
		RTA 00	1 per carton											
 <p>60\"W Two Seater Banquette, Open Back COM: 6 YD 5.49 M Unit weight: 100 LB 45.5 KG Carton weight: 127 LB 57.61 KG Carton volume: 62.75 FT³ 1.77 MT³</p>		8507-60	3504	3696	3858	4044	4350	4632	4914	5160	5466	5754	6144	6696
			OVERALL DIMENSIONS			SEAT DIMENSIONS			BACK DIMENSIONS					
			W	D	H	W	D	H	W	H				
			IN 60	28	48	60	19	18	60	30				
			MM 1524	711	1219	1524	483	457	1524	762				
		RTA 00	1 per carton											
 <p>72\"W Three Seater Banquette, Open Back COM: 7 YD 6.4 M Unit weight: 120 LB 54.5 KG Carton weight: 153 LB 69.4 KG Carton volume: 75 FT³ 2.12 MT³</p>		8507-72	3885	4109	4298	4515	4872	5201	5530	5817	6174	6510	6965	7609
			OVERALL DIMENSIONS			SEAT DIMENSIONS			BACK DIMENSIONS					
			W	D	H	W	D	H	W	H				
			IN 72	28	48	72	19	18	72	30				
			MM 1829	711	1219	1829	483	457	1829	762				
		RTA 00	1 per carton											
 <p>78\"W Three Seater Banquette, Open Back COM: 8 YD 7.32 M Unit weight: 130 LB 59.1 KG Carton weight: 163 LB 73.94 KG Carton volume: 79.75 FT³ 2.25 MT³</p>		8507-78	4134	4390	4606	4854	5262	5638	6014	6342	6750	7134	7654	8390
			OVERALL DIMENSIONS			SEAT DIMENSIONS			BACK DIMENSIONS					
			W	D	H	W	D	H	W	H				
			IN 78	28	48	78	19	18	78	30				
			MM 1981	711	1219	1981	483	457	1981	762				
		RTA 00	1 per carton											
 <p>48\"W Four Seater Banquette, Double Back COM: 9 YD 8.23 M Unit weight: 128 LB 58.2 KG Carton weight: 163 LB 73.94 KG Carton volume: 89.75 FT³ 2.54 MT³</p>		8508-48	4545	4833	5076	5355	5814	6237	6660	7029	7488	7920	8505	9333
			OVERALL DIMENSIONS			SEAT DIMENSIONS			BACK DIMENSIONS					
			W	D	H	W	D	H	W	H				
			IN 48	55	48	48	19	18	48	30				
			MM 1219	1397	1219	1219	483	457	1219	762				
		RTA 00	1 per carton											

DESCRIPTION FEATURES MODEL # STANDARD TEXTILE GRADES

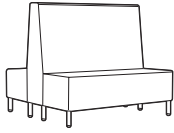

60"W Four Seater Banquette, Double Back
 COM: 10 YD | 9.14 M
 Unit weight: 160 LB | 72.7 KG
 Carton weight: 198 LB | 89.81 KG
 Carton volume: 111 FT³ | 3.14 MT³

Optional knocked down (KD) packaging available (no upcharge)

MODEL #	1	2	3	4	5	6	7	8	9	10	11	12
8508-60	5325	5645	5915	6225	6735	7205	7675	8085	8595	9075	9725	10645

OVERALL DIMENSIONS			SEAT DIMENSIONS			BACK DIMENSIONS	
W	D	H	W	D	H	W	H

IN	60	55	48	60	19	18	60	30
MM	1524	1397	1219	1524	483	457	1524	762

RTA 00 1 per carton

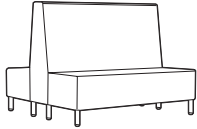

72"W Six Seater Banquette, Double Back
 COM: 11 YD | 10.06 M
 Unit weight: 192 LB | 87.3 KG
 Carton weight: 242 LB | 109.77 KG
 Carton volume: 132.5 FT³ | 3.75 MT³

Optional knocked down (KD) packaging available (no upcharge)

MODEL #	1	2	3	4	5	6	7	8	9	10	11	12
8508-72	5993	6345	6642	6983	7544	8061	8578	9029	9590	10118	10833	11845

OVERALL DIMENSIONS			SEAT DIMENSIONS			BACK DIMENSIONS	
W	D	H	W	D	H	W	H

IN	72	55	48	72	19	18	72	30
MM	1829	1397	1219	1829	483	457	1829	762

RTA 00 1 per carton

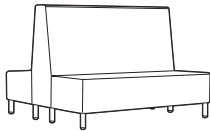

78"W Six Seater Banquette, Double Back
 COM: 12 YD | 10.97 M
 Unit weight: 208 LB | 94.5 KG
 Carton weight: 255 LB | 115.67 KG
 Carton volume: 141.75 FT³ | 4.01 MT³

Optional knocked down (KD) packaging available (no upcharge)

MODEL #	1	2	3	4	5	6	7	8	9	10	11	12
8508-78	6530	6914	7238	7610	8222	8786	9350	9842	10454	11030	11810	12914

OVERALL DIMENSIONS			SEAT DIMENSIONS			BACK DIMENSIONS	
W	D	H	W	D	H	W	H

IN	78	55	48	78	19	18	78	30
MM	1981	1397	1219	1981	483	457	1981	762

RTA 00 1 per carton

List price

8509	75
------	----

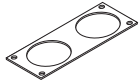

Ganging Bracket Kit
 COM: N/A
 Unit weight: 0.25 LB | - KG
 Carton weight: 0.5 LB | 0.23 KG
 Carton volume: 0.1 FT³ | 0.03 MT³

Kit includes 2 brackets.

OVERALL DIMENSIONS			SEAT DIMENSIONS			BACK DIMENSIONS	
W	D	H	W	D	H	W	H

IN	2.5	6	0.25	-	-	-	-
MM	64	152	6	-	-	-	-

RTA 00  1 per carton

VITROLA



model 8271

model 8275



model 8274, 8275 and 8276

STANDARD FEATURES

- Classic soft seating upholstery design with swooping arms.
- Available in lounge, high back lounge, two seat sofa and three seat sofa.
- Matching ottoman and accent pillow complete the offering.
- Fully upholstered with piping details at the bottom of frame.
- Seat cushions are fixed or sewn tight.
- Standard in tapered maple wood legs. Legs are equipped with White non-marking glides as standard. Suitable for both carpet and hard surface flooring.
- Upholstery options: fabric, vinyl or leather. Vinyl and leather models may feature stitch detail across the seat and/or back cushions, if applicable.
- Back upholstery is continuous without seams. In the event the textile cannot be railroaded, stitch lines will be required (one for 2 seater and two for 3 seater).
- All models ship fully assembled.

OPTIONAL FEATURES

Please add option codes in the following order:

- **Model number**
8271 Lounge chair
8272 Two seat sofa
8273 Three seat sofa
8274 Ottoman
8275 High back lounge chair
8276 Accent pillow
- **Fabric**
Specify fabric code.
- **Wood Legs**
(AB) Absolute (AAM)
(BM) Black (BKM)
(AC) Cherry (ACM)
(EO) English Oak (EOM)
(EC) Espresso Café (ECM)
(HT) Grey (HGM)
(AH) Honey (AHM)
(TM) Mahogany (TMM)
(AM) Maple (AVM)
(MW) Medium Walnut (MWM)
(NL) Natural Walnut (NLW)
(AT) Night (ASM)
(BI) Noce Biondo (NBM)
(GI) Noce Grigio (NGM)
(EI) Noce Leggero (NEM)
(MI) Noce Medio (NMM)
(SH) Shaker Cherry (SKM)
(TF) Fruitwood (TFM)
(TW) Walnut (TWM)
(WR) WC Cream (WTM)
(WH) White (WHM)
(WM) Winter Cherry (WCM)
(colors shown on website)

EXAMPLE VITROLA ORDER CODE:

8271	WA50	HT
Model #	Fabric	Wood Legs

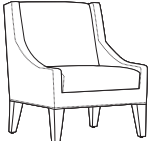
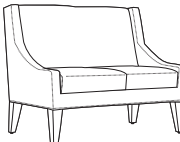
DESCRIPTION	FEATURES	MODEL #	STANDARD TEXTILE GRADES											
			1	2	3	4	5	6	7	8	9	10	11	12
 <p>Lounge Chair COM: 5.25 YD 4.8 M Unit weight: 80 LB 36.4 KG Carton weight: 90 LB 40.82 KG Carton volume: 20.25 FT³ 0.57 MT³</p>		8271	1423	1591	1733	1896	2163	2410	2657	2872	3140	3392	3733	4216
			OVERALL DIMENSIONS			SEAT DIMENSIONS			BACK DIMENSIONS					
			W	D	H	W	D	H	W	H				
			IN 28	31	34	22	20	18	22	16				
			MM 711	787	864	559	508	457	559	406				
		RTA 00	1 per carton											
 <p>Two Seat Sofa COM: 7.25 YD 6.63 M Unit weight: 95 LB 43.2 KG Carton weight: 107 LB 48.53 KG Carton volume: 36.5 FT³ 1.03 MT³</p>		8272	2349	2581	2777	3002	3371	3712	4053	4350	4720	5068	5539	6206
			OVERALL DIMENSIONS			SEAT DIMENSIONS			BACK DIMENSIONS					
			W	D	H	W	D	H	W	H				
			IN 51	31	34	45	20	18	45	16				
			MM 1295	787	864	1143	508	457	1143	406				
		RTA 00	1 per carton											

DESCRIPTION	FEATURES	MODEL #	STANDARD TEXTILE GRADES											
			1	2	3	4	5	6	7	8	9	10	11	12

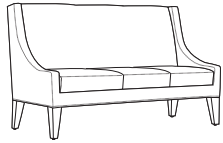

Three Seat Sofa
 COM: 9.25 YD | 8.46 M
 Unit weight: 125 LB | 56.8 KG
 Carton weight: 140 LB | 63.5 KG
 Carton volume: 51.75 FT³ | 1.46 MT³

STANDARD TEXTILE GRADES												
1	2	3	4	5	6	7	8	9	10	11	12	
8273	3113	3409	3659	3946	4417	4852	5287	5666	6138	6582	7183	8034
OVERALL DIMENSIONS			SEAT DIMENSIONS			BACK DIMENSIONS						
W	D	H	W	D	H	W	H					
IN 74.25	31	34	68.25	20	18	68.25	16					
MM 1886	787	864	1734	508	457	1734	406					
RTA 00		1 per carton										

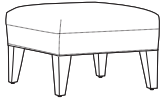

Ottoman
 COM: 1.75 YD | 1.6 M
 Unit weight: 15 LB | 6.8 KG
 Carton weight: 20 LB | 9.07 KG
 Carton volume: 8 FT³ | 0.22 MT³

STANDARD TEXTILE GRADES												
1	2	3	4	5	6	7	8	9	10	11	12	
8274	525	581	628	683	772	854	936	1008	1097	1181	1295	1456
OVERALL DIMENSIONS			SEAT DIMENSIONS			BACK DIMENSIONS						
W	D	H	W	D	H	W	H					
IN 24	24	17	24	-	17	-	-					
MM 610	610	432	610	-	432	-	-					
RTA 00		1 per carton										

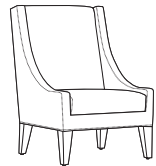

High Back Lounge Chair
 COM: 6.25 YD | 5.72 M
 Unit weight: 85 LB | 38.6 KG
 Carton weight: 96 LB | 43.54 KG
 Carton volume: 28.25 FT³ | 0.79 MT³

STANDARD TEXTILE GRADES												
1	2	3	4	5	6	7	8	9	10	11	12	
8275	1652	1852	2021	2215	2533	2827	3121	3377	3696	3996	4402	4977
OVERALL DIMENSIONS			SEAT DIMENSIONS			BACK DIMENSIONS						
W	D	H	W	D	H	W	H					
IN 28	31	42	22	20	18	22	18					
MM 711	787	1067	559	508	457	559	457					
RTA 00		1 per carton										



Accent Pillow
 COM: 0.75 YD | 0.69 M
 Unit weight: 3 LB | 1.4 KG
 Carton weight: 4 LB | 1.81 KG
 Carton volume: 1 FT³ | 0.02 MT³

STANDARD TEXTILE GRADES												
1	2	3	4	5	6	7	8	9	10	11	12	
8276	175	199	219	243	281	316	351	382	420	456	505	574
OVERALL DIMENSIONS			SEAT DIMENSIONS			BACK DIMENSIONS						
W	D	H	W	D	H	W	H					
IN 23	6	8	-	-	-	-	-					
MM 584	152	203	-	-	-	-	-					
RTA 00		1 per carton										

WIND SEATING



model 3361 (lounge chair), model 3362 (two seat sofa) + model 3367 (coffee table)

ADDITIONAL STITCH DETAIL - ILLUSTRATIONS BELOW

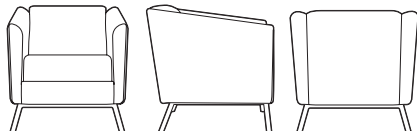

Standard detailing - when upholstered in fabric or vinyl

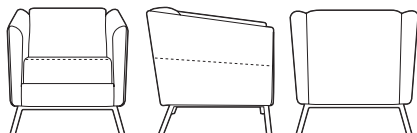

Additional detailing - when upholstered in fabric

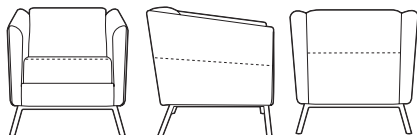

Additional detailing - when upholstered in genuine leather

For Wind tables, please see page 327.
For Wind Linear series, please see page 329. This series includes models with ganging solutions.

STANDARD FEATURES





- The Wind series includes freestanding lounge chairs and tables.
- Wind seating is a contemporary version of the traditional lounge chair with raised legs and is scaled down for smaller spaces.
- Wind seating models are available with metal or wood legs. Please see right column for additional details.
- A variety of glide types are available. Please see right column for additional details. Casters are not available on this series.
- Upholstery options: fabric, vinyl or leather. Vinyl and leather models may feature stitch detail across the seat and/or back cushions, if applicable.
- Available with contrasting fabrics. Specify arms, back and front rail separate from seat cushion.

Please add option codes in the following order:

- **Model number**
3361 to 3363
 Metal leg seating
3431 to 3433
 Wood leg seating
- **Back + arm textile** (includes front rail)
 Specify fabric code.
- **Seat textile**
 Specify fabric code.
- **Leg finish** (metal)
 For leg frame finish options, please see page 379. Upcharges apply for plated finishes:
 (CHM) Chrome. No upcharge.
 (BCH) Brushed Chrome. Add \$49 for lounge chair. Add \$84 for two seat sofa. Add \$174 for three seat sofa.
 (SBR) Satin Brass. Add \$132 for lounge chair. Add \$204 for two seat sofa. Add \$399 for three seat sofa.
 (ACO) Antique Copper. Add \$132 for lounge chair. Add \$204 for two seat sofa. Add \$399 for three seat sofa.
- **Leg finish** (wood)

(AAM) Absolute	(NLW) Natural Walnut
(BKM) Black	(ASM) Night
(ACM) Cherry	(NBM) Noce Biondo
(EOM) English Oak	(NGM) Noce Grigio
(ECM) Espresso Cafe	(NEM) Noce Leggero
(TFM) Fruitwood	(NMM) Noce Medio
(HGM) Gray	(SKM) Shaker Cherry
(AHM) Honey	(TWM) Walnut
(TMM) Mahogany	(WTM) WC Cream
(AVM) Maple	(WHM) White
(MWM) Medium Walnut	(WCM) Winter Cherry
- **Glide type** (metal legs only)
 - (GL) Black glide for most surfaces (standard)
 - (NM) non-marking glides for most surfaces. No upcharge.
- **Glide type** (wood leg seating only)
 - (NM) non-marking glides for most surfaces (standard)
 - (SG) steel cushioned glides for carpeted surfaces. Add \$17.
 - (RG) non-slip rubber glides for most hard floor surfaces. Add \$22.
 - (FG) felt glides for most hard floor surfaces. Add \$22.

DESCRIPTION	FEATURES	MODEL #	STANDARD TEXTILE GRADES											
			1	2	3	4	5	6	7	8	9	10	11	12
 <p>Lounge Chair, Metal Legs COM: 4.5 YD 4.11 M Unit weight: 55 LB 25 KG Carton weight: 62 LB 28.12 KG Carton volume: 16.5 FT³ 0.46 MT³</p>		3361	-	1711	1832	1973	2202	2413	2624	2809	3038	3254	3547	3961
			OVERALL DIMENSIONS			SEAT DIMENSIONS			BACK DIMENSIONS					
			W	D	H	W	D	H	W	H				
			IN 27.5	29	28.5	19.5	19	17	19	12				
			MM 699	737	724	495	483	432	483	305				
			RTA.00		1 per carton									

DESCRIPTION	FEATURES	MODEL#	STANDARD TEXTILE GRADES												
			1	2	3	4	5	6	7	8	9	10	11	12	
 <p>Two Seat Sofa, Metal Legs COM: 6.75 YD 6.17 M Unit weight: 95 LB 43.2 KG Carton weight: 102 LB 46.27 KG Carton volume: 30 FT³ 0.84 MT³</p>		3362	-	2288	2471	2680	3024	3341	3659	3935	4280	4604	5042	5663	
				OVERALL DIMENSIONS			SEAT DIMENSIONS			BACK DIMENSIONS					
				W	D	H	W	D	H	W	H				
				IN 54.5	29	28.5	46.5	19	17	46.5	12				
				MM 1384	737	724	1181	483	432	1181	305				
			RTA 00	1 per carton											
 <p>Three Seat Sofa, Metal Legs COM: 9 YD 8.23 M Unit weight: 125 LB 56.8 KG Carton weight: 135 LB 61.23 KG Carton volume: 42.5 FT³ 1.2 MT³</p>		3363	-	2863	3107	3385	3845	4267	4691	5059	5519	5951	6535	7363	
				OVERALL DIMENSIONS			SEAT DIMENSIONS			BACK DIMENSIONS					
				W	D	H	W	D	H	W	H				
				IN 78	29	28.5	70.5	19	17	70.5	12				
				MM 1981	737	724	1791	483	432	1791	305				
			RTA 00	1 per carton											
 <p>Lounge Chair, Wood Legs COM: 6 YD 5.49 M Unit weight: 53 LB 24.1 KG Carton weight: 59 LB 26.76 KG Carton volume: 16.5 FT³ 0.46 MT³</p>		3431	-	1968	2130	2317	2622	2904	3186	3432	3738	4026	4416	4968	
				OVERALL DIMENSIONS			SEAT DIMENSIONS			BACK DIMENSIONS					
				W	D	H	W	D	H	W	H				
				IN 27.5	29	28.5	19.5	19	17	19	12				
				MM 699	737	724	495	483	432	483	305				
			RTA 00	1 per carton											
 <p>Two Seat Sofa, Wood Legs COM: 6.75 YD 6.17 M Unit weight: 91 LB 41.4 KG Carton weight: 98 LB 44.45 KG Carton volume: 30 FT³ 0.84 MT³</p>		3432	-	2631	2814	3023	3367	3684	4002	4278	4623	4947	5385	6006	
				OVERALL DIMENSIONS			SEAT DIMENSIONS			BACK DIMENSIONS					
				W	D	H	W	D	H	W	H				
				IN 54.5	29	28.5	46.5	19	17	46.5	12				
				MM 1384	737	724	1181	483	432	1181	305				
			RTA 00	1 per carton											
 <p>Three Seat Sofa, Wood Legs COM: 9 YD 8.23 M Unit weight: 119 LB 54.1 KG Carton weight: 129 LB 58.51 KG Carton volume: 42.5 FT³ 1.2 MT³</p>		3433	-	3292	3536	3814	4274	4696	5120	5488	5948	6380	6964	7792	
				OVERALL DIMENSIONS			SEAT DIMENSIONS			BACK DIMENSIONS					
				W	D	H	W	D	H	W	H				
				IN 78	29	28.5	70.5	19	17	70.5	12				
				MM 1981	737	724	1791	483	432	1791	305				
			RTA 00	1 per carton											

WIND TABLES



model 3367 (rectangular coffee table)





For Wind seating, please see page 325.

STANDARD FEATURES

- Wind tables complement the modern decor of many environments, pairing naturally with Wind and Wind Linear lounge seating and other contemporary series (such as Kate, Erin and Marche).
- Wind table models are only available with metal legs. Please see right column for additional details.
- A variety of glide types are available. Please see right column for additional details.
- Table tops are offered in thermally fused laminate finishes to coordinate with Global casegoods and wood seating. They are also available in high pressure laminate (HPL) at a 20% upcharge. Please specify HPL in addition to finish code.

Please add option codes in the following order:

- **Model number**
Specify model number
- **Laminate top finish (LPL)**
Absolute Acajou (ACJ), Asian Night (ASN), Avant Cherry (AWC), Avant Honey (AWH), Black (BLK), Blizzard (BZD), Brushed Cobalt (BRC), Clear Maple (CMB), Custom Grey (CGY), Dark Espresso (DES), Designer White (DWT), Fashionista (FAS), First Class (FCL), Noce Biondo (NBL), Noce Grigio (NGL), Noce Leggero (NEL), Noce Medio (NML), Quartered Mahogany (QTM), Sheer Beauty (SBY), Stonedust (SDT), Storm Grey (SOG), Walnut Heights (WHE), White Chocolate (WHC) and Winter Cherry (WCR).
- **Leg finish**
For leg frame finish options, please see page 379. Upcharges apply for plated finishes:
(CHM) Chrome. No upcharge.
(BCH) Brushed Chrome. Add \$73.
(SBR) Satin Brass. Add \$189.
(ACO) Antique Copper. Add \$189.
- **Glide type**
(GL) Black glide for most surfaces (standard)
(NM) non-marking glides for most surfaces.
No upcharge.

DESCRIPTION	FEATURES	MODEL #	STANDARD TEXTILE GRADES						
 <p>End Table, Metal Legs COM: N/A Unit weight: 24 LB 10.9 KG Carton weight: 36 LB 16.33 KG Carton volume: 11.5 FT³ 0.32 MT³</p>		List price							
		3366	661						
		Laminate top							
		OVERALL DIMENSIONS			SEAT DIMENSIONS			BACK DIMENSIONS	
			W	D	H	W	D	H	W
IN	24	24	17	-	-	-	-	-	
MM	610	610	432	-	-	-	-	-	
		RTA 00	1 per carton						
 <p>Rectangular Coffee Table, Metal Legs COM: N/A Unit weight: 39 LB 17.7 KG Carton weight: 52 LB 23.59 KG Carton volume: 16 FT³ 0.45 MT³</p>		List price							
		3367	886						
		Laminate top							
		OVERALL DIMENSIONS			SEAT DIMENSIONS			BACK DIMENSIONS	
			W	D	H	W	D	H	W
IN	48	20	15	-	-	-	-	-	
MM	1219	508	381	-	-	-	-	-	
		RTA 00	1 per carton						
 <p>Square End Table, Metal Legs COM: N/A Unit weight: 50 LB 22.7 KG Carton weight: 66 LB 29.94 KG Carton volume: 22 FT³ 0.62 MT³</p>		List price							
		3368	1214						
		Laminate top							
		OVERALL DIMENSIONS			SEAT DIMENSIONS			BACK DIMENSIONS	
			W	D	H	W	D	H	W
IN	36	36	15	-	-	-	-	-	
MM	914	914	381	-	-	-	-	-	
		RTA 00	1 per carton						
 <p>Round End Table, Metal Legs COM: N/A Unit weight: 30 LB 13.6 KG Carton weight: 35 LB 15.88 KG Carton volume: 11.5 FT³ 0.32 MT³</p>		List price							
		3870	721						
		Laminate top							
		OVERALL DIMENSIONS			SEAT DIMENSIONS			BACK DIMENSIONS	
			W	D	H	W	D	H	W
IN	24	24	17	-	-	-	-	-	
MM	610	610	432	-	-	-	-	-	
		RTA 00	1 per carton						

DESCRIPTION	FEATURES	MODEL#	STANDARD TEXTILE GRADES							
 <p>Round Coffee Table, Metal Legs COM: N/A Unit weight: 50 LB 22.7 KG Carton weight: 57 LB 25.85 KG Carton volume: 22 FT³ 0.62 MT³</p>			List price							
			3871	1115						
			Laminate top							
			OVERALL DIMENSIONS			SEAT DIMENSIONS			BACK DIMENSIONS	
			W	D	H	W	D	H	W	H
		IN	36	36	15	-	-	-	-	-
		MM	914	914	381	-	-	-	-	-
			RTA 00		1 per carton					

WIND LINEAR SEATING



models 3363R and 3363L with 3882 bridge table, 3360 table attaching bracket kit and two 3880 coffee tables

For Wind Linear tables, please see page 333.

STANDARD FEATURES



- Wind Linear is an extension of the Wind lounge series with an emphasis on expansive, clean lines.
- This modular furniture series includes single arm and armless sofas, benches, bridges and tables.
- Seating can be used as stand-alone products or can be ganged together. See ganging features below for more information.
- Wind Linear seating models are available with metal or wood legs. Please see right column for additional details.
- A variety of glide types are available. Please see right column for additional details. Casters are not available on this series.
- Upholstery options: fabric, vinyl or leather. Vinyl and leather models may feature stitch detail across the seat and/or back cushions, if applicable.
- Available with contrasting fabrics. Specify arms, back and front rail separate from seat cushion.

GANGING

- **Metal leg (seating):**
Table bridges can mount outside or in-between seats to accommodate various work and collaborative settings. Requires table attaching bracket kit 3360.
- **Wood leg (seating):**
Seat-to-seat ganging bracket option is available to gang seating together at armless ends. Option must be selected at the time of the order, the ganging bracket is factory installed and cannot be added in the field. Wind Linear bridge/end tables (models 3882 + 3884) can mount in between seats.
- Benches and ottomans cannot gang with seating units.

Please add option codes in the following order:

- **Model number**
3361L/R/NA, 3363L/R/NA, 3361B + 3363B
Metal leg seating
3431L/R/NA, 3433L/R/NA, 3434B + 3435B
Wood leg seating
- **Back + arm textile** (includes front rail)
Specify fabric code.
- **Seat textile**
Specify fabric code.
- **Leg finish** (metal)
For metal leg frame finish options, please see page 379. Upcharges apply for plated finishes:
(CHM) Chrome. No upcharge.
(BCH) Brushed Chrome. Add \$130 for single seaters. Add \$200 for three seat sofas. Add \$107 for ottoman. Add \$193 for bench.
(SBR) Satin Brass. Add \$275 for single seater. Add \$449 for three seat sofa. Add \$228 for ottoman. Add \$441 for bench.
- **(ACO) Antique Copper.** Add \$275 for single seater. Add \$449 for three seat sofa. Add \$228 for ottoman. Add \$441 for bench.
- **Leg finish** (wood)
(AAM) Absolute (NLW) Natural Walnut
(BKM) Black (ASM) Night
(ACM) Cherry (NBM) Noce Biondo
(EOM) English Oak (NGM) Noce Grigio
(ECM) Espresso Cafe (NEM) Noce Leggero
(TFM) Fruitwood (NMM) Noce Medio
(HGM) Gray (SKM) Shaker Cherry
(AHM) Honey (TWM) Walnut
(TMM) Mahogany (WTM) WC Cream
(AVM) Maple (WHM) White
(MWM) Medium Walnut (WCM) Winter Cherry
- **Glide type** (metal legs only)
(GL) Black glide for most surfaces (standard)
(NM) non-marking glides for most surfaces. No upcharge.
- **Glide type** (wood leg seating only)
(NM) non-marking glides for most surfaces (standard)
(SG) steel cushioned glides for carpeted surfaces. Add \$17.
(RG) non-slip rubber glides for most hard floor surfaces. Add \$22.
(FG) felt glides for most hard floor surfaces. Add \$22.
- **Ganging** (wood leg seating only)
(NG) no ganging (standard)
(GS) ganging seat to seat. See models for upcharges.

DESCRIPTION	FEATURES	MODEL #	STANDARD TEXTILE GRADES											
			1	2	3	4	5	6	7	8	9	10	11	12
 3361R  3361L		3361R	-	1866	1994	2142	2384	2607	2830	3025	3267	3495	3804	4241
		3361L												
			OVERALL DIMENSIONS			SEAT DIMENSIONS			BACK DIMENSIONS					
			W	D	H	W	D	H	W	H	W	H		
			IN 39.5	29	28.5	36	19	17	36	12	36	12		
			MM 1003	737	724	914	483	432	914	305	914	305		
			RTA 00		1 per carton									

Single Seater - w/Left or Right Arm, Metal Legs
 COM: 4.75 YD | 4.34 M
 Unit weight: 62 LB | 28.2 KG
 Carton weight: 72 LB | 32.66 KG
 Carton volume: 28.5 FT³ | 0.8 MT³

DESCRIPTION	FEATURES	MODEL#	STANDARD TEXTILE GRADES											
			1	2	3	4	5	6	7	8	9	10	11	12



Single Seater - Armless, Metal Legs
 COM: 3.25 YD | 2.97 M
 Unit weight: 48 LB | 21.8 KG
 Carton weight: 58 LB | 26.31 KG
 Carton volume: 28.5 FT³ | 0.8 MT³

3361NA	1	2	3	4	5	6	7	8	9	10	11	12
	-	1673	1761	1862	2028	2180	2333	2466	2632	2788	2999	3298
OVERALL DIMENSIONS			SEAT DIMENSIONS			BACK DIMENSIONS						
W	D	H	W	D	H	W	H	W	H			
IN 36.5	29	28.5	36.5	19	17	36.5	12	36.5	12			
MM 927	737	724	927	483	432	927	305	927	305			
RTA 00		1 per carton										



Three Seat Sofa - w/Left or Right Arm, Metal Legs
 COM: 7.75 YD | 7.09 M
 Unit weight: 105 LB | 47.7 KG
 Carton weight: 120 LB | 54.43 KG
 Carton volume: 41 FT³ | 1.16 MT³

3363R 3363L	1	2	3	4	5	6	7	8	9	10	11	12
	-	2672	2881	3122	3517	3881	4245	4563	4958	5330	5834	6547
OVERALL DIMENSIONS			SEAT DIMENSIONS			BACK DIMENSIONS						
W	D	H	W	D	H	W	H	W	H			
IN 75	29	28.5	71	19	17	71	12	71	12			
MM 1905	737	724	1803	483	432	1803	305	1803	305			
RTA 00		1 per carton										



Three Seat Sofa - Armless, Metal Legs
 COM: 6.5 YD | 5.94 M
 Unit weight: 96 LB | 43.6 KG
 Carton weight: 111 LB | 50.35 KG
 Carton volume: 39.25 FT³ | 1.11 MT³

3363NA	1	2	3	4	5	6	7	8	9	10	11	12
	-	2479	2655	2856	3188	3493	3799	4065	4397	4709	5131	5729
OVERALL DIMENSIONS			SEAT DIMENSIONS			BACK DIMENSIONS						
W	D	H	W	D	H	W	H	W	H			
IN 72	29	28.5	72	19	17	72	12	72	12			
MM 1829	737	724	1829	483	432	1829	305	1829	305			
RTA 00		1 per carton										



Ottoman, Metal Legs
 COM: 1.75 YD | 1.6 M
 Unit weight: 38 LB | 17.3 KG
 Carton weight: 50 LB | 22.68 KG
 Carton volume: 12.5 FT³ | 0.35 MT³

3361B	1	2	3	4	5	6	7	8	9	10	11	12
	-	1290	1337	1392	1481	1563	1645	1717	1806	1890	2004	2165
OVERALL DIMENSIONS			SEAT DIMENSIONS			BACK DIMENSIONS						
W	D	H	W	D	H	W	H	W	H			
IN 35.5	20.5	17.5	-	-	-	-	-	-	-			
MM 902	521	445	-	-	-	-	-	-	-			
RTA 00		1 per carton										



Bench, Metal Legs
 COM: 3.5 YD | 3.2 M
 Unit weight: 70 LB | 31.8 KG
 Carton weight: 80 LB | 36.29 KG
 Carton volume: 18.75 FT³ | 0.53 MT³

3363B	1	2	3	4	5	6	7	8	9	10	11	12
	-	1943	2038	2146	2325	2489	2654	2797	2976	3144	3371	3693
OVERALL DIMENSIONS			SEAT DIMENSIONS			BACK DIMENSIONS						
W	D	H	W	D	H	W	H	W	H			
IN 72	20.5	17.5	-	-	17.5	-	-	-	-			
MM 1829	521	445	-	-	445	-	-	-	-			
RTA 00		1 per carton										

DESCRIPTION	FEATURES	MODEL#	STANDARD TEXTILE GRADES																																		
			1	2	3	4	5	6	7	8	9	10	11	12																							
 <p>3431R 3431L</p> <p>Single Seater - w/Left or Right Arm, Wood Legs COM: 4.75 YD 4.34 M Unit weight: 60 LB 27.3 KG Carton weight: 70 LB 31.75 KG Carton volume: 28.5 FT³ 0.8 MT³</p>	Optional ganging bracket (1 unit) for seat to seat on 1 side - add \$12.	3431R	-	2146	2275	2422	2664	2887	3111	3305	3548	3776	4084	4521																							
		<table border="1"> <thead> <tr> <th colspan="3">OVERALL DIMENSIONS</th> <th colspan="3">SEAT DIMENSIONS</th> <th colspan="2">BACK DIMENSIONS</th> </tr> <tr> <th>W</th> <th>D</th> <th>H</th> <th>W</th> <th>D</th> <th>H</th> <th>W</th> <th>H</th> </tr> </thead> <tbody> <tr> <td>IN 39.5</td> <td>29</td> <td>28.5</td> <td>36</td> <td>19</td> <td>17</td> <td>36</td> <td>12</td> </tr> <tr> <td>MM 1003</td> <td>737</td> <td>724</td> <td>914</td> <td>483</td> <td>432</td> <td>914</td> <td>305</td> </tr> </tbody> </table>			OVERALL DIMENSIONS			SEAT DIMENSIONS			BACK DIMENSIONS		W	D	H	W	D	H	W	H	IN 39.5	29	28.5	36	19	17	36	12	MM 1003	737	724	914	483	432	914	305	RTA 00 1 per carton
OVERALL DIMENSIONS			SEAT DIMENSIONS			BACK DIMENSIONS																															
W	D	H	W	D	H	W	H																														
IN 39.5	29	28.5	36	19	17	36	12																														
MM 1003	737	724	914	483	432	914	305																														
 <p>3431NA</p> <p>Single Seater - Armless, Wood Legs COM: 3.25 YD 2.97 M Unit weight: 46 LB 20.9 KG Carton weight: 56 LB 25.4 KG Carton volume: 28.5 FT³ 0.8 MT³</p>	Optional ganging bracket (2 units) for seat to seat on both sides - add \$24.	3431NA	-	1924	2012	2113	2279	2431	2584	2717	2883	3039	3250	3549																							
		<table border="1"> <thead> <tr> <th colspan="3">OVERALL DIMENSIONS</th> <th colspan="3">SEAT DIMENSIONS</th> <th colspan="2">BACK DIMENSIONS</th> </tr> <tr> <th>W</th> <th>D</th> <th>H</th> <th>W</th> <th>D</th> <th>H</th> <th>W</th> <th>H</th> </tr> </thead> <tbody> <tr> <td>IN 36.5</td> <td>29</td> <td>28.5</td> <td>36.5</td> <td>19</td> <td>17</td> <td>36.5</td> <td>12</td> </tr> <tr> <td>MM 927</td> <td>737</td> <td>724</td> <td>927</td> <td>483</td> <td>432</td> <td>927</td> <td>305</td> </tr> </tbody> </table>			OVERALL DIMENSIONS			SEAT DIMENSIONS			BACK DIMENSIONS		W	D	H	W	D	H	W	H	IN 36.5	29	28.5	36.5	19	17	36.5	12	MM 927	737	724	927	483	432	927	305	RTA 00 1 per carton
OVERALL DIMENSIONS			SEAT DIMENSIONS			BACK DIMENSIONS																															
W	D	H	W	D	H	W	H																														
IN 36.5	29	28.5	36.5	19	17	36.5	12																														
MM 927	737	724	927	483	432	927	305																														
 <p>3433R 3433L</p> <p>Three Seat Sofa - w/Left or Right Arm, Wood Legs COM: 7.75 YD 7.09 M Unit weight: 99 LB 45 KG Carton weight: 111 LB 50.35 KG Carton volume: 41 FT³ 1.16 MT³</p>	Optional ganging bracket (1 unit) for seat to seat on 1 side - add \$12.	3433R	-	3073	3283	3523	3918	4282	4647	4964	5360	5732	6235	6948																							
		<table border="1"> <thead> <tr> <th colspan="3">OVERALL DIMENSIONS</th> <th colspan="3">SEAT DIMENSIONS</th> <th colspan="2">BACK DIMENSIONS</th> </tr> <tr> <th>W</th> <th>D</th> <th>H</th> <th>W</th> <th>D</th> <th>H</th> <th>W</th> <th>H</th> </tr> </thead> <tbody> <tr> <td>IN 75</td> <td>29</td> <td>28.5</td> <td>71</td> <td>19</td> <td>17</td> <td>71</td> <td>12</td> </tr> <tr> <td>MM 1905</td> <td>737</td> <td>724</td> <td>1803</td> <td>483</td> <td>432</td> <td>1803</td> <td>305</td> </tr> </tbody> </table>			OVERALL DIMENSIONS			SEAT DIMENSIONS			BACK DIMENSIONS		W	D	H	W	D	H	W	H	IN 75	29	28.5	71	19	17	71	12	MM 1905	737	724	1803	483	432	1803	305	RTA 00 1 per carton
OVERALL DIMENSIONS			SEAT DIMENSIONS			BACK DIMENSIONS																															
W	D	H	W	D	H	W	H																														
IN 75	29	28.5	71	19	17	71	12																														
MM 1905	737	724	1803	483	432	1803	305																														
 <p>3433NA</p> <p>Three Seat Sofa - Armless, Wood Legs COM: 6.5 YD 5.94 M Unit weight: 90 LB 40.9 KG Carton weight: 105 LB 47.63 KG Carton volume: 39.25 FT³ 1.11 MT³</p>	Optional ganging bracket (2 units) for seat to seat on both sides - add \$24.	3433NA	-	2851	3027	3229	3559	3865	4171	4437	4769	5081	5503	6101																							
		<table border="1"> <thead> <tr> <th colspan="3">OVERALL DIMENSIONS</th> <th colspan="3">SEAT DIMENSIONS</th> <th colspan="2">BACK DIMENSIONS</th> </tr> <tr> <th>W</th> <th>D</th> <th>H</th> <th>W</th> <th>D</th> <th>H</th> <th>W</th> <th>H</th> </tr> </thead> <tbody> <tr> <td>IN 72</td> <td>29</td> <td>28.5</td> <td>72</td> <td>19</td> <td>17</td> <td>72</td> <td>12</td> </tr> <tr> <td>MM 1829</td> <td>737</td> <td>724</td> <td>1829</td> <td>483</td> <td>432</td> <td>1829</td> <td>305</td> </tr> </tbody> </table>			OVERALL DIMENSIONS			SEAT DIMENSIONS			BACK DIMENSIONS		W	D	H	W	D	H	W	H	IN 72	29	28.5	72	19	17	72	12	MM 1829	737	724	1829	483	432	1829	305	RTA 00 1 per carton
OVERALL DIMENSIONS			SEAT DIMENSIONS			BACK DIMENSIONS																															
W	D	H	W	D	H	W	H																														
IN 72	29	28.5	72	19	17	72	12																														
MM 1829	737	724	1829	483	432	1829	305																														
 <p>3434B</p> <p>Ottoman, Wood Legs COM: 1.75 YD 1.6 M Unit weight: 36 LB 16.4 KG Carton weight: 48 LB 21.77 KG Carton volume: 12.5 FT³ 0.35 MT³</p>		3434B	-	1484	1531	1586	1675	1757	1839	1911	2000	2084	2198	2359																							
		<table border="1"> <thead> <tr> <th colspan="3">OVERALL DIMENSIONS</th> <th colspan="3">SEAT DIMENSIONS</th> <th colspan="2">BACK DIMENSIONS</th> </tr> <tr> <th>W</th> <th>D</th> <th>H</th> <th>W</th> <th>D</th> <th>H</th> <th>W</th> <th>H</th> </tr> </thead> <tbody> <tr> <td>IN 35.5</td> <td>20.5</td> <td>17.5</td> <td>-</td> <td>-</td> <td>-</td> <td>-</td> <td>-</td> </tr> <tr> <td>MM 902</td> <td>521</td> <td>445</td> <td>-</td> <td>-</td> <td>-</td> <td>-</td> <td>-</td> </tr> </tbody> </table>			OVERALL DIMENSIONS			SEAT DIMENSIONS			BACK DIMENSIONS		W	D	H	W	D	H	W	H	IN 35.5	20.5	17.5	-	-	-	-	-	MM 902	521	445	-	-	-	-	-	RTA 00 1 per carton
OVERALL DIMENSIONS			SEAT DIMENSIONS			BACK DIMENSIONS																															
W	D	H	W	D	H	W	H																														
IN 35.5	20.5	17.5	-	-	-	-	-																														
MM 902	521	445	-	-	-	-	-																														

DESCRIPTION	FEATURES	MODEL#	STANDARD TEXTILE GRADES											
			1	2	3	4	5	6	7	8	9	10	11	12



Bench, Wood Legs
 COM: 3.5 YD | 3.2 M
 Unit weight: 66 LB | 30 KG
 Carton weight: 76 LB | 34.47 KG
 Carton volume: 18.75 FT³ | 0.53 MT³

3435B	1	2	3	4	5	6	7	8	9	10	11	12
	-	2234	2329	2437	2616	2780	2945	3088	3267	3435	3662	3984
OVERALL DIMENSIONS			SEAT DIMENSIONS			BACK DIMENSIONS						
W	D	H	W	D	H	W	H					
IN 72	20.5	17.5	-	-	17.5	-	-					
MM 1829	521	445	-	-	445	-	-					
RTA 00		1 per carton										



Bolster Cushion
 COM: 1 YD | 0.91 M
 Unit weight: 1 LB | 0.5 KG
 Carton weight: 1.5 LB | 0.68 KG
 Carton volume: 1.3 FT³ | 0.03 MT³

1 loose cushion.

3885	1	2	3	4	5	6	7	8	9	10	11	12
	-	133	160	191	242	289	336	377	428	476	541	633
OVERALL DIMENSIONS			SEAT DIMENSIONS			BACK DIMENSIONS						
W	D	H	W	D	H	W	H					
IN 16	5	7	-	-	-	-	-					
MM 406	127	178	-	-	-	-	-					
RTA 00		1 per carton										

WIND LINEAR TABLES



model 3878 (side table - rectangular)

For Wind Linear seating, please see page 329.

STANDARD FEATURES





- Wind Linear is an extension of the Wind lounge series with an emphasis on expansive, clean lines.
- Seating and freestanding tables can be used as stand-alone products. Seating units can be linked together using bridge tables to create infinite configurations.
- Tables are available with metal legs. Please see right column for additional details.
- A variety of glide types are available. Please see right column for additional details. Casters are not available on this series.
- Models are offered in thermally fused laminate finishes to coordinate with Global casegoods and wood seating.









GANGING

- Table bridges can mount outside or in-between seats to accommodate various work and collaborative settings. Requires table attaching bracket kit 3360.
- Bridge corner and end tables mount between chairs and/or sofa units only (at armless ends). Bridge table (model 3884) is only to be used with ottomans and/or benches. Both require table attaching bracket kit 3360.

Please add option codes in the following order:

- **Model number**
3878, 3879, 3880, 3881L + 3883
 Metal leg tables
3882 + 3884
 Bridge tables (no legs)
- **Laminate top finish (LPL)**
 Absolute Acajou (ACJ), Asian Night (ASN), Avant Cherry (AWC), Avant Honey (AWH), Black (BLK), Blizzard (BZD), Brushed Cobalt (BRC), Clear Maple (CMB), Custom Grey (CGY), Dark Espresso (DES), Designer White (DWT), Fashionista (FAS), First Class (FCL), Noce Biondo (NBL), Noce Grigio (NGL), Noce Leggero (NEL), Noce Medio (NML), Quartered Mahogany (QTM), Sheer Beauty (SBY), Stonedust (SDT), Storm Grey (SOG), Walnut Heights (WHE), White Chocolate (WHC) and Winter Cherry (WCR).
- **Leg finish (metal)**
 For metal leg frame finish options, please see page 379. Upcharges apply for plated finishes:
(CHM) Chrome. No upcharge (except on bridge corner table model 3881 - add \$61)
(BCH) Brushed Chrome. Add \$73.
(SBR) Satin Brass. Add \$189.
(ACO) Antique Copper. Add \$189.
- **Glide type (metal legs only)**
(GL) Black glide for most surfaces (standard)
(NM) non-marking glides for most surfaces. No upcharge.

DESCRIPTION	FEATURES	MODEL #	STANDARD TEXTILE GRADES							
 <p>Side Table - Rectangular, Metal Legs COM: N/A Unit weight: 30 LB 13.6 KG Carton weight: 38 LB 17.24 KG Carton volume: 11.5 FT³ 0.32 MT³</p>	Freestanding.	3878	List price							
			1112							
			OVERALL DIMENSIONS W D H			SEAT DIMENSIONS W D H			BACK DIMENSIONS W H	
			IN	20	25	16	-	-	-	-
MM	508	635	406	-	-	-	-	-		
		RTA 00		1 per carton						
 <p>Side Table - 25" Square, Metal Legs COM: N/A Unit weight: 32 LB 14.5 KG Carton weight: 40 LB 18.14 KG Carton volume: 11.5 FT³ 0.32 MT³</p>	Freestanding.	3879	List price							
			1241							
			OVERALL DIMENSIONS W D H			SEAT DIMENSIONS W D H			BACK DIMENSIONS W H	
			IN	25	25	16	-	-	-	-
MM	635	635	406	-	-	-	-	-		
		RTA 00		1 per carton						
 <p>Coffee Table - 54", Metal Legs COM: N/A Unit weight: 39 LB 17.7 KG Carton weight: 52 LB 23.59 KG Carton volume: 16 FT³ 0.45 MT³</p>	Freestanding.	3880	List price							
			1393							
			OVERALL DIMENSIONS W D H			SEAT DIMENSIONS W D H			BACK DIMENSIONS W H	
			IN	54	20	15	-	-	-	-
MM	1372	508	381	-	-	-	-	-		
		RTA 00	1 per carton							

DESCRIPTION	FEATURES	MODEL#	STANDARD TEXTILE GRADES						
 <p>3881R</p>	 <p>3881L</p>	List price							
		3881R	1502						
		3881L							
		OVERALL DIMENSIONS			SEAT DIMENSIONS			BACK DIMENSIONS	
		W	D	H	W	D	H	W	H
		IN 25	25	12	-	-	-	-	-
		MM 635	635	305	-	-	-	-	-
<p>Bridge Corner Table - Right or Left, Metal Legs COM: N/A Unit weight: 25 LB 11.4 KG Carton weight: 33 LB 14.97 KG Carton volume: 11.5 FT³ 0.32 MT³</p>		Requires bracket kit (3360).		Chrome (CHM) leg frame finish - add \$61.		  1 per carton			
		List price							
		3882					789		
		OVERALL DIMENSIONS			SEAT DIMENSIONS			BACK DIMENSIONS	
		W	D	H	W	D	H	W	H
		IN 20	25	5	-	-	-	-	-
		MM 508	635	127	-	-	-	-	-
<p>Bridge End Table COM: N/A Unit weight: 20 LB 9.1 KG Carton weight: 25 LB 11.34 KG Carton volume: 3.4 FT³ 0.09 MT³</p>		Requires bracket kit (3360).		To be used with chair and sofa models. Not usable with bench or ottoman models.		  1 per carton			
		List price							
		3883					1098		
		OVERALL DIMENSIONS			SEAT DIMENSIONS			BACK DIMENSIONS	
		W	D	H	W	D	H	W	H
		IN 20	25	12	-	-	-	-	-
		MM 508	635	305	-	-	-	-	-
<p>Low Side Table, Metal Legs COM: N/A Unit weight: 26 LB 11.8 KG Carton weight: 32 LB 14.51 KG Carton volume: 11.5 FT³ 0.32 MT³</p>		Freestanding.		  1 per carton					
		List price							
		3884					710		
		OVERALL DIMENSIONS			SEAT DIMENSIONS			BACK DIMENSIONS	
		W	D	H	W	D	H	W	H
		IN 20	20	5	-	-	-	-	-
		MM 508	508	127	-	-	-	-	-
<p>Bridge Table - 20" Square COM: N/A Unit weight: 18 LB 8.2 KG Carton weight: 23 LB 10.43 KG Carton volume: 3.4 FT³ 0.09 MT³</p>		Requires bracket kit (3360).		To be used with bench and ottoman models. Not usable with chair or sofa models		 1 per carton			
		List price							
		3360					125		
		OVERALL DIMENSIONS			SEAT DIMENSIONS			BACK DIMENSIONS	
		W	D	H	W	D	H	W	H
		IN 5	7.5	3	-	-	-	-	-
		MM 127	191	76	-	-	-	-	-
<p>Table Bracket Kit COM: N/A Unit weight: 1 LB 0.5 KG Carton weight: 1.5 LB 0.68 KG Carton volume: 0.5 FT³ 0.01 MT³</p>		Kit includes 4 brackets and hardware. Use with models 3881L, 3881R, 3882, 3884, 3436R and 3436L.		1 kit per carton.		