





















# lounge

	Ballara.....	212		Jeo.....	255		River+.....	277
	Braden.....	222		Kate.....	256		Sirena.....	300
	Calidon.....	225		ML.....	257		Venture.....	303
	Camino.....	226		ML Park.....	259		Vitrola.....	306
	Citi.....	231		Prairie.....	260		Wind.....	308
	Citi Square.....	235		Rambler.....	261		Wind Linear.....	312
	Drift.....	244		River.....	263			

**BALLARA**



model 9751

model 9751NA & 9757L

**Quilted seat option**  
4x4 Square grid pattern  
See optional features  
for more details.



model 9752NA Two Seat Sofa, 9755 Corner Table, 9751NA Lounge Chair, 9757L Left Tablet

**STANDARD FEATURES**

- Ballara is a modular series that includes seating, storage, power, tables and tablets.
- It can fulfill many space planning scenarios including corner, in-line, open concept, as well as traditional receptions.
- Furniture pieces, seating or tables can be used as standalone items or linked together with ganging brackets to create infinite configurations.
- Four high back (banquette) models available in two different heights (42" or 48") and two seat options (two-seat or three-seat armless sofas).
- Tablets can be mounted outside to accommodate various work/collaborative settings. Tablets have a 14" round surface and a 2-point locking mechanism for easy handling and stability.
- Fixed cushions are accented by a metal base and frame. Frames are standard in Black.
- Table frames and tablet metal components are standard in Black. Tables feature durable and matching 3mm edges.
- Ganging brackets and power units are standard in Black.
- Power units include one power outlet and two USB ports and can be mounted under any seat or table. Wire management is included.
- Upholstery options: fabric, vinyl or leather. Vinyl and leather models may feature stitch detail across the seat and/or back cushions, if applicable.
- All models are standard with Black polypropylene foot glides.

**OPTIONAL FEATURES**

- Quilted seat (**Q**) is available. Backless stools, add \$131 each. Single seat models, add \$131. Two seater sofa, add \$263. Three seater sofa, add \$395.
- All chair frames, table frames, tablet metal components, ganging brackets and metal brackets are available in paint and plated finishes. Please see page 360 for options. Chrome (**CHM**) or Brushed Chrome (**BCH**) are available with an upcharge. Add \$174 for counter height/bar height stools. Add \$174 for single seat lounge chairs and bench. Add \$231 for two seat sofas and bench. Add \$275 for three seat sofas and bench. Add \$174 for tables. Add \$231 for 2-seat length tables. Add \$85 for tablets. Add \$15 for ganging brackets. Add \$9 for metal brackets on floating tables (BCH finish only).
- Corner tables, storage tables, floating tables and tablets are offered in the following laminate finishes: Absolute Acajou (ACJ), Asian Night (ASN), Avant Cherry (AWC), Avant Honey (AWH), Black (BLK), Blizzard (BZD), Brushed Cobalt (BRC), Clear Maple (CMB), Custom Grey (CGY), Dark Espresso (DES), Designer White (DWT), Fashionista (FAS), First Class (FCL), Noce Biondo (NBL), Noce Grigio (NGL), Noce Leggero (NEL), Noce Medio (NML), Quartered Mahogany (QTM), Sheer Beauty (SBY), Stonedust (SDT), Storm Grey (SOG), Walnut Heights (WHE), White Chocolate (WHC) and Winter Cherry (WCR).

**SAMPLE LAYOUTS**

**Layout A**



Qty	Model Number	Description	Dimensions	List Price
1	<b>9751L</b>	Lounge Chair - Left Arm	28.5 x 31 x 30	1500
1	<b>9751R</b>	Lounge Chair - Right Arm	28.5 x 31 x 30	1500
1	<b>9755</b>	Corner Table	27.25 x 27.25 x 12.5	584
2	<b>9759</b>	Ganging Bracket	1 x 0.75 x 10	19 x 2

**SAMPLE LAYOUT TOTAL IN STANDARD BLACK FRAME 3622**  
**SAMPLE LAYOUT TOTAL IN OPTIONAL FRAME FINISHES 4174**

**Layout B**



Qty	Model Number	Description	Dimensions	List Price
1	<b>9751L</b>	Lounge Chair - Left Arm	28.5 x 31 x 30	1500
1	<b>9751R</b>	Lounge Chair - Right Arm	28.5 x 31 x 30	1500
1	<b>9755</b>	Corner Table	27.25 x 27.25 x 12.5	584
2	<b>9759</b>	Ganging Bracket	1 x 0.75 x 10	19 x 2

**SAMPLE LAYOUT TOTAL IN STANDARD BLACK FRAME 3622**  
**SAMPLE LAYOUT TOTAL IN OPTIONAL FRAME FINISHES 4174**

**Layout C**



Qty	Model Number	Description	Dimensions	List Price
1	<b>9751L</b>	Lounge Chair - Left Arm	28.5 x 31 x 30	1500
1	<b>9751R</b>	Lounge Chair - Right Arm	28.5 x 31 x 30	1500
1	<b>9751NA</b>	Lounge Chair - No Arms	26.5 x 31 x 30	1229
2	<b>9755</b>	Corner Table	27.25 x 27.25 x 12.5	584 x 2
4	<b>9759</b>	Ganging Bracket	1 x 0.75 x 10	19 x 4

**SAMPLE LAYOUT TOTAL IN STANDARD BLACK FRAME 5473**  
**SAMPLE LAYOUT TOTAL IN OPTIONAL FRAME FINISHES 6403**

## SAMPLE LAYOUTS

Layout D



Qty	Model Number	Description	Dimensions	List Price
1	9751L	Lounge Chair - Left Arm	28.5 x 31 x 30	1500
1	9751R	Lounge Chair - Right Arm	28.5 x 31 x 30	1500
1	9751NA	Lounge Chair - Armless	26.5 x 31 x 30	1229
2	9755	Corner Table	27.25 x 27.25 x 12.5	584 x 2
1	9757L	Left Tablet	14 x 17.25 x 14	460
1	9758R	Right Tablet	14 x 17.25 x 14	460
4	9759	Ganging Bracket	1 x 0.75 x 10	19 x 4

**SAMPLE LAYOUT TOTAL IN STANDARD BLACK FRAME 6393**  
**SAMPLE LAYOUT TOTAL IN OPTIONAL FRAME FINISHES 7493**

Layout E

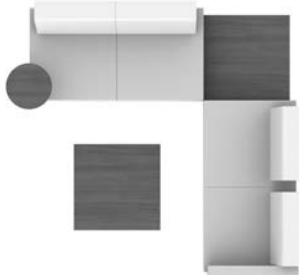

Qty	Model Number	Description	Dimensions	List Price
1	9752L-OB	Two Seat Sofa Open Back - Left Arm	54 x 31 x 30	2459
1	9752NA	Two Seat Sofa - Armless	52 x 31 x 30	2248
1	9754	Storage Table	27.25 x 27.25 x 16.5	953
1	9755	Corner Table	27.25 x 27.25 x 12.5	584
1	9758R	Right Tablet	14 x 17.25 x 14	460
2	9759	Ganging Bracket	1 x 0.75 x 10	19 x 2

**SAMPLE LAYOUT TOTAL IN STANDARD BLACK FRAME 6742**  
**SAMPLE LAYOUT TOTAL IN OPTIONAL FRAME FINISHES 7667**

Layout F

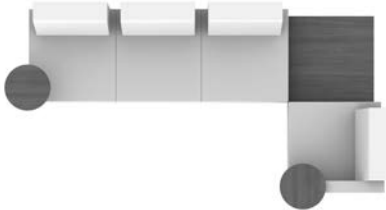

Qty	Model Number	Description	Dimensions	List Price
1	9753NA-OB	Three Seat Sofa Open Back - Armless	80.5 x 31 x 30	3208
1	9751L	Lounge Chair - Left Arm	28.5 x 31 x 30	1500
1	9755	Corner Table	27.25 x 27.25 x 12.5	584
1	9757L	Left Tablet	14 x 17.25 x 14	460
1	9758R	Right Tablet	14 x 17.25 x 14	460
2	9759	Ganging Bracket	1 x 0.75 x 10	19 x 2

**SAMPLE LAYOUT TOTAL IN STANDARD BLACK FRAME 6250**  
**SAMPLE LAYOUT TOTAL IN OPTIONAL FRAME FINISHES 7073**

Layout G

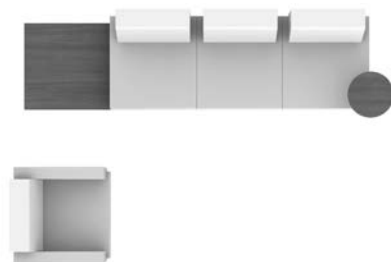

Qty	Model Number	Description	Dimensions	List Price
1	9753NA-OB	Three Seat Sofa Open Back - Armless	80.5 x 31 x 30	3208
1	9751	Lounge Chair	30.5 x 31 x 30	1771
1	9755	Corner Table	27.25 x 27.25 x 12.5	584
1	9757L	Left Tablet	14 x 17.25 x 14	460
1	9759	Ganging Bracket	1 x 0.75 x 10	19

**SAMPLE LAYOUT TOTAL IN STANDARD BLACK FRAME 6061**  
**SAMPLE LAYOUT TOTAL IN OPTIONAL FRAME FINISHES 6799**

Layout H



Qty	Model Number	Description	Dimensions	List Price
1	9751L	Lounge Chair - Left Arm	28.5 x 31 x 30	1500
1	9751R	Lounge Chair - Right Arm	28.5 x 31 x 30	1500
1	9751NA	Lounge Chair - No Arms	26.5 x 31 x 30	1229
2	9755	Corner Table	27.25 x 27.25 x 12.5	584 x 2
4	9759	Ganging Bracket	1 x 0.75 x 10	19 x 4

**SAMPLE LAYOUT TOTAL IN STANDARD BLACK FRAME 5473**  
**SAMPLE LAYOUT TOTAL IN OPTIONAL FRAME FINISHES 6403**

**SAMPLE LAYOUTS**

**Layout I**

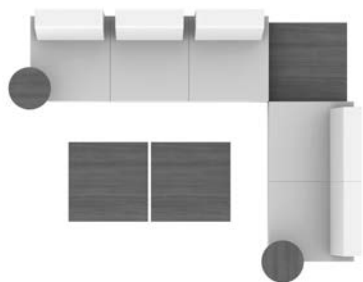

Qty	Model Number	Description	Dimensions	List Price
1	<b>9753NA-OB</b>	Three Seat Sofa Open Back - Armless	80.5 x 31 x 30	3208
1	<b>9752NA</b>	Two Seat Sofa - Armless	52 x 31 x 30	2248
2	<b>9754</b>	Storage Table	27.25 x 27.25 x 16.5	953 x 2
1	<b>9755</b>	Corner Table	27.25 x 27.25 x 12.5	584
1	<b>9757L</b>	Left Tablet	14 x 17.25 x 14	460
1	<b>9758R</b>	Right Tablet	14 x 17.25 x 14	460
2	<b>9759</b>	Ganging Bracket	1 x 0.75 x 10	19 x 2

**SAMPLE LAYOUT TOTAL IN STANDARD BLACK FRAME 8904**  
**SAMPLE LAYOUT TOTAL IN OPTIONAL FRAME FINISHES 10132**

**Layout J**

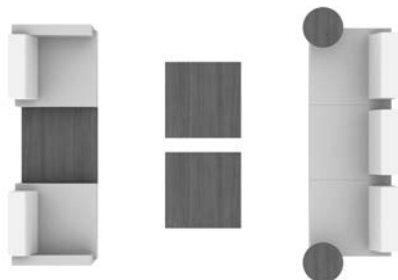

Qty	Model Number	Description	Dimensions	List Price
1	<b>9753NA-OB</b>	Three Seat Sofa Open Back - Armless	80.5 x 31 x 30	3208
1	<b>9751L</b>	Lounge Chair - Left Arm	28.5 x 31 x 30	1500
1	<b>9751R</b>	Lounge Chair - Right Arm	28.5 x 31 x 30	1500
2	<b>9754</b>	Storage Table	27.25 x 27.25 x 16.5	953 x 2
1	<b>9755</b>	Corner Table	27.25 x 27.25 x 12.5	584
1	<b>9757L</b>	Left Tablet	14 x 17.25 x 14	460
1	<b>9758R</b>	Right Tablet	14 x 17.25 x 14	460
2	<b>9759</b>	Ganging Bracket	1 x 0.75 x 10	19 x 2

**SAMPLE LAYOUT TOTAL IN STANDARD BLACK FRAME 9656**  
**SAMPLE LAYOUT TOTAL IN OPTIONAL FRAME FINISHES 11001**

**Layout K**



Qty	Model Number	Description	Dimensions	List Price
2	<b>9753NA-OB</b>	Three Seat Sofa Open Back - Armless	80.5 x 31 x 30	3208 x 2
2	<b>9755</b>	Corner Table	27.25 x 27.25 x 12.5	584 x 2
2	<b>9759</b>	Ganging Bracket	1 x 0.75 x 10	19 x 2

**SAMPLE LAYOUT TOTAL IN STANDARD BLACK FRAME 7622**  
**SAMPLE LAYOUT TOTAL IN OPTIONAL FRAME FINISHES 8550**

**Layout L**



Qty	Model Number	Description	Dimensions	List Price
1	<b>9752NA</b>	Two Seat Sofa - Armless	52 x 31 x 30	2248
1	<b>9751L</b>	Lounge Chair - Left Arm	28.5 x 31 x 30	1500
1	<b>9751R</b>	Lounge Chair - Right Arm	28.5 x 31 x 30	1500
2	<b>9755</b>	Corner Table	27.25 x 27.25 x 12.5	584 x 2
4	<b>9759</b>	Ganging Bracket	1 x 0.75 x 10	19 x 4

**SAMPLE LAYOUT TOTAL IN STANDARD BLACK FRAME 6492**  
**SAMPLE LAYOUT TOTAL IN OPTIONAL FRAME FINISHES 7479**

**Layout M**



Qty	Model Number	Description	Dimensions	List Price
1	<b>9753NA-OB</b>	Three Seat Sofa Open Back - Armless	80.5 x 31 x 30	3208
1	<b>9752L-OB</b>	Two Seat Sofa Open Back - Left Arm	54 x 31 x 30	2459
1	<b>9752NA</b>	Two Seat Sofa - Armless	52 x 31 x 30	2248
2	<b>9755</b>	Corner Table	27.25 x 27.25 x 12.5	584 x 2
1	<b>9754</b>	Storage Table	27.25 x 27.25 x 16.5	953
1	<b>9758R</b>	Right Tablet	14 x 17.25 x 14	460
4	<b>9759</b>	Ganging Bracket	1 x 0.75 x 10	19 x 4

**SAMPLE LAYOUT TOTAL IN STANDARD BLACK FRAME 10572**  
**SAMPLE LAYOUT TOTAL IN OPTIONAL FRAME FINISHES 11976**

## SAMPLE LAYOUTS

### Layout N

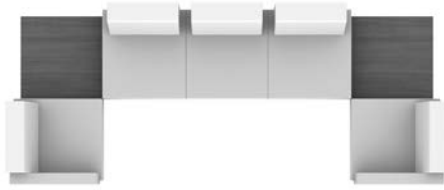

Qty	Model Number	Description	Dimensions	List Price
1	<b>9753NA-OB</b>	Three Seat Sofa Open Back - Armless	80.5 x 31 x 30	3208
1	<b>9751L</b>	Lounge Chair - Left Arm	28.5 x 31 x 30	1500
1	<b>9751R</b>	Lounge Chair - Right Arm	28.5 x 31 x 30	1500
2	<b>9755</b>	Corner Table	27.25 x 27.25 x 12.5	584 x 2
4	<b>9759</b>	Ganging Bracket	1 x 0.75 x 10	19 x 4

<b>SAMPLE LAYOUT TOTAL IN STANDARD BLACK FRAME</b>	<b>7452</b>
<b>SAMPLE LAYOUT TOTAL IN OPTIONAL FRAME FINISHES</b>	<b>8483</b>

### Layout O

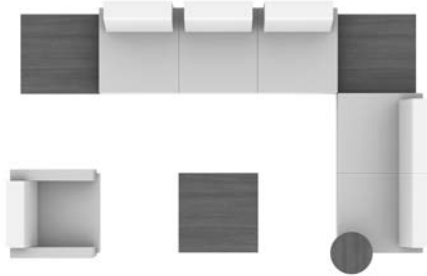

Qty	Model Number	Description	Dimensions	List Price
1	<b>9753NA-OB</b>	Three Seat Sofa Open Back - Armless	80.5 x 31 x 30	3208
1	<b>9752NA</b>	Two Seat Sofa - Armless	52 x 31 x 30	2248
1	<b>9751</b>	Lounge Chair	30.5 x 31 x 30	1771
1	<b>9754</b>	Storage Table	27.25 x 27.25 x 16.5	953
2	<b>9755</b>	Corner Table	27.25 x 27.25 x 12.5	584 x 2
1	<b>9757L</b>	Left Tablet	14 x 17.25 x 14	460
3	<b>9759</b>	Ganging Bracket	1 x 0.75 x 10	19 x 3

<b>SAMPLE LAYOUT TOTAL IN STANDARD BLACK FRAME</b>	<b>9865</b>
<b>SAMPLE LAYOUT TOTAL IN OPTIONAL FRAME FINISHES</b>	<b>11197</b>

### Layout P

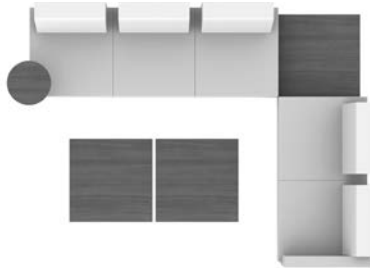

Qty	Model Number	Description	Dimensions	List Price
1	<b>9753NA-OB</b>	Three Seat Sofa Open Back - Armless	80.5 x 31 x 30	3208
1	<b>9752L-OB</b>	Two Seat Sofa Open Back - Left Arm	54 x 31 x 30	2459
2	<b>9754</b>	Storage Table	27.25 x 27.25 x 16.5	953 x 2
1	<b>9755</b>	Corner Table	27.25 x 27.25 x 12.5	584
1	<b>9758R</b>	Right Tablet	14 x 17.25 x 14	460
2	<b>9759</b>	Ganging Bracket	1 x 0.75 x 10	19 x 2

<b>SAMPLE LAYOUT TOTAL IN STANDARD BLACK FRAME</b>	<b>8655</b>
<b>SAMPLE LAYOUT TOTAL IN OPTIONAL FRAME FINISHES</b>	<b>9798</b>

	1	2	3	4	5	6	7	8	9	10	11	12
<b>9751</b>	1771	1907	2022	2154	2370	2570	2770	2944	3161	3365	3641	4032

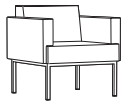

**Lounge Chair**  
 COM: 4.25 YD | 3.89 M  
 Unit weight: 61 LB | 27.7 KG  
 Carton weight: 71 LB | 32.21 KG  
 Carton volume: 21.5 FT³ | 0.6 MT³

	OVERALL DIMENSIONS			SEAT DIMENSIONS			BACK DIMENSIONS	
	W	D	H	W	D	H	W	H

IN	30.5	31	30	24	20.5	18.5	22	12.5
MM	775	787	762	610	521	470	559	318

**RTA 00** 1 per carton

	1	2	3	4	5	6	7	8	9	10	11	12
<b>9751R</b>	1500	1604	1692	1793	1958	2111	2264	2397	2563	2719	2930	3229
<b>9751L</b>												

	OVERALL DIMENSIONS			SEAT DIMENSIONS			BACK DIMENSIONS	
	W	D	H	W	D	H	W	H

IN	28.5	31	30	24	20.5	18.5	22	12.5
MM	724	787	762	610	521	470	559	318

**RTA 00** 1 per carton



9751R



9751L

**Lounge Chair - One Arm**  
 COM: 3.25 YD | 2.97 M  
 Unit weight: 51 LB | 23.2 KG  
 Carton weight: 61 LB | 27.67 KG  
 Carton volume: 20 FT³ | 0.56 MT³

Ganging clip required for sectional use.

R for right arm.  
 L for left arm.

DESCRIPTION	FEATURES	MODEL #	STANDARD TEXTILE GRADES											
			1	2	3	4	5	6	7	8	9	10	11	12



**Lounge Chair - Armless**  
 COM: 2.25 YD | 2.06 M  
 Unit weight: 41 LB | 18.6 KG  
 Carton weight: 51 LB | 23.13 KG  
 Carton volume: 18.75 FT³ | 0.53 MT³

Ganging clip required for sectional use.

MODEL #	OVERALL DIMENSIONS			SEAT DIMENSIONS			BACK DIMENSIONS					
	W	D	H	W	D	H	W	H				
9751NA	2229	1301	1362	1432	1546	1652	1758	1850	1965	2073	2219	2426
	IN 26.5	31	30	24	20.5	18.5			22		12.5	
	MM 673	787	762	610	521	470			559		318	
	<b>RTA 00</b>	1 per carton										



**Corner Unit**  
 COM: 3 YD | 2.74 M  
 Unit weight: 62 LB | 28.2 KG  
 Carton weight: 72 LB | 32.66 KG  
 Carton volume: 18.5 FT³ | 0.52 MT³

Ganging clip required for sectional use.

MODEL #	OVERALL DIMENSIONS			SEAT DIMENSIONS			BACK DIMENSIONS					
	W	D	H	W	D	H	W	H				
9764	1621	1717	1798	1891	2044	2185	2326	2449	2602	2746	2941	3217
	IN 28.5	28.5	30	22	20.5	18.5			22		12.5	
	MM 724	724	762	559	521	470			559		318	
	<b>RTA 00</b>	1 per carton										

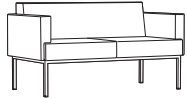

**Two Seat Sofa**  
 COM: 6.25 YD | 5.72 M  
 Unit weight: 99 LB | 45 KG  
 Carton weight: 111 LB | 50.35 KG  
 Carton volume: 37.5 FT³ | 1.06 MT³

MODEL #	OVERALL DIMENSIONS			SEAT DIMENSIONS			BACK DIMENSIONS					
	W	D	H	W	D	H	W	H				
9752	2794	2994	3163	3357	3675	3969	4263	4519	4838	5138	5544	6119
	IN 56	31	30	48	20.5	18.5			44		12.5	
	MM 1422	787	762	1219	521	470			1118		318	
	<b>RTA 00</b>	1 per carton										

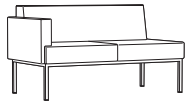

9752R

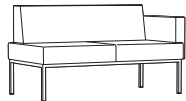

9752L

**Two Seat Sofa**  
 COM: 5 YD | 4.57 M  
 Unit weight: 89 LB | 40.5 KG  
 Carton weight: 101 LB | 45.81 KG  
 Carton volume: 36.25 FT³ | 1.02 MT³

Ganging clip required for sectional use.

R for right arm.  
 L for left arm.

MODEL #	OVERALL DIMENSIONS			SEAT DIMENSIONS			BACK DIMENSIONS					
	W	D	H	W	D	H	W	H				
9752R 9752L	2490	2650	2785	2940	3195	3430	3665	3870	4125	4365	4690	5150
	IN 54	31	30	48	20.5	18.5			44		12.5	
	MM 1372	787	762	1219	521	470			1118		318	
	<b>RTA 00</b>	1 per carton										

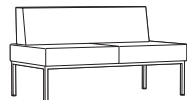

**Two Seat Sofa - Armless**  
 COM: 4 YD | 3.66 M  
 Unit weight: 79 LB | 35.9 KG  
 Carton weight: 91 LB | 41.28 KG  
 Carton volume: 35.5 FT³ | 1 MT³

Ganging clip required for sectional use.

MODEL #	OVERALL DIMENSIONS			SEAT DIMENSIONS			BACK DIMENSIONS					
	W	D	H	W	D	H	W	H				
9752NA	2248	2376	2484	2608	2812	3000	3188	3352	3556	3748	4008	4376
	IN 52	31	30	48	20.5	18.5			44		12.5	
	MM 1321	787	762	1219	521	470			1118		318	
	<b>RTA 00</b>	1 per carton										

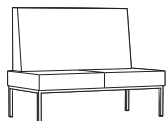

**Two Seat Sofa - 42" High Back**  
 COM: 8 YD | 7.32 M  
 Unit weight: 105 LB | 47.7 KG  
 Carton weight: 120 LB | 54.43 KG  
 Carton volume: 48.5 FT³ | 1.37 MT³

Ganging clip required for sectional use.

MODEL #	OVERALL DIMENSIONS			SEAT DIMENSIONS			BACK DIMENSIONS					
	W	D	H	W	D	H	W	H				
9752NAHB42	2563	2819	3035	3283	3691	4067	4443	4771	5179	5563	6083	6819
	IN 52	31	42	48	20.5	18.5			44		24.5	
	MM 1321	787	1067	1219	521	470			1118		622	
	<b>RTA 00</b>	1 per carton										

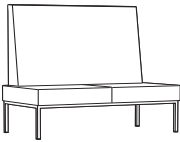
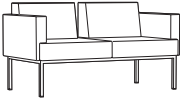
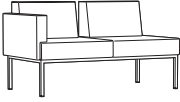
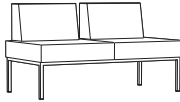
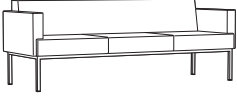
DESCRIPTION	FEATURES	MODEL #	STANDARD TEXTILE GRADES												
			1	2	3	4	5	6	7	8	9	10	11	12	
 <p><b>Two Seat Sofa - 48" High Back</b>                      COM: 8.75 YD   8 M                      Unit weight: 115 LB   52.3 KG                      Carton weight: 130 LB   58.97 KG                      Carton volume: 55 FT³   1.55 MT³</p>	Ganging clip required for sectional use.	<b>9752NAHB48</b>	2671	2951	3187	3459	3905	4316	4727	5086	5532	5952	6521	7326	
			<b>OVERALL DIMENSIONS</b>			<b>SEAT DIMENSIONS</b>			<b>BACK DIMENSIONS</b>						
			<b>W</b>	<b>D</b>	<b>H</b>	<b>W</b>	<b>D</b>	<b>H</b>	<b>W</b>	<b>H</b>					
			IN 52	31	48	48	20.5	18.5	44	30.5					
			MM 1321	787	1219	1219	521	470	1118	775					
		<b>RTA 00</b>	1 per carton												
 <p><b>Two Seat Sofa - Open Back</b>                      COM: 6.25 YD   5.72 M                      Unit weight: 99 LB   45 KG                      Carton weight: 111 LB   50.35 KG                      Carton volume: 35.25 FT³   0.99 MT³</p>		<b>9752-OB</b>	2761	2961	3130	3324	3642	3936	4230	4486	4805	5105	5511	6086	
			<b>OVERALL DIMENSIONS</b>			<b>SEAT DIMENSIONS</b>			<b>BACK DIMENSIONS</b>						
			<b>W</b>	<b>D</b>	<b>H</b>	<b>W</b>	<b>D</b>	<b>H</b>	<b>W</b>	<b>H</b>					
			IN 56	29.5	30	54	20.5	18.5	48	12.5					
			MM 1422	749	762	1372	521	470	1219	318					
		<b>RTA 00</b>	1 per carton												
 <p><b>Two Seat Sofa - Open Back - One Arm</b>                      COM: 5.25 YD   4.8 M                      Unit weight: 89 LB   40.5 KG                      Carton weight: 101 LB   45.81 KG                      Carton volume: 36.25 FT³   1.02 MT³</p>	Ganging clip required for sectional use.  R for right arm. L for left arm.	<b>9752R-OB</b> <b>9752L-OB</b>	2459	2627	2769	2932	3199	3446	3693	3908	4176	4428	4769	5252	
			<b>OVERALL DIMENSIONS</b>			<b>SEAT DIMENSIONS</b>			<b>BACK DIMENSIONS</b>						
			<b>W</b>	<b>D</b>	<b>H</b>	<b>W</b>	<b>D</b>	<b>H</b>	<b>W</b>	<b>H</b>					
			IN 54	31	30	48	20.5	18.5	44	12.5					
			MM 1372	787	762	1219	521	470	1118	318					
		<b>RTA 00</b>	1 per carton												
 <p><b>Two Seat Sofa - Open Back - Armless</b>                      COM: 4.25 YD   3.89 M                      Unit weight: 79 LB   35.9 KG                      Carton weight: 91 LB   41.28 KG                      Carton volume: 35.5 FT³   1 MT³</p>		<b>9752NA-OB</b>	2218	2354	2469	2601	2817	3017	3217	3391	3608	3812	4088	4479	
			<b>OVERALL DIMENSIONS</b>			<b>SEAT DIMENSIONS</b>			<b>BACK DIMENSIONS</b>						
			<b>W</b>	<b>D</b>	<b>H</b>	<b>W</b>	<b>D</b>	<b>H</b>	<b>W</b>	<b>H</b>					
			IN 52	31	30	48	20.5	18.5	44	12.5					
			MM 1321	787	762	1219	521	470	1118	318					
		<b>RTA 00</b>	1 per carton												
 <p><b>Three Seat Sofa</b>                      COM: 9.5 YD   8.69 M                      Unit weight: 138 LB   62.7 KG                      Carton weight: 153 LB   69.4 KG                      Carton volume: 54.5 FT³   1.54 MT³</p>		<b>9753</b>	3784	4088	4345	4639	5124	5570	6017	6406	6891	7347	7964	8838	
			<b>OVERALL DIMENSIONS</b>			<b>SEAT DIMENSIONS</b>			<b>BACK DIMENSIONS</b>						
			<b>W</b>	<b>D</b>	<b>H</b>	<b>W</b>	<b>D</b>	<b>H</b>	<b>W</b>	<b>H</b>					
			IN 82.5	31	30	76.5	20.5	18.5	66	12.5					
			MM 2096	787	762	1943	521	470	1676	318					
		<b>RTA 00</b>	1 per carton												

DESCRIPTION	FEATURES	MODEL #	STANDARD TEXTILE GRADES											
			1	2	3	4	5	6	7	8	9	10	11	12

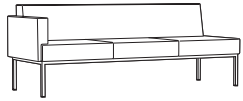

9753R

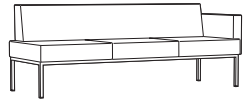

9753L

**Three Seat Sofa - One Arm**

COM: 8.25 YD | 7.54 M  
 Unit weight: 128 LB | 58.2 KG  
 Carton weight: 143 LB | 64.86 KG  
 Carton volume: 54.5 FT<sup>3</sup> | 1.54 MT<sup>3</sup>

Ganging clip required for sectional use.

R for right arm.  
 L for left arm.

<b>9753R</b>	3528	3792	4015	4271	4691	5079	5467	5805	6226	6622	7158	7917
<b>9753L</b>												

OVERALL DIMENSIONS			SEAT DIMENSIONS			BACK DIMENSIONS		
W	D	H	W	D	H	W	H	

IN	81.5	31	30	80.5	20.5	18.5	74	12.5
MM	2070	787	762	2045	521	470	1880	318

**RTA 00** 1 per carton

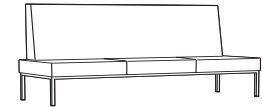

**Three Seat Sofa - 42" High Back**

COM: 12.25 YD | 11.2 M  
 Unit weight: 128 LB | 58.2 KG  
 Carton weight: 143 LB | 64.86 KG  
 Carton volume: 72.5 FT<sup>3</sup> | 2.05 MT<sup>3</sup>

Ganging clip required for sectional use.

<b>9753NAHB42</b>	3912	4304	4635	5015	5639	6215	6791	7293	7918	8506	9302	10429
-------------------	------	------	------	------	------	------	------	------	------	------	------	-------

OVERALL DIMENSIONS			SEAT DIMENSIONS			BACK DIMENSIONS		
W	D	H	W	D	H	W	H	

IN	80.5	31	42	74	20.5	18.5	74	24.5
MM	2045	787	1067	1880	521	470	1880	622

**RTA 00** 1 per carton

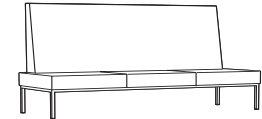

**Three Seat Sofa - 48" High Back**

COM: 13.25 YD | 12.12 M  
 Unit weight: 153 LB | 69.5 KG  
 Carton weight: 168 LB | 76.2 KG  
 Carton volume: 82.25 FT<sup>3</sup> | 2.32 MT<sup>3</sup>

Ganging clip required for sectional use.

<b>9753NAHB48</b>	4144	4568	4926	5337	6012	6635	7258	7801	8477	9113	9974	11193
-------------------	------	------	------	------	------	------	------	------	------	------	------	-------

OVERALL DIMENSIONS			SEAT DIMENSIONS			BACK DIMENSIONS		
W	D	H	W	D	H	W	H	

IN	80.5	31	48	80.5	20.5	18.5	74	30.5
MM	2045	787	1219	2045	521	470	1880	775

**RTA 00** 1 per carton

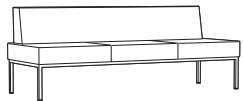

**Three Seat Sofa - Armless**

COM: 7 YD | 6.4 M  
 Unit weight: 118 LB | 53.6 KG  
 Carton weight: 133 LB | 60.33 KG  
 Carton volume: 51.5 FT<sup>3</sup> | 1.45 MT<sup>3</sup>

Ganging clip required for sectional use.

<b>9753NA</b>	3240	3464	3653	3870	4227	4556	4885	5172	5529	5865	6320	6964
---------------	------	------	------	------	------	------	------	------	------	------	------	------

OVERALL DIMENSIONS			SEAT DIMENSIONS			BACK DIMENSIONS		
W	D	H	W	D	H	W	H	

IN	80.5	31	30	80.5	20.5	18.5	74	12.5
MM	2045	787	762	2045	521	470	1880	318

**RTA 00** 1 per carton

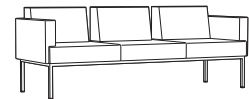

**Three Seat Sofa - Open Back**

COM: 8 YD | 7.32 M  
 Unit weight: 138 LB | 62.7 KG  
 Carton weight: 153 LB | 69.4 KG  
 Carton volume: 54.5 FT<sup>3</sup> | 1.54 MT<sup>3</sup>

Ganging clip required for sectional use.

<b>9753-OB</b>	3751	4007	4223	4471	4879	5255	5631	5959	6367	6751	7271	8007
----------------	------	------	------	------	------	------	------	------	------	------	------	------

OVERALL DIMENSIONS			SEAT DIMENSIONS			BACK DIMENSIONS		
W	D	H	W	D	H	W	H	

IN	82.5	31	30	80.5	20.5	18.5	74	12.5
MM	2096	787	762	2045	521	470	1880	318

**RTA 00** 1 per carton

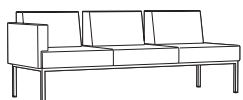

9753R-OB

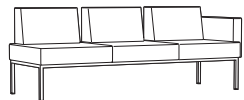

9753L-OB

**Three Seat Sofa - Open Back - One Arm**

COM: 7 YD | 6.4 M  
 Unit weight: 128 LB | 58.2 KG  
 Carton weight: 143 LB | 64.86 KG  
 Carton volume: 54.5 FT<sup>3</sup> | 1.54 MT<sup>3</sup>

Ganging clip required for sectional use.

R for right arm.  
 L for left arm.









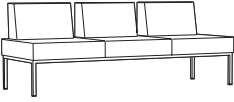

<b>9753R-OB</b>	3495	3719	3908	4125	4482	4811	5140	5427	5784	6120	6575	7219
<b>9753L-OB</b>												





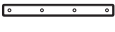

OVERALL DIMENSIONS			SEAT DIMENSIONS			BACK DIMENSIONS		
W	D	H	W	D	H	W	H	

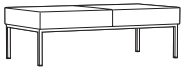
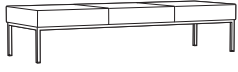

IN	81.5	31	30	80.5	20.5	18.5	74	12.5
MM	2070	787	762	2045	521	470	1880	318

**RTA 00** 1 per carton



DESCRIPTION	FEATURES	MODEL #	STANDARD TEXTILE GRADES											
			1	2	3	4	5	6	7	8	9	10	11	12
 <p><b>Three Seat Sofa - Open Back - Armless</b>                      COM: 6.25 YD   5.72 M                      Unit weight: 118 LB   53.6 KG                      Carton weight: 133 LB   60.33 KG                      Carton volume: 51.5 FT³   1.45 MT³</p>	Ganging clip required for sectional use.	<b>9753NA-OB</b>	3208	3408	3577	3771	4089	4383	4677	4933	5252	5552	5958	6533
			<b>OVERALL DIMENSIONS</b>			<b>SEAT DIMENSIONS</b>			<b>BACK DIMENSIONS</b>					
			W	D	H	W	D	H	W	H				
			IN 80.5 MM 2045	31 787	30 762	80.5 2045	20.5 521	18.5 470	74 1880	12.5 318				
			<b>RTA 00</b>	1 per carton										
			List price											
			<b>9754</b>	953										
 <p><b>Storage Table</b>                      COM: N/A                      Unit weight: 59 LB   26.8 KG                      Carton weight: 65 LB   29.48 KG                      Carton volume: 11.5 FT³   0.32 MT³</p>	Ganging clip required for sectional use.	<b>9754</b>	27.25	27.25	16.5	-	-	-	-	-	-	-	-	-
			<b>OVERALL DIMENSIONS</b>			<b>SEAT DIMENSIONS</b>			<b>BACK DIMENSIONS</b>					
			W	D	H	W	D	H	W	H				
			IN 27.25 MM 692	27.25 692	16.5 419	-	-	-	-	-	-			
			<b>RTA 00</b>		1 per carton									
			List price											
			<b>9755</b>	584										
 <p><b>Corner Table</b>                      COM: N/A                      Unit weight: 34 LB   15.5 KG                      Carton weight: 40 LB   18.14 KG                      Carton volume: 8 FT³   0.22 MT³</p>	Ganging clip required for sectional use.	<b>9755</b>	27.25	27.25	12.5	-	-	-	-	-	-	-	-	-
			<b>OVERALL DIMENSIONS</b>			<b>SEAT DIMENSIONS</b>			<b>BACK DIMENSIONS</b>					
			W	D	H	W	D	H	W	H				
			IN 27.25 MM 692	27.25 692	12.5 318	-	-	-	-	-	-			
			<b>RTA 00</b>		1 per carton									
			List price											
			<b>9755</b>	584										
 <p><b>Tablet</b>                      COM: N/A                      Unit weight: 9 LB   4.1 KG                      Carton weight: 12 LB   5.44 KG                      Carton volume: 2.5 FT³   0.07 MT³</p>	Mounts underneath of seating.  R for right hand tablet. L for left hand tablet.	<b>9757L</b> <b>9758R</b>	14	17.25	14	-	-	-	-	-	-	-	-	-
			<b>OVERALL DIMENSIONS</b>			<b>SEAT DIMENSIONS</b>			<b>BACK DIMENSIONS</b>					
			W	D	H	W	D	H	W	H				
			IN 14 MM 356	17.25 438	14 356	-	-	-	-	-	-			
			<b>RTA 00</b>		1 per carton									
			List price											
			<b>9757L</b> <b>9758R</b>	460										
 <p><b>Ganging Bracket</b>                      COM: N/A                      Unit weight: 0.25 LB   0.1 KG                      Carton weight: 0.52 LB   0.24 KG                      Carton volume: 0.5 FT³   0.01 MT³</p>	One bracket is required per connection.	<b>9759</b>	1	0.75	10	-	-	-	-	-	-	-	-	
			<b>OVERALL DIMENSIONS</b>			<b>SEAT DIMENSIONS</b>			<b>BACK DIMENSIONS</b>					
			W	D	H	W	D	H	W	H				
			IN 1 MM 25	0.75 19	10 254	-	-	-	-	-	-			
			<b>RTA 00</b>		25 per carton									
			List price											
			<b>9759</b>	19										
 <p><b>Power Unit w/10 Ft. power cord</b>                      COM: N/A                      Unit weight: 2 LB   0.9 KG                      Carton weight: 3 LB   1.36 KG                      Carton volume: 0.5 FT³   0.01 MT³</p>	Mounts underneath of seating or tables.  One power outlet and two USB ports.	<b>9760</b>	6	2.75	2.75	-	-	-	-	-	-	-	-	
			<b>OVERALL DIMENSIONS</b>			<b>SEAT DIMENSIONS</b>			<b>BACK DIMENSIONS</b>					
			W	D	H	W	D	H	W	H				
			IN 6 MM 152	2.75 70	2.75 70	-	-	-	-	-	-			
			<b>RTA 00</b>		1 per carton									

DESCRIPTION	FEATURES	MODEL #	STANDARD TEXTILE GRADES														
			1	2	3	4	5	6	7	8	9	10	11	12			
 <p><b>One Seat Bench</b> COM: 2 YD   1.83 M Unit weight: 31 LB   14.1 KG Carton weight: 37 LB   16.78 KG Carton volume: 10.75 FT³   0.3 MT³</p>	Ganging clip required for sectional use.	<b>9761</b>	939	1003	1057	1119	1221	1315	1409	1491	1593	1689	1819	2003			
			OVERALL DIMENSIONS			SEAT DIMENSIONS			BACK DIMENSIONS								
			W	D	H	W	D	H	W	H							
			IN 27.5	28.5	17.5	27.5	28.5	18.5	-	-							
			MM 699	724	445	699	724	470	-	-							
		<b>RTA 00</b>	1 per carton														
 <p><b>Two Seat Bench</b> COM: 4 YD   3.66 M Unit weight: 49 LB   22.3 KG Carton weight: 57 LB   25.85 KG Carton volume: 21.25 FT³   0.6 MT³</p>	Ganging clip required for sectional use.	<b>9762</b>	1668	1796	1904	2028	2232	2420	2608	2772	2976	3168	3428	3796			
			OVERALL DIMENSIONS			SEAT DIMENSIONS			BACK DIMENSIONS								
			W	D	H	W	D	H	W	H							
			IN 54	28.5	17.5	54	28.5	18.5	-	-							
			MM 1372	724	445	1372	724	470	-	-							
		<b>RTA 00</b>	1 per carton														
 <p><b>Three Seat Bench</b> COM: 6 YD   5.49 M Unit weight: 70 LB   31.8 KG Carton weight: 80 LB   36.29 KG Carton volume: 29.5 FT³   0.83 MT³</p>	Ganging clip required for sectional use.	<b>9763</b>	2394	2586	2748	2934	3240	3522	3804	4050	4356	4644	5034	5586			
			OVERALL DIMENSIONS			SEAT DIMENSIONS			BACK DIMENSIONS								
			W	D	H	W	D	H	W	H							
			IN 80.5	28.5	17.5	80.5	28.5	18.5	-	-							
			MM 2045	724	445	2045	724	470	-	-							
		<b>RTA 00</b>	1 per carton														
 <p><b>Coffee Storage Table (2 Seat Length)</b> COM: N/A Unit weight: 102 LB   46.4 KG Carton weight: 112 LB   50.8 KG Carton volume: 20.5 FT³   0.58 MT³</p>	Ganging clip required for sectional use.	List price															
		<b>9765</b>	1503														
			OVERALL DIMENSIONS			SEAT DIMENSIONS			BACK DIMENSIONS								
			W	D	H	W	D	H	W	H							
			IN 53.75	27.25	16.5	-	-	-	-	-							
MM 1365	692		419	-	-	-	-	-									
		<b>RTA 00</b>		1 per carton													
 <p><b>Coffee Table (2 Seat Length)</b> COM: N/A Unit weight: 56 LB   25.5 KG Carton weight: 68 LB   30.84 KG Carton volume: 17.75 FT³   0.5 MT³</p>	Freestanding.	List price															
		<b>9766</b>	969														
			OVERALL DIMENSIONS			SEAT DIMENSIONS			BACK DIMENSIONS								
			W	D	H	W	D	H	W	H							
			IN 54	27.5	13	-	-	-	-	-							
MM 1372	699		330	-	-	-	-	-									
		<b>RTA 00</b>		1 per carton													
 <p><b>Floating Side Table</b> COM: N/A Unit weight: 15 LB   6.8 KG Carton weight: 20 LB   9.07 KG Carton volume: 2.2 FT³   0.06 MT³</p>	To be used in between chair/sofa models.	List price															
		<b>9767</b>	501														
			OVERALL DIMENSIONS			SEAT DIMENSIONS			BACK DIMENSIONS								
			W	D	H	W	D	H	W	H							
			IN 13.5	27.25	1	-	-	-	-	-							
MM 343	692		25	-	-	-	-	-									
		<b>RTA 00</b>		1 per carton													

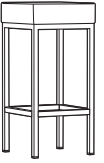
DESCRIPTION	FEATURES	MODEL #	STANDARD TEXTILE GRADES																																				
		List price																																					
		9768	704																																				
 <p><b>Floating Storage Side Table</b> COM: N/A Unit weight: 15 LB   6.8 KG Carton weight: 20 LB   9.07 KG Carton volume: 2.2 FT<sup>3</sup>   0.06 MT<sup>3</sup></p>		To be used in between chair/sofa models.	<b>OVERALL DIMENSIONS</b> W D H			<b>SEAT DIMENSIONS</b> W D H			<b>BACK DIMENSIONS</b> W H																														
		IN	13.5	27.25	5	-	-	-	-	-	-	-																											
		MM	343	692	127	-	-	-	-	-	-	-																											
		<b>RTA 00</b>	courier 1 per carton																																				
		<table border="1"> <thead> <tr> <th></th> <th>1</th> <th>2</th> <th>3</th> <th>4</th> <th>5</th> <th>6</th> <th>7</th> <th>8</th> <th>9</th> <th>10</th> <th>11</th> <th>12</th> </tr> </thead> <tbody> <tr> <td><b>9769S24</b></td> <td>587</td> <td>611</td> <td>631</td> <td>655</td> <td>693</td> <td>728</td> <td>763</td> <td>794</td> <td>832</td> <td>868</td> <td>917</td> <td>986</td> </tr> </tbody> </table>													1	2	3	4	5	6	7	8	9	10	11	12	<b>9769S24</b>	587	611	631	655	693	728	763	794	832	868	917	986
	1	2	3	4	5	6	7	8	9	10	11	12																											
<b>9769S24</b>	587	611	631	655	693	728	763	794	832	868	917	986																											
 <p><b>24" Stool</b> COM: 0.75 YD   0.69 M Unit weight: 17 LB   7.7 KG Carton weight: 22 LB   9.98 KG Carton volume: 4.75 FT<sup>3</sup>   0.13 MT<sup>3</sup></p>		<b>OVERALL DIMENSIONS</b> W D H			<b>SEAT DIMENSIONS</b> W D H			<b>BACK DIMENSIONS</b> W H																															
		IN	15	15	24	-	-	24	-	-	-	-																											
		MM	381	381	610	-	-	610	-	-	-	-																											
		<b>RTA 00</b>	1 per carton																																				
		<table border="1"> <thead> <tr> <th></th> <th>1</th> <th>2</th> <th>3</th> <th>4</th> <th>5</th> <th>6</th> <th>7</th> <th>8</th> <th>9</th> <th>10</th> <th>11</th> <th>12</th> </tr> </thead> <tbody> <tr> <td><b>9769S30</b></td> <td>656</td> <td>680</td> <td>700</td> <td>724</td> <td>762</td> <td>797</td> <td>832</td> <td>863</td> <td>901</td> <td>937</td> <td>986</td> <td>1055</td> </tr> </tbody> </table>													1	2	3	4	5	6	7	8	9	10	11	12	<b>9769S30</b>	656	680	700	724	762	797	832	863	901	937	986	1055
	1	2	3	4	5	6	7	8	9	10	11	12																											
<b>9769S30</b>	656	680	700	724	762	797	832	863	901	937	986	1055																											
 <p><b>30" Stool</b> COM: 0.75 YD   0.69 M Unit weight: 18 LB   8.2 KG Carton weight: 23 LB   10.43 KG Carton volume: 5.5 FT<sup>3</sup>   0.15 MT<sup>3</sup></p>		<b>OVERALL DIMENSIONS</b> W D H			<b>SEAT DIMENSIONS</b> W D H			<b>BACK DIMENSIONS</b> W H																															
		IN	15	15	30	-	-	30	-	-	-	-																											
		MM	381	381	762	-	-	762	-	-	-	-																											
		<b>RTA 00</b>	1 per carton																																				

**BRADEN**



model 7871

models 7870R, 7870, 7870L, 7872, 7873

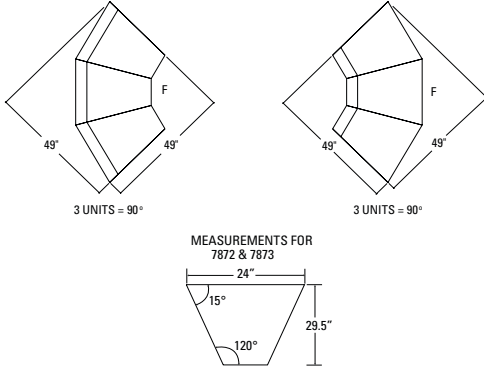

**STANDARD FEATURES**

- A flexible modular seating system that is exceptionally durable. Combine these seating components into a configuration that suits your space.
- Braden uses a unique ganging feature which locks units solidly together, but allows them to be separated and reconfigured when necessary.
- Locking "pins" will always be on the left side (seated) of a ganging unit, while the pin receptacle will always be on the right side.
- Ganging brackets can only be used on armless and single arm models. Model 7871 cannot be ganged.
- Three inside corner units create a 90° inside corner assembly.
- Three outside corner units create a 90° outside corner.
- Upholstery options: fabric, vinyl or leather. Vinyl and leather models may feature stitch detail across the seat and/or back cushions, if applicable.

**OPTIONAL FEATURES**

- For ganging hardware please use the following codes: add **(G)** for both sides, add **(GR)** for right side seated only, add **(GL)** for left side seated only.
- For highly resilient, high density Ultracell foam seat, please specify **(UC)**. Add \$96.
- For hard surface flooring use tiger paw non-slip glides, please specify **(NS)**. Add \$22.
- Model 7874 table (top) is offered in the following laminate finishes: Absolute Acajou (ACJ), Asian Night (ASN), Avant Cherry (AWC), Avant Honey (AWH), Black (BLK), Blizzard (BZD), Brushed Cobalt (BRC), Clear Maple (CMB), Custom Grey (CGY), Dark Espresso (DES), Designer White (DWT), Fashionista (FAS), First Class (FCL), Noce Biondo (NBL), Noce Grigio (NGL), Noce Leggero (NEL), Noce Medio (NML), Quartered Mahogany (OTM), Sheer Beauty (SBY), Stonedust (SDT), Storm Grey (SOG), Walnut Heights (WHE), White Chocolate (WHC) and Winter Cherry (WCR).

**Typical Configurations and Applications:**

Five seat linked sofa with arms only on ends

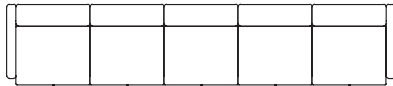

Ganged seating with corner units

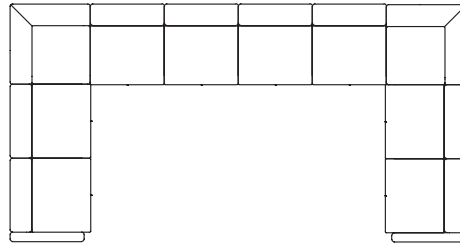



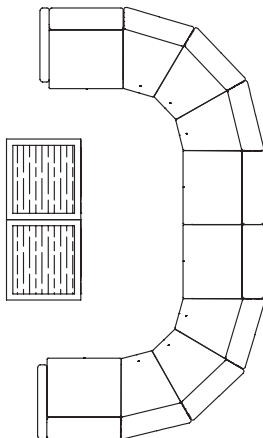



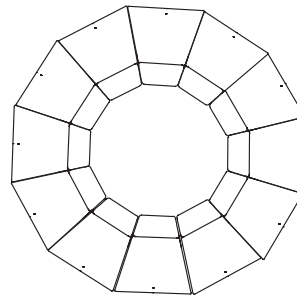

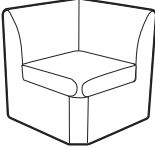
C shaped sectional with arms on ends and tables

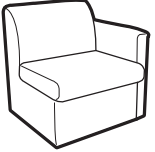
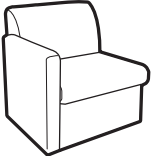
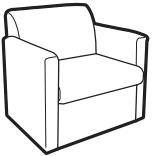

Circular configuration ganged seating

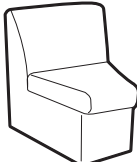

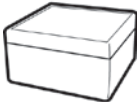
DESCRIPTION	FEATURES	MODEL#	STANDARD TEXTILE GRADES														
			1	2	3	4	5	6	7	8	9	10	11	12			
 <p><b>Corner Unit</b> COM: 4 YD   3.66 M Unit weight: 42 LB   19.1 KG Carton weight: 50 LB   22.68 KG Carton volume: 16.5 FT³   0.46 MT³</p>	<p>Ganging hardware adjacent sides.</p> <p>Ergonomic features: M, N</p>	<b>7867</b>	1092	1220	1328	1452	1656	1844	2032	2196	2400	2592	2852	3220			
			OVERALL DIMENSIONS			SEAT DIMENSIONS			BACK DIMENSIONS								
			W	D	H	W	D	H	W	H							
			IN 28	28	30	20	20.5	17	19.5	12.5							
	MM 711	711	762	508	521	432	495	318									
									<b>RTA 00</b>	1 per carton							
 <p><b>Single Seater</b> COM: 2.75 YD   2.51 M Unit weight: 33 LB   15 KG Carton weight: 38 LB   17.24 KG Carton volume: 16.5 FT³   0.46 MT³</p>	<p>See notes for ganging hardware options.</p> <p>Ergonomic features: M, N</p>	<b>7870</b>	581	669	743	829	969	1098	1227	1340	1480	1612	1791	2044			
			OVERALL DIMENSIONS			SEAT DIMENSIONS			BACK DIMENSIONS								
			W	D	H	W	D	H	W	H							
			IN 24	27.5	30	24	19.5	16.5	24	13.5							
	MM 610	699	762	610	495	419	610	343									
									<b>RTA 00</b>	1 per carton							
 <p><b>Single Seater - Left Arm</b> COM: 3.75 YD   3.43 M Unit weight: 40 LB   18.2 KG Carton weight: 45 LB   20.41 KG Carton volume: 16.5 FT³   0.46 MT³</p>	<p>Ganging hardware right side.</p> <p>Ergonomic features: M, N</p>	<b>7870L</b>	870	990	1091	1208	1399	1575	1751	1905	2096	2276	2520	2865			
			OVERALL DIMENSIONS			SEAT DIMENSIONS			BACK DIMENSIONS								
			W	D	H	W	D	H	W	H							
			IN 27	27.5	30	24	19.5	16.5	24	13.5							
	MM 686	699	762	610	495	419	610	343									
									<b>RTA 00</b>	1 per carton							
 <p><b>Single Seater - Right Arm</b> COM: 3.75 YD   3.43 M Unit weight: 40 LB   18.2 KG Carton weight: 45 LB   20.41 KG Carton volume: 16.5 FT³   0.46 MT³</p>	<p>Ganging hardware left side.</p> <p>Ergonomic features: M, N</p>	<b>7870R</b>	870	990	1091	1208	1399	1575	1751	1905	2096	2276	2520	2865			
			OVERALL DIMENSIONS			SEAT DIMENSIONS			BACK DIMENSIONS								
			W	D	H	W	D	H	W	H							
			IN 27	27.5	30	24	19.5	16.5	24	13.5							
	MM 686	699	762	610	495	419	610	343									
									<b>RTA 00</b>	1 per carton							
 <p><b>Single Seater - w/Arms</b> COM: 4.75 YD   4.34 M Unit weight: 47 LB   21.4 KG Carton weight: 52 LB   23.59 KG Carton volume: 16.5 FT³   0.46 MT³</p>	<p>Freestanding unit. No ganging hardware options.</p> <p>Ergonomic features: M, N</p>	<b>7871</b>	1158	1310	1438	1586	1828	2051	2274	2469	2711	2939	3248	3685			
			OVERALL DIMENSIONS			SEAT DIMENSIONS			BACK DIMENSIONS								
			W	D	H	W	D	H	W	H							
			IN 30	27.5	30	24	19.5	16.5	24	13.5							
	MM 762	699	762	610	495	419	610	343									
									<b>RTA 00</b>	1 per carton							

DESCRIPTION	FEATURES	MODEL#	STANDARD TEXTILE GRADES														
			1	2	3	4	5	6	7	8	9	10	11	12			
 <p>60° inside</p> <p><b>Corner Unit</b> COM: 2.75 YD   2.51 M Unit weight: 26 LB   11.8 KG Carton weight: 31 LB   14.06 KG Carton volume: 16.5 FT³   0.46 MT³</p>	<p>3 pieces make a 90° outside turn. Total of 49"L x 49"W.</p> <p>See notes for ganging hardware options.</p> <p>Ergonomic features: M, N</p>	<b>7872</b>	638	726	800	886	1026	1155	1284	1397	1537	1669	1848	2101			
			OVERALL DIMENSIONS			SEAT DIMENSIONS			BACK DIMENSIONS								
			W	D	H	W	D	H	W	H							
			IN 24 MM 610	27.5 699	30 762	20 508	19.5 495	16.5 419	15 381	13.5 343							
			<b>RTA 00</b>	1 per carton													
 <p>30° inside</p> <p><b>Corner Unit</b> COM: 2.75 YD   2.51 M Unit weight: 26 LB   11.8 KG Carton weight: 31 LB   14.06 KG Carton volume: 16.5 FT³   0.46 MT³</p>	<p>3 pieces make a 90° inside turn. Total of 49"L x 49"W.</p> <p>See notes for ganging hardware options.</p> <p>Ergonomic features: M, N</p>	<b>7873</b>	638	726	800	886	1026	1155	1284	1397	1537	1669	1848	2101			
			OVERALL DIMENSIONS			SEAT DIMENSIONS			BACK DIMENSIONS								
			W	D	H	W	D	H	W	H							
			IN 24 MM 610	27.5 699	30 762	16 406	19.5 495	16.5 419	21.5 546	13.5 343							
			<b>RTA 00</b>	1 per carton													
 <p><b>Table - 24" Square w/Upholstered Sides</b> COM: 1.75 YD   1.6 M Unit weight: 35 LB   15.9 KG Carton weight: 38 LB   17.24 KG Carton volume: 6.25 FT³   0.17 MT³</p>		<b>7874</b>	480	536	583	638	727	809	891	963	1052	1136	1250	1411			
			OVERALL DIMENSIONS			SEAT DIMENSIONS			BACK DIMENSIONS								
			W	D	H	W	D	H	W	H							
			IN 24 MM 610	24 610	14.5 368	-	-	-	-	-							
			<b>RTA 00</b>		1 per carton												
 <p><b>Footstool - 24" Square Fully Upholstered</b> COM: 2.25 YD   2.06 M Unit weight: 40 LB   18.2 KG Carton weight: 44 LB   19.96 KG Carton volume: 8.5 FT³   0.24 MT³</p>		<b>7874FS</b>	809	881	942	1012	1126	1232	1338	1430	1545	1653	1799	2006			
			OVERALL DIMENSIONS			SEAT DIMENSIONS			BACK DIMENSIONS								
			W	D	H	W	D	H	W	H							
			IN 24 MM 610	24 610	17.5 445	-	-	-	-	-							
			<b>RTA 00</b>		1 per carton												



Calidon™ seating and occasional tables share a distinctly modern appearance. With well-balanced and full-frame, solid hardwood construction, Calidon is a versatile solution combining comfort, style and durability for years to come. Fully upholstered lounge models include optional integrated power and USB charging for easy access in either front or side locations. Guest and lounge seating feature an integrated wipe-out design to support cleaning protocols from workplace and hospitality to healthcare environments.

To see the full Calidon series, please refer to the Healthcare price list at [globalfurnituregroup.com/ca/healthcare/resources/price-lists](http://globalfurnituregroup.com/ca/healthcare/resources/price-lists).

#### Features and Benefits

- Calidon consists of wood frame guest, lounge, bariatric and bench seating.
- Freestanding and tandem/bridge tables available.
- Designed for the rigors of high use environments.
- Frame design features a wall saver leg to prevent back contact and damage to walls.
- All guest and lounge chairs feature a clean out between seat and back, and tall legs for ease of cleaning.
- Lounge chairs with closed arms are fully upholstered.
- For added comfort, seats are standard with high density Ultracell foam.
- Active weight capacity up to 400 lbs. per seat for standard seating; up to 600 lbs. per seat for bariatric seating.

CAMINO



models shown: 5471-CP Lounge Chair, 5475-W End Table, 5472-CP Two Seat Sofa.



model 5471-CP



model 5476-W

STANDARD FEATURES



- A transitional soft seating series composed of one, two and three seat units. The series also offers tables with coordinating details and finishes.
- Frame is heavy duty, interlocking plywood, puzzle box construction suitable for public environments.
- The leg system utilizes a continuous visible frame between the front and rear leg. Each leg frame is bolted directly to the sofa frame, creating a very durable product.
- Legs are equipped with translucent non marking glides as standard. Suitable for both carpet and hard surface flooring.
- Seating units feature a decorative double stitch detail, which makes seams lay flat and adds extra seam strength.
- Cushions are highly resilient foam and seats are equipped with a synthetic rubberized sheet webbing suspension system for extra comfort. Cushions are fixed and non-removable.
- Tables are made with a choice of tops: genuine wood tops (**W**) with a reverse beveled edge, thermally fused laminate tops (**LP**) with matching PVC edging or high pressure laminate top (**HP**) with matching PVC edging. Custom high pressure laminate finishes will be considered upon request.
- Regardless of top chosen, all tables have wood aprons and a unique tapered leg design.
- Some table assembly is required, see RTA code with each item below.
- Upholstery options: fabric, vinyl or leather. Vinyl and leather models may feature stitch detail across the seat and/or back cushions, if applicable. If a two-tone fabric or a fabric/leather combination is required please fill in a fabric combination sketch showing where each fabric is to be applied. Please contact Customer Service.

OPTIONAL FEATURES

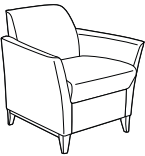
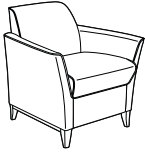
- For piping made in fabric matching the rest of the upholstery, please use matching piping models, (**MP**) after the model number. No upcharge.
- For piping made in a fabric that does not match the rest of the upholstery, you can specify any grade 1 or 2 upholstery material. Please see model numbers ending in (**CP**) which reflect the appropriate upcharge.
- Contrast piping fabric in a grade higher than 2 requires a special quotation. Unit price will vary depending on the number of units being ordered.
- Seating units and tables come with a choice of wood legs or polished cast aluminum legs. The table leg finishes coordinate with the legs on the soft seating units; finish must be specified.
- Wood finishes are available in Absolute (AAM), Black (BKM), Cherry (ACM), Espresso Cafe (ECM), English Oak (EOM), Fruitwood (TFM), Gray (HGM), Honey (AHM), Mahogany (TMM), Maple (AVM), Medium Walnut (MWM), Natural Walnut (NLW), Night (ASM), Noce Biondo (NBM), Noce Grigio (NGM), Noce Leggero (NEM), Noce Medio (NMM), Shaker Cherry (SKM), Walnut (TWM), WC Cream (WTM), White (WHM) and Winter Cherry (WCM). Please specify.
- Seating and tables with polished aluminum legs are shown as separate SKUs.
- Laminate table tops (LP and HP) are offered in the following finishes: Absolute Acajou (ACJ), Asian Night (ASN), Avant Cherry (AVC), Avant Honey (AWH), Black (BLK), Blizzard (BZD), Brushed Cobalt (BRC), Clear Maple (CMB), Custom Grey (CGY), Dark Espresso (DES), Designer White (DWT), Fashionista (FAS), First Class (FCL), Noce Biondo (NBL), Noce Grigio (NGL), Noce Leggero (NEL), Noce Medio (NML), Quartered Mahogany (QTM), Sheer Beauty (SBY), Stonedust (SDT), Storm Grey (SOG), Walnut Heights (WHE), White Chocolate (WHC) and Winter Cherry (WCR). Please specify.

DESCRIPTION	FEATURES	MODEL#	STANDARD TEXTILE GRADES											
			1	2	3	4	5	6	7	8	9	10	11	12
 <p><b>Lounge Chair w/Wood Legs</b> COM: 4 YD   3.66 M Unit weight: 50 LB   22.7 KG Carton weight: 60 LB   27.22 KG Carton volume: 19.25 FT<sup>3</sup>   0.54 MT<sup>3</sup></p>	No piping.	<b>5471</b>	2090	2218	2326	2450	2654	2842	3030	3194	3398	3590	3850	4218
		<b>OVERALL DIMENSIONS</b>			<b>SEAT DIMENSIONS</b>			<b>BACK DIMENSIONS</b>						
		IN	29.5	29	30.5	21	19.5	18	20	11.5				
		MM	749	737	775	533	495	457	508	292				
		<b>RTA 00</b>	1 per carton											
 <p><b>Lounge Chair w/Wood Legs &amp; Piping</b> COM: 4 YD   3.66 M Unit weight: 50 LB   22.7 KG Carton weight: 60 LB   27.22 KG Carton volume: 19.25 FT<sup>3</sup>   0.54 MT<sup>3</sup></p>	CP = contrast piping. MP = matching piping.	<b>5471-CP</b>	2239	2367	2475	2599	2803	2991	3179	3343	3547	3739	3999	4367
		<b>5471-MP</b>	2090	2218	2326	2450	2654	2842	3030	3194	3398	3590	3850	4218
		<b>OVERALL DIMENSIONS</b>			<b>SEAT DIMENSIONS</b>			<b>BACK DIMENSIONS</b>						
		IN	29.5	29	30.5	21	19.5	18	20	11.5				
		<b>RTA 00</b>	1 per carton											

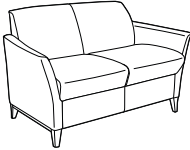
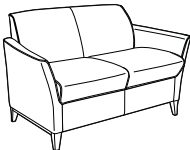
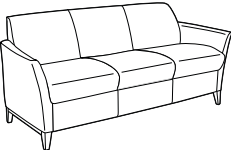
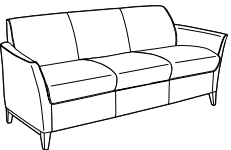

DESCRIPTION	FEATURES	MODEL#	STANDARD TEXTILE GRADES												
			1	2	3	4	5	6	7	8	9	10	11	12	
 <p><b>Two Seat Sofa w/Wood Legs</b> COM: 5.75 YD   5.26 M Unit weight: 72 LB   32.7 KG Carton weight: 84 LB   38.1 KG Carton volume: 36 FT³   1.01 MT³</p>	No piping.	<b>5472</b>	2944	3128	3283	3462	3755	4025	4295	4531	4824	5100	5474	6003	
			<b>OVERALL DIMENSIONS</b>			<b>SEAT DIMENSIONS</b>			<b>BACK DIMENSIONS</b>						
			<b>W</b>	<b>D</b>	<b>H</b>	<b>W</b>	<b>D</b>	<b>H</b>	<b>W</b>	<b>H</b>					
			IN 51 MM 1295	29 737	30.5 775	42 1067	19.5 495	18 457	41 1041	11.5 292					
			<b>RTA 00</b>	1 per carton											
 <p><b>Two Seat Sofa w/Wood Legs</b> COM: 5.75 YD   5.26 M Unit weight: 72 LB   32.7 KG Carton weight: 84 LB   38.1 KG Carton volume: 36 FT³   1.01 MT³</p>	CP = contrast piping. MP = matching piping.	<b>5472-CP</b> <b>5472-MP</b>	3140	3324	3479	3657	3949	4219	4489	4724	5017	5293	5666	6194	
			<b>OVERALL DIMENSIONS</b>			<b>SEAT DIMENSIONS</b>			<b>BACK DIMENSIONS</b>						
			<b>W</b>	<b>D</b>	<b>H</b>	<b>W</b>	<b>D</b>	<b>H</b>	<b>W</b>	<b>H</b>					
			IN 51 MM 1295	29 737	30.5 775	42 1067	19.5 495	18 457	41 1041	11.5 292					
			<b>RTA 00</b>	1 per carton											
 <p><b>Three Seat Sofa w/Wood Legs</b> COM: 7.5 YD   6.86 M Unit weight: 95 LB   43.2 KG Carton weight: 110 LB   49.9 KG Carton volume: 50.25 FT³   1.42 MT³</p>	No piping.	<b>5473</b>	3800	4040	4243	4475	4858	5210	5563	5870	6253	6613	7100	7790	
			<b>OVERALL DIMENSIONS</b>			<b>SEAT DIMENSIONS</b>			<b>BACK DIMENSIONS</b>						
			<b>W</b>	<b>D</b>	<b>H</b>	<b>W</b>	<b>D</b>	<b>H</b>	<b>W</b>	<b>H</b>					
			IN 71 MM 1803	29 737	30.5 775	63 1600	19.5 495	18 457	62 1575	11.5 292					
			<b>RTA 00</b>	1 per carton											
 <p><b>Three Seat Sofa w/Wood Legs</b> COM: 7.5 YD   6.86 M Unit weight: 95 LB   43.2 KG Carton weight: 110 LB   49.9 KG Carton volume: 50.25 FT³   1.42 MT³</p>	CP = contrast piping. MP = matching piping.	<b>5473-CP</b> <b>5473-MP</b>	4039	4279	4481	4713	5095	5447	5799	6106	6488	6848	7335	8024	
			<b>OVERALL DIMENSIONS</b>			<b>SEAT DIMENSIONS</b>			<b>BACK DIMENSIONS</b>						
			<b>W</b>	<b>D</b>	<b>H</b>	<b>W</b>	<b>D</b>	<b>H</b>	<b>W</b>	<b>H</b>					
			IN 71 MM 1803	29 737	30.5 775	63 1600	19.5 495	18 457	62 1575	11.5 292					
			<b>RTA 00</b>	1 per carton											
 <p><b>Coffee Table - 22" x 48" Rectangle w/Wood Legs</b> COM: N/A Unit weight: 32 LB   14.5 KG Carton weight: 40 LB   18.14 KG Carton volume: 4 FT³   0.11 MT³</p>			List price												
			<b>5474-LP</b>	1583											
			<b>5474-HP</b>	1699											
			<b>5474-W</b>	2045											
			LP = Laminate top	HP = High pressure laminate top	W = Wood top										
<b>OVERALL DIMENSIONS</b>			<b>SEAT DIMENSIONS</b>			<b>BACK DIMENSIONS</b>									
<b>W</b>	<b>D</b>	<b>H</b>	<b>W</b>	<b>D</b>	<b>H</b>	<b>W</b>	<b>H</b>								
IN 22 MM 559	48 1219	17.5 445	-	-	-	-	-								
			<b>RTA 6</b>	1 per carton											

DESCRIPTION FEATURES MODEL# STANDARD TEXTILE GRADES



**End Table - 21" x 21" Square w/Wood Legs**

COM: N/A  
 Unit weight: 17 LB | 7.7 KG  
 Carton weight: 20 LB | 9.07 KG  
 Carton volume: 19.25 FT<sup>3</sup> | 0.05 MT<sup>3</sup>

List price								
<b>5475-LP</b>	1180							
<b>5475-HP</b>	1294							
<b>5475-W</b>	1434							
LP = Laminate top HP = High pressure laminate top W = Wood top								
OVERALL DIMENSIONS			SEAT DIMENSIONS			BACK DIMENSIONS		
W	D	H	W	D	H	W	H	
IN 21	21	17.5	-	-	-	-	-	
MM 533	533	445	-	-	-	-	-	
<b>RTA 8</b> 1 per carton								



**Coffee Table - 24" Round w/Wood Legs**

COM: N/A  
 Unit weight: 18 LB | 8.2 KG  
 Carton weight: 21 LB | 9.53 KG  
 Carton volume: 2.1 FT<sup>3</sup> | 0.05 MT<sup>3</sup>

List price								
<b>5476-LP</b>	1210							
<b>5476-HP</b>	1325							
<b>5476-W</b>	1552							
LP = Laminate top HP = High pressure laminate top W = Wood top								
OVERALL DIMENSIONS			SEAT DIMENSIONS			BACK DIMENSIONS		
W	D	H	W	D	H	W	H	
IN 24	24	17.5	-	-	-	-	-	
MM 610	610	445	-	-	-	-	-	
<b>RTA 8</b> 1 per carton								



**Coffee Table - 32" Round w/Wood Legs**

COM: N/A  
 Unit weight: 27 LB | 12.3 KG  
 Carton weight: 35 LB | 15.88 KG  
 Carton volume: 4.4 FT<sup>3</sup> | 0.12 MT<sup>3</sup>

List price								
<b>5477-LP</b>	1838							
<b>5477-HP</b>	1953							
<b>5477-W</b>	2332							
LP = Laminate top HP = High pressure laminate top W = Wood top								
OVERALL DIMENSIONS			SEAT DIMENSIONS			BACK DIMENSIONS		
W	D	H	W	D	H	W	H	
IN 32	32	17.5	-	-	-	-	-	
MM 813	813	445	-	-	-	-	-	
<b>RTA 8</b> 1 per carton								

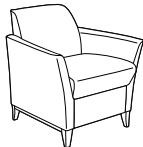

**Lounge Chair w/Aluminum Legs**

COM: 4 YD | 3.66 M  
 Unit weight: 52 LB | 23.6 KG  
 Carton weight: 62 LB | 28.12 KG  
 Carton volume: 19.25 FT<sup>3</sup> | 0.54 MT<sup>3</sup>

No piping.

	1	2	3	4	5	6	7	8	9	10	11	12
<b>5481</b>	1955	2083	2191	2315	2519	2707	2895	3059	3263	3455	3715	4083
OVERALL DIMENSIONS			SEAT DIMENSIONS			BACK DIMENSIONS						
W	D	H	W	D	H	W	H					
IN 29.5	29	30.5	21	19.5	18	20	11.5					
MM 749	737	775	533	495	457	508	292					
<b>RTA 00</b> 1 per carton												





**Lounge Chair w/Aluminum Legs**

COM: 4 YD | 3.66 M  
 Unit weight: 52 LB | 23.6 KG  
 Carton weight: 62 LB | 28.12 KG  
 Carton volume: 19.25 FT<sup>3</sup> | 0.54 MT<sup>3</sup>

CP = contrast piping.  
 MP = matching piping.

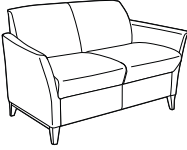
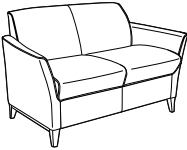
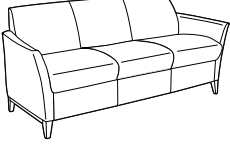
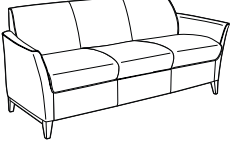
	1	2	3	4	5	6	7	8	9	10	11	12
<b>5481-CP</b>	2104	2232	2339	2463	2667	2854	3042	3205	3409	3600	3860	4227
<b>5481-MP</b>	1955	2083	2191	2315	2519	2707	2895	3059	3263	3455	3715	4083
OVERALL DIMENSIONS			SEAT DIMENSIONS			BACK DIMENSIONS						
W	D	H	W	D	H	W	H					
IN 29.5	29	30.5	21	19.5	18	20	11.5					
MM 749	737	775	533	495	457	508	292					
<b>RTA 00</b> 1 per carton												

DESCRIPTION	FEATURES	MODEL#	STANDARD TEXTILE GRADES												
			1	2	3	4	5	6	7	8	9	10	11	12	
 <p><b>Two Seat Sofa w/Aluminum Legs</b> COM: 5.75 YD   5.26 M Unit weight: 74 LB   33.6 KG Carton weight: 86 LB   39.01 KG Carton volume: 36 FT³   1.01 MT³</p>	No piping.	<b>5482</b>	2809	2993	3148	3327	3620	3890	4160	4396	4689	4965	5339	5868	
			<b>OVERALL DIMENSIONS</b>			<b>SEAT DIMENSIONS</b>			<b>BACK DIMENSIONS</b>						
			<b>W</b>	<b>D</b>	<b>H</b>	<b>W</b>	<b>D</b>	<b>H</b>	<b>W</b>	<b>H</b>					
			IN 51 MM 1295	29 737	30.5 775	42 1067	19.5 495	18 457	41 1041	11.5 292					
		<b>RTA 00</b>	1 per carton												
 <p><b>Two Seat Sofa w/Aluminum Legs</b> COM: 5.75 YD   5.26 M Unit weight: 74 LB   33.6 KG Carton weight: 86 LB   39.01 KG Carton volume: 36 FT³   1.01 MT³</p>	CP = contrast piping. MP = matching piping.	<b>5482-CP</b> <b>5482-MP</b>	3004	3188	3343	3521	3813	4083	4353	4588	4881	5157	5530	6058	
			<b>OVERALL DIMENSIONS</b>			<b>SEAT DIMENSIONS</b>			<b>BACK DIMENSIONS</b>						
			<b>W</b>	<b>D</b>	<b>H</b>	<b>W</b>	<b>D</b>	<b>H</b>	<b>W</b>	<b>H</b>					
			IN 51 MM 1295	29 737	30.5 775	42 1067	19.5 495	18 457	41 1041	11.5 292					
		<b>RTA 00</b>	1 per carton												
 <p><b>Three Seat Sofa w/Aluminum Legs</b> COM: 7.5 YD   6.86 M Unit weight: 97 LB   44.1 KG Carton weight: 112 LB   50.8 KG Carton volume: 50.25 FT³   1.42 MT³</p>	No piping.	<b>5483</b>	3665	3905	4108	4340	4723	5075	5428	5735	6118	6478	6965	7655	
			<b>OVERALL DIMENSIONS</b>			<b>SEAT DIMENSIONS</b>			<b>BACK DIMENSIONS</b>						
			<b>W</b>	<b>D</b>	<b>H</b>	<b>W</b>	<b>D</b>	<b>H</b>	<b>W</b>	<b>H</b>					
			IN 71 MM 1803	29 737	30.5 775	63 1600	19.5 495	18 457	62 1575	11.5 292					
		<b>RTA 00</b>	1 per carton												
 <p><b>Three Seat Sofa w/Aluminum Legs</b> COM: 7.5 YD   6.86 M Unit weight: 97 LB   44.1 KG Carton weight: 112 LB   50.8 KG Carton volume: 50.25 FT³   1.42 MT³</p>	CP = contrast piping. MP = matching piping.	<b>5483-CP</b> <b>5483-MP</b>	3903	4143	4345	4577	4959	5311	5663	5970	6352	6712	7199	7888	
			<b>OVERALL DIMENSIONS</b>			<b>SEAT DIMENSIONS</b>			<b>BACK DIMENSIONS</b>						
			<b>W</b>	<b>D</b>	<b>H</b>	<b>W</b>	<b>D</b>	<b>H</b>	<b>W</b>	<b>H</b>					
			IN 71 MM 1803	29 737	30.5 775	63 1600	19.5 495	18 457	62 1575	11.5 292					
		<b>RTA 00</b>	1 per carton												
 <p><b>Coffee Table - 22" x 48" Rectangle w/Aluminum Legs</b> COM: N/A Unit weight: 38 LB   17.3 KG Carton weight: 46 LB   20.87 KG Carton volume: 4 FT³   0.11 MT³</p>			List price												
			<b>5484-LP</b>	1686											
			<b>5484-HP</b>	1803											
			<b>5484-W</b>	2149											
			LP = Laminate top   HP = High pressure laminate top   W = Wood top												
			<b>OVERALL DIMENSIONS</b>			<b>SEAT DIMENSIONS</b>			<b>BACK DIMENSIONS</b>						
			<b>W</b>	<b>D</b>	<b>H</b>	<b>W</b>	<b>D</b>	<b>H</b>	<b>W</b>	<b>H</b>					
			IN 22 MM 559	48 1219	17.5 445	19.5 533	18 495	20 457	11.5 508	292					
			<b>RTA 6</b>	1 per carton											

DESCRIPTION FEATURES MODEL# STANDARD TEXTILE GRADES



**End Table - 21" x 21" Square w/Aluminum Legs**

COM: N/A  
 Unit weight: 23 LB | 10.5 KG  
 Carton weight: 26 LB | 11.79 KG  
 Carton volume: 2.1 FT³ | 0.05 MT³

List price								
<b>5485-LP</b>		1283						
<b>5485-HP</b>		1399						
<b>5485-W</b>		1538						
LP = Laminate top HP = High pressure laminate top W = Wood top								
OVERALL DIMENSIONS			SEAT DIMENSIONS			BACK DIMENSIONS		
W	D	H	W	D	H	W	D	H
IN 21	21	17.5	-	-	-	-	-	-
MM 533	533	445	-	-	-	-	-	-
<b>RTA 8</b>		1 per carton						



**End Table - 24" Round w/Aluminum Legs**

COM: N/A  
 Unit weight: 24 LB | 10.9 KG  
 Carton weight: 27 LB | 12.25 KG  
 Carton volume: 2.1 FT³ | 0.05 MT³

List price								
<b>5486-LP</b>		1315						
<b>5486-HP</b>		1429						
<b>5486-W</b>		1656						
LP = Laminate top HP = High pressure laminate top W = Wood top								
OVERALL DIMENSIONS			SEAT DIMENSIONS			BACK DIMENSIONS		
W	D	H	W	D	H	W	D	H
IN 24	24	17.5	-	-	-	-	-	-
MM 610	610	445	-	-	-	-	-	-
<b>RTA 8</b>		1 per carton						

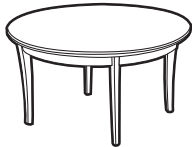

**Coffee Table - 32" Round w/Aluminum Legs**

COM: N/A  
 Unit weight: 33 LB | 15 KG  
 Carton weight: 41 LB | 18.6 KG  
 Carton volume: 4.4 FT³ | 0.12 MT³

List price								
<b>5487-LP</b>		1940						
<b>5487-HP</b>		2057						
<b>5487-W</b>		2435						
LP = Laminate top HP = High pressure laminate top W = Wood top								
OVERALL DIMENSIONS			SEAT DIMENSIONS			BACK DIMENSIONS		
W	D	H	W	D	H	W	D	H
IN 32	32	17.5	-	-	-	-	-	-
MM 813	813	445	-	-	-	-	-	-
<b>RTA 8</b>		1 per carton						

CITI



model 7875RTL

model 7889



Citi Modular Group & Tables - shown in Tungsten

Leg options



5" tubular metal leg (shown in Tungsten finish)

5" tapered, softened edge, wood leg (shown in Maple finish)

STANDARD FEATURES



- Fully upholstered contemporary design, complements the timeless decor of many offices. Proportions are compact, 31" deep, work well in public spaces.
- All models have fixed, non-removable cushions.
- Arm height on all models is 25".
- Casters are not available on this series.
- Citi seat and table legs are 5" high tubular metal, standard in a Tungsten finish.
- Citi table tops are available in either tempered glass or laminate.
- Tablets are made from thermally fused laminate, 0.75" thick. Tablet arms measure 12"D x 16.5"W. Available right hand seated (RT), left hand seated (LT) or both right and left hand (LRT).
- Laminate tables and tablets are offered in the following finishes: Absolute Acajou (ACJ), Asian Night (ASN), Avant Cherry (AWC), Avant Honey (AWH), Black (BLK), Blizzard (BZD), Brushed Cobalt (BRC), Clear Maple (CMB), Custom Grey (CGY), Dark Espresso (DES), Designer White (DWT), Fashionista (FAS), First Class (FCL), Noce Biondo (NBL), Noce Grigio (NGL), Noce Leggero (NEL), Noce Medio (NML), Quartered Mahogany (QTM), Sheer Beauty (SBY), Stonedust (SDT), Storm Grey (SOG), Walnut Heights (WHE), White Chocolate (WHC) and Winter Cherry (WCR). Please specify.
- Ganging brackets (#7892) are sold separately. Ganging brackets are to be used on armless seating if interconnection to another armless seating unit is required. Bench and ottomans cannot gang with seating units. Brackets come with a template for installation.
- Upholstery options: fabric, vinyl or leather. Vinyl and leather models may feature stitch detail across the seat and/or back cushions, if applicable.







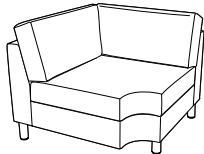







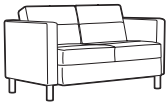

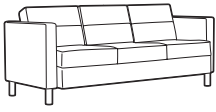



OPTIONAL FEATURES

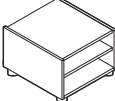

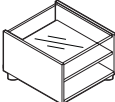

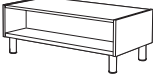

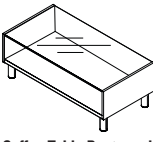
- For highly resilient, high density Ultracell foam on seat, please specify (UC) after the model number. One seater add \$99. Two seater add \$197. Three seater add \$295.
- Leg options:**
  - (MTL) Metal legs  
For metal leg finish options, please see page 360. For Chrome (CHM) finish, add \$68.
  - (WDL) Wood legs  
Non-cylindrical wood legs available in the following finishes. Add \$300.
 

(AAM) Absolute	(MWM) Medium Walnut
(BKM) Black	(NLW) Natural Walnut
(CJM) Charcoal Java	(ASM) Night
(ACM) Cherry	(NBM) Noce Biondo
(EMM) Empire Mahogany	(NGM) Noce Grigio
(EOM) English Oak	(NEM) Noce Leggero
(ECM) Espresso Cafe	(NMM) Noce Medio
(TFM) Fruitwood	(SBM) Sandy Beach
(HGM) Gray	(SKM) Shaker Cherry
(HOM) Harvest Oak	(SOM) Silver Oak
(AHM) Honey	(TWM) Walnut
(JOM) Jet Onyx	(WTM) WC Cream
(LHM) Light Honey	(WHM) White
(TMM) Mahogany	(WCM) Winter Cherry
(AVM) Maple	
- Glide type** (wood legs only)
  - (NM) White non-marking nylon for most surfaces (standard)
  - (SG) steel cushioned glides for carpeted surfaces. Add \$17.
  - (RG) non-slip rubber glides for most hard floor surfaces. Add \$22.
  - (FG) felt glides for most hard floor surfaces. Add \$22.
- Table legs are available in Black (TBL), or Tungsten (TTU), please specify. For Chrome (CHM) finish. Add \$68.
- If you would like fabric/vinyl on the shell of a chair with leather seat + back cushions, please submit a [multi fabric form](#) (multi fabric grade will apply). Please note: the reverse is not available (leather on the shell of the chair with fabric/vinyl seat + back cushions).

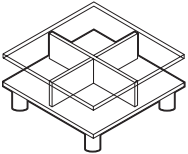
DESCRIPTION	FEATURES	MODEL#	STANDARD TEXTILE GRADES													
			1	2	3	4	5	6	7	8	9	10	11	12		
 <p><b>Corner Seat</b> COM: 6.25 YD   5.72 M Unit weight: 65 LB   29.5 KG Carton weight: 75 LB   34.02 KG Carton volume: 30.25 FT<sup>3</sup>   0.85 MT<sup>3</sup></p>	<p>Ganging hardware not included.</p> <p>Armless side(s) can be equipped with ganging brackets, model 7892.</p>	7862	-	-	-	-	1656	1950	2244	2500	2819	3119	3525	4100		
			<b>OVERALL DIMENSIONS</b>			<b>SEAT DIMENSIONS</b>			<b>BACK DIMENSIONS</b>							
			<b>W</b>	<b>D</b>	<b>H</b>	<b>W</b>	<b>D</b>	<b>H</b>	<b>W</b>	<b>H</b>						
			IN 37	37	31	26	26	17.5	26	13.5						
MM 940	940	787	660	660	445	660	343									
		<b>RTA 00</b>	1 per carton													
 <p><b>Lounge Chair</b> COM: 4.5 YD   4.11 M Unit weight: 57 LB   25.9 KG Carton weight: 67 LB   30.39 KG Carton volume: 21 FT<sup>3</sup>   0.59 MT<sup>3</sup></p>	<p>Freestanding unit only.</p>	7875	-	-	-	-	1180	1391	1604	1787	2018	2234	2525	2939		
			<b>OVERALL DIMENSIONS</b>			<b>SEAT DIMENSIONS</b>			<b>BACK DIMENSIONS</b>							
			<b>W</b>	<b>D</b>	<b>H</b>	<b>W</b>	<b>D</b>	<b>H</b>	<b>W</b>	<b>H</b>						
			IN 30	31	30	22	19.5	17.5	22	12.5						
MM 762	787	762	559	495	445	559	318									
		<b>RTA 00</b>	1 per carton													

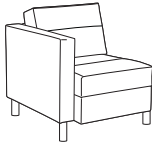
DESCRIPTION	FEATURES	MODEL#	STANDARD TEXTILE GRADES											
			1	2	3	4	5	6	7	8	9	10	11	12
 <b>7875LTL</b>  <b>7875RTL</b> <b>Lounge Chair w/Laminated Tablet</b> COM: 4.5 YD   4.11 M Unit weight: 65 LB   29.5 KG Carton weight: 75 LB   34.02 KG Carton volume: 22.5 FT³   0.63 MT³	Freestanding unit only.	<b>7875LTL</b> 7875RTL	-	-	-	-	1613	1824	2037	2220	2451	2667	2958	3372
		<b>OVERALL DIMENSIONS</b>			<b>SEAT DIMENSIONS</b>			<b>BACK DIMENSIONS</b>						
		<b>W</b>	<b>D</b>	<b>H</b>	<b>W</b>	<b>D</b>	<b>H</b>	<b>W</b>	<b>H</b>					
		IN 31.5 MM 800	33.5 851	30 762	22 559	19.5 495	17.5 445	22 559	12.5 318					
		<b>RTA 00</b>			1 per carton									
 <b>Ganging Bracket Kit</b> COM: N/A Unit weight: 0.25 LB   0.1 KG Carton weight: 0.25 LB   0.11 KG Carton volume: 0.02 FT³   0.0003 MT³	Kit includes 2 brackets, 4 screws and a template. Only one set is needed per unit.	<b>7892</b>	List price 18											
		<b>OVERALL DIMENSIONS</b>			<b>SEAT DIMENSIONS</b>			<b>BACK DIMENSIONS</b>						
		<b>W</b>	<b>D</b>	<b>H</b>	<b>W</b>	<b>D</b>	<b>H</b>	<b>W</b>	<b>H</b>					
		IN 0.5 MM 13	3.87 98	2 51	-	-	-	-	-					
		<b>RTA 00</b>			courier									
 <b>Lounge Chair - Armless</b> COM: 3 YD   2.74 M Unit weight: 39 LB   17.7 KG Carton weight: 45 LB   20.41 KG Carton volume: 15.5 FT³   0.43 MT³	Ganging hardware not included.  Armless side(s) can be equipped with ganging brackets, model 7892.	<b>7895</b>	-	-	-	-	1180	1321	1463	1585	1739	1883	2077	2353
		<b>OVERALL DIMENSIONS</b>			<b>SEAT DIMENSIONS</b>			<b>BACK DIMENSIONS</b>						
		<b>W</b>	<b>D</b>	<b>H</b>	<b>W</b>	<b>D</b>	<b>H</b>	<b>W</b>	<b>H</b>					
		IN 22 MM 559	31 787	30.75 781	22 559	18.5 470	17.5 445	22 559	12.5 318					
		<b>RTA 00</b>			1 per carton									
 <b>Two Seat Sofa</b> COM: 6.25 YD   5.72 M Unit weight: 113 LB   51.4 KG Carton weight: 125 LB   56.7 KG Carton volume: 36 FT³   1.01 MT³	Freestanding unit only.	<b>7876</b>	-	-	-	-	1656	1950	2244	2500	2819	3119	3525	4100
		<b>OVERALL DIMENSIONS</b>			<b>SEAT DIMENSIONS</b>			<b>BACK DIMENSIONS</b>						
		<b>W</b>	<b>D</b>	<b>H</b>	<b>W</b>	<b>D</b>	<b>H</b>	<b>W</b>	<b>H</b>					
		IN 51.25 MM 1302	31 787	30 762	43.25 1099	19.5 495	17.5 445	43.25 1099	12.5 318					
		<b>RTA 00</b>			1 per carton									
 <b>Two Seat Sofa - Armless</b> COM: 5 YD   4.57 M Unit weight: 81 LB   36.8 KG Carton weight: 93 LB   42.18 KG Carton volume: 36 FT³   1.01 MT³	Ganging hardware not included.  Armless side(s) can be equipped with ganging brackets, model 7892.	<b>7896</b>	-	-	-	-	1656	1891	2126	2331	2586	2826	3151	3611
		<b>OVERALL DIMENSIONS</b>			<b>SEAT DIMENSIONS</b>			<b>BACK DIMENSIONS</b>						
		<b>W</b>	<b>D</b>	<b>H</b>	<b>W</b>	<b>D</b>	<b>H</b>	<b>W</b>	<b>H</b>					
		IN 43.25 MM 1099	31 787	30.75 781	43.25 1099	19.5 495	17.5 445	43.25 1099	13.25 337					
		<b>RTA 00</b>			1 per carton									
 <b>Three Seat Sofa</b> COM: 8.75 YD   8 M Unit weight: 149 LB   67.7 KG Carton weight: 163 LB   73.94 KG Carton volume: 50.25 FT³   1.42 MT³	Freestanding unit only.	<b>7877</b>	-	-	-	-	2134	2546	2957	3316	3762	4182	4751	5556
		<b>OVERALL DIMENSIONS</b>			<b>SEAT DIMENSIONS</b>			<b>BACK DIMENSIONS</b>						
		<b>W</b>	<b>D</b>	<b>H</b>	<b>W</b>	<b>D</b>	<b>H</b>	<b>W</b>	<b>H</b>					
		IN 72.5 MM 1842	31 787	30 762	64.5 1638	19.5 495	17.5 445	64.5 1638	12.5 318					
		<b>RTA 00</b>			1 per carton									

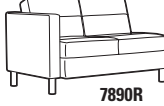
DESCRIPTION	FEATURES	MODEL#	STANDARD TEXTILE GRADES													
			1	2	3	4	5	6	7	8	9	10	11	12		
 <p><b>Three Seat Sofa - Armless</b>                      COM: 7.25 YD   6.63 M                      Unit weight: 117 LB   53.2 KG                      Carton weight: 131 LB   59.42 KG                      Carton volume: 50.25 FT³   1.42 MT³</p>	Ganging hardware not included.  Armless side(s) can be equipped with ganging brackets, model 7892.	7897	-	-	-	-	2134	2475	2816	3113	3483	3831	4302	4969		
		<b>OVERALL DIMENSIONS</b>			<b>SEAT DIMENSIONS</b>			<b>BACK DIMENSIONS</b>								
		W	D	H	W	D	H	W	H							
		IN 64.5	31	30.75	64.5	19.5	17.5	64.5	13.25							
		MM 1638	787	781	1638	495	445	1638	337							
		RTA 00	1 per carton													
 <p><b>Ottoman</b>                      COM: 1.5 YD   1.37 M                      Unit weight: 23 LB   10.5 KG                      Carton weight: 27 LB   12.25 KG                      Carton volume: 7.5 FT³   0.21 MT³</p>	Ganging hardware not included.  Side(s) can be equipped with ganging brackets, model 7892. Does not gang to seating units.	7879	-	-	-	-	590	661	731	793	869	941	1039	1177		
		<b>OVERALL DIMENSIONS</b>			<b>SEAT DIMENSIONS</b>			<b>BACK DIMENSIONS</b>								
		W	D	H	W	D	H	W	H							
		IN 22	22	17	-	-	-	-	-							
		MM 559	559	432	-	-	-	-	-							
		RTA 00		1 per carton												
		List price														
		7885	751													
 <p><b>End Table - Laminate Top</b>                      COM: N/A                      Unit weight: 45 LB   20.5 KG                      Carton weight: 53 LB   24.04 KG                      Carton volume: 6 FT³   0.16 MT³</p>		<b>OVERALL DIMENSIONS</b>			<b>SEAT DIMENSIONS</b>			<b>BACK DIMENSIONS</b>								
		W	D	H	W	D	H	W	H							
		IN 20	24	20	-	-	-	-	-							
		MM 508	610	508	-	-	-	-	-							
				RTA 1		1 per carton										
		List price														
		7886	981													
 <p><b>End Table - Glass Top</b>                      COM: N/A                      Unit weight: 52 LB   23.6 KG                      Carton weight: 60 LB   27.22 KG                      Carton volume: 6 FT³   0.16 MT³</p>		<b>OVERALL DIMENSIONS</b>			<b>SEAT DIMENSIONS</b>			<b>BACK DIMENSIONS</b>								
		W	D	H	W	D	H	W	H							
		IN 20	24	20	-	-	-	-	-							
		MM 508	610	508	-	-	-	-	-							
				RTA 1		1 per carton										
		List price														
		7887	784													
 <p><b>Coffee Table Rectangular - Laminate top</b>                      COM: N/A                      Unit weight: 50 LB   22.7 KG                      Carton weight: 60 LB   27.22 KG                      Carton volume: 6.5 FT³   0.18 MT³</p>		<b>OVERALL DIMENSIONS</b>			<b>SEAT DIMENSIONS</b>			<b>BACK DIMENSIONS</b>								
		W	D	H	W	D	H	W	H							
		IN 40	20	15	-	-	-	-	-							
		MM 1016	508	381	-	-	-	-	-							
				RTA 1		1 per carton										
		List price														
		7888	1133													
 <p><b>Coffee Table Rectangular - Glass Top</b>                      COM: N/A                      Unit weight: 65 LB   29.5 KG                      Carton weight: 75 LB   34.02 KG                      Carton volume: 6.5 FT³   0.18 MT³</p>		<b>OVERALL DIMENSIONS</b>			<b>SEAT DIMENSIONS</b>			<b>BACK DIMENSIONS</b>								
		W	D	H	W	D	H	W	H							
		IN 40	20	15	-	-	-	-	-							
		MM 1016	508	381	-	-	-	-	-							
				RTA 1		1 per carton										

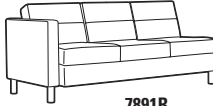
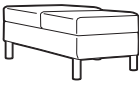
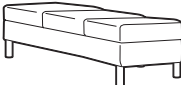
DESCRIPTION	FEATURES	MODEL#	STANDARD TEXTILE GRADES													
 <p><b>Coffee Table Square</b> COM: N/A Unit weight: 80 LB   36.4 KG Carton weight: 90 LB   40.82 KG Carton volume: 8.75 FT³   0.24 MT³</p>		<b>7889</b> Glass top	List price													
			1347													
			<b>OVERALL DIMENSIONS</b>			<b>SEAT DIMENSIONS</b>			<b>BACK DIMENSIONS</b>							
			W	D	H	W	D	H	W	H						
IN 33	33	15	-	-	-	-	-									
MM 838	838	381	-	-	-	-	-									
<b>RTA 1</b>			1 per carton													
 <p><b>7901L</b></p> <p><b>Lounge Chair - One Arm</b> COM: 4 YD   3.66 M Unit weight: 55 LB   25 KG Carton weight: 65 LB   29.48 KG Carton volume: 21 FT³   0.59 MT³</p>	 <p><b>7901R</b></p> <p>Ganging hardware not included. Armless side can be equipped with ganging brackets, model 7892.</p>	<b>7901L</b> 7901R	1 2 3 4 5 6 7 8 9 10 11 12													
			<b>OVERALL DIMENSIONS</b>			<b>SEAT DIMENSIONS</b>			<b>BACK DIMENSIONS</b>							
			W	D	H	W	D	H	W	H						
			IN 26	31	30	22	19.5	17.5	22	12.5						
MM 660	787	762	559	495	445	559	318									
<b>RTA 00</b>			1 per carton													
 <p><b>7890L</b></p> <p><b>Two Seat Sofa - One Arm</b> COM: 5.25 YD   4.8 M Unit weight: 95 LB   43.2 KG Carton weight: 107 LB   48.53 KG Carton volume: 36 FT³   1.01 MT³</p>	 <p><b>7890R</b></p> <p>Ganging hardware not included. Armless side can be equipped with ganging brackets, model 7892.</p>	<b>7890L</b> 7890R	1 2 3 4 5 6 7 8 9 10 11 12													
			<b>OVERALL DIMENSIONS</b>			<b>SEAT DIMENSIONS</b>			<b>BACK DIMENSIONS</b>							
			W	D	H	W	D	H	W	H						
			IN 47.25	31	30.75	43.25	19.5	17.5	43.25	13.25						
MM 1200	787	781	1099	495	445	1099	337									
<b>RTA 00</b>			1 per carton													
 <p><b>7891L</b></p> <p><b>Three Seat Sofa - One Arm</b> COM: 7.25 YD   6.63 M Unit weight: 124 LB   56.4 KG Carton weight: 138 LB   62.6 KG Carton volume: 50.25 FT³   1.42 MT³</p>	 <p><b>7891R</b></p> <p>Ganging hardware not included. Armless side can be equipped with ganging brackets, model 7892.</p>	<b>7891L</b> 7891R	1 2 3 4 5 6 7 8 9 10 11 12													
			<b>OVERALL DIMENSIONS</b>			<b>SEAT DIMENSIONS</b>			<b>BACK DIMENSIONS</b>							
			W	D	H	W	D	H	W	H						
			IN 68.5	31	30.75	64.5	19.5	17.5	64.5	13.25						
MM 1740	787	781	1638	495	445	1638	337									
<b>RTA 00</b>			1 per carton													
 <p><b>7893</b></p> <p><b>Two Seat Bench</b> COM: 2.25 YD   2.06 M Unit weight: 36 LB   16.4 KG Carton weight: 42 LB   19.05 KG Carton volume: 11.5 FT³   0.32 MT³</p>		<b>7893</b>	1 2 3 4 5 6 7 8 9 10 11 12													
			<b>OVERALL DIMENSIONS</b>			<b>SEAT DIMENSIONS</b>			<b>BACK DIMENSIONS</b>							
			W	D	H	W	D	H	W	H						
			IN 43	21.5	17	-	-	-	-	-						
MM 1092	546	432	-	-	-	-	-									
<b>RTA 00</b>			1 per carton													
 <p><b>7894</b></p> <p><b>Three Seat Bench</b> COM: 3.75 YD   3.43 M Unit weight: 54 LB   24.5 KG Carton weight: 62 LB   28.12 KG Carton volume: 16.75 FT³   0.47 MT³</p>		<b>7894</b>	1 2 3 4 5 6 7 8 9 10 11 12													
			<b>OVERALL DIMENSIONS</b>			<b>SEAT DIMENSIONS</b>			<b>BACK DIMENSIONS</b>							
			W	D	H	W	D	H	W	H						
			IN 64.5	21.5	17	-	-	-	-	-						
MM 1638	546	432	-	-	-	-	-									
<b>RTA 00</b>			1 per carton													



CITISQUARE



model S7875LT



Sample Layout A - Models shown: S7875FUC and S7911



Sample Layout B - Models shown: S7890RFUC, S7862FUC (2), S7897FUC, S7890LFUC and S7912.

STANDARD FEATURES

- Fully upholstered lounge series with a complete range of sectional components for all applications. Proportions are compact, 31" deep, work well in public spaces.
- All models have fixed, non-removable cushions.
- Arm height on all models is 25".
- Casters are not available on this series.
- Citi Square seat and table legs are 5" high, single-piece welded frames.
- Citi Square tables are made with high pressure laminate.
- Tables are made from thermally fused laminate, 0.75" thick. Tablet arms measure 12"D x 16.5"W. Available right hand seated (RT), left hand seated (LT) or both right and left hand (LRT).
- Laminate tables and tablets are offered in the following finishes: Absolute Acajou (ACJ), Asian Night (ASN), Avant Cherry (AWC), Avant Honey (AWH), Black (BLK), Blizzard (BZD), Brushed Cobalt (BRC), Clear Maple (CMB), Custom Grey (CGY), Dark Espresso (DES), Designer White (DWT), Fashionista (FAS), First Class (FCL), Noce Biondo (NBL), Noce Grigio (NGL), Noce Leggero (NEL), Noce Medio (NML), Quartered Mahogany (QTM), Sheer Beauty (SBY), Stonedust (SDT), Storm Grey (SOG), Walnut Heights (WHE), White Chocolate (WHC) and Winter Cherry (WCR). Please specify. Custom high pressure laminate finishes will be considered upon request.
- Ganging brackets (#7892) are sold separately. Ganging brackets are to be used on armless seating if interconnection to another armless seating unit is required. Bench and ottomans only gang to other benches/ottomans, cannot gang with seating units. Brackets come with a template for installation.
- Upholstery options: fabric, vinyl or leather. Vinyl and leather models may feature stitch detail across the seat and/or back cushions, if applicable.

OPTIONAL FEATURES

- For highly resilient, high density Ultracell foam on seat, please specify (UC) after the model number. One seater add \$99. Two seater add \$197. Three seater add \$295. Four seater add \$395.
- For leg frame finish options, please see page 360. Upcharges apply for plated finishes:
  - (CHM) Chrome. Add \$131.
  - (BCH) Brushed Chrome. Add \$246 for corner units. Add \$177 for single seat units. Add \$220 for two seat units. Add \$270 for three seat units. Add \$320 for four seat units.
  - (SBR) Satin Brass. Add \$377 for corner units. Add \$281 for single seat units. Add \$381 for two seat units. Add \$481 for three seat units. Add \$581 for four seat units.
  - (ACO) Antique Copper. Add \$377 for corner units. Add \$281 for single seat units. Add \$381 for two seat units. Add \$481 for three seat units. Add \$581 for four seat units.
- For leg frame finish options on occasional tables, please see page 360. Upcharges apply for plated finishes (see models for upcharges).
- Power/USB units are available in tables. Each unit includes two power outlets and two double USB terminals and is equipped with a 6' long three-prong power cord. The power units are available in Jet Black (J1) or White (W1). Add \$729 per unit. Please see electrical placement below for predetermined locations.
- If you would like fabric/vinyl on the shell of a chair with leather seat + back cushions, please submit a multi fabric form (multi fabric grade will apply). Please note: the reverse is not available (leather on the shell of the chair with fabric/vinyl seat + back cushions).

ELECTRICAL PLACEMENT

Coffee/End Tables: Predetermined location is on the end/side of the unit J1 (Black) or W1 (White).

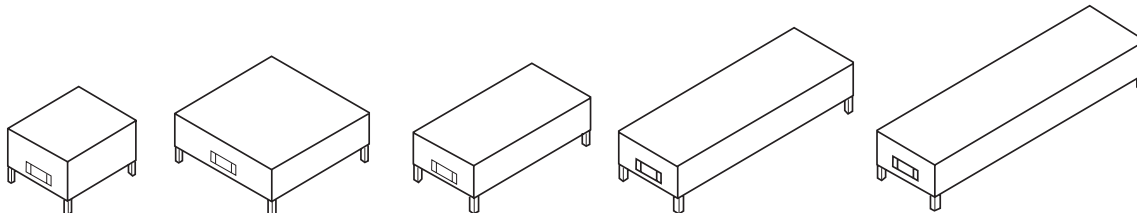

DESCRIPTION

FEATURES

MODEL #

STANDARD TEXTILE GRADES



Ganging Bracket Kit

COM: N/A  
 Unit weight: 0.25 LB | 0.1 KG  
 Carton weight: 0.25 LB | 0.11 KG  
 Carton volume: 0.01 FT³ | 0.0003 MT³

Kit includes 2 brackets, 4 screws and a template. Only one set is needed per unit.

List price

7892 18

OVERALL DIMENSIONS

	W	D	H
IN	0.5	3.87	2
MM	13	98	51

SEAT DIMENSIONS







	W	D	H
	-	-	-

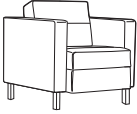

BACK DIMENSIONS

	W	H
	-	-

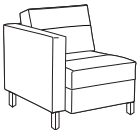
RTA 00



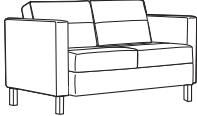
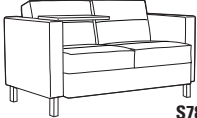
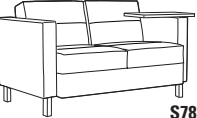
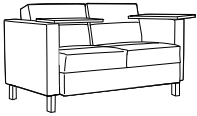
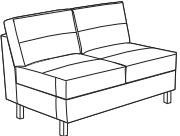

DESCRIPTION	FEATURES	MODEL#	STANDARD TEXTILE GRADES												
			1	2	3	4	5	6	7	8	9	10	11	12	
 <p><b>Linking Corner Unit</b> COM: 6.25 YD   5.72 M Unit weight: 65 LB   29.5 KG Carton weight: 75 LB   34.02 KG Carton volume: 30.25 FT³   0.85 MT³</p>	Ganging hardware not included.  Armless side(s) can be equipped with ganging brackets, model 7892.	<b>S7862</b>	-	-	-	-	1882	2176	2470	2726	3045	3345	3751	4326	
			<b>OVERALL DIMENSIONS</b>			<b>SEAT DIMENSIONS</b>			<b>BACK DIMENSIONS</b>						
			<b>W</b>	<b>D</b>	<b>H</b>	<b>W</b>	<b>D</b>	<b>H</b>	<b>W</b>	<b>H</b>					
			IN 37	37	31	26	26	17.5	26	13.5					
			MM 940	940	787	660	660	445	660	343					
<b>RTA 00</b>	1 per carton														
 <p><b>Single Seat w/Arms</b> COM: 4.5 YD   4.11 M Unit weight: 71 LB   32.3 KG Carton weight: 81 LB   36.74 KG Carton volume: 21 FT³   0.59 MT³</p>	Freestanding unit only.	<b>S7875</b>	-	-	-	-	1328	1540	1751	1936	2165	2381	2674	3088	
			<b>OVERALL DIMENSIONS</b>			<b>SEAT DIMENSIONS</b>			<b>BACK DIMENSIONS</b>						
			<b>W</b>	<b>D</b>	<b>H</b>	<b>W</b>	<b>D</b>	<b>H</b>	<b>W</b>	<b>H</b>					
			IN 30	31	30	22	19.5	17.5	22	12.5					
			MM 762	787	762	559	495	445	559	318					
<b>RTA 00</b>	1 per carton														
 <p><b>S7875RT</b></p>	 <p><b>S7875LT</b></p>	Freestanding unit only.	<b>S7875LT</b> S7875RT	-	-	-	-	1760	1972	2183	2368	2597	2813	3106	3520
				<b>OVERALL DIMENSIONS</b>			<b>SEAT DIMENSIONS</b>			<b>BACK DIMENSIONS</b>					
				<b>W</b>	<b>D</b>	<b>H</b>	<b>W</b>	<b>D</b>	<b>H</b>	<b>W</b>	<b>H</b>				
				IN 31.5	33.5	30	22	19.5	17.5	22	12.5				
				MM 800	851	762	559	495	445	559	318				
<b>RTA 00</b>	1 per carton														
 <p><b>Armless Single Seat</b> COM: 3 YD   2.74 M Unit weight: 39 LB   17.7 KG Carton weight: 45 LB   20.41 KG Carton volume: 15.5 FT³   0.43 MT³</p>	Ganging hardware not included.  Armless side(s) can be equipped with ganging brackets, model 7892.	<b>S7895</b>	-	-	-	-	1328	1469	1610	1733	1886	2030	2225	2501	
			<b>OVERALL DIMENSIONS</b>			<b>SEAT DIMENSIONS</b>			<b>BACK DIMENSIONS</b>						
			<b>W</b>	<b>D</b>	<b>H</b>	<b>W</b>	<b>D</b>	<b>H</b>	<b>W</b>	<b>H</b>					
			IN 22	31	30.75	22	18.5	17.5	22	12.5					
			MM 559	787	781	559	470	445	559	318					
<b>RTA 00</b>	1 per carton														
 <p><b>S7901R</b></p>	 <p><b>S7901L</b></p>	Ganging hardware not included.  Armless side can be equipped with ganging brackets, model 7892.	<b>S7901L</b> S7901R	-	-	-	-	1328	1516	1704	1868	2072	2264	2524	2892
				<b>OVERALL DIMENSIONS</b>			<b>SEAT DIMENSIONS</b>			<b>BACK DIMENSIONS</b>					
				<b>W</b>	<b>D</b>	<b>H</b>	<b>W</b>	<b>D</b>	<b>H</b>	<b>W</b>	<b>H</b>				
				IN 26	31	30.75	22	19.5	17.5	22	12.5				
				MM 660	787	781	559	495	445	559	318				
<b>RTA 00</b>	1 per carton														

DESCRIPTION	FEATURES	MODEL#	STANDARD TEXTILE GRADES											
			1	2	3	4	5	6	7	8	9	10	11	12
 <p><b>S7901RRT</b></p> <p><b>Single Seat w/One Arm &amp; Laminate Tablet</b>                      COM: 4 YD   3.66 M                      Unit weight: 63 LB   28.6 KG                      Carton weight: 73 LB   33.11 KG                      Carton volume: 22.5 FT³   0.63 MT³</p>	 <p><b>S7901LLT</b></p> <p>Ganging hardware not included.                       Armless side(s) can be equipped with ganging brackets, model 7892.</p>	<p><b>S7901LLT</b> S7901RRT</p>	-	-	-	-	1760	1948	2136	2300	2504	2696	2956	3324
			<p><b>OVERALL DIMENSIONS</b> W D H</p> <p>IN 27.5 31 30.75 MM 699 787 781</p> <p><b>SEAT DIMENSIONS</b> W D H</p> <p>22 19.5 17.5 559 495 445</p> <p><b>BACK DIMENSIONS</b> W H</p> <p>22 12.5 559 318</p>	<p><b>RTA 00</b> 1 per carton</p>										
 <p><b>S7876</b></p> <p><b>Two Seater w/Arms</b>                      COM: 6.25 YD   5.72 M                      Unit weight: 110 LB   50 KG                      Carton weight: 122 LB   55.34 KG                      Carton volume: 36 FT³   1.01 MT³</p>	<p>Freestanding unit only.</p>	<p><b>S7876</b></p>	-	-	-	-	1882	2176	2470	2726	3045	3345	3751	4326
			<p><b>OVERALL DIMENSIONS</b> W D H</p> <p>IN 51.25 31 30 MM 1302 787 762</p> <p><b>SEAT DIMENSIONS</b> W D H</p> <p>43.25 19.5 17.5 1099 495 445</p> <p><b>BACK DIMENSIONS</b> W H</p> <p>43.25 12.5 1099 318</p>	<p><b>RTA 00</b> 1 per carton</p>										
 <p><b>S7876RT</b></p> <p><b>Two Seater w/Arms &amp; Laminate Tablet</b>                      COM: 6.25 YD   5.72 M                      Unit weight: 118 LB   53.6 KG                      Carton weight: 130 LB   58.97 KG                      Carton volume: 41.25 FT³   1.16 MT³</p>	 <p><b>S7876LT</b></p> <p>Freestanding unit only.</p>	<p><b>S7876LT</b> S7876RT</p>	-	-	-	-	2312	2606	2900	3156	3475	3775	4181	4756
			<p><b>OVERALL DIMENSIONS</b> W D H</p> <p>IN 52.75 33.5 30 MM 1340 851 762</p> <p><b>SEAT DIMENSIONS</b> W D H</p> <p>43.25 19.5 17.5 1099 495 445</p> <p><b>BACK DIMENSIONS</b> W H</p> <p>43.25 12.5 1099 318</p>	<p><b>RTA 00</b> 1 per carton</p>										
 <p><b>S7876LRT</b></p> <p><b>Two Seater w/Arms &amp; Laminate Tablets</b>                      COM: 6.25 YD   5.72 M                      Unit weight: 126 LB   57.3 KG                      Carton weight: 138 LB   62.6 KG                      Carton volume: 41.25 FT³   1.16 MT³</p>	<p>Freestanding unit only.                       Left and right tablets.</p>	<p><b>S7876LRT</b></p>	-	-	-	-	2745	3039	3333	3589	3908	4208	4614	5189
			<p><b>OVERALL DIMENSIONS</b> W D H</p> <p>IN 54.25 33.5 30 MM 1378 851 762</p> <p><b>SEAT DIMENSIONS</b> W D H</p> <p>43.25 19.5 17.5 1099 495 445</p> <p><b>BACK DIMENSIONS</b> W H</p> <p>43.25 12.5 1099 318</p>	<p><b>RTA 00</b> 1 per carton</p>										
 <p><b>S7896</b></p> <p><b>Armless Two Seater</b>                      COM: 5 YD   4.57 M                      Unit weight: 78 LB   35.5 KG                      Carton weight: 90 LB   40.82 KG                      Carton volume: 36 FT³   1.01 MT³</p>	<p>Ganging hardware not included.                       Armless side(s) can be equipped with ganging brackets, model 7892.</p>	<p><b>S7896</b></p>	-	-	-	-	1882	2117	2352	2557	2812	3052	3377	3837
			<p><b>OVERALL DIMENSIONS</b> W D H</p> <p>IN 43.25 31 30.75 MM 1099 787 781</p> <p><b>SEAT DIMENSIONS</b> W D H</p> <p>43.25 19.5 17.5 1099 495 445</p> <p><b>BACK DIMENSIONS</b> W H</p> <p>43.25 13.25 1099 337</p>	<p><b>RTA 00</b> 1 per carton</p>										

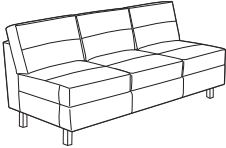
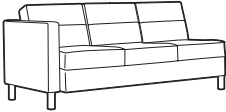
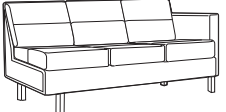
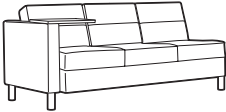
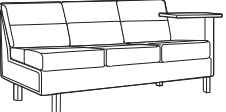
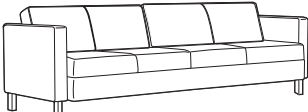
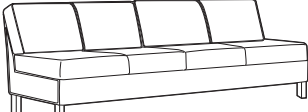
DESCRIPTION	FEATURES	MODEL#	STANDARD TEXTILE GRADES											
			1	2	3	4	5	6	7	8	9	10	11	12
<p><b>S7890R</b></p> <p><b>Two Seater w/One Arm</b>                      COM: 5.25 YD   4.8 M                      Unit weight: 94 LB   42.7 KG                      Carton weight: 106 LB   48.08 KG                      Carton volume: 36 FT³   1.01 MT³</p>	<p><b>S7890L</b></p> <p>Ganging hardware not included.                       Armless side can be equipped with ganging brackets, model 7892.</p>	<b>S7890L</b> S7890R	-	-	-	-	1882	2129	2376	2591	2859	3111	3452	3935
			<b>OVERALL DIMENSIONS</b>			<b>SEAT DIMENSIONS</b>			<b>BACK DIMENSIONS</b>					
			<b>W</b>	<b>D</b>	<b>H</b>	<b>W</b>	<b>D</b>	<b>H</b>	<b>W</b>	<b>H</b>				
			IN 47.25	31	30.75	43.25	19.5	17.5	43.25	13.25				
			MM 1200	787	781	1099	495	445	1099	337				
			<b>RTA 00</b>	1 per carton										
<p><b>S7890RRT</b></p> <p><b>Two Seater w/One Arm and Laminate Tablet</b>                      COM: 5.25 YD   4.8 M                      Unit weight: 102 LB   46.4 KG                      Carton weight: 114 LB   51.71 KG                      Carton volume: 41.25 FT³   1.16 MT³</p>	<p><b>S7890LLT</b></p> <p>Ganging hardware not included.                       Armless side(s) can be equipped with ganging brackets, model 7892.</p>	<b>S7890LLT</b> S7890RRT	-	-	-	-	2312	2559	2806	3021	3289	3541	3882	4365
			<b>OVERALL DIMENSIONS</b>			<b>SEAT DIMENSIONS</b>			<b>BACK DIMENSIONS</b>					
			<b>W</b>	<b>D</b>	<b>H</b>	<b>W</b>	<b>D</b>	<b>H</b>	<b>W</b>	<b>H</b>				
			IN 48.75	33.5	30.75	43.25	19.5	17.5	43.25	13.25				
			MM 1238	851	781	1099	495	445	1099	337				
			<b>RTA 00</b>	1 per carton										
<p><b>S7877</b></p> <p><b>Three Seater w/Arms</b>                      COM: 8.75 YD   8 M                      Unit weight: 149 LB   67.7 KG                      Carton weight: 163 LB   73.94 KG                      Carton volume: 50.25 FT³   1.42 MT³</p>	<p>Freestanding unit only.</p>	<b>S7877</b>	-	-	-	-	2432	2843	3255	3613	4060	4480	5048	5853
			<b>OVERALL DIMENSIONS</b>			<b>SEAT DIMENSIONS</b>			<b>BACK DIMENSIONS</b>					
			<b>W</b>	<b>D</b>	<b>H</b>	<b>W</b>	<b>D</b>	<b>H</b>	<b>W</b>	<b>H</b>				
			IN 72.5	31	30	64.5	19.5	17.5	64.5	12.5				
			MM 1842	787	762	1638	495	445	1638	318				
			<b>RTA 00</b>	1 per carton										
<p><b>S7877RT</b></p> <p><b>Three Seater w/Arms and Laminate Tablet</b>                      COM: 8.75 YD   8 M                      Unit weight: 157 LB   71.4 KG                      Carton weight: 171 LB   77.56 KG                      Carton volume: 55.5 FT³   1.57 MT³</p>	<p><b>S7877LT</b></p> <p>Freestanding unit only.</p>	<b>S7877LT</b> S7877RT	-	-	-	-	2863	3274	3686	4044	4491	4911	5479	6284
			<b>OVERALL DIMENSIONS</b>			<b>SEAT DIMENSIONS</b>			<b>BACK DIMENSIONS</b>					
			<b>W</b>	<b>D</b>	<b>H</b>	<b>W</b>	<b>D</b>	<b>H</b>	<b>W</b>	<b>H</b>				
			IN 74	33.5	30	64.5	19.5	17.5	64.5	12.5				
			MM 1880	851	762	1638	495	445	1638	318				
			<b>RTA 00</b>	1 per carton										
<p><b>S7877LRT</b></p> <p><b>Three Seater w/Arms and Laminate Tablets</b>                      COM: 8.75 YD   8 M                      Unit weight: 165 LB   75 KG                      Carton weight: 179 LB   81.19 KG                      Carton volume: 55.5 FT³   1.57 MT³</p>	<p>Freestanding unit only.</p> <p>Left and right tablets.</p>	<b>S7877LRT</b>	-	-	-	-	3295	3706	4118	4476	4923	5343	5911	6716
			<b>OVERALL DIMENSIONS</b>			<b>SEAT DIMENSIONS</b>			<b>BACK DIMENSIONS</b>					
			<b>W</b>	<b>D</b>	<b>H</b>	<b>W</b>	<b>D</b>	<b>H</b>	<b>W</b>	<b>H</b>				
			IN 75.5	33.5	30	64.5	19.5	17.5	64.5	12.5				
			MM 1918	851	762	1638	495	445	1638	318				
			<b>RTA 00</b>	1 per carton										

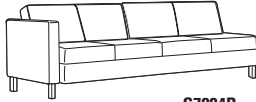
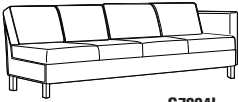
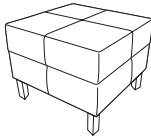
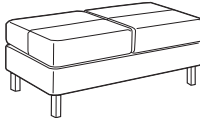
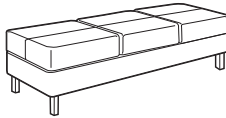
DESCRIPTION	FEATURES	MODEL#	STANDARD TEXTILE GRADES													
			1	2	3	4	5	6	7	8	9	10	11	12		
 <p><b>Armless Three Seater</b>                      COM: 8.25 YD   7.54 M                      Unit weight: 117 LB   53.2 KG                      Carton weight: 131 LB   59.42 KG                      Carton volume: 50.25 FT³   1.42 MT³</p>	Ganging hardware not included.  Armless side(s) can be equipped with ganging brackets, model 7892.	<b>S7897</b>	-	-	-	-	2432	2820	3208	3546	3967	4363	4899	5658		
			<b>OVERALL DIMENSIONS</b>			<b>SEAT DIMENSIONS</b>			<b>BACK DIMENSIONS</b>							
			<b>W</b>	<b>D</b>	<b>H</b>	<b>W</b>	<b>D</b>	<b>H</b>	<b>W</b>	<b>H</b>						
			IN 64.5 MM 1638	31 787	30.75 781	64.5 1638	19.5 495	17.5 445	64.5 1638	13.25 337						
			<b>RTA 00</b>	1 per carton												
 <p><b>S7891R</b></p>	 <p><b>S7891L</b></p>	<p><b>Three Seater w/One Arm</b>                      COM: 7.25 YD   6.63 M                      Unit weight: 133 LB   60.5 KG                      Carton weight: 147 LB   66.68 KG                      Carton volume: 50.25 FT³   1.42 MT³</p>	Ganging hardware not included.  Armless side can be equipped with ganging brackets, model 7892.	<b>S7891L</b>	-	-	-	-	2432	2773	3114	3411	3781	4129	4600	5267
					<b>OVERALL DIMENSIONS</b>			<b>SEAT DIMENSIONS</b>			<b>BACK DIMENSIONS</b>					
					<b>W</b>	<b>D</b>	<b>H</b>	<b>W</b>	<b>D</b>	<b>H</b>	<b>W</b>	<b>H</b>				
					IN 68.5 MM 1740	31 787	30.75 781	64.5 1638	19.5 495	17.5 445	64.5 1638	13.25 337				
			<b>RTA 00</b>	1 per carton												
 <p><b>S7891RRT</b></p>	 <p><b>S7891LLT</b></p>	<p><b>Three Seater w/One Arm and Laminate Tablet</b>                      COM: 7.25 YD   6.63 M                      Unit weight: 141 LB   64.1 KG                      Carton weight: 155 LB   70.31 KG                      Carton volume: 55.5 FT³   1.57 MT³</p>	Ganging hardware not included.  Armless side(s) can be equipped with ganging brackets, model 7892.	<b>S7891LLT</b>	-	-	-	-	2863	3204	3545	3842	4212	4560	5031	5698
					<b>OVERALL DIMENSIONS</b>			<b>SEAT DIMENSIONS</b>			<b>BACK DIMENSIONS</b>					
					<b>W</b>	<b>D</b>	<b>H</b>	<b>W</b>	<b>D</b>	<b>H</b>	<b>W</b>	<b>H</b>				
					IN 70 MM 1778	31 787	30.75 781	64.5 1638	19.5 495	17.5 445	64.5 1638	13.25 337				
			<b>RTA 00</b>	1 per carton												
 <p><b>S7884</b></p>	<p><b>Four Seater w/Arms</b>                      COM: 10.25 YD   9.37 M                      Unit weight: 188 LB   85.5 KG                      Carton weight: 204 LB   92.53 KG                      Carton volume: 69 FT³   1.95 MT³</p>	<b>S7884</b>	-	-	-	-	3458	3940	4422	4842	5365	5857	6523	7466		
			<b>OVERALL DIMENSIONS</b>			<b>SEAT DIMENSIONS</b>			<b>BACK DIMENSIONS</b>							
			<b>W</b>	<b>D</b>	<b>H</b>	<b>W</b>	<b>D</b>	<b>H</b>	<b>W</b>	<b>H</b>						
			IN 93.5 MM 2375	31 787	30 762	85.5 2172	19.5 495	17.5 445	85.5 2172	12.5 318						
			<b>RTA 00</b>	1 per carton												
 <p><b>S7884NA</b></p>	<p><b>Armless Four Seater</b>                      COM: 8.75 YD   8 M                      Unit weight: 156 LB   70.9 KG                      Carton weight: 172 LB   78.02 KG                      Carton volume: 61.5 FT³   1.74 MT³</p>	<b>S7884NA</b>	-	-	-	-	3458	3869	4281	4639	5086	5506	6074	6879		
			<b>OVERALL DIMENSIONS</b>			<b>SEAT DIMENSIONS</b>			<b>BACK DIMENSIONS</b>							
			<b>W</b>	<b>D</b>	<b>H</b>	<b>W</b>	<b>D</b>	<b>H</b>	<b>W</b>	<b>H</b>						
			IN 85.5 MM 2172	31 787	30.75 781	85.5 2172	19.5 495	17.5 445	85.5 2172	12.5 318						
			<b>RTA 00</b>	1 per carton												

DESCRIPTION	FEATURES	MODEL#	STANDARD TEXTILE GRADES												
			1	2	3	4	5	6	7	8	9	10	11	12	
 <p><b>S7884R</b></p> <p><b>Four Seater w/One Arm</b> COM: 9.5 YD   8.69 M Unit weight: 172 LB   78.2 KG Carton weight: 188 LB   85.28 KG Carton volume: 69 FT³   1.95 MT³</p>	 <p><b>S7884L</b></p> <p>Ganging hardware not included. Armless side can be equipped with ganging brackets, model 7892.</p>	<b>S7884L</b> S7884R	-	-	-	-	3458	3905	4351	4741	5225	5681	6299	7173	
			<b>OVERALL DIMENSIONS</b>			<b>SEAT DIMENSIONS</b>			<b>BACK DIMENSIONS</b>						
			<b>W</b>	<b>D</b>	<b>H</b>	<b>W</b>	<b>D</b>	<b>H</b>	<b>W</b>	<b>H</b>					
			IN 89.5	31	30.75	85.8	19.5	17.5	85.8	12.5					
			MM 2273	787	781	2179	495	445	2179	318					
			<b>RTA 00</b>	1 per carton											
 <p><b>Square Ottoman</b> COM: 1.5 YD   1.37 M Unit weight: 23 LB   10.5 KG Carton weight: 27 LB   12.25 KG Carton volume: 7.5 FT³   0.21 MT³</p>	<p>Ganging hardware not included. Side(s) can be equipped with ganging brackets, model 7892. Does not gang to seating units.</p>	<b>S7879</b>	-	-	-	-	739	810	880	942	1018	1090	1188	1326	
			<b>OVERALL DIMENSIONS</b>			<b>SEAT DIMENSIONS</b>			<b>BACK DIMENSIONS</b>						
			<b>W</b>	<b>D</b>	<b>H</b>	<b>W</b>	<b>D</b>	<b>H</b>	<b>W</b>	<b>H</b>					
			IN 22	22	17	-	-	-	-	-					
			MM 559	559	432	-	-	-	-	-					
			<b>RTA 00</b>	1 per carton											
			courier												
 <p><b>Two Seater Bench</b> COM: 2.25 YD   2.06 M Unit weight: 36 LB   16.4 KG Carton weight: 42 LB   19.05 KG Carton volume: 11.5 FT³   0.32 MT³</p>	<p>Ganging hardware not included. Side(s) can be equipped with ganging brackets, model 7892. Does not gang to seating units.</p>	<b>S7893</b>	-	-	-	-	1089	1195	1301	1393	1508	1616	1762	1969	
			<b>OVERALL DIMENSIONS</b>			<b>SEAT DIMENSIONS</b>			<b>BACK DIMENSIONS</b>						
			<b>W</b>	<b>D</b>	<b>H</b>	<b>W</b>	<b>D</b>	<b>H</b>	<b>W</b>	<b>H</b>					
			IN 43	21.5	17	-	-	-	-	-					
			MM 1092	546	432	-	-	-	-	-					
			<b>RTA 00</b>	1 per carton											
 <p><b>Three Seater Bench</b> COM: 3.75 YD   3.43 M Unit weight: 54 LB   24.5 KG Carton weight: 62 LB   28.12 KG Carton volume: 16.75 FT³   0.47 MT³</p>	<p>Ganging hardware not included. Side(s) can be equipped with ganging brackets, model 7892. Does not gang to seating units.</p>	<b>S7894</b>	-	-	-	-	1547	1723	1900	2053	2245	2425	2668	3013	
			<b>OVERALL DIMENSIONS</b>			<b>SEAT DIMENSIONS</b>			<b>BACK DIMENSIONS</b>						
			<b>W</b>	<b>D</b>	<b>H</b>	<b>W</b>	<b>D</b>	<b>H</b>	<b>W</b>	<b>H</b>					
			IN 64.5	21.5	17	-	-	-	-	-					
			MM 1638	546	432	-	-	-	-	-					
			<b>RTA 00</b>	1 per carton											
 <p><b>Two Seater Bench - Single Cushion</b> COM: 2.25 YD   2.06 M Unit weight: 36 LB   16.4 KG Carton weight: 42 LB   19.05 KG Carton volume: 11.5 FT³   0.32 MT³</p>	<p>Ganging hardware not included. Side(s) can be equipped with ganging brackets, model 7892. Does not gang to seating units.</p>	<b>S7905</b>	-	-	-	-	1089	1195	1301	1393	1508	1616	1762	1969	
			<b>OVERALL DIMENSIONS</b>			<b>SEAT DIMENSIONS</b>			<b>BACK DIMENSIONS</b>						
			<b>W</b>	<b>D</b>	<b>H</b>	<b>W</b>	<b>D</b>	<b>H</b>	<b>W</b>	<b>H</b>					
			IN 43	21.5	17	-	-	-	-	-					
			MM 1092	546	432	-	-	-	-	-					
			<b>RTA 00</b>	1 per carton											

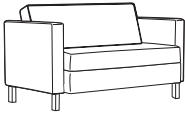
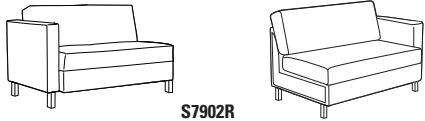
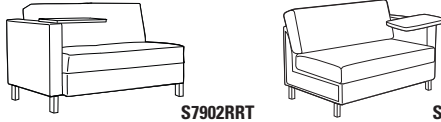
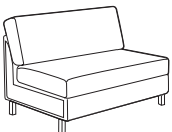
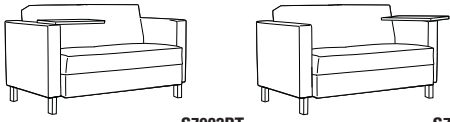
DESCRIPTION	FEATURES	MODEL#	STANDARD TEXTILE GRADES											
			1	2	3	4	5	6	7	8	9	10	11	12
 <p><b>Two Seater w/Arms - Single Cushion</b> COM: 6.5 YD   5.94 M Unit weight: 110 LB   50 KG Carton weight: 122 LB   55.34 KG Carton volume: 36 FT³   1.01 MT³</p>	Freestanding unit only.	<b>S7902</b>	-	-	-	-	1967	2273	2578	2845	3176	3488	3911	4509
			<b>OVERALL DIMENSIONS</b>			<b>SEAT DIMENSIONS</b>			<b>BACK DIMENSIONS</b>					
			W	D	H	W	D	H	W	H				
			IN 51.25 MM 1302	31 787	30 762	43.25 1099	19.5 495	17.5 445	43.25 1099	12.5 318				
			<b>RTA 00</b>	1 per carton										
 <p><b>Two Seater w/One Arm - Single Cushion</b> COM: 6.5 YD   5.94 M Unit weight: 102 LB   46.4 KG Carton weight: 114 LB   51.71 KG Carton volume: 36 FT³   1.01 MT³</p>	Ganging hardware not included.  Armless side can be equipped with ganging brackets, model 7892.	<b>S7902L</b> S7902R	-	-	-	-	1967	2273	2578	2845	3176	3488	3911	4509
			<b>OVERALL DIMENSIONS</b>			<b>SEAT DIMENSIONS</b>			<b>BACK DIMENSIONS</b>					
			W	D	H	W	D	H	W	H				
			IN 47.25 MM 1200	31 787	30.75 781	43.25 1099	19.5 495	17.5 445	43.25 1099	13.25 337				
			<b>RTA 00</b>	1 per carton										
 <p><b>Two Seater w/One Arm &amp; Lam. Tablet - Single Cushion</b> COM: 5.25 YD   4.8 M Unit weight: 102 LB   46.4 KG Carton weight: 114 LB   51.71 KG Carton volume: 36 FT³   1.01 MT³</p>	Ganging hardware not included.  Armless side can be equipped with ganging brackets, model 7892.	<b>S7902LLT</b> S7902RRT	-	-	-	-	2399	2646	2893	3108	3376	3628	3969	4452
			<b>OVERALL DIMENSIONS</b>			<b>SEAT DIMENSIONS</b>			<b>BACK DIMENSIONS</b>					
			W	D	H	W	D	H	W	H				
			IN 48.75 MM 1238	33.5 851	30.75 781	43.25 1099	19.5 495	17.5 445	43.25 1099	13.25 337				
			<b>RTA 00</b>	1 per carton										
 <p><b>Armless Two Seater - Single Cushion</b> COM: 4.5 YD   4.11 M Unit weight: 78 LB   35.5 KG Carton weight: 90 LB   40.82 KG Carton volume: 36 FT³   1.01 MT³</p>	Ganging hardware not included.  Armless side(s) can be equipped with ganging brackets, model 7892.	<b>S7902NA</b>	-	-	-	-	1967	2179	2390	2575	2804	3020	3313	3727
			<b>OVERALL DIMENSIONS</b>			<b>SEAT DIMENSIONS</b>			<b>BACK DIMENSIONS</b>					
			W	D	H	W	D	H	W	H				
			IN 43.25 MM 1099	31 787	30.75 781	43.25 1099	19.5 495	17.5 445	43.25 1099	13.25 337				
			<b>RTA 00</b>	1 per carton										
 <p><b>Two Seater w/Arms &amp; Lam. Tablet - Single Cushion</b> COM: 6.5 YD   5.94 M Unit weight: 118 LB   53.6 KG Carton weight: 130 LB   58.97 KG Carton volume: 41.25 FT³   1.16 MT³</p>	Freestanding unit only.	<b>S7902LT</b> S7902RT	-	-	-	-	2399	2705	3010	3277	3608	3920	4343	4941
			<b>OVERALL DIMENSIONS</b>			<b>SEAT DIMENSIONS</b>			<b>BACK DIMENSIONS</b>					
			W	D	H	W	D	H	W	H				
			IN 52.75 MM 1340	33.5 851	30 762	43.25 1099	19.5 495	17.5 445	43.25 1099	12.5 318				
			<b>RTA 00</b>	1 per carton										

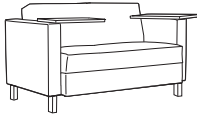
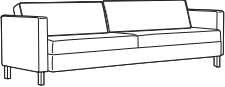
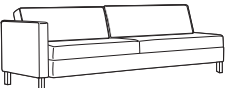
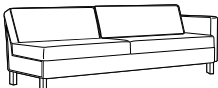
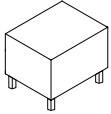
DESCRIPTION	FEATURES	MODEL#	STANDARD TEXTILE GRADES														
			1	2	3	4	5	6	7	8	9	10	11	12			
 <p><b>Two Seater w/Arms &amp; Lam. Tablets - Single Cushion</b>                      COM: 5.25 YD   4.8 M                      Unit weight: 115 LB   52.3 KG                      Carton weight: 127 LB   57.61 KG                      Carton volume: 41.25 FT³   1.16 MT³</p>	Freestanding unit only.  Left and right tablets.	<b>S7902LRT</b>	-	-	-	-	2829	3076	3323	3538	3806	4058	4399	4882			
			OVERALL DIMENSIONS			SEAT DIMENSIONS			BACK DIMENSIONS								
			W	D	H	W	D	H	W	H							
			IN 54.25	33.5	30	43.25	19.5	17.5	43.25	12.5							
			MM 1378	851	762	1099	495	445	1099	318							
		<b>RTA 00</b>	1 per carton														
 <p><b>Four Seater w/Arms - Duo Cushion</b>                      COM: 10.25 YD   9.37 M                      Unit weight: 188 LB   85.5 KG                      Carton weight: 204 LB   92.53 KG                      Carton volume: 69 FT³   1.95 MT³</p>	Freestanding unit only.	<b>S7904</b>	-	-	-	-	3489	3971	4453	4873	5396	5888	6554	7497			
			OVERALL DIMENSIONS			SEAT DIMENSIONS			BACK DIMENSIONS								
			W	D	H	W	D	H	W	H							
			IN 93.5	31	30	85.5	19.5	17.5	85.5	12.5							
			MM 2375	787	762	2172	495	445	2172	318							
		<b>RTA 00</b>	1 per carton														
 <p><b>Four Seater w/One Arm - Duo Cushion</b>                      COM: 9.5 YD   8.69 M                      Unit weight: 172 LB   78.2 KG                      Carton weight: 188 LB   85.29 KG                      Carton volume: 61.5 FT³   1.74 MT³</p>	Ganging hardware not included.  Armless side can be equipped with ganging brackets, model 7892.	<b>S7904L</b>	-	-	-	-	3489	3936	4382	4772	5256	5712	6330	7204			
			OVERALL DIMENSIONS			SEAT DIMENSIONS			BACK DIMENSIONS								
			W	D	H	W	D	H	W	H							
			IN 89.5	31	30.75	85.5	19.5	17.5	89.5	12.5							
			MM 2273	787	781	2273	495	445	2273	318							
		<b>RTA 00</b>	1 per carton														
 <p><b>Four Seater w/One Arm - Duo Cushion</b>                      COM: 8.75 YD   8 M                      Unit weight: 156 LB   70.9 KG                      Carton weight: 172 LB   78.02 KG                      Carton volume: 61.5 FT³   1.74 MT³</p>	Ganging hardware not included.  Armless side(s) can be equipped with ganging brackets, model 7892.	<b>S7904R</b>	-	-	-	-	3489	3900	4312	4670	5117	5537	6105	6910			
			OVERALL DIMENSIONS			SEAT DIMENSIONS			BACK DIMENSIONS								
			W	D	H	W	D	H	W	H							
			IN 85.5	31	30.75	85.5	19.5	17.5	85.5	12.5							
			MM 2172	787	781	2172	495	445	2172	318							
		<b>RTA 00</b>	1 per carton														
 <p><b>Cube End Table</b>                      COM: N/A                      Unit weight: 41 LB   18.6 KG                      Carton weight: 51 LB   23.13 KG                      Carton volume: 5.5 FT³   0.15 MT³</p>	Leg finish upcharges: Chrome ( <b>CHM</b> ) - add \$64 Brushed Chrome ( <b>BCH</b> ) - add \$104 Satin Brass ( <b>SBR</b> ) - add \$198 Antique Copper ( <b>ACO</b> ) - add \$198  Freestanding unit only.  For power/USB unit please see electrical placement chart.	<b>S7911</b>	List price														
			1268														
			OVERALL DIMENSIONS			SEAT DIMENSIONS			BACK DIMENSIONS								
			W	D	H	W	D	H	W	H							
			IN 20	24	16	-	-	-	-	-							
MM 508	610	406	-	-	-	-	-										
		<b>RTA 00</b>	1 per carton														



DESCRIPTION FEATURES MODEL# STANDARD TEXTILE GRADES

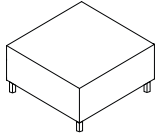

**Cube Square Coffee Table**  
 COM: N/A  
 Unit weight: 74 LB | 33.6 KG  
 Carton weight: 86 LB | 39.01 KG  
 Carton volume: 10.75 FT³ | 0.3 MT³

Leg finish upcharges:  
 Chrome (CHM) - add \$46  
 Brushed Chrome (BCH) - add \$221  
 Satin Brass (SBR) - add \$315  
 Antique Copper (ACO) - add \$315

Freestanding unit only.

For power/USB unit please see electrical placement chart.

List price									
<b>S7912</b>		1616							
OVERALL DIMENSIONS			SEAT DIMENSIONS			BACK DIMENSIONS			
W	D	H	W	D	H	W	H		
IN 33	33	14	-	-	-	-	-		
MM 838	838	356	-	-	-	-	-		
		<b>RTA 00</b>		1 per carton					

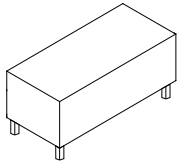

**Cube 40" Coffee Table**  
 COM: N/A  
 Unit weight: 56 LB | 25.5 KG  
 Carton weight: 66 LB | 29.94 KG  
 Carton volume: 8 FT³ | 0.22 MT³

Leg finish upcharges:  
 Chrome (CHM) - add \$67  
 Brushed Chrome (BCH) - add \$115  
 Satin Brass (SBR) - add \$246  
 Antique Copper (ACO) - add \$246

Freestanding unit only.

For power/USB unit please see electrical placement chart.

List price									
<b>S7913</b>		1534							
OVERALL DIMENSIONS			SEAT DIMENSIONS			BACK DIMENSIONS			
W	D	H	W	D	H	W	H		
IN 40	20	14	-	-	-	-	-		
MM 1016	508	356	-	-	-	-	-		
		<b>RTA 00</b>		1 per carton					

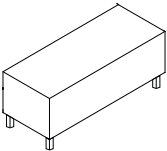

**Cube Extended 60" Coffee Table**  
 COM: N/A  
 Unit weight: 81 LB | 36.8 KG  
 Carton weight: 93 LB | 42.18 KG  
 Carton volume: 12 FT³ | 0.33 MT³

Leg finish upcharges:  
 Chrome (CHM) - add \$67  
 Brushed Chrome (BCH) - add \$99  
 Satin Brass (SBR) - add \$230  
 Antique Copper (ACO) - add \$230

Freestanding unit only.

For power/USB unit please see electrical placement chart.

List price									
<b>S7915</b>		2007							
OVERALL DIMENSIONS			SEAT DIMENSIONS			BACK DIMENSIONS			
W	D	H	W	D	H	W	H		
IN 60	20	14	-	-	-	-	-		
MM 1524	508	356	-	-	-	-	-		
		<b>RTA 00</b>		1 per carton					

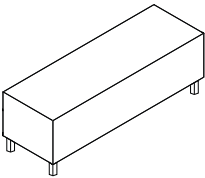

**Cube Extended 72" Coffee Table**  
 COM: N/A  
 Unit weight: 107 LB | 48.53 KG  
 Carton weight: 107 LB | 48.53 KG  
 Carton volume: 14.25 FT³ | 0.4 MT³

Leg finish upcharges:  
 Chrome (CHM) - add \$81  
 Brushed Chrome (BCH) - add \$188  
 Satin Brass (SBR) - add \$313  
 Antique Copper (ACO) - add \$313

Freestanding unit only.

For power/USB unit please see electrical placement chart.

List price									
<b>S7916</b>		2087							
OVERALL DIMENSIONS			SEAT DIMENSIONS			BACK DIMENSIONS			
W	D	H	W	D	H	W	H		
IN 72	20	14	-	-	-	-	-		
MM 1829	508	356	-	-	-	-	-		
		<b>RTA 00</b>		1 per carton					

DRIFT SEATING



model 8034



model 8037



model 8030



model 8052



model 8022



model 8026

Drift Tables



For Drift tables, please see page 251.

EXAMPLE DRIFT SEATING ORDER CODE:

8030P	-S2	-WA50	-SE	-WA50	-R11
Model number	Sealed Seams (back)	Back/arm textile	Sealed seams (seat)	Seat textile	Patch color

-AAM	-NM	-NB
Base finish	Glide type	Moisture barrier

Release vinyl for arm and head patches

(R11) White	(R21) Red Barn	(R31) Green
(R12) Chalk	(R22) Brave Red	(R32) Blue
(R13) Stone	(R23) Gypsy Red	(R33) Black
(R14) Taupe	(R24) Cajun	(R34) Cool Grey
(R15) Orange	(R25) Vinyard	(R35) Thunder Grey
(R16) Country	(R26) Olive	(R36) Navy
(R17) Tuscan	(R27) Bonsai	(R37) Dark Chocolate
(R18) Cottage	(R28) Summer's Dream	(R38) Espresso
(R19) Yellow	(R29) Calico	

MECHANISM OPTIONS:

Tilter mechanism (-4)

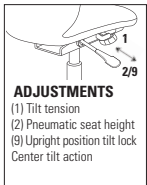

Ergonomic features:

B, C, S, U

STANDARD FEATURES

- The soft seat, contoured back and arms provide the perfect balance of style and comfort.
- Wood fixed bases are made from beechwood and available in all standard wood finishes.
- Wood fixed and swivel base models are standard with White non-marking polycarbonate glides (see right column for additional glide options).
- Sled bases are standard in paint or plated finishes (see right column for upcharges).
- Sled base models are standard with clear polycarbonate glides (see right column for additional glide options).
- For increased durability on side and lounge chairs, select P and PH suffix models which are available with arm and head patches made from Global's Release vinyl. Please specify color.
- For ease of cleaning on side and lounge chairs, models with F suffix have flip-forward seats (material under seat matches chosen seat textile).
- Sealed seams are available on chair backs and/or seats (with upcharge). For sealed seams on Ottoman, choose model 8026S which is available in sealed seam approved textiles only.
- Moisture barrier can be added to seat cushions only (with upcharge) but cannot be combined with sealed seams.
- Assembled using tamperproof screws and comes shipped fully assembled.
- Upholstery options: fabric, vinyl or leather. Vinyl and leather models may feature stitch detail across the seat and/or back cushions, if applicable.
- Active weight capacity for this series is 300 lbs

SIDE CHAIRS

- Available with six base options: sled, wood fixed, wood four star swivel, Chrome four star swivel, high four star swivel and five star base on casters.
- High four star swivel base is polished aluminum with White non-marking glides (see right column for additional glide options).
- Chairs on casters with five star 360° base swivel, are height adjustable with a 4" seat height range and include a tilting mechanism with upright tilt lock. Carpet and hard floor casters are available (see right column for caster options).

LOUNGE CHAIRS

- Available with four base options: sled, wood fixed, wood four star swivel and Chrome four star swivel.
- Chrome four star swivel models are available with 360° self-centering or swivel option. Base only available in polished Chrome.
- Available in two seat heights: 17" with a classic lounge angle or 18" with a reduced back angle for ease of sitting and standing.

STOOLS

- Counter or bar height stools are available with three base options: sled, wood fixed and metal four star swivel.



OTTOMAN

- Features a weighted bottom to always maintain an upright position and White non-marking glides.

Please add option codes in the following order:

- Model number**  
specify model number
- Back seams and textile**  
(NS) no sealed back seams  
(S2) sealed back seams. See model for upcharge. Specify textile code.
- Seat seams and textile**  
(NS) no sealed seat seams  
(SE) sealed seat seams. See model for upcharge. Specify textile code.
- Arm and head patch textile**  
(for P and PH suffix models) See bottom left for Release vinyl arm and head patches color chart.
- Base height** (lounge seating only)  
(S17) 17" seat height  
(S18) 18" seat height
- Wood base finish** (wood base models only)  

(AAM) Absolute	(NLW) Natural Walnut
(BKM) Black	(ASM) Night
(ACM) Cherry	(NBM) Noce Biondo
(EOM) English Oak	(NGM) Noce Grigio
(ECM) Espresso Cafe	(NEM) Noce Leggero
(TFM) Fruitwood	(NMM) Noce Medio
(HGM) Gray	(SKM) Shaker Cherry
(AHM) Honey	(TWM) Walnut
(TMM) Mahogany	(WTM) WC Cream
(AVM) Maple	(WHM) White
(MVM) Medium Walnut	(WCM) Winter Cherry
- Frame finish** (sled base models only)  
For leg frame finish options, please see page 360. Upcharges apply for the following plated finish:  
(CHM) Chrome. Add \$41 for side/lounge. Add \$79 for counter. Add \$79 for bar.
- Base finish** (five star base side chair only)  
(A7) polished aluminum
- Cylinder selection**  
(Chrome swivel lounge models only)  
(DSC) swivel cylinder  
(DAC) self-centering
- Glide type** (wood base seating only)  
(NM) White non-marking nylon for most surfaces (standard)  
(SG) steel cushioned glides for carpeted surfaces. Add \$17.  
(RG) non-slip rubber glides for most hard floor surfaces. Add \$22.  
(FG) felt glides for most hard floor surfaces. Add \$22.
- Glide type** (wire sled base seating)  
(CG) clear polycarbonate glides for most surfaces (standard)  
(XG) no glides  
(SG) steel cushioned glides for carpeted surfaces. Add \$19.  
(RG) rubber glides for most hard floor surfaces. Add \$19.  
(FG) felt glides for most hard floor surfaces. Add \$19.
- Glide type** (high four star base chairs)  
(NM) White polyethylene non-marking for most surfaces (standard)  
(FG) felt glides for most hard floor surfaces. Add \$22.
- Caster type** (five star base chairs)  
(DC) 2" casters for carpeted surfaces.  
(RC) 2" casters for most hard floor surfaces. Add \$17.
- Moisture barrier** (not available with sealed seams)  
(NB) no moisture barrier.  
(MB) moisture barrier (seat only). Add \$81.

DESCRIPTION	FEATURES	MODEL #	STANDARD TEXTILE GRADES														
			1	2	3	4	5	6	7	8	9	10	11	12			
	<b>Ottoman</b> COM: 2 YD   1.83 M Unit weight: 25 LB   11.4 KG Carton weight: 31 LB   14.06 KG Carton volume: 8.5 FT³   0.24 MT³	8026	803	867	922	983	1086	1179	1274	1355	1458	1554	1683	1867			
			8026S	905	969	1024	1085	1188	1281	1376	1457	1560	1656	1785	1969		
			sealed seams														
			<b>OVERALL DIMENSIONS</b>			<b>SEAT DIMENSIONS</b>			<b>BACK DIMENSIONS</b>								
			<b>W</b>	<b>D</b>	<b>H</b>	<b>W</b>	<b>D</b>	<b>H</b>	<b>W</b>	<b>H</b>							
			IN 18.5	18.5	18	-	-	-	-	-							
			MM 470	470	457	-	-	-	-	-							
			<b>RTA 00</b>		1 per carton												

DESCRIPTION	FEATURES	MODEL #	STANDARD TEXTILE GRADES														
			1	2	3	4	5	6	7	8	9	10	11	12			
	<b>Side Chair w/Sled Base</b> COM: 2 YD   1.83 M Unit weight: 22 LB   10 KG Carton weight: 31 LB   14.06 KG Carton volume: 13.25 FT³   0.37 MT³	8023	1389	1453	1507	1570	1671	1765	1859	1941	2043	2139	2269	2453			
			8023F	1489	1561	1622	1692	1806	1912	2018	2110	2225	2333	2479	2686		
			flip-forward seat														
			8023P	1409	1473	1527	1590	1691	1785	1879	1961	2063	2159	2289	2473		
			with arm patches														
			8023PF	1509	1581	1642	1712	1826	1932	2038	2130	2245	2353	2499	2706		
			with arm patches + flip-forward seat														
			<b>OVERALL DIMENSIONS</b>			<b>SEAT DIMENSIONS</b>			<b>BACK DIMENSIONS</b>								
			<b>W</b>	<b>D</b>	<b>H</b>	<b>W</b>	<b>D</b>	<b>H</b>	<b>W</b>	<b>H</b>							
			IN 24.5	23	31	18	17.5	18	15	13							
			MM 622	584	787	457	445	457	381	330							
			<b>RTA 00</b>	1 per carton													

	sealed seam upcharges	
	(S2)	(SE)
8023	Add \$33	Add \$25
8023F	Add \$33	Add \$40
8023P	Add \$49	Add \$25
8023PF	Add \$49	Add \$40

DESCRIPTION	FEATURES	MODEL #	STANDARD TEXTILE GRADES														
			1	2	3	4	5	6	7	8	9	10	11	12			
	<b>Side Chair w/Four-Legged Wood Base</b> COM: 2 YD   1.83 M Unit weight: 24 LB   10.9 KG Carton weight: 31 LB   14.06 KG Carton volume: 15.75 FT³   0.44 MT³	8030	1469	1533	1587	1650	1751	1845	1939	2021	2123	2219	2349	2533			
			8030F	1569	1641	1702	1772	1886	1992	2098	2190	2305	2413	2559	2766		
			flip-forward seat														
			8030P	1489	1553	1607	1670	1771	1865	1959	2041	2143	2239	2369	2553		
			with arm patches														
			8030PF	1589	1661	1722	1792	1906	2012	2118	2210	2325	2433	2579	2786		
			with arm patches + flip-forward seat														
			<b>OVERALL DIMENSIONS</b>			<b>SEAT DIMENSIONS</b>			<b>BACK DIMENSIONS</b>								
			<b>W</b>	<b>D</b>	<b>H</b>	<b>W</b>	<b>D</b>	<b>H</b>	<b>W</b>	<b>H</b>							
			IN 24.5	23	31	18	17.5	18	15	13							
			MM 622	584	787	457	445	457	381	330							
			<b>RTA 00</b>	1 per carton													

	sealed seam upcharges	
	(S2)	(SE)
8030	Add \$33	Add \$25
8030F	Add \$33	Add \$40
8030P	Add \$49	Add \$25
8030PF	Add \$49	Add \$40

DESCRIPTION	FEATURES	MODEL #	STANDARD TEXTILE GRADES														
			1	2	3	4	5	6	7	8	9	10	11	12			
	<b>Side Chair w/Wood Swivel Base</b> COM: 2 YD   1.83 M Unit weight: 24 LB   10.9 KG Carton weight: 31 LB   14.06 KG Carton volume: 15.75 FT³   0.44 MT³	8031	1706	1770	1824	1887	1988	2082	2176	2258	2360	2456	2586	2770			
			8031F	1806	1878	1939	2009	2123	2229	2335	2427	2542	2650	2796	3003		
			flip-forward seat														
			8031P	1726	1790	1844	1907	2008	2102	2196	2278	2380	2476	2606	2790		
			with arm patches														
			8031PF	1826	1898	1959	2029	2143	2249	2355	2447	2562	2670	2816	3023		
			with arm patches + flip-forward seat														
			<b>OVERALL DIMENSIONS</b>			<b>SEAT DIMENSIONS</b>			<b>BACK DIMENSIONS</b>								
			<b>W</b>	<b>D</b>	<b>H</b>	<b>W</b>	<b>D</b>	<b>H</b>	<b>W</b>	<b>H</b>							
			IN 24.5	23	31	18	17.5	18	15	13							
			MM 622	584	787	457	445	457	381	330							
			<b>RTA 00</b>	1 per carton													

	sealed seam upcharges	
	(S2)	(SE)
8031	Add \$33	Add \$25
8031F	Add \$33	Add \$40
8031P	Add \$49	Add \$25
8031PF	Add \$49	Add \$40

DESCRIPTION FEATURES MODEL # STANDARD TEXTILE GRADES



**Side Chair w/Chrome Swivel Base**  
 COM: 2 YD | 1.83 M  
 Unit weight: 24 LB | 10.9 KG  
 Carton weight: 31 LB | 14.06 KG  
 Carton volume: 15.75 FT³ | 0.44 MT³

Model #	sealed seam upcharges	
	(S2)	(SE)
8032	Add \$33	Add \$25
8032F	Add \$33	Add \$40
8032P	Add \$49	Add \$25
8032PF	Add \$49	Add \$40

Model #	1	2	3	4	5	6	7	8	9	10	11	12
8032	1748	1812	1866	1929	2030	2124	2218	2300	2402	2498	2628	2812
8032F	1848	1920	1981	2051	2165	2271	2377	2469	2584	2692	2838	3045
8032P	1768	1832	1886	1949	2050	2144	2238	2320	2422	2518	2648	2832
8032PF	1868	1940	2001	2071	2185	2291	2397	2489	2604	2712	2858	3065

Model #	OVERALL DIMENSIONS			SEAT DIMENSIONS			BACK DIMENSIONS		
	W	D	H	W	D	H	W	H	
IN	24.5	23	31	18	17.5	18	15	13	
MM	622	584	787	457	445	457	381	330	

RTA 00 1 per carton



**Side Chair w/High Four Star Swivel Base**  
 COM: 2 YD | 1.83 M  
 Unit weight: 26.5 LB | 12 KG  
 Carton weight: 35.5 LB | 16.1 KG  
 Carton volume: 13.25 FT³ | 0.37 MT³

Fixed seat cushion only.

Model #	sealed seam upcharges	
	(S2)	(SE)
8021	Add \$33	Add \$25
8021P	Add \$49	Add \$25

Model #	1	2	3	4	5	6	7	8	9	10	11	12
8021	1558	1622	1676	1739	1840	1934	2028	2110	2212	2308	2438	2622
8021P	1578	1642	1696	1759	1860	1954	2048	2130	2232	2328	2458	2642

Model #	OVERALL DIMENSIONS			SEAT DIMENSIONS			BACK DIMENSIONS		
	W	D	H	W	D	H	W	H	
IN	24.5	23	32	18	17.5	18.5	15	13	
MM	622	584	813	457	445	470	381	330	

RTA 00 1 per carton



**Side Chair w/Five Star Swivel Tilt Base on Casters**  
 COM: 2 YD | 1.83 M  
 Unit weight: 28.5 LB | 13 KG  
 Carton weight: 37.5 LB | 17.01 KG  
 Carton volume: 15.75 FT³ | 0.44 MT³

Tilting mechanism with tilt lock.  
 Fixed seat cushion only.

Model #	sealed seam upcharges	
	(S2)	(SE)
8022	Add \$33	Add \$25
8022P	Add \$49	Add \$25

Model #	1	2	3	4	5	6	7	8	9	10	11	12
8022	1701	1765	1819	1882	1983	2077	2171	2253	2355	2451	2581	2765
8022P	1721	1785	1839	1902	2003	2097	2191	2273	2375	2471	2601	2785

Model #	OVERALL DIMENSIONS			SEAT DIMENSIONS			BACK DIMENSIONS		
	W	D	H	W	D	H	W	H	
IN	24.5	23	32.5	18	17.5	15	15	13	
MM	622	584	826	457	445	381	381	330	

RTA 00 1 per carton



**Low Back Lounge Chair w/Sled Base**  
 COM: 3.25 YD | 2.97 M  
 Unit weight: 42 LB | 19.1 KG  
 Carton weight: 52 LB | 23.59 KG  
 Carton volume: 19.25 FT³ | 0.54 MT³

Model #	sealed seam upcharges	
	(S2)	(SE)
8024	Add \$68	Add \$29
8024F	Add \$68	Add \$44
8024P	Add \$84	Add \$29
8024PF	Add \$84	Add \$44

Model #	1	2	3	4	5	6	7	8	9	10	11	12
8024	1829	1933	2021	2122	2287	2440	2593	2726	2892	3048	3259	3558
8024F	1954	2082	2190	2315	2518	2706	2894	3058	3262	3454	3714	4082
8024P	1849	1953	2041	2142	2307	2460	2613	2746	2912	3068	3279	3578
8024PF	1974	2102	2210	2335	2538	2726	2914	3078	3282	3474	3734	4102

Model #	OVERALL DIMENSIONS			SEAT DIMENSIONS			BACK DIMENSIONS		
	W	D	H	W	D	H	W	H	
IN	29	30	33	21.5	20	17	21	16	
MM	737	762	838	546	508	432	533	406	

RTA 00 1 per carton

DESCRIPTION	FEATURES	MODEL #	STANDARD TEXTILE GRADES											
			1	2	3	4	5	6	7	8	9	10	11	12



**Low Back Lounge Chair w/Four-Legged Wood Base**  
 COM: 3.25 YD | 2.97 M  
 Unit weight: 43.5 LB | 19.8 KG  
 Carton weight: 53.5 LB | 24.27 KG  
 Carton volume: 19 FT³ | 0.53 MT³

	sealed seam upcharges	
	(S2)	(SE)
<b>8025</b>	Add \$68	Add \$29
<b>8025F</b>	Add \$68	Add \$44
<b>8025P</b>	Add \$84	Add \$29
<b>8025PF</b>	Add \$84	Add \$44

	1	2	3	4	5	6	7	8	9	10	11	12
<b>8025</b>	2329	2433	2521	2622	2787	2940	3093	3226	3392	3548	3759	4058
<b>8025F</b>	2454	2582	2690	2815	3018	3206	3394	3558	3762	3954	4214	4582
flip-forward seat												
<b>8025P</b>	2349	2453	2541	2642	2807	2960	3113	3246	3412	3568	3779	4078
with arm patches												
<b>8025PF</b>	2474	2602	2710	2835	3038	3226	3414	3578	3782	3974	4234	4602
with arm patches + flip-forward seat												

	OVERALL DIMENSIONS			SEAT DIMENSIONS			BACK DIMENSIONS					
	W	D	H	W	D	H	W	H				
IN	29	30	33	21.5	20	17	21	16				
MM	737	762	838	546	508	432	533	406				
<b>RTA 00</b>	1 per carton											



**Low Back Lounge Chair w/Wood Swivel Base**  
 COM: 3.25 YD | 2.97 M  
 Unit weight: 43 LB | 19.5 KG  
 Carton weight: 53 LB | 24.04 KG  
 Carton volume: 19 FT³ | 0.53 MT³

	sealed seam upcharges	
	(S2)	(SE)
<b>8033</b>	Add \$68	Add \$29
<b>8033F</b>	Add \$68	Add \$44
<b>8033P</b>	Add \$84	Add \$29
<b>8033PF</b>	Add \$84	Add \$44

	1	2	3	4	5	6	7	8	9	10	11	12
<b>8033</b>	2329	2433	2521	2622	2787	2940	3093	3226	3392	3548	3759	4058
<b>8033F</b>	2454	2582	2690	2815	3018	3206	3394	3558	3762	3954	4214	4582
flip-forward seat												
<b>8033P</b>	2349	2453	2541	2642	2807	2960	3113	3246	3412	3568	3779	4078
with arm patches												
<b>8033PF</b>	2474	2602	2710	2835	3038	3226	3414	3578	3782	3974	4234	4602
with arm patches + flip-forward seat												

	OVERALL DIMENSIONS			SEAT DIMENSIONS			BACK DIMENSIONS					
	W	D	H	W	D	H	W	H				
IN	29	30	33	21.5	20	17	21	16				
MM	737	762	838	546	508	432	533	406				
<b>RTA 00</b>	1 per carton											



**Low Back Lounge Chair w/Chrome Swivel Base**  
 COM: 3.25 YD | 2.97 M  
 Unit weight: 49 LB | 22.3 KG  
 Carton weight: 59 LB | 26.76 KG  
 Carton volume: 19.25 FT³ | 0.54 MT³

	sealed seam upcharges	
	(S2)	(SE)
<b>8034</b>	Add \$68	Add \$29
<b>8034F</b>	Add \$68	Add \$44
<b>8034P</b>	Add \$84	Add \$29
<b>8034PF</b>	Add \$84	Add \$44

	1	2	3	4	5	6	7	8	9	10	11	12
<b>8034</b>	2344	2448	2536	2637	2802	2955	3108	3241	3407	3563	3774	4073
<b>8034F</b>	2469	2597	2705	2830	3033	3221	3409	3573	3777	3969	4229	4597
flip-forward seat												
<b>8034P</b>	2364	2468	2556	2657	2822	2975	3128	3261	3427	3583	3794	4093
with arm patches												
<b>8034PF</b>	2489	2617	2725	2850	3053	3241	3429	3593	3797	3989	4249	4617
with arm patches + flip-forward seat												

	OVERALL DIMENSIONS			SEAT DIMENSIONS			BACK DIMENSIONS					
	W	D	H	W	D	H	W	H				
IN	29	30	33	21.5	20	17	21	16				
MM	737	762	838	546	508	432	533	406				
<b>RTA 00</b>	1 per carton											



**Mid Back Lounge Chair w/Sled Base**  
 COM: 3.5 YD | 3.2 M  
 Unit weight: 42 LB | 19.1 KG  
 Carton weight: 52 LB | 23.59 KG  
 Carton volume: 25.5 FT³ | 0.72 MT³

	sealed seam upcharges	
	(S2)	(SE)
<b>8016</b>	Add \$74	Add \$29
<b>8016F</b>	Add \$74	Add \$44
<b>8016P</b>	Add \$90	Add \$29
<b>8016PF</b>	Add \$90	Add \$44

	1	2	3	4	5	6	7	8	9	10	11	12
<b>8016</b>	1923	2035	2130	2238	2417	2581	2746	2889	3068	3236	3463	3785
<b>8016F</b>	2073	2209	2324	2456	2672	2872	3072	3246	3463	3667	3943	4334
flip-forward seat												
<b>8016P</b>	1943	2055	2150	2258	2437	2601	2766	2909	3088	3256	3483	3805
with arm patches												
<b>8016PF</b>	2093	2229	2344	2476	2692	2892	3092	3266	3483	3687	3963	4354
with arm patches + flip-forward seat												

	OVERALL DIMENSIONS			SEAT DIMENSIONS			BACK DIMENSIONS					
	W	D	H	W	D	H	W	H				
IN	29	31.5	38.5	21.5	20	17	21	21.5				
MM	737	800	978	546	508	432	533	546				
<b>RTA 00</b>	1 per carton											

DESCRIPTION FEATURES MODEL # STANDARD TEXTILE GRADES



**Mid Back Lounge Chair w/Four-Legged Wood Base**  
 COM: 3.5 YD | 3.2 M  
 Unit weight: 43.5 LB | 19.8 KG  
 Carton weight: 53.5 LB | 24.27 KG  
 Carton volume: 25.5 FT³ | 0.72 MT³

	sealed seam upcharges	
	(S2)	(SE)
<b>8027</b>	Add \$74	Add \$29
<b>8027F</b>	Add \$74	Add \$44
<b>8027P</b>	Add \$90	Add \$29
<b>8027PF</b>	Add \$90	Add \$44

	1	2	3	4	5	6	7	8	9	10	11	12
<b>8027</b>	2423	2535	2630	2738	2917	3081	3246	3389	3568	3736	3963	4285
<b>8027F</b>	2573	2709	2824	2956	3172	3372	3572	3746	3963	4167	4443	4834
flip-forward seat												
<b>8027P</b>	2443	2555	2650	2758	2937	3101	3266	3409	3588	3756	3983	4305
with arm patches												
<b>8027PF</b>	2593	2729	2844	2976	3192	3392	3592	3766	3983	4187	4463	4854
with arm patches + flip-forward seat												

	OVERALL DIMENSIONS			SEAT DIMENSIONS			BACK DIMENSIONS	
	W	D	H	W	D	H	W	H
IN	29	31.5	38.5	21.5	20	17	21	21.5
MM	737	800	978	546	508	432	533	546

**RTA 00** 1 per carton



**Mid Back Lounge Chair w/Wood Swivel Base**  
 COM: 3.5 YD | 3.2 M  
 Unit weight: 44 LB | 20 KG  
 Carton weight: 54 LB | 24.49 KG  
 Carton volume: 25.5 FT³ | 0.72 MT³

	sealed seam upcharges	
	(S2)	(SE)
<b>8035</b>	Add \$74	Add \$29
<b>8035F</b>	Add \$74	Add \$44
<b>8035P</b>	Add \$90	Add \$29
<b>8035PF</b>	Add \$90	Add \$44

	1	2	3	4	5	6	7	8	9	10	11	12
<b>8035</b>	2423	2535	2630	2738	2917	3081	3246	3389	3568	3736	3963	4285
<b>8035F</b>	2573	2709	2824	2956	3172	3372	3572	3746	3963	4167	4443	4834
flip-forward seat												
<b>8035P</b>	2443	2555	2650	2758	2937	3101	3266	3409	3588	3756	3983	4305
with arm patches												
<b>8035PF</b>	2593	2729	2844	2976	3192	3392	3592	3766	3983	4187	4463	4854
with arm patches + flip-forward seat												

	OVERALL DIMENSIONS			SEAT DIMENSIONS			BACK DIMENSIONS	
	W	D	H	W	D	H	W	H
IN	29	31.5	38.5	21.5	20	17	21	21.5
MM	737	800	978	546	508	432	533	546

**RTA 00** 1 per carton



**Mid Back Lounge Chair w/Chrome Swivel Base**  
 COM: 3.5 YD | 3.2 M  
 Unit weight: 50 LB | 22.7 KG  
 Carton weight: 60 LB | 27.22 KG  
 Carton volume: 25.5 FT³ | 0.72 MT³

	sealed seam upcharges	
	(S2)	(SE)
<b>8036</b>	Add \$74	Add \$29
<b>8036F</b>	Add \$74	Add \$44
<b>8036P</b>	Add \$90	Add \$29
<b>8036PF</b>	Add \$90	Add \$44

	1	2	3	4	5	6	7	8	9	10	11	12
<b>8036</b>	2439	2551	2646	2754	2933	3097	3262	3405	3584	3752	3979	4301
<b>8036F</b>	2589	2725	2840	2972	3188	3388	3588	3762	3979	4183	4459	4850
flip-forward seat												
<b>8036P</b>	2459	2571	2666	2774	2953	3117	3282	3425	3604	3772	3999	4321
with arm patches												
<b>8036PF</b>	2609	2745	2860	2992	3208	3408	3608	3782	3999	4203	4479	4870
with arm patches + flip-forward seat												

	OVERALL DIMENSIONS			SEAT DIMENSIONS			BACK DIMENSIONS	
	W	D	H	W	D	H	W	H
IN	29	31.5	38.5	21.5	20	17	21	21.5
MM	737	800	978	546	508	432	533	546

**RTA 00** 1 per carton





**High Back Lounge Chair w/Sled Base**  
 COM: 3.75 YD | 3.43 M  
 Unit weight: 46 LB | 20.9 KG  
 Carton weight: 56 LB | 25.4 KG  
 Carton volume: 28.25 FT³ | 0.79 MT³



	sealed seam upcharges	
	(S2)	(SE)
<b>8028</b>	Add \$76	Add \$29
<b>8028F</b>	Add \$76	Add \$44
<b>8028P</b>	Add \$93	Add \$29
<b>8028PF</b>	Add \$93	Add \$44
<b>8028PH</b>	Add \$112	Add \$29
<b>8028PHF</b>	Add \$112	Add \$44



	1	2	3	4	5	6	7	8	9	10	11	12
<b>8028</b>	2150	2270	2371	2488	2679	2855	3031	3185	3376	3556	3800	4145
<b>8028F</b>	2325	2469	2591	2731	2959	3171	3383	3567	3797	4013	4305	4719
flip-forward seat												
<b>8028P</b>	2170	2290	2391	2508	2699	2875	3051	3205	3396	3576	3820	4165
with arm patches												
<b>8028PF</b>	2345	2489	2611	2751	2979	3191	3403	3587	3817	4033	4325	4739
with arm patches + flip-forward seat												
<b>8028PH</b>	2200	2320	2421	2538	2729	2905	3081	3235	3426	3606	3850	4195
with arm + head patches												
<b>8028PHF</b>	2375	2519	2641	2781	3009	3221	3433	3617	3847	4063	4355	4769
with arm + head patches + flip-forward seat												

	OVERALL DIMENSIONS			SEAT DIMENSIONS			BACK DIMENSIONS	
	W	D	H	W	D	H	W	H
IN	29	31.5	44.5	21.5	20	17	21	27.5
MM	737	800	1130	546	508	432	533	699

**RTA 00** 1 per carton

DESCRIPTION	FEATURES	MODEL #	STANDARD TEXTILE GRADES																																
			1	2	3	4	5	6	7	8	9	10	11	12																					
  <b>High Back Lounge Chair w/Four-Legged Wood Base</b> COM: 3.75 YD   3.43 M Unit weight: 46.5 LB   21.1 KG Carton weight: 56.5 LB   25.63 KG Carton volume: 28.25 FT³   0.79 MT³	sealed seam upcharges <table border="1"> <thead> <tr> <th></th> <th>(S2)</th> <th>(SE)</th> </tr> </thead> <tbody> <tr> <td><b>8029</b></td> <td>Add \$76</td> <td>Add \$29</td> </tr> <tr> <td><b>8029F</b></td> <td>Add \$76</td> <td>Add \$44</td> </tr> <tr> <td><b>8029P</b></td> <td>Add \$93</td> <td>Add \$29</td> </tr> <tr> <td><b>8029PF</b></td> <td>Add \$93</td> <td>Add \$44</td> </tr> <tr> <td><b>8029PH</b></td> <td>Add \$112</td> <td>Add \$29</td> </tr> <tr> <td><b>8029PHF</b></td> <td>Add \$112</td> <td>Add \$44</td> </tr> </tbody> </table>		(S2)	(SE)	<b>8029</b>	Add \$76	Add \$29	<b>8029F</b>	Add \$76	Add \$44	<b>8029P</b>	Add \$93	Add \$29	<b>8029PF</b>	Add \$93	Add \$44	<b>8029PH</b>	Add \$112	Add \$29	<b>8029PHF</b>	Add \$112	Add \$44	<b>8029</b>	2650	2770	2871	2988	3179	3355	3531	3685	3876	4056	4300	4645
			(S2)	(SE)																															
		<b>8029</b>	Add \$76	Add \$29																															
		<b>8029F</b>	Add \$76	Add \$44																															
		<b>8029P</b>	Add \$93	Add \$29																															
		<b>8029PF</b>	Add \$93	Add \$44																															
		<b>8029PH</b>	Add \$112	Add \$29																															
		<b>8029PHF</b>	Add \$112	Add \$44																															
		<b>8029F</b>	2825	2969	3091	3231	3459	3671	3883	4067	4297	4513	4805	5219																					
		flip-forward seat																																	
<b>8029P</b>	2670	2790	2891	3008	3199	3375	3551	3705	3896	4076	4320	4665																							
with arm patches																																			
<b>8029PF</b>	2845	2989	3111	3251	3479	3691	3903	4087	4317	4533	4825	5239																							
with arm patches + flip-forward seat																																			
<b>8029PH</b>	2700	2820	2921	3038	3229	3405	3581	3735	3926	4106	4350	4695																							
with arm + head patches																																			
<b>8029PHF</b>	2875	3019	3141	3281	3509	3721	3933	4117	4347	4563	4855	5269																							
with arm + head patches + flip-forward seat																																			
			<b>OVERALL DIMENSIONS</b>			<b>SEAT DIMENSIONS</b>			<b>BACK DIMENSIONS</b>																										
			<b>W</b>	<b>D</b>	<b>H</b>	<b>W</b>	<b>D</b>	<b>H</b>	<b>W</b>	<b>H</b>																									
			IN 29	31.5	44.5	21.5	20	17	21	27.5																									
			MM 737	800	1130	546	508	432	533	699																									
			<b>RTA 00</b>		1 per carton																														

DESCRIPTION	FEATURES	MODEL #	STANDARD TEXTILE GRADES																																
			1	2	3	4	5	6	7	8	9	10	11	12																					
  <b>High Back Lounge Chair w/Wood Swivel Base</b> COM: 3.75 YD   3.43 M Unit weight: 47 LB   21.4 KG Carton weight: 57 LB   25.85 KG Carton volume: 28.25 FT³   0.79 MT³	sealed seam upcharges <table border="1"> <thead> <tr> <th></th> <th>(S2)</th> <th>(SE)</th> </tr> </thead> <tbody> <tr> <td><b>8037</b></td> <td>Add \$76</td> <td>Add \$29</td> </tr> <tr> <td><b>8037F</b></td> <td>Add \$76</td> <td>Add \$44</td> </tr> <tr> <td><b>8037P</b></td> <td>Add \$93</td> <td>Add \$29</td> </tr> <tr> <td><b>8037PF</b></td> <td>Add \$93</td> <td>Add \$44</td> </tr> <tr> <td><b>8037PH</b></td> <td>Add \$112</td> <td>Add \$29</td> </tr> <tr> <td><b>8037PHF</b></td> <td>Add \$112</td> <td>Add \$44</td> </tr> </tbody> </table>		(S2)	(SE)	<b>8037</b>	Add \$76	Add \$29	<b>8037F</b>	Add \$76	Add \$44	<b>8037P</b>	Add \$93	Add \$29	<b>8037PF</b>	Add \$93	Add \$44	<b>8037PH</b>	Add \$112	Add \$29	<b>8037PHF</b>	Add \$112	Add \$44	<b>8037</b>	2650	2770	2871	2988	3179	3355	3531	3685	3876	4056	4300	4645
			(S2)	(SE)																															
		<b>8037</b>	Add \$76	Add \$29																															
		<b>8037F</b>	Add \$76	Add \$44																															
		<b>8037P</b>	Add \$93	Add \$29																															
		<b>8037PF</b>	Add \$93	Add \$44																															
		<b>8037PH</b>	Add \$112	Add \$29																															
		<b>8037PHF</b>	Add \$112	Add \$44																															
		<b>8037F</b>	2825	2969	3091	3231	3459	3671	3883	4067	4297	4513	4805	5219																					
		flip-forward seat																																	
<b>8037P</b>	2670	2790	2891	3008	3199	3375	3551	3705	3896	4076	4320	4665																							
with arm patches																																			
<b>8037PF</b>	2845	2989	3111	3251	3479	3691	3903	4087	4317	4533	4825	5239																							
with arm patches + flip-forward seat																																			
<b>8037PH</b>	2700	2820	2921	3038	3229	3405	3581	3735	3926	4106	4350	4695																							
with arm + head patches																																			
<b>8037PHF</b>	2875	3019	3141	3281	3509	3721	3933	4117	4347	4563	4855	5269																							
with arm + head patches + flip-forward seat																																			
			<b>OVERALL DIMENSIONS</b>			<b>SEAT DIMENSIONS</b>			<b>BACK DIMENSIONS</b>																										
			<b>W</b>	<b>D</b>	<b>H</b>	<b>W</b>	<b>D</b>	<b>H</b>	<b>W</b>	<b>H</b>																									
			IN 29	31.5	44.5	21.5	20	17	21	27.5																									
			MM 737	800	1130	546	508	432	533	699																									
			<b>RTA 00</b>		1 per carton																														

DESCRIPTION	FEATURES	MODEL #	STANDARD TEXTILE GRADES																																
			1	2	3	4	5	6	7	8	9	10	11	12																					
  <b>High Back Lounge Chair w/Chrome Swivel Base</b> COM: 3.75 YD   3.43 M Unit weight: 53 LB   24.1 KG Carton weight: 63 LB   28.58 KG Carton volume: 28.25 FT³   0.79 MT³	sealed seam upcharges <table border="1"> <thead> <tr> <th></th> <th>(S2)</th> <th>(SE)</th> </tr> </thead> <tbody> <tr> <td><b>8038</b></td> <td>Add \$76</td> <td>Add \$29</td> </tr> <tr> <td><b>8038F</b></td> <td>Add \$76</td> <td>Add \$44</td> </tr> <tr> <td><b>8038P</b></td> <td>Add \$93</td> <td>Add \$29</td> </tr> <tr> <td><b>8038PF</b></td> <td>Add \$93</td> <td>Add \$44</td> </tr> <tr> <td><b>8038PH</b></td> <td>Add \$112</td> <td>Add \$29</td> </tr> <tr> <td><b>8038PHF</b></td> <td>Add \$112</td> <td>Add \$44</td> </tr> </tbody> </table>		(S2)	(SE)	<b>8038</b>	Add \$76	Add \$29	<b>8038F</b>	Add \$76	Add \$44	<b>8038P</b>	Add \$93	Add \$29	<b>8038PF</b>	Add \$93	Add \$44	<b>8038PH</b>	Add \$112	Add \$29	<b>8038PHF</b>	Add \$112	Add \$44	<b>8038</b>	2666	2786	2887	3004	3195	3371	3547	3701	3892	4072	4316	4661
			(S2)	(SE)																															
		<b>8038</b>	Add \$76	Add \$29																															
		<b>8038F</b>	Add \$76	Add \$44																															
		<b>8038P</b>	Add \$93	Add \$29																															
		<b>8038PF</b>	Add \$93	Add \$44																															
		<b>8038PH</b>	Add \$112	Add \$29																															
		<b>8038PHF</b>	Add \$112	Add \$44																															
		<b>8038F</b>	2841	2985	3107	3247	3475	3687	3899	4083	4313	4529	4821	5235																					
		flip-forward seat																																	
<b>8038P</b>	2686	2806	2907	3024	3215	3391	3567	3721	3912	4092	4336	4681																							
with arm patches																																			
<b>8038PF</b>	2861	3005	3127	3267	3495	3707	3919	4103	4333	4549	4841	5255																							
with arm patches + flip-forward seat																																			
<b>8038PH</b>	2716	2836	2937	3054	3245	3421	3597	3751	3942	4122	4366	4711																							
with arm + head patches																																			
<b>8038PHF</b>	2891	3035	3157	3297	3525	3737	3949	4133	4363	4579	4871	5285																							
with arm + head patches + flip-forward seat																																			
			<b>OVERALL DIMENSIONS</b>			<b>SEAT DIMENSIONS</b>			<b>BACK DIMENSIONS</b>																										
			<b>W</b>	<b>D</b>	<b>H</b>	<b>W</b>	<b>D</b>	<b>H</b>	<b>W</b>	<b>H</b>																									
			IN 29	31.5	44.5	21.5	20	17	21	27.5																									
			MM 737	800	1130	546	508	432	533	699																									
			<b>RTA 00</b>		1 per carton																														

DESCRIPTION FEATURES MODEL # STANDARD TEXTILE GRADES



**Counter Stool w/Sled Base**  
 COM: 1.5 YD | 1.37 M  
 Unit weight: 23.5 LB | 10.7 KG  
 Carton weight: 30 LB | 13.61 KG  
 Carton volume: 9 FT³ | 0.25 MT³

sealed seam upcharges	(S2)	(SE)
<b>8051</b>	Add \$26	Add \$17

	1	2	3	4	5	6	7	8	9	10	11	12
<b>8051</b>	1135	1183	1224	1270	1347	1417	1488	1549	1626	1698	1795	1933

OVERALL DIMENSIONS			SEAT DIMENSIONS			BACK DIMENSIONS		
W	D	H	W	D	H	W	H	

IN	19.25	19	34.5	15.5	15.75	24.5	12.5	10
MM	489	483	876	394	400	622	318	254

**RTA 00** 1 per carton



**Counter Stool w/Four-Legged Wood Base**  
 COM: 1.5 YD | 1.37 M  
 Unit weight: 22 LB | 10 KG  
 Carton weight: 28 LB | 12.7 KG  
 Carton volume: 9 FT³ | 0.25 MT³

sealed seam upcharges	(S2)	(SE)
<b>8052</b>	Add \$26	Add \$17

	1	2	3	4	5	6	7	8	9	10	11	12
<b>8052</b>	1685	1733	1774	1820	1897	1967	2038	2099	2176	2248	2345	2483

OVERALL DIMENSIONS			SEAT DIMENSIONS			BACK DIMENSIONS		
W	D	H	W	D	H	W	H	

IN	19.25	19	34.5	15.5	15.75	24.5	12.5	10
MM	489	483	876	394	400	622	318	254

**RTA 00** 1 per carton



**Counter Stool w/Chrome Swivel Base**  
 COM: 1.5 YD | 1.37 M  
 Unit weight: 36.5 LB | 16.6 KG  
 Carton weight: 43 LB | 19.5 KG  
 Carton volume: 11.5 FT³ | 0.32 MT³

sealed seam upcharges	(S2)	(SE)
<b>8053</b>	Add \$26	Add \$17

	1	2	3	4	5	6	7	8	9	10	11	12
<b>8053</b>	2185	2233	2274	2320	2397	2467	2538	2599	2676	2748	2845	2983

OVERALL DIMENSIONS			SEAT DIMENSIONS			BACK DIMENSIONS		
W	D	H	W	D	H	W	H	

IN	19.25	20	34.5	15.5	15.75	24.5	12.5	10
MM	489	508	876	394	400	622	318	254

**RTA 00** 1 per carton



**Bar Stool w/Sled Base**  
 COM: 1.5 YD | 1.37 M  
 Unit weight: 25 LB | 11.4 KG  
 Carton weight: 33 LB | 14.97 KG  
 Carton volume: 11 FT³ | 0.31 MT³

sealed seam upcharges	(S2)	(SE)
<b>8054</b>	Add \$26	Add \$17

	1	2	3	4	5	6	7	8	9	10	11	12
<b>8054</b>	1210	1258	1299	1345	1422	1492	1563	1624	1701	1773	1870	2008

OVERALL DIMENSIONS			SEAT DIMENSIONS			BACK DIMENSIONS		
W	D	H	W	D	H	W	H	

IN	19.25	20	40	15.5	15.75	29.5	12.5	10
MM	489	508	1016	394	400	749	318	254

**RTA 00** 1 per carton



**Bar Stool w/Four-Legged Wood Base**  
 COM: 1.5 YD | 1.37 M  
 Unit weight: 22.5 LB | 10.2 KG  
 Carton weight: 30 LB | 13.61 KG  
 Carton volume: 11 FT³ | 0.31 MT³

sealed seam upcharges	(S2)	(SE)
<b>8055</b>	Add \$26	Add \$17

	1	2	3	4	5	6	7	8	9	10	11	12
<b>8055</b>	1760	1808	1849	1895	1972	2042	2113	2174	2251	2323	2420	2558

OVERALL DIMENSIONS			SEAT DIMENSIONS			BACK DIMENSIONS		
W	D	H	W	D	H	W	H	

IN	19.25	20	40	15.5	15.75	29.5	12.5	10
MM	489	508	1016	394	400	749	318	254

**RTA 00** 1 per carton



**Bar Stool w/Chrome Swivel Base**  
 COM: 1.5 YD | 1.37 M  
 Unit weight: 38 LB | 17.3 KG  
 Carton weight: 45.5 LB | 20.64 KG  
 Carton volume: 13.25 FT³ | 0.37 MT³

sealed seam upcharges	(S2)	(SE)
<b>8056</b>	Add \$26	Add \$17

	1	2	3	4	5	6	7	8	9	10	11	12
<b>8056</b>	2260	2308	2349	2395	2472	2542	2613	2674	2751	2823	2920	3058

OVERALL DIMENSIONS			SEAT DIMENSIONS			BACK DIMENSIONS		
W	D	H	W	D	H	W	H	

IN	19.25	20	40	15.5	15.75	29.5	12.5	10
MM	489	508	1016	394	400	749	318	254

**RTA 00** 1 per carton



DRIFT TABLES



model 8041R2616C



model 8042SQ2816I



model 8042SQ2816WSF

Drift Seating



For Drift seating, please see page 244.

DRIFT TABLE FINISHES COORDINATION CHART			
TFL/HPL TOP FINISH		COORDINATING WOOD BASE FINISH	
ACJ	Absolute Acajou	AAM	Absolute
		MWM	Medium Walnut
ASN	Asian Night	ASM	Night
AWC	Avant Cherry	ACM	Cherry
AWH	Avant Honey	AHM	Honey
BLK	Black	BKM	Black
CMB	Clear Maple	AVM	Maple
DES	Dark Espresso	ECM	Espresso Cafe
DWT	Designer White	WHM	White
NBL	Noce Biondo	NBM	Noce Biondo
NEL	Noce Leggero	NEM	Noce Leggero
NGL	Noce Grigio	NGM	Noce Grigio
NML	Noce Medio	NMM	Noce Medio
QTM	Quartered Mahogany	TMM	Mahogany
WCR	Winter Cherry	WCM	Winter Cherry
WHC	White Chocolate	WTM	WC Cream
WHE	Walnut Heights	NLW	Natural Walnut
TFL/HPL TOP FINISHES WITH NO COORDINATING WOOD BASE FINISHES		WOOD BASE FINISHES WITH NO COORDINATING HPL TOP FINISHES	
BRC**	Brushed Cobalt	EOM	English Oak
FAS**	Fashionista	NLW	Natural Walnut
FCL**	First Class	SKM	Shaker Cherry
SBY**	Sheer Beauty		
SOG**	Storm Grey		

\*\*Chrome base models are available for all TFL/HPL top finishes

STANDARD FEATURES

- Tables are available in three shapes, multiple sizes, two edge styles and three top materials. All offer three base options: sled, four-legged wood and a polished chrome base.
- Table bases are fixed and do not swivel.
- Sled bases are available in two heights.
- Wood bases are made from beechwood and are available in all standard wood finishes.
- Sled bases are standard in paint and optionally available in Chrome. See upcharges.
- Chrome bases are available in polished chrome only.
- Table tops are available in either laminate or solid surface.
- Laminate flat edge tops are available in either a 1" thick thermally fused laminate (TFL) with 2mm edgeband or 1-1/16" thick high pressure laminate (HPL) with 2mm edgeband (see upcharge).
- Laminate knife edge tops are only available in 1-3/16" thick high pressure laminate (HPL) with 2.5mm edgeband.
- Solid surface tops are 1.25" thick, available with flat or knife edge tops.
- Polished chrome bases are equipped with White non-marking polycarbonate glides that are suitable for most hard and carpeted floor surfaces.
- Tables are shipped fully assembled.

Please specify based on the following criteria:

- **Model number** (suffix determines edge detail)
  - sled base models
    - \_\_\_\_\_ **I** laminate flat edge
    - \_\_\_\_\_ **K** laminate knife edge
    - \_\_\_\_\_ **SF** solid surface flat edge
    - \_\_\_\_\_ **SK** solid surface knife edge
  - polished chrome base models
    - \_\_\_\_\_ **C** laminate flat edge
    - \_\_\_\_\_ **CK** laminate knife edge
    - \_\_\_\_\_ **CSF** solid surface flat edge
    - \_\_\_\_\_ **CSK** solid surface knife edge
  - four-legged wood base models
    - \_\_\_\_\_ **W** laminate flat edge
    - \_\_\_\_\_ **WK** laminate knife edge
    - \_\_\_\_\_ **WSF** solid surface flat edge
    - \_\_\_\_\_ **WSK** solid surface knife edge

• Top details

LAMINATE

**Surface type** (laminate flat edge tables only)  
**(TFL)** Thermally fused laminate  
**(HPL)** High pressure laminate

**Top finish** (see model for HPL upcharges)

- |                              |                                 |
|------------------------------|---------------------------------|
| <b>(ACJ)</b> Absolute Acajou | <b>(FCL)</b> First Class        |
| <b>(ASN)</b> Asian Night     | <b>(NBL)</b> Noce Biondo        |
| <b>(AWC)</b> Avant Cherry    | <b>(NGL)</b> Noce Grigio        |
| <b>(AWH)</b> Avant Honey     | <b>(NEL)</b> Noce Leggero       |
| <b>(BLK)</b> Black           | <b>(NML)</b> Noce Medio         |
| <b>(BZD)</b> Blizzard        | <b>(OTM)</b> Quartered Mahogany |
| <b>(BRC)</b> Brushed Cobalt  | <b>(SBY)</b> Sheer Beauty       |
| <b>(CMB)</b> Clear Maple     | <b>(SDT)</b> Stonedust          |
| <b>(CGY)</b> Custom Grey     | <b>(SOG)</b> Storm Grey         |
| <b>(DES)</b> Dark Espresso   | <b>(WHE)</b> Walnut Heights     |
| <b>(DWT)</b> Designer White  | <b>(WHC)</b> White Chocolate    |
| <b>(FAS)</b> Fashionista     | <b>(WCR)</b> Winter Cherry      |

SOLID SURFACE

**Top finish** (see model for grade 2 upcharges)

- (AWH)** Designer White - grade 1
- (SBT)** Beige Tempest - grade 2
- (SBX)** Black Onyx Mirage - grade 2
- (SFW)** Frosty White Mirage - grade 2
- (SHS)** Hot Stone - grade 2
- (SMG)** Milk Glass Spectra - grade 2
- (SNM)** Northern Melange - grade 2

• Base finish

SLED BASE

For leg frame finish options, please see page 360. Upcharges apply for the following plated finish:

**(CHM)** Chrome. Add \$33.

**WOOD BASE** (see coordination chart)

- |                            |                             |
|----------------------------|-----------------------------|
| <b>(AAM)</b> Absolute      | <b>(NLW)</b> Natural Walnut |
| <b>(BKM)</b> Black         | <b>(ASM)</b> Night          |
| <b>(ACM)</b> Cherry        | <b>(NBM)</b> Noce Biondo    |
| <b>(EOM)</b> English Oak   | <b>(NGM)</b> Noce Grigio    |
| <b>(ECM)</b> Espresso Cafe | <b>(NEM)</b> Noce Leggero   |
| <b>(TFM)</b> Fruitwood     | <b>(NMM)</b> Noce Medio     |
| <b>(HGM)</b> Gray          | <b>(SKM)</b> Shaker Cherry  |
| <b>(AHM)</b> Honey         | <b>(TWM)</b> Walnut         |
| <b>(TMM)</b> Mahogany      | <b>(WTM)</b> WC Cream       |
| <b>(AVM)</b> Maple         | <b>(WHM)</b> White          |
| <b>(MWM)</b> Medium Walnut | <b>(WCM)</b> Winter Cherry  |

POLISHED CHROME BASE

**(CHM)** Chrome.

• Glide type

SLED BASE GLIDES

- (CG)** clear polycarbonate glides for most surfaces (standard)
- (XG)** no glides (carpeted surface)
- (SG)** steel cushioned glides for carpeted surfaces. Add \$19.
- (RG)** rubber glides for most hard floor surfaces. Add \$19.
- (FG)** felt glides for most hard floor surfaces. Add \$19.

WOOD BASE GLIDES

- (NM)** White non-marking nylon for most surfaces (standard)
- (SG)** steel cushioned glides for carpeted surfaces. Add \$17.
- (RG)** non-slip rubber glides for most hard floor surfaces. Add \$22.
- (FG)** felt glides for most hard floor surfaces. Add \$22.

Please note that these finishes are coordinating and not exact matches. Please reach out to your Global Sales representative for physical samples of finishes prior to ordering.

DESCRIPTION	MODEL #	DIMENSIONS	WT/LB.	CUBIC FT.	LIST PRICE	HP ADD	GRADE 2+
-------------	---------	------------	--------	-----------	------------	--------	----------



Round Table w/Polished Chrome Four Star Base

W x D x H							
<b>Laminate Flat Edge</b>							
8041R2616C	26 x 26 x 16	30	10.75	\$865	\$91	N/A	
8041R3016C	30 x 30 x 16	34	13	\$898	\$108	N/A	
<b>Laminate Knife Edge</b>							
8041R2616CK	26 x 26 x 16	30	10.75	\$1504	N/A	N/A	
8041R3016CK	30 x 30 x 16	34	13	\$1697	N/A	N/A	
<b>Solid Surface Flat Edge</b>							
8041R2616CSF	26 x 26 x 16	43	10.75	\$2789	N/A	\$171	
8041R3016CSF	30 x 30 x 16	51.5	13	\$2982	N/A	\$235	
<b>Solid Surface Knife Edge</b>							
8041R2616CSK	26 x 26 x 16	43	10.75	\$2847	N/A	\$183	
8041R3016CSK	30 x 30 x 16	51.5	13	\$3070	N/A	\$253	

Finished height will vary depending on material top. Shipped fully assembled in 1 carton.



Round Table w/Sled Base

<b>Laminate Flat Edge</b>							
8041R2616I	26 x 26 x 16	28	10.25	\$489	\$91	N/A	
8041R3016I	30 x 30 x 16	33	13	\$522	\$108	N/A	
8041R2120I	21 x 21 x 20	23	8.75	\$487	\$89	N/A	
<b>Laminate Knife Edge</b>							
8041R2616IK	26 x 26 x 16	28	10.25	\$1128	N/A	N/A	
8041R3016IK	30 x 30 x 16	33	13	\$1321	N/A	N/A	
8041R2120IK	21 x 21 x 20	23	8.75	\$941	N/A	N/A	
<b>Solid Surface Flat Edge</b>							
8041R2616ISF	26 x 26 x 16	41	10.25	\$2413	N/A	\$171	
8041R3016ISF	30 x 30 x 16	50	13	\$2606	N/A	\$235	
8041R2120ISF	21 x 21 x 20	31.5	8.75	\$2263	N/A	\$118	
<b>Solid Surface Knife Edge</b>							
8041R2616ISK	26 x 26 x 16	41	10.25	\$2471	N/A	\$183	
8041R3016ISK	30 x 30 x 16	50	13	\$2694	N/A	\$253	
8041R2120ISK	21 x 21 x 20	31.5	8.75	\$2369	N/A	\$123	

Finished height will vary depending on material top. Shipped fully assembled in 1 carton.



Round Table w/Wood Four Star Base

<b>Laminate Flat Edge</b>							
8041R2616W	26 x 26 x 16	24	10.75	\$975	\$91	N/A	
8041R3016W	30 x 30 x 16	29	13	\$1008	\$108	N/A	
<b>Laminate Knife Edge</b>							
8041R2616WK	26 x 26 x 16	24	10.75	\$1614	N/A	N/A	
8041R3016WK	30 x 30 x 16	29	13	\$1807	N/A	N/A	
<b>Solid Surface Flat Edge</b>							
8041R2616WSF	26 x 26 x 16	37.5	10.75	\$2899	N/A	\$171	
8041R3016WSF	30 x 30 x 16	46.5	13	\$3092	N/A	\$235	
<b>Solid Surface Knife Edge</b>							
8041R2616WSK	26 x 26 x 16	37.5	10.75	\$2957	N/A	\$183	
8041R3016WSK	30 x 30 x 16	46.5	13	\$3180	N/A	\$253	

Finished height will vary depending on material top. Shipped fully assembled in 1 carton.

DESCRIPTION	MODEL #	DIMENSIONS	WT/LB.	CUBIC FT.	LIST PRICE	HP ADD	GRADE 2+
-------------	---------	------------	--------	-----------	------------	--------	----------



Square Table w/Polished Chrome Four Star Base

		W x D x H					
<b>Laminate Flat Edge</b>							
8042SQ2216C		22.75 x 22.75 x 16	29	7.75	\$865	\$91	N/A
8042SQ2816C		28.5 x 28.5 x 16	36	11.5	\$898	\$108	N/A
<b>Laminate Knife Edge</b>							
8042SQ2216CK		22.75 x 22.75 x 16	29	7.75	\$1300	N/A	N/A
8042SQ2816CK		28.5 x 28.5 x 16	36	11.5	\$1493	N/A	N/A
<b>Solid Surface Flat Edge</b>							
8042SQ2216CSF		22.75 x 22.75 x 16	34	7.75	\$2488	N/A	\$147
8042SQ2816CSF		28.5 x 28.5 x 16	48.5	11.5	\$2832	N/A	\$235
<b>Solid Surface Knife Edge</b>							
8042SQ2216CSK		22.75 x 22.75 x 16	34	7.75	\$2847	N/A	\$176
8042SQ2816CSK		28.5 x 28.5 x 16	48.5	11.5	\$3421	N/A	\$265

Finished height will vary depending on material top. Shipped fully assembled in 1 carton.



Square Table w/Sled Base

<b>Laminate Flat Edge</b>							
8042SQ2216I		22.5 x 22.5 x 16	27	8	\$489	\$91	N/A
8042SQ2816I		28.5 x 28.5 x 16	35	11.75	\$522	\$108	N/A
8042SQ1920I		19.5 x 19.5 x 20	23.5	7.75	\$487	\$89	N/A
<b>Laminate Knife Edge</b>							
8042SQ2216IK		22.5 x 22.5 x 16	27	8	\$924	N/A	N/A
8042SQ2816IK		28.5 x 28.5 x 16	35	11.75	\$1117	N/A	N/A
8042SQ1920IK		19.5 x 19.5 x 20	23.5	7.75	\$881	N/A	N/A
<b>Solid Surface Flat Edge</b>							
8042SQ2216ISF		22.5 x 22.5 x 16	32.5	8	\$2112	N/A	\$147
8042SQ2816ISF		28.5 x 28.5 x 16	53.5	11.75	\$2456	N/A	\$235
8042SQ1920ISF		19.5 x 19.5 x 20	31.5	7.75	\$2017	N/A	\$123
<b>Solid Surface Knife Edge</b>							
8042SQ2216ISK		22.5 x 22.5 x 16	32.5	8	\$2471	N/A	\$176
8042SQ2816ISK		28.5 x 28.5 x 16	53.5	11.75	\$3045	N/A	\$265
8042SQ1920ISK		19.5 x 19.5 x 20	31.5	7.75	\$2369	N/A	\$130

Finished height will vary depending on material top. Shipped fully assembled in 1 carton.



Square Table w/Wood Four Star Base

<b>Laminate Flat Edge</b>							
8042SQ2216W		22.75 x 22.75 x 16	23	7.75	\$975	\$91	N/A
8042SQ2816W		28.5 x 28.5 x 16	30	11.5	\$1008	\$108	N/A
<b>Laminate Knife Edge</b>							
8042SQ2216WK		22.75 x 22.75 x 16	23	7.75	\$1410	N/A	N/A
8042SQ2816WK		28.5 x 28.5 x 16	30	11.5	\$1603	N/A	N/A
<b>Solid Surface Flat Edge</b>							
8042SQ2216WSF		22.75 x 22.75 x 16	29	7.75	\$2598	N/A	\$147
8042SQ2816WSF		28.5 x 28.5 x 16	50	11.5	\$2942	N/A	\$235
<b>Solid Surface Knife Edge</b>							
8042SQ2216WSK		22.75 x 22.75 x 16	29	7.75	\$2957	N/A	\$176
8042SQ2816WSK		28.5 x 28.5 x 16	50	11.5	\$3531	N/A	\$265

Finished height will vary depending on material top. Shipped fully assembled in 1 carton.

DESCRIPTION	MODEL #	DIMENSIONS	WT/LB.	CUBIC FT.	LIST PRICE	HP ADD	GRADE 2+
-------------	---------	------------	--------	-----------	------------	--------	----------



Oval Table w/Polished Chrome Four Star Base

		W x D x H					
<b>Laminate Flat Edge</b>							
80430V2616C	26 x 22 x 16	30	9.25	\$865	\$91	N/A	
80430V3116C	31 x 26 x 16	34	11.75	\$898	\$108	N/A	
<b>Laminate Knife Edge</b>							
80430V2616CK	26 x 22 x 16	30	9.25	\$1504	N/A	N/A	
80430V3116CK	31 x 26 x 16	34	11.75	\$1697	N/A	N/A	
<b>Solid Surface Flat Edge</b>							
80430V2616CSF	26 x 22 x 16	41.5	9.25	\$2789	N/A	\$171	
80430V3116CSF	31 x 26 x 16	51.5	11.75	\$2982	N/A	\$235	
<b>Solid Surface Knife Edge</b>							
80430V3116CSK	31 x 26 x 16	51.5	11.75	\$3070	N/A	\$253	
80430V3116CSK	31 x 26 x 16	51.5	11.75	\$3070	N/A	\$253	

Finished height will vary depending on material top. Shipped fully assembled in 1 carton.



Oval Table w/Sled Base

<b>Laminate Flat Edge</b>							
80430V2616I	22 x 26 x 16	28.5	8.75	\$489	\$91	N/A	
80430V3116I	31 x 26 x 16	36	11.75	\$522	\$108	N/A	
80430V2220I	18 x 22 x 20	28	10.75	\$487	\$89	N/A	
<b>Laminate Knife Edge</b>							
80430V2616IK	22 x 26 x 16	28.5	8.75	\$1128	N/A	N/A	
80430V3116IK	31 x 26 x 16	36	11.75	\$1321	N/A	N/A	
80430V2220IK	18 x 22 x 20	28	10.75	\$941	N/A	N/A	
<b>Solid Surface Flat Edge</b>							
80430V2616ISF	22 x 26 x 16	34	8.75	\$2413	N/A	\$171	
80430V3116ISF	31 x 26 x 16	50	11.75	\$2606	N/A	\$235	
80430V2220ISF	18 x 22 x 20	32	10.75	\$2263	N/A	\$118	
<b>Solid Surface Knife Edge</b>							
80430V2616ISK	22 x 26 x 16	38	8.75	\$2471	N/A	\$183	
80430V3116ISK	31 x 26 x 16	50	11.75	\$2694	N/A	\$253	
80430V2220ISK	18 x 22 x 20	32	10.75	\$2369	N/A	\$123	

Finished height will vary depending on material top. Shipped fully assembled in 1 carton.



Oval Table w/Wood Four Star Base

<b>Laminate Flat Edge</b>							
80430V2616W	26 x 22 x 16	24	9.25	\$975	\$91	N/A	
80430V3116W	31 x 26 x 16	29	11.75	\$1008	\$108	N/A	
<b>Laminate Knife Edge</b>							
80430V2616WK	26 x 22 x 16	24	9.25	\$1614	N/A	N/A	
80430V3116WK	31 x 26 x 16	29	11.75	\$1807	N/A	N/A	
<b>Solid Surface Flat Edge</b>							
80430V2616WSF	26 x 22 x 16	36.5	9.25	\$2899	N/A	\$171	
80430V3116WSF	31 x 26 x 16	46.5	11.75	\$3092	N/A	\$235	
<b>Solid Surface Knife Edge</b>							
80430V3116WSK	31 x 26 x 16	46.5	11.75	\$3180	N/A	\$253	
80430V3116WSK	31 x 26 x 16	46.5	11.75	\$3180	N/A	\$253	

Finished height will vary depending on material top. Shipped fully assembled in 1 carton.

JEO



model 8434



model 8433-4



Optional quilted stitch back (Q)





Optional five prong base with glides (G)

STANDARD FEATURES

- JEO is a contemporary, retro- inspired series with versatility for a variety of workplace applications.
- The tailored box styling functions well in lounge, conferencing, collaboration and side/guest environments.
- Three seating models: a swivel tilter with a five prong caster base, a swivel self-centering return with a stationary round pedestal base or a matching four legged arm chair.
- Model 8433-4 is standard with a five prong Black nylon base with carpet casters (CX).
- Model 8437 is standard with Black (TBL) four-legged frame.
- Upholstery options: fabric, vinyl, leather or a combination of two or more materials. Vinyl and leather models may feature stitch detail across the seat and/or back cushions, if applicable. The upholstery surfaces are seamed together with tailored double stitch detailing.

OPTIONAL FEATURES

- Chairs are available with an optional quilted stitch back, specify (Q). Add \$131.
- Model 8433-4 has an optional five prong aluminum base, specify (PA). Add \$175.
- Optional five prong aluminum base with hard glides, specify (HG). Add \$49.
- Optional soft casters are available on the five prong base, specify (ID). Add \$21.
- Model 8434 round pedestal base available in Chrome (CHM) or Brushed Chrome (BCH), please specify.
- Model 8437 has an optional Tungsten (TTU) or Designer White (TDW) four-legged frame. No upcharge. For Chrome (CHM) or Brushed Chrome (BCH) finish, add \$175.

DESCRIPTION	FEATURES	MODEL #	STANDARD TEXTILE GRADES												
			1	2	3	4	5	6	7	8	9	10	11	12	
 <p><b>Self-Centering Lounge Chair on Pedestal Base</b>                      COM: 2.75 YD   2.51 M                      Unit weight: 50 LB   22.7 KG                      Carton weight: 56 LB   25.4 KG                      Carton volume: 14.25 FT<sup>3</sup>   0.4 MT<sup>3</sup></p>	Ergonomic features: C	8434	1945	2033	2107	2193	2333	2462	2591	2704	2844	2976	3155	3408	
		<b>OVERALL DIMENSIONS</b>			<b>SEAT DIMENSIONS</b>			<b>BACK DIMENSIONS</b>							
		W	D	H	W	D	H	W	H						
		IN 26	25	30	20	19	16.5	20	15						
		MM 660	635	762	508	483	419	508	381						
			RTA 00		1 per carton										
 <p><b>Swivel Tilter Chair</b>                      COM: 2.75 YD   2.51 M                      Unit weight: 50 LB   22.7 KG                      Carton weight: 56 LB   25.4 KG                      Carton volume: 14.25 FT<sup>3</sup>   0.4 MT<sup>3</sup></p>	Ergonomic features: A, B, C, S	8433-4	1295	1383	1457	1543	1683	1812	1941	2054	2194	2326	2505	2758	
		<b>OVERALL DIMENSIONS</b>			<b>SEAT DIMENSIONS</b>			<b>BACK DIMENSIONS</b>							
		W	D	H	W	D	H	W	H						
		IN 26	25	30	20	19	16.5	20	15						
		MM 660	635	762	508	483	419	508	381						
			RTA 00		1 per carton										
 <p><b>Armchair</b>                      COM: 2.75 YD   2.51 M                      Unit weight: 50 LB   22.7 KG                      Carton weight: 57 LB   25.85 KG                      Carton volume: 15.75 FT<sup>3</sup>   0.44 MT<sup>3</sup></p>		8437	1432	1520	1594	1680	1820	1949	2078	2191	2331	2463	2642	2895	
	<b>OVERALL DIMENSIONS</b>			<b>SEAT DIMENSIONS</b>			<b>BACK DIMENSIONS</b>								
	W	D	H	W	D	H	W	H							
	IN 26	25	32.5	20	19	18	20	15							
	MM 660	635	826	508	483	457	508	381							
			RTA 00		1 per carton										

KATE



model 2811-4



model 2811-8







STANDARD FEATURES

- A contemporary, yet retro series featuring sculpted seat and back cushions.
- Fully upholstered closed arms offer a unique style and function in the workplace.
- Tilter and swivel are standard with a five prong, polished aluminum base with dual wheel carpet casters (**C10**).
- Armchair and ottoman are standard with steel frame and leg in Chrome finish. These bases are equipped with a Black polypropylene glide as standard.
- Upholstery options: fabric, vinyl or leather. Vinyl and leather models may feature stitch detail across the seat and/or back cushions, if applicable.

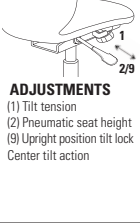
OPTIONAL FEATURES

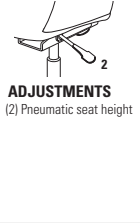
- There are no arm options for this series.
- An optional Black injection molded base (**BLK**) is available, please specify. No upcharge.
- (**C7**) glides are available, please specify. No upcharge.
- For hard surface flooring casters, please specify (**C10R**). Add \$20.
- For additional caster options, please refer to the Arm and Caster section (page 335). *Optional casters may be priced higher than the standard casters for your chair and the difference will be charged. Lower priced optional casters will not be credited.*



DESCRIPTION	FEATURES	MODEL #	STANDARD TEXTILE GRADES													
			1	2	3	4	5	6	7	8	9	10	11	12		
 <p><b>MB Tilter</b> COM: 3.75 YD   3.43 M Unit weight: 40 LB   18.2 KG Carton weight: 50 LB   22.68 KG Carton volume: 19.25 FT<sup>3</sup>   0.54 MT<sup>3</sup></p>	 <p><b>ADJUSTMENTS</b> (1) Tilt tension (2) Pneumatic seat height (9) Upright position tilt lock Center tilt action</p> <p>Ergonomic features: A, B, C, N</p>	<b>2811-4</b>	1187	1307	1408	1525	1716	1892	2068	2222	2413	2593	2837	3182		
		<b>OVERALL DIMENSIONS</b>			<b>SEAT DIMENSIONS</b>			<b>BACK DIMENSIONS</b>								
		<b>W</b>	<b>D</b>	<b>H</b>	<b>W</b>	<b>D</b>	<b>H</b>	<b>W</b>	<b>H</b>							
		IN 26	24.5	33	17.5	18	17.5-22.5	19	15.5							
		MM 660	622	838	445	457	445-572	483	394							
		<b>RTA 00</b>	1 per carton													
 <p><b>MB Swivel</b> COM: 3.75 YD   3.43 M Unit weight: 36 LB   16.4 KG Carton weight: 46 LB   20.87 KG Carton volume: 19.5 FT<sup>3</sup>   0.55 MT<sup>3</sup></p>	 <p><b>ADJUSTMENTS</b> (2) Pneumatic seat height</p> <p>Ergonomic features: C, N</p>	<b>2811-8</b>	1161	1281	1382	1499	1690	1866	2042	2196	2387	2567	2811	3156		
		<b>OVERALL DIMENSIONS</b>			<b>SEAT DIMENSIONS</b>			<b>BACK DIMENSIONS</b>								
		<b>W</b>	<b>D</b>	<b>H</b>	<b>W</b>	<b>D</b>	<b>H</b>	<b>W</b>	<b>H</b>							
		IN 26	24.5	33	17.5	18	17.5-22.5	19	15.5							
		MM 660	622	838	445	457	445-572	483	394							
		<b>RTA 00</b>	1 per carton													
 <p><b>MB Armchair</b> COM: 3.75 YD   3.43 M Unit weight: 36 LB   16.4 KG Carton weight: 46 LB   20.87 KG Carton volume: 19.5 FT<sup>3</sup>   0.55 MT<sup>3</sup></p>	<p>Ergonomic features: N</p>	<b>2813</b>	1128	1248	1349	1466	1657	1833	2009	2163	2354	2534	2778	3123		
		<b>OVERALL DIMENSIONS</b>			<b>SEAT DIMENSIONS</b>			<b>BACK DIMENSIONS</b>								
		<b>W</b>	<b>D</b>	<b>H</b>	<b>W</b>	<b>D</b>	<b>H</b>	<b>W</b>	<b>H</b>							
		IN 26.5	26.5	33.5	17.5	18	18	19	15.5							
		MM 673	673	851	445	457	457	483	394							
		<b>RTA 00</b>	1 per carton													
 <p><b>Ottoman</b> COM: 1.5 YD   1.37 M Unit weight: 17 LB   7.7 KG Carton weight: 22 LB   9.98 KG Carton volume: 6 FT<sup>3</sup>   0.16 MT<sup>3</sup></p>	<p>Ergonomic features: N</p>	<b>2814</b>	740	788	829	875	952	1022	1093	1154	1231	1303	1400	1538		
		<b>OVERALL DIMENSIONS</b>			<b>SEAT DIMENSIONS</b>			<b>BACK DIMENSIONS</b>								
		<b>W</b>	<b>D</b>	<b>H</b>	<b>W</b>	<b>D</b>	<b>H</b>	<b>W</b>	<b>H</b>							
		IN 23.5	18.75	17.75	-	-	17.75	-	-							
		MM 597	476	451	-	-	451	-	-							
		<b>RTA 00</b>		1 per carton												

## ML









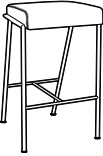

model ML2630

### STANDARD FEATURES

- Modern seating with a distinctive retro design featuring a steel tube frame, legs and arms.
- Fully upholstered continuous seat and back cushions.
- Standard with non-marking Black glides.
- Upholstery options: fabric, vinyl or leather. Vinyl and leather models may feature stitch detail across the seat and/or back cushions, if applicable.

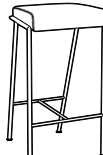
### OPTIONAL FEATURES

- Available in five frame finish options: Chrome (**CHM**), Brushed Chrome (**BCH**), Black (**TBL**), Designer White (**TDW**) or Tungsten (**TTU**), please specify. No upcharge.

DESCRIPTION	FEATURES	MODEL #	STANDARD TEXTILE GRADES											
			1	2	3	4	5	6	7	8	9	10	11	12
 <p><b>Counter Height Stool - 24" Seat Height</b>                      COM: 0.5 YD   0.46 M                      Unit weight: 17 LB   7.7 KG                      Carton weight: 24 LB   10.89 KG                      Carton volume: 9.5 FT³   0.26 MT³</p>		<b>ML171724</b>	1483	1499	1513	1528	1554	1577	1601	1621	1647	1671	1703	1749
			<b>OVERALL DIMENSIONS</b>			<b>SEAT DIMENSIONS</b>			<b>BACK DIMENSIONS</b>					
			<b>W</b>	<b>D</b>	<b>H</b>	<b>W</b>	<b>D</b>	<b>H</b>	<b>W</b>	<b>H</b>				
			IN 18	19	24	-	-	-	-	-				
		MM 457	483	610	-	-	-	-	-					
		<b>RTA 00</b>		1 per carton										
 <p><b>Bar Height Stool - 30" Seat Height</b>                      COM: 0.5 YD   0.46 M                      Unit weight: 18 LB   8.2 KG                      Carton weight: 26 LB   11.79 KG                      Carton volume: 13.75 FT³   0.38 MT³</p>		<b>ML171730</b>	1517	1533	1547	1562	1588	1611	1635	1655	1681	1705	1737	1783
			<b>OVERALL DIMENSIONS</b>			<b>SEAT DIMENSIONS</b>			<b>BACK DIMENSIONS</b>					
			<b>W</b>	<b>D</b>	<b>H</b>	<b>W</b>	<b>D</b>	<b>H</b>	<b>W</b>	<b>H</b>				
			IN 18	20.5	30	-	-	-	-	-				
		MM 457	521	762	-	-	-	-	-					
		<b>RTA 00</b>		1 per carton										
 <p><b>Bar Height Stool - 33" Seat Height</b>                      COM: 0.5 YD   0.46 M                      Unit weight: 19 LB   8.6 KG                      Carton weight: 27 LB   12.25 KG                      Carton volume: 13.75 FT³   0.38 MT³</p>		<b>ML171733</b>	1550	1566	1580	1595	1621	1644	1668	1688	1714	1738	1770	1816
			<b>OVERALL DIMENSIONS</b>			<b>SEAT DIMENSIONS</b>			<b>BACK DIMENSIONS</b>					
			<b>W</b>	<b>D</b>	<b>H</b>	<b>W</b>	<b>D</b>	<b>H</b>	<b>W</b>	<b>H</b>				
			IN 18	21.5	33	-	-	-	-	-				
		MM 457	546	838	-	-	-	-	-					
		<b>RTA 00</b>		1 per carton										
 <p><b>Ottoman</b>                      COM: 1.25 YD   1.14 M                      Unit weight: 23 LB   10.5 KG                      Carton weight: 28 LB   12.7 KG                      Carton volume: 5.75 FT³   0.16 MT³</p>		<b>ML2121</b>	1454	1494	1528	1567	1630	1689	1748	1799	1863	1923	2004	2119
			<b>OVERALL DIMENSIONS</b>			<b>SEAT DIMENSIONS</b>			<b>BACK DIMENSIONS</b>					
			<b>W</b>	<b>D</b>	<b>H</b>	<b>W</b>	<b>D</b>	<b>H</b>	<b>W</b>	<b>H</b>				
			IN 21	21	17	-	-	-	-	-				
		MM 533	533	432	-	-	-	-	-					
		<b>RTA 00</b>		1 per carton										

DESCRIPTION	FEATURES	MODEL #	STANDARD TEXTILE GRADES											
			1	2	3	4	5	6	7	8	9	10	11	12
 <p><b>Dining Chair</b>                      COM: 1.75 YD   1.6 M                      Unit weight: 26 LB   11.8 KG                      Carton weight: 33 LB   14.97 KG                      Carton volume: 14.75 FT³   0.41 MT³</p>		<b>ML2326</b>	2083	2139	2186	2241	2330	2412	2494	2566	2655	2739	2853	3014
			<b>OVERALL DIMENSIONS</b>			<b>SEAT DIMENSIONS</b>			<b>BACK DIMENSIONS</b>					
			<b>W</b>	<b>D</b>	<b>H</b>	<b>W</b>	<b>D</b>	<b>H</b>	<b>W</b>	<b>H</b>				
			IN 23.25 MM 591	29.5 749	29.75 756	20.5 521	17 432	18 457	17 432	11.5 292				
		<b>RTA 00</b>	1 per carton											

DESCRIPTION	FEATURES	MODEL #	STANDARD TEXTILE GRADES											
			1	2	3	4	5	6	7	8	9	10	11	12
 <p><b>Lounge Chair</b>                      COM: 2.5 YD   2.29 M                      Unit weight: 46 LB   20.9 KG                      Carton weight: 54 LB   24.49 KG                      Carton volume: 21.25 FT³   0.6 MT³</p>		<b>ML2630</b>	2328	2408	2476	2553	2681	2798	2916	3018	3146	3266	3428	3658
			<b>OVERALL DIMENSIONS</b>			<b>SEAT DIMENSIONS</b>			<b>BACK DIMENSIONS</b>					
			<b>W</b>	<b>D</b>	<b>H</b>	<b>W</b>	<b>D</b>	<b>H</b>	<b>W</b>	<b>H</b>				
			IN 26 MM 660	34.5 876	35 889	23 584	20 508	18 457	18 457	17.5 445				
		<b>RTA 00</b>	1 per carton											



## ML PARK



model ML4634CH





model ML8634

## STANDARD FEATURES

- ML Park is a modern armless lounge seating series with a distinctive retro design.
- Features aluminum legs with non-marking Black glides.
- Fully upholstered continuous seat and back cushions with distinctive seams.
- Upholstery options: fabric, vinyl or leather. Vinyl and leather models may feature stitch detail across the seat and/or back cushions, if applicable.

## OPTIONAL FEATURES

- Optional fixed back cushion (**FC**) is available on lounge models, please specify. Model ML4634, add \$157. Model ML6634, add \$210. Model ML8634, add \$263.
- Available in five leg finish options: Black (**TBL**), Brushed Aluminum (**BAL**), Designer White (**TDW**), Polished Aluminum (**ALU**) or Tungsten (**TTU**), please specify. No upcharge.

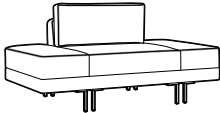
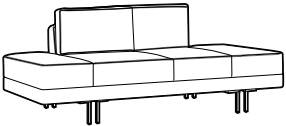
DESCRIPTION	FEATURES	MODEL #	STANDARD TEXTILE GRADES											
			1	2	3	4	5	6	7	8	9	10	11	12
 <p><b>Ottoman</b> COM: 1.5 YD   1.37 M Unit weight: 35 LB   15.9 KG Carton weight: 41 LB   18.6 KG Carton volume: 9.75 FT³   0.27 MT³</p>		<b>ML2634</b>	1525	1573	1614	1660	1737	1807	1878	1939	2016	2088	2185	2323
			<b>OVERALL DIMENSIONS</b>			<b>SEAT DIMENSIONS</b>			<b>BACK DIMENSIONS</b>					
			<b>W</b>	<b>D</b>	<b>H</b>	<b>W</b>	<b>D</b>	<b>H</b>	<b>W</b>	<b>H</b>				
			IN 26.75	26.75	18.25	-	-	-	-	-				
		MM 679	679	464	-	-	-	-	-					
		<b>RTA 00</b>		1 per carton										
 <p><b>Lounge Chair</b> COM: 7.25 YD   6.63 M Unit weight: 85 LB   38.6 KG Carton weight: 95 LB   43.09 KG Carton volume: 35.5 FT³   1 MT³</p>		<b>ML4634</b>	2932	3164	3360	3585	3954	4295	4636	4933	5303	5651	6122	6789
			<b>OVERALL DIMENSIONS</b>			<b>SEAT DIMENSIONS</b>			<b>BACK DIMENSIONS</b>					
			<b>W</b>	<b>D</b>	<b>H</b>	<b>W</b>	<b>D</b>	<b>H</b>	<b>W</b>	<b>H</b>				
			IN 42.75	36	32	42.75	24	20	20	12				
		MM 1086	914	813	1086	610	508	508	305					
		<b>RTA 00</b>	1 per carton											
 <p><b>Two Seat Sofa</b> COM: 7.5 YD   6.86 M Unit weight: 120 LB   54.5 KG Carton weight: 132 LB   59.87 KG Carton volume: 52 FT³   1.47 MT³</p>		<b>ML6634</b>	5018	5258	5461	5693	6076	6428	6781	7088	7471	7831	8318	9008
			<b>OVERALL DIMENSIONS</b>			<b>SEAT DIMENSIONS</b>			<b>BACK DIMENSIONS</b>					
			<b>W</b>	<b>D</b>	<b>H</b>	<b>W</b>	<b>D</b>	<b>H</b>	<b>W</b>	<b>H</b>				
			IN 66	36	32	66	24	20	20	12				
		MM 1676	914	813	1676	610	508	508	305					
		<b>RTA 00</b>	1 per carton											
 <p><b>Three Seat Sofa</b> COM: 11 YD   10.06 M Unit weight: 145 LB   65.9 KG Carton weight: 160 LB   72.57 KG Carton volume: 67.25 FT³   1.9 MT³</p>		<b>ML8634</b>	5916	6268	6565	6906	7467	7984	8501	8952	9513	10041	10756	11768
			<b>OVERALL DIMENSIONS</b>			<b>SEAT DIMENSIONS</b>			<b>BACK DIMENSIONS</b>					
			<b>W</b>	<b>D</b>	<b>H</b>	<b>W</b>	<b>D</b>	<b>H</b>	<b>W</b>	<b>H</b>				
			IN 86	36	32	86	24	20	40	12				
		MM 2184	914	813	2184	610	508	1016	305					
		<b>RTA 00</b>	1 per carton											

PRAIRIE



model 3481



model 3482

STANDARD FEATURES

- Features barrel shaped arms that provide an attractive and enticing appearance.
- Fully upholstered. Tapered wood skirt and legs.
- Fixed, non-removable cushions.
- Elasticized seat suspension system for extra comfort.
- Series includes lounge chair, two seat and three seat sofa.
- Upholstery options: fabric, vinyl or leather. Vinyl and leather models may feature stitch detail across the seat and/or back cushions, if applicable.

OPTIONAL FEATURES

- Tapered wood legs are available in Absolute (AAM), Black (BKM), Cherry (ACM), Espresso Cafe (ECM), English Oak (EOM), Fruitwood (TFM), Gray (HGM), Honey (AHM), Mahogany (TMM), Maple (AVM), Medium Walnut (MWM), Natural Walnut (NLW), Night (ASM), Noce Biondo (NBM), Noce Grigio (NGM), Noce Leggero (NEM), Noce Medio (NMM), Shaker Cherry (SKM), Walnut (TWM), WC Cream (WTM), White (WHM) and Winter Cherry (WCM). Please specify. Genuine maple faced veneers and solids are used.

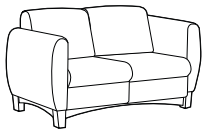
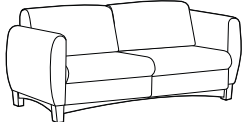
DESCRIPTION	FEATURES	MODEL #	STANDARD TEXTILE GRADES											
			1	2	3	4	5	6	7	8	9	10	11	12
 <p><b>Lounge Chair</b> COM: 4.25 YD   3.89 M Unit weight: 70 LB   31.8 KG Carton weight: 80 LB   36.29 KG Carton volume: 19.25 FT<sup>3</sup>   0.54 MT<sup>3</sup></p>		<b>3481</b>	1502	1638	1753	1885	2101	2301	2501	2675	2892	3096	3372	3763
			<b>OVERALL DIMENSIONS</b>			<b>SEAT DIMENSIONS</b>			<b>BACK DIMENSIONS</b>					
			<b>W</b>	<b>D</b>	<b>H</b>	<b>W</b>	<b>D</b>	<b>H</b>	<b>W</b>	<b>H</b>				
			IN 32	29	30.5	21	19	16	21	14.5				
			MM 813	737	775	533	483	406	533	368				
		<b>RTA 00</b>	1 per carton											
 <p><b>Two Seat Sofa</b> COM: 6.25 YD   5.72 M Unit weight: 96 LB   43.6 KG Carton weight: 106 LB   48.08 KG Carton volume: 41.25 FT<sup>3</sup>   1.16 MT<sup>3</sup></p>		<b>3482</b>	2050	2250	2419	2613	2931	3225	3519	3775	4094	4394	4800	5375
			<b>OVERALL DIMENSIONS</b>			<b>SEAT DIMENSIONS</b>			<b>BACK DIMENSIONS</b>					
			<b>W</b>	<b>D</b>	<b>H</b>	<b>W</b>	<b>D</b>	<b>H</b>	<b>W</b>	<b>H</b>				
			IN 52.5	29	30.5	42	19	16	42	14.5				
			MM 1334	737	775	1067	483	406	1067	368				
		<b>RTA 00</b>	1 per carton											
 <p><b>Three Seat Sofa</b> COM: 9.5 YD   8.69 M Unit weight: 135 LB   61.4 KG Carton weight: 150 LB   68.04 KG Carton volume: 55.5 FT<sup>3</sup>   1.57 MT<sup>3</sup></p>		<b>3483</b>	2599	2903	3160	3454	3939	4385	4832	5221	5706	6162	6779	7653
			<b>OVERALL DIMENSIONS</b>			<b>SEAT DIMENSIONS</b>			<b>BACK DIMENSIONS</b>					
			<b>W</b>	<b>D</b>	<b>H</b>	<b>W</b>	<b>D</b>	<b>H</b>	<b>W</b>	<b>H</b>				
			IN 73.5	29	30.5	63.5	19	16	63.5	14.5				
			MM 1867	737	775	1613	483	406	1613	368				
		<b>RTA 00</b>	1 per carton											

RAMBLER



model RA2652RE



model RA3939SQ

STANDARD FEATURES

- Rambler ottomans feature gently curved shapes that create mobile and stationary spaces in education, workplace and healthcare environments.
- Ottomans are fully upholstered and are available in a variety of sizes and shapes (square, rectangular and trapazoid).
- Standard seat height is 17.5" high (with 3" fixed legs or casters). A 15.5" seat height is also available (with 1" leg).
- Poly legs (3" and 1") are available in Night or Sand finish and are standard with White non-marking polycarbonate glides (see right column for additional glide options).
- 2.5" Black carpet casters (12) are standard or hard surface flooring casters (8R) are optionally available.
- Available with contrasting fabrics. Specify tops separate from sides. Use the Build-It tool on our website for pricing. *Combining different material types (ex. vinyl and fabric) is not recommended due to the potential for puckering.*
- Moisture barrier can be added (with upcharge).
- Sealed seams are not available.
- Ottomans do not gang.
- All models ship fully assembled.
- Active weight capacity for this series is 300 lbs.
- Upholstery options: fabric, vinyl or leather. Vinyl and leather models may feature stitch detail across the seat and/or back cushions, if applicable.

Please add option codes in the following order:

- Model number**  
specify model number
- Top textile**  
specify textile code
- Side textile**  
specify textile code
- Base type**  
**(3L)** 3" leg with 17.5" seat height  
**(1L)** 1" leg with 15.5" seat height  
**(CST)** casters with 17.5" seat height (upcharges may apply - see below)
- Leg finish**  
**(BLK)** Night  
**(SND)** Sand
- Caster type**  
**(12)** 2.5" Black casters for carpeted surfaces. No upcharge.  
**(8R)** 2.5" casters for most hard floor surfaces. Add \$21.
- Glide type**  
**(NM)** White non-marking nylon for most surfaces (standard)  
**(SG)** steel cushioned glides for carpeted surfaces. Add \$17.  
**(RG)** non-slip rubber glides for most hard floor surfaces. Add \$22.  
**(FG)** felt glides for most hard floor surfaces. Add \$22.
- Moisture barrier**  
**(NB)** no moisture barrier.  
**(MB)** moisture barrier (please refer to model for upcharges)

EXAMPLE RAMBLER ORDER CODE:

RA2222SQ	-WA50	-VY20	-3L	BLK	NM	NB
Model number	Top textile	Side textile	Base type	Leg finish or caster type	Glide type	Moisture barrier

DESCRIPTION	FEATURES	MODEL#	STANDARD TEXTILE GRADES													
			1	2	3	4	5	6	7	8	9	10	11	12		
<p><b>Square Ottoman 22" x 22"</b> COM: 1.75 YD   1.6 M Unit weight: 28 LB   12.7 KG Carton weight: 33.5 LB   15.2 KG Carton volume: 6.5 FT<sup>3</sup>   0.18 MT<sup>3</sup></p>	<p>Add \$81 for moisture barrier <b>(MB)</b>.</p> <p>Width and depth may vary by up to 0.5 in.</p>	<b>RA2222SQ</b>	610	666	713	768	857	939	1021	1093	1182	1266	1380	1541		
		<b>OVERALL DIMENSIONS</b>			<b>SEAT DIMENSIONS</b>			<b>BACK DIMENSIONS</b>								
		<b>W</b>	<b>D</b>	<b>H</b>	<b>W</b>	<b>D</b>	<b>H</b>	<b>W</b>	<b>H</b>							
		IN 22.5	22.5	17.5	-	-	-	-	-							
		MM 572	572	445	-	-	-	-	-							
		<b>RTA 00</b>		1 per carton												
<p><b>Square Ottoman 26" x 26"</b> COM: 1.75 YD   1.6 M Unit weight: 38.4 LB   17.5 KG Carton weight: 45.4 LB   20.59 KG Carton volume: 9.5 FT<sup>3</sup>   0.26 MT<sup>3</sup></p>	<p>Add \$81 for moisture barrier <b>(MB)</b>.</p> <p>Width and depth may vary by up to 0.5 in.</p>	<b>RA2626SQ</b>	655	711	758	813	902	984	1066	1138	1227	1311	1425	1586		
		<b>OVERALL DIMENSIONS</b>			<b>SEAT DIMENSIONS</b>			<b>BACK DIMENSIONS</b>								
		<b>W</b>	<b>D</b>	<b>H</b>	<b>W</b>	<b>D</b>	<b>H</b>	<b>W</b>	<b>H</b>							
		IN 26.5	26.5	17.5	-	-	-	-	-							
		MM 673	673	445	-	-	-	-	-							
		<b>RTA 00</b>		1 per carton												

DESCRIPTION	FEATURES	MODEL #	STANDARD TEXTILE GRADES														
			1	2	3	4	5	6	7	8	9	10	11	12			
 <p><b>Square Ottoman 39" x 39"</b> COM: 3.5 YD   3.2 M Unit weight: 63 LB   28.6 KG Carton weight: 76 LB   34.47 KG Carton volume: 19.5 FT³   0.55 MT³</p>	<p>Add \$165 for moisture barrier (MB).</p> <p>Width and depth may vary by up to 0.5 in.</p>	<p>IN 39.5 39.5 17.5 MM 1003 1003 445</p>	1	2	3	4	5	6	7	8	9	10	11	12			
			RA3939SQ	1125	1237	1332	1441	1618	1783	1948	2091	2270	2438	2665	2987		
			OVERALL DIMENSIONS			SEAT DIMENSIONS			BACK DIMENSIONS								
			W	D	H	W	D	H	W	H							
RTA 00		courier		1 per carton													
 <p><b>Rectangular Ottoman 26" x 39"</b> COM: 2.5 YD   2.29 M Unit weight: 57.4 LB   26.1 KG Carton weight: 66.4 LB   30.12 KG Carton volume: 13.75 FT³   0.38 MT³</p>	<p>Add \$122 for moisture barrier (MB).</p> <p>Width and depth may vary by up to 0.5 in.</p>	<p>IN 39.5 26.5 17.5 MM 1003 673 445</p>	1	2	3	4	5	6	7	8	9	10	11	12			
			RA2639RE	870	950	1018	1095	1223	1340	1458	1560	1688	1808	1970	2200		
			OVERALL DIMENSIONS			SEAT DIMENSIONS			BACK DIMENSIONS								
			W	D	H	W	D	H	W	H							
RTA 00		1 per carton															
 <p><b>Rectangular Ottoman 26" x 52"</b> COM: 2.5 YD   2.29 M Unit weight: 64 LB   29.1 KG Carton weight: 75 LB   34.02 KG Carton volume: 17.75 FT³   0.5 MT³</p>	<p>Add \$122 for moisture barrier (MB).</p> <p>Width and depth may vary by up to 0.5 in.</p>	<p>IN 52.5 26.5 17.5 MM 1334 673 445</p>	1	2	3	4	5	6	7	8	9	10	11	12			
			RA2652RE	1105	1185	1253	1330	1458	1575	1693	1795	1923	2043	2205	2435		
			OVERALL DIMENSIONS			SEAT DIMENSIONS			BACK DIMENSIONS								
			W	D	H	W	D	H	W	H							
RTA 00		1 per carton															
 <p><b>Trapezoid Ottoman 26" x 26"</b> COM: 2.25 YD   2.06 M Unit weight: 31.8 LB   14.5 KG Carton weight: 38.8 LB   17.6 KG Carton volume: 9.5 FT³   0.26 MT³</p>	<p>Add \$122 for moisture barrier (MB).</p> <p>Width and depth may vary by up to 0.5 in.</p>	<p>IN 27.5 27.5 17.5 MM 699 699 445</p>	1	2	3	4	5	6	7	8	9	10	11	12			
			RA2626TR	655	727	788	858	973	1078	1184	1276	1391	1499	1645	1852		
			OVERALL DIMENSIONS			SEAT DIMENSIONS			BACK DIMENSIONS								
			W	D	H	W	D	H	W	H							
RTA 00		1 per carton															
 <p><b>Trapezoid Ottoman 26" x 39"</b> COM: 2.5 YD   2.29 M Unit weight: 48 LB   21.8 KG Carton weight: 59 LB   26.76 KG Carton volume: 13.75 FT³   0.38 MT³</p>	<p>Add \$122 for moisture barrier (MB).</p> <p>Width and depth may vary by up to 0.5 in.</p>	<p>IN 39.5 26.5 17.5 MM 1003 673 445</p>	1	2	3	4	5	6	7	8	9	10	11	12			
			RA2639TR	870	950	1018	1095	1223	1340	1458	1560	1688	1808	1970	2200		
			OVERALL DIMENSIONS			SEAT DIMENSIONS			BACK DIMENSIONS								
			W	D	H	W	D	H	W	H							
RTA 00		1 per carton															
 <p><b>Trapezoid Ottoman 26" x 52"</b> COM: 2.5 YD   2.29 M Unit weight: 59.4 LB   27 KG Carton weight: 70.4 LB   31.93 KG Carton volume: 17.75 FT³   0.5 MT³</p>	<p>Add \$122 for moisture barrier (MB).</p> <p>Width and depth may vary by up to 0.5 in.</p>	<p>IN 52.5 26.5 17.5 MM 1334 673 445</p>	1	2	3	4	5	6	7	8	9	10	11	12			
			RA2652TR	1105	1185	1253	1330	1458	1575	1693	1795	1923	2043	2205	2435		
			OVERALL DIMENSIONS			SEAT DIMENSIONS			BACK DIMENSIONS								
			W	D	H	W	D	H	W	H							
RTA 00		1 per carton															

RIVER



Sample Layout



Sample Layout

STANDARD FEATURES

- A seating series that is composed of modular units in straight, curved and corner sections, as well as freestanding units. Soft seating models are available with standard height, high and extended high backs. Linking units can be used together in any combination to create a wide variety of layouts.
- Armless units can be ganged together with a quick connect, disconnect feature. Ganging hardware is standard and is factory installed. Ganging hardware swivels out of sight when not in use.
- Front edge of the seat angles slightly inward, so feet have freedom of movement and don't rub on the seat. This inward slant matches the inward angles of the back. Benches and connecting end tables also reflect the inward angles on the front and back faces, so all units coordinate in visual appearance.
- The unique tapered legs are made of welded steel, with each leg bolted directly to the unit frame. All units except for the laptop tables have the same leg height of 6.5". The leg height makes it easier to clean under the product.
- Legs are standard in Chrome with Black nylon non-marking height adjustable glides.
- All cushions are fixed and non-removable. Perimeter seams feature a decorative single stitch detail, which makes seams lay flat and adds extra seam strength.
- Seating frames are heavy duty with interlocking plywood, puzzle box construction, and are made for active environments. Seats are high density with highly resilient foam.
- Personal Harbor high traffic units are rated at 350 lbs., suitable for 24/7 use and should be specified in textiles that meet or exceed 100,000 double rubs (for the fabric portion of the warranty to apply). These units have the same puzzle box frame construction as other River models except the framing wood is 1" thick, rotary cut, birch plywood.
- Upholstery options: fabric, vinyl or leather. Leather only recommended on seat and may feature a horizontal stitch detail.

OPTIONAL FEATURES

- Most tables and seating units (except round benches) can be specified with power/USB units, which include two power outlets, two double USB terminals and a Black 5' three-prong power cord. Each power/USB unit is set in predetermined locations, as shown in the electrical illustrations below. Electrical units must be factory installed.
- Power/USB units are available with either Jet Black (J) face plate with Black power/USB receptacles or with a White (W) face plate with White power/USB receptacles.
- To add a power/USB unit, please specify (J1), (W1), (J2), (W2), (J3), (W3), (J4), (W4), (J6) or (W6) after the product model number. Please note on seating units, if both right and left locations are required, add both (J1/J3) or (W1/W3) to the model number. Add \$729 each.
- Coffee, end and laptop tables are made with high pressure laminate and are offered in the following finishes: Absolute Acajou (ACJ), Asian Night (ASN), Avant Cherry (AWC), Avant Honey (AWH), Blizzard (BZD), Clear Maple (CMB), Custom Grey (CGY), Dark Espresso (DES), Designer White (DWT), Stonedust (SDT), Walnut Heights (WHE), White Chocolate (WHC) and Winter Cherry (WCR). Please specify. Custom high pressure laminate finishes will be considered upon request.
- For leg finish options, please see page 360. No upcharges.
- If more than one fabric or a fabric/vinyl and leather combination is required, please fill out a "Seating Multiple Textile" form, specifying each fabric location. Please contact Customer Service for more information.

ELECTRICAL PLACEMENT

Soft Seating

Locations available on left side J1 (Black) or W1 (White), right side J3 (Black), or W3 (White) or both sides J1/J3 (Black) or W1/W3 (White).

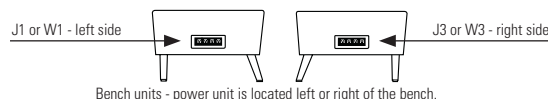
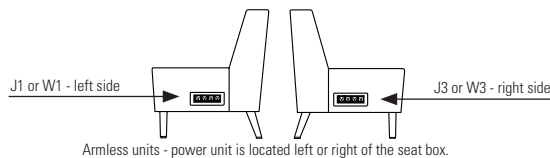
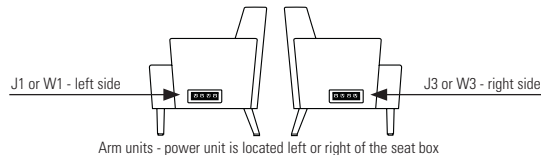
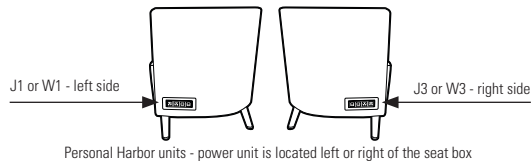



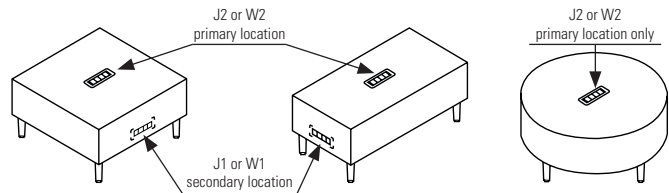

Coffee/End Tables

Primary location is on the top of the unit, centered J2 (Black) or W2 (White). Secondary Location is end/side of the unit J1 (Black) or W1 (White).

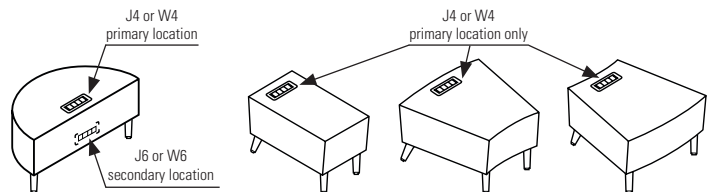

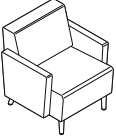
Primary location is on the top rear/edge of the unit J4 (Black) or W4 (White). Secondary Location is the back side of the unit J6 (Black) or W6 (White).

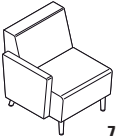

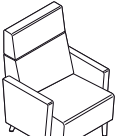
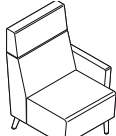
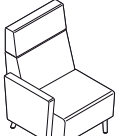

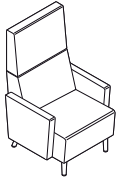
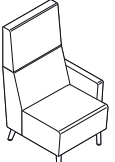
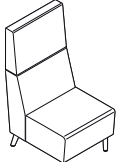
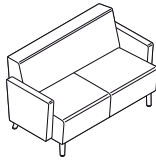
DESCRIPTION	FEATURES	MODEL#	STANDARD TEXTILE GRADES												
			1	2	3	4	5	6	7	8	9	10	11	12	
 <p><b>Lounge Chair - Standard Back w/Arms</b>                      COM: 4 YD   3.66 M                      Unit weight: 46 LB   20.9 KG                      Carton weight: 57 LB   25.85 KG                      Carton volume: 22.5 FT³   0.63 MT³</p>	For power/USB unit please see electrical placement chart. Freestanding unit only.	<b>7701</b>	1920	2048	2156	2280	2484	2672	2860	3024	3228	3420	3680	4048	
			<b>OVERALL DIMENSIONS</b>			<b>SEAT DIMENSIONS</b>			<b>BACK DIMENSIONS</b>						
			<b>W</b>	<b>D</b>	<b>H</b>	<b>W</b>	<b>D</b>	<b>H</b>	<b>W</b>	<b>H</b>					
			IN 29.5 MM 749	29.5 749	32 813	24 610	19 483	18 457	24 610	14 356					
			<b>RTA 00</b> 1 per carton												
 <p><b>7701L (Left arm)</b></p>	 <p><b>7701R (Right arm)</b></p>	<b>7701L</b> 7701R	1676	1780	1868	1969	2134	2287	2440	2573	2739	2895	3106	3405	
			<b>OVERALL DIMENSIONS</b>			<b>SEAT DIMENSIONS</b>			<b>BACK DIMENSIONS</b>						
			<b>W</b>	<b>D</b>	<b>H</b>	<b>W</b>	<b>D</b>	<b>H</b>	<b>W</b>	<b>H</b>					
			IN 27 MM 686	29.5 749	32 813	24 610	19 483	18 457	24 610	14 356					
			<b>RTA 00</b> 1 per carton												
 <p><b>Armless Lounge Chair - Standard Back</b>                      COM: 2.5 YD   2.29 M                      Unit weight: 26 LB   11.8 KG                      Carton weight: 37 LB   16.78 KG                      Carton volume: 22.5 FT³   0.63 MT³</p>	For power/USB unit please see electrical placement chart. Includes ganging hardware (2 sides).	<b>7701NA</b>	1432	1512	1580	1657	1785	1902	2020	2122	2250	2370	2532	2762	
			<b>OVERALL DIMENSIONS</b>			<b>SEAT DIMENSIONS</b>			<b>BACK DIMENSIONS</b>						
			<b>W</b>	<b>D</b>	<b>H</b>	<b>W</b>	<b>D</b>	<b>H</b>	<b>W</b>	<b>H</b>					
			IN 24.5 MM 622	29.5 749	32 813	24 610	19 483	18 457	24 610	14 356					
			<b>RTA 00</b> 1 per carton												
 <p><b>Lounge Chair - High Back w/Arms</b>                      COM: 4.5 YD   4.11 M                      Unit weight: 48 LB   21.8 KG                      Carton weight: 61 LB   27.67 KG                      Carton volume: 28.25 FT³   0.79 MT³</p>	For power/USB unit please see electrical placement chart. Freestanding unit only.	<b>7702</b>	2154	2298	2420	2559	2789	3000	3212	3396	3626	3842	4134	4548	
			<b>OVERALL DIMENSIONS</b>			<b>SEAT DIMENSIONS</b>			<b>BACK DIMENSIONS</b>						
			<b>W</b>	<b>D</b>	<b>H</b>	<b>W</b>	<b>D</b>	<b>H</b>	<b>W</b>	<b>H</b>					
			IN 29.5 MM 749	29.5 749	41.5 1054	24 610	19 483	18 457	24 610	24 610					
			<b>RTA 00</b> 1 per carton												
 <p><b>7702L (Left arm)</b></p>	 <p><b>7702R (Right arm)</b></p>	<b>7702L</b> 7702R	1913	2033	2134	2251	2442	2618	2794	2948	3139	3319	3563	3908	
			<b>OVERALL DIMENSIONS</b>			<b>SEAT DIMENSIONS</b>			<b>BACK DIMENSIONS</b>						
			<b>W</b>	<b>D</b>	<b>H</b>	<b>W</b>	<b>D</b>	<b>H</b>	<b>W</b>	<b>H</b>					
			IN 27 MM 686	29.5 749	41.5 1054	24 610	19 483	18 457	24 610	24 610					
			<b>RTA 00</b> 1 per carton												

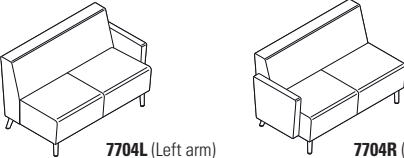

DESCRIPTION	FEATURES	MODEL#	STANDARD TEXTILE GRADES											
			1	2	3	4	5	6	7	8	9	10	11	12
 <p><b>Armless Lounge Chair - High Back</b>                      COM: 3 YD   2.74 M                      Unit weight: 28 LB   12.7 KG                      Carton weight: 41 LB   18.6 KG                      Carton volume: 28.25 FT<sup>3</sup>   0.79 MT<sup>3</sup></p>	<p>For power/USB unit please see electrical placement chart. Includes ganging hardware (2 sides).</p>	<b>7702NA</b>	1669	1765	1846	1939	2092	2233	2374	2497	2650	2794	2989	3265
		<b>OVERALL DIMENSIONS</b>			<b>SEAT DIMENSIONS</b>			<b>BACK DIMENSIONS</b>						
		<b>W</b>	<b>D</b>	<b>H</b>	<b>W</b>	<b>D</b>	<b>H</b>	<b>W</b>	<b>H</b>					
		IN 24.5 MM 622	29.5 749	41.5 1054	24 610	19 483	18 457	24 610	24 610					
		<b>RTA 00</b>			1 per carton									
 <p><b>Lounge Chair - Extended Back w/Arms</b>                      COM: 4.75 YD   4.34 M                      Unit weight: 51 LB   23.2 KG                      Carton weight: 68 LB   30.84 KG                      Carton volume: 32.75 FT<sup>3</sup>   0.92 MT<sup>3</sup></p>	<p>For power/USB unit please see electrical placement chart. Freestanding unit only.</p>	<b>7703</b>	2247	2399	2527	2675	2917	3140	3363	3558	3800	4028	4337	4774
		<b>OVERALL DIMENSIONS</b>			<b>SEAT DIMENSIONS</b>			<b>BACK DIMENSIONS</b>						
		<b>W</b>	<b>D</b>	<b>H</b>	<b>W</b>	<b>D</b>	<b>H</b>	<b>W</b>	<b>H</b>					
		IN 29.5 MM 749	29.5 749	47 1194	24 610	19 483	18 457	24 610	29 737					
		<b>RTA 00</b>			1 per carton									
 <p><b>Lounge Chair-Extended Back w/One Arm</b>                      COM: 4 YD   3.66 M                      Unit weight: 41 LB   18.6 KG                      Carton weight: 58 LB   26.31 KG                      Carton volume: 32.75 FT<sup>3</sup>   0.92 MT<sup>3</sup></p>	<p>For power/USB unit please see electrical placement chart. Includes ganging hardware (1 side).</p>	<b>7703L</b>	2004	2132	2240	2364	2568	2756	2944	3108	3312	3504	3764	4132
		<b>OVERALL DIMENSIONS</b>			<b>SEAT DIMENSIONS</b>			<b>BACK DIMENSIONS</b>						
		<b>W</b>	<b>D</b>	<b>H</b>	<b>W</b>	<b>D</b>	<b>H</b>	<b>W</b>	<b>H</b>					
		IN 27 MM 686	29.5 749	47 1194	24 610	19 483	18 457	24 610	29 737					
		<b>RTA 00</b>			1 per carton									
 <p><b>Armless Lounge Chair - Extended Back</b>                      COM: 3.25 YD   2.97 M                      Unit weight: 31 LB   14.1 KG                      Carton weight: 48 LB   21.77 KG                      Carton volume: 32.75 FT<sup>3</sup>   0.92 MT<sup>3</sup></p>	<p>For power/USB unit please see electrical placement chart. Includes ganging hardware (2 sides).</p>	<b>7703R</b>	2004	2132	2240	2364	2568	2756	2944	3108	3312	3504	3764	4132
		<b>OVERALL DIMENSIONS</b>			<b>SEAT DIMENSIONS</b>			<b>BACK DIMENSIONS</b>						
		<b>W</b>	<b>D</b>	<b>H</b>	<b>W</b>	<b>D</b>	<b>H</b>	<b>W</b>	<b>H</b>					
		IN 24.5 MM 622	29.5 749	47 1194	24 610	19 483	18 457	24 610	29 737					
		<b>RTA 00</b>			1 per carton									
 <p><b>Two Seater - Standard Back w/Arms</b>                      COM: 5.5 YD   5.03 M                      Unit weight: 73 LB   33.2 KG                      Carton weight: 95 LB   43.09 KG                      Carton volume: 39 FT<sup>3</sup>   1.1 MT<sup>3</sup></p>	<p>For power/USB unit please see electrical placement chart. Freestanding unit only.</p>	<b>7704</b>	2702	2878	3027	3197	3478	3736	3995	4220	4501	4765	5122	5628
		<b>OVERALL DIMENSIONS</b>			<b>SEAT DIMENSIONS</b>			<b>BACK DIMENSIONS</b>						
		<b>W</b>	<b>D</b>	<b>H</b>	<b>W</b>	<b>D</b>	<b>H</b>	<b>W</b>	<b>H</b>					
		IN 53.5 MM 1359	29.5 749	32 813	48 1219	19 483	18 457	48 1219	14 356					
		<b>RTA 00</b>			1 per carton									

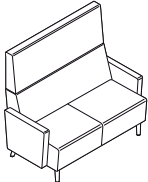
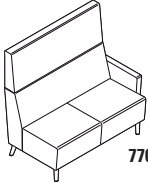
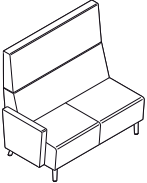
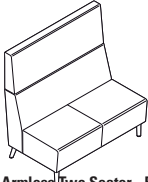
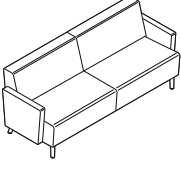

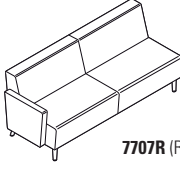
DESCRIPTION	FEATURES	MODEL#	STANDARD TEXTILE GRADES												
			1	2	3	4	5	6	7	8	9	10	11	12	
 <p><b>7704L</b> (Left arm) <b>7704R</b> (Right arm)</p> <p><b>Two Seater - Standard Back w/One Arm</b> COM: 4.75 YD   4.34 M Unit weight: 63 LB   28.6 KG Carton weight: 85 LB   38.56 KG Carton volume: 39 FT³   1.1 MT³</p>	<p>For power/USB unit please see electrical placement chart. Includes ganging hardware (1 side).</p>	<p><b>7704L</b> 7704R</p>	1	2	3	4	5	6	7	8	9	10	11	12	
			2460	2612	2740	2888	3130	3353	3576	3771	4013	4241	4550	4987	
			<b>OVERALL DIMENSIONS</b>			<b>SEAT DIMENSIONS</b>			<b>BACK DIMENSIONS</b>						
			<b>W</b>	<b>D</b>	<b>H</b>	<b>W</b>	<b>D</b>	<b>H</b>	<b>W</b>	<b>H</b>					
			IN 51	29.5	32	48	19	18	48	14					
			MM 1295	749	813	1219	483	457	1219	356					
			<b>RTA 00</b>	1 per carton											
			1	2	3	4	5	6	7	8	9	10	11	12	
			<b>7704NA</b>	2217	2353	2468	2600	2816	3016	3216	3390	3607	3811	4087	4478
			<b>OVERALL DIMENSIONS</b>			<b>SEAT DIMENSIONS</b>			<b>BACK DIMENSIONS</b>						
			<b>W</b>	<b>D</b>	<b>H</b>	<b>W</b>	<b>D</b>	<b>H</b>	<b>W</b>	<b>H</b>					
			IN 48.5	29.5	32	48	19	18	48	14					
			MM 1232	749	813	1219	483	457	1219	356					
			<b>RTA 00</b>	1 per carton											
			1	2	3	4	5	6	7	8	9	10	11	12	
			<b>7705</b>	3172	3380	3556	3757	4089	4394	4700	4966	5298	5610	6032	6630
			<b>OVERALL DIMENSIONS</b>			<b>SEAT DIMENSIONS</b>			<b>BACK DIMENSIONS</b>						
			<b>W</b>	<b>D</b>	<b>H</b>	<b>W</b>	<b>D</b>	<b>H</b>	<b>W</b>	<b>H</b>					
			IN 53.5	29.5	41.5	48	19	18	48	24					
			MM 1359	749	1054	1219	483	457	1219	610					
			<b>RTA 00</b>	1 per carton											
			1	2	3	4	5	6	7	8	9	10	11	12	
			<b>7705L</b> 7705R	2929	3113	3268	3447	3740	4010	4280	4516	4809	5085	5459	5988
			<b>OVERALL DIMENSIONS</b>			<b>SEAT DIMENSIONS</b>			<b>BACK DIMENSIONS</b>						
			<b>W</b>	<b>D</b>	<b>H</b>	<b>W</b>	<b>D</b>	<b>H</b>	<b>W</b>	<b>H</b>					
			IN 51	29.5	41.5	48	19	18	48	24					
			MM 1295	749	1054	1219	483	457	1219	610					
			<b>RTA 00</b>	1 per carton											
			1	2	3	4	5	6	7	8	9	10	11	12	
			<b>7705NA</b>	2687	2855	2997	3160	3427	3674	3921	4136	4404	4656	4997	5480
			<b>OVERALL DIMENSIONS</b>			<b>SEAT DIMENSIONS</b>			<b>BACK DIMENSIONS</b>						
			<b>W</b>	<b>D</b>	<b>H</b>	<b>W</b>	<b>D</b>	<b>H</b>	<b>W</b>	<b>H</b>					
			IN 48.5	29.5	41.5	48	19	18	48	24					
			MM 1232	749	1054	1219	483	457	1219	610					
			<b>RTA 00</b>	1 per carton											

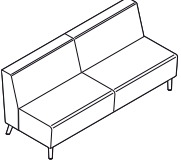
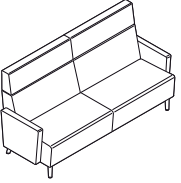
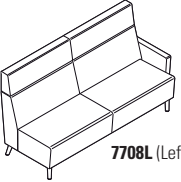
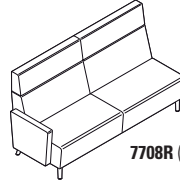
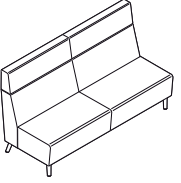
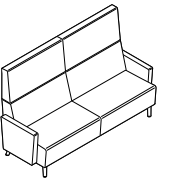

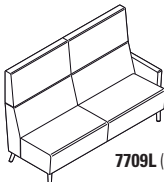
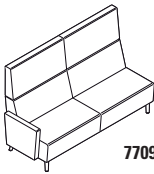
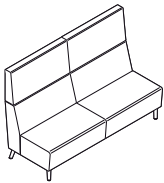
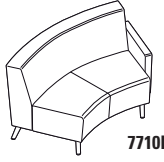
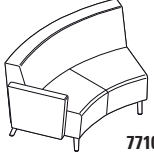
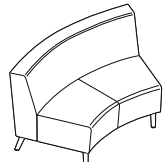
DESCRIPTION	FEATURES	MODEL#	STANDARD TEXTILE GRADES											
			1	2	3	4	5	6	7	8	9	10	11	12
 <p><b>Two Seater - Extended Back w/Arms</b>                      COM: 7 YD   6.4 M                      Unit weight: 81 LB   36.8 KG                      Carton weight: 107 LB   48.53 KG                      Carton volume: 56.75 FT³   1.6 MT³</p>	For power/USB unit please see electrical placement chart. Freestanding unit only.	7706	3358	3582	3771	3988	4345	4674	5003	5290	5647	5983	6438	7082
			<b>OVERALL DIMENSIONS</b>			<b>SEAT DIMENSIONS</b>			<b>BACK DIMENSIONS</b>					
			<b>W</b>	<b>D</b>	<b>H</b>	<b>W</b>	<b>D</b>	<b>H</b>	<b>W</b>	<b>H</b>				
			IN 53.5	29.5	47	48	19	18	48	29				
			MM 1359	749	1194	1219	483	457	1219	737				
		<b>RTA 00</b>	1 per carton											
 <p><b>Two Seater - Extended Back w/One Arm</b>                      COM: 6.25 YD   5.72 M                      Unit weight: 71 LB   32.3 KG                      Carton weight: 97 LB   44 KG                      Carton volume: 56.75 FT³   1.6 MT³</p>	 <p><b>7706L (Left arm)</b>      <b>7706R (Right arm)</b></p> For power/USB unit please see electrical placement chart. Includes ganging hardware (1 side).	7706L 7706R	3115	3315	3484	3678	3996	4290	4584	4840	5159	5459	5865	6440
			<b>OVERALL DIMENSIONS</b>			<b>SEAT DIMENSIONS</b>			<b>BACK DIMENSIONS</b>					
			<b>W</b>	<b>D</b>	<b>H</b>	<b>W</b>	<b>D</b>	<b>H</b>	<b>W</b>	<b>H</b>				
			IN 51	29.5	47	48	19	18	48	29				
			MM 1295	749	1194	1219	483	457	1219	737				
		<b>RTA 00</b>	1 per carton											
 <p><b>Armless Two Seater - Extended Back</b>                      COM: 5.75 YD   5.26 M                      Unit weight: 61 LB   27.7 KG                      Carton weight: 87 LB   39.46 KG                      Carton volume: 56.75 FT³   1.6 MT³</p>	For power/USB unit please see electrical placement chart. Includes ganging hardware (2 sides).	7706NA	2871	3055	3210	3389	3682	3952	4222	4458	4751	5027	5401	5930
			<b>OVERALL DIMENSIONS</b>			<b>SEAT DIMENSIONS</b>			<b>BACK DIMENSIONS</b>					
			<b>W</b>	<b>D</b>	<b>H</b>	<b>W</b>	<b>D</b>	<b>H</b>	<b>W</b>	<b>H</b>				
			IN 48.5	29.5	47	48	19	18	48	29				
			MM 1232	749	1194	1219	483	457	1219	737				
		<b>RTA 00</b>	1 per carton											
 <p><b>Three Seater - Standard Back w/Arms</b>                      COM: 8.25 YD   7.54 M                      Unit weight: 108 LB   49.1 KG                      Carton weight: 139 LB   63.05 KG                      Carton volume: 55.5 FT³   1.57 MT³</p>	For power/USB unit please see electrical placement chart. Freestanding unit only.	7707	4268	4532	4755	5011	5431	5819	6207	6545	6966	7362	7898	8657
			<b>OVERALL DIMENSIONS</b>			<b>SEAT DIMENSIONS</b>			<b>BACK DIMENSIONS</b>					
			<b>W</b>	<b>D</b>	<b>H</b>	<b>W</b>	<b>D</b>	<b>H</b>	<b>W</b>	<b>H</b>				
			IN 77.5	29.5	32	72	19	18	72	14				
			MM 1969	749	813	1829	483	457	1829	356				
		<b>RTA 00</b>	1 per carton											
 <p><b>Three Seater - Standard Back w/One Arm</b>                      COM: 7.75 YD   7.09 M                      Unit weight: 98 LB   44.5 KG                      Carton weight: 129 LB   58.51 KG                      Carton volume: 55.5 FT³   1.57 MT³</p>	 <p><b>7707L (Left arm)</b>      <b>7707R (Right arm)</b></p> For power/USB unit please see electrical placement chart. Includes ganging hardware (1 side).	7707L 7707R	4025	4273	4482	4723	5118	5482	5846	6164	6559	6931	7435	8148
			<b>OVERALL DIMENSIONS</b>			<b>SEAT DIMENSIONS</b>			<b>BACK DIMENSIONS</b>					
			<b>W</b>	<b>D</b>	<b>H</b>	<b>W</b>	<b>D</b>	<b>H</b>	<b>W</b>	<b>H</b>				
			IN 75	29.5	32	72	19	18	72	14				
			MM 1905	749	813	1829	483	457	1829	356				
		<b>RTA 00</b>	1 per carton											

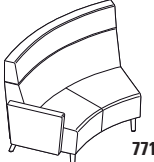
DESCRIPTION	FEATURES	MODEL#	STANDARD TEXTILE GRADES											
			1	2	3	4	5	6	7	8	9	10	11	12
 <p><b>Armless Three Seater - Standard Back</b>                      COM: 7 YD   6.4 M                      Unit weight: 88 LB   40 KG                      Carton weight: 119 LB   53.98 KG                      Carton volume: 55.5 FT³   1.57 MT³</p>	For power/USB unit please see electrical placement chart. Includes ganging hardware (2 sides).	<b>7707NA</b>	3783	4007	4196	4413	4770	5099	5428	5715	6072	6408	6863	7507
			<b>OVERALL DIMENSIONS</b> W D H			<b>SEAT DIMENSIONS</b> W D H			<b>BACK DIMENSIONS</b> W H					
			IN 72.5	29.5	32	72	19	18	72	14				
			MM 1842	749	813	1829	483	457	1829	356				
		<b>RTA 00</b>	1 per carton											
 <p><b>Three Seater - High Back w/Arms</b>                      COM: 10.5 YD   9.6 M                      Unit weight: 112 LB   50.9 KG                      Carton weight: 148 LB   67.13 KG                      Carton volume: 69.75 FT³   1.97 MT³</p>	For power/USB unit please see electrical placement chart. Freestanding unit only.	<b>7708</b>	4973	5309	5593	5918	6454	6947	7441	7871	8407	8911	9593	10559
			<b>OVERALL DIMENSIONS</b> W D H			<b>SEAT DIMENSIONS</b> W D H			<b>BACK DIMENSIONS</b> W H					
			IN 77.5	29.5	41.5	72	19	18	72	24				
			MM 1969	749	1054	1829	483	457	1829	610				
		<b>RTA 00</b>	1 per carton											
 <p><b>7708L (Left arm)</b></p>  <p><b>7708R (Right arm)</b></p>	For power/USB unit please see electrical placement chart. Includes ganging hardware (1 side).	<b>7708L</b> 7708R	4731	5043	5306	5609	6106	6564	7022	7422	7919	8387	9021	9918
			<b>OVERALL DIMENSIONS</b> W D H			<b>SEAT DIMENSIONS</b> W D H			<b>BACK DIMENSIONS</b> W H					
			IN 75	29.5	41.5	72	19	18	72	24				
			MM 1905	749	1054	1829	483	457	1829	610				
		<b>RTA 00</b>	1 per carton											
 <p><b>Armless Three Seater - High Back</b>                      COM: 9.25 YD   8.46 M                      Unit weight: 92 LB   41.8 KG                      Carton weight: 126 LB   57.15 KG                      Carton volume: 69.75 FT³   1.97 MT³</p>	For power/USB unit please see electrical placement chart. Includes ganging hardware (2 sides).	<b>7708NA</b>	4486	4782	5032	5319	5790	6225	6660	7039	7511	7955	8556	9407
			<b>OVERALL DIMENSIONS</b> W D H			<b>SEAT DIMENSIONS</b> W D H			<b>BACK DIMENSIONS</b> W H					
			IN 72.5	29.5	41.5	72	19	18	72	24				
			MM 1842	749	1054	1829	483	457	1829	610				
		<b>RTA 00</b>	1 per carton											
 <p><b>Three Seater - Extended Back w/Arms</b>                      COM: 11 YD   10.06 M                      Unit weight: 116 LB   52.7 KG                      Carton weight: 144 LB   65.32 KG                      Carton volume: 78.75 FT³   2.22 MT³</p>	For power/USB unit please see electrical placement chart. Freestanding unit only.	<b>7709</b>	5250	5602	5899	6240	6801	7318	7835	8286	8847	9375	10090	11102
			<b>OVERALL DIMENSIONS</b> W D H			<b>SEAT DIMENSIONS</b> W D H			<b>BACK DIMENSIONS</b> W H					
			IN 77.5	29.5	47	72	19	18	72	29				
			MM 1969	749	1194	1829	483	457	1829	737				
		<b>RTA 00</b>	1 per carton											

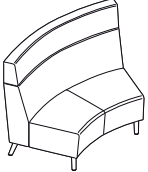
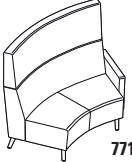
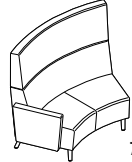
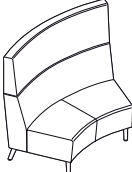
DESCRIPTION	FEATURES	MODEL#	STANDARD TEXTILE GRADES											
			1	2	3	4	5	6	7	8	9	10	11	12
 <p><b>7709L</b> (Left arm)</p>	 <p><b>7709R</b> (Right arm)</p>	<p><b>7709L</b> 7709R</p>	1	2	3	4	5	6	7	8	9	10	11	12
			5007	5343	5627	5952	6488	6981	7475	7905	8441	8945	9627	10593
<p><b>Three Seater - Extended Back w/One Arm</b> COM: 10.5 YD   9.6 M Unit weight: 106 LB   48.2 KG Carton weight: 134 LB   60.78 KG Carton volume: 78.75 FT³   2.22 MT³</p>			<p>For power/USB unit please see electrical placement chart. Includes ganging hardware (1 side).</p>			<p><b>OVERALL DIMENSIONS</b> W D H</p>			<p><b>SEAT DIMENSIONS</b> W D H</p>			<p><b>BACK DIMENSIONS</b> W H</p>		
<p>IN 75 29.5 47 72 19 18 72 29 MM 1905 749 1194 1829 483 457 1829 737</p>			<p><b>RTA 00</b> 1 per carton</p>											
		<p><b>7709NA</b></p>	1	2	3	4	5	6	7	8	9	10	11	12
			4764	5076	5339	5642	6139	6597	7055	7455	7952	8420	9054	9951
<p><b>Armless Three Seater - Extended Back</b> COM: 9.75 YD   8.92 M Unit weight: 96 LB   43.6 KG Carton weight: 124 LB   56.25 KG Carton volume: 78.75 FT³   2.22 MT³</p>			<p>For power/USB unit please see electrical placement chart. Includes ganging hardware (2 sides).</p>			<p><b>OVERALL DIMENSIONS</b> W D H</p>			<p><b>SEAT DIMENSIONS</b> W D H</p>			<p><b>BACK DIMENSIONS</b> W H</p>		
<p>IN 72.5 29.5 47 72 19 18 72 29 MM 1842 749 1194 1829 483 457 1829 737</p>			<p><b>RTA 00</b> 1 per carton</p>											
 <p><b>7710L</b> (Left arm)</p>	 <p><b>7710R</b> (Right arm)</p>	<p><b>7710L</b> 7710R</p>	1	2	3	4	5	6	7	8	9	10	11	12
			2886	3054	3196	3359	3626	3873	4120	4335	4603	4855	5196	5679
<p><b>IS Curve - Two Seater - Standard Back w/One Arm</b> COM: 5.25 YD   4.8 M Unit weight: 68 LB   30.9 KG Carton weight: 88 LB   39.92 KG Carton volume: 43 FT³   1.21 MT³</p>			<p>For power/USB unit please see electrical placement chart. Includes ganging hardware (2 sides).</p>			<p><b>OVERALL DIMENSIONS</b> W D H</p>			<p><b>SEAT DIMENSIONS</b> W D H</p>			<p><b>BACK DIMENSIONS</b> W H</p>		
<p>IN 57 29.5 32 42 19 18 51 14 MM 1448 749 813 1067 483 457 1295 356</p>			<p><b>RTA 00</b> 1 per carton</p>											
		<p><b>7710NA</b></p>	1	2	3	4	5	6	7	8	9	10	11	12
			2643	2787	2909	3048	3278	3489	3701	3885	4115	4331	4623	5037
<p><b>Armless IS Curve - Two Seat - Standard Back</b> COM: 4.5 YD   4.11 M Unit weight: 58 LB   26.4 KG Carton weight: 78 LB   35.38 KG Carton volume: 43 FT³   1.21 MT³</p>			<p>For power/USB unit please see electrical placement chart. Includes ganging hardware (2 sides).</p>			<p><b>OVERALL DIMENSIONS</b> W D H</p>			<p><b>SEAT DIMENSIONS</b> W D H</p>			<p><b>BACK DIMENSIONS</b> W H</p>		
<p>IN 55 29.5 32 42 19 18 51 14 MM 1397 749 813 1067 483 457 1295 356</p>			<p><b>RTA 00</b> 1 per carton</p>											
 <p><b>7711L</b> (Left arm)</p>	 <p><b>7711R</b> (Right arm)</p>	<p><b>7711L</b> 7711R</p>	1	2	3	4	5	6	7	8	9	10	11	12
			3428	3636	3812	4013	4345	4650	4956	5222	5554	5866	6288	6886
<p><b>IS Curve - Two Seater - High Back w/One Arm</b> COM: 6.5 YD   5.94 M Unit weight: 72 LB   32.7 KG Carton weight: 94 LB   42.64 KG Carton volume: 54 FT³   1.52 MT³</p>			<p>For power/USB unit please see electrical placement chart. Includes ganging hardware (2 sides).</p>			<p><b>OVERALL DIMENSIONS</b> W D H</p>			<p><b>SEAT DIMENSIONS</b> W D H</p>			<p><b>BACK DIMENSIONS</b> W H</p>		
<p>IN 57 29.5 41.5 42 19 18 51 24 MM 1448 749 1054 1067 483 457 1295 610</p>			<p><b>RTA 00</b> 1 per carton</p>											

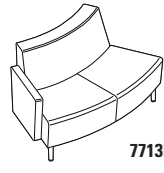
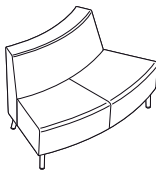
DESCRIPTION	FEATURES	MODEL#	STANDARD TEXTILE GRADES													
			1	2	3	4	5	6	7	8	9	10	11	12		
 <p><b>Armless IS Curve - Two Seater - High Back</b>                      COM: 6 YD   5.49 M                      Unit weight: 62 LB   28.2 KG                      Carton weight: 84 LB   38.1 KG                      Carton volume: 54 FT<sup>3</sup>   1.52 MT<sup>3</sup></p>	For power/USB unit please see electrical placement chart. Includes ganging hardware (2 sides).	<b>7711NA</b>	3185	3377	3539	3725	4031	4313	4595	4841	5147	5435	5825	6377		
			<b>OVERALL DIMENSIONS</b>			<b>SEAT DIMENSIONS</b>			<b>BACK DIMENSIONS</b>							
			<b>W</b>	<b>D</b>	<b>H</b>	<b>W</b>	<b>D</b>	<b>H</b>	<b>W</b>	<b>H</b>						
			IN 55 MM 1397	29.5 749	41.5 1054	42 1067	19 483	18 457	51 1295	24 610						
			<b>RTA 00</b>	1 per carton												
 <p><b>7712L (Left arm)</b></p>  <p><b>7712R (Right arm)</b></p> <p><b>IS Curve - Two Seater - Extended Back w/One Arm</b>                      COM: 7 YD   6.4 M                      Unit weight: 76 LB   34.5 KG                      Carton weight: 99 LB   44.91 KG                      Carton volume: 62.75 FT<sup>3</sup>   1.77 MT<sup>3</sup></p>	For power/USB unit please see electrical placement chart. Includes ganging hardware (2 sides).	<b>7712L</b> 7712R	3741	3965	4154	4371	4728	5057	5386	5673	6030	6366	6821	7465		
			<b>OVERALL DIMENSIONS</b>			<b>SEAT DIMENSIONS</b>			<b>BACK DIMENSIONS</b>							
			<b>W</b>	<b>D</b>	<b>H</b>	<b>W</b>	<b>D</b>	<b>H</b>	<b>W</b>	<b>H</b>						
			IN 57 MM 1448	29.5 749	47 1194	42 1067	19 483	18 457	51 1295	29 737						
			<b>RTA 00</b>	1 per carton												
 <p><b>Armless IS Curve - Two Seater - Extended Back</b>                      COM: 6.75 YD   6.17 M                      Unit weight: 66 LB   30 KG                      Carton weight: 89 LB   40.37 KG                      Carton volume: 62.75 FT<sup>3</sup>   1.77 MT<sup>3</sup></p>	For power/USB unit please see electrical placement chart. Includes ganging hardware (2 sides).	<b>7712NA</b>	3498	3714	3896	4106	4450	4767	5084	5361	5705	6029	6468	7089		
			<b>OVERALL DIMENSIONS</b>			<b>SEAT DIMENSIONS</b>			<b>BACK DIMENSIONS</b>							
			<b>W</b>	<b>D</b>	<b>H</b>	<b>W</b>	<b>D</b>	<b>H</b>	<b>W</b>	<b>H</b>						
			IN 55 MM 1397	29.5 749	47 1194	42 1067	19 483	18 457	51 1295	29 737						
			<b>RTA 00</b>	1 per carton												
 <p><b>7713L (Left arm)</b></p>  <p><b>7713R (Right arm)</b></p> <p><b>OS Curve - Two Seater - Standard Back w/One Arm</b>                      COM: 5.25 YD   4.8 M                      Unit weight: 62 LB   28.2 KG                      Carton weight: 82 LB   37.19 KG                      Carton volume: 43 FT<sup>3</sup>   1.21 MT<sup>3</sup></p>	For power/USB unit please see electrical placement chart. Includes ganging hardware (1 side).	<b>7713L</b> 7713R	2943	3111	3253	3416	3683	3930	4177	4392	4660	4912	5253	5736		
			<b>OVERALL DIMENSIONS</b>			<b>SEAT DIMENSIONS</b>			<b>BACK DIMENSIONS</b>							
			<b>W</b>	<b>D</b>	<b>H</b>	<b>W</b>	<b>D</b>	<b>H</b>	<b>W</b>	<b>H</b>						
			IN 54.5 MM 1384	29.5 749	32 813	48 1219	19 483	18 457	36 914	14 356						
			<b>RTA 00</b>	1 per carton												
 <p><b>Armless OS Curve - Two Seater - Standard Back</b>                      COM: 4.5 YD   4.11 M                      Unit weight: 52 LB   23.6 KG                      Carton weight: 72 LB   32.66 KG                      Carton volume: 43 FT<sup>3</sup>   1.21 MT<sup>3</sup></p>	For power/USB unit please see electrical placement chart. Includes ganging hardware (2 sides).	<b>7713NA</b>	2699	2843	2965	3104	3334	3545	3757	3941	4171	4387	4679	5093		
			<b>OVERALL DIMENSIONS</b>			<b>SEAT DIMENSIONS</b>			<b>BACK DIMENSIONS</b>							
			<b>W</b>	<b>D</b>	<b>H</b>	<b>W</b>	<b>D</b>	<b>H</b>	<b>W</b>	<b>H</b>						
			IN 54 MM 1372	29.5 749	32 813	48 1219	19 483	18 457	36 914	14 356						
			<b>RTA 00</b>	1 per carton												

DESCRIPTION	FEATURES	MODEL#	STANDARD TEXTILE GRADES											
			1	2	3	4	5	6	7	8	9	10	11	12
<p><b>7714L (Left arm)</b></p>	<p><b>7714R (Right arm)</b></p>	<p><b>7714L</b> 7714R</p>	1	2	3	4	5	6	7	8	9	10	11	12
			3486	3694	3870	4071	4403	4708	5014	5280	5612	5924	6346	6944
<p><b>OS Curve - Two Seater - High Back w/One Arm</b> COM: 6.5 YD   5.94 M Unit weight: 66 LB   30 KG Carton weight: 88 LB   39.92 KG Carton volume: 54 FT³   1.52 MT³</p>			<p>For power/USB unit please see electrical placement chart. Includes ganging hardware (1 side).</p>			<p><b>OVERALL DIMENSIONS</b> W D H</p>			<p><b>SEAT DIMENSIONS</b> W D H</p>			<p><b>BACK DIMENSIONS</b> W H</p>		
			IN	54.5	29.5	41.5	48	19	18		36	24		
			MM	1384	749	1054	1219	483	457		914	610		
			<b>RTA 00</b>	1 per carton										
		<p><b>7714NA</b></p>	1	2	3	4	5	6	7	8	9	10	11	12
			3242	3434	3596	3782	4088	4370	4652	4898	5204	5492	5882	6434
<p><b>Armless OS Curve - Two Seater - High Back</b> COM: 6.5 YD   5.94 M Unit weight: 56 LB   25.5 KG Carton weight: 78 LB   35.38 KG Carton volume: 54 FT³   1.52 MT³</p>			<p>For power/USB unit please see electrical placement chart. Includes ganging hardware (2 sides).</p>			<p><b>OVERALL DIMENSIONS</b> W D H</p>			<p><b>SEAT DIMENSIONS</b> W D H</p>			<p><b>BACK DIMENSIONS</b> W H</p>		
			IN	54	29.5	41.5	48	19	18		36	24		
			MM	1372	749	1054	1219	483	457		914	610		
			<b>RTA 00</b>	1 per carton										
<p><b>7715L (Left arm)</b></p>	<p><b>7715R (Right arm)</b></p>	<p><b>7715L</b> 7715R</p>	1	2	3	4	5	6	7	8	9	10	11	12
			3797	4021	4210	4427	4784	5113	5442	5729	6086	6422	6877	7521
<p><b>OS Curve - Two Seater - Extended Back w/One Arm</b> COM: 7 YD   6.4 M Unit weight: 70 LB   31.8 KG Carton weight: 93 LB   42.18 KG Carton volume: 62.75 FT³   1.77 MT³</p>			<p>For power/USB unit please see electrical placement chart. Includes ganging hardware (1 side).</p>			<p><b>OVERALL DIMENSIONS</b> W D H</p>			<p><b>SEAT DIMENSIONS</b> W D H</p>			<p><b>BACK DIMENSIONS</b> W H</p>		
			IN	54.5	29.5	47	48	19	18		36	29		
			MM	1384	749	1194	1219	483	457		914	737		
			<b>RTA 00</b>	1 per carton										
		<p><b>7715NA</b></p>	1	2	3	4	5	6	7	8	9	10	11	12
			3553	3769	3951	4161	4505	4822	5139	5416	5760	6084	6523	7144
<p><b>Armless OS Curve - Two Seater - Ext. High Back</b> COM: 6.75 YD   6.17 M Unit weight: 60 LB   27.3 KG Carton weight: 83 LB   37.65 KG Carton volume: 62.75 FT³   1.77 MT³</p>			<p>For power/USB unit please see electrical placement chart. Includes ganging hardware (2 sides).</p>			<p><b>OVERALL DIMENSIONS</b> W D H</p>			<p><b>SEAT DIMENSIONS</b> W D H</p>			<p><b>BACK DIMENSIONS</b> W H</p>		
			IN	54	29.5	47	48	19	18		36	29		
			MM	1372	749	1194	1219	483	457		914	737		
			<b>RTA 00</b>	1 per carton										
		<p><b>7716</b></p>	1	2	3	4	5	6	7	8	9	10	11	12
			3676	3852	4001	4171	4452	4710	4969	5194	5475	5739	6096	6602
<p><b>Armless Corner Unit - Standard Back</b> COM: 5.5 YD   5.03 M Unit weight: 55 LB   25 KG Carton weight: 75 LB   34.02 KG Carton volume: 49 FT³   1.38 MT³</p>			<p>For power/USB unit please see electrical placement chart. Includes ganging hardware (2 sides).</p>			<p><b>OVERALL DIMENSIONS</b> W D H</p>			<p><b>SEAT DIMENSIONS</b> W D H</p>			<p><b>BACK DIMENSIONS</b> W H</p>		
			IN	38	38	32	24	19	18		24	14		
			MM	965	965	813	610	483	457		610	356		
			<b>RTA 00</b>	1 per carton										

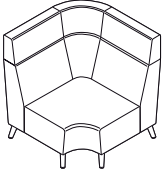
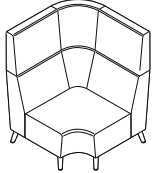
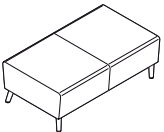
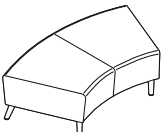
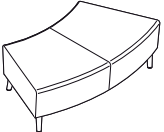
DESCRIPTION	FEATURES	MODEL#	STANDARD TEXTILE GRADES											
			1	2	3	4	5	6	7	8	9	10	11	12
 <p><b>Armless Corner Unit - High Back</b>                      COM: 7.75 YD   7.09 M                      Unit weight: 60 LB   27.3 KG                      Carton weight: 82 LB   37.19 KG                      Carton volume: 49 FT<sup>3</sup>   1.38 MT<sup>3</sup></p>	For power/USB unit please see electrical placement chart. Includes ganging hardware (2 sides).	<b>7717</b>	4666	4914	5123	5364	5759	6123	6487	6805	7200	7572	8076	8789
			<b>OVERALL DIMENSIONS</b>			<b>SEAT DIMENSIONS</b>			<b>BACK DIMENSIONS</b>					
			<b>W</b>	<b>D</b>	<b>H</b>	<b>W</b>	<b>D</b>	<b>H</b>	<b>W</b>	<b>H</b>				
			IN 38	38	41.5	24	19	18	24	24				
			MM 965	965	1054	610	483	457	610	610				
			<b>RTA 00</b>	1 per carton										
 <p><b>Armless Corner Unit - Extended Back</b>                      COM: 8.5 YD   7.77 M                      Unit weight: 65 LB   29.5 KG                      Carton weight: 88 LB   39.92 KG                      Carton volume: 49 FT<sup>3</sup>   1.38 MT<sup>3</sup></p>	For power/USB unit please see electrical placement chart. Includes ganging hardware (2 sides).	<b>7718</b>	5181	5453	5683	5946	6380	6779	7179	7527	7961	8369	8921	9703
			<b>OVERALL DIMENSIONS</b>			<b>SEAT DIMENSIONS</b>			<b>BACK DIMENSIONS</b>					
			<b>W</b>	<b>D</b>	<b>H</b>	<b>W</b>	<b>D</b>	<b>H</b>	<b>W</b>	<b>H</b>				
			IN 38	38	47	24	19	18	24	29				
			MM 965	965	1194	610	483	457	610	737				
			<b>RTA 00</b>	1 per carton										
 <p><b>Two Seater Bench</b>                      COM: 2.25 YD   2.06 M                      Unit weight: 31 LB   14.1 KG                      Carton weight: 41 LB   18.6 KG                      Carton volume: 21.25 FT<sup>3</sup>   0.6 MT<sup>3</sup></p>	For power/USB unit please see electrical placement chart. Includes ganging hardware (2 sides).	<b>7725</b>	1796	1868	1929	1999	2113	2219	2325	2417	2532	2640	2786	2993
			<b>OVERALL DIMENSIONS</b>			<b>SEAT DIMENSIONS</b>			<b>BACK DIMENSIONS</b>					
			<b>W</b>	<b>D</b>	<b>H</b>	<b>W</b>	<b>D</b>	<b>H</b>	<b>W</b>	<b>H</b>				
			IN 48.5	28	17.5	-	-	-	-	-				
			MM 1232	711	445	-	-	-	-	-				
			<b>RTA 00</b>	1 per carton										
 <p><b>IS Curve - Two Seater Bench</b>                      COM: 3 YD   2.74 M                      Unit weight: 31 LB   14.1 KG                      Carton weight: 41 LB   18.6 KG                      Carton volume: 21.25 FT<sup>3</sup>   0.6 MT<sup>3</sup></p>	For power/USB unit please see electrical placement chart. Includes ganging hardware (2 sides).	<b>7726</b>	2609	2705	2786	2879	3032	3173	3314	3437	3590	3734	3929	4205
			<b>OVERALL DIMENSIONS</b>			<b>SEAT DIMENSIONS</b>			<b>BACK DIMENSIONS</b>					
			<b>W</b>	<b>D</b>	<b>H</b>	<b>W</b>	<b>D</b>	<b>H</b>	<b>W</b>	<b>H</b>				
			IN 54	28	17.5	-	-	-	-	-				
			MM 1372	711	445	-	-	-	-	-				
			<b>RTA 00</b>	1 per carton										
 <p><b>OS Curve - Two Seater Bench</b>                      COM: 3 YD   2.74 M                      Unit weight: 31 LB   14.1 KG                      Carton weight: 41 LB   18.6 KG                      Carton volume: 21.25 FT<sup>3</sup>   0.6 MT<sup>3</sup></p>	For power/USB unit please see electrical placement chart. Includes ganging hardware (2 sides).	<b>7727</b>	2597	2693	2774	2867	3020	3161	3302	3425	3578	3722	3917	4193
			<b>OVERALL DIMENSIONS</b>			<b>SEAT DIMENSIONS</b>			<b>BACK DIMENSIONS</b>					
			<b>W</b>	<b>D</b>	<b>H</b>	<b>W</b>	<b>D</b>	<b>H</b>	<b>W</b>	<b>H</b>				
			IN 54	28	17.5	-	-	-	-	-				
			MM 1372	711	445	-	-	-	-	-				
			<b>RTA 00</b>	1 per carton										

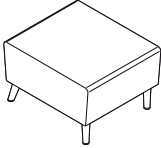
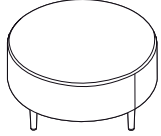
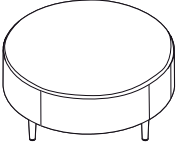
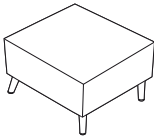
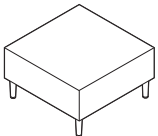
DESCRIPTION	FEATURES	MODEL#	STANDARD TEXTILE GRADES											
			1	2	3	4	5	6	7	8	9	10	11	12
 <p><b>Square Single Seater Bench</b> COM: 1.75 YD   1.6 M Unit weight: 25 LB   11.4 KG Carton weight: 30 LB   13.61 KG Carton volume: 9.25 FT³   0.26 MT³</p>	<p>For power/USB unit please see electrical placement chart. Includes ganging hardware (2 sides).</p>	<b>7728</b>	1157	1213	1260	1315	1404	1486	1568	1640	1729	1813	1927	2088
			<b>OVERALL DIMENSIONS</b>			<b>SEAT DIMENSIONS</b>			<b>BACK DIMENSIONS</b>					
			<b>W</b>	<b>D</b>	<b>H</b>	<b>W</b>	<b>D</b>	<b>H</b>	<b>W</b>	<b>H</b>				
			IN 24.5	28	17.5	-	-	-	-	-				
			MM 622	711	445	-	-	-	-	-				
		<b>RTA 00</b>	1 per carton											
 <p><b>36" Dia. - Round Bench</b> COM: 3 YD   2.74 M Unit weight: 41 LB   18.6 KG Carton weight: 46 LB   20.87 KG Carton volume: 18.25 FT³   0.51 MT³</p>	<p>No power/USB unit. Freestanding unit only.</p>	<b>7729</b>	1546	1642	1723	1816	1969	2110	2251	2374	2527	2671	2866	3142
			<b>OVERALL DIMENSIONS</b>			<b>SEAT DIMENSIONS</b>			<b>BACK DIMENSIONS</b>					
			<b>W</b>	<b>D</b>	<b>H</b>	<b>W</b>	<b>D</b>	<b>H</b>	<b>W</b>	<b>H</b>				
			IN 36	36	17.5	-	-	-	-	-				
			MM 914	914	445	-	-	-	-	-				
		<b>RTA 00</b>	1 per carton											
 <p><b>42" Dia. - Round Bench</b> COM: 3.25 YD   2.97 M Unit weight: 45 LB   20.5 KG Carton weight: 50 LB   22.68 KG Carton volume: 22 FT³   0.62 MT³</p>	<p>No power/USB unit. Freestanding unit only.</p>	<b>7730</b>	1813	1917	2005	2106	2271	2424	2577	2710	2876	3032	3243	3542
			<b>OVERALL DIMENSIONS</b>			<b>SEAT DIMENSIONS</b>			<b>BACK DIMENSIONS</b>					
			<b>W</b>	<b>D</b>	<b>H</b>	<b>W</b>	<b>D</b>	<b>H</b>	<b>W</b>	<b>H</b>				
			IN 42	42	17.5	-	-	-	-	-				
			MM 1067	1067	445	-	-	-	-	-				
		<b>RTA 00</b>	1 per carton											
 <p><b>30" Square Laminate Coffee Table</b> COM: N/A Unit weight: 48 LB   21.8 KG Carton weight: 61 LB   27.67 KG Carton volume: 11.5 FT³   0.32 MT³</p>	<p>For power/USB unit please see electrical placement chart. Freestanding unit only.</p>	<b>7731</b>	List price											
			1392											
			<b>OVERALL DIMENSIONS</b>			<b>SEAT DIMENSIONS</b>			<b>BACK DIMENSIONS</b>					
			<b>W</b>	<b>D</b>	<b>H</b>	<b>W</b>	<b>D</b>	<b>H</b>	<b>W</b>	<b>H</b>				
			IN 30	30	17	-	-	-	-	-				
MM 762	762	432	-	-	-	-	-							
		<b>RTA 00</b>	1 per carton											
 <p><b>36" Square Laminate Coffee Table</b> COM: N/A Unit weight: 70 LB   31.8 KG Carton weight: 85 LB   38.56 KG Carton volume: 16.5 FT³   0.46 MT³</p>	<p>For Power/USB unit please see electrical placement chart. Freestanding unit only.</p>	<b>7732</b>	List price											
			1582											
			<b>OVERALL DIMENSIONS</b>			<b>SEAT DIMENSIONS</b>			<b>BACK DIMENSIONS</b>					
			<b>W</b>	<b>D</b>	<b>H</b>	<b>W</b>	<b>D</b>	<b>H</b>	<b>W</b>	<b>H</b>				
			IN 36	36	17	-	-	-	-	-				
MM 914	914	432	-	-	-	-	-							
		<b>RTA 00</b>	1 per carton											

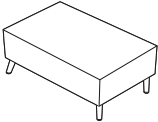
DESCRIPTION	FEATURES	MODEL#	STANDARD TEXTILE GRADES						
 <p><b>Rectangular Laminate Coffee Table</b> COM: N/A Unit weight: 50 LB   22.7 KG Carton weight: 55 LB   24.95 KG Carton volume: 11.5 FT<sup>3</sup>   0.32 MT<sup>3</sup></p>	<p>For power/USB unit please see electrical placement chart.</p> <p>Freestanding unit only.</p>	List price							
		7733	1400						
		<b>OVERALL DIMENSIONS</b>			<b>SEAT DIMENSIONS</b>			<b>BACK DIMENSIONS</b>	
		IN	40	20	17	-	-	-	-
MM	1016	508	432	-	-	-	-		
				<b>RTA 00</b>	1 per carton				
	<p>For power/USB unit please see electrical placement chart.</p> <p>Freestanding unit only.</p>	List price							
		7734	1729						
		<b>OVERALL DIMENSIONS</b>			<b>SEAT DIMENSIONS</b>			<b>BACK DIMENSIONS</b>	
		IN	36	36	17	-	-	-	-
MM	914	914	432	-	-	-	-		
				<b>RTA 00</b>	1 per carton				
	<p>For power/USB unit please see electrical placement chart.</p> <p>Freestanding unit only.</p>	List price							
		7735	1889						
		<b>OVERALL DIMENSIONS</b>			<b>SEAT DIMENSIONS</b>			<b>BACK DIMENSIONS</b>	
		IN	42	42	17	-	-	-	-
MM	1067	1067	432	-	-	-	-		
				<b>RTA 00</b>	1 per carton				
	<p>For power/USB unit please see electrical placement chart.</p> <p>Freestanding unit only.</p>	List price							
		7736	1223						
		<b>OVERALL DIMENSIONS</b>			<b>SEAT DIMENSIONS</b>			<b>BACK DIMENSIONS</b>	
		IN	36	18	17	-	-	-	-
MM	914	457	432	-	-	-	-		
				<b>RTA 00</b>	1 per carton				
	<p>For power/USB unit please see electrical placement chart.</p> <p>Freestanding unit only.</p>	List price							
		7737	1483						
		<b>OVERALL DIMENSIONS</b>			<b>SEAT DIMENSIONS</b>			<b>BACK DIMENSIONS</b>	
		IN	42	21	17	-	-	-	-
MM	1067	533	432	-	-	-	-		
				<b>RTA 00</b>	1 per carton				

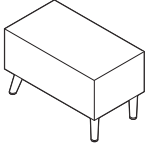
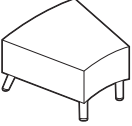
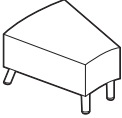
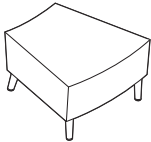
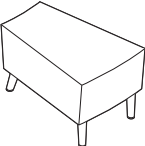

DESCRIPTION	FEATURES	MODEL#	STANDARD TEXTILE GRADES							
 <p><b>Rectangular Laminate End Table</b> COM: N/A Unit weight: 28 LB   12.7 KG Carton weight: 34 LB   15.42 KG Carton volume: 5.5 FT<sup>3</sup>   0.15 MT<sup>3</sup></p>	<p>For power/USB unit please see electrical placement chart.</p> <p>Includes ganging hardware (2 sides).</p>	<p><b>7738</b></p>	List price							
			1401							
			OVERALL DIMENSIONS			SEAT DIMENSIONS			BACK DIMENSIONS	
			W	D	H	W	D	H	W	H
IN 15	27.25	17	-	-	-	-	-			
MM 381	692	432	-	-	-	-	-			
		<b>RTA 00</b>	1 per carton							
 <p><b>IS Curve Wide Wedge Laminate End Table</b> COM: N/A Unit weight: 40 LB   18.2 KG Carton weight: 50 LB   22.68 KG Carton volume: 9.5 FT<sup>3</sup>   0.26 MT<sup>3</sup></p>	<p>For power/USB unit please see electrical placement chart.</p> <p>Includes ganging hardware (2 sides).</p>	<p><b>7739</b></p>	List price							
			1850							
			OVERALL DIMENSIONS			SEAT DIMENSIONS			BACK DIMENSIONS	
			W	D	H	W	D	H	W	H
IN 27.25	27.25	17	-	-	-	-	-			
MM 692	692	432	-	-	-	-	-			
		<b>RTA 00</b>	1 per carton							
 <p><b>IS Curve Narrow Wedge Laminate End Table</b> COM: N/A Unit weight: 28 LB   12.7 KG Carton weight: 34 LB   15.42 KG Carton volume: 6.5 FT<sup>3</sup>   0.18 MT<sup>3</sup></p>	<p>For power/USB unit please see electrical placement chart.</p> <p>Includes ganging hardware (2 sides).</p>	<p><b>7740</b></p>	List price							
			1499							
			OVERALL DIMENSIONS			SEAT DIMENSIONS			BACK DIMENSIONS	
			W	D	H	W	D	H	W	H
IN 18.25	27.25	17	-	-	-	-	-			
MM 464	692	432	-	-	-	-	-			
		<b>RTA 00</b>	1 per carton							
 <p><b>OS Curve - Wide Wedge Laminate End Table</b> COM: N/A Unit weight: 40 LB   18.2 KG Carton weight: 50 LB   22.68 KG Carton volume: 9.5 FT<sup>3</sup>   0.26 MT<sup>3</sup></p>	<p>For power/USB unit please see electrical placement chart.</p> <p>Includes ganging hardware (2 sides).</p>	<p><b>7741</b></p>	List price							
			1850							
			OVERALL DIMENSIONS			SEAT DIMENSIONS			BACK DIMENSIONS	
			W	D	H	W	D	H	W	H
IN 27.25	27.25	17	-	-	-	-	-			
MM 692	692	432	-	-	-	-	-			
		<b>RTA 00</b>	1 per carton							
 <p><b>OS Curve - Narrow Wedge Laminate End Table</b> COM: N/A Unit weight: 28 LB   12.7 KG Carton weight: 34 LB   15.42 KG Carton volume: 6.5 FT<sup>3</sup>   0.18 MT<sup>3</sup></p>	<p>For power/USB unit please see electrical placement chart.</p> <p>Includes ganging hardware (2 sides).</p>	<p><b>7742</b></p>	List price							
			1499							
			OVERALL DIMENSIONS			SEAT DIMENSIONS			BACK DIMENSIONS	
			W	D	H	W	D	H	W	H
IN 18.25	27.25	17	-	-	-	-	-			
MM 464	692	432	-	-	-	-	-			
		<b>RTA 00</b>	1 per carton							

DESCRIPTION	FEATURES	MODEL#	STANDARD TEXTILE GRADES												
	<p><b>18" Round Laminate Laptop Table w/14" Base</b>                      COM: N/A                      Unit weight: 22 LB   10 KG                      Carton weight: 32 LB   14.51 KG                      Carton volume: 6 FT³   0.16 MT³</p>	<p>No power/USB unit.</p>	List price												
			7743	1063											
			OVERALL DIMENSIONS			SEAT DIMENSIONS			BACK DIMENSIONS						
			W	D	H	W	D	H	W	H					
IN 18	18	25.25	-	-	-	-	-								
MM 457	457	641	-	-	-	-	-								
			1 per carton												
	<p><b>16" Square Laminate Laptop Table w/14" Base</b>                      COM: N/A                      Unit weight: 26 LB   11.8 KG                      Carton weight: 36 LB   16.33 KG                      Carton volume: 6 FT³   0.16 MT³</p>	<p>No power/USB unit.</p>	List price												
			7745	1035											
			OVERALL DIMENSIONS			SEAT DIMENSIONS			BACK DIMENSIONS						
			W	D	H	W	D	H	W	H					
IN 16	16	25.25	-	-	-	-	-								
MM 406	406	641	-	-	-	-	-								
		1 per carton													
	<p><b>Personal Harbor - Standard Back</b>                      COM: 5.5 YD   5.03 M                      Unit weight: 70 LB   31.8 KG                      Carton weight: 85 LB   38.56 KG                      Carton volume: 31.75 FT³   0.89 MT³</p>	<p>For power/USB unit please see electrical placement chart. Freestanding unit only.</p>													
			7746	3124	3300	3449	3619	3900	4158	4417	4642	4923	5187	5544	6050
			7786*	3568	3744	3893	4063	4344	4602	4861	5086	5367	5631	5988	6494
			OVERALL DIMENSIONS			SEAT DIMENSIONS			BACK DIMENSIONS						
W	D	H	W	D	H	W	H								
IN 45	29.5	32	24	19	18	27	14								
MM 1143	749	813	610	483	457	686	356								
		1 per carton													
	<p><b>Personal Harbor - High Back</b>                      COM: 7.75 YD   7.09 M                      Unit weight: 86 LB   39.1 KG                      Carton weight: 101 LB   45.81 KG                      Carton volume: 40.25 FT³   1.13 MT³</p>	<p>For power/USB unit please see electrical placement chart. Freestanding unit only.</p>													
			7747	4397	4645	4854	5095	5490	5854	6218	6536	6931	7303	7807	8520
			7787*	4970	5218	5427	5668	6063	6427	6791	7109	7504	7876	8380	9093
			OVERALL DIMENSIONS			SEAT DIMENSIONS			BACK DIMENSIONS						
W	D	H	W	D	H	W	H								
IN 45	29.5	41.5	24	19	18	27	24								
MM 1143	749	1054	610	483	457	686	610								
		1 per carton													
	<p><b>Personal Harbor - Extended Back</b>                      COM: 8.5 YD   7.77 M                      Unit weight: 102 LB   46.4 KG                      Carton weight: 117 LB   53.07 KG                      Carton volume: 45.75 FT³   1.29 MT³</p>	<p>For power/USB unit please see electrical placement chart. Freestanding unit only.</p>													
			7748	4946	5218	5448	5711	6145	6544	6944	7292	7726	8134	8686	9468
			7788*	5389	5661	5891	6154	6588	6987	7387	7735	8169	8577	9129	9911
			OVERALL DIMENSIONS			SEAT DIMENSIONS			BACK DIMENSIONS						
W	D	H	W	D	H	W	H								
IN 45	29.5	47	24	19	18	27	29								
MM 1143	749	1194	610	483	457	686	737								
		1 per carton													

RIVER+ SEATING



model R27802

model R27824S

River+ Benches & Tables



For River+ benches, please see page 291.

For River+ tables, please see page 296.

EXAMPLE RIVER+ SEATING ORDER CODE:

R27802	-NS	-CE90	-NS	-CE90	-	-FO
Model number	Sealed Seams (back)	Back textile	Sealed seams (seat)	Seat textile	Shelf finish	Connector finish
-CHM	-S6	-NC				
Leg finish	Leg selection	Additional weight				

Additional Options specify at end of order code.	SPECIFY CODE
<b>Additional weight</b> See each model for amount of added weight and upcharge. For models ending in S, applies only to leg selection (S6).	<b>CW</b>
<b>Bottom selection</b> Black lining (standard) Vinyl sealed bottom w/staple strip. Upcharges vary, see model.* Steel bottom. Upcharges vary, see model.**	<b>SB</b> <b>SU</b> <b>BS</b>
<b>Power unit finish</b> Jet Black White	<b>J</b> <b>W</b>
<b>Power/USB unit position</b> (see electrical placement images, not available on corner units) Front left Front right Side left Side right <b>Power/USB unit position</b> (models with shelf only) Center back	\$717 per unit <b>F1</b> <b>F2</b> <b>S1</b> <b>S2</b> <b>CB</b>
<b>Tamperproof fasteners</b> Upcharges vary, see model.	<b>TP</b>
<b>Moisture barrier</b> Upcharges vary, see model.	<b>MB</b>
<b>Accessory hook finish</b> (for models with shelf) Night. No Upcharge. Fog. No Upcharge. Latte. No Upcharge.	<b>BK</b> <b>FO</b> <b>LB</b>

\*linking hardware is lowered to clear the staple strip. Units will only gang with other units with sealed bottom.  
\*\*cannot be combined with linking hardware or power units

STANDARD FEATURES

- A modular series that is composed of straight, curved and corner sections.
- Same seat height units with no upholstered arms can be linked together to create a variety of layouts. Ganging hardware is standard (factory installed) and swivels out of the way when not in use.
- The unique tapered legs are made of welded steel, with each leg bolted directly to the unit frame. Standard leg height is 6.5". The leg height makes it easy to clean under the product.
- Legs are standard in Chrome (CHM) with Black nylon non-marking height adjustable glides.
- Modular, aluminum loop arms are sold separately (with or without nylon armcaps). These relocatable arms are field installed at any seat to back connector.
- Seating frames are heavy duty with interlocking plywood, puzzle box construction, and are made for active environments. Seats are high density with highly resilient foam.
- Seat to back connector components join back and seat; maintaining offset for cleanout. Connector is available in three finishes.
- All River+ seating models meet or exceed the applicable ANSI/BIFMA standards and are backed by Global's Heavy Duty warranty.
- River+ seating is rated for an active weight up to 600 lbs. per seat and 24/7 use.
- For heavy duty application, Global's Limited Lifetime Warranty is applicable only on fabrics that are rated for 100,000+ double rubs.
- Upholstery options: fabric, vinyl or leather. Leather only recommended on seat and may feature a horizontal stitch detail.
- All units are shipped fully assembled.

OPTIONAL FEATURES

- To add sealed seams to your product, please specify (S2), (SE) - see each model for upcharges.
- A 10" deep, 1" thick back shelf is available on two and three seater units, as well as select corner units, in many low pressure laminate finishes. Shelf supports are aluminum with accessory hook in three finishes. Weight capacity: Shelf - 50 lbs. per seat; Hook - 20 lbs. each.
- Units with shelf available with 6.5" leg. Back legs on these models are (E6) extended legs, as standard.
- To specify tapered legs on shelf models to match models without shelf, select (C6) leg with counterweight. Available on models ending in "S". Upcharges vary.
- Floor mount legs are available. Please specify (F6). Models with shelf will have extended legs. Fastening hardware not included.
- Products can be weighted to reduce the ease of movement. For additional weight options, please specify (CW) - see each model for available additional weight and upcharge.
- Underside of seat is standard with black lining (SB). For improved housekeeping and infection control practices, the underside of the seat can be finished with PVC (vinyl) and sealed to prevent penetration of liquids. Please specify (SU) - see each model for upcharge.
- Steel bottom provides tamperproof protection (includes tamperproof screws). Please specify (BS) - see each model for upcharge. Note: electrical option and ganging are not available with steel bottom.
- Most seating (except corner units) can be specified with power/USB units, which include one power outlet, one double USB terminal with a matching 120" three-prong power cord.
- Power/USB units can be specified in a variety predetermined locations, as shown in the electrical illustrations. Electrical units must be factory installed.

- Power/USB units are available with either Jet Black (J) face plate with Black power/USB receptacles or with a White (W) face plate with White power/USB receptacles.
- Tamperproof fasteners can be requested for a higher level of safety (ganging brackets are not included). Please specify (TP) - see each model for upcharge.
- For moisture barrier on seat, please specify (MB) - see each model for upcharge.

Please add option codes in the following order:

- **Model number**  
R27801 to R27803 Lounge chairs  
R27804 to R27806 Two seaters  
R27807 to R27809 Three seaters  
R27810 to R27812 Bariatric lounge chairs  
R27815 to R27817 Inside curve two seaters  
R27818 to R27820 Outside curve two seaters  
R27821 to R27823 90 degree corners  
R27824 to R27826 120 degree corners  
- Add (S) to model # if ordering with a back shelf (excludes lounge chairs and bariatric models).
- **Back + upholstered arms sealed seams (NS)** Standard seams.  
(S2) Back sealed seams. Upcharges vary, see model.
- **Back + upholstered arms textile** Specify textile code.
- **Seat sealed seams (NS)** Standard seams.  
(SE) Seat sealed seams. Upcharges vary, see model.
- **Seat textile** Specify textile code.
- **Back shelf finish** (for models ending in S) (colors shown on website)  
(ACJ) Absolute Acajou (FCL) First Class  
(ASN) Asian Night (NBL) Noce Biondo  
(AWC) Avant Cherry (NGL) Noce Grigio  
(AWH) Avant Honey (NEL) Noce Leggero  
(BLK) Black (NML) Noce Medio  
(BZD) Blizzard (OTM) Quartered Mahogany  
(BRC) Brushed Cobalt (SBY) Sheer Beauty  
(CMB) Clear Maple (SDT) Stonedust  
(CGY) Custom Grey (SOG) Storm Grey  
(DES) Dark Espresso (WHE) Walnut Heights  
(DWT) Designer White (WHC) White Chocolate  
(FAS) Fashionista (WCR) Winter Cherry
- **Seat to back connector finish**  
(BK) Night. No upcharge.  
(FO) Fog. No upcharge.  
(LB) Latte. No upcharge.
- **Leg finish**  
For leg finish options, please see page 360. No upcharges.
- **Leg selection** (models without shelf)  
(S6) Standard seat height (17.5"), 6.5" leg w/ adjustable glides. No upcharge.  
(S8) High seat (19"), 8" leg w/adjustable glides. No upcharge.  
(F6) Standard seat height (17.5"), 6.5" leg w/floor mount. Add \$90 for straight units; \$113 for curved, corner units.  
(F8) High seat (19"), 8" leg w/floor mount. Add \$90 for straight units; \$113 for curved, corner units.
- **Leg selection** (models with shelf)  
(E6) Standard seat height (17.5"), 6.5" extended leg w/adjustable glides.  
(F6) Standard seat height (17.5"), 6.5" extended leg w/floor mount. Add \$90 for straight units; \$113 for curved, corner units.  
(C6) Standard seat height (17.5"), 6.5" leg w/adjustable glides and counterweight. Upcharges vary, see model.
- **Additional weight** (not available on all models)  
(NC) No added weight. No upcharge.  
(CW) Counterweight. See each model for weight added and upcharge.

SHELF HEIGHTS

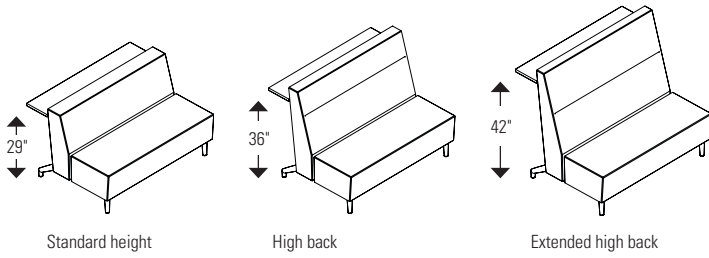

DIMENSIONS

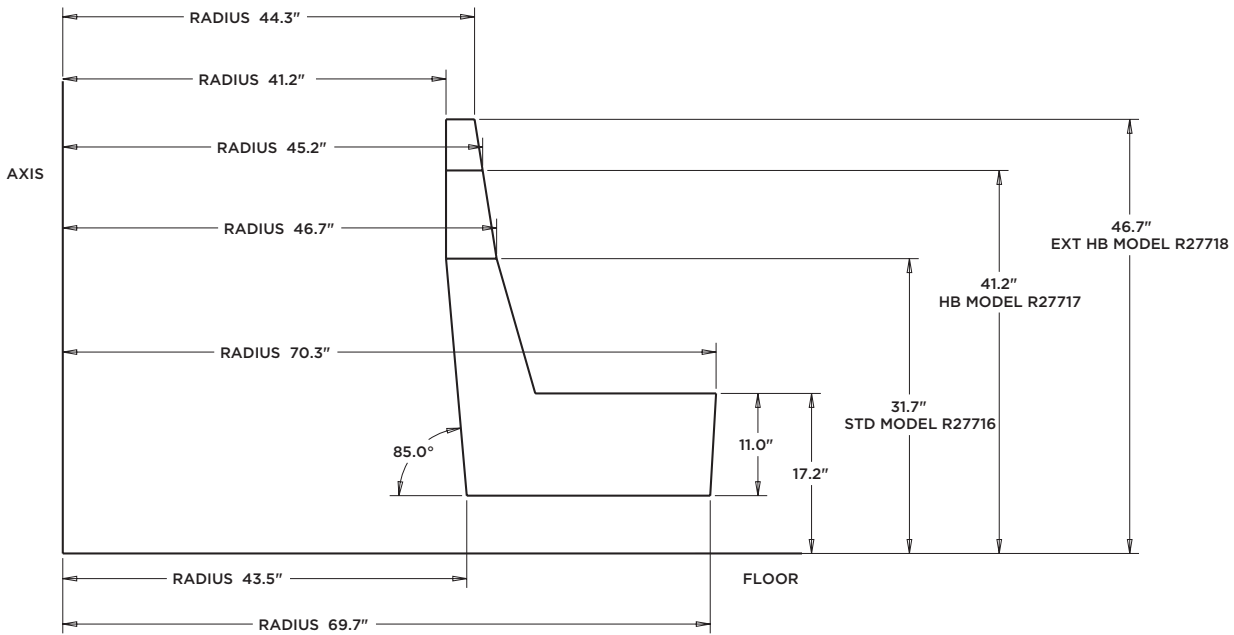

ELECTRICAL PLACEMENT

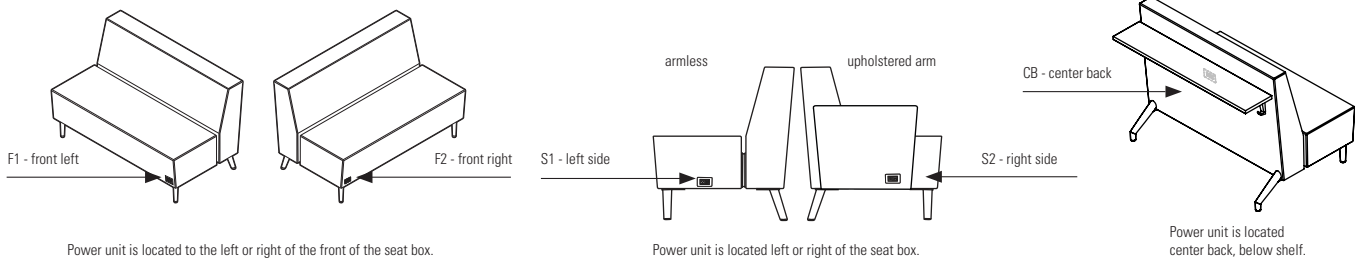

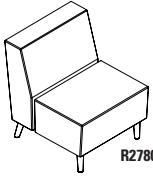
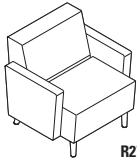
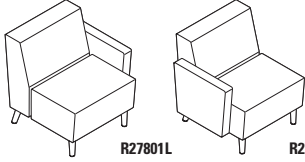
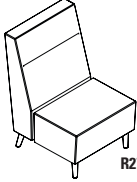
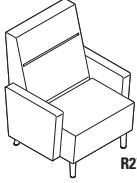
DESCRIPTION	FEATURES	MODEL#	STANDARD TEXTILE GRADES																													
			1	2	3	4	5	6	7	8	9	10	11	12																		
 <p><b>R27801</b></p> <p><b>Lounge Chair - Standard Back</b> COM: 3.75 YD   3.43 M Unit weight: 47 LB   21.4 KG Carton weight: 61 LB   27.67 KG Carton volume: 19.75 FT<sup>3</sup>   0.55 MT<sup>3</sup></p>	<p>For power/USB unit, please see electrical placement chart.</p> <p>Includes ganging hardware (2 sides).</p> <p>Add \$52, \$46 for <b>(S2)</b>, <b>(SE)</b> Add \$533 for 36 lbs. <b>(CW)</b> Add \$59 for <b>(SU)</b> or \$298 for <b>(BS)</b> Add \$28 for <b>(TP)</b> Add \$81 for <b>(MB)</b></p>	<b>R27801</b>	1691	1811	1912	2029	2220	2396	2572	2726	2917	3097	3341	3686																		
		<table border="1"> <thead> <tr> <th colspan="3">OVERALL DIMENSIONS</th> <th colspan="3">SEAT DIMENSIONS</th> <th colspan="2">BACK DIMENSIONS</th> </tr> <tr> <th>W</th> <th>D</th> <th>H</th> <th>W</th> <th>D</th> <th>H</th> <th>W</th> <th>H</th> </tr> </thead> <tbody> <tr> <td>IN 26</td> <td>30</td> <td>32</td> <td>26</td> <td>19</td> <td>18</td> <td>26</td> <td>14</td> </tr> <tr> <td>MM 660</td> <td>762</td> <td>813</td> <td>660</td> <td>483</td> <td>457</td> <td>660</td> <td>356</td> </tr> </tbody> </table> <p><b>RTA 00</b> 1 per carton</p>	OVERALL DIMENSIONS			SEAT DIMENSIONS			BACK DIMENSIONS		W	D	H	W	D	H	W	H	IN 26	30	32	26	19	18	26	14	MM 660	762	813	660	483	457
OVERALL DIMENSIONS			SEAT DIMENSIONS			BACK DIMENSIONS																										
W	D	H	W	D	H	W	H																									
IN 26	30	32	26	19	18	26	14																									
MM 660	762	813	660	483	457	660	356																									
 <p><b>R27801B</b></p> <p><b>Lounge Chair - Standard Back w/Uph Arms</b> COM: 5.75 YD   5.26 M Unit weight: 67 LB   30.5 KG Carton weight: 82 LB   37.19 KG Carton volume: 24.5 FT<sup>3</sup>   0.69 MT<sup>3</sup></p>	<p>For power/USB unit, please see electrical placement chart.</p> <p>Ganging not available.</p> <p>Add \$91, \$46 for <b>(S2)</b>, <b>(SE)</b> Add \$533 for 36 lbs. <b>(CW)</b> Add \$57 for <b>(SU)</b> or \$285 for <b>(BS)</b> Add \$28 for <b>(TP)</b> Add \$77 for <b>(MB)</b></p>	<b>R27801B</b>	2285	2469	2624	2803	3096	3366	3636	3872	4165	4441	4815	5344																		
		<table border="1"> <thead> <tr> <th colspan="3">OVERALL DIMENSIONS</th> <th colspan="3">SEAT DIMENSIONS</th> <th colspan="2">BACK DIMENSIONS</th> </tr> <tr> <th>W</th> <th>D</th> <th>H</th> <th>W</th> <th>D</th> <th>H</th> <th>W</th> <th>H</th> </tr> </thead> <tbody> <tr> <td>IN 33</td> <td>30</td> <td>32</td> <td>26</td> <td>19</td> <td>18</td> <td>26</td> <td>14</td> </tr> <tr> <td>MM 838</td> <td>762</td> <td>813</td> <td>660</td> <td>483</td> <td>457</td> <td>660</td> <td>356</td> </tr> </tbody> </table> <p><b>RTA 00</b> 1 per carton</p>	OVERALL DIMENSIONS			SEAT DIMENSIONS			BACK DIMENSIONS		W	D	H	W	D	H	W	H	IN 33	30	32	26	19	18	26	14	MM 838	762	813	660	483	457
OVERALL DIMENSIONS			SEAT DIMENSIONS			BACK DIMENSIONS																										
W	D	H	W	D	H	W	H																									
IN 33	30	32	26	19	18	26	14																									
MM 838	762	813	660	483	457	660	356																									
 <p><b>R27801L</b>      <b>R27801R</b></p> <p><b>Lounge Chair - Standard Back w/Uph Arms (Left/Right)</b> COM: 4.75 YD   4.34 M Unit weight: 57 LB   25.9 KG Carton weight: 72 LB   32.66 KG Carton volume: 24.5 FT<sup>3</sup>   0.69 MT<sup>3</sup></p>	<p>For power/USB unit, please see electrical placement chart.</p> <p>Includes ganging hardware (1 side only).</p> <p>Add \$71, \$46 for <b>(S2)</b>, <b>(SE)</b> Add \$533 for 36 lbs. <b>(CW)</b> Add \$57 for <b>(SU)</b> or \$285 for <b>(BS)</b> Add \$28 for <b>(TP)</b> Add \$77 for <b>(MB)</b></p>	<b>R27801L</b> <b>R27801R</b>	1988	2140	2268	2416	2658	2881	3104	3299	3541	3769	4078	4515																		
		<table border="1"> <thead> <tr> <th colspan="3">OVERALL DIMENSIONS</th> <th colspan="3">SEAT DIMENSIONS</th> <th colspan="2">BACK DIMENSIONS</th> </tr> <tr> <th>W</th> <th>D</th> <th>H</th> <th>W</th> <th>D</th> <th>H</th> <th>W</th> <th>H</th> </tr> </thead> <tbody> <tr> <td>IN 29.5</td> <td>30</td> <td>32</td> <td>26</td> <td>19</td> <td>18</td> <td>26</td> <td>14</td> </tr> <tr> <td>MM 749</td> <td>762</td> <td>813</td> <td>660</td> <td>483</td> <td>457</td> <td>660</td> <td>356</td> </tr> </tbody> </table> <p><b>RTA 00</b> 1 per carton</p>	OVERALL DIMENSIONS			SEAT DIMENSIONS			BACK DIMENSIONS		W	D	H	W	D	H	W	H	IN 29.5	30	32	26	19	18	26	14	MM 749	762	813	660	483	457
OVERALL DIMENSIONS			SEAT DIMENSIONS			BACK DIMENSIONS																										
W	D	H	W	D	H	W	H																									
IN 29.5	30	32	26	19	18	26	14																									
MM 749	762	813	660	483	457	660	356																									
 <p><b>R27802</b></p> <p><b>Lounge Chair - High Back</b> COM: 4.5 YD   4.11 M Unit weight: 52 LB   23.6 KG Carton weight: 71 LB   32.21 KG Carton volume: 24.75 FT<sup>3</sup>   0.7 MT<sup>3</sup></p>	<p>For power/USB unit, please see electrical placement chart.</p> <p>Includes ganging hardware (2 sides).</p> <p>Add \$72, \$46 for <b>(S2)</b>, <b>(SE)</b> Add \$533 for 36 lbs. <b>(CW)</b> Add \$59 for <b>(SU)</b> or \$298 for <b>(BS)</b> Add \$28 for <b>(TP)</b> Add \$81 for <b>(MB)</b></p>	<b>R27802</b>	1878	2022	2143	2284	2513	2724	2935	3120	3349	3565	3858	4272																		
		<table border="1"> <thead> <tr> <th colspan="3">OVERALL DIMENSIONS</th> <th colspan="3">SEAT DIMENSIONS</th> <th colspan="2">BACK DIMENSIONS</th> </tr> <tr> <th>W</th> <th>D</th> <th>H</th> <th>W</th> <th>D</th> <th>H</th> <th>W</th> <th>H</th> </tr> </thead> <tbody> <tr> <td>IN 26</td> <td>30.5</td> <td>41.5</td> <td>26</td> <td>19</td> <td>18</td> <td>26</td> <td>23.5</td> </tr> <tr> <td>MM 660</td> <td>775</td> <td>1054</td> <td>660</td> <td>483</td> <td>457</td> <td>660</td> <td>597</td> </tr> </tbody> </table> <p><b>RTA 00</b> 1 per carton</p>	OVERALL DIMENSIONS			SEAT DIMENSIONS			BACK DIMENSIONS		W	D	H	W	D	H	W	H	IN 26	30.5	41.5	26	19	18	26	23.5	MM 660	775	1054	660	483	457
OVERALL DIMENSIONS			SEAT DIMENSIONS			BACK DIMENSIONS																										
W	D	H	W	D	H	W	H																									
IN 26	30.5	41.5	26	19	18	26	23.5																									
MM 660	775	1054	660	483	457	660	597																									
 <p><b>R27802B</b></p> <p><b>Lounge Chair - High Back w/Uph Arms</b> COM: 6.5 YD   5.94 M Unit weight: 72 LB   32.7 KG Carton weight: 88.5 LB   40.14 KG Carton volume: 31.25 FT<sup>3</sup>   0.88 MT<sup>3</sup></p>	<p>For power/USB unit, please see electrical placement chart.</p> <p>Ganging not available.</p> <p>Add \$112, \$46 for <b>(S2)</b>, <b>(SE)</b> Add \$533 for 36 lbs. <b>(CW)</b> Add \$59 for <b>(SU)</b> or \$298 for <b>(BS)</b> Add \$28 for <b>(TP)</b> Add \$81 for <b>(MB)</b></p>	<b>R27802B</b>	2472	2680	2855	3058	3389	3694	3999	4266	4597	4909	5332	5930																		
		<table border="1"> <thead> <tr> <th colspan="3">OVERALL DIMENSIONS</th> <th colspan="3">SEAT DIMENSIONS</th> <th colspan="2">BACK DIMENSIONS</th> </tr> <tr> <th>W</th> <th>D</th> <th>H</th> <th>W</th> <th>D</th> <th>H</th> <th>W</th> <th>H</th> </tr> </thead> <tbody> <tr> <td>IN 33</td> <td>30.5</td> <td>41.5</td> <td>26</td> <td>19</td> <td>18</td> <td>26</td> <td>23.5</td> </tr> <tr> <td>MM 838</td> <td>775</td> <td>1054</td> <td>660</td> <td>483</td> <td>457</td> <td>660</td> <td>597</td> </tr> </tbody> </table> <p><b>RTA 00</b> 1 per carton</p>	OVERALL DIMENSIONS			SEAT DIMENSIONS			BACK DIMENSIONS		W	D	H	W	D	H	W	H	IN 33	30.5	41.5	26	19	18	26	23.5	MM 838	775	1054	660	483	457
OVERALL DIMENSIONS			SEAT DIMENSIONS			BACK DIMENSIONS																										
W	D	H	W	D	H	W	H																									
IN 33	30.5	41.5	26	19	18	26	23.5																									
MM 838	775	1054	660	483	457	660	597																									

DESCRIPTION FEATURES MODEL# STANDARD TEXTILE GRADES

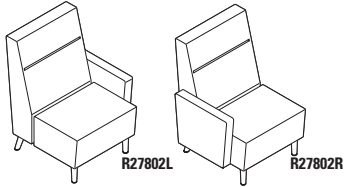

**Lounge Chair - High Back w/Up Arms (Left/Right)**  
 COM: 5.5 YD | 5.03 M  
 Unit weight: 62 LB | 28.2 KG  
 Carton weight: 78.5 LB | 35.61 KG  
 Carton volume: 31.25 FT<sup>3</sup> | 0.88 MT<sup>3</sup>

For power/USB unit, please see electrical placement chart.

Includes ganging hardware (1 side only).

Add \$91, \$46 for (S2), (SE)  
 Add \$533 for 36 lbs. (CW)  
 Add \$59 for (SU) or \$298 for (BS)  
 Add \$28 for (TP)  
 Add \$81 for (MB)

	1	2	3	4	5	6	7	8	9	10	11	12
<b>R27802L</b>	2175	2351	2499	2671	2951	3209	3467	3693	3973	4237	4595	5101
<b>R27802R</b>												
OVERALL DIMENSIONS			SEAT DIMENSIONS			BACK DIMENSIONS						
W	D	H	W	D	H	W	H					
IN 29.5	30.5	41.5	26	19	18	26	23.5					
MM 749	775	1054	660	483	457	660	597					
<b>RTA 00</b>	1 per carton											

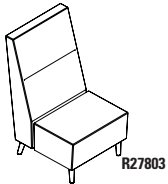

**Lounge Chair - Extended Back**  
 COM: 4.75 YD | 4.34 M  
 Unit weight: 64 LB | 29.1 KG  
 Carton weight: 81 LB | 36.74 KG  
 Carton volume: 28 FT<sup>3</sup> | 0.79 MT<sup>3</sup>

For power/USB unit, please see electrical placement chart.

Includes ganging hardware (2 sides).

Add \$72, \$46 for (S2), (SE)  
 Add \$533 for 36 lbs. (CW)  
 Add \$59 for (SU) or \$298 for (BS)  
 Add \$28 for (TP)  
 Add \$81 for (MB)

	1	2	3	4	5	6	7	8	9	10	11	12
<b>R27803</b>	1972	2124	2252	2400	2642	2865	3088	3283	3525	3753	4062	4499
OVERALL DIMENSIONS			SEAT DIMENSIONS			BACK DIMENSIONS						
W	D	H	W	D	H	W	H					
IN 26	31	47	26	19	18	26	29					
MM 660	787	1194	660	483	457	660	597					
<b>RTA 00</b>	1 per carton											

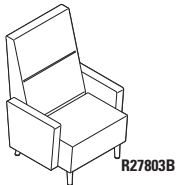

**Lounge Chair - Extended Back w/Up Arms**  
 COM: 6.75 YD | 6.17 M  
 Unit weight: 84 LB | 38.2 KG  
 Carton weight: 101.5 LB | 46.04 KG  
 Carton volume: 35 FT<sup>3</sup> | 0.99 MT<sup>3</sup>

For power/USB unit, please see electrical placement chart.

Ganging not available.

Add \$117, \$46 for (S2), (SE)  
 Add \$533 for 36 lbs. (CW)  
 Add \$59 for (SU) or \$298 for (BS)  
 Add \$28 for (TP)  
 Add \$81 for (MB)

	1	2	3	4	5	6	7	8	9	10	11	12
<b>R27803B</b>	2566	2782	2964	3174	3518	3835	4152	4429	4773	5097	5536	6157
OVERALL DIMENSIONS			SEAT DIMENSIONS			BACK DIMENSIONS						
W	D	H	W	D	H	W	H					
IN 33	31	47	26	19	18	26	29					
MM 838	787	1194	660	483	457	660	737					
<b>RTA 00</b>	1 per carton											

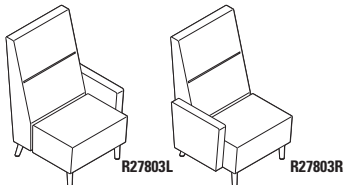

**Lounge Chair - Extended Back w/Up Arms (Left/Right)**  
 COM: 5.75 YD | 5.26 M  
 Unit weight: 74 LB | 33.6 KG  
 Carton weight: 91.5 LB | 41.5 KG  
 Carton volume: 35 FT<sup>3</sup> | 0.99 MT<sup>3</sup>

For power/USB unit, please see electrical placement chart.

Includes ganging hardware (1 side only).

Add \$97, \$46 for (S2), (SE)  
 Add \$533 for 36 lbs. (CW)  
 Add \$59 for (SU) or \$298 for (BS)  
 Add \$28 for (TP)  
 Add \$81 for (MB)

	1	2	3	4	5	6	7	8	9	10	11	12
<b>R27803L</b>	2269	2453	2608	2787	3080	3350	3620	3856	4149	4425	4799	5328
<b>R27803R</b>												
OVERALL DIMENSIONS			SEAT DIMENSIONS			BACK DIMENSIONS						
W	D	H	W	D	H	W	H					
IN 29.5	31	47	26	19	18	26	29					
MM 749	787	1194	660	483	457	660	737					
<b>RTA 00</b>	1 per carton											

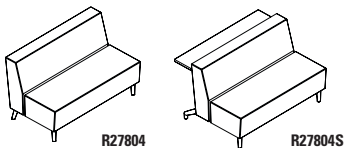

**Two Seater - Standard Back**  
 COM: 4.75 YD | 4.34 M  
 Unit weight: 91 LB | 41.4 KG  
 Carton weight: 113 LB | 51.26 KG  
 Carton volume: 28 FT<sup>3</sup> | 0.79 MT<sup>3</sup>

For power/USB unit, please see electrical placement chart.

Includes ganging hardware (2 sides).

Add \$85, \$71 for (S2), (SE)  
 Add \$1067 for 72 lbs. (CW), (C6)  
 Add \$119 for (SU) or \$476 for (BS)  
 Add \$28 for (TP)  
 Add \$161 for (MB)

	1	2	3	4	5	6	7	8	9	10	11	12
<b>R27804</b>	2647	2799	2927	3075	3317	3540	3763	3958	4200	4428	4737	5174
<b>R27804S</b>	3209	3361	3489	3637	3879	4102	4325	4520	4762	4990	5299	5736
shelf model IN W52 D40.5 H32   MM W1321 D1029 H813												
OVERALL DIMENSIONS			SEAT DIMENSIONS			BACK DIMENSIONS						
W	D	H	W	D	H	W	H					
IN 52	30	32	52	19	18	52	14					
MM 1321	762	813	1321	483	457	1321	356					
<b>RTA 00</b>	1 per carton											

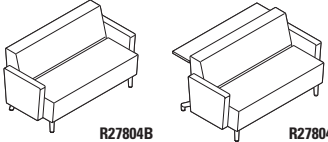
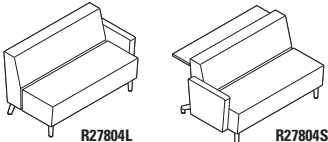
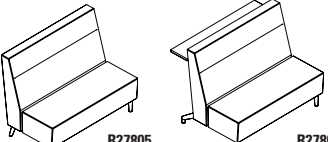
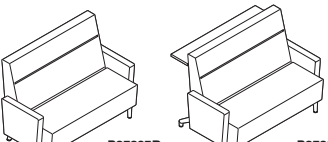
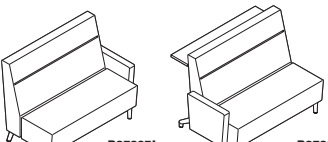
DESCRIPTION	FEATURES	MODEL#	STANDARD TEXTILE GRADES																																								
			1	2	3	4	5	6	7	8	9	10	11	12																													
 <p><b>R27804B</b>      <b>R27804SB</b></p> <p><b>Two Seater - Standard Back w/Uph Arms</b>                      COM: 6.75 YD   6.17 M                      Unit weight: 111 LB   50.5 KG                      Carton weight: 133 LB   60.33 KG                      Carton volume: 42.5 FT<sup>3</sup>   1.2 MT<sup>3</sup></p>	<p>For power/USB unit, please see electrical placement chart.</p> <p>Ganging not available.</p> <p>Add \$127, \$71 for <b>(S2), (SE)</b>                      Add \$1067 for 72 lbs. <b>(CW), (C6)</b>                      Add \$119 for <b>(SU)</b> or \$476 for <b>(BS)</b>                      Add \$28 for <b>(TP)</b>                      Add \$161 for <b>(MB)</b></p>	<p><b>R27804B</b>    3241   3457   3639   3849   4193   4510   4827   5104   5448   5772   6211   6832</p> <p><b>R27804SB</b>   3803   4019   4201   4411   4755   5072   5389   5666   6010   6334   6773   7394</p> <p>shelf model in W59 D40.5 H32   MM W1499 D1029 H813</p>																																									
		<p><b>OVERALL DIMENSIONS</b></p> <table border="1"> <thead> <tr> <th>W</th> <th>D</th> <th>H</th> <th colspan="3">SEAT DIMENSIONS</th> <th colspan="2">BACK DIMENSIONS</th> </tr> <tr> <th>W</th> <th>D</th> <th>H</th> <th>W</th> <th>D</th> <th>H</th> <th>W</th> <th>H</th> </tr> </thead> <tbody> <tr> <td>IN 59</td> <td>30</td> <td>32</td> <td>52</td> <td>19</td> <td>18</td> <td>52</td> <td>14</td> </tr> <tr> <td>MM 1499</td> <td>762</td> <td>813</td> <td>1321</td> <td>483</td> <td>457</td> <td>1321</td> <td>356</td> </tr> </tbody> </table> <p><b>RTA 00</b>      1 per carton</p>	W	D	H	SEAT DIMENSIONS			BACK DIMENSIONS		W	D	H	W	D	H	W	H	IN 59	30	32	52	19	18	52	14	MM 1499	762	813	1321	483	457	1321	356									
W	D	H	SEAT DIMENSIONS			BACK DIMENSIONS																																					
W	D	H	W	D	H	W	H																																				
IN 59	30	32	52	19	18	52	14																																				
MM 1499	762	813	1321	483	457	1321	356																																				
 <p><b>R27804L</b>      <b>R27804SR</b></p> <p><b>Two Seater - Standard Back w/Uph Arms (Left/Right)</b>                      COM: 5.75 YD   5.26 M                      Unit weight: 101 LB   45.9 KG                      Carton weight: 123 LB   55.79 KG                      Carton volume: 42.5 FT<sup>3</sup>   1.2 MT<sup>3</sup></p>	<p>For power/USB unit, please see electrical placement chart.</p> <p>Includes ganging hardware (1 side only).</p> <p>Add \$106, \$71 for <b>(S2), (SE)</b>                      Add \$1067 for 72 lbs. <b>(CW), (C6)</b>                      Add \$119 for <b>(SU)</b> or \$476 for <b>(BS)</b>                      Add \$28 for <b>(TP)</b>                      Add \$161 for <b>(MB)</b></p>	<p><b>R27804L</b>    2944   3128   3283   3462   3755   4025   4295   4531   4824   5100   5474   6003</p> <p><b>R27804SR</b>   3506   3690   3845   4024   4317   4587   4857   5093   5386   5662   6036   6565</p> <p>shelf model in W55.5 D40.5 H32   MM W1410 D1029 H813</p>																																									
		<p><b>OVERALL DIMENSIONS</b></p> <table border="1"> <thead> <tr> <th>W</th> <th>D</th> <th>H</th> <th colspan="3">SEAT DIMENSIONS</th> <th colspan="2">BACK DIMENSIONS</th> </tr> <tr> <th>W</th> <th>D</th> <th>H</th> <th>W</th> <th>D</th> <th>H</th> <th>W</th> <th>H</th> </tr> </thead> <tbody> <tr> <td>IN 55.5</td> <td>30</td> <td>32</td> <td>52</td> <td>19</td> <td>18</td> <td>52</td> <td>14</td> </tr> <tr> <td>MM 1410</td> <td>762</td> <td>813</td> <td>1321</td> <td>483</td> <td>457</td> <td>1321</td> <td>356</td> </tr> </tbody> </table> <p><b>RTA 00</b>      1 per carton</p>	W	D	H	SEAT DIMENSIONS			BACK DIMENSIONS		W	D	H	W	D	H	W	H	IN 55.5	30	32	52	19	18	52	14	MM 1410	762	813	1321	483	457	1321	356									
W	D	H	SEAT DIMENSIONS			BACK DIMENSIONS																																					
W	D	H	W	D	H	W	H																																				
IN 55.5	30	32	52	19	18	52	14																																				
MM 1410	762	813	1321	483	457	1321	356																																				
 <p><b>R27805</b>      <b>R27805S</b></p> <p><b>Two Seater - High Back</b>                      COM: 5.5 YD   5.03 M                      Unit weight: 94 LB   42.7 KG                      Carton weight: 116 LB   52.62 KG                      Carton volume: 19.75 FT<sup>3</sup>   0.55 MT<sup>3</sup></p>	<p>For power/USB unit, please see electrical placement chart.</p> <p>Includes ganging hardware (2 sides).</p> <p>Add \$115, \$71 for <b>(S2), (SE)</b>                      Add \$1067 for 72 lbs. <b>(CW), (C6)</b>                      Add \$119 for <b>(SU)</b> or \$476 for <b>(BS)</b>                      Add \$28 for <b>(TP)</b>                      Add \$161 for <b>(MB)</b></p>	<p><b>R27805</b>      2946   3122   3271   3441   3722   3980   4239   4464   4745   5009   5366   5872</p> <p><b>R27805S</b>    3508   3684   3833   4003   4284   4542   4801   5026   5307   5571   5928   6434</p> <p>shelf model in W52 D41 H41.5   MM W1321 D1041 H1054</p>																																									
		<p><b>OVERALL DIMENSIONS</b></p> <table border="1"> <thead> <tr> <th>W</th> <th>D</th> <th>H</th> <th colspan="3">SEAT DIMENSIONS</th> <th colspan="2">BACK DIMENSIONS</th> </tr> <tr> <th>W</th> <th>D</th> <th>H</th> <th>W</th> <th>D</th> <th>H</th> <th>W</th> <th>H</th> </tr> </thead> <tbody> <tr> <td>IN 52</td> <td>30.5</td> <td>41.5</td> <td>52</td> <td>19</td> <td>18</td> <td>52</td> <td>23.5</td> </tr> <tr> <td>MM 1321</td> <td>775</td> <td>1054</td> <td>1321</td> <td>483</td> <td>457</td> <td>1321</td> <td>597</td> </tr> </tbody> </table> <p><b>RTA 00</b>      1 per carton</p>	W	D	H	SEAT DIMENSIONS			BACK DIMENSIONS		W	D	H	W	D	H	W	H	IN 52	30.5	41.5	52	19	18	52	23.5	MM 1321	775	1054	1321	483	457	1321	597									
W	D	H	SEAT DIMENSIONS			BACK DIMENSIONS																																					
W	D	H	W	D	H	W	H																																				
IN 52	30.5	41.5	52	19	18	52	23.5																																				
MM 1321	775	1054	1321	483	457	1321	597																																				
 <p><b>R27805B</b>      <b>R27805SB</b></p> <p><b>Two Seater - High Back w/Uph Arms</b>                      COM: 7.5 YD   6.86 M                      Unit weight: 114 LB   51.8 KG                      Carton weight: 116 LB   52.62 KG                      Carton volume: 19.75 FT<sup>3</sup>   0.55 MT<sup>3</sup></p>	<p>For power/USB unit, please see electrical placement chart.</p> <p>Ganging not available.</p> <p>Add \$155, \$71 for <b>(S2), (SE)</b>                      Add \$1067 for 72 lbs. <b>(CW), (C6)</b>                      Add \$119 for <b>(SU)</b> or \$476 for <b>(BS)</b>                      Add \$28 for <b>(TP)</b>                      Add \$161 for <b>(MB)</b></p>	<p><b>R27805B</b>    3540   3780   3983   4215   4598   4950   5303   5610   5993   6353   6840   7530</p> <p><b>R27805SB</b>   4102   4342   4545   4777   5160   5512   5865   6172   6555   6915   7402   8092</p> <p>shelf model in W59 D41 H41.5   MM W1499 D1041 H1054</p>																																									
		<p><b>OVERALL DIMENSIONS</b></p> <table border="1"> <thead> <tr> <th>W</th> <th>D</th> <th>H</th> <th colspan="3">SEAT DIMENSIONS</th> <th colspan="2">BACK DIMENSIONS</th> </tr> <tr> <th>W</th> <th>D</th> <th>H</th> <th>W</th> <th>D</th> <th>H</th> <th>W</th> <th>H</th> </tr> </thead> <tbody> <tr> <td>IN 59</td> <td>30.5</td> <td>41.5</td> <td>52</td> <td>19</td> <td>18</td> <td>52</td> <td>23.5</td> </tr> <tr> <td>MM 1499</td> <td>775</td> <td>1054</td> <td>1321</td> <td>483</td> <td>457</td> <td>1321</td> <td>597</td> </tr> </tbody> </table> <p><b>RTA 00</b>      1 per carton</p>	W	D	H	SEAT DIMENSIONS			BACK DIMENSIONS		W	D	H	W	D	H	W	H	IN 59	30.5	41.5	52	19	18	52	23.5	MM 1499	775	1054	1321	483	457	1321	597									
W	D	H	SEAT DIMENSIONS			BACK DIMENSIONS																																					
W	D	H	W	D	H	W	H																																				
IN 59	30.5	41.5	52	19	18	52	23.5																																				
MM 1499	775	1054	1321	483	457	1321	597																																				
 <p><b>R27805L</b>      <b>R27805SR</b></p> <p><b>Two Seater - High Back w/Uph Arms (Left/Right)</b>                      COM: 6.5 YD   5.94 M                      Unit weight: 104 LB   47.3 KG                      Carton weight: 128 LB   58.06 KG                      Carton volume: 54 FT<sup>3</sup>   1.52 MT<sup>3</sup></p>	<p>For power/USB unit, please see electrical placement chart.</p> <p>Includes ganging hardware (1 side only).</p> <p>Add \$134, \$71 for <b>(S2), (SE)</b>                      Add \$1067 for 72 lbs. <b>(CW), (C6)</b>                      Add \$119 for <b>(SU)</b> or \$476 for <b>(BS)</b>                      Add \$28 for <b>(TP)</b>                      Add \$161 for <b>(MB)</b></p>	<p><b>R27805L</b>    3243   3451   3627   3828   4160   4465   4771   5037   5369   5681   6103   6701</p> <p><b>R27805SR</b>   3805   4013   4189   4390   4722   5027   5333   5599   5931   6243   6665   7263</p> <p>shelf model in W55.5 D41 H41.5   MM W1410 D1041 H1054</p>																																									
		<p><b>OVERALL DIMENSIONS</b></p> <table border="1"> <thead> <tr> <th>W</th> <th>D</th> <th>H</th> <th colspan="3">SEAT DIMENSIONS</th> <th colspan="2">BACK DIMENSIONS</th> </tr> <tr> <th>W</th> <th>D</th> <th>H</th> <th>W</th> <th>D</th> <th>H</th> <th>W</th> <th>H</th> </tr> </thead> <tbody> <tr> <td>IN 55.5</td> <td>30.5</td> <td>41.5</td> <td>52</td> <td>19</td> <td>18</td> <td>52</td> <td>23.5</td> </tr> <tr> <td>MM 1410</td> <td>775</td> <td>1054</td> <td>1321</td> <td>483</td> <td>457</td> <td>1321</td> <td>597</td> </tr> </tbody> </table> <p><b>RTA 00</b>      1 per carton</p>	W	D	H	SEAT DIMENSIONS			BACK DIMENSIONS		W	D	H	W	D	H	W	H	IN 55.5	30.5	41.5	52	19	18	52	23.5	MM 1410	775	1054	1321	483	457	1321	597									
W	D	H	SEAT DIMENSIONS			BACK DIMENSIONS																																					
W	D	H	W	D	H	W	H																																				
IN 55.5	30.5	41.5	52	19	18	52	23.5																																				
MM 1410	775	1054	1321	483	457	1321	597																																				

DESCRIPTION FEATURES MODEL# STANDARD TEXTILE GRADES

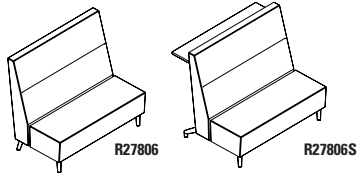

**Two Seater - Extended Back**  
 COM: 5.5 YD | 5.03 M  
 Unit weight: 106 LB | 48.2 KG  
 Carton weight: 71 LB | 32.21 KG  
 Carton volume: 24.75 FT³ | 0.7 MT³

For power/USB unit, please see electrical placement chart.  
 Includes ganging hardware (2 sides).  
 Add \$123, \$71 for **(S2), (SE)**  
 Add \$1067 for 72 lbs. **(CW), (C6)**  
 Add \$119 for **(SU)** or \$476 for **(BS)**  
 Add \$28 for **(TP)**  
 Add \$161 for **(MB)**

	1	2	3	4	5	6	7	8	9	10	11	12
<b>R27806</b>	3117	3293	3442	3612	3893	4151	4410	4635	4916	5180	5537	6043
<b>R27806S</b>	3678	3854	4003	4173	4454	4712	4971	5196	5477	5741	6098	6604

shelf model in W52 D41.5 H47 | MM W1321 D1054 H1194

OVERALL DIMENSIONS			SEAT DIMENSIONS			BACK DIMENSIONS		
W	D	H	W	D	H	W	H	
IN 52	31	47	52	19	18	52	29	
MM 1321	787	1194	1321	483	457	1321	737	

RTA 00 1 per carton

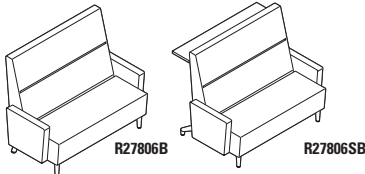

**Two Seater - Extended Back w/Uph Arms**  
 COM: 8 YD | 7.32 M  
 Unit weight: 126 LB | 57.3 KG  
 Carton weight: 151 LB | 68.49 KG  
 Carton volume: 60.5 FT³ | 1.71 MT³

For power/USB unit, please see electrical placement chart.  
 Ganging not available.  
 Add \$162, \$71 for **(S2), (SE)**  
 Add \$1067 for 72 lbs. **(CW), (C6)**  
 Add \$119 for **(SU)** or \$476 for **(BS)**  
 Add \$28 for **(TP)**  
 Add \$161 for **(MB)**

	1	2	3	4	5	6	7	8	9	10	11	12
<b>R27806B</b>	3711	3967	4183	4431	4839	5215	5591	5919	6327	6711	7231	7967
<b>R27806SB</b>	4272	4528	4744	4992	5400	5776	6152	6480	6888	7272	7792	8528

shelf model in W59 D41.5 H47 | MM W1499 D1054 H1194

OVERALL DIMENSIONS			SEAT DIMENSIONS			BACK DIMENSIONS		
W	D	H	W	D	H	W	H	
IN 59	31	47	52	19	18	52	29	
MM 1499	787	1194	1321	483	457	1321	737	

RTA 00 1 per carton

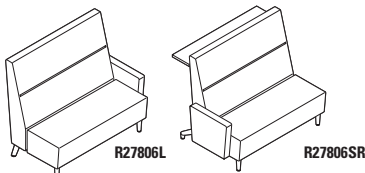

**Two Seater - Extended Back w/Uph Arms (Left/Right)**  
 COM: 7 YD | 6.4 M  
 Unit weight: 116 LB | 52.7 KG  
 Carton weight: 141 LB | 63.96 KG  
 Carton volume: 60.5 FT³ | 1.71 MT³

For power/USB unit, please see electrical placement chart.  
 Includes ganging hardware (1 side only).  
 Add \$142, \$71 for **(S2), (SE)**  
 Add \$1067 for 72 lbs. **(CW), (C6)**  
 Add \$119 for **(SU)** or \$476 for **(BS)**  
 Add \$28 for **(TP)**  
 Add \$161 for **(MB)**

	1	2	3	4	5	6	7	8	9	10	11	12
<b>R27806L</b>	3414	3638	3827	4044	4401	4730	5059	5346	5703	6039	6494	7138
<b>R27806R</b>												
<b>R27806SL</b>	3975	4199	4388	4605	4962	5291	5620	5907	6264	6600	7055	7699
<b>R27806SR</b>												

shelf model in W55.5 D41.5 H47 | MM W1410 D1054 H1194

OVERALL DIMENSIONS			SEAT DIMENSIONS			BACK DIMENSIONS		
W	D	H	W	D	H	W	H	
IN 55.5	31	47	52	19	18	52	29	
MM 1410	787	1194	1321	483	457	1321	737	

RTA 00 1 per carton

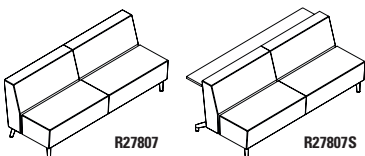

**Three Seater - Standard Back**  
 COM: 8 YD | 7.32 M  
 Unit weight: 120 LB | 54.5 KG  
 Carton weight: 152 LB | 68.95 KG  
 Carton volume: 55.5 FT³ | 1.57 MT³

For power/USB unit, please see electrical placement chart.  
 Includes ganging hardware (2 sides).  
 Add \$101, \$84 for **(S2), (SE)**  
 Add \$1067 for 72 lbs. **(CW), (C6)**  
 Add \$179 for **(SU)** or \$655 for **(BS)**  
 Add \$28 for **(TP)**  
 Add \$243 for **(MB)**

	1	2	3	4	5	6	7	8	9	10	11	12
<b>R27807</b>	3783	4039	4256	4503	4912	5287	5664	5991	6400	6784	7303	8039
<b>R27807S</b>	4531	4787	5004	5251	5660	6035	6412	6739	7148	7532	8051	8787

shelf model in W78 D40.5 H32 | MM W1981 D1029 H813

OVERALL DIMENSIONS			SEAT DIMENSIONS			BACK DIMENSIONS		
W	D	H	W	D	H	W	H	
IN 78	30	32	78	19	18	78	14	
MM 1981	762	813	1981	483	457	1981	356	

RTA 00 1 per carton

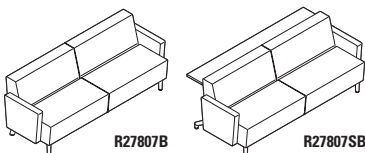

**Three Seater - Standard Back w/Uph Arms**  
 COM: 10 YD | 9.14 M  
 Unit weight: 140 LB | 63.6 KG  
 Carton weight: 170 LB | 77.11 KG  
 Carton volume: 60.5 FT³ | 1.71 MT³

For power/USB unit, please see electrical placement chart.  
 Ganging not available.  
 Add \$137, \$84 for **(S2), (SE)**  
 Add \$1067 for 72 lbs. **(CW), (C6)**  
 Add \$179 for **(SU)** or \$655 for **(BS)**  
 Add \$28 for **(TP)**  
 Add \$243 for **(MB)**

	1	2	3	4	5	6	7	8	9	10	11	12
<b>R27807B</b>	4377	4697	4968	5277	5788	6257	6728	7137	7648	8128	8777	9697
<b>R27807SB</b>	5125	5445	5716	6025	6536	7005	7476	7885	8396	8876	9525	10445

shelf model in W85 D40.5 H32 | MM W2159 D1029 H813

OVERALL DIMENSIONS			SEAT DIMENSIONS			BACK DIMENSIONS		
W	D	H	W	D	H	W	H	
IN 85	30	32	78	19	18	78	14	
MM 2159	762	813	1981	483	457	1981	356	

RTA 00 1 per carton

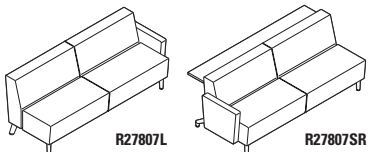
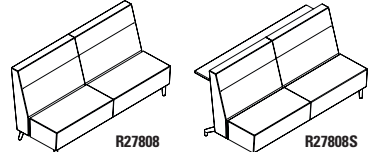
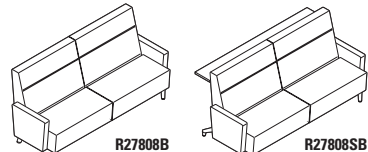
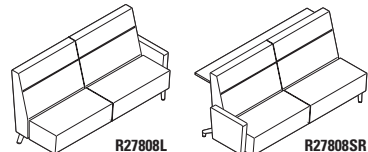
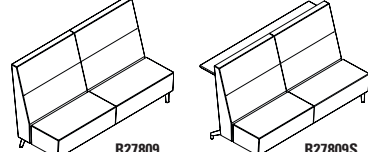

DESCRIPTION	FEATURES	MODEL#	STANDARD TEXTILE GRADES											
			1	2	3	4	5	6	7	8	9	10	11	12
 <p><b>R27807L</b>      <b>R27807SR</b></p> <p><b>Three Seater - Standard Back w/Uph Arms (Left/Right)</b>                      COM: 9 YD   8.23 M                      Unit weight: 130 LB   59.1 KG                      Carton weight: 160 LB   72.57 KG                      Carton volume: 60.5 FT<sup>3</sup>   1.71 MT<sup>3</sup></p>	<p>For power/USB unit, please see electrical placement chart.</p> <p>Includes ganging hardware (1 side only).</p> <p>Add \$120, \$84 for <b>(S2)</b>, <b>(SE)</b>                      Add \$1067 for 72 lbs. <b>(CW)</b>, <b>(C6)</b>                      Add \$179 for <b>(SU)</b> or \$655 for <b>(BS)</b>                      Add \$28 for <b>(TP)</b>                      Add \$243 for <b>(MB)</b></p>	<p><b>R27807L</b></p> <p><b>R27807R</b></p> <p><b>R27807SL</b></p> <p><b>R27807SR</b></p> <p>shelf model in W81.5 D40.5 H32   MM W2070 D1029 H813</p>	4080	4368	4612	4890	5350	5772	6196	6564	7024	7456	8040	8868
		<p><b>OVERALL DIMENSIONS</b></p> <p>W      D      H</p> <p>IN 81.5      30      32                      MM 2070      762      813</p> <p><b>SEAT DIMENSIONS</b></p> <p>W      D      H</p> <p>IN 78      19      18                      MM 1981      483      457</p> <p><b>BACK DIMENSIONS</b></p> <p>W      H</p> <p>IN 78      14                      MM 1981      356</p> <p><b>RTA 00</b>      1 per carton</p>												
 <p><b>R27808</b>      <b>R27808S</b></p> <p><b>Three Seater - High Back</b>                      COM: 9.25 YD   8.46 M                      Unit weight: 138 LB   62.7 KG                      Carton weight: 177 LB   80.29 KG                      Carton volume: 69.75 FT<sup>3</sup>   1.97 MT<sup>3</sup></p>	<p>For power/USB unit, please see electrical placement chart.</p> <p>Includes ganging hardware (2 sides).</p> <p>Add \$136, \$84 for <b>(S2)</b>, <b>(SE)</b>                      Add \$1067 for 72 lbs. <b>(CW)</b>, <b>(C6)</b>                      Add \$179 for <b>(SU)</b> or \$655 for <b>(BS)</b>                      Add \$28 for <b>(TP)</b>                      Add \$243 for <b>(MB)</b></p>	<p><b>R27808</b></p> <p><b>R27808S</b></p> <p>shelf model in W78 D41 H41.5   MM W1981 D1041 H1054</p>	4486	4782	5032	5319	5791	6225	6660	7039	7511	7955	8556	9407
		<p><b>OVERALL DIMENSIONS</b></p> <p>W      D      H</p> <p>IN 78      30.5      41.5                      MM 1981      775      1054</p> <p><b>SEAT DIMENSIONS</b></p> <p>W      D      H</p> <p>IN 78      19      18                      MM 1981      483      457</p> <p><b>BACK DIMENSIONS</b></p> <p>W      H</p> <p>IN 78      23.5                      MM 1981      597</p> <p><b>RTA 00</b>      1 per carton</p>												
 <p><b>R27808B</b>      <b>R27808SB</b></p> <p><b>Three Seater - High Back w/Uph Arms</b>                      COM: 11.25 YD   10.29 M                      Unit weight: 158 LB   71.8 KG                      Carton weight: 190.5 LB   86.41 KG                      Carton volume: 69.75 FT<sup>3</sup>   1.97 MT<sup>3</sup></p>	<p>For power/USB unit, please see electrical placement chart.</p> <p>Ganging not available.</p> <p>Add \$175, \$84 for <b>(S2)</b>, <b>(SE)</b>                      Add \$1067 for 72 lbs. <b>(CW)</b>, <b>(C6)</b>                      Add \$179 for <b>(SU)</b> or \$655 for <b>(BS)</b>                      Add \$28 for <b>(TP)</b>                      Add \$243 for <b>(MB)</b></p>	<p><b>R27808B</b></p> <p><b>R27808SB</b></p> <p>shelf model in W85 D41 H41.5   MM W2159 D1041 H1054</p>	5080	5440	5744	6093	6667	7195	7724	8185	8759	9299	10030	11065
		<p><b>OVERALL DIMENSIONS</b></p> <p>W      D      H</p> <p>IN 85      30.5      41.5                      MM 2159      775      1054</p> <p><b>SEAT DIMENSIONS</b></p> <p>W      D      H</p> <p>IN 78      19      18                      MM 1981      483      457</p> <p><b>BACK DIMENSIONS</b></p> <p>W      H</p> <p>IN 78      23.5                      MM 1981      597</p> <p><b>RTA 00</b>      1 per carton</p>												
 <p><b>R27808L</b>      <b>R27808SR</b></p> <p><b>Three Seater - High Back w/Uph Arms (Left/Right)</b>                      COM: 10.25 YD   9.37 M                      Unit weight: 148 LB   67.3 KG                      Carton weight: 180.5 LB   81.87 KG                      Carton volume: 76.75 FT<sup>3</sup>   2.17 MT<sup>3</sup></p>	<p>For power/USB unit, please see electrical placement chart.</p> <p>Includes ganging hardware (1 side only).</p> <p>Add \$155, \$84 for <b>(S2)</b>, <b>(SE)</b>                      Add \$1067 for 72 lbs. <b>(CW)</b>, <b>(C6)</b>                      Add \$179 for <b>(SU)</b> or \$655 for <b>(BS)</b>                      Add \$28 for <b>(TP)</b>                      Add \$243 for <b>(MB)</b></p>	<p><b>R27808L</b></p> <p><b>R27808R</b></p> <p><b>R27808SL</b></p> <p><b>R27808SR</b></p> <p>shelf model in W81.5 D41 H41.5   MM W2070 D1041 H1054</p>	4783	5111	5388	5706	6229	6710	7192	7612	8135	8627	9293	10236
		<p><b>OVERALL DIMENSIONS</b></p> <p>W      D      H</p> <p>IN 81.5      30.5      41.5                      MM 2070      775      1054</p> <p><b>SEAT DIMENSIONS</b></p> <p>W      D      H</p> <p>IN 78      19      18                      MM 1981      483      457</p> <p><b>BACK DIMENSIONS</b></p> <p>W      H</p> <p>IN 78      23.5                      MM 1981      597</p> <p><b>RTA 00</b>      1 per carton</p>												
 <p><b>R27809</b>      <b>R27809S</b></p> <p><b>Three Seater - Extended Back</b>                      COM: 10 YD   9.14 M                      Unit weight: 135 LB   61.4 KG                      Carton weight: 165 LB   74.84 KG                      Carton volume: 79.25 FT<sup>3</sup>   2.24 MT<sup>3</sup></p>	<p>For power/USB unit, please see electrical placement chart.</p> <p>Includes ganging hardware (2 sides).</p> <p>Add \$143, \$84 for <b>(S2)</b>, <b>(SE)</b>                      Add \$1067 for 72 lbs. <b>(CW)</b>, <b>(C6)</b>                      Add \$179 for <b>(SU)</b> or \$655 for <b>(BS)</b>                      Add \$28 for <b>(TP)</b>                      Add \$243 for <b>(MB)</b></p>	<p><b>R27809</b></p> <p><b>R27809S</b></p> <p>shelf model in W78 D41.5 H47   MM W1981 D1054 H1194</p>	4764	5084	5355	5664	6175	6644	7115	7524	8035	8515	9164	10084
		<p><b>OVERALL DIMENSIONS</b></p> <p>W      D      H</p> <p>IN 78      31      47                      MM 1981      787      1194</p> <p><b>SEAT DIMENSIONS</b></p> <p>W      D      H</p> <p>IN 78      19      18                      MM 1981      483      457</p> <p><b>BACK DIMENSIONS</b></p> <p>W      H</p> <p>IN 78      29                      MM 1981      737</p> <p><b>RTA 00</b>      1 per carton</p>												

DESCRIPTION FEATURES MODEL# STANDARD TEXTILE GRADES

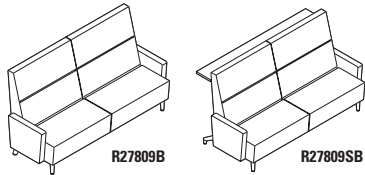

**Three Seater - Extended Back w/Uph Arms**  
 COM: 12 YD | 10.97 M  
 Unit weight: 155 LB | 70.5 KG  
 Carton weight: 190 LB | 86.18 KG  
 Carton volume: 86.25 FT<sup>3</sup> | 2.44 MT<sup>3</sup>

For power/USB unit, please see electrical placement chart.

Ganging not available.

Add \$174, \$84 for **(S2)**, **(SE)**  
 Add \$1067 for 72 lbs. **(CW)**, **(C6)**  
 Add \$179 for **(SU)** or \$655 for **(BS)**  
 Add \$28 for **(TP)**  
 Add \$243 for **(MB)**

	1	2	3	4	5	6	7	8	9	10	11	12
<b>R27809B</b>	5358	5742	6067	6438	7051	7614	8179	8670	9283	9859	10638	11742
<b>R27809SB</b>	6106	6490	6815	7186	7799	8362	8927	9418	10031	10607	11386	12490

shelf model in W85 D41.5 H47 | MM W2159 D1054 H1194

	OVERALL DIMENSIONS			SEAT DIMENSIONS			BACK DIMENSIONS		
	W	D	H	W	D	H	W	H	
IN	85	31	47	78	19	18	78	29	
MM	2159	787	1194	1981	483	457	1981	737	
<b>RTA 00</b>				1 per carton					

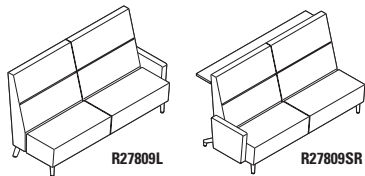

**Three Seater - Extended Back w/Uph Arms (Left/Right)**  
 COM: 11 YD | 10.06 M  
 Unit weight: 145 LB | 65.9 KG  
 Carton weight: 180 LB | 81.65 KG  
 Carton volume: 86.25 FT<sup>3</sup> | 2.44 MT<sup>3</sup>

For power/USB unit, please see electrical placement chart.

Includes ganging hardware (1 side only).

Add \$162, \$84 for **(S2)**, **(SE)**  
 Add \$1067 for 72 lbs. **(CW)**, **(C6)**  
 Add \$179 for **(SU)** or \$655 for **(BS)**  
 Add \$28 for **(TP)**  
 Add \$243 for **(MB)**

	1	2	3	4	5	6	7	8	9	10	11	12
<b>R27809L</b>	5061	5413	5711	6051	6613	7129	7647	8097	8659	9187	9901	10913
<b>R27809SL</b>	5809	6161	6459	6799	7361	7877	8395	8845	9407	9935	10649	11661
<b>R27809SR</b>												

shelf model in W81.5 D41.5 H47 | MM W2070 D1054 H1194

	OVERALL DIMENSIONS			SEAT DIMENSIONS			BACK DIMENSIONS		
	W	D	H	W	D	H	W	H	
IN	81.5	31	47	78	19	18	78	29	
MM	2070	787	1194	1981	483	457	1981	737	
<b>RTA 00</b>				1 per carton					

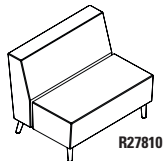

**Bariatric Lounge Chair - Standard Back**  
 COM: 4.25 YD | 3.89 M  
 Unit weight: 69 LB | 31.4 KG  
 Carton weight: 90 LB | 40.82 KG  
 Carton volume: 28.75 FT<sup>3</sup> | 0.81 MT<sup>3</sup>

For power/USB unit, please see electrical placement chart.

Includes ganging hardware (2 sides).

Add \$61, \$52 for **(S2)**, **(SE)**  
 Add \$533 for 36 lbs. **(CW)**  
 Add \$83 for **(SU)** or \$387 for **(BS)**  
 Add \$28 for **(TP)**  
 Add \$122 for **(MB)**

	1	2	3	4	5	6	7	8	9	10	11	12
<b>R27810</b>	2303	2439	2554	2686	2902	3102	3302	3476	3693	3897	4173	4564

	OVERALL DIMENSIONS			SEAT DIMENSIONS			BACK DIMENSIONS		
	W	D	H	W	D	H	W	H	
IN	39	30	32	39	19	18	39	14	
MM	991	762	813	991	483	457	991	356	
<b>RTA 00</b>				1 per carton					

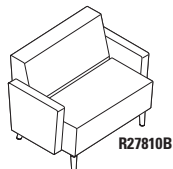

**Bariatric Lounge Chair - Standard Back w/Uph Arms**  
 COM: 6.25 YD | 5.72 M  
 Unit weight: 89 LB | 40.5 KG  
 Carton weight: 108 LB | 48.99 KG  
 Carton volume: 33 FT<sup>3</sup> | 0.93 MT<sup>3</sup>

For power/USB unit, please see electrical placement chart.

Ganging not available.

Add \$102, \$52 for **(S2)**, **(SE)**  
 Add \$533 for 36 lbs. **(CW)**  
 Add \$83 for **(SU)** or \$387 for **(BS)**  
 Add \$28 for **(TP)**  
 Add \$122 for **(MB)**

	1	2	3	4	5	6	7	8	9	10	11	12
<b>R27810B</b>	2897	3097	3266	3460	3778	4072	4366	4622	4941	5241	5647	6222

	OVERALL DIMENSIONS			SEAT DIMENSIONS			BACK DIMENSIONS		
	W	D	H	W	D	H	W	H	
IN	46	30	32	39	19	18	39	14	
MM	1168	762	813	991	483	457	991	356	
<b>RTA 00</b>				1 per carton					

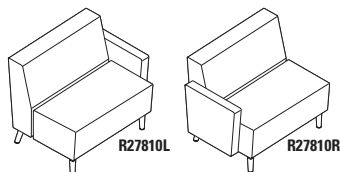

**Bariatric Lounge Chair - Standard Back w/Uph Arms (Left/Right)**  
 COM: 5.25 YD | 4.8 M  
 Unit weight: 79 LB | 35.9 KG  
 Carton weight: 98 LB | 44.45 KG  
 Carton volume: 33 FT<sup>3</sup> | 0.93 MT<sup>3</sup>

For power/USB unit, please see electrical placement chart.

Includes ganging hardware (1 side only).

Add \$82, \$52 for **(S2)**, **(SE)**  
 Add \$533 for 36 lbs. **(CW)**  
 Add \$83 for **(SU)** or \$387 for **(BS)**  
 Add \$28 for **(TP)**  
 Add \$122 for **(MB)**

	1	2	3	4	5	6	7	8	9	10	11	12
<b>R27810L</b>	2600	2768	2910	3073	3340	3587	3834	4049	4317	4569	4910	5393
<b>R27810R</b>												

	OVERALL DIMENSIONS			SEAT DIMENSIONS			BACK DIMENSIONS		
	W	D	H	W	D	H	W	H	
IN	42.5	30	32	39	19	18	39	14	
MM	1080	762	813	991	483	457	991	356	
<b>RTA 00</b>				1 per carton					

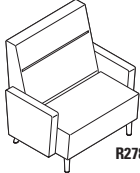
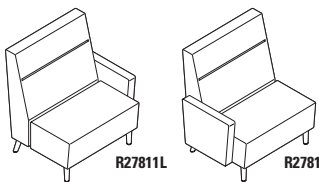
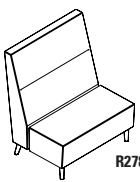
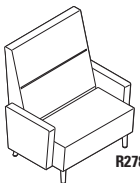
DESCRIPTION	FEATURES	MODEL#	STANDARD TEXTILE GRADES																													
			1	2	3	4	5	6	7	8	9	10	11	12																		
 <p><b>R27811</b></p> <p><b>Bariatric Lounge Chair - High Back</b>                      COM: 4.75 YD   4.34 M                      Unit weight: 77 LB   35 KG                      Carton weight: 98 LB   44.45 KG                      Carton volume: 36 FT<sup>3</sup>   1.01 MT<sup>3</sup></p>	<p>For power/USB unit, please see electrical placement chart.</p> <p>Includes ganging hardware (2 sides).</p> <p>Add \$81, \$52 for <b>(S2)</b>, <b>(SE)</b>                      Add \$533 for 36 lbs. <b>(CW)</b>                      Add \$83 for <b>(SU)</b> or \$387 for <b>(BS)</b>                      Add \$28 for <b>(TP)</b>                      Add \$122 for <b>(MB)</b></p>	<b>R27811</b>	2585	2737	2865	3013	3255	3478	3701	3896	4138	4366	4675	5112																		
		<table border="1"> <thead> <tr> <th colspan="3">OVERALL DIMENSIONS</th> <th colspan="3">SEAT DIMENSIONS</th> <th colspan="2">BACK DIMENSIONS</th> </tr> <tr> <th>W</th><th>D</th><th>H</th> <th>W</th><th>D</th><th>H</th> <th>W</th><th>H</th> </tr> </thead> <tbody> <tr> <td>IN 39</td><td>30.5</td><td>41.5</td> <td>39</td><td>19</td><td>18</td> <td>39</td><td>23.5</td> </tr> <tr> <td>MM 991</td><td>775</td><td>1054</td> <td>991</td><td>483</td><td>457</td> <td>991</td><td>597</td> </tr> </tbody> </table> <p><b>RTA 00</b> 1 per carton</p>	OVERALL DIMENSIONS			SEAT DIMENSIONS			BACK DIMENSIONS		W	D	H	W	D	H	W	H	IN 39	30.5	41.5	39	19	18	39	23.5	MM 991	775	1054	991	483	457
OVERALL DIMENSIONS			SEAT DIMENSIONS			BACK DIMENSIONS																										
W	D	H	W	D	H	W	H																									
IN 39	30.5	41.5	39	19	18	39	23.5																									
MM 991	775	1054	991	483	457	991	597																									
 <p><b>R27811B</b></p> <p><b>Bariatric Lounge Chair - High Back w/Uph Arms</b>                      COM: 6.75 YD   6.17 M                      Unit weight: 97 LB   44.1 KG                      Carton weight: 117.5 LB   53.3 KG                      Carton volume: 42.25 FT<sup>3</sup>   1.19 MT<sup>3</sup></p>	<p>For power/USB unit, please see electrical placement chart.</p> <p>Ganging not available.</p> <p>Add \$120, \$52 for <b>(S2)</b>, <b>(SE)</b>                      Add \$533 for 36 lbs. <b>(CW)</b>                      Add \$83 for <b>(SU)</b> or \$387 for <b>(BS)</b>                      Add \$28 for <b>(TP)</b>                      Add \$122 for <b>(MB)</b></p>	<b>R27811B</b>	3179	3395	3577	3787	4131	4448	4765	5042	5386	5710	6149	6770																		
		<table border="1"> <thead> <tr> <th colspan="3">OVERALL DIMENSIONS</th> <th colspan="3">SEAT DIMENSIONS</th> <th colspan="2">BACK DIMENSIONS</th> </tr> <tr> <th>W</th><th>D</th><th>H</th> <th>W</th><th>D</th><th>H</th> <th>W</th><th>H</th> </tr> </thead> <tbody> <tr> <td>IN 46</td><td>30.5</td><td>41.5</td> <td>39</td><td>19</td><td>18</td> <td>39</td><td>23.5</td> </tr> <tr> <td>MM 1168</td><td>775</td><td>1054</td> <td>991</td><td>483</td><td>457</td> <td>991</td><td>597</td> </tr> </tbody> </table> <p><b>RTA 00</b> 1 per carton</p>	OVERALL DIMENSIONS			SEAT DIMENSIONS			BACK DIMENSIONS		W	D	H	W	D	H	W	H	IN 46	30.5	41.5	39	19	18	39	23.5	MM 1168	775	1054	991	483	457
OVERALL DIMENSIONS			SEAT DIMENSIONS			BACK DIMENSIONS																										
W	D	H	W	D	H	W	H																									
IN 46	30.5	41.5	39	19	18	39	23.5																									
MM 1168	775	1054	991	483	457	991	597																									
 <p><b>R27811L</b>      <b>R27811R</b></p> <p><b>Bariatric Lounge Chair - High Back w/Uph Arms (Left/Right)</b>                      COM: 5.75 YD   5.26 M                      Unit weight: 87 LB   39.5 KG                      Carton weight: 107.5 LB   48.76 KG                      Carton volume: 42.25 FT<sup>3</sup>   1.19 MT<sup>3</sup></p>	<p>For power/USB unit, please see electrical placement chart.</p> <p>Includes ganging hardware (1 side only).</p> <p>Add \$100, \$52 for <b>(S2)</b>, <b>(SE)</b>                      Add \$533 for 36 lbs. <b>(CW)</b>                      Add \$83 for <b>(SU)</b> or \$387 for <b>(BS)</b>                      Add \$28 for <b>(TP)</b>                      Add \$122 for <b>(MB)</b></p>	<b>R27811L</b>	2882	3066	3221	3400	3693	3963	4233	4469	4762	5038	5412	5941																		
		<b>R27811R</b>	2882	3066	3221	3400	3693	3963	4233	4469	4762	5038	5412	5941																		
<table border="1"> <thead> <tr> <th colspan="3">OVERALL DIMENSIONS</th> <th colspan="3">SEAT DIMENSIONS</th> <th colspan="2">BACK DIMENSIONS</th> </tr> <tr> <th>W</th><th>D</th><th>H</th> <th>W</th><th>D</th><th>H</th> <th>W</th><th>H</th> </tr> </thead> <tbody> <tr> <td>IN 42.5</td><td>30.5</td><td>41.5</td> <td>39</td><td>19</td><td>18</td> <td>39</td><td>23.5</td> </tr> <tr> <td>MM 1080</td><td>775</td><td>1054</td> <td>991</td><td>483</td><td>457</td> <td>991</td><td>597</td> </tr> </tbody> </table> <p><b>RTA 00</b> 1 per carton</p>	OVERALL DIMENSIONS			SEAT DIMENSIONS			BACK DIMENSIONS		W	D	H	W	D	H	W	H	IN 42.5	30.5	41.5	39	19	18	39	23.5	MM 1080	775	1054	991	483	457	991	597
OVERALL DIMENSIONS			SEAT DIMENSIONS			BACK DIMENSIONS																										
W	D	H	W	D	H	W	H																									
IN 42.5	30.5	41.5	39	19	18	39	23.5																									
MM 1080	775	1054	991	483	457	991	597																									
 <p><b>R27812</b></p> <p><b>Bariatric Lounge Chair - Extended Back</b>                      COM: 5.25 YD   4.8 M                      Unit weight: 91 LB   41.4 KG                      Carton weight: 115 LB   52.16 KG                      Carton volume: 41 FT<sup>3</sup>   1.16 MT<sup>3</sup></p>	<p>For power/USB unit, please see electrical placement chart.</p> <p>Includes ganging hardware (2 sides).</p> <p>Add \$85, \$52 for <b>(S2)</b>, <b>(SE)</b>                      Add \$533 for 36 lbs. <b>(CW)</b>                      Add \$83 for <b>(SU)</b> or \$387 for <b>(BS)</b>                      Add \$28 for <b>(TP)</b>                      Add \$122 for <b>(MB)</b></p>	<b>R27812</b>	2697	2865	3007	3170	3437	3684	3931	4146	4414	4666	5007	5490																		
		<table border="1"> <thead> <tr> <th colspan="3">OVERALL DIMENSIONS</th> <th colspan="3">SEAT DIMENSIONS</th> <th colspan="2">BACK DIMENSIONS</th> </tr> <tr> <th>W</th><th>D</th><th>H</th> <th>W</th><th>D</th><th>H</th> <th>W</th><th>H</th> </tr> </thead> <tbody> <tr> <td>IN 39</td><td>31</td><td>47</td> <td>39</td><td>19</td><td>18</td> <td>39</td><td>29</td> </tr> <tr> <td>MM 991</td><td>787</td><td>1194</td> <td>991</td><td>483</td><td>457</td> <td>991</td><td>737</td> </tr> </tbody> </table> <p><b>RTA 00</b> 1 per carton</p>	OVERALL DIMENSIONS			SEAT DIMENSIONS			BACK DIMENSIONS		W	D	H	W	D	H	W	H	IN 39	31	47	39	19	18	39	29	MM 991	787	1194	991	483	457
OVERALL DIMENSIONS			SEAT DIMENSIONS			BACK DIMENSIONS																										
W	D	H	W	D	H	W	H																									
IN 39	31	47	39	19	18	39	29																									
MM 991	787	1194	991	483	457	991	737																									
 <p><b>R27812B</b></p> <p><b>Bariatric Lounge Chair - Extended Back w/Uph Arms</b>                      COM: 7.25 YD   6.63 M                      Unit weight: 111 LB   50.5 KG                      Carton weight: 132.5 LB   60.1 KG                      Carton volume: 47.25 FT<sup>3</sup>   1.33 MT<sup>3</sup></p>	<p>For power/USB unit, please see electrical placement chart.</p> <p>Ganging not available.</p> <p>Add \$127, \$52 for <b>(S2)</b>, <b>(SE)</b>                      Add \$533 for 36 lbs. <b>(CW)</b>                      Add \$83 for <b>(SU)</b> or \$387 for <b>(BS)</b>                      Add \$28 for <b>(TP)</b>                      Add \$122 for <b>(MB)</b></p>	<b>R27812B</b>	3291	3523	3719	3944	4313	4654	4995	5292	5662	6010	6481	7148																		
		<table border="1"> <thead> <tr> <th colspan="3">OVERALL DIMENSIONS</th> <th colspan="3">SEAT DIMENSIONS</th> <th colspan="2">BACK DIMENSIONS</th> </tr> <tr> <th>W</th><th>D</th><th>H</th> <th>W</th><th>D</th><th>H</th> <th>W</th><th>H</th> </tr> </thead> <tbody> <tr> <td>IN 46</td><td>31</td><td>47</td> <td>39</td><td>19</td><td>18</td> <td>39</td><td>29</td> </tr> <tr> <td>MM 1168</td><td>787</td><td>1194</td> <td>991</td><td>483</td><td>457</td> <td>991</td><td>737</td> </tr> </tbody> </table> <p><b>RTA 00</b> 1 per carton</p>	OVERALL DIMENSIONS			SEAT DIMENSIONS			BACK DIMENSIONS		W	D	H	W	D	H	W	H	IN 46	31	47	39	19	18	39	29	MM 1168	787	1194	991	483	457
OVERALL DIMENSIONS			SEAT DIMENSIONS			BACK DIMENSIONS																										
W	D	H	W	D	H	W	H																									
IN 46	31	47	39	19	18	39	29																									
MM 1168	787	1194	991	483	457	991	737																									

DESCRIPTION FEATURES MODEL# STANDARD TEXTILE GRADES

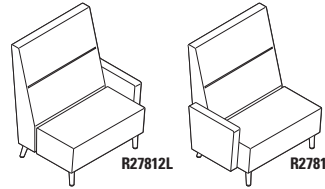

**Bariatric Lounge Chair - Extended Back w/Uph Arms (Left/Right)**  
 COM: 6.25 YD | 5.72 M  
 Unit weight: 101 LB | 45.9 KG  
 Carton weight: 122.5 LB | 55.57 KG  
 Carton volume: 47.25 FT<sup>3</sup> | 1.33 MT<sup>3</sup>

For power/USB unit, please see electrical placement chart.

Includes ganging hardware (1 side only).

Add \$106, \$52 for **(S2)**, **(SE)**  
 Add \$533 for 36 lbs. **(CW)**  
 Add \$83 for **(SU)** or \$387 for **(BS)**  
 Add \$28 for **(TP)**  
 Add \$122 for **(MB)**

	1	2	3	4	5	6	7	8	9	10	11	12
<b>R27812L</b>	2994	3194	3363	3557	3875	4169	4463	4719	5038	5338	5744	6319
<b>R27812R</b>												
<b>OVERALL DIMENSIONS</b>			<b>SEAT DIMENSIONS</b>			<b>BACK DIMENSIONS</b>						
	<b>W</b>	<b>D</b>	<b>H</b>	<b>W</b>	<b>D</b>	<b>H</b>	<b>W</b>	<b>H</b>				
IN	42.5	31	47	39	19	18		39	29			
MM	1080	787	1194	991	483	457		991	737			
<b>RTA 00</b>	1 per carton											

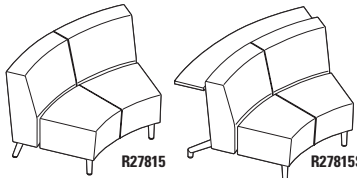

**IS Curve Two Seater - Standard Back**  
 COM: 5 YD | 4.57 M  
 Unit weight: 67 LB | 30.5 KG  
 Carton weight: 93 LB | 42.18 KG  
 Carton volume: 42.75 FT<sup>3</sup> | 1.21 MT<sup>3</sup>

For power/USB unit, please see electrical placement chart.

Includes ganging hardware (2 sides).

Add \$85, \$61 for **(S2)**, **(SE)**  
 Add \$1067 for 72 lbs. **(CW)**, **(C6)**  
 Add \$108 for **(SU)** or \$446 for **(BS)**  
 Add \$35 for **(TP)**  
 Add \$161 for **(MB)**

	1	2	3	4	5	6	7	8	9	10	11	12
<b>R27815</b>	2643	2803	2938	3093	3348	3583	3818	4023	4278	4518	4843	5303
<b>R27815S</b>	3561	3721	3856	4011	4266	4501	4736	4941	5196	5436	5761	6221
shelf model IN W58 D40.5 H32   MM W1473 D1029 H813												
<b>OVERALL DIMENSIONS</b>			<b>SEAT DIMENSIONS</b>			<b>BACK DIMENSIONS</b>						
	<b>W</b>	<b>D</b>	<b>H</b>	<b>W</b>	<b>D</b>	<b>H</b>	<b>W</b>	<b>H</b>				
IN	50.5	30	32	42	19	18		51	14			
MM	1283	762	813	1067	483	457		1295	356			
<b>RTA 00</b>	1 per carton											

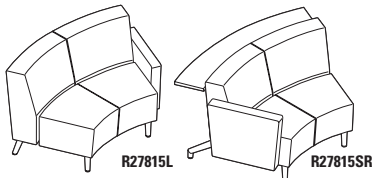

**IS Curve Two Seater - Standard Back w/Uph Arms (Left/Right)**  
 COM: 6 YD | 5.49 M  
 Unit weight: 77 LB | 35 KG  
 Carton weight: 102 LB | 46.27 KG  
 Carton volume: 43.5 FT<sup>3</sup> | 1.23 MT<sup>3</sup>

For power/USB unit, please see electrical placement chart.

Includes ganging hardware (1 side only).

Add \$106, \$61 for **(S2)**, **(SE)**  
 Add \$1067 for 72 lbs. **(CW)**, **(C6)**  
 Add \$108 for **(SU)** or \$446 for **(BS)**  
 Add \$35 for **(TP)**  
 Add \$161 for **(MB)**

	1	2	3	4	5	6	7	8	9	10	11	12
<b>R27815L</b>	2940	3132	3294	3480	3786	4068	4350	4596	4902	5190	5580	6132
<b>R27815R</b>												
<b>R27815SL</b>	3858	4050	4212	4398	4704	4986	5268	5514	5820	6108	6498	7050
<b>R27815SR</b>												
shelf model IN W61.5 D40.5 H32   MM W1562 D1029 H813												
<b>OVERALL DIMENSIONS</b>			<b>SEAT DIMENSIONS</b>			<b>BACK DIMENSIONS</b>						
	<b>W</b>	<b>D</b>	<b>H</b>	<b>W</b>	<b>D</b>	<b>H</b>	<b>W</b>	<b>H</b>				
IN	54	30	32	42	19	18		51	14			
MM	1372	762	813	1067	483	457		1295	356			
<b>RTA 00</b>	1 per carton											

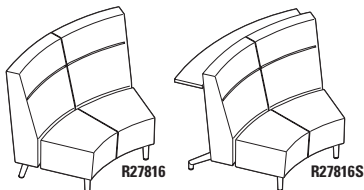

**IS Curve Two Seater - High Back**  
 COM: 6.5 YD | 5.93 M  
 Unit weight: 78 LB | 35.5 KG  
 Carton weight: 106 LB | 48.08 KG  
 Carton volume: 53.75 FT<sup>3</sup> | 1.52 MT<sup>3</sup>

For power/USB unit, please see electrical placement chart.

Includes ganging hardware (2 sides).

Add \$115, \$61 for **(S2)**, **(SE)**  
 Add \$1067 for 72 lbs. **(CW)**, **(C6)**  
 Add \$108 for **(SU)** or \$446 for **(BS)**  
 Add \$35 for **(TP)**  
 Add \$161 for **(MB)**

	1	2	3	4	5	6	7	8	9	10	11	12
<b>R27816</b>	3185	3361	3510	3680	3961	4219	4478	4703	4984	5248	5605	6111
<b>R27816S</b>	4101	4277	4426	4596	4877	5135	5394	5619	5900	6164	6521	7027
shelf model IN W58.5 D41 H41.5   MM W1486 D1041 H1054												
<b>OVERALL DIMENSIONS</b>			<b>SEAT DIMENSIONS</b>			<b>BACK DIMENSIONS</b>						
	<b>W</b>	<b>D</b>	<b>H</b>	<b>W</b>	<b>D</b>	<b>H</b>	<b>W</b>	<b>H</b>				
IN	51	30.5	41.5	42	19	18		51	23.5			
MM	1295	775	1054	1067	483	457		1295	597			
<b>RTA 00</b>	1 per carton											

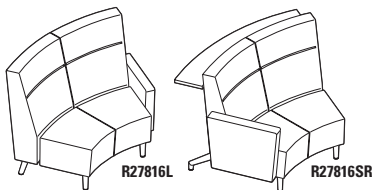

**IS Curve Two Seater - High Back w/Uph Arms (Left/Right)**  
 COM: 6.5 YD | 5.94 M  
 Unit weight: 88 LB | 40 KG  
 Carton weight: 115 LB | 52.16 KG  
 Carton volume: 55.5 FT<sup>3</sup> | 1.57 MT<sup>3</sup>

For power/USB unit, please see electrical placement chart.

Includes ganging hardware (1 side only).

Add \$134, \$61 for **(S2)**, **(SE)**  
 Add \$1067 for 72 lbs. **(CW)**, **(C6)**  
 Add \$108 for **(SU)** or \$446 for **(BS)**  
 Add \$35 for **(TP)**  
 Add \$161 for **(MB)**

	1	2	3	4	5	6	7	8	9	10	11	12
<b>R27816L</b>	3482	3690	3866	4067	4399	4704	5010	5276	5608	5920	6342	6940
<b>R27816R</b>												
<b>R27816SL</b>	4398	4606	4782	4983	5315	5620	5926	6192	6524	6836	7258	7856
<b>R27816SR</b>												
shelf model IN W62 D41 H41.5   MM W1575 D1041 H1054												
<b>OVERALL DIMENSIONS</b>			<b>SEAT DIMENSIONS</b>			<b>BACK DIMENSIONS</b>						
	<b>W</b>	<b>D</b>	<b>H</b>	<b>W</b>	<b>D</b>	<b>H</b>	<b>W</b>	<b>H</b>				
IN	54.5	30.5	41.5	42	19	18		51	23.5			
MM	1384	775	1054	1067	483	457		1295	597			
<b>RTA 00</b>	1 per carton											

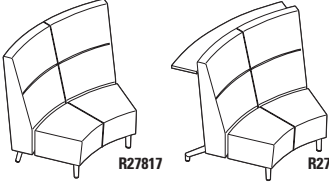
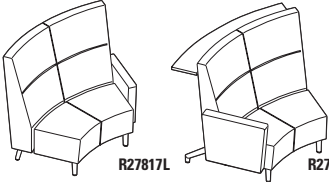
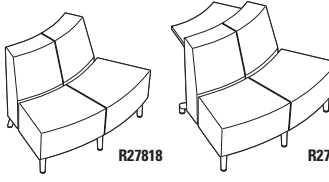
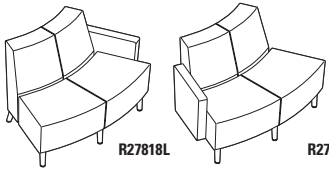
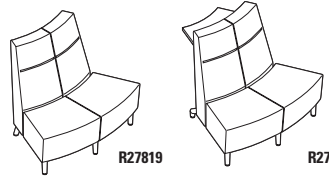
DESCRIPTION	FEATURES	MODEL#	STANDARD TEXTILE GRADES											
			1	2	3	4	5	6	7	8	9	10	11	12
 <p><b>IS Curve Two Seater - Extended Back</b> COM: 6 YD   5.49 M Unit weight: 84 LB   38.2 KG Carton weight: 118 LB   53.52 KG Carton volume: 61 FT<sup>3</sup>   1.72 MT<sup>3</sup></p>	<p>For power/USB unit, please see electrical placement chart.</p> <p>Includes ganging hardware (2 sides).</p> <p>Add \$123, \$61 for (S2), (SE) Add \$1067 for 72 lbs. (CW), (C6) Add \$108 for (SU) or \$446 for (BS) Add \$35 for (TP) Add \$161 for (MB)</p>	<p><b>R27817</b> 3498 3690 3852 4038 4344 4626 4908 5154 5460 5748 6138 6690 <b>R27817S</b> 4414 4606 4768 4954 5260 5542 5824 6070 6376 6664 7054 7606</p> <p>shelf model IN W59 D41.5 H47   MM W1499 D1054 H1194</p>	<p><b>OVERALL DIMENSIONS</b></p> <p>W D H</p>			<p><b>SEAT DIMENSIONS</b></p> <p>W D H</p>			<p><b>BACK DIMENSIONS</b></p> <p>W H</p>					
			<p>IN 51.5 31 47 42 19 18 51 29 MM 1308 787 1194 1067 483 457 1295 737</p> <p><b>RTA 00</b> 1 per carton</p>											
 <p><b>IS Curve Two Seater - Extended Back w/Uph Arms (Left/Right)</b> COM: 7 YD   6.4 M Unit weight: 94 LB   42.7 KG Carton weight: 122 LB   55.34 KG Carton volume: 62.25 FT<sup>3</sup>   1.76 MT<sup>3</sup></p>	<p>For power/USB unit, please see electrical placement chart.</p> <p>Includes ganging hardware (1 side only).</p> <p>Add \$142, \$61 for (S2), (SE) Add \$1067 for 72 lbs. (CW), (C6) Add \$108 for (SU) or \$446 for (BS) Add \$35 for (TP) Add \$161 for (MB)</p>	<p><b>R27817L</b> 3795 4019 4208 4425 4782 5111 5440 5727 6084 6420 6875 7519 <b>R27817R</b> 4711 4935 5124 5341 5698 6027 6356 6643 7000 7336 7791 8435 <b>R27817SL</b> <b>R27817SR</b></p> <p>shelf model IN W62.5 D41.5 H47   MM W1588 D1054 H1194</p>	<p><b>OVERALL DIMENSIONS</b></p> <p>W D H</p>			<p><b>SEAT DIMENSIONS</b></p> <p>W D H</p>			<p><b>BACK DIMENSIONS</b></p> <p>W H</p>					
			<p>IN 54 31 47 42 19 18 51 29 MM 1372 787 1194 1067 483 457 1295 737</p> <p><b>RTA 00</b> 1 per carton</p>											
 <p><b>OS Curve Two Seater - Standard Back</b> COM: 4.25 YD   3.89 M Unit weight: 67 LB   30.5 KG Carton weight: 93 LB   42.18 KG Carton volume: 42.75 FT<sup>3</sup>   1.21 MT<sup>3</sup></p>	<p>For power/USB unit, please see electrical placement chart.</p> <p>Includes ganging hardware (2 sides).</p> <p>Add \$75, \$68 for (S2), (SE) Add \$1067 for 72 lbs. (CW), (C6) Add \$108 for (SU) or \$536 for (BS) Add \$35 for (TP) Add \$161 for (MB)</p>	<p><b>R27818</b> 2699 2835 2950 3082 3298 3498 3698 3872 4089 4293 4569 4960 <b>R27818S</b> 3198 3334 3449 3581 3797 3997 4197 4371 4588 4792 5068 5459</p> <p>shelf model IN W50 D40.5 H32   MM W1270 D1029 H813</p>	<p><b>OVERALL DIMENSIONS</b></p> <p>W D H</p>			<p><b>SEAT DIMENSIONS</b></p> <p>W D H</p>			<p><b>BACK DIMENSIONS</b></p> <p>W H</p>					
			<p>IN 50 30 32 50 19 18 36 14 MM 1270 762 813 1270 483 457 914 356</p> <p><b>RTA 00</b> 1 per carton</p>											
 <p><b>OS Curve Two Seater - Standard Back w/Uph Arms (Left/Right)</b> COM: 5.25 YD   4.8 M Unit weight: 77 LB   35 KG Carton weight: 102 LB   46.27 KG Carton volume: 43.5 FT<sup>3</sup>   1.23 MT<sup>3</sup></p>	<p>For power/USB unit, please see electrical placement chart.</p> <p>Includes ganging hardware (1 side only).</p> <p>Add \$96, \$68 for (S2), (SE) Add \$1067 for 72 lbs. (CW), (C6) Add \$108 for (SU) or \$536 for (BS) Add \$35 for (TP) Add \$161 for (MB)</p>	<p><b>R27818L</b> 2996 3164 3306 3469 3736 3983 4230 4445 4713 4965 5306 5789 <b>R27818R</b></p>	<p><b>OVERALL DIMENSIONS</b></p> <p>W D H</p>			<p><b>SEAT DIMENSIONS</b></p> <p>H W D</p>			<p><b>BACK DIMENSIONS</b></p> <p>H WH</p>					
			<p>IN 53.5 30 32 50 19 18 36 14 MM 1359 762 813 1270 483 457 914 356</p> <p><b>RTA 00</b> 1 per carton</p>											
 <p><b>OS Curve Two Seater - High Back</b> COM: 5.25 YD   4.8 M Unit weight: 73 LB   33.2 KG Carton weight: 101 LB   45.81 KG Carton volume: 53.75 FT<sup>3</sup>   1.52 MT<sup>3</sup></p>	<p>For power/USB unit, please see electrical placement chart.</p> <p>Includes ganging hardware (2 sides).</p> <p>Add \$99, \$68 for (S2), (SE) Add \$1067 for 72 lbs. (CW), (C6) Add \$108 for (SU) or \$536 for (BS) Add \$35 for (TP) Add \$161 for (MB)</p>	<p><b>R27819</b> 3242 3410 3552 3715 3982 4229 4476 4691 4959 5211 5552 6035 <b>R27819S</b> 3741 3909 4051 4214 4481 4728 4975 5190 5458 5710 6051 6534</p> <p>shelf model IN W50 D41 H41.5   MM W1270 D1041 H1054</p>	<p><b>OVERALL DIMENSIONS</b></p> <p>W D H</p>			<p><b>SEAT DIMENSIONS</b></p> <p>W D H</p>			<p><b>BACK DIMENSIONS</b></p> <p>W H</p>					
			<p>IN 50 30.5 41.5 50 19 18 32 23.5 MM 1270 775 1054 1270 483 457 813 597</p> <p><b>RTA 00</b> 1 per carton</p>											

DESCRIPTION FEATURES MODEL# STANDARD TEXTILE GRADES

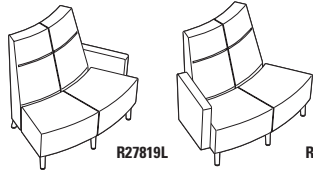

**OS Curve Two Seater - High Back w/Uph Arms (Left/Right)**  
 COM: 6.25 YD | 5.72 M  
 Unit weight: 83 LB | 37.7 KG  
 Carton weight: 110 LB | 49.9 KG  
 Carton volume: 55.5 FT<sup>3</sup> | 1.57 MT<sup>3</sup>

For power/USB unit, please see electrical placement chart.

Includes ganging hardware (1 side only).

Add \$118, \$68 for (S2), (SE)  
 Add \$1067 for 72 lbs. (CW), (C6)  
 Add \$108 for (SU) or \$536 for (BS)  
 Add \$35 for (TP)  
 Add \$161 for (MB)

	1	2	3	4	5	6	7	8	9	10	11	12
<b>R27819L</b>	3539	3739	3908	4102	4420	4714	5008	5264	5583	5883	6289	6864
<b>R27819R</b>												

	OVERALL DIMENSIONS		SEAT DIMENSIONS			BACK DIMENSIONS		
	W	D	H	W	D	H	WH	
IN	53.5	30.5	41.5	50	19	18	32	23.5
MM	1359	775	1054	1270	483	457	813	597

RTA 00 1 per carton

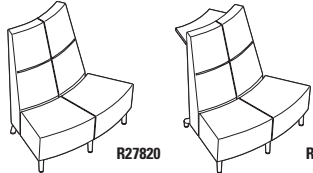

**OS Curve Two Seater - Extended Back**  
 COM: 6.25 YD | 5.72 M  
 Unit weight: 75 LB | 34.1 KG  
 Carton weight: 109 LB | 49.44 KG  
 Carton volume: 61 FT<sup>3</sup> | 1.72 MT<sup>3</sup>

For power/USB unit, please see electrical placement chart.

Includes ganging hardware (2 sides).

Add \$104, \$68 for (S2), (SE)  
 Add \$1067 for 72 lbs. (CW), (C6)  
 Add \$108 for (SU) or \$536 for (BS)  
 Add \$35 for (TP)  
 Add \$161 for (MB)

	1	2	3	4	5	6	7	8	9	10	11	12
<b>R27820</b>	3553	3753	3922	4116	4434	4728	5022	5278	5597	5897	6303	6878
<b>R27820S</b>	4052	4252	4421	4615	4933	5227	5521	5777	6096	6396	6802	7377

shelf model IN W50 D41.5 H47 | MM W1270 D1054 H1194

	OVERALL DIMENSIONS			SEAT DIMENSIONS			BACK DIMENSIONS	
	W	D	H	W	D	H	W	H
IN	50	31	47	50	19	18	28	29
MM	1270	787	1194	1270	483	457	711	737

RTA 00 1 per carton

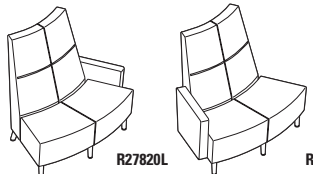

**OS Curve Two Seater - Extended Back w/Uph Arms (Left/Right)**  
 COM: 7.25 YD | 6.63 M  
 Unit weight: 85 LB | 38.6 KG  
 Carton weight: 113 LB | 51.26 KG  
 Carton volume: 62.25 FT<sup>3</sup> | 1.76 MT<sup>3</sup>

For power/USB unit, please see electrical placement chart.

Includes ganging hardware (1 side only).

Add \$126, \$68 for (S2), (SE)  
 Add \$1067 for 72 lbs. (CW), (C6)  
 Add \$108 for (SU) or \$536 for (BS)  
 Add \$35 for (TP)  
 Add \$161 for (MB)

	1	2	3	4	5	6	7	8	9	10	11	12
<b>R27820L</b>	3850	4082	4278	4503	4872	5213	5554	5851	6221	6569	7040	7707
<b>R27820R</b>												

	OVERALL DIMENSIONS		SEAT DIMENSIONS			BACK DIMENSIONS		
	W	D	H	W	D	H	WH	
IN	53.5	31	47	50	19	18	28	29
MM	1359	787	1194	1270	483	457	711	737

RTA 00 1 per carton

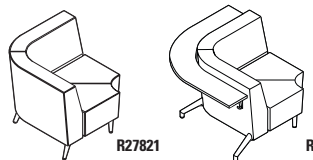

**90° Corner - Standard Back**  
 COM: 6 YD | 5.49 M  
 Unit weight: 79 LB | 35.9 KG  
 Carton weight: 105 LB | 47.63 KG  
 Carton volume: 35.5 FT<sup>3</sup> | 1 MT<sup>3</sup>

No power/USB unit.

Includes ganging hardware (2 sides).

Add \$95, \$47 for (S2), (SE)  
 Add \$533 for 36 lbs. (CW), (C6)  
 Add \$108 for (SU) or \$536 for (BS)  
 Add \$35 for (TP)  
 Add \$161 for (MB)

	1	2	3	4	5	6	7	8	9	10	11	12
<b>R27821</b>	3676	3868	4030	4216	4522	4804	5086	5332	5638	5926	6316	6868
<b>R27821S</b>	4674	4866	5028	5214	5520	5802	6084	6330	6636	6924	7314	7866

shelf model IN W48.5 D48.5 H32 | MM W1232 D1232 H813

	OVERALL DIMENSIONS			SEAT DIMENSIONS			BACK DIMENSIONS	
	W	D	H	W	D	H	W	H
IN	37.5	37.5	32	24	19	18	24	14
MM	953	953	813	610	483	457	610	356

RTA 00 1 per carton

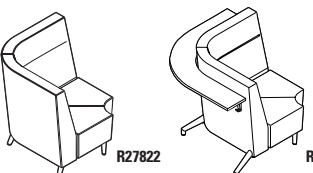

**90° Corner - High Back**  
 COM: 7.75 YD | 7.09 M  
 Unit weight: 95 LB | 43.2 KG  
 Carton weight: 119 LB | 53.98 KG  
 Carton volume: 44.5 FT<sup>3</sup> | 1.26 MT<sup>3</sup>

No power/USB unit.

Includes ganging hardware (2 sides).



Add \$127, \$47 for (S2), (SE)  
 Add \$533 for 36 lbs. (CW), (C6)  
 Add \$108 for (SU) or \$536 for (BS)  
 Add \$35 for (TP)  
 Add \$161 for (MB)

	1	2	3	4	5	6	7	8	9	10	11	12
<b>R27822</b>	4666	4914	5123	5364	5759	6123	6487	6805	7200	7572	8076	8789
<b>R27822S</b>	5664	5912	6121	6362	6757	7121	7485	7803	8198	8570	9074	9787

shelf model IN W49 D49 H41.5 | MM W1245 D1245 H1054

	OVERALL DIMENSIONS			SEAT DIMENSIONS			BACK DIMENSIONS	
	W	D	H	W	D	H	W	H
IN	38.5	38.5	41.5	24	19	18	24	23.5
MM	978	978	1054	610	483	457	610	597

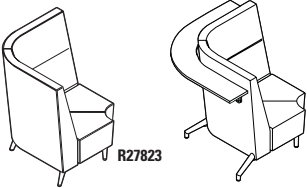
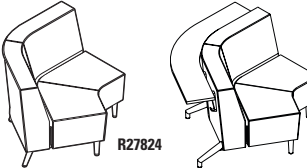
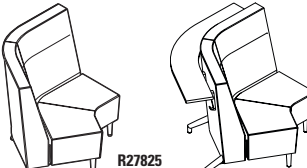
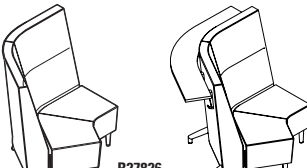
RTA 00 1 per carton

DESCRIPTION	FEATURES	MODEL#	STANDARD TEXTILE GRADES											
			1	2	3	4	5	6	7	8	9	10	11	12
 <p><b>90° Corner - Extended Back</b> COM: 8.25 YD   7.54 M Unit weight: 100 LB   45.5 KG Carton weight: 128 LB   58.06 KG Carton volume: 50.5 FT<sup>3</sup>   1.43 MT<sup>3</sup></p>	<p>No power/USB unit.</p> <p>Includes ganging hardware (2 sides).</p> <p>Add \$131, \$47 for <b>(S2)</b>, <b>(SE)</b> Add \$533 for 36 lbs. <b>(CW)</b>, <b>(C6)</b> Add \$108 for <b>(SU)</b> or \$536 for <b>(BS)</b> Add \$35 for <b>(TP)</b> Add \$161 for <b>(MB)</b></p>	<b>R27823</b>	5181	5445	5668	5924	6344	6732	7120	7458	7879	8275	8811	9570
		<b>R27823S</b>	6179	6443	6666	6922	7342	7730	8118	8456	8877	9273	9809	10568
			shelf model IN W49.5 D49.5 H47   MM W1257 D1257 H1194											
			<b>OVERALL DIMENSIONS</b>			<b>SEAT DIMENSIONS</b>			<b>BACK DIMENSIONS</b>					
			<b>W</b>	<b>D</b>	<b>H</b>	<b>W</b>	<b>D</b>	<b>H</b>	<b>W</b>	<b>H</b>				
			IN 39	39	47	24	19	18	24	29				
			MM 991	991	1194	610	483	457	610	737				
			<b>RTA 00</b>	1 per carton										
 <p><b>120° Corner - Standard Back</b> COM: 6 YD   5.49 M Unit weight: 80 LB   36.4 KG Carton weight: 109 LB   49.44 KG Carton volume: 48.25 FT<sup>3</sup>   1.36 MT<sup>3</sup></p>	<p>No power/USB unit.</p> <p>Includes ganging hardware (2 sides).</p> <p>Add \$91, \$63 for <b>(S2)</b>, <b>(SE)</b> Add \$533 for 36 lbs. <b>(CW)</b>, <b>(C6)</b> Add \$117 for <b>(SU)</b> or \$596 for <b>(BS)</b> Add \$35 for <b>(TP)</b> Add \$161 for <b>(MB)</b></p>	<b>R27824</b>	3676	3868	4030	4216	4522	4804	5086	5332	5638	5926	6316	6868
		<b>R27824S</b>	4612	4804	4966	5152	5458	5740	6022	6268	6574	6862	7252	7804
			shelf model IN W62.5 D40.5 H32   MM W1588 D1029 H813											
			<b>OVERALL DIMENSIONS</b>			<b>SEAT DIMENSIONS</b>			<b>BACK DIMENSIONS</b>					
			<b>W</b>	<b>D</b>	<b>H</b>	<b>W</b>	<b>D</b>	<b>H</b>	<b>W</b>	<b>H</b>				
			IN 52.5	30	32	52	19	18	52	14				
			MM 1334	762	813	1321	483	457	1321	356				
			<b>RTA 00</b>	1 per carton										
 <p><b>120° Corner - High Back</b> COM: 7.75 YD   7.09 M Unit weight: 89 LB   40.5 KG Carton weight: 118 LB   53.52 KG Carton volume: 60.5 FT<sup>3</sup>   1.71 MT<sup>3</sup></p>	<p>No power/USB unit.</p> <p>Includes ganging hardware (2 sides).</p> <p>Add \$120, \$63 for <b>(S2)</b>, <b>(SE)</b> Add \$533 for 36 lbs. <b>(CW)</b>, <b>(C6)</b> Add \$117 for <b>(SU)</b> or \$596 for <b>(BS)</b> Add \$35 for <b>(TP)</b> Add \$161 for <b>(MB)</b></p>	<b>R27825</b>	4666	4914	5123	5364	5759	6123	6487	6805	7200	7572	8076	8789
		<b>R27825S</b>	5602	5850	6059	6300	6695	7059	7423	7741	8136	8508	9012	9725
			shelf model IN W63.5 D41 H41.5   MM W1613 D1041 H1054											
			<b>OVERALL DIMENSIONS</b>			<b>SEAT DIMENSIONS</b>			<b>BACK DIMENSIONS</b>					
			<b>W</b>	<b>D</b>	<b>H</b>	<b>W</b>	<b>D</b>	<b>H</b>	<b>W</b>	<b>H</b>				
			IN 53.5	30.5	41.5	41	21	18	51	23.5				
			MM 1359	775	1054	1041	533	457	1295	597				
			<b>RTA 00</b>	1 per carton										
 <p><b>120° Corner - Extended Back</b> COM: 8.25 YD   7.54 M Unit weight: 91 LB   41.4 KG Carton weight: 123 LB   55.79 KG Carton volume: 68.75 FT<sup>3</sup>   1.94 MT<sup>3</sup></p>	<p>No power/USB unit.</p> <p>Includes ganging hardware (2 sides).</p> <p>Add \$129, \$63 for <b>(S2)</b>, <b>(SE)</b> Add \$533 for 36 lbs. <b>(CW)</b>, <b>(C6)</b> Add \$117 for <b>(SU)</b> or \$596 for <b>(BS)</b> Add \$35 for <b>(TP)</b> Add \$161 for <b>(MB)</b></p>	<b>R27826</b>	5181	5445	5668	5924	6344	6732	7120	7458	7879	8275	8811	9570
		<b>R27826S</b>	6116	6380	6603	6859	7279	7667	8055	8393	8814	9210	9746	10505
			shelf model IN W64 D41.5 H47   MM W1626 D1054 H1194											
			<b>OVERALL DIMENSIONS</b>			<b>SEAT DIMENSIONS</b>			<b>BACK DIMENSIONS</b>					
			<b>W</b>	<b>D</b>	<b>H</b>	<b>W</b>	<b>D</b>	<b>H</b>	<b>W</b>	<b>H</b>				
			IN 54	31.5	47	41	21	18	51	29				
			MM 1372	800	1194	1041	533	457	1295	737				
			<b>RTA 00</b>	1 per carton										
 <p><b>Loop Arm</b> COM: N/A Unit weight: 5 LB   2.3 KG Carton weight: 7 LB   3.18 KG Carton volume: 0.6 FT<sup>3</sup>   0.01 MT<sup>3</sup></p>	<p>Arms sold separately (1 pc).</p>	List price												
		<b>R2770</b>	238											
			<b>OVERALL DIMENSIONS</b>			<b>SEAT DIMENSIONS</b>			<b>BACK DIMENSIONS</b>					
			<b>W</b>	<b>D</b>	<b>H</b>	<b>W</b>	<b>D</b>	<b>H</b>	<b>W</b>	<b>H</b>				
			IN 2.5	14	19.5	-	-	-	-	-				
			MM 64	356	495	-	-	-	-	-				
			<b>RTA 1</b>	1 per carton										

DESCRIPTION	FEATURES	MODEL#	STANDARD TEXTILE GRADES						
 <p><b>Loop Arm w/Armcap</b>                      COM: N/A                      Unit weight: 5 LB   2.3 KG                      Carton weight: 7 LB   3.18 KG                      Carton volume: 0.6 FT<sup>3</sup>   0.01 MT<sup>3</sup></p>	<p>Arms sold separately (1 pc).                      Armcap finish:                      (BK) Night, (FO) Fog, (LB) Latte</p>	List price							
		<b>R2771</b>	274						
		OVERALL DIMENSIONS			SEAT DIMENSIONS			BACK DIMENSIONS	
		W	D	H	W	D	H	W	H
IN 2.5	14	19.5	-	-	-	-	-		
MM 64	356	495	-	-	-	-	-		
		<b>RTA 1</b>	1 per carton						



RIVER+ BENCHES



model R27832

model R27842



model R27845

model R27840

River+ Seating & Tables



For River+ seating, please see page 277.  
For River+ tables, please see page 296.

EXAMPLE RIVER+ BENCH ORDER CODE:

R27832	-NS	-CE90	-CHM	-S6	-AS	-NC
Model number	Sealed Seams	Textile	Leg finish	Leg selection	Leg angle	Additional weight
-SB	-W	-F1				
Bottom selection	Power finish	Power/USB position				

Additional Options specify at end of order code.	SPECIFY CODE
<b>Tamperproof fasteners</b> Upcharges vary, see model.	<b>TP</b>
<b>Moisture barrier</b> Upcharges vary, see model.	<b>MB</b>

\*linking hardware is lowered to clear the staple strip.  
Units will only gang with other units with sealed bottom.  
\*\*cannot be combined with linking hardware or power units

STANDARD FEATURES

- A modular series that is composed of straight, and curved sections, as well as freestanding units.
- Linking units can be used together in any combination to create a wide variety of layouts. Ganging hardware is standard and is factory installed. Ganging hardware swivels out of the way when not in use.
- The unique tapered legs are made of welded steel, with each leg bolted directly to the unit frame. Standard leg height of 6.5". The leg height makes it easier to clean under the product.
- Legs are straight (vertical) as standard. Linking models are optionally available with angled back legs to match River+ seating units.
- Legs are standard in Chrome with Black nylon non-marking height adjustable glides.
- River+ is rated for an active weight up to 600 lbs. per seat and 24/7 use.
- For heavy duty application, Global's Limited Lifetime Warranty is applicable only on fabrics that are rated for 100,000 double rubs.
- Upholstery options: fabric, vinyl or leather. Vinyl and leather models may feature stitch detail across the seat and/or back cushions, if applicable.
- All units are shipped fully assembled.

OPTIONAL FEATURES

- To add sealed seams to your product, please specify **(SS)** - see each model for upcharge.
  - Legs are available in 3" and 8" heights. All heights are available with fixed-to-floor option. Please specify. Upcharges vary. *Fastening hardware not included.*
  - Products can be weighted to reduce the ease of movement. For additional weight options, please specify **(CW)** - see each model for available additional weight and upcharge.
  - The underside of the seat can be finished with PVC (vinyl) and sealed to prevent penetration of liquids. Please specify **(SU)** - see each model for upcharge.
  - Steel bottom provides tamperproof protection (includes tamperproof screws). Please specify **(BS)** - see each model for upcharge.
  - Most benches (except corner and freestanding units) can be specified with power/USB units, which include one power outlet, one double USB terminal and a Black 120" three-prong power cord.
  - Each power/USB unit is set in predetermined locations, as shown in the electrical illustrations below. Electrical units must be factory installed. Add \$717 per unit.
  - Power/USB units are available with either Jet Black **(J)** face plate with Black power/USB receptacles or with a White **(W)** face plate with White power/USB receptacles.
- **Model number**  
**R27831 to R27833** Straight benches  
**R27834 to R27835** Curved benches  
**R27836 to R27839** Corner benches  
**R27840 to R27841** Boomerang benches  
**R27842** Y bench  
**R27843 to R27846** Round non-linking benches  
**R27847 to R27850** Square non-linking benches
  - **Seat sealed seams**  
**(NS)** Standard seams.  
**(SS)** Sealed seams. Upcharges vary, see model.
  - **Textile**  
Specify textile code.
  - **Leg finish**  
For leg finish options, please see page 360. No upcharges.
  - **Leg selection**  
**(S6)** Standard seat height (17.5"), 6.5" leg w/ adjustable glides. No upcharge.  
**(S3)** Low seat (14"), 3" leg w/adjustable glides. No upcharge.  
**(S8)** High seat (19"), 8" leg w/adjustable glides. No upcharge.  
**(F6)** Standard seat height (17.5"), 6.5" leg, fixed to floor. Upcharges vary.  
**(F3)** Low seat (14"), 3" leg, fixed to floor. Upcharges vary.  
**(F8)** High seat (19"), 8" leg, fixed to floor. Upcharges vary.
  - **Leg angle**  
**(AS)** Straight legs. No upcharge.  
**(SA)** Straight front legs, angled back legs (available only for 6.5" and 8" high legs on straight, curved, corner and boomerang units). No upcharge.
  - **Additional weight**  
**(NC)** No additional weight.  
**(CW)** Additional weight. Upcharges vary, see model.
  - **Bottom selection**  
**(SB)** Standard bottom.  
**(SU)** Vinyl sealed bottom w/staple strip. Upcharges vary, see model.\*  
**(BS)** Steel bottom. Upcharges vary, see model.\*\*
  - **Power unit finish**  
**(NP)** No power  
**(J)** Jet Black  
**(W)** White
  - **Power/USB unit position** (straight, curved, boomerang and Y benches only, as shown below). Add \$717 per unit.  
**(F1)** Front left  
**(F2)** Front right  
**(B1)** Back left  
**(B2)** Back right

Please add option codes in the following order:

ELECTRICAL PLACEMENT

Straight benches

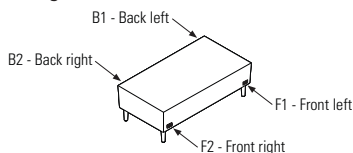

Y bench

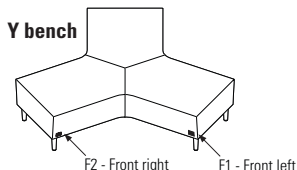



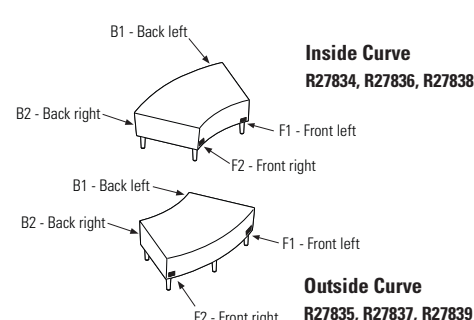

Curved benches

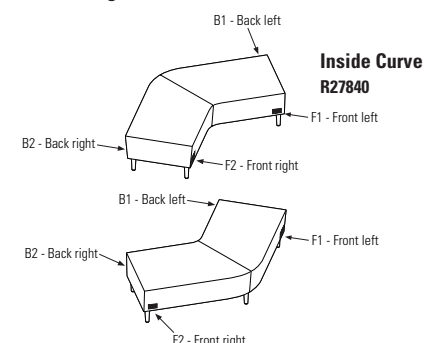

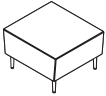
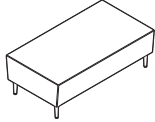
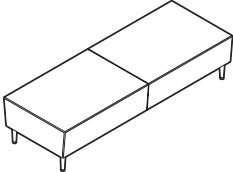
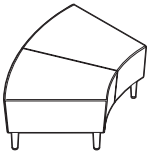

Boomerang benches

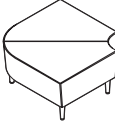
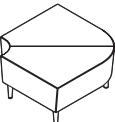

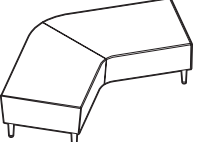
DESCRIPTION	FEATURES	MODEL#	STANDARD TEXTILE GRADES														
			1	2	3	4	5	6	7	8	9	10	11	12			
 <p><b>Single Seater Bench</b> COM: 1.75 YD   1.6 M Unit weight: 40 LB   18.2 KG Carton weight: 48 LB   21.77 KG Carton volume: 10.5 FT<sup>3</sup>   0.29 MT<sup>3</sup></p>	<p>For power/USB unit, please see electrical placement chart.</p> <p>Includes ganging hardware (2 sides).</p> <p>Add \$47 for (SS) Add \$90 for (F_) Add \$533 for 36 lbs. (CW) Add \$47 for (SU) or \$247 for (BS) Add \$28 for (TP) Add \$81 for (MB)</p>	<p><b>R27831</b></p>	1157	1213	1260	1315	1404	1486	1568	1640	1729	1813	1927	2088			
			OVERALL DIMENSIONS			SEAT DIMENSIONS			BACK DIMENSIONS								
			W	D	H	W	D	H	W	H							
			IN 26 MM 660	28.5 724	17.5 445	-	-	-	-	-	-	-	-	-	-	-	
			<b>RTA 00</b>	1 per carton													
 <p><b>Two Seater Bench</b> COM: 2.75 YD   2.51 M Unit weight: 55 LB   25 KG Carton weight: 65 LB   29.48 KG Carton volume: 20.5 FT<sup>3</sup>   0.58 MT<sup>3</sup></p>	<p>For power/USB unit, please see electrical placement chart.</p> <p>Includes ganging hardware (2 sides).</p> <p>Add \$59 for (SS) Add \$90 for (F_) Add \$1067 for 72 lbs. (CW) Add \$72 for (SU) or \$407 for (BS) Add \$28 for (TP) Add \$161 for (MB)</p>	<p><b>R27832</b></p>	1796	1884	1958	2044	2184	2313	2442	2555	2695	2827	3006	3259			
			OVERALL DIMENSIONS			SEAT DIMENSIONS			BACK DIMENSIONS								
			W	D	H	W	D	H	W	H							
			IN 52 MM 1321	28.5 724	17.5 445	-	-	-	-	-	-	-	-	-	-	-	
			<b>RTA 00</b>	1 per carton													
 <p><b>Three Seater Bench</b> COM: 4.5 YD   4.11 M Unit weight: 88 LB   40 KG Carton weight: 103 LB   46.72 KG Carton volume: 30.25 FT<sup>3</sup>   0.85 MT<sup>3</sup></p>	<p>For power/USB unit, please see electrical placement chart.</p> <p>Includes ganging hardware (2 sides).</p> <p>Add \$88 for (SS) Add \$90 for (F_) Add \$1067 for 72 lbs. (CW) Add \$101 for (SU) or \$521 for (BS) Add \$28 for (TP) Add \$243 for (MB)</p>	<p><b>R27833</b></p>	2489	2633	2755	2894	3124	3335	3547	3731	3961	4177	4469	4883			
			OVERALL DIMENSIONS			SEAT DIMENSIONS			BACK DIMENSIONS								
			W	D	H	W	D	H	W	H							
			IN 78 MM 1981	28.5 724	17.5 445	-	-	-	-	-	-	-	-	-	-	-	
			<b>RTA 00</b>	1 per carton													
 <p><b>Inside Curve Two Seater Bench</b> COM: 3 YD   2.74 M Unit weight: 49 LB   22.3 KG Carton weight: 60 LB   27.22 KG Carton volume: 22.75 FT<sup>3</sup>   0.64 MT<sup>3</sup></p>	<p>For power/USB unit, please see electrical placement chart.</p> <p>Includes ganging hardware (2 sides).</p> <p>Add \$55 for (SS) Add \$113 for (F_) Add \$1067 for 72 lbs. (CW) Add \$72 for (SU) or \$327 for (BS) Add \$35 for (TP) Add \$161 for (MB)</p>	<p><b>R27834</b></p>	2609	2705	2786	2879	3032	3173	3314	3437	3590	3734	3929	4205			
			OVERALL DIMENSIONS			SEAT DIMENSIONS			BACK DIMENSIONS								
			W	D	H	W	D	H	W	H							
			IN 50 MM 1270	30.5 775	17.5 445	-	-	-	-	-	-	-	-	-	-	-	
			<b>RTA 00</b>	1 per carton													
 <p><b>Outside Curve Two Seater Bench</b> COM: 3 YD   2.74 M Unit weight: 49 LB   22.3 KG Carton weight: 60 LB   27.22 KG Carton volume: 22.75 FT<sup>3</sup>   0.64 MT<sup>3</sup></p>	<p>For power/USB unit, please see electrical placement chart.</p> <p>Includes ganging hardware (2 sides).</p> <p>Add \$55 for (SS) Add \$113 for (F_) Add \$1067 for 72 lbs. (CW) Add \$72 for (SU) or \$327 for (BS) Add \$35 for (TP) Add \$161 for (MB)</p>	<p><b>R27835</b></p>	2609	2705	2786	2879	3032	3173	3314	3437	3590	3734	3929	4205			
			OVERALL DIMENSIONS			SEAT DIMENSIONS			BACK DIMENSIONS								
			W	D	H	W	D	H	W	H							
			IN 50 MM 1270	30.5 775	17.5 445	-	-	-	-	-	-	-	-	-	-	-	
			<b>RTA 00</b>	1 per carton													

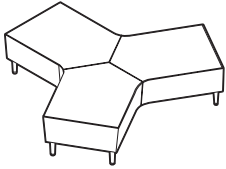
DESCRIPTION	FEATURES	MODEL#	STANDARD TEXTILE GRADES													
			1	2	3	4	5	6	7	8	9	10	11	12		
 <p><b>90° Inside Curve Corner Bench</b> COM: 3.25 YD   2.97 M Unit weight: 49 LB   22.3 KG Carton weight: 60 LB   27.22 KG Carton volume: 17.25 FT<sup>3</sup>   0.48 MT<sup>3</sup></p>	<p>For power/USB unit, please see electrical placement chart.</p> <p>Includes ganging hardware (2 sides).</p> <p>Add \$55 for (SS) Add \$113 for (F_) Add \$533 for 36 lbs. (CW) Add \$83 for (SU) or \$382 for (BS) Add \$35 for (TP) Add \$161 for (MB)</p>	<b>R27836</b>	2609	2713	2801	2902	3067	3220	3373	3506	3672	3828	4039	4338		
		<b>OVERALL DIMENSIONS</b>			<b>SEAT DIMENSIONS</b>			<b>BACK DIMENSIONS</b>								
		W D H			W D H			W H								
		IN 36.5 36.5 17.5			- - -			- - -								
		MM 927 927 445			- - -			- - -								
			<b>RTA 00</b>			1 per carton										
 <p><b>90° Outside Curve Corner Bench</b> COM: 3.25 YD   2.97 M Unit weight: 49 LB   22.3 KG Carton weight: 60 LB   27.22 KG Carton volume: 17.25 FT<sup>3</sup>   0.48 MT<sup>3</sup></p>	<p>For power/USB unit, please see electrical placement chart.</p> <p>Includes ganging hardware (2 sides).</p> <p>Add \$55 for (SS) Add \$113 for (F_) Add \$533 for 36 lbs. (CW) Add \$83 for (SU) or \$382 for (BS) Add \$35 for (TP) Add \$161 for (MB)</p>	<b>R27837</b>	2609	2713	2801	2902	3067	3220	3373	3506	3672	3828	4039	4338		
		<b>OVERALL DIMENSIONS</b>			<b>SEAT DIMENSIONS</b>			<b>BACK DIMENSIONS</b>								
		W D H			W D H			W H								
		IN 36.5 36.5 17.5			- - -			- - -								
		MM 927 927 445			- - -			- - -								
			<b>RTA 00</b>			1 per carton										
 <p><b>120° Inside Curve Corner Bench</b> COM: 3.5 YD   3.2 M Unit weight: 46 LB   20.9 KG Carton weight: 57 LB   25.85 KG Carton volume: 26.75 FT<sup>3</sup>   0.75 MT<sup>3</sup></p>	<p>For power/USB unit, please see electrical placement chart.</p> <p>Includes ganging hardware (2 sides).</p> <p>Add \$57 for (SS) Add \$113 for (F_) Add \$533 for 36 lbs. (CW) Add \$83 for (SU) or \$421 for (BS) Add \$35 for (TP) Add \$161 for (MB)</p>	<b>R27838</b>	2609	2721	2816	2924	3103	3267	3432	3575	3754	3922	4149	4471		
		<b>OVERALL DIMENSIONS</b>			<b>SEAT DIMENSIONS</b>			<b>BACK DIMENSIONS</b>								
		W D H			W D H			W H								
		IN 36.5 51.5 17.5			- - -			- - -								
		MM 927 1308 445			- - -			- - -								
			<b>RTA 00</b>			1 per carton										
 <p><b>120° Outside Curve Corner Bench</b> COM: 3.5 YD   3.2 M Unit weight: 46 LB   20.9 KG Carton weight: 57 LB   25.85 KG Carton volume: 26.75 FT<sup>3</sup>   0.75 MT<sup>3</sup></p>	<p>For power/USB unit, please see electrical placement chart.</p> <p>Includes ganging hardware (2 sides).</p> <p>Add \$57 for (SS) Add \$113 for (F_) Add \$533 for 36 lbs. (CW) Add \$83 for (SU) or \$421 for (BS) Add \$35 for (TP) Add \$161 for (MB)</p>	<b>R27839</b>	2609	2721	2816	2924	3103	3267	3432	3575	3754	3922	4149	4471		
		<b>OVERALL DIMENSIONS</b>			<b>SEAT DIMENSIONS</b>			<b>BACK DIMENSIONS</b>								
		W D H			W D H			W H								
		IN 36.5 51.5 17.5			- - -			- - -								
		MM 927 1308 445			- - -			- - -								
			<b>RTA 00</b>			1 per carton										
 <p><b>Inside Curve Boomerang Bench</b> COM: 5.25 YD   4.8 M Unit weight: 84 LB   38.2 KG Carton weight: 126 LB   57.15 KG Carton volume: 47.75 FT<sup>3</sup>   1.35 MT<sup>3</sup></p>	<p>For power/USB unit, please see electrical placement chart.</p> <p>Includes ganging hardware (2 sides).</p> <p>Add \$84 for (SS) Add \$113 for (F_) Add \$1067 for 72 lbs. (CW) Add \$114 for (SU) or \$736 for (BS) Add \$35 for (TP) Add \$243 for (MB)</p>	<b>R27840</b>	3233	3401	3543	3706	3973	4220	4467	4682	4950	5202	5543	6026		
		<b>OVERALL DIMENSIONS</b>			<b>SEAT DIMENSIONS</b>			<b>BACK DIMENSIONS</b>								
		W D H			W D H			W H								
		IN 82 45 17.5			- - -			- - -								
		MM 2083 1143 445			- - -			- - -								
			<b>RTA 00</b>			1 per carton										

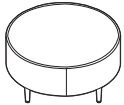
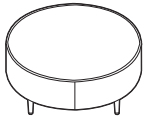
DESCRIPTION	FEATURES	MODEL#	STANDARD TEXTILE GRADES													
			1	2	3	4	5	6	7	8	9	10	11	12		
 <p><b>Outside Curve Boomerang Bench</b> COM: 5.25 YD   4.8 M Unit weight: 84 LB   38.2 KG Carton weight: 126 LB   57.15 KG Carton volume: 47.75 FT<sup>3</sup>   1.35 MT<sup>3</sup></p>	<p>For power/USB unit, please see electrical placement chart.</p> <p>Includes ganging hardware (2 sides).</p> <p>Add \$84 for (SS) Add \$113 for (F_) Add \$1067 for 72 lbs. (CW) Add \$114 for (SU) or \$736 for (BS) Add \$35 for (TP) Add \$243 for (MB)</p>	<b>R27841</b>	3233	3401	3543	3706	3973	4220	4467	4682	4950	5202	5543	6026		
		<b>OVERALL DIMENSIONS</b>			<b>SEAT DIMENSIONS</b>			<b>BACK DIMENSIONS</b>								
		W D H			W D H			W H								
		IN 82 45 17.5			- - -			- - -								
		MM 2083 1143 445			- - -			- - -								
		<b>RTA 00</b>	1 per carton													
 <p><b>Y Bench</b> COM: 8 YD   7.32 M Unit weight: 122 LB   55.5 KG Carton weight: 203 LB   92.08 KG Carton volume: 101.25 FT<sup>3</sup>   2.86 MT<sup>3</sup></p>	<p>For power/USB unit, please see electrical placement chart.</p> <p>Includes ganging hardware (2 sides).</p> <p>Add \$141 for (SS) Add \$158 for (F_) Add \$800 for 54 lbs. (CW) Add \$179 for (SU) or \$917 for (BS) Add \$51 for (TP) Add \$324 for (MB)</p>	<b>R27842</b>	5623	5879	6095	6343	6751	7127	7503	7831	8239	8623	9143	9879		
		<b>OVERALL DIMENSIONS</b>			<b>SEAT DIMENSIONS</b>			<b>BACK DIMENSIONS</b>								
		W D H			W D H			W H								
		IN 82 70 17.5			- - -			- - -								
		MM 2083 1778 445			- - -			- - -								
		<b>RTA 00</b>	1 per carton													
 <p><b>18" Dia. Round Bench</b> COM: 1 YD   0.91 M Unit weight: 20 LB   9.1 KG Carton weight: 25 LB   11.34 KG Carton volume: 4.7 FT<sup>3</sup>   0.13 MT<sup>3</sup></p>	<p>No power/USB unit.</p> <p>Freestanding unit only.</p> <p>Add \$31 for (SS) Add \$90 for (F_) Not available (CW) Add \$35 for (SU), (BS) not available Add \$28 for (TP) Add \$81 for (MB)</p>	<b>R27843</b>	686	718	745	776	827	874	921	962	1013	1061	1126	1218		
		<b>OVERALL DIMENSIONS</b>			<b>SEAT DIMENSIONS</b>			<b>BACK DIMENSIONS</b>								
		W D H			W D H			W H								
		IN 18 18 17.5			- - -			- - -								
		MM 457 457 445			- - -			- - -								
		<b>RTA 00</b>	1 per carton													
 <p><b>36" Dia. Round Bench</b> COM: 3.25 YD   2.97 M Unit weight: 41 LB   18.6 KG Carton weight: 50 LB   22.68 KG Carton volume: 18.25 FT<sup>3</sup>   0.51 MT<sup>3</sup></p>	<p>No power/USB unit.</p> <p>Freestanding unit only.</p> <p>Add \$51 for (SS) Add \$90 for (F_) Add \$533 for 36 lbs. (CW) Add \$72 for (SU) or \$422 for (BS) Add \$28 for (TP) Add \$81 for (MB)</p>	<b>R27844</b>	1546	1650	1738	1839	2004	2157	2310	2443	2609	2765	2976	3275		
		<b>OVERALL DIMENSIONS</b>			<b>SEAT DIMENSIONS</b>			<b>BACK DIMENSIONS</b>								
		W D H			W D H			W H								
		IN 36 36 17.5			- - -			- - -								
		MM 914 914 445			- - -			- - -								
		<b>RTA 00</b>	1 per carton													
 <p><b>42" Dia. Round Bench</b> COM: 3.5 YD   3.2 M Unit weight: 45 LB   20.5 KG Carton weight: 55 LB   24.95 KG Carton volume: 23 FT<sup>3</sup>   0.65 MT<sup>3</sup></p>	<p>No power/USB unit.</p> <p>Freestanding unit only.</p> <p>Add \$55 for (SS) Add \$90 for (F_) Add \$1067 for 72 lbs. (CW) Add \$83 for (SU) or \$461 for (BS) Add \$28 for (TP) Add \$161 for (MB)</p>	<b>R27845</b>	1813	1925	2020	2128	2307	2471	2636	2779	2958	3126	3353	3675		
		<b>OVERALL DIMENSIONS</b>			<b>SEAT DIMENSIONS</b>			<b>BACK DIMENSIONS</b>								
		W D H			W D H			W H								
		IN 42 42 17.5			- - -			- - -								
		MM 1067 1067 445			- - -			- - -								
		<b>RTA 00</b>	1 per carton													

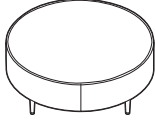
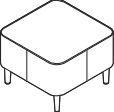
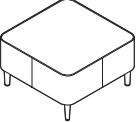
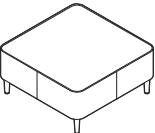
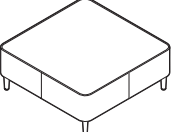
DESCRIPTION	FEATURES	MODEL#	STANDARD TEXTILE GRADES														
			1	2	3	4	5	6	7	8	9	10	11	12			
 <p><b>48" Dia. Round Bench</b> COM: 3.75 YD   3.43 M Unit weight: 55 LB   25 KG Carton weight: 65 LB   29.48 KG Carton volume: 30 FT<sup>3</sup>   0.84 MT<sup>3</sup></p>	<p>No power/USB unit.</p> <p>Freestanding unit only.</p> <p>Add \$59 for <b>(SS)</b> Add \$90 for <b>(F_)</b> Add \$1067 for 72 lbs. <b>(CW)</b> Add \$101 for <b>(SU)</b> or \$491 for <b>(BS)</b> Add \$28 for <b>(TP)</b> Add \$243 for <b>(MB)</b></p>	<b>R27846</b>	2130	2250	2351	2468	2659	2835	3011	3165	3356	3536	3780	4125			
			OVERALL DIMENSIONS			SEAT DIMENSIONS			BACK DIMENSIONS								
			W	D	H	W	D	H	W	H							
			IN 48	48	17.5	-	-	-	-	-							
			MM 1219	1219	445	-	-	-	-	-							
	<b>RTA 00</b>		1 per carton														
 <p><b>24" Square Bench</b> COM: 1.5 YD   1.37 M Unit weight: 25 LB   11.4 KG Carton weight: 30 LB   13.61 KG Carton volume: 8 FT<sup>3</sup>   0.22 MT<sup>3</sup></p>	<p>No power/USB unit.</p> <p>Freestanding unit only.</p> <p>Add \$43 for <b>(SS)</b> Add \$90 for <b>(F_)</b> Add \$533 for 36 lbs. <b>(CW)</b> Add \$38 for <b>(SU)</b> or \$189 for <b>(BS)</b> Add \$28 for <b>(TP)</b> Add \$81 for <b>(MB)</b></p>	<b>R27847</b>	968	1016	1057	1103	1180	1250	1321	1382	1459	1531	1628	1766			
			OVERALL DIMENSIONS			SEAT DIMENSIONS			BACK DIMENSIONS								
			W	D	H	W	D	H	W	H							
			IN 24	24	17.5	-	-	-	-	-							
			MM 610	610	445	-	-	-	-	-							
	<b>RTA 00</b>		1 per carton														
 <p><b>30" Square Bench</b> COM: 2.75 YD   2.51 M Unit weight: 30 LB   13.6 KG Carton weight: 40 LB   18.14 KG Carton volume: 12.25 FT<sup>3</sup>   0.34 MT<sup>3</sup></p>	<p>No power/USB unit.</p> <p>Freestanding unit only.</p> <p>Add \$51 for <b>(SS)</b> Add \$90 for <b>(F_)</b> Add \$1067 for 36 lbs. <b>(CW)</b> Add \$72 for <b>(SU)</b> or \$233 for <b>(BS)</b> Add \$28 for <b>(TP)</b> Add \$81 for <b>(MB)</b></p>	<b>R27848</b>	1290	1378	1452	1538	1678	1807	1936	2049	2189	2321	2500	2753			
			OVERALL DIMENSIONS			SEAT DIMENSIONS			BACK DIMENSIONS								
			W	D	H	W	D	H	W	H							
			IN 30	30	17.5	-	-	-	-	-							
			MM 762	762	445	-	-	-	-	-							
	<b>RTA 00</b>		1 per carton														
 <p><b>36" Square Bench</b> COM: 3 YD   2.74 M Unit weight: 40 LB   18.2 KG Carton weight: 50 LB   22.68 KG Carton volume: 18.25 FT<sup>3</sup>   0.51 MT<sup>3</sup></p>	<p>No power/USB unit.</p> <p>Freestanding unit only.</p> <p>Add \$55 for <b>(SS)</b> Add \$90 for <b>(F_)</b> Add \$1067 for 72 lbs. <b>(CW)</b> Add \$77 for <b>(SU)</b> or \$311 for <b>(BS)</b> Add \$28 for <b>(TP)</b> Add \$161 for <b>(MB)</b></p>	<b>R27849</b>	1598	1694	1775	1868	2021	2162	2303	2426	2579	2723	2918	3194			
			OVERALL DIMENSIONS			SEAT DIMENSIONS			BACK DIMENSIONS								
			W	D	H	W	D	H	W	H							
			IN 36	36	17.5	-	-	-	-	-							
			MM 914	914	445	-	-	-	-	-							
	<b>RTA 00</b>		1 per carton														
 <p><b>42" Square Bench</b> COM: 3.25 YD   2.97 M Unit weight: 50 LB   22.7 KG Carton weight: 60 LB   27.22 KG Carton volume: 23 FT<sup>3</sup>   0.65 MT<sup>3</sup></p>	<p>No power/USB unit.</p> <p>Freestanding unit only.</p> <p>Add \$61 for <b>(SS)</b> Add \$90 for <b>(F_)</b> Add \$1067 for 72 lbs. <b>(CW)</b> Add \$96 for <b>(SU)</b> or \$430 for <b>(BS)</b> Add \$28 for <b>(TP)</b> Add \$243 for <b>(MB)</b></p>	<b>R27850</b>	1955	2059	2147	2248	2413	2566	2719	2852	3018	3174	3385	3684			
			OVERALL DIMENSIONS			SEAT DIMENSIONS			BACK DIMENSIONS								
			W	D	H	W	D	H	W	H							
			IN 42	42	17.5	-	-	-	-	-							
			MM 1067	1067	445	-	-	-	-	-							
	<b>RTA 00</b>		1 per carton														

RIVER+ TABLES

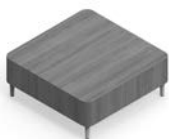

model R27858



model R27864



model 7743

River+ Seating & Benches



For River+ seating, please see page 277.  
For River+ benches, please see page 291.

STANDARD FEATURES

- A modular series that is composed of straight and curved sections, as well as freestanding units.
- Linking units can be used together in any combination with River+ seating and bench units to create a wide variety of layouts. Ganging hardware is standard and is factory installed. Ganging hardware swivels out of the way when not in use.
- Front and back faces of end (linking) tables angles slightly inwards. This inward slant matches the inward angles of River seating so all units coordinate in visual appearance.
- The unique tapered legs are made of welded steel, with each leg bolted directly to the unit frame. All units have the same standard leg height of 6.5". The leg height makes it easier to clean under the product.
- Legs are straight (vertical) as standard. Linking models are optionally available with an angled back leg to visually align with River seating units.
- Legs are standard in Chrome with Black nylon non-marking height adjustable glides.

OPTIONAL FEATURES

- Tables are made with high pressure laminate and are offered in the finishes listed on the right. Please specify. Custom high pressure laminate finishes will be considered upon request.
- Legs of coffee and end (linking) tables are available in 3" and 8" heights. All heights are available with fixed-to-floor option. Please specify.
- Products can be weighted to reduce the ease of movement. For additional weight options, please specify **(CW)** - see each model for available additional weight and upcharge.
- Most tables (except freestanding units) can be specified with power/USB units, which include one power outlets, one double USB terminals and a Black 120" three-prong power cord.
- Each power/USB unit is set in predetermined locations, as shown in the electrical illustrations below. Electrical units must be factory installed. Add \$881 per unit.
- Power/USB units are available with either Jet Black **(J)** face plate with Black power/USB receptacles or with a White **(W)** face plate with White power/USB receptacles.

Please add option codes in the following order:

- **Model number**  
**R27855 to R27858** Square coffee tables  
**R27859** Rectangular coffee table  
**R27860 to R27861** Round coffee tables  
**R27862 to R27864** Linking/end tables  
**7443 and 7745** Freestanding tables
- **Laminate finishes** (colors shown on website)  
**(ACJ)** Absolute Acajou  
**(ASN)** Asian Night  
**(AWC)** Avanti Cherry  
**(AWH)** Avanti Honey  
**(BLK)** Black  
**(BZD)** Blizzard  
**(BRC)** Brushed Cobalt  
**(CMB)** Clear Maple  
**(CGY)** Custom Grey  
**(DES)** Dark Espresso  
**(DWT)** Designer White  
**(FAS)** Fashionista  
**(FCL)** First Class  
**(NBL)** Noce Biondo  
**(NGL)** Noce Grigio  
**(NEL)** Noce Leggero  
**(NML)** Noce Medio  
**(QTM)** Quartered Mahogany  
**(SBY)** Sheer Beauty  
**(SDT)** Stonedust  
**(SGY)** Storm Grey  
**(WHE)** Walnut Heights  
**(WHC)** White Chocolate  
**(WCR)** Winter Cherry
- **Leg finish**  
For leg finish options, please see page 360. No upcharges.
- **Leg selection**  
**(S6)** Standard height (6.5") w/adjustable glides. No upcharge.  
**(S3)** Low (3") w/adjustable glides. No upcharge.  
**(S8)** High (8") w/adjustable glides. No upcharge.  
**(F6)** Standard height (6.5"), fixed to floor. Add \$90.  
**(F3)** Low (3"), fixed to floor. Add \$90.  
**(F8)** High (8"), fixed to floor. Add \$90.
- **Leg angle** (linking/end tables only)  
**(AS)** Straight legs. No upcharge.  
**(SA)** Straight front legs, angled back legs. No upcharge.
- **Additional weight**  
**(NC)** No additional weight.  
**(CW)** Additional weight. Upcharges vary, see model.
- **Power unit finish**  
**(J)** Jet Black  
**(W)** White
- **Power/USB unit position** (coffee and linking/end tables only, as shown below). Add \$881 per unit.  
**(NP)** No power. No upcharge.  
**(E1)** Left end (rectangular coffee table only)  
**(E2)** Right end (rectangular coffee table only)  
**(F3)** Front center (square coffee table only)  
**(T1)** Top
- **Fasteners**  
**(RS)** Standard  
**(TP)** Tamperproof. Add \$119.

EXAMPLE RIVER+ TABLE ORDER CODE:

R27858	-ACJ	-CHM	-S6	-AS	-NC	-W	-T1	-RS
Model number	Laminate	Leg finish	Leg selection	Leg angle	Additional weight	Power finish	Power/USB	Fasteners

ELECTRICAL PLACEMENT

Coffee Tables

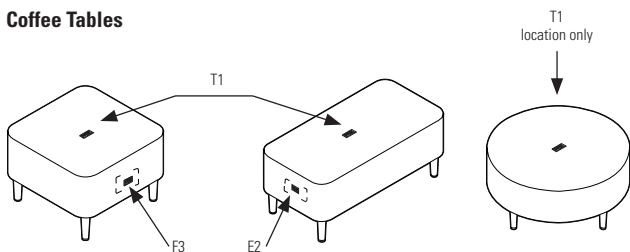

Linking Tables

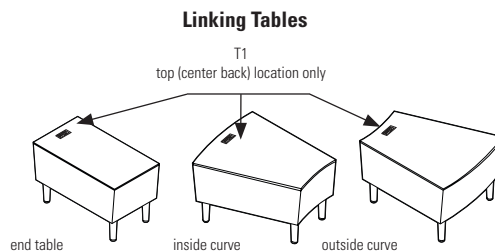

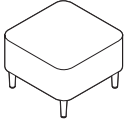
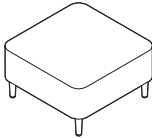
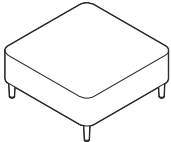
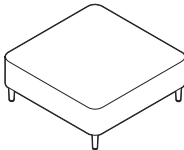
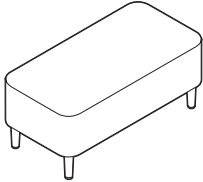
DESCRIPTION	FEATURES	MODEL#	STANDARD TEXTILE GRADES																																
	<p><b>24" Square Laminate Coffee Table</b> COM: N/A Unit weight: 40 LB   18.14 KG Carton weight: 40 LB   18.14 KG Carton volume: 10.7 FT<sup>3</sup>   0.3 MT<sup>3</sup></p>	<p>For power/USB unit, please see electrical placement chart.</p> <p>Freestanding unit only. Add \$533 for 36 lbs. (CW)</p>	List price																																
			R27855	1329																															
			<table border="1"> <thead> <tr> <th colspan="3">OVERALL DIMENSIONS</th> <th colspan="3">SEAT DIMENSIONS</th> <th colspan="2">BACK DIMENSIONS</th> </tr> <tr> <th>W</th> <th>D</th> <th>H</th> <th>W</th> <th>D</th> <th>H</th> <th>W</th> <th>H</th> </tr> </thead> <tbody> <tr> <td>IN 24</td> <td>24</td> <td>17</td> <td>-</td> <td>-</td> <td>-</td> <td>-</td> <td>-</td> </tr> <tr> <td>MM 610</td> <td>610</td> <td>432</td> <td>-</td> <td>-</td> <td>-</td> <td>-</td> <td>-</td> </tr> </tbody> </table>			OVERALL DIMENSIONS			SEAT DIMENSIONS			BACK DIMENSIONS		W	D	H	W	D	H	W	H	IN 24	24	17	-	-	-	-	-	MM 610	610	432	-	-	-
OVERALL DIMENSIONS			SEAT DIMENSIONS			BACK DIMENSIONS																													
W	D	H	W	D	H	W	H																												
IN 24	24	17	-	-	-	-	-																												
MM 610	610	432	-	-	-	-	-																												
	<p><b>30" Square Laminate Coffee Table</b> COM: N/A Unit weight: 53 LB   24.04 KG Carton weight: 53 LB   24.04 KG Carton volume: 15.3 FT<sup>3</sup>   0.43 MT<sup>3</sup></p>	<p>For power/USB unit, please see electrical placement chart.</p> <p>Freestanding unit only. Add \$400 for 27 lbs. (CW)</p>	List price																																
			R27856	1392																															
			<table border="1"> <thead> <tr> <th colspan="3">OVERALL DIMENSIONS</th> <th colspan="3">SEAT DIMENSIONS</th> <th colspan="2">BACK DIMENSIONS</th> </tr> <tr> <th>W</th> <th>D</th> <th>H</th> <th>W</th> <th>D</th> <th>H</th> <th>W</th> <th>H</th> </tr> </thead> <tbody> <tr> <td>IN 30</td> <td>30</td> <td>17</td> <td>-</td> <td>-</td> <td>-</td> <td>-</td> <td>-</td> </tr> <tr> <td>MM 762</td> <td>762</td> <td>432</td> <td>-</td> <td>-</td> <td>-</td> <td>-</td> <td>-</td> </tr> </tbody> </table>			OVERALL DIMENSIONS			SEAT DIMENSIONS			BACK DIMENSIONS		W	D	H	W	D	H	W	H	IN 30	30	17	-	-	-	-	-	MM 762	762	432	-	-	-
OVERALL DIMENSIONS			SEAT DIMENSIONS			BACK DIMENSIONS																													
W	D	H	W	D	H	W	H																												
IN 30	30	17	-	-	-	-	-																												
MM 762	762	432	-	-	-	-	-																												
	<p><b>36" Square Laminate Coffee Table</b> COM: N/A Unit weight: 75 LB   34.01 KG Carton weight: 75 LB   34.02 KG Carton volume: 20.6 FT<sup>3</sup>   0.58 MT<sup>3</sup></p>	<p>For power/USB unit, please see electrical placement chart.</p> <p>Freestanding unit only. No additional weight required.</p>	List price																																
			R27857	1541																															
			<table border="1"> <thead> <tr> <th colspan="3">OVERALL DIMENSIONS</th> <th colspan="3">SEAT DIMENSIONS</th> <th colspan="2">BACK DIMENSIONS</th> </tr> <tr> <th>W</th> <th>D</th> <th>H</th> <th>W</th> <th>D</th> <th>H</th> <th>W</th> <th>H</th> </tr> </thead> <tbody> <tr> <td>IN 36</td> <td>36</td> <td>17</td> <td>-</td> <td>-</td> <td>-</td> <td>-</td> <td>-</td> </tr> <tr> <td>MM 914</td> <td>914</td> <td>432</td> <td>-</td> <td>-</td> <td>-</td> <td>-</td> <td>-</td> </tr> </tbody> </table>			OVERALL DIMENSIONS			SEAT DIMENSIONS			BACK DIMENSIONS		W	D	H	W	D	H	W	H	IN 36	36	17	-	-	-	-	-	MM 914	914	432	-	-	-
OVERALL DIMENSIONS			SEAT DIMENSIONS			BACK DIMENSIONS																													
W	D	H	W	D	H	W	H																												
IN 36	36	17	-	-	-	-	-																												
MM 914	914	432	-	-	-	-	-																												
	<p><b>42" Square Laminate Coffee Table</b> COM: N/A Unit weight: 115 LB   52.16 KG Carton weight: 115 LB   52.16 KG Carton volume: 26.7 FT<sup>3</sup>   0.75 MT<sup>3</sup></p>	<p>For power/USB unit, please see electrical placement chart.</p> <p>Freestanding unit only. No additional weight required.</p>	List price																																
			R27858	1706																															
			<table border="1"> <thead> <tr> <th colspan="3">OVERALL DIMENSIONS</th> <th colspan="3">SEAT DIMENSIONS</th> <th colspan="2">BACK DIMENSIONS</th> </tr> <tr> <th>W</th> <th>D</th> <th>H</th> <th>W</th> <th>D</th> <th>H</th> <th>W</th> <th>H</th> </tr> </thead> <tbody> <tr> <td>IN 42</td> <td>42</td> <td>17</td> <td>-</td> <td>-</td> <td>-</td> <td>-</td> <td>-</td> </tr> <tr> <td>MM 1067</td> <td>1067</td> <td>432</td> <td>-</td> <td>-</td> <td>-</td> <td>-</td> <td>-</td> </tr> </tbody> </table>			OVERALL DIMENSIONS			SEAT DIMENSIONS			BACK DIMENSIONS		W	D	H	W	D	H	W	H	IN 42	42	17	-	-	-	-	-	MM 1067	1067	432	-	-	-
OVERALL DIMENSIONS			SEAT DIMENSIONS			BACK DIMENSIONS																													
W	D	H	W	D	H	W	H																												
IN 42	42	17	-	-	-	-	-																												
MM 1067	1067	432	-	-	-	-	-																												
	<p><b>Rectangular Laminate Coffee Table</b> COM: N/A Unit weight: 55 LB   24.94 KG Carton weight: 55 LB   24.95 KG Carton volume: 14.2 FT<sup>3</sup>   0.4 MT<sup>3</sup></p>	<p>For power/USB unit, please see electrical placement chart.</p> <p>Freestanding unit only. Add \$267 for 18 lbs. (CW)</p>	List price																																
			R27859	1400																															
			<table border="1"> <thead> <tr> <th colspan="3">OVERALL DIMENSIONS</th> <th colspan="3">SEAT DIMENSIONS</th> <th colspan="2">BACK DIMENSIONS</th> </tr> <tr> <th>W</th> <th>D</th> <th>H</th> <th>W</th> <th>D</th> <th>H</th> <th>W</th> <th>H</th> </tr> </thead> <tbody> <tr> <td>IN 40</td> <td>20</td> <td>17</td> <td>-</td> <td>-</td> <td>-</td> <td>-</td> <td>-</td> </tr> <tr> <td>MM 1016</td> <td>508</td> <td>432</td> <td>-</td> <td>-</td> <td>-</td> <td>-</td> <td>-</td> </tr> </tbody> </table>			OVERALL DIMENSIONS			SEAT DIMENSIONS			BACK DIMENSIONS		W	D	H	W	D	H	W	H	IN 40	20	17	-	-	-	-	-	MM 1016	508	432	-	-	-
OVERALL DIMENSIONS			SEAT DIMENSIONS			BACK DIMENSIONS																													
W	D	H	W	D	H	W	H																												
IN 40	20	17	-	-	-	-	-																												
MM 1016	508	432	-	-	-	-	-																												

DESCRIPTION FEATURES MODEL# STANDARD TEXTILE GRADES

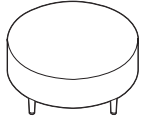

**36" Dia. Round Laminate Coffee Table**  
 COM: N/A  
 Unit weight: 63 LB | 28.57 KG  
 Carton weight: 63 LB | 28.58 KG  
 Carton volume: 15.3 FT<sup>3</sup> | 0.43 MT<sup>3</sup>

For power/USB unit, please see electrical placement chart.  
 Freestanding unit only.  
 Add \$267 for 18 lbs. (CW)

List price								
<b>R27860</b>	1729							
OVERALL DIMENSIONS			SEAT DIMENSIONS			BACK DIMENSIONS		
W	D	H	W	D	H	W	H	
IN 36	36	17	-	-	-	-	-	
MM 914	914	432	-	-	-	-	-	
<b>RTA 00</b>		1 per carton						

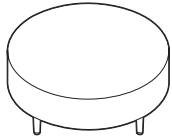

**42" Dia. Round Laminate Coffee Table**  
 COM: N/A  
 Unit weight: 85 LB | 38.55 KG  
 Carton weight: 85 LB | 38.56 KG  
 Carton volume: 20.6 FT<sup>3</sup> | 0.58 MT<sup>3</sup>

For power/USB unit, please see electrical placement chart.  
 Freestanding unit only.  
 No additional weight required.

List price								
<b>R27861</b>	1889							
OVERALL DIMENSIONS			SEAT DIMENSIONS			BACK DIMENSIONS		
W	D	H	W	D	H	W	H	
IN 42	42	17	-	-	-	-	-	
MM 1067	1067	432	-	-	-	-	-	
<b>RTA 00</b>		1 per carton						

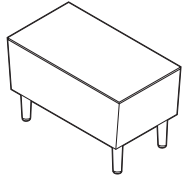

**Rectangular Laminate End Table**  
 COM: N/A  
 Unit weight: 40 LB | 18.14 KG  
 Carton weight: 40 LB | 18.14 KG  
 Carton volume: 20.6 FT<sup>3</sup> | 0.58 MT<sup>3</sup>

For power/USB unit, please see electrical placement chart.  
 Includes ganging hardware (2 sides).  
 Add \$533 for 36 lbs. (CW)

List price								
<b>R27862</b>	1401							
OVERALL DIMENSIONS			SEAT DIMENSIONS			BACK DIMENSIONS		
W	D	H	W	D	H	W	H	
IN 28	15	17	-	-	-	-	-	
MM 711	381	432	-	-	-	-	-	
<b>RTA 00</b>		1 per carton						

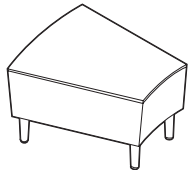

**Inside Curve Laminate End Table**  
 COM: N/A  
 Unit weight: 47 LB | 21.31 KG  
 Carton weight: 47 LB | 21.32 KG  
 Carton volume: 13.3 FT<sup>3</sup> | 0.37 MT<sup>3</sup>

For power/USB unit, please see electrical placement chart.  
 Includes ganging hardware (2 sides).  
 Add \$533 for 36 lbs. (CW)

List price								
<b>R27863</b>	1850							
OVERALL DIMENSIONS			SEAT DIMENSIONS			BACK DIMENSIONS		
W	D	H	W	D	H	W	H	
IN 28	17	17	-	-	-	-	-	
MM 711	432	432	-	-	-	-	-	
<b>RTA 00</b>		1 per carton						

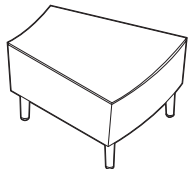

**Outside Curve Laminate End Table**  
 COM: N/A  
 Unit weight: 47 LB | 21.31 KG  
 Carton weight: 47 LB | 21.32 KG  
 Carton volume: 13.3 FT<sup>3</sup> | 0.37 MT<sup>3</sup>

For power/USB unit, please see electrical placement chart.  
 Includes ganging hardware (2 sides).  
 Add \$533 for 36 lbs. (CW)

List price								
<b>R27864</b>	1850							
OVERALL DIMENSIONS			SEAT DIMENSIONS			BACK DIMENSIONS		
W	D	H	W	D	H	W	H	
IN 28	17	17	-	-	-	-	-	
MM 711	432	432	-	-	-	-	-	
<b>RTA 00</b>		1 per carton						

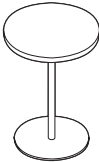
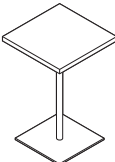

DESCRIPTION	FEATURES	MODEL#	STANDARD TEXTILE GRADES						
 <p><b>18" Dia. Round Laminate Laptop Table</b>                      COM: N/A                      Unit weight: 22 LB   10 KG                      Carton weight: 32 LB   14.51 KG                      Carton volume: 6 FT³   0.16 MT³</p>	No power/USB unit.	7743	List price						
			1063						
		<b>OVERALL DIMENSIONS</b>			<b>SEAT DIMENSIONS</b>			<b>BACK DIMENSIONS</b>	
		<b>W</b>	<b>D</b>	<b>H</b>	<b>W</b>	<b>D</b>	<b>H</b>	<b>W</b>	<b>H</b>
		IN 18	18	25.25	-	-	-	-	-
		MM 457	457	641	-	-	-	-	-
		RTA 00		courier		1 per carton			
 <p><b>16" Square Laminate Laptop Table</b>                      COM: N/A                      Unit weight: 26 LB   11.8 KG                      Carton weight: 36 LB   16.33 KG                      Carton volume: 6 FT³   0.16 MT³</p>	No power/USB unit.	7745	List price						
			1035						
		<b>OVERALL DIMENSIONS</b>			<b>SEAT DIMENSIONS</b>			<b>BACK DIMENSIONS</b>	
		<b>W</b>	<b>D</b>	<b>H</b>	<b>W</b>	<b>D</b>	<b>H</b>	<b>W</b>	<b>H</b>
		IN 16	16	25.25	-	-	-	-	-
		MM 406	406	641	-	-	-	-	-
		RTA 00				1 per carton			

SIRENA



models 3371 Lounge Chairs, 3373 Two Seat Sofa, 3400 Coffee Table and 3402 End Table



model 3371



model 3372CRTL



STANDARD FEATURES

- Modern club style seating includes: lounge chair, two and three seat sofas.
- Complete with modern tables for reception areas, meeting rooms and private office use.
- Distinctive round style feet are finished in Black only.
- All models have fixed, non-removable seat cushions with arm height at 25" in the front.
- When ordering models with tablet, please specify for left hand or for right hand tablet. See models below.
- Tablets rotate and are non-removable. Overall tablet size is 17"W by 14"D.
- Laminate tops are 1" thick.
- Table legs are 1.5" steel tubing, tapered toward the bottom to 7/8", equipped with self-leveling, pivoting steel glides.
- (C1M) dual wheel carpet casters are standard. Casters are available on lounge chairs only.
- Upholstery options: fabric, vinyl or leather. Vinyl and leather models may feature stitch detail across the seat and/or back cushions, if applicable.

OPTIONAL FEATURES

- Laminate tables, tablets and book shelves are offered in the following laminate finishes: Absolute Acajou (ACJ), Asian Night (ASN), Avant Cherry (AWC), Avant Honey (AWH), Black (BLK), Blizzard (BZD), Clear Maple (CMB), Custom Grey (CGY), Dark Espresso (DES), Designer White (DWT), Fashionista (FAS), First Class (FCL), Noce Biondo (NBL), Noce Grigio (NGL), Noce Leggero (NEL), Noce Medio (NML), Sheer Beauty (SBY), Quatered Mahogany (QTM), Stonedust (SDT), Walnut Heights (WHE), White Chocolate (WHC) and Winter Cherry (WCR). Please specify.
- Table legs are available in Black (TBL) or Tungsten (TTU). No upcharge.

DESCRIPTION

FEATURES

MODEL#

STANDARD TEXTILE GRADES



Lounge Chair Fabric

COM: 4.25 YD | 3.89 M  
 Unit weight: 45 LB | 20.5 KG  
 Carton weight: 52 LB | 23.59 KG  
 Carton volume: 19.25 FT³ | 0.54 MT³

	1	2	3	4	5	6	7	8	9	10	11	12
<b>3371</b>	-	1148	1263	1395	1611	1811	2011	2185	2402	2606	2882	3273
<b>OVERALL DIMENSIONS</b>			<b>SEAT DIMENSIONS</b>			<b>BACK DIMENSIONS</b>						
	<b>W</b>	<b>D</b>	<b>H</b>	<b>W</b>	<b>D</b>	<b>H</b>	<b>W</b>	<b>H</b>				
IN	30.5	29.5	28.5	20	20	17.5	19	11.5				
MM	775	749	724	508	508	445	483	292				
<b>RTA 00</b>	1 per carton											



Lounge Chair w/Casters

COM: 4.25 YD | 3.89 M  
 Unit weight: 47 LB | 21.4 KG  
 Carton weight: 52 LB | 23.59 KG  
 Carton volume: 19.25 FT³ | 0.54 MT³

	1	2	3	4	5	6	7	8	9	10	11	12
<b>3371C</b>	-	1242	1357	1489	1705	1905	2105	2279	2496	2700	2976	3367
<b>OVERALL DIMENSIONS</b>			<b>SEAT DIMENSIONS</b>			<b>BACK DIMENSIONS</b>						
	<b>W</b>	<b>D</b>	<b>H</b>	<b>W</b>	<b>D</b>	<b>H</b>	<b>W</b>	<b>H</b>				
IN	30.5	29.5	29.5	20	20	18	19	12.5				
MM	775	749	749	508	508	457	483	318				
<b>RTA 00</b>	1 per carton											



3371LTL













3371RTL

Lounge Chair w/Laminate Tablet

COM: 4.25 YD | 3.89 M  
 Unit weight: 53 LB | 24.1 KG  
 Carton weight: 58 LB | 26.31 KG  
 Carton volume: 19.25 FT³ | 0.54 MT³

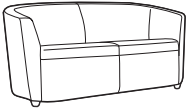
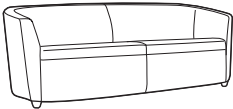
	1	2	3	4	5	6	7	8	9	10	11	12
<b>3371LTL</b> 3371RTL	-	1561	1676	1808	2024	2224	2424	2598	2815	3019	3295	3686
<b>OVERALL DIMENSIONS</b>			<b>SEAT DIMENSIONS</b>			<b>BACK DIMENSIONS</b>						
	<b>W</b>	<b>D</b>	<b>H</b>	<b>W</b>	<b>D</b>	<b>H</b>	<b>W</b>	<b>H</b>				
IN	32.5	29.5	28.5	20	20	17.5	19	11.5				
MM	826	749	724	508	508	445	483	292				
<b>RTA 00</b>	1 per carton											

DESCRIPTION	FEATURES	MODEL#	STANDARD TEXTILE GRADES											
			1	2	3	4	5	6	7	8	9	10	11	12
 <b>3371CLTL</b>	 <b>3371CRTL</b>	<b>3371CLTL</b> 3371CRTL	-	1652	1767	1899	2115	2315	2515	2689	2906	3110	3386	3777
		<b>OVERALL DIMENSIONS</b> W D H	<b>SEAT DIMENSIONS</b> W D H	<b>BACK DIMENSIONS</b> W H	IN 32 MM 813	29.5 749	29.5 749	20 508	20 508	18 457	19 483	12.5 318		
<b>Lounge Chair w/Casters &amp; Laminate Tablet</b> COM: 4.25 YD   3.89 M Unit weight: 57 LB   25.9 KG Carton weight: 62 LB   28.12 KG Carton volume: 19.25 FT³   0.54 MT³		<b>RTA 00</b>	1 per carton											
 <b>3372</b>		<b>3372</b>	-	1371	1486	1618	1834	2034	2234	2408	2625	2829	3105	3496
	<b>OVERALL DIMENSIONS</b> W D H	<b>SEAT DIMENSIONS</b> W D H	<b>BACK DIMENSIONS</b> W H	IN 30.5 MM 775	29.5 749	28.5 724	20 508	20 508	17.5 445	19 483	11.5 292			
<b>Lounge Chair w/Laminate Bookshelf</b> COM: 4.25 YD   3.89 M Unit weight: 47 LB   21.4 KG Carton weight: 55 LB   24.95 KG Carton volume: 19.25 FT³   0.54 MT³		<b>RTA 00</b>	1 per carton											
 <b>3372C</b>		<b>3372C</b>	-	1464	1579	1711	1927	2127	2327	2501	2718	2922	3198	3589
	<b>OVERALL DIMENSIONS</b> W D H	<b>SEAT DIMENSIONS</b> W D H	<b>BACK DIMENSIONS</b> W H	IN 30.5 MM 775	29.5 749	28.5 724	20 508	20 508	17.5 445	19 483	11.5 292			
<b>Lounge Chair w/Casters &amp; Laminate Bookshelf</b> COM: 4.25 YD   3.89 M Unit weight: 47 LB   21.4 KG Carton weight: 55 LB   24.95 KG Carton volume: 19.25 FT³   0.54 MT³		<b>RTA 00</b>	1 per carton											
 <b>3372LTL</b>	 <b>3372RTL</b>	<b>3372LTL</b> 3372RTL	-	1782	1897	2029	2245	2445	2645	2819	3036	3240	3516	3907
		<b>OVERALL DIMENSIONS</b> W D H	<b>SEAT DIMENSIONS</b> W D H	<b>BACK DIMENSIONS</b> W H	IN 32.5 MM 826	29.5 749	28.5 724	20 508	20 508	17.5 445	19 483	11.5 292		
<b>Lounge Chair w/Laminate Tablet/Bookshelf</b> COM: 4.25 YD   3.89 M Unit weight: 58 LB   26.4 KG Carton weight: 66 LB   29.94 KG Carton volume: 19.25 FT³   0.54 MT³		<b>RTA 00</b>	1 per carton											
 <b>3372CLTL</b>	 <b>3372CRTL</b>	<b>3372CLTL</b> 3372CRTL	-	1874	1989	2121	2337	2537	2737	2911	3128	3332	3608	3999
		<b>OVERALL DIMENSIONS</b> W D H	<b>SEAT DIMENSIONS</b> W D H	<b>BACK DIMENSIONS</b> W H	IN 32.5 MM 826	29.5 749	28.5 724	20 508	20 508	17.5 445	19 483	11.5 292		
<b>Lounge Chair w/Casters &amp; Laminate Tablet/Bookshelf</b> COM: 4.25 YD   3.89 M Unit weight: 58 LB   26.4 KG Carton weight: 66 LB   29.94 KG Carton volume: 19.25 FT³   0.54 MT³		<b>RTA 00</b>	1 per carton											

DESCRIPTION	FEATURES	MODEL#	STANDARD TEXTILE GRADES												
			1	2	3	4	5	6	7	8	9	10	11	12	
 <p><b>Two Seat Sofa</b>                      COM: 7 YD   6.4 M                      Unit weight: 82 LB   37.3 KG                      Carton weight: 92 LB   41.73 KG                      Carton volume: 48 FT³   1.35 MT³</p>		<b>3373</b>	-	2036	2225	2442	2799	3128	3457	3744	4101	4437	4892	5536	
				<b>OVERALL DIMENSIONS</b>			<b>SEAT DIMENSIONS</b>			<b>BACK DIMENSIONS</b>					
				<b>W</b>	<b>D</b>	<b>H</b>	<b>W</b>	<b>D</b>	<b>H</b>	<b>W</b>	<b>H</b>				
				IN 62	29.5	28.5	53	20	17.5	53	11.5				
				MM 1575	749	724	1346	508	445	1346	292				
			<b>RTA 00</b>	1 per carton											
 <p><b>Three Seat Sofa</b>                      COM: 7.75 YD   7.09 M                      Unit weight: 97 LB   44.1 KG                      Carton weight: 107 LB   48.53 KG                      Carton volume: 55.5 FT³   1.57 MT³</p>		<b>3374</b>	-	2405	2614	2855	3250	3614	3978	4296	4691	5063	5567	6280	
				<b>OVERALL DIMENSIONS</b>			<b>SEAT DIMENSIONS</b>			<b>BACK DIMENSIONS</b>					
				<b>W</b>	<b>D</b>	<b>H</b>	<b>W</b>	<b>D</b>	<b>H</b>	<b>W</b>	<b>H</b>				
				IN 81.5	29.5	28.5	72.5	20	17.5	72.5	11.5				
				MM 2070	749	724	1842	508	445	1842	292				
			<b>RTA 00</b>	1 per carton											
 <p><b>Coffee Table - 48" Laminate Top</b>                      COM: N/A                      Unit weight: 44 LB   20 KG                      Carton weight: 52 LB   23.59 KG                      Carton volume: 17.25 FT³   0.48 MT³</p>		<b>3400</b>	List price												
				1214											
					<b>OVERALL DIMENSIONS</b>			<b>SEAT DIMENSIONS</b>			<b>BACK DIMENSIONS</b>				
				<b>W</b>	<b>D</b>	<b>H</b>	<b>W</b>	<b>D</b>	<b>H</b>	<b>W</b>	<b>H</b>				
				IN 48	22	14.5	-	-	-	-	-				
			MM 1219	559	368	-	-	-	-	-					
			<b>RTA 00</b>	1 per carton											
 <p><b>Coffee Table - 56" Laminate Top</b>                      COM: N/A                      Unit weight: 50 LB   22.7 KG                      Carton weight: 60 LB   27.22 KG                      Carton volume: 19 FT³   0.53 MT³</p>		<b>3401</b>	List price												
				1346											
					<b>OVERALL DIMENSIONS</b>			<b>SEAT DIMENSIONS</b>			<b>BACK DIMENSIONS</b>				
				<b>W</b>	<b>D</b>	<b>H</b>	<b>W</b>	<b>D</b>	<b>H</b>	<b>W</b>	<b>H</b>				
				IN 56	22	14.5	-	-	-	-	-				
			MM 1422	559	368	-	-	-	-	-					
			<b>RTA 00</b>	1 per carton											
 <p><b>End Table - Laminate Top</b>                      COM: N/A                      Unit weight: 20 LB   9.1 KG                      Carton weight: 26 LB   11.79 KG                      Carton volume: 7.75 FT³   0.21 MT³</p>		<b>3402</b>	List price												
				1007											
					<b>OVERALL DIMENSIONS</b>			<b>SEAT DIMENSIONS</b>			<b>BACK DIMENSIONS</b>				
				<b>W</b>	<b>D</b>	<b>H</b>	<b>W</b>	<b>D</b>	<b>H</b>	<b>W</b>	<b>H</b>				
				IN 17	22	14.5	-	-	-	-	-				
			MM 432	559	368	-	-	-	-	-					
			<b>RTA 00</b>		1 per carton										

## VENTURE



**48\"/>**



**78\"/>**



**60\"/>**

## STANDARD FEATURES

- Venture is a solid and durable banquette seating series ideal for impromptu meetings.
- Banquettes are available with or without fully upholstered backs. Open back banquettes are intended to be placed against walls or in other layouts where the back will not be visible.
- Heavy duty frame with interlocking plywood, puzzle box construction suitable for public environments.
- Cushions are fixed and non-removable and made with highly resilient foam for extra comfort.
- Ganging bracket kit (8509) gangs two single back models back to back or side by side and double back models side by side. Kit contains two brackets.
- Standard with metal legs and Black glides, suitable for carpet and hard surface flooring.
- Closed back models are fully upholstered for use in open settings and to support reconfiguration.
- Open back models have a Black outer back protective dust cover to be used against walls or for ganging back to back.
- Double back models (#8508-48, #8508-60, #8508-72, #8508-78) measure 55\"/>

## OPTIONAL FEATURES



- **Leg finish** (no upcharge)
  - (**TBL**) Black
  - (**CHM**) Chrome
  - (**TTU**) Tungsten
- **Packaging options** (no upcharge) *available on double back models only*
  - (**ST**) fully assembled (standard)
  - (**KD**) knocked down

## EXAMPLE VENTURE ORDER CODE:

8506-48	EL58	EL65	TBL	ST
Model #	Back Textile	Seat Textile	Leg Finish	Packaging

DESCRIPTION	FEATURES	MODEL #	STANDARD TEXTILE GRADES											
			1	2	3	4	5	6	7	8	9	10	11	12
<p><b>48\"/&gt;                     COM: 6.75 YD   6.17 M                      Unit weight: 80 LB   36.4 KG                      Carton weight: 104 LB   47.17 KG                      Carton volume: 50.75 FT<sup>3</sup>   1.43 MT<sup>3</sup></b></p>		<b>8506-48</b>	3174	3390	3572	3782	4126	4443	4760	5037	5381	5705	6144	6765
			<b>OVERALL DIMENSIONS</b>			<b>SEAT DIMENSIONS</b>			<b>BACK DIMENSIONS</b>					
			<b>W</b>	<b>D</b>	<b>H</b>	<b>W</b>	<b>D</b>	<b>H</b>	<b>W</b>	<b>H</b>				
			IN 48	28	48	48	19	18	48	30				
			MM 1219	711	1219	1219	483	457	1219	762				
		<b>RTA 00</b>	1 per carton											
<p><b>60\"/&gt;                     COM: 8 YD   7.32 M                      Unit weight: 100 LB   45.5 KG                      Carton weight: 127 LB   57.61 KG                      Carton volume: 62.75 FT<sup>3</sup>   1.77 MT<sup>3</sup></b></p>		<b>8506-60</b>	3703	3959	4175	4423	4831	5207	5583	5911	6319	6703	7223	7959
			<b>OVERALL DIMENSIONS</b>			<b>SEAT DIMENSIONS</b>			<b>BACK DIMENSIONS</b>					
			<b>W</b>	<b>D</b>	<b>H</b>	<b>W</b>	<b>D</b>	<b>H</b>	<b>W</b>	<b>H</b>				
			IN 60	28	48	60	19	18	60	30				
			MM 1524	711	1219	1524	483	457	1524	762				
		<b>RTA 00</b>	1 per carton											
<p><b>72\"/&gt;                     COM: 9 YD   8.23 M                      Unit weight: 120 LB   54.5 KG                      Carton weight: 153 LB   69.4 KG                      Carton volume: 75 FT<sup>3</sup>   2.12 MT<sup>3</sup></b></p>		<b>8506-72</b>	4122	4410	4653	4932	5391	5814	6237	6606	7065	7497	8082	8910
			<b>OVERALL DIMENSIONS</b>			<b>SEAT DIMENSIONS</b>			<b>BACK DIMENSIONS</b>					
			<b>W</b>	<b>D</b>	<b>H</b>	<b>W</b>	<b>D</b>	<b>H</b>	<b>W</b>	<b>H</b>				
			IN 72	28	48	72	19	18	72	30				
			MM 1829	711	1219	1829	483	457	1829	762				
		<b>RTA 00</b>	1 per carton											

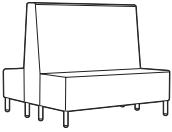
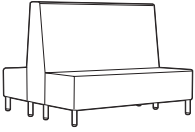
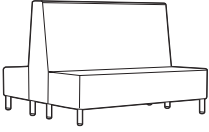
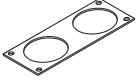
DESCRIPTION	FEATURES	MODEL #	STANDARD TEXTILE GRADES											
			1	2	3	4	5	6	7	8	9	10	11	12
<p><b>78\"/&gt; </b></p>	<p><b>78\"/&gt; </b></p>	<p><b>8506-78</b></p>	4409	4729	4999	5309	5819	6289	6759	7169	7679	8159	8809	9729
			<b>OVERALL DIMENSIONS</b>			<b>SEAT DIMENSIONS</b>			<b>BACK DIMENSIONS</b>					
			<b>W</b>	<b>D</b>	<b>H</b>	<b>W</b>	<b>D</b>	<b>H</b>	<b>W</b>	<b>H</b>				
			IN 78	28	48	78	19	18	78	30				
			MM 1981	711	1219	1981	483	457	1981	762				
		<b>RTA 00</b>	1 per carton											
<p><b>48\"/&gt; </b></p>	<p><b>48\"/&gt; </b></p>	<p><b>8507-48</b></p>	3012	3172	3307	3462	3717	3952	4187	4392	4647	4887	5212	5672
			<b>OVERALL DIMENSIONS</b>			<b>SEAT DIMENSIONS</b>			<b>BACK DIMENSIONS</b>					
			<b>W</b>	<b>D</b>	<b>H</b>	<b>W</b>	<b>D</b>	<b>H</b>	<b>W</b>	<b>H</b>				
			IN 48	28	48	48	19	18	48	30				
			MM 1219	711	1219	1219	483	457	1219	762				
		<b>RTA 00</b>	1 per carton											
<p><b>60\"/&gt; </b></p>	<p><b>60\"/&gt; </b></p>	<p><b>8507-60</b></p>	3504	3696	3858	4044	4350	4632	4914	5160	5466	5754	6144	6696
			<b>OVERALL DIMENSIONS</b>			<b>SEAT DIMENSIONS</b>			<b>BACK DIMENSIONS</b>					
			<b>W</b>	<b>D</b>	<b>H</b>	<b>W</b>	<b>D</b>	<b>H</b>	<b>W</b>	<b>H</b>				
			IN 60	28	48	60	19	18	60	30				
			MM 1524	711	1219	1524	483	457	1524	762				
		<b>RTA 00</b>	1 per carton											
<p><b>72\"/&gt; </b></p>	<p><b>72\"/&gt; </b></p>	<p><b>8507-72</b></p>	3885	4109	4298	4515	4872	5201	5530	5817	6174	6510	6965	7609
			<b>OVERALL DIMENSIONS</b>			<b>SEAT DIMENSIONS</b>			<b>BACK DIMENSIONS</b>					
			<b>W</b>	<b>D</b>	<b>H</b>	<b>W</b>	<b>D</b>	<b>H</b>	<b>W</b>	<b>H</b>				
			IN 72	28	48	72	19	18	72	30				
			MM 1829	711	1219	1829	483	457	1829	762				
		<b>RTA 00</b>	1 per carton											
<p><b>78\"/&gt; </b></p>	<p><b>78\"/&gt; </b></p>	<p><b>8507-78</b></p>	4134	4390	4606	4854	5262	5638	6014	6342	6750	7134	7654	8390
			<b>OVERALL DIMENSIONS</b>			<b>SEAT DIMENSIONS</b>			<b>BACK DIMENSIONS</b>					
			<b>W</b>	<b>D</b>	<b>H</b>	<b>W</b>	<b>D</b>	<b>H</b>	<b>W</b>	<b>H</b>				
			IN 78	28	48	78	19	18	78	30				
			MM 1981	711	1219	1981	483	457	1981	762				
		<b>RTA 00</b>	1 per carton											
<p><b>48\"/&gt; </b></p>	<p><b>48\"/&gt; </b></p>	<p><b>8508-48</b></p>	4545	4833	5076	5355	5814	6237	6660	7029	7488	7920	8505	9333
			<b>OVERALL DIMENSIONS</b>			<b>SEAT DIMENSIONS</b>			<b>BACK DIMENSIONS</b>					
			<b>W</b>	<b>D</b>	<b>H</b>	<b>W</b>	<b>D</b>	<b>H</b>	<b>W</b>	<b>H</b>				
			IN 48	55	48	48	19	18	48	30				
			MM 1219	1397	1219	1219	483	457	1219	762				
		<b>RTA 00</b>	1 per carton											
<p><b>48\"/&gt; </b></p>	<p><b>48\"/&gt; </b></p>	<p><b>8508-48</b></p>	Optional knocked down (KD) packaging available (no upcharge)											
			<b>OVERALL DIMENSIONS</b>			<b>SEAT DIMENSIONS</b>			<b>BACK DIMENSIONS</b>					
			<b>W</b>	<b>D</b>	<b>H</b>	<b>W</b>	<b>D</b>	<b>H</b>	<b>W</b>	<b>H</b>				
			IN 48	55	48	48	19	18	48	30				
			MM 1219	1397	1219	1219	483	457	1219	762				
		<b>RTA 00</b>	1 per carton											

DESCRIPTION	FEATURES	MODEL #	STANDARD TEXTILE GRADES											
			1	2	3	4	5	6	7	8	9	10	11	12
 <p><b>60"W Four Seater Banquette, Double Back</b>                      COM: 10 YD   9.14 M                      Unit weight: 160 LB   72.7 KG                      Carton weight: 198 LB   89.81 KG                      Carton volume: 111 FT³   3.14 MT³</p>	Optional knocked down (KD) packaging available (no upcharge)	<b>8508-60</b>	5325	5645	5915	6225	6735	7205	7675	8085	8595	9075	9725	10645
			<b>OVERALL DIMENSIONS</b>			<b>SEAT DIMENSIONS</b>			<b>BACK DIMENSIONS</b>					
			<b>W</b>	<b>D</b>	<b>H</b>	<b>W</b>	<b>D</b>	<b>H</b>	<b>W</b>	<b>H</b>				
			IN 60	55	48	60	19	18	60	30				
			MM 1524	1397	1219	1524	483	457	1524	762				
		<b>RTA 00</b>	1 per carton											
 <p><b>72"W Six Seater Banquette, Double Back</b>                      COM: 11 YD   10.06 M                      Unit weight: 192 LB   87.3 KG                      Carton weight: 242 LB   109.77 KG                      Carton volume: 132.5 FT³   3.75 MT³</p>	Optional knocked down (KD) packaging available (no upcharge)	<b>8508-72</b>	5993	6345	6642	6983	7544	8061	8578	9029	9590	10118	10833	11845
			<b>OVERALL DIMENSIONS</b>			<b>SEAT DIMENSIONS</b>			<b>BACK DIMENSIONS</b>					
			<b>W</b>	<b>D</b>	<b>H</b>	<b>W</b>	<b>D</b>	<b>H</b>	<b>W</b>	<b>H</b>				
			IN 72	55	48	72	19	18	72	30				
			MM 1829	1397	1219	1829	483	457	1829	762				
		<b>RTA 00</b>	1 per carton											
 <p><b>78"W Six Seater Banquette, Double Back</b>                      COM: 12 YD   10.97 M                      Unit weight: 208 LB   94.5 KG                      Carton weight: 255 LB   115.67 KG                      Carton volume: 141.75 FT³   4.01 MT³</p>	Optional knocked down (KD) packaging available (no upcharge)	<b>8508-78</b>	6530	6914	7238	7610	8222	8786	9350	9842	10454	11030	11810	12914
			<b>OVERALL DIMENSIONS</b>			<b>SEAT DIMENSIONS</b>			<b>BACK DIMENSIONS</b>					
			<b>W</b>	<b>D</b>	<b>H</b>	<b>W</b>	<b>D</b>	<b>H</b>	<b>W</b>	<b>H</b>				
			IN 78	55	48	78	19	18	78	30				
			MM 1981	1397	1219	1981	483	457	1981	762				
		<b>RTA 00</b>	1 per carton											
			List price											
		<b>8509</b>	75											
 <p><b>Ganging Bracket Kit</b>                      COM: N/A                      Unit weight: 0.25 LB   - KG                      Carton weight: 0.5 LB   0.23 KG                      Carton volume: 0.1 FT³   0.03 MT³</p>	Kit includes 2 brackets.	<b>8509</b>	75											
			<b>OVERALL DIMENSIONS</b>			<b>SEAT DIMENSIONS</b>			<b>BACK DIMENSIONS</b>					
			<b>W</b>	<b>D</b>	<b>H</b>	<b>W</b>	<b>D</b>	<b>H</b>	<b>W</b>	<b>H</b>				
			IN 2.5	6	0.25	-	-	-	-	-				
			MM 64	152	6	-	-	-	-	-				
		<b>RTA 00</b>		1 per carton										

**VITROLA**



model 8271

model 8275



model 8274, 8275 and 8276

**STANDARD FEATURES**

- Classic soft seating upholstery design with swooping arms.
- Available in lounge, high back lounge, two seat sofa and three seat sofa.
- Matching ottoman and accent pillow complete the offering.
- Fully upholstered with piping details at the bottom of frame.
- Seat cushions are fixed or sewn tight.
- Standard in tapered maple wood legs. Legs are equipped with White non-marking glides as standard. Suitable for both carpet and hard surface flooring.
- Upholstery options: fabric, vinyl or leather. Vinyl and leather models may feature stitch detail across the seat and/or back cushions, if applicable.
- Back upholstery is continuous without seams. In the event the textile cannot be railroaded, stitch lines will be required (one for 2 seater and two for 3 seater).
- All models ship fully assembled.

**OPTIONAL FEATURES**

Please add option codes in the following order:



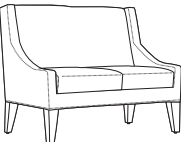

- **Model number**  
**8271** Lounge chair  
**8272** Two seat sofa  
**8273** Three seat sofa  
**8274** Ottoman  
**8275** High back lounge chair  
**8276** Accent pillow
- **Fabric**  
Specify fabric code.
- **Wood Legs**  
**(AB)** Absolute (AAM)  
**(BM)** Black (BKM)  
**(AC)** Cherry (ACM)  
**(EO)** English Oak (EOM)  
**(EC)** Espresso Café (ECM)  
**(HT)** Grey (HGM)  
**(AH)** Honey (AHM)  
**(TM)** Mahogany (TMM)  
**(AM)** Maple (AVM)  
**(MW)** Medium Walnut (MWM)  
**(NL)** Natural Walnut (NLW)  
**(AT)** Night (ASM)  
**(BI)** Noce Biondo (NBM)  
**(GI)** Noce Grigio (NGM)  
**(EI)** Noce Leggero (NEM)  
**(MI)** Noce Medio (NMM)  
**(SH)** Shaker Cherry (SKM)  
**(TF)** Fruitwood (TFM)  
**(TW)** Walnut (TWM)  
**(WR)** WC Cream (WTM)  
**(WH)** White (WHM)  
**(WM)** Winter Cherry (WCM)  
(colors shown on website)

**EXAMPLE VITROLA ORDER CODE:**

8271	WA50	HT
Model #	Fabric	Wood Legs

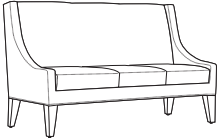
DESCRIPTION	FEATURES	MODEL #	STANDARD TEXTILE GRADES											
			1	2	3	4	5	6	7	8	9	10	11	12
 <p><b>Lounge Chair</b>  COM: 5.25 YD   4.8 M  Unit weight: 80 LB   36.4 KG  Carton weight: 90 LB   40.82 KG  Carton volume: 20.25 FT³   0.57 MT³</p>		<b>8271</b>	1423	1591	1733	1896	2163	2410	2657	2872	3140	3392	3733	4216
			<b>OVERALL DIMENSIONS</b>			<b>SEAT DIMENSIONS</b>			<b>BACK DIMENSIONS</b>					
			<b>W</b>	<b>D</b>	<b>H</b>	<b>W</b>	<b>D</b>	<b>H</b>	<b>W</b>	<b>H</b>				
			IN 28	31	34	22	20	18	22	16				
			MM 711	787	864	559	508	457	559	406				
			<b>RTA 00</b>	1 per carton										
 <p><b>Two Seat Sofa</b>  COM: 7.25 YD   6.63 M  Unit weight: 95 LB   43.2 KG  Carton weight: 107 LB   48.53 KG  Carton volume: 36.5 FT³   1.03 MT³</p>		<b>8272</b>	2349	2581	2777	3002	3371	3712	4053	4350	4720	5068	5539	6206
			<b>OVERALL DIMENSIONS</b>			<b>SEAT DIMENSIONS</b>			<b>BACK DIMENSIONS</b>					
			<b>W</b>	<b>D</b>	<b>H</b>	<b>W</b>	<b>D</b>	<b>H</b>	<b>W</b>	<b>H</b>				
			IN 51	31	34	45	20	18	45	16				
			MM 1295	787	864	1143	508	457	1143	406				
			<b>RTA 00</b>	1 per carton										



DESCRIPTION	FEATURES	MODEL #	STANDARD TEXTILE GRADES											
			1	2	3	4	5	6	7	8	9	10	11	12
 <p><b>Three Seat Sofa</b>                      COM: 9.25 YD   8.46 M                      Unit weight: 125 LB   56.8 KG                      Carton weight: 140 LB   63.5 KG                      Carton volume: 51.75 FT<sup>3</sup>   1.46 MT<sup>3</sup></p>		<b>8273</b>	3113	3409	3659	3946	4417	4852	5287	5666	6138	6582	7183	8034
			<b>OVERALL DIMENSIONS</b>			<b>SEAT DIMENSIONS</b>			<b>BACK DIMENSIONS</b>					
				<b>W</b>	<b>D</b>	<b>H</b>	<b>W</b>	<b>D</b>	<b>H</b>	<b>W</b>	<b>H</b>			
				IN 74.25	31	34	68.25	20	18	68.25	16			
				MM 1886	787	864	1734	508	457	1734	406			
			<b>RTA 00</b>	1 per carton										
 <p><b>Ottoman</b>                      COM: 1.75 YD   1.6 M                      Unit weight: 15 LB   6.8 KG                      Carton weight: 20 LB   9.07 KG                      Carton volume: 8 FT<sup>3</sup>   0.22 MT<sup>3</sup></p>		<b>8274</b>	525	581	628	683	772	854	936	1008	1097	1181	1295	1456
			<b>OVERALL DIMENSIONS</b>			<b>SEAT DIMENSIONS</b>			<b>BACK DIMENSIONS</b>					
				<b>W</b>	<b>D</b>	<b>H</b>	<b>W</b>	<b>D</b>	<b>H</b>	<b>W</b>	<b>H</b>			
				IN 24	24	17	24	-	17	-	-			
				MM 610	610	432	610	-	432	-	-			
			<b>RTA 00</b>	1 per carton										
 <p><b>High Back Lounge Chair</b>                      COM: 6.25 YD   5.72 M                      Unit weight: 85 LB   38.6 KG                      Carton weight: 96 LB   43.54 KG                      Carton volume: 28.25 FT<sup>3</sup>   0.79 MT<sup>3</sup></p>		<b>8275</b>	1652	1852	2021	2215	2533	2827	3121	3377	3696	3996	4402	4977
			<b>OVERALL DIMENSIONS</b>			<b>SEAT DIMENSIONS</b>			<b>BACK DIMENSIONS</b>					
				<b>W</b>	<b>D</b>	<b>H</b>	<b>W</b>	<b>D</b>	<b>H</b>	<b>W</b>	<b>H</b>			
				IN 28	31	42	22	20	18	22	18			
				MM 711	787	1067	559	508	457	559	457			
			<b>RTA 00</b>	1 per carton										
 <p><b>Accent Pillow</b>                      COM: 0.75 YD   0.69 M                      Unit weight: 3 LB   1.4 KG                      Carton weight: 4 LB   1.81 KG                      Carton volume: 1 FT<sup>3</sup>   0.02 MT<sup>3</sup></p>		<b>8276</b>	175	199	219	243	281	316	351	382	420	456	505	574
			<b>OVERALL DIMENSIONS</b>			<b>SEAT DIMENSIONS</b>			<b>BACK DIMENSIONS</b>					
				<b>W</b>	<b>D</b>	<b>H</b>	<b>W</b>	<b>D</b>	<b>H</b>	<b>W</b>	<b>H</b>			
				IN 23	6	8	-	-	-	-	-			
				MM 584	152	203	-	-	-	-	-			
			<b>RTA 00</b>	1 per carton										

WIND SEATING



model 3361 (lounge chair), model 3362 (two seat sofa) + model 3367 (coffee table)

ADDITIONAL STITCH DETAIL - ILLUSTRATIONS BELOW

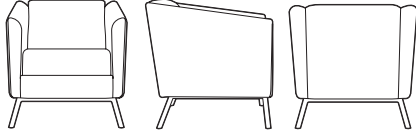

Standard detailing - when upholstered in fabric or vinyl

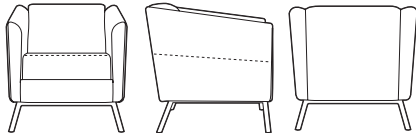

Additional detailing - when upholstered in leather

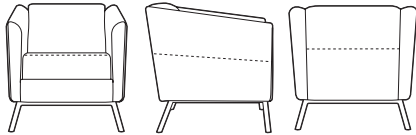

Additional detailing - when upholstered in genuine leather

For Wind tables, please see page 310.

For Wind Linear series, please see page 312. This series includes models with ganging solutions.

STANDARD FEATURES





- The Wind series includes freestanding lounge chairs and tables.
- Wind seating is a contemporary version of the traditional lounge chair with raised legs and is scaled down for smaller spaces.
- Wind seating models are available with metal or wood legs. Please see right column for additional details.
- A variety of glide types are available. Please see right column for additional details. Casters are not available on this series.
- Upholstery options: fabric, vinyl or leather. Vinyl and leather models may feature stitch detail across the seat and/or back cushions, if applicable.
- Available with contrasting fabrics. Specify arms, back and front rail separate from seat cushion.

Please add option codes in the following order:

- **Model number**  
**3361 to 3363**  
 Metal leg seating  
**3431 to 3433**  
 Wood leg seating
- **Back + arm textile** (includes front rail)  
 Specify fabric code.
- **Seat textile**  
 Specify fabric code.
- **Leg finish** (metal)  
 For leg frame finish options, please see page 360. Upcharges apply for plated finishes:  
**(CHM)** Chrome. No upcharge.  
**(BCH)** Brushed Chrome. Add \$49 for lounge chair. Add \$84 for two seat sofa. Add \$174 for three seat sofa.  
**(SBR)** Satin Brass. Add \$132 for lounge chair. Add \$204 for two seat sofa. Add \$399 for three seat sofa.  
**(ACO)** Antique Copper. Add \$132 for lounge chair. Add \$204 for two seat sofa. Add \$399 for three seat sofa.
- **Leg finish** (wood)
 

<b>(AAM)</b> Absolute	<b>(NLW)</b> Natural Walnut
<b>(BKM)</b> Black	<b>(ASM)</b> Night
<b>(ACM)</b> Cherry	<b>(NBM)</b> Noce Biondo
<b>(EOM)</b> English Oak	<b>(NGM)</b> Noce Grigio
<b>(ECM)</b> Espresso Cafe	<b>(NEM)</b> Noce Leggero
<b>(TFM)</b> Fruitwood	<b>(NMM)</b> Noce Medio
<b>(HGM)</b> Gray	<b>(SKM)</b> Shaker Cherry
<b>(AHM)</b> Honey	<b>(TWM)</b> Walnut
<b>(TMM)</b> Mahogany	<b>(WTM)</b> WC Cream
<b>(AVM)</b> Maple	<b>(WHM)</b> White
<b>(MWM)</b> Medium Walnut	<b>(WCM)</b> Winter Cherry
- **Glide type** (metal legs only)
  - (GL)** Black glide for most surfaces (standard)
  - (NM)** non-marking glides for most surfaces. No upcharge.
- **Glide type** (wood leg seating only)
  - (NM)** non-marking glides for most surfaces (standard)
  - (SG)** steel cushioned glides for carpeted surfaces. Add \$17.
  - (RG)** non-slip rubber glides for most hard floor surfaces. Add \$22.
  - (FG)** felt glides for most hard floor surfaces. Add \$22.

DESCRIPTION	FEATURES	MODEL #	STANDARD TEXTILE GRADES											
			1	2	3	4	5	6	7	8	9	10	11	12
 <p><b>Lounge Chair, Metal Legs</b>                      COM: 4.5 YD   4.11 M                      Unit weight: 55 LB   25 KG                      Carton weight: 62 LB   28.12 KG                      Carton volume: 16.5 FT³   0.46 MT³</p>		<b>3361</b>	-	1711	1832	1973	2202	2413	2624	2809	3038	3254	3547	3961
			<b>OVERALL DIMENSIONS</b>			<b>SEAT DIMENSIONS</b>			<b>BACK DIMENSIONS</b>					
				<b>W</b>	<b>D</b>	<b>H</b>	<b>W</b>	<b>D</b>	<b>H</b>	<b>W</b>	<b>H</b>			
			IN 27.5	29	28.5	19.5	19	17	19	12				
			MM 699	737	724	495	483	432	483	305				
			<b>RTA.00</b>		1 per carton									

DESCRIPTION	FEATURES	MODEL#	STANDARD TEXTILE GRADES											
			1	2	3	4	5	6	7	8	9	10	11	12
 <p><b>Two Seat Sofa, Metal Legs</b> COM: 6.75 YD   6.17 M Unit weight: 95 LB   43.2 KG Carton weight: 102 LB   46.27 KG Carton volume: 30 FT³   0.84 MT³</p>		<b>3362</b>	-	2288	2471	2680	3024	3341	3659	3935	4280	4604	5042	5663
 <p><b>Three Seat Sofa, Metal Legs</b> COM: 9 YD   8.23 M Unit weight: 125 LB   56.8 KG Carton weight: 135 LB   61.23 KG Carton volume: 42.5 FT³   1.2 MT³</p>		<b>3363</b>	-	2863	3107	3385	3845	4267	4691	5059	5519	5951	6535	7363
 <p><b>Lounge Chair, Wood Legs</b> COM: 6 YD   5.49 M Unit weight: 53 LB   24.1 KG Carton weight: 59 LB   26.76 KG Carton volume: 16.5 FT³   0.46 MT³</p>		<b>3431</b>	-	1968	2130	2317	2622	2904	3186	3432	3738	4026	4416	4968
 <p><b>Two Seat Sofa, Wood Legs</b> COM: 6.75 YD   6.17 M Unit weight: 91 LB   41.4 KG Carton weight: 98 LB   44.45 KG Carton volume: 30 FT³   0.84 MT³</p>		<b>3432</b>	-	2631	2814	3023	3367	3684	4002	4278	4623	4947	5385	6006
 <p><b>Three Seat Sofa, Wood Legs</b> COM: 9 YD   8.23 M Unit weight: 119 LB   54.1 KG Carton weight: 129 LB   58.51 KG Carton volume: 42.5 FT³   1.2 MT³</p>		<b>3433</b>	-	3292	3536	3814	4274	4696	5120	5488	5948	6380	6964	7792

WIND TABLES



model 3367 (rectangular coffee table)





For Wind seating, please see page 308.

STANDARD FEATURES

- Wind tables complement the modern decor of many environments, pairing naturally with Wind and Wind Linear lounge seating and other contemporary series (such as Kate, Erin and Marche).
- Wind table models are only available with metal legs. Please see right column for additional details.
- A variety of glide types are available. Please see right column for additional details.
- Table tops are offered in thermally fused laminate finishes to coordinate with Global casegoods and wood seating. They are also available in high pressure laminate (HPL) at a 20% upcharge. Please specify HPL in addition to finish code.

Please add option codes in the following order:

- **Model number**  
Specify model number
- **Laminate top finish (LPL)**  
Absolute Acajou (ACJ), Asian Night (ASN), Avant Cherry (AWC), Avant Honey (AWH), Black (BLK), Blizzard (BZD), Brushed Cobalt (BRC), Clear Maple (CMB), Custom Grey (CGY), Dark Espresso (DES), Designer White (DWT), Fashionista (FAS), First Class (FCL), Noce Biondo (NBL), Noce Grigio (NGL), Noce Leggero (NEL), Noce Medio (NML), Quartered Mahogany (QTM), Sheer Beauty (SBY), Stonedust (SDT), Storm Grey (SOG), Walnut Heights (WHE), White Chocolate (WHC) and Winter Cherry (WCR).
- **Leg finish**  
For leg frame finish options, please see page 360. Upcharges apply for plated finishes:  
(CHM) Chrome. No upcharge.  
(BCH) Brushed Chrome. Add \$73.  
(SBR) Satin Brass. Add \$189.  
(ACO) Antique Copper. Add \$189.
- **Glide type**  
(GL) Black glide for most surfaces (standard)  
(NM) non-marking glides for most surfaces.  
No upcharge.

DESCRIPTION	FEATURES	MODEL #	STANDARD TEXTILE GRADES									
 <p><b>End Table, Metal Legs</b> COM: N/A Unit weight: 24 LB   10.9 KG Carton weight: 36 LB   16.33 KG Carton volume: 11.5 FT³   0.32 MT³</p>		List price										
		3366	661									
		Laminate top										
		OVERALL DIMENSIONS			SEAT DIMENSIONS			BACK DIMENSIONS				
			W	D	H	W	D	H	W	H		
IN	24	24	17	-	-	-	-	-				
MM	610	610	432	-	-	-	-	-				
		RTA 00	1 per carton									
 <p><b>Rectangular Coffee Table, Metal Legs</b> COM: N/A Unit weight: 39 LB   17.7 KG Carton weight: 52 LB   23.59 KG Carton volume: 16 FT³   0.45 MT³</p>		List price										
		3367	886									
		Laminate top										
		OVERALL DIMENSIONS			SEAT DIMENSIONS			BACK DIMENSIONS				
			W	D	H	W	D	H	W	H		
IN	48	20	15	-	-	-	-	-				
MM	1219	508	381	-	-	-	-	-				
		RTA 00	1 per carton									
 <p><b>Square End Table, Metal Legs</b> COM: N/A Unit weight: 50 LB   22.7 KG Carton weight: 66 LB   29.94 KG Carton volume: 22 FT³   0.62 MT³</p>		List price										
		3368	1214									
		Laminate top										
		OVERALL DIMENSIONS			SEAT DIMENSIONS			BACK DIMENSIONS				
			W	D	H	W	D	H	W	H		
IN	36	36	15	-	-	-	-	-				
MM	914	914	381	-	-	-	-	-				
		RTA 00	1 per carton									
 <p><b>Round End Table, Metal Legs</b> COM: N/A Unit weight: 30 LB   13.6 KG Carton weight: 35 LB   15.88 KG Carton volume: 11.5 FT³   0.32 MT³</p>		List price										
		3870	721									
		Laminate top										
		OVERALL DIMENSIONS			SEAT DIMENSIONS			BACK DIMENSIONS				
			W	D	H	W	D	H	W	H		
IN	24	24	17	-	-	-	-	-				
MM	610	610	432	-	-	-	-	-				
		RTA 00	1 per carton									

DESCRIPTION	FEATURES	MODEL#	STANDARD TEXTILE GRADES								
 <p><b>Round Coffee Table, Metal Legs</b>                      COM: N/A                      Unit weight: 50 LB   22.7 KG                      Carton weight: 57 LB   25.85 KG                      Carton volume: 22 FT<sup>3</sup>   0.62 MT<sup>3</sup></p>			List price								
			<b>3871</b>	1115							
				Laminate top							
				<b>OVERALL DIMENSIONS</b>			<b>SEAT DIMENSIONS</b>			<b>BACK DIMENSIONS</b>	
				<b>W</b>	<b>D</b>	<b>H</b>	<b>W</b>	<b>D</b>	<b>H</b>	<b>W</b>	<b>H</b>
			IN 36	36	15	-	-	-	-	-	
			MM 914	914	381	-	-	-	-	-	
			<b>RTA 00</b>		1 per carton						

WIND LINEAR SEATING



models 3363R and 3363L with 3882 bridge table, 3360 table attaching bracket kit and two 3880 coffee tables

For Wind Linear tables, please see page 316.

STANDARD FEATURES



- Wind Linear is an extension of the Wind lounge series with an emphasis on expansive, clean lines.
- This modular furniture series includes single arm and armless sofas, benches, bridges and tables.
- Seating can be used as stand-alone products or can be ganged together. See ganging features below for more information.
- Wind Linear seating models are available with metal or wood legs. Please see right column for additional details.
- A variety of glide types are available. Please see right column for additional details. Casters are not available on this series.
- Upholstery options: fabric, vinyl or leather. Vinyl and leather models may feature stitch detail across the seat and/or back cushions, if applicable.
- Available with contrasting fabrics. Specify arms, back and front rail separate from seat cushion.

GANGING



- Metal leg (seating): Table bridges can mount outside or in-between seats to accommodate various work and collaborative settings. Requires table attaching bracket kit 3360.
- Wood leg (seating): Seat-to-seat ganging bracket option is available to gang seating together at armless ends. Option must be selected at the time of the order, the ganging bracket is factory installed and cannot be added in the field. Wind Linear bridge/end tables (models 3882 + 3884) can mount in between seats.
- Benches and ottomans cannot gang with seating units.



Please add option codes in the following order:

- **Model number**  
**3361L/R/NA, 3363L/R/NA, 3361B + 3363B**  
 Metal leg seating  
**3431L/R/NA, 3433L/R/NA, 3434B + 3435B**  
 Wood leg seating
- **Back + arm textile** (includes front rail)  
 Specify fabric code.
- **Seat textile**  
 Specify fabric code.
- **Leg finish** (metal)  
 For metal leg frame finish options, please see page 360. Upcharges apply for plated finishes:  
**(CHM)** Chrome. No upcharge.  
**(BCH)** Brushed Chrome. Add \$130 for single seaters. Add \$200 for three seat sofas. Add \$107 for ottoman. Add \$193 for bench.  
**(SBR)** Satin Brass. Add \$275 for single seater. Add \$449 for three seat sofa. Add \$228 for ottoman. Add \$441 for bench.
- **(ACO)** Antique Copper. Add \$275 for single seater. Add \$449 for three seat sofa. Add \$228 for ottoman. Add \$441 for bench.
- **Leg finish** (wood)  
**(AAM)** Absolute **(NLW)** Natural Walnut  
**(BKM)** Black **(ASM)** Night  
**(ACM)** Cherry **(NBM)** Noce Biondo  
**(EOM)** English Oak **(NGM)** Noce Grigio  
**(ECM)** Espresso Cafe **(NEM)** Noce Leggero  
**(TFM)** Fruitwood **(NMM)** Noce Medio  
**(HGM)** Gray **(SKM)** Shaker Cherry  
**(AHM)** Honey **(TWM)** Walnut  
**(TMM)** Mahogany **(WTM)** WC Cream  
**(AVM)** Maple **(WHM)** White  
**(MWM)** Medium Walnut **(WCM)** Winter Cherry
- **Glide type** (metal legs only)  
**(GL)** Black glide for most surfaces (standard)  
**(NM)** non-marking glides for most surfaces. No upcharge.
- **Glide type** (wood leg seating only)  
**(NM)** non-marking glides for most surfaces (standard)  
**(SG)** steel cushioned glides for carpeted surfaces. Add \$17.  
**(RG)** non-slip rubber glides for most hard floor surfaces. Add \$22.  
**(FG)** felt glides for most hard floor surfaces. Add \$22.
- **Ganging** (wood leg seating only)  
**(NG)** no ganging (standard)  
**(GS)** ganging seat to seat. See models for upcharges.

DESCRIPTION	FEATURES	MODEL #	STANDARD TEXTILE GRADES											
			1	2	3	4	5	6	7	8	9	10	11	12
 <p>3361R</p>	 <p>3361L</p>	3361R	-	1866	1995	2142	2384	2607	2831	3025	3268	3496	3804	4241
		3361L												
			OVERALL DIMENSIONS			SEAT DIMENSIONS			BACK DIMENSIONS					
			W	D	H	W	D	H	W	H				
			IN 39.5	29	28.5	36	19	17	36	12				
			MM 1003	737	724	914	483	432	914	305				
			<b>RTA 00</b>		1 per carton									



Single Seater - w/Left or Right Arm, Metal Legs  
 COM: 4.75 YD | 4.34 M  
 Unit weight: 62 LB | 28.2 KG  
 Carton weight: 72 LB | 32.66 KG  
 Carton volume: 28.5 FT³ | 0.8 MT³

DESCRIPTION	FEATURES	MODEL#	STANDARD TEXTILE GRADES												
			1	2	3	4	5	6	7	8	9	10	11	12	
 <p><b>Single Seater - Armless, Metal Legs</b>                      COM: 3.25 YD   2.97 M                      Unit weight: 48 LB   21.8 KG                      Carton weight: 58 LB   26.31 KG                      Carton volume: 28.5 FT³   0.8 MT³</p>		<b>3361NA</b>	-	1673	1761	1862	2028	2180	2333	2466	2632	2788	2999	3298	
				<b>OVERALL DIMENSIONS</b>			<b>SEAT DIMENSIONS</b>			<b>BACK DIMENSIONS</b>					
				<b>W</b>	<b>D</b>	<b>H</b>	<b>W</b>	<b>D</b>	<b>H</b>	<b>W</b>	<b>H</b>				
				IN 36.5	29	28.5	36.5	19	17	36.5	12				
				MM 927	737	724	927	483	432	927	305				
			<b>RTA 00</b>	1 per carton											
 <p><b>Three Seat Sofa - w/Left or Right Arm, Metal Legs</b>                      COM: 7.75 YD   7.09 M                      Unit weight: 105 LB   47.7 KG                      Carton weight: 120 LB   54.43 KG                      Carton volume: 41 FT³   1.16 MT³</p>		<b>3363R</b> <b>3363L</b>	-	2672	2882	3122	3517	3881	4246	4563	4959	5331	5834	6547	
				<b>OVERALL DIMENSIONS</b>			<b>SEAT DIMENSIONS</b>			<b>BACK DIMENSIONS</b>					
				<b>W</b>	<b>D</b>	<b>H</b>	<b>W</b>	<b>D</b>	<b>H</b>	<b>W</b>	<b>H</b>				
				IN 75	29	28.5	71	19	17	71	12				
				MM 1905	737	724	1803	483	432	1803	305				
			<b>RTA 00</b>	1 per carton											
 <p><b>Three Seat Sofa - Armless, Metal Legs</b>                      COM: 6.5 YD   5.94 M                      Unit weight: 96 LB   43.6 KG                      Carton weight: 111 LB   50.35 KG                      Carton volume: 39.25 FT³   1.11 MT³</p>		<b>3363NA</b>	-	2479	2655	2857	3187	3493	3799	4065	4397	4709	5131	5729	
				<b>OVERALL DIMENSIONS</b>			<b>SEAT DIMENSIONS</b>			<b>BACK DIMENSIONS</b>					
				<b>W</b>	<b>D</b>	<b>H</b>	<b>W</b>	<b>D</b>	<b>H</b>	<b>W</b>	<b>H</b>				
				IN 72	29	28.5	72	19	17	72	12				
				MM 1829	737	724	1829	483	432	1829	305				
			<b>RTA 00</b>	1 per carton											
 <p><b>Ottoman, Metal Legs</b>                      COM: 1.75 YD   1.6 M                      Unit weight: 38 LB   17.3 KG                      Carton weight: 50 LB   22.68 KG                      Carton volume: 12.5 FT³   0.35 MT³</p>		<b>3361B</b>	-	1290	1337	1392	1481	1563	1645	1717	1806	1890	2004	2165	
				<b>OVERALL DIMENSIONS</b>			<b>SEAT DIMENSIONS</b>			<b>BACK DIMENSIONS</b>					
				<b>W</b>	<b>D</b>	<b>H</b>	<b>W</b>	<b>D</b>	<b>H</b>	<b>W</b>	<b>H</b>				
				IN 35.5	20.5	17.5	-	-	-	-	-				
				MM 902	521	445	-	-	-	-	-				
			<b>RTA 00</b>	1 per carton											
 <p><b>Bench, Metal Legs</b>                      COM: 3.5 YD   3.2 M                      Unit weight: 70 LB   31.8 KG                      Carton weight: 80 LB   36.29 KG                      Carton volume: 18.75 FT³   0.53 MT³</p>		<b>3363B</b>	-	1943	2038	2146	2325	2489	2654	2797	2976	3144	3371	3693	
				<b>OVERALL DIMENSIONS</b>			<b>SEAT DIMENSIONS</b>			<b>BACK DIMENSIONS</b>					
				<b>W</b>	<b>D</b>	<b>H</b>	<b>W</b>	<b>D</b>	<b>H</b>	<b>W</b>	<b>H</b>				
				IN 72	20.5	17.5	-	-	17.5	-	-				
				MM 1829	521	445	-	-	445	-	-				
			<b>RTA 00</b>	1 per carton											

DESCRIPTION	FEATURES	MODEL#	STANDARD TEXTILE GRADES														
			1	2	3	4	5	6	7	8	9	10	11	12			
 <p><b>3431R</b>                      <b>3431L</b></p> <p><b>Single Seater - w/Left or Right Arm, Wood Legs</b>                      COM: 4.75 YD   4.34 M                      Unit weight: 60 LB   27.3 KG                      Carton weight: 70 LB   31.75 KG                      Carton volume: 28.5 FT³   0.8 MT³</p>	Optional ganging bracket (1 unit) for seat to seat on 1 side - add \$12.	<b>3431R</b>	-	2146	2275	2422	2664	2887	3111	3305	3548	3776	4084	4521			
		<b>3431L</b>															
		<b>OVERALL DIMENSIONS</b>			<b>SEAT DIMENSIONS</b>			<b>BACK DIMENSIONS</b>									
		IN	39.5	29	28.5	36	19	17	36	12	MM	1003	737	724	914	483	432
	<b>RTA 00</b>	1 per carton															
 <p><b>3431NA</b></p> <p><b>Single Seater - Armless, Wood Legs</b>                      COM: 3.25 YD   2.97 M                      Unit weight: 46 LB   20.9 KG                      Carton weight: 56 LB   25.4 KG                      Carton volume: 28.5 FT³   0.8 MT³</p>	Optional ganging bracket (2 units) for seat to seat on both sides - add \$24.	<b>3431NA</b>	-	1924	2012	2113	2279	2431	2584	2717	2883	3039	3250	3549			
		<b>3431NA</b>															
		<b>OVERALL DIMENSIONS</b>			<b>SEAT DIMENSIONS</b>			<b>BACK DIMENSIONS</b>									
		IN	36.5	29	28.5	36.5	19	17	36.5	12	MM	927	737	724	927	483	432
	<b>RTA 00</b>	1 per carton															
 <p><b>3433R</b>                      <b>3433L</b></p> <p><b>Three Seat Sofa - w/Left or Right Arm, Wood Legs</b>                      COM: 7.75 YD   7.09 M                      Unit weight: 99 LB   45 KG                      Carton weight: 111 LB   50.35 KG                      Carton volume: 41 FT³   1.16 MT³</p>	Optional ganging bracket (1 unit) for seat to seat on 1 side - add \$12.	<b>3433R</b>	-	3073	3283	3523	3918	4282	4647	4964	5360	5732	6235	6948			
		<b>3433L</b>															
		<b>OVERALL DIMENSIONS</b>			<b>SEAT DIMENSIONS</b>			<b>BACK DIMENSIONS</b>									
		IN	75	29	28.5	71	19	17	71	12	MM	1905	737	724	1803	483	432
	<b>RTA 00</b>	1 per carton															
 <p><b>3433NA</b></p> <p><b>Three Seat Sofa - Armless, Wood Legs</b>                      COM: 6.5 YD   5.94 M                      Unit weight: 90 LB   40.9 KG                      Carton weight: 105 LB   47.63 KG                      Carton volume: 39.25 FT³   1.11 MT³</p>	Optional ganging bracket (2 units) for seat to seat on both sides - add \$24.	<b>3433NA</b>	-	2851	3027	3229	3559	3865	4171	4437	4769	5081	5503	6101			
		<b>3433NA</b>															
		<b>OVERALL DIMENSIONS</b>			<b>SEAT DIMENSIONS</b>			<b>BACK DIMENSIONS</b>									
		IN	72	29	28.5	72	19	17	72	12	MM	1829	737	724	1829	483	432
	<b>RTA 00</b>	1 per carton															
 <p><b>3434B</b></p> <p><b>Ottoman, Wood Legs</b>                      COM: 1.75 YD   1.6 M                      Unit weight: 36 LB   16.4 KG                      Carton weight: 48 LB   21.77 KG                      Carton volume: 12.5 FT³   0.35 MT³</p>		<b>3434B</b>	-	1484	1531	1586	1675	1757	1839	1911	2000	2084	2198	2359			
		<b>3434B</b>															
		<b>OVERALL DIMENSIONS</b>			<b>SEAT DIMENSIONS</b>			<b>BACK DIMENSIONS</b>									
		IN	35.5	20.5	17.5	-	-	-	-	-	MM	902	521	445	-	-	-
	<b>RTA 00</b>	1 per carton															



DESCRIPTION	FEATURES	MODEL#	STANDARD TEXTILE GRADES											
			1	2	3	4	5	6	7	8	9	10	11	12
 <p><b>Bench, Wood Legs</b>                      COM: 3.5 YD   3.2 M                      Unit weight: 66 LB   30 KG                      Carton weight: 76 LB   34.47 KG                      Carton volume: 18.75 FT³   0.53 MT³</p>		<b>3435B</b>	-	2234	2329	2437	2616	2780	2945	3088	3267	3435	3662	3984
				OVERALL DIMENSIONS			SEAT DIMENSIONS			BACK DIMENSIONS				
				W	D	H	W	D	H	W	H			
				IN 72	20.5	17.5	-	-	17.5	-	-			
			MM 1829	521	445	-	-	445	-	-				
			<b>RTA 00</b>	1 per carton										

DESCRIPTION	FEATURES	MODEL#	STANDARD TEXTILE GRADES											
			1	2	3	4	5	6	7	8	9	10	11	12
 <p><b>Bolster Cushion</b>                      COM: 1 YD   0.91 M                      Unit weight: 1 LB   0.5 KG                      Carton weight: 1.5 LB   0.68 KG                      Carton volume: 1.3 FT³   0.03 MT³</p>	1 loose cushion.	<b>3885</b>	-	133	160	191	242	289	336	377	428	476	541	633
				OVERALL DIMENSIONS			SEAT DIMENSIONS			BACK DIMENSIONS				
				W	D	H	W	D	H	W	H			
				IN 16	5	7	-	-	-	-	-			
			MM 406	127	178	-	-	-	-	-				
			<b>RTA 00</b>		1 per carton									

WIND LINEAR TABLES



model 3878 (side table - rectangular)

For Wind Linear seating, please see page 312.

STANDARD FEATURES





- Wind Linear is an extension of the Wind lounge series with an emphasis on expansive, clean lines.
- Seating and freestanding tables can be used as stand-alone products. Seating units can be linked together using bridge tables to create infinite configurations.
- Tables are available with metal legs. Please see right column for additional details.
- A variety of glide types are available. Please see right column for additional details. Casters are not available on this series.
- Models are offered in thermally fused laminate finishes to coordinate with Global casegoods and wood seating.









GANGING

- Table bridges can mount outside or in-between seats to accommodate various work and collaborative settings. Requires table attaching bracket kit 3360.
- Bridge corner and end tables mount between chairs and/or sofa units only (at armless ends). Bridge table (model 3884) is only to be used with ottomans and/or benches. Both require table attaching bracket kit 3360.

Please add option codes in the following order:

- **Model number**  
**3878, 3879, 3880, 3881L + 3883**  
 Metal leg tables  
**3882 + 3884**  
 Bridge tables (no legs)
- **Laminate top finish (LPL)**  
 Absolute Acajou (ACJ), Asian Night (ASN), Avant Cherry (AWC), Avant Honey (AWH), Black (BLK), Blizzard (BZD), Brushed Cobalt (BRC), Clear Maple (CMB), Custom Grey (CGY), Dark Espresso (DES), Designer White (DWT), Fashionista (FAS), First Class (FCL), Noce Biondo (NBL), Noce Grigio (NGL), Noce Leggero (NEL), Noce Medio (NML), Quartered Mahogany (QTM), Sheer Beauty (SBY), Stonedust (SDT), Storm Grey (SOG), Walnut Heights (WHE), White Chocolate (WHC) and Winter Cherry (WCR).
- **Leg finish (metal)**  
 For metal leg frame finish options, please see page 360. Upcharges apply for plated finishes:  
**(CHM)** Chrome. No upcharge (except on bridge corner table model 3881 - add \$61)  
**(BCH)** Brushed Chrome. Add \$73.  
**(SBR)** Satin Brass. Add \$189.  
**(ACO)** Antique Copper. Add \$189.
- **Glide type (metal legs only)**  
**(GL)** Black glide for most surfaces (standard)  
**(NM)** non-marking glides for most surfaces.  
 No upcharge.

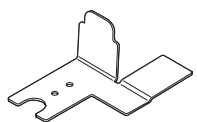
DESCRIPTION	FEATURES	MODEL #	STANDARD TEXTILE GRADES						
 <p><b>Side Table - Rectangular, Metal Legs</b>                      COM: N/A                      Unit weight: 30 LB   13.6 KG                      Carton weight: 38 LB   17.24 KG                      Carton volume: 11.5 FT³   0.32 MT³</p>	Freestanding.	List price							
		<b>3878</b>	1112						
		OVERALL DIMENSIONS			SEAT DIMENSIONS			BACK DIMENSIONS	
		W	D	H	W	D	H	W	H
IN 20	25	16	-	-	-	-	-		
MM 508	635	406	-	-	-	-	-		
		<b>RTA 00</b>		1 per carton					
 <p><b>Side Table - 25" Square, Metal Legs</b>                      COM: N/A                      Unit weight: 32 LB   14.5 KG                      Carton weight: 40 LB   18.14 KG                      Carton volume: 11.5 FT³   0.32 MT³</p>	Freestanding.	List price							
		<b>3879</b>	1241						
		OVERALL DIMENSIONS			SEAT DIMENSIONS			BACK DIMENSIONS	
		W	D	H	W	D	H	W	H
IN 25	25	16	-	-	-	-	-		
MM 635	635	406	-	-	-	-	-		
		<b>RTA 00</b>		1 per carton					
 <p><b>Coffee Table - 54", Metal Legs</b>                      COM: N/A                      Unit weight: 39 LB   17.7 KG                      Carton weight: 52 LB   23.59 KG                      Carton volume: 16 FT³   0.45 MT³</p>	Freestanding.	List price							
		<b>3880</b>	1393						
		OVERALL DIMENSIONS			SEAT DIMENSIONS			BACK DIMENSIONS	
		W	D	H	W	D	H	W	H
IN 54	20	15	-	-	-	-	-		
MM 1372	508	381	-	-	-	-	-		
		<b>RTA 00</b>	1 per carton						

DESCRIPTION	FEATURES	MODEL#	STANDARD TEXTILE GRADES							
 <p><b>3881R</b>      <b>3881L</b></p> <p><b>Bridge Corner Table - Right or Left, Metal Legs</b>                      COM: N/A                      Unit weight: 25 LB   11.4 KG                      Carton weight: 33 LB   14.97 KG                      Carton volume: 11.5 FT³   0.32 MT³</p>	Requires bracket kit (3360).  Chrome (CHM) leg frame finish - add \$61.	<b>3881R</b>	List price							
		3881L	1502							
			<b>OVERALL DIMENSIONS</b>			<b>SEAT DIMENSIONS</b>			<b>BACK DIMENSIONS</b>	
			W	D	H	W	D	H	W	H
			IN 25	25	12	-	-	-	-	-
			MM 635	635	305	-	-	-	-	-
			<b>RTA 00</b>		1 per carton					
 <p><b>Bridge End Table</b>                      COM: N/A                      Unit weight: 20 LB   9.1 KG                      Carton weight: 25 LB   11.34 KG                      Carton volume: 3.4 FT³   0.09 MT³</p>	Requires bracket kit (3360).  To be used with chair and sofa models. Not usable with bench or ottoman models.	<b>3882</b>	List price							
			789							
			<b>OVERALL DIMENSIONS</b>			<b>SEAT DIMENSIONS</b>			<b>BACK DIMENSIONS</b>	
			W	D	H	W	D	H	W	H
			IN 20	25	5	-	-	-	-	-
			MM 508	635	127	-	-	-	-	-
			<b>RTA 00</b>		1 per carton					
 <p><b>Low Side Table, Metal Legs</b>                      COM: N/A                      Unit weight: 26 LB   11.8 KG                      Carton weight: 32 LB   14.51 KG                      Carton volume: 11.5 FT³   0.32 MT³</p>	Freestanding.	<b>3883</b>	List price							
			1098							
			<b>OVERALL DIMENSIONS</b>			<b>SEAT DIMENSIONS</b>			<b>BACK DIMENSIONS</b>	
			W	D	H	W	D	H	W	H
			IN 20	25	12	-	-	-	-	-
			MM 508	635	305	-	-	-	-	-
			<b>RTA 00</b>		1 per carton					
 <p><b>Bridge Table - 20" Square</b>                      COM: N/A                      Unit weight: 18 LB   8.2 KG                      Carton weight: 23 LB   10.43 KG                      Carton volume: 3.4 FT³   0.09 MT³</p>	Requires bracket kit (3360).  To be used with bench and ottoman models. Not usable with chair or sofa models.	<b>3884</b>	List price							
			710							
			<b>OVERALL DIMENSIONS</b>			<b>SEAT DIMENSIONS</b>			<b>BACK DIMENSIONS</b>	
			W	D	H	W	D	H	W	H
			IN 20	20	5	-	-	-	-	-
			MM 508	508	127	-	-	-	-	-
			<b>RTA 00</b>	1 per carton						
 <p><b>Table Bracket Kit</b>                      COM: N/A                      Unit weight: 1 LB   0.5 KG                      Carton weight: 1.5 LB   0.68 KG                      Carton volume: 0.5 FT³   0.01 MT³</p>	Kit includes 4 brackets and hardware. Use with models 3881L, 3881R, 3882, 3884, 3436R and 3436L.  1 kit per carton.	<b>3360</b>	List price							
			125							
			<b>OVERALL DIMENSIONS</b>			<b>SEAT DIMENSIONS</b>			<b>BACK DIMENSIONS</b>	
			W	D	H	W	D	H	W	H
			IN 5	7.5	3	-	-	-	-	-
			MM 127	191	76	-	-	-	-	-
			<b>RTA 00</b>		1 kit per carton					