

Global's Swap collection is a comprehensive offering including laptop tables, casual meeting tables, café tables, huddle tables and more. Suitable for a variety of applications: break rooms, dedicated/enclosed meeting rooms, casual/open area meeting spaces (lounge, seated, counter and bar height options), and private office (accommodate smaller 3-4 person discussions). Tops and bases are sold separately for ease of specification. Mix and match capabilities to create spaces for multi-purpose use. Choose your top, choose your base. Create the combination you desire for the way you want to work.

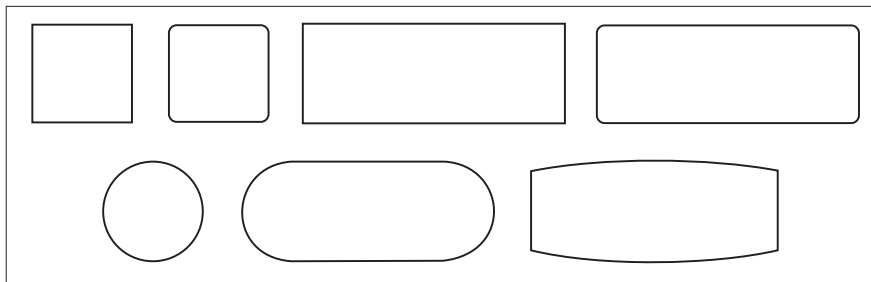

Top shapes

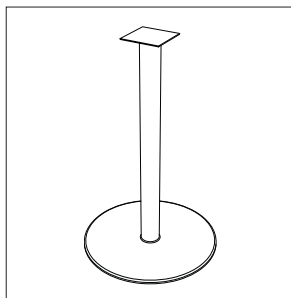

Round base

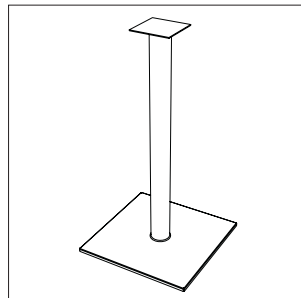

Square base

**Features and Benefits**

- Tops are available in four materials to help perfect your interior design: thermally fused laminate, high pressure laminate, veneer and solid surface.
- **High performance thermally fused laminate** tops are 1" thick with a 45 lb. density particle board core and feature 2mm thick edgeband.
- **High pressure laminate** tops are 1 1/16" thick with 2mm flat edge or 1 3/16" thick with knife edge profile. Tops with flat edge have a 45 lb. density particle board core; tops with knife edge have a MDF core.
- **Veneer** tops are 1 3/16" thick overall with matching flat edge or knife edge.
- **Solid surface** tops are 1 1/4" thick with a plywood or particle board melamine subtop depending on size, available with flat edge or knife edge.
- Bases are constructed of a solid steel metal plate and cover - round or square.
- Power block cut-outs are available on most tables.
- 6 heights:  
 Coffee table height at 16"H.  
 End table height at 22"H.  
 Lounge height at 27"H.  
 Seated height at 29"H.  
 Counter height at 36"H.  
 Bar height at 41.5"H.

## GENERAL INFORMATION

- Swap is a series of tables for use in casual meeting spaces, lounges, café areas and more.
- The right proportions, flawless surfaces and a solid foundation is sure to become your favorite table series to spec.
- Finish palette coordinates with most Global laminate and veneer casegoods series as well as a variety of solid surface options to choose from - tables can stand-alone or blend with other solutions.
- Each component is packed individually. Bases are shipped assembled, 1 per carton. Easy to assemble.
- For environmental certifications, please visit [globalfurnituregroup.com](http://globalfurnituregroup.com).

## WORKSURFACES

- Four material choices: high performance thermally fused laminate, high pressure laminate, veneer and solid surface.
- **Thermally fused laminate** tops are 1" thick overall with a 45 lb. density particle board core and feature 2mm thick edgeband. Edgeband finish can be specified to match or contrast the surface finish.
- **High pressure laminate** tops are 1 1/16" thick with 2mm flat edge or 1 3/16" thick with knife edge. 1 1/16" thick tops have a 45 lb. density particle board core and the 2mm flat edge finish can be specified to match or complement the top surface. 1 3/16" thick tops have an MDF core and the knife edge finish will match top surface. Models ending in **(LK)** indicate high pressure laminate with knife edge.
- **Veneer** tops are 1 3/16" thick overall with choice of edge detail - flat edge or knife edge. Edge finish will correspond to surface finish. When flat edge, core material is 45 lb. density particle board; when knife edge, core material is MDF. Models ending in **(V)** indicate veneer.
- **Solid surface** tops are 1 1/4" thick overall with choice of edge detail - flat edge or knife edge. Solid surface material is 0.5" thick with built up edge profile over a particle board or plywood subtop depending on overall top size. Models ending in **(SF)** indicate solid surface with flat edge; models ending in **(SK)** indicate solid surface with knife edge.
- Please see model # for pricing and availability of various material and edge options.
- Refer to page 344 or [globalfurnituregroup.com](http://globalfurnituregroup.com) for available finish options.
- While not all sizes are available in all materials:
  - Worksurfaces of 96" or less in length are standard in one piece (1 carton).
  - Worksurfaces 120" to 144" in length are standard in two pieces (2 cartons).
  - Worksurfaces 96", 120" and 144" x 48" include support channels.

## BASES

- **Caution:** to meet BIFMA standards for performance and stability, appropriate base size must be specified with corresponding top sizes identified. **Top plates and base plates vary by base size and will only work with table shape sizes as referenced on the following pages.**
- Bases are constructed of a round or square solid steel metal plate for counter balance, covered with a finished steel shroud, affixed with four bolts to a cold rolled steel tube.
- GRB14H25 attaches to tops with a 6" x 6" steel plate, welded to a 1.5" diameter steel tube, bolted to a 0.5" thick solid steel counter balance. Not to be used on tops greater than 22" x 22" in size.
- GSB13H25 and GSOB13H25 attach to tops with a 6" x 6" steel plate, welded to a 1.5" diameter steel tube, bolted to a 0.5" thick solid steel counter balance. Not to be used on tops greater than 22" x 22" in size.
- GRB22H15, GRB22H21, GRB22H26, GRB22, GRB22H35, GRB22H41, GSB19H15, GSB19H21, GSB19H26, GSB19, GSB19H35 and GSB19H41 attach to tops with a 6" x 6" steel plate, welded to a 3" diameter steel tube, bolted to a 0.5" thick solid steel counter balance.
- Top plate and base plate of GRB22 and GSB19 models in all heights, have pass-through cut-outs to accommodate a single port simplex or dual USB module to deliver power or USB charging to the surface. This allows the module to be mounted directly above the base and to pass the unit's cord through the base column resulting in the cord and plug head exiting from the bottom of the base for plugging into a floor or wall mount power source.
- GRB28, GRB34, GSB23 and GSB28 attach to tops with an 11" x 11" steel plate, welded to a 4" diameter steel tube, bolted to a 0.375" thick solid steel counter balance.
- Bases are available PAINTED in "Sandtex" finish for extra durability. Also available in plated finishes (see page 344) at an upcharge and with an extended lead time. Please see model # for pricing.
- All bases come with six 0.5" height adjustable glides for leveling on uneven floors.
- Coffee table height bases with 14"H column and 0.375"H levelers.
- End table height bases with 20"H column and 0.375"H levelers.
- Lounge height bases with 25"H column and 0.375"H levelers.
- Seated height bases with 27"H column and 0.375"H levelers.
- Counter height bases with 34"H column and 0.375"H levelers.
- Bar height bases with 39.5"H column and 0.375"H levelers.
- Round bases available in 22", 28" and 34" dia.
- Square bases available in 18.5", 22.5" and 28.5".

## 1. SPECIFY MODEL NUMBER

## 2. SPECIFY FINISH

### Laminate finishes (thermally fused and high pressure laminate):

ACJ	Absolute Acajou	NGL	Noce Grigio
ASN	Asian Night	NEL	Noce Leggero
AWC	Avant Cherry	NML	Noce Medio
AWH	Avant Honey	QTM	Quarter Mahogany
BLK	Black	SOG	Storm Grey
BRC	Brushed Cobalt	TFW	Tiger Fruitwood
CMB	Clear Maple	TWL	Tiger Walnut
DES	Dark Espresso	WHE	Walnut Heights
DWT	Designer White	WGY	Willow Grey
HGT	Hayden Grey	WHC	White Chocolate
NBL	Noce Biondo	WCR	Winter Cherry

### Veneer finishes (applicable for models ending in **V** only):

AMW	Almond Cherry	MPW	Maple
ACW	Amber Cherry	MTW	Milestone
BTW	Biscotti	MCW	Mocha
CAW	Cocoa Walnut	NLW	Natural Walnut
CRW	Coral	OYW	Oyster Maple
DCW	Dark Cherry	RCW	Red Cherry
DWW	Dark Walnut	SHW	Sahara Maple
EWV	Empress Walnut	SMW	Sugar Maple
EVV	Evening Oak	ULW	Umber Walnut
HAW	Hazelnut	VNW	Vintage Cherry
JAW	Java	WLW	Walnut
LTW	Latte	WMW	White Maple
MHW	Mahogany on Walnut	WCW	Windsor Cherry

### Solid surface (applicable for models ending in **SF** or **SK** only):

<b>Grade 1</b>		<b>Grade 2</b>	
SWH	Designer White	SBT	Beige Tempest
		SBM	Black Onyx Mirage
		SFW	Frosty White Mirage
		SHS	Hot Stone
		SMG	Milk Glass Spectra
		SNM	Northern Melange

### Bases (paint finishes):

TBL	Black	TIN	Ink
TBZ	Buzz Blue	TKA	Kalua
TCC	Cactus	TLA	Latte
TCR	Carrot	TMO	Mocha
TIV	Cloud	TNE	Nevada
TDW	Designer White	TSN	Sand
TDJ	Dijon	TSR	Scarlet
TEG	Eggplant	TSH	Shadow
TFO	Fog	TOA	Toast
TFR	Frost	TTU	Tungsten

### Bases (plated finishes - upcharge applies):

ACO	Antique Copper	CHM	Chrome
BCH	Brushed Chrome	SBR	Satin Brass

## 3. SPECIFY EDGE PROFILE (where applicable)

- Thermally fused laminate and high pressure with flat edge tops:
  - Flat edge (FE) - default profile
  - 3" radiused corners (R3) - optional for square and rectangular tops, upcharge applies
- High pressure laminate tops (models ending in **LK**):
  - Knife edge only
  - 3" radiused corners available by quote request only
- Veneer tops (models ending in **V**):
  - Flat edge (FE) - default profile
  - Knife edge (KS) - optional
  - 3" radiused corners available by quote request only
- Solid surface tops (models ending is **SF**):
  - Flat edge (FE) - default profile
  - 3" radiused corners (R3) - optional for square and rectangular tops, upcharge applies
- Solid surface tops (models ending is **SK**):
  - Knife edge (KS) - default profile
  - Knife edge with 3" radiused corners (KR) - optional for square and rectangular tops, upcharge applies

## 4. SPECIFY EDGE FINISH

### Edge finish only applicable for thermally fused laminate and high pressure tops with flat edge (FE)

AAE	Absolute Acajou	LAB	Latte
ASE	Asian Night	NBL	Noce Biondo
ACE	Avant Cherry	NGL	Noce Grigio
AHE	Avant Honey	NEL	Noce Leggero
BLK	Black	NML	Noce Medio
BRC	Brushed Cobalt	QTM	Quarter Mahogany
BZB	Buzz Blue	SAR	Scarlet
CCT	Cactus	SHW	Shadow
CRO	Carrot	SOG	Storm Grey
CME	Clear Maple	TFE	Tiger Fruitwood
DEE	Dark Espresso	TWE	Tiger Walnut
DWE	Designer White	WHE	Walnut Heights
DJN	Dijon	CBE	White Chocolate
FOG	Fog	WGY	Willow Grey
HGT	Hayden Grey	WCE	Winter Cherry

5. SPECIFY OPTIONS

POWER BLOCKS AND CUT-OUTS LOCATIONS

- A power block delivers power/data to the table surface.
- Power block modules are ordered separately.
- Not all power block locations are available on all table sizes. Please refer to the top/base chart on the following pages for more information.
- To purchase a power block, you must specify the power block cut-out location when ordering the top and order the power block separately.
- Optional cut-out available in standard worksurface locations (left, center or right) for all table shapes.  
Example: Order as **E1, U1, A1, J1, K1**, etc. **Add \$91** for each cut-out.
- Cut-outs may be placed at non-standard locations. Please contact Customer Service.
- Select power block option from Productivity Solutions pages 492-495.

POWER BLOCK OPTIONS AND CUT-OUT LOCATIONS

(Power modules and blocks can be found in the Productivity Solutions section of the price list)

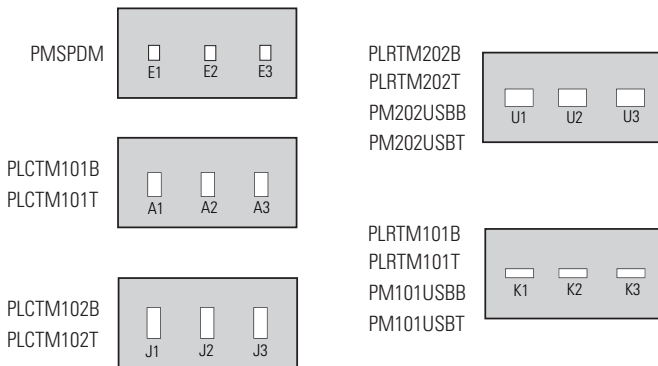

- Match power block desired with cut-out code and location from above grid.
- Example: If power block module # PLCTM101T is required in the center position, specify cut-out option A2 when specifying the top.

SINGLE PORT MODULES

- Single port module with one simplex or one dual USB charging port centered over the base, available for tops supported with single GRB22xx or GSB19xx base in any height
- Specify optional cut-out (**Q2**) to accommodate when specifying tops. **Add \$91** to list.
- Modules are listed on product pages with applicable tops and bases. Modules are ordered separately.

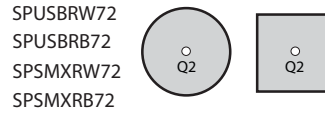

- For White colored modules, specify code ending in (**W72**); for Black colored modules, specify code ending in (**B72**).









SPECIFICATIONS



- Required and optional specifications marked with an \* on the pricelist pages with products are applicable to only those products which have the \* symbol beside the product name.







## TABLE NOTES - ESTIMATED CAPACITY

- Use the following to determine the size of a table and the number of chairs needed for a conference area.
- All estimates are based on an average chair width of 23" with a 4" clearance between chairs. Adjust accordingly for a different chair size.

Top Size	Round	NUMBER OF CHAIRS				Boat	Racetrack
		Square	Rectangular				
24 x 24	2	2	N/A	N/A	N/A	N/A	
24 x 30	N/A	N/A	2-3	N/A	N/A	N/A	
24 x 36	N/A	N/A	3-4	N/A	N/A	N/A	
30 x 30	3	4	N/A	N/A	N/A	N/A	
30 x 36	N/A	N/A	4	N/A	N/A	N/A	
30 x 42	N/A	N/A	4	N/A	N/A	N/A	
36 x 36	4	4	N/A	N/A	N/A	N/A	
36 x 42	N/A	N/A	4	N/A	N/A	N/A	
42 x 42	4	4	N/A	N/A	N/A	N/A	
48 x 48	4	4	N/A	N/A	N/A	N/A	
54 x 54	5	6	N/A	N/A	N/A	N/A	
60 x 60	5	6	N/A	N/A	N/A	N/A	
24 x 60	N/A	N/A	4-6	N/A	N/A	4-6	
24 x 66	N/A	N/A	4-6	N/A	N/A	4-6	
24 x 72	N/A	N/A	4-6	N/A	N/A	4-6	
24 x 84	N/A	N/A	4-6	N/A	N/A	4-6	
24 x 96	N/A	N/A	6-8	N/A	N/A	6-8	
30 x 60	N/A	N/A	4-6	4-6	N/A	4-6	
30 x 66	N/A	N/A	4-6	4-6	N/A	4-6	
30 x 72	N/A	N/A	4-6	4-6	N/A	4-6	
30 x 84	N/A	N/A	4-6	4-6	N/A	4-6	
30 x 96	N/A	N/A	6-8	6-8	N/A	6-8	
36 x 60	N/A	N/A	4-6	4-6	N/A	4-6	
36 x 66	N/A	N/A	4-6	4-6	N/A	4-6	
36 x 72	N/A	N/A	4-6	4-6	N/A	4-6	
36 x 84	N/A	N/A	4-6	4-6	N/A	4-6	
36 x 96	N/A	N/A	6-8	6-8	N/A	6-8	
48 x 84	N/A	N/A	6-8	6-8	N/A	6-8	
48 x 96	N/A	N/A	6-8	6-8	N/A	6-8	
48 x 120	N/A	N/A	8-10	8-10	N/A	8-10	
48 x 144	N/A	N/A	10-12	10-12	N/A	10-12	

APPLICABLE BASE OPTIONS FOR CORRESPONDING TOP										POWER MGMT OPTIONS		
Table Shape/Size	Top #	Lounge Height 27"H		Seated Height 29"H		Counter Height 36"H		Bar Height 41.5"H		Base Qty.	# top pieces	Grommet and Power Block Cut-outs Available
		Round base 22" 	Square base 18.5" 	Round base 22", 28", 34" 	Square base 18.5", 22.5", 28.5" 	Round base 22" 	Square base 18.5" 	Round base 22" 	Square base 18.5" 			
<b>Round</b> ○ <b>Nominal base plate dimension indicated by 4th and 5th characters in base model numbers</b>												
24" diameter top	GRBTP24_	GRB22H26	GSB19H26	GRB22	GSB19	GRB22H35	GSB19H35	GRB22H41	GSB19H41	1	1	Q2 only
30" diameter top	GRBTP30_	GRB22H26	GSB19H26	GRB22	GSB19	GRB22H35	GSB19H35	GRB22H41	GSB19H41	1	1	Q2 only
36" diameter top	GRBTP36_	GRB22H26	GSB19H26	GRB22	GSB19	GRB22H35	GSB19H35	GRB22H41	GSB19H41	1	1	Q2 only
42" diameter top	GRBTP42_	N/A	N/A	GRB28	GSB23	N/A	N/A	N/A	N/A	1	1	None
48" diameter top	GRBTP48_	N/A	N/A	GRB28	GSB23	N/A	N/A	N/A	N/A	1	1	None
54" diameter top	GRBTP54_	N/A	N/A	GRB34	GSB28	N/A	N/A	N/A	N/A	1	1	None
60" diameter top	GRBTP60_	N/A	N/A	GRB34	GSB28	N/A	N/A	N/A	N/A	1	1	None
<b>Square</b> □												
24" square top	GSBTP24_	GRB22H26	GSB19H26	GRB22	GSB19	GRB22H35	GSB19H35	GRB22H41	GSB19H41	1	1	Q2 only
30" square top	GSBTP30_	GRB22H26	GSB19H26	GRB22	GSB19	GRB22H35	GSB19H35	GRB22H41	GSB19H41	1	1	Q2 only
36" square top	GSBTP36_	GRB22H26	GSB19H26	GRB22	GSB19	GRB22H35	GSB19H35	GRB22H41	GSB19H41	1	1	Q2 only
42" square top	GSBTP42_	N/A	N/A	GRB28	GSB23	N/A	N/A	N/A	N/A	1	1	None
<b>Rectangular</b> ▭												
30x24 Rectangular	GSBTP2430_	GRB22H26	GSB19H26	GRB22	GSB19	GRB22H35	GSB19H35	GRB22H41	GSB19H41	1	1	Q2 only
36x24 Rectangular	GSBTP2436_	GRB22H26	GSB19H26	GRB22	GSB19	GRB22H35	GSB19H35	GRB22H41	GSB19H41	1	1	Q2 only
36x30 Rectangular	GSBTP3036_	GRB22H26	GSB19H26	GRB22	GSB19	GRB22H35	GSB19H35	GRB22H41	GSB19H41	1	1	Q2 only
42x30 Rectangular	GSBTP3042_	N/A	N/A	GRB28	GSB23	N/A	N/A	N/A	N/A	1	1	None
42x36 Rectangular	GSBTP3642_	N/A	N/A	GRB28	GSB23	N/A	N/A	N/A	N/A	1	1	None
60x24 Rectangular	GRT5STP_	GRB22H26	GSB19H26	N/A	N/A	GRB22H35	GSB19H35	GRB22H41	GSB19H41	2	1	Center: A2, E2, J2, K2, U2, FOG2
66x24 Rectangular	GRT5HSTP_	GRB22H26	GSB19H26	N/A	N/A	GRB22H35	GSB19H35	GRB22H41	GSB19H41	2	1	
72x24 Rectangular	GRT6STP_	GRB22H26	GSB19H26	N/A	N/A	GRB22H35	GSB19H35	GRB22H41	GSB19H41	2	1	
84x24 Rectangular	GRT7STP_	GRB22H26	GSB19H26	N/A	N/A	GRB22H35	GSB19H35	GRB22H41	GSB19H41	2	1	3 positions - Left/ Center/Right
96x24 Rectangular	GRT8STP_	GRB22H26	GSB19H26	N/A	N/A	GRB22H35	GSB19H35	GRB22H41	GSB19H41	2	1	
60x30 Rectangular	GRT5NTP_	GRB22H26	GSB19H26	GRB22	GSB19	GRB22H35	GSB19H35	GRB22H41	GSB19H41	2	1	
60x36 Rectangular	GRT5TP_	GRB22H26	GSB19H26	GRB22	GSB19	GRB22H35	GSB19H35	GRB22H41	GSB19H41	2	1	Center: E2, A2, U2, J2, K2, FOG2
66x30 Rectangular	GRT5NHTP_	GRB22H26	GSB19H26	GRB22	GSB19	GRB22H35	GSB19H35	GRB22H41	GSB19H41	2	1	
66x36 Rectangular	GRT5HTP_	GRB22H26	GSB19H26	GRB22	GSB19	GRB22H35	GSB19H35	GRB22H41	GSB19H41	2	1	
72x30 Rectangular	GRT6NTP_	GRB22H26	GSB19H26	GRB22	GSB19	GRB22H35	GSB19H35	GRB22H41	GSB19H41	2	1	3 positions - Left/ Center/Right: E1/2/3, A1/2/3, U1/2/3, J1/2/3, K1/2/3, FOG1/2/3
72x36 Rectangular	GRT6TP_	GRB22H26	GSB19H26	GRB22	GSB19	GRB22H35	GSB19H35	GRB22H41	GSB19H41	2	1	
84x30 Rectangular	GRT7NTP_	GRB22H26	GSB19H26	GRB22	GSB19	GRB22H35	GSB19H35	GRB22H41	GSB19H41	2	1	
84x36 Rectangular	GRT7TP_	GRB22H26	GSB19H26	GRB22	GSB19	GRB22H35	GSB19H35	GRB22H41	GSB19H41	2	1	3 positions - Left/ Center/Right: E1/2/3, A1/2/3, U1/2/3, J1/2/3, K1/2/3, FOG1/2/3
96x30 Rectangular	GRT8NTP_	GRB22H26	GSB19H26	GRB22	GSB19	GRB22H35	GSB19H35	GRB22H41	GSB19H41	2	1	
96x36 Rectangular	GRT8TP_	GRB22H26	GSB19H26	GRB22	GSB19	GRB22H35	GSB19H35	GRB22H41	GSB19H41	2	1	
96x42 Rectangular	GRT8MTP_	N/A	N/A	GRB28	GSB23	N/A	N/A	N/A	N/A	2	1	Both ends: E1, E3; A1, A3; U1, U3; J1, J3; K1, K3, FOG1, FOG3
96x48 Rectangular	GRT8WTP_	N/A	N/A	GRB28	GSB23	N/A	N/A	N/A	N/A	2	1	
120x48 Rectangular	GRT10WTP_	N/A	N/A	GRB28	GSB23	N/A	N/A	N/A	N/A	3	2	
144x48 Rectangular	GRT12WTP_	N/A	N/A	GRB28	GSB23	N/A	N/A	N/A	N/A	3	2	

APPLICABLE BASE OPTIONS FOR CORRESPONDING TOP										POWER MGMT OPTIONS		
Table Shape/Size	Top #	Lounge Height 27"H		Seated Height 29"H		Counter Height 36"H		Bar Height 41.5"H		Base Qty.	# top pieces	Grommet and Power Block Cut-outs Available
		Round base 22"	Square base 18.5"	Round base 22", 28", 34"	Square base 18.5", 22.5", 28.5"	Round base 22"	Square base 18.5"	Round base 22"	Square base 18.5"			
<b>Racetrack</b>  <b>Nominal base plate dimension indicated by 4th and 5th characters in base model numbers</b>												
60x24 Racetrack	GRC5STP_	GRB22H26	GSB19H26	N/A	N/A	GRB22H35	GSB19H35	GRB22H41	GSB19H41	2	1	Center: A2, E2, J2, K2 U2, FOG2
66x24 Racetrack	GRC5HSTP_	GRB22H26	GSB19H26	N/A	N/A	GRB22H35	GSB19H35	GRB22H41	GSB19H41	2	1	
72x24 Racetrack	GRC6STP_	GRB22H26	GSB19H26	N/A	N/A	GRB22H35	GSB19H35	GRB22H41	GSB19H41	2	1	
84x24 Racetrack	GRC7STP_	GRB22H26	GSB19H26	N/A	N/A	GRB22H35	GSB19H35	GRB22H41	GSB19H41	2	1	3 positions - Left/ Center/Right
96x24 Racetrack	GRC8STP_	GRB22H26	GSB19H26	N/A	N/A	GRB22H35	GSB19H35	GRB22H41	GSB19H41	2	1	
60x30 Racetrack	GRC5NTP_	GRB22H26	GSB19H26	GRB22	GSB19	GRB22H35	GSB19H35	GRB22H41	GSB19H41	2	1	Center: E2, A2, U2, J2, K2, FOG2
60x36 Racetrack	GRC5TP_	GRB22H26	GSB19H26	GRB22	GSB19	GRB22H35	GSB19H35	GRB22H41	GSB19H41	2	1	
66x30 Racetrack	GRC5NHTP_	GRB22H26	GSB19H26	GRB22	GSB19	GRB22H35	GSB19H35	GRB22H41	GSB19H41	2	1	
66x36 Racetrack	GRC5HTP_	GRB22H26	GSB19H26	GRB22	GSB19	GRB22H35	GSB19H35	GRB22H41	GSB19H41	2	1	
72x30 Racetrack	GRC6NTP_	GRB22H26	GSB19H26	GRB22	GSB19	GRB22H35	GSB19H35	GRB22H41	GSB19H41	2	1	
72x36 Racetrack	GRC6TP_	GRB22H26	GSB19H26	GRB22	GSB19	GRB22H35	GSB19H35	GRB22H41	GSB19H41	2	1	3 positions - Left/ Center/Right: E1/2/3; A1/2/3; U1/2/3, J1/2/3, K1/2/3, FOG1/2/3
84x30 Racetrack	GRC7NTP_	GRB22H26	GSB19H26	GRB22	GSB19	GRB22H35	GSB19H35	GRB22H41	GSB19H41	2	1	
84x36 Racetrack	GRC7TP_	GRB22H26	GSB19H26	GRB22	GSB19	GRB22H35	GSB19H35	GRB22H41	GSB19H41	2	1	
96x30 Racetrack	GRC8NTP_	GRB22H26	GSB19H26	GRB22	GSB19	GRB22H35	GSB19H35	GRB22H41	GSB19H41	2	1	
96x36 Racetrack	GRC8TP_	GRB22H26	GSB19H26	GRB22	GSB19	GRB22H35	GSB19H35	GRB22H41	GSB19H41	2	1	
96x42 Racetrack	GRC8MTP_	N/A	N/A	GRB28	GSB23	N/A	N/A	N/A	N/A	2	1	Both ends: E1, E3; A1, A3; U1, U3; J1, J3; K1, K3, FOG1, FOG3
96x48 Racetrack	GRC8WTP_	N/A	N/A	GRB28	GSB23	N/A	N/A	N/A	N/A	2	1	
120x48 Racetrack	GRC10WTP_	N/A	N/A	GRB28	GSB23	N/A	N/A	N/A	N/A	3	2	
144x48 Racetrack	GRC12WTP_	N/A	N/A	GRB28	GSB23	N/A	N/A	N/A	N/A	3	2	
<b>Boat Shape</b> 												
60x30 Boat shape	GBT5NTP_	GRB22H26	GSB19H26	GRB22	GSB19	GRB22H35	GSB19H35	GRB22H41	GSB19H41	2	1	Center: E2, A2, U2, J2, K2, FOG2
60x36 Boat shape	GBT5TP_	GRB22H26	GSB19H26	GRB22	GSB19	GRB22H35	GSB19H35	GRB22H41	GSB19H41	2	1	
66x30 Boat shape	GBT5NHTP_	GRB22H26	GSB19H26	GRB22	GSB19	GRB22H35	GSB19H35	GRB22H41	GSB19H41	2	1	
66x36 Boat shape	GBT5HTP_	GRB22H26	GSB19H26	GRB22	GSB19	GRB22H35	GSB19H35	GRB22H41	GSB19H41	2	1	
72x30 Boat shape	GBT6NTP_	GRB22H26	GSB19H26	GRB22	GSB19	GRB22H35	GSB19H35	GRB22H41	GSB19H41	2	1	
72x36 Boat shape	GBT6TP_	GRB22H26	GSB19H26	GRB22	GSB19	GRB22H35	GSB19H35	GRB22H41	GSB19H41	2	1	3 positions - Left/ Center/Right: E1/2/3; A1/2/3; U1/2/3, J1/2/3, K1/2/3, FOG1/2/3
84x30 Boat shape	GBT7NTP_	GRB22H26	GSB19H26	GRB22	GSB19	GRB22H35	GSB19H35	GRB22H41	GSB19H41	2	1	
84x36 Boat shape	GBT7TP_	GRB22H26	GSB19H26	GRB22	GSB19	GRB22H35	GSB19H35	GRB22H41	GSB19H41	2	1	
96x30 Boat shape	GBT8NTP_	GRB22H26	GSB19H26	GRB22	GSB19	GRB22H35	GSB19H35	GRB22H41	GSB19H41	2	1	
96x36 Boat shape	GBT8TP_	GRB22H26	GSB19H26	GRB22	GSB19	GRB22H35	GSB19H35	GRB22H41	GSB19H41	2	1	
96x42 Boat shape	GBT8MTP_	N/A	N/A	GRB28	GSB23	N/A	N/A	N/A	N/A	2	1	Both ends: E1, E3; A1, A3; U1, U3; J1, J3; K1, K3, FOG1, FOG 3
96x48 Boat shape	GBT8WTP_	N/A	N/A	GRB28	GSB23	N/A	N/A	N/A	N/A	2	1	
120x48 Boat shape	GBT10WTP_	N/A	N/A	GRB28	GSB23	N/A	N/A	N/A	N/A	3	2	
144x48 Boat shape	GBT12WTP_	N/A	N/A	GRB28	GSB23	N/A	N/A	N/A	N/A	3	2	

APPLICABLE BASE OPTIONS FOR CORRESPONDING TOP						POWER MGMT OPTIONS		
Table Shape/Size	Top #	Centered Column 25.5"H		Offset Column 25.5"H		Base Qty.	# Top pieces	Power Block Cut-outs Available
		Round base 14" 	Square base 12.5" 	Round base N/A	Square base 12.5" 			
<b>Round Laptop</b> ○ <i>*Nominal base plate dimension indicated by 4th and 5th characters in base model numbers.</i>								
16" dia	GRBTP16_	GRB14H25	GSB13H25	N/A	N/A	1	1	None
20" dia	GRBTP20_	GRB14H25	GSB13H25	N/A	N/A	1	1	None
22" dia	GRBTP22_	GRB14H25	GSB13H25	N/A	N/A	1	1	None
16" dia	GRBOTP16_	N/A	N/A	N/A	GSOB13H25	1	1	None
20" dia	GRBOTP20_	N/A	N/A	N/A	GSOB13H25	1	1	None
22" dia	GRBOTP22_	N/A	N/A	N/A	GSOB13H25	1	1	None
<b>Square Laptop</b> □								
16"x16"	GSBTP16_	GRB14H25	GSB13H25	N/A	N/A	1	1	None
20"x20"	GSBTP20_	GRB14H25	GSB13H25	N/A	N/A	1	1	None
22"x22"	GSBTP22_	GRB14H25	GSB13H25	N/A	N/A	1	1	None
16"x16"	GSBOTP16_	N/A	N/A	N/A	GSOB13H25	1	1	None
20"x20"	GSBOTP20_	N/A	N/A	N/A	GSOB13H25	1	1	None
22"x22"	GSBOTP22_	N/A	N/A	N/A	GSOB13H25	1	1	None
<b>Rectangular Laptop</b> □								
16"x20"	GSBTP1620_	GRB14H25	GSB13H25	N/A	N/A	1	1	None
16"x22"	GSBTP1622_	GRB14H25	GSB13H25	N/A	N/A	1	1	None
16"x20"	GSBOT1620_	N/A	N/A	N/A	GSOB13H25	1	1	None
16"x22"	GSBOT1622_	N/A	N/A	N/A	GSOB13H25	1	1	None
APPLICABLE BASE OPTIONS FOR CORRESPONDING TOP						POWER MGMT OPTIONS		
Table Shape	Top #	Coffee Table 16"H		End Table 22"H		Base Qty.	# top pieces	Power Block Cut-outs Available
		Round base 22" 	Square base 18.5" 	Round base 22" 	Square base 18.5" 			
<b>Round Coffee/End Tables</b> ○ <i>*Nominal base plate dimension indicated by 4th and 5th characters in base model numbers.</i>								
24" dia	GRBTP24_	GRB22H15	GSB19H15	GRB22H21	GSB19H21	1	1	Q2 only
30" dia	GRBTP30_	GRB22H15	GSB19H15	GRB22H21	GSB19H21	1	1	Q2 only
36" dia	GRBTP36_	GRB22H15	GSB19H15	GRB22H21	GSB19H21	1	1	Q2 only
<b>Square Coffee/End Tables</b> □								
24" square	GSBTP24_	GRB22H15	GSB19H15	GRB22H21	GSB19H21	1	1	Q2 only
30" square	GSBTP30_	GRB22H15	GSB19H15	GRB22H21	GSB19H21	1	1	Q2 only
36" square	GSBTP36_	GRB22H15	GSB19H15	GRB22H21	GSB19H21	1	1	Q2 only



## ROUND LAPTOP TABLES FOR CENTER BASE

MODEL # DIMENSIONS WT/LB. CUBIC FT. LIST PRICE HP ADD GRADE 2 R3 ADD KS ADD

W x D x H

### Thermally fused laminate, flat edge <sup>(1)</sup>

GRBTP16	16 x - x 1	6	0.3	\$188	\$80	N/A	N/A	N/A
GRBTP20	20 x - x 1	9	0.5	\$206	\$89	N/A	N/A	N/A
GRBTP22	22 x - x 1	9	0.5	\$206	\$89	N/A	N/A	N/A

### High pressure laminate, knife edge

GRBTP16LK	16 x - x 1.19	7.5	1	\$537	N/A	N/A	N/A	N/A
GRBTP20LK	20 x - x 1.19	11	1.5	\$608	N/A	N/A	N/A	N/A
GRBTP22LK	22 x - x 1.19	11	2	\$660	N/A	N/A	N/A	N/A

### Veneer <sup>(2)</sup>

GRBTP16V	16 x - x 1.19	7.5	1	\$809	N/A	N/A	N/A	\$77
GRBTP20V	20 x - x 1.19	11	1.5	\$875	N/A	N/A	N/A	\$77
GRBTP22V	22 x - x 1.19	11	2	\$942	N/A	N/A	N/A	\$77

### Solid surface, flat edge <sup>(3)</sup>

GRBTP16SF	16 x - x 1.25	11	0.6	\$1689	N/A	\$88	N/A	N/A
GRBTP20SF	20 x - x 1.25	16	1	\$1982	N/A	\$118	N/A	N/A
GRBTP22SF	22 x - x 1.25	20	1	\$2077	N/A	\$171	N/A	N/A

### Solid surface, knife edge <sup>(3)</sup>

GRBTP16SK	16 x - x 1.25	11	0.6	\$1789	N/A	\$100	N/A	N/A
GRBTP20SK	20 x - x 1.25	16	1	\$2088	N/A	\$123	N/A	N/A
GRBTP22SK	22 x - x 1.25	20	1	\$2188	N/A	\$176	N/A	N/A



Round Tops, for Centered Base

Only applicable bases to use with above tops: GRB14H25 round base or GSB13H25 square base with centered column.

Tops feature metal inserts for ease of assembly to base. One base required.

## SQUARE LAPTOP TABLES FOR CENTER BASE

### Thermally fused laminate, flat edge <sup>(1)(4)</sup>

GSBTP16	16 x 16 x 1	7	0.3	\$188	\$80	N/A	\$18.80	N/A
GSBTP20	20 x 20 x 1	11	0.5	\$206	\$89	N/A	\$20.60	N/A
GSBTP22	22 x 22 x 1	13	0.5	\$206	\$89	N/A	\$20.60	N/A

### High pressure laminate, knife edge

GSBTP16LK	16 x 16 x 1.19	8.5	1	\$359	N/A	N/A	N/A	N/A
GSBTP20LK	20 x 20 x 1.19	13	1.5	\$450	N/A	N/A	N/A	N/A
GSBTP22LK	22 x 22 x 1.19	16	2	\$491	N/A	N/A	N/A	N/A

### Veneer <sup>(2)</sup>

GSBTP16V	16 x 16 x 1.19	8.5	1	\$461	N/A	N/A	N/A	\$72
GSBTP20V	20 x 20 x 1.19	13	1.5	\$578	N/A	N/A	N/A	\$87
GSBTP22V	22 x 22 x 1.19	16	2	\$635	N/A	N/A	N/A	\$97

### Solid surface, flat edge <sup>(3)(4)</sup>

GSBTP16SF	16 x 16 x 1.25	14	0.6	\$1447	N/A	\$83	\$206	N/A
GSBTP20SF	20 x 20 x 1.25	21	1	\$1736	N/A	\$123	\$206	N/A
GSBTP22SF	22 x 22 x 1.25	26	1	\$1829	N/A	\$147	\$206	N/A

### Solid surface, knife edge <sup>(3)(4)</sup>

GSBTP16SK	16 x 16 x 1.25	14	0.6	\$1789	N/A	\$100	\$206	N/A
GSBTP20SK	20 x 20 x 1.25	21	1	\$2088	N/A	\$130	\$206	N/A
GSBTP22SK	22 x 22 x 1.25	26	1	\$2188	N/A	\$176	\$206	N/A

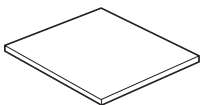

Square Tops, for Centered Base

Only applicable bases to use with above tops: GRB14H25 round base or GSB13H25 square base with centered column.

Tops feature metal inserts for ease of assembly to base. One base required.

#### Required specifications

Top finish  
Edge finish <sup>(1)</sup>

#### Optional specifications

HP laminate <sup>(1)</sup>  
Knife edge <sup>(2)</sup>  
Grade 2 solid surface <sup>(3)</sup>  
3" radiused corners <sup>(4)</sup>

#### Applicable bases

GRB14H25 - round  
GSB13H25 - square

**RECTANGULAR LAPTOP TABLES FOR CENTER BASE**

MODEL #	DIMENSIONS	WT/LB.	CUBIC FT.	LIST PRICE	HP ADD	GRADE 2	R3 ADD	KS ADD
<b>W x D x H</b>								
<b>Thermally fused laminate, flat edge <sup>(1)(4)</sup></b>								
GSBTP1620	16 x 20 x 1	9	0.4	<b>\$206</b>	<b>\$89</b>	N/A	<b>\$20.60</b>	N/A
GSBTP1622	16 x 22 x 1	11	0.5	<b>\$206</b>	<b>\$89</b>	N/A	<b>\$20.60</b>	N/A
<b>High pressure laminate, knife edge</b>								
GSBTP1620LK	20 x 16 x 1.19	11	1	<b>\$461</b>	N/A	N/A	N/A	N/A
GSBTP1622LK	22 x 16 x 1.19	13	1.5	<b>\$506</b>	N/A	N/A	N/A	N/A
<b>Veneer <sup>(2)</sup></b>								
GSBTP1620V	20 x 16 x 1.19	11	1	<b>\$568</b>	N/A	N/A	N/A	<b>\$87</b>
GSBTP1622V	22 x 16 x 1.19	13	1.5	<b>\$624</b>	N/A	N/A	N/A	<b>\$92</b>
<b>Solid surface, flat edge <sup>(3)(4)</sup></b>								
GSBTP1620SF	16 x 20 x 1.25	17	0.8	<b>\$1606</b>	N/A	<b>\$100</b>	<b>\$206</b>	N/A
GSBTP1622SF	16 x 22 x 1.25	19	0.8	<b>\$1629</b>	N/A	<b>\$106</b>	<b>\$206</b>	N/A
<b>Solid surface, knife edge <sup>(3)(4)</sup></b>								
GSBTP1620SK	16 x 20 x 1.25	17	0.8	<b>\$1929</b>	N/A	<b>\$123</b>	<b>\$206</b>	N/A
GSBTP1622SK	16 x 22 x 1.25	19	0.8	<b>\$1965</b>	N/A	<b>\$141</b>	<b>\$206</b>	N/A

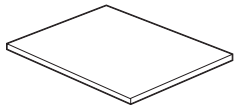

Rectangular Tops, for Centered Base

**Only applicable bases to use with above tops: GRB14H25 round base or GSB13H25 square base with centered column.**  
Tops feature metal inserts for ease of assembly to base. One base required.

**ROUND LAPTOP TABLES FOR OFFSET BASE**

<b>Thermally fused laminate, flat edge <sup>(1)</sup></b>								
GRBOTP16	16 x - x 1	6	0.3	<b>\$188</b>	<b>\$80</b>	N/A	N/A	N/A
GRBOTP20	20 x - x 1	9	0.5	<b>\$206</b>	<b>\$89</b>	N/A	N/A	N/A
GRBOTP22	22 x - x 1	11	0.7	<b>\$206</b>	<b>\$89</b>	N/A	N/A	N/A
<b>High pressure laminate, knife edge</b>								
GRBOTP16LK	16 x - x 1.19	8	1	<b>\$537</b>	N/A	N/A	N/A	N/A
GRBOTP20LK	20 x - x 1.19	13	1.5	<b>\$608</b>	N/A	N/A	N/A	N/A
GRBOTP22LK	22 x - x 1.19	16	2	<b>\$660</b>	N/A	N/A	N/A	N/A
<b>Veneer <sup>(2)</sup></b>								
GRBOTP16V	16 x - x 1.19	8	1	<b>\$809</b>	N/A	N/A	N/A	<b>\$77</b>
GRBOTP20V	20 x - x 1.19	13	1.5	<b>\$875</b>	N/A	N/A	N/A	<b>\$77</b>
GRBOTP22V	22 x - x 1.19	16	2	<b>\$942</b>	N/A	N/A	N/A	<b>\$77</b>
<b>Solid surface, flat edge <sup>(3)</sup></b>								
GRBOTP16SF	16 x - x 1.25	11	0.6	<b>\$1689</b>	N/A	<b>\$88</b>	N/A	N/A
GRBOTP20SF	20 x - x 1.25	16	1	<b>\$1982</b>	N/A	<b>\$118</b>	N/A	N/A
GRBOTP22SF	22 x - x 1.25	20	1	<b>\$2077</b>	N/A	<b>\$171</b>	N/A	N/A
<b>Solid surface, knife edge <sup>(3)</sup></b>								
GRBOTP16SK	16 x - x 1.25	11	0.6	<b>\$1789</b>	N/A	<b>\$100</b>	N/A	N/A
GRBOTP20SK	20 x - x 1.25	16	1	<b>\$2088</b>	N/A	<b>\$123</b>	N/A	N/A
GRBOTP22SK	22 x - x 1.25	20	1	<b>\$2188</b>	N/A	<b>\$176</b>	N/A	N/A



Round Tops, for Offset Base

**Only applicable bases to use with above tops: GSOB13H25 square base with OFFSET column.**  
Tops feature metal inserts for ease of assembly to base. One base required.

**Required specifications**

Top finish  
Edge finish <sup>(1)</sup>

**Optional specifications**

HP laminate <sup>(1)</sup>  
Knife edge <sup>(2)</sup>  
Grade 2 solid surface <sup>(3)</sup>  
3" radiused corners <sup>(4)</sup>

**Applicable bases**

GRB14H25 - round centered  
GSB13H25 - square centered  
GSOB13H25 - square offset

## SQUARE LAPTOP TABLES FOR OFFSET BASE

MODEL # DIMENSIONS WT/LB. CUBIC FT. LIST PRICE HP ADD GRADE 2 R3 ADD KS ADD

W x D x H

### Thermally fused laminate, flat edge <sup>(1)(4)</sup>

GSBOTP16	16 x 16 x 1	7	0.3	\$188	\$80	N/A	\$18.80	N/A
GSBOTP20	20 x 20 x 1	11	0.5	\$206	\$89	N/A	\$20.60	N/A
GSBOTP22	22 x 22 x 1	13	0.7	\$206	\$89	N/A	\$20.60	N/A

### High pressure laminate, knife edge

GSBOTP16LK	16 x 16 x 1.19	8.5	1	\$359	N/A	N/A	N/A	N/A
GSBOTP20LK	20 x 20 x 1.19	13	1.5	\$450	N/A	N/A	N/A	N/A
GSBOTP22LK	22 x 22 x 1.19	16	2	\$491	N/A	N/A	N/A	N/A

### Veneer <sup>(2)</sup>

GSBOTP16V	16 x 16 x 1.19	8.5	1	\$461	N/A	N/A	N/A	\$72
GSBOTP20V	20 x 20 x 1.19	13	1.5	\$578	N/A	N/A	N/A	\$87
GSBOTP22V	22 x 22 x 1.19	16	2	\$635	N/A	N/A	N/A	\$97

### Solid surface, flat edge <sup>(3)(4)</sup>

GSBOTP16SF	16 x 16 x 1.25	14	0.6	\$1447	N/A	\$83	\$206	N/A
GSBOTP20SF	20 x 20 x 1.25	21	1	\$1736	N/A	\$123	\$206	N/A
GSBOTP22SF	22 x 22 x 1.25	26	1	\$1829	N/A	\$147	\$206	N/A

### Solid surface, knife edge <sup>(3)(4)</sup>

GSBOTP16SK	16 x 16 x 1.25	14	0.6	\$1789	N/A	\$100	\$206	N/A
GSBOTP20SK	20 x 20 x 1.25	21	1	\$2088	N/A	\$130	\$206	N/A
GSBOTP22SK	22 x 22 x 1.25	26	1	\$2188	N/A	\$176	\$206	N/A

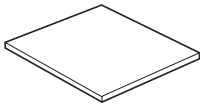

Square Tops, for Offset Base

Only applicable bases to use with above tops: GSOB13H25 square base with OFFSET column.

Tops feature metal inserts for ease of assembly to base. One base required.

## RECTANGULAR LAPTOP TABLES FOR OFFSET BASE

### Thermally fused laminate, flat edge <sup>(1)(4)</sup>

GSBOT1620	16 x 20 x 1	9	0.4	\$210	\$91	N/A	\$21	N/A
GSBOT1622	16 x 22 x 1	11	0.5	\$210	\$91	N/A	\$21	N/A

### High pressure laminate, knife edge

GSBOT1620LK	20 x 16 x 1.19	11	1.5	\$461	N/A	N/A	N/A	N/A
GSBOT1622LK	22 x 16 x 1.19	13	2	\$506	N/A	N/A	N/A	N/A

### Veneer <sup>(2)</sup>

GSBOT1620V	20 x 16 x 1.19	11	1.5	\$568	N/A	N/A	N/A	\$87
GSBOT1622V	22 x 16 x 1.19	13	2	\$624	N/A	N/A	N/A	\$92

### Solid surface, flat edge <sup>(3)(4)</sup>

GSBOT1620SF	16 x 20 x 1.25	17	0.8	\$1606	N/A	\$100	\$206	N/A
GSBOT1622SF	16 x 22 x 1.25	19	0.8	\$1629	N/A	\$106	\$206	N/A

### Solid surface, knife edge <sup>(3)(4)</sup>

GSBOT1620SK	16 x 20 x 1.25	17	0.8	\$1929	N/A	\$123	\$206	N/A
GSBOT1622SK	16 x 22 x 1.25	19	0.8	\$1965	N/A	\$141	\$206	N/A

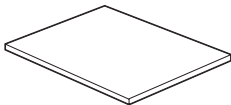

Rectangular Tops, for Offset Base

Only applicable bases to use with above tops: GSOB13H25 square base with OFFSET column.

Tops feature metal inserts for ease of assembly to base. One base required.

#### Required specifications

Top finish  
Edge finish <sup>(1)</sup>

#### Optional specifications

HP laminate <sup>(1)</sup>  
Knife edge <sup>(2)</sup>  
Grade 2 solid surface <sup>(3)</sup>  
3" radiused corners <sup>(4)</sup>

#### Applicable base

GSOB13H25 - square

LAPTOP TABLE BASES      MODEL #      DIMENSIONS      WT/LB.      CUBIC FT.      LIST PRICE      BCH / CHM      ACO / SBR

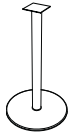

14" Round Centered Base

		W x D x H					
GRB14H25	14 x - x 24.5	27	3.26	\$633	\$87	\$172	

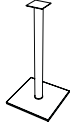

12.5" Square Centered Base

GSB13H25	12.5 x 12.5 x 24.5	26	3.26	\$653	\$87	\$186	
----------	--------------------	----	------	-------	------	-------	--



12.5" Square Offset Base

GSOB13H25	12.5 x 12.5 x 24.5	26	3.26	\$653	\$87	\$186	
-----------	--------------------	----	------	-------	------	-------	--

1.5" diameter column. Weighted base for balance includes top plate, 0.5" adjustable glides to level on uneven surfaces. Screws included with base for attaching to appropriate top(s). Available in paint and plated finishes as listed on page 344. Upcharge applies on plated finishes.

**Required specifications**  
Finish

**Optional specifications**  
Plated finish

ROUND TOPS, 24" - 36"W

MODEL # DIMENSIONS WT/LB. CUBIC FT. LIST PRICE HP ADD GRADE 2 R3 ADD KS ADD

W x D x H

**Thermally fused laminate, flat edge <sup>(1)</sup>**

GRBTP24	24 x - x 1	16	1	\$206	\$91	N/A	N/A	N/A
GRBTP30	30 x - x 1	25	1.5	\$239	\$108	N/A	N/A	N/A
GRBTP36	36 x - x 1	36	2	\$303	\$136	N/A	N/A	N/A

**High pressure laminate, knife edge**

GRBTP24LK	24 x - x 1.19	19	2	\$845	N/A	N/A	N/A	N/A
GRBTP30LK	30 x - x 1.19	30	3	\$1038	N/A	N/A	N/A	N/A
GRBTP36LK	36 x - x 1.19	43	4	\$1228	N/A	N/A	N/A	N/A

**Veneer <sup>(2)</sup>**

GRBTP24V	24 x - x 1.19	19	2	\$1008	N/A	N/A	N/A	\$77
GRBTP30V	30 x - x 1.19	30	3	\$1202	N/A	N/A	N/A	\$77
GRBTP36V	36 x - x 1.19	43	4	\$1407	N/A	N/A	N/A	\$77

**Solid surface, flat edge <sup>(3)</sup>**

GRBTP24SF	24 x - x 1.25	24	1.2	\$2130	N/A	\$171	N/A	N/A
GRBTP30SF	29.8 x - x 1.25	37	1.8	\$2323	N/A	\$235	N/A	N/A
GRBTP36SF	36 x - x 1.25	53	2.5	\$2970	N/A	\$353	N/A	N/A

**Solid surface, knife edge <sup>(3)</sup>**

GRBTP24SK	24 x - x 1.25	24	1.2	\$2188	N/A	\$183	N/A	N/A
GRBTP30SK	29.8 x - x 1.25	37	1.8	\$2411	N/A	\$253	N/A	N/A
GRBTP36SK	36 x - x 1.25	53	2.5	\$3147	N/A	\$376	N/A	N/A



Round Tops

**Applicable bases to use with above tops: GRB22Hxx round base or GSB19Hxx square base (15", 21", 26", 28" 35" or 40.5"H).** Tops feature metal inserts for ease of assembly to base. One base required. Optional cut-out Q2 for single port module SPUSBRW72/SPUSBRB72 or SPSMXRW72/SPSMXRB72.

SQUARE TOPS, 24" - 36"W

**Thermally fused laminate, flat edge <sup>(1)(4)</sup>**

GSBTP24	24 x 24 x 1	20	1	\$206	\$91	N/A	\$20.60	N/A
GSBTP30	30 x 30 x 1	30	1.5	\$239	\$108	N/A	\$23.90	N/A
GSBTP36	36 x 36 x 1	44	2	\$303	\$136	N/A	\$30.30	N/A

**High pressure laminate, knife edge**

GSBTP24LK	24 x 24 x 1.19	24	2	\$768	N/A	N/A	N/A	N/A
GSBTP30LK	30 x 30 x 1.19	36	3	\$834	N/A	N/A	N/A	N/A
GSBTP36LK	36 x 36 x 1.19	53	4	\$895	N/A	N/A	N/A	N/A

**Veneer <sup>(2)</sup>**

GSBTP24V	24 x 24 x 1.19	24	2	\$1038	N/A	N/A	N/A	\$72
GSBTP30V	30 x 30 x 1.19	36	3	\$1100	N/A	N/A	N/A	\$72
GSBTP36V	36 x 36 x 1.19	53	4	\$1166	N/A	N/A	N/A	\$72

**Solid surface, flat edge <sup>(3)(4)</sup>**

GSBTP24SF	24 x 24 x 1.25	30	1.2	\$1882	N/A	\$176	\$206	N/A
GSBTP30SF	29.8 x 29.8 x 1.25	47	1.8	\$2323	N/A	\$235	\$206	N/A
GSBTP36SF	36 x 36 x 1.25	68	2.5	\$3024	N/A	\$288	\$206	N/A

**Solid surface, knife edge <sup>(1)(4)</sup>**

GSBTP24SK	24 x 24 x 1.25	30	1.2	\$1942	N/A	\$188	\$206	N/A
GSBTP30SK	29.8 x 29.8 x 1.25	47	1.8	\$2912	N/A	\$265	\$206	N/A
GSBTP36SK	36 x 36 x 1.25	68	2.5	\$3606	N/A	\$329	\$206	N/A

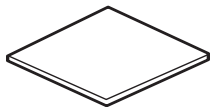

Square Tops

**Applicable bases to use with above tops: GRB22Hxx round base or GSB19Hxx square base (15", 21", 26", 28" 35" or 40.5"H).** Tops feature metal inserts for ease of assembly to base. One base required. Optional cut-out Q2 for single port module SPUSBRW72/SPUSBRB72 or SPSMXRW72/SPSMXRB72.

**Required specifications**

Top finish  
Edge finish <sup>(1)</sup>

**Optional specifications**

HP laminate <sup>(1)</sup> Knife edge <sup>(2)</sup>  
Grade 2 solid surface <sup>(3)</sup>  
3" radius corners <sup>(4)</sup>  
Q2 cut-out for single port module

**Applicable bases**

Round bases: GRB22H15, GRB22H21, GRB22H26, GRB22, GRB22H35, GRB22H41  
Square bases: GSB19H15, GSB19H21, GSB19H26, GSB19, GSB19H35, GSB19H41

**Accessories**

Single port modules

**RECTANGULAR TOPS, SMALL**      **MODEL #**      **DIMENSIONS**      **WT/LB.**      **CUBIC FT.**      **LIST PRICE**      **HP ADD**      **GRADE 2**      **R3 ADD**      **KS ADD**

W x D x H

**Thermally fused laminate, flat edge** <sup>(1)(4)</sup>

GSBTP2430	30 x 24 x 1	20	0.91	<b>\$235</b>	<b>\$103</b>	N/A	<b>\$23.50</b>	N/A
GSBTP2436	36 x 24 x 1	24	1.08	<b>\$271</b>	<b>\$117</b>	N/A	<b>\$27.10</b>	N/A
GSBTP3036	36 x 30 x 1	31	1.34	<b>\$297</b>	<b>\$128</b>	N/A	<b>\$29.70</b>	N/A

**High pressure laminate, knife edge**

GSBTP2430LK	30 x 24 x 1.19	24	2.5	<b>\$768</b>	N/A	N/A	N/A	N/A
GSBTP2436LK	36 x 24 x 1.19	29	3	<b>\$895</b>	N/A	N/A	N/A	N/A
GSBTP3036LK	36 x 30 x 1.19	37	3.5	<b>\$942</b>	N/A	N/A	N/A	N/A

**Veneer** <sup>(2)</sup>

GSBTP2430V	30 x 24 x 1.19	24	2.5	<b>\$1038</b>	N/A	N/A	N/A	<b>\$72</b>
GSBTP2436V	36 x 24 x 1.19	29	3	<b>\$1100</b>	N/A	N/A	N/A	<b>\$72</b>
GSBTP3036V	36 x 30 x 1.19	37	3.5	<b>\$1166</b>	N/A	N/A	N/A	<b>\$72</b>

**Solid surface, flat edge** <sup>(3)(4)</sup>

GSBTP2430SF	24 x 29.8 x 1.25	38	1.8	<b>\$2035</b>	N/A	<b>\$176</b>	<b>\$206</b>	N/A
GSBTP2436SF	24 x 36 x 1.25	45	2.1	<b>\$2295</b>	N/A	<b>\$223</b>	<b>\$206</b>	N/A
GSBTP3036SF	29.8 x 36 x 1.25	57	2.1	<b>\$2606</b>	N/A	<b>\$248</b>	<b>\$206</b>	N/A

**Solid surface, knife edge** <sup>(3)(4)</sup>

GSBTP2430SK	24 x 29.8 x 1.25	38	1.8	<b>\$2453</b>	N/A	<b>\$218</b>	<b>\$206</b>	N/A
GSBTP2436SK	24 x 36 x 1.25	45	2.1	<b>\$2664</b>	N/A	<b>\$271</b>	<b>\$206</b>	N/A
GSBTP3036SK	29.8 x 36 x 1.25	57	2.1	<b>\$3006</b>	N/A	<b>\$300</b>	<b>\$206</b>	N/A

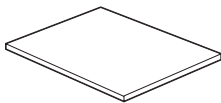

**Rectangular Tops**

**Applicable bases to use with above tops: GRB22Hxx round base or GSB19Hxx square base (15", 21", 26", 28" 35" or 40.5"H).** Tops feature metal inserts for ease of assembly to base. One base required. Optional cut-out Q2 for single port module SPUSBRW72/SPUSBRB72 or SPSMXRW72/SPSMXRB72.

**Required specifications**

Top finish  
Edge finish <sup>(1)</sup>

**Optional specifications**

HP laminate <sup>(1)</sup>      Knife edge <sup>(2)</sup>  
Grade 2 solid surface <sup>(3)</sup>  
3" radiused corners <sup>(4)</sup>  
Q2 cut-out for single port module

**Applicable bases**

Round bases: GRB22H15, GRB22H21, GRB22H26, GRB22, GRB22H35, GRB22H41  
Square bases: GSB19H15, GSB19H21, GSB19H26, GSB19, GSB19H35, GSB19H41

**Accessories**

Single port modules

# S SWAP™ TABLES

## BASES FOR TOPS 24" - 36"W

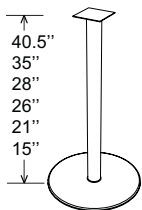

22" Dia Round Bases <sup>(1)</sup>

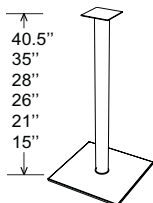

18.5" Square Bases <sup>(1)</sup>



Single Port Module w/dual port USB-A



Single Port Module w/one Simplex

MODEL #	DIMENSIONS	WT/LB.	CUBIC FT.	LIST PRICE	BCH / CHM	ACO / SBR
---------	------------	--------	-----------	------------	-----------	-----------

W x D x H

**BASE VALID FOR TOPS ON PAGES 354-355:**

GRB22H15	22 x - x 15	47.6	4.69	<b>\$793</b>	<b>\$147</b>	<b>\$211</b>
GRB22H21	22 x - x 21	48.6	6.45	<b>\$793</b>	<b>\$147</b>	<b>\$211</b>
GRB22H26	22 x - x 26	55	8.63	<b>\$793</b>	<b>\$147</b>	<b>\$221</b>
GRB22	22 x - x 28	55	9.33	<b>\$793</b>	<b>\$147</b>	<b>\$221</b>
GRB22H35	22 x - x 35	57.1	12	<b>\$831</b>	<b>\$164</b>	<b>\$253</b>
GRB22H41	22 x - x 40.5	58.3	14	<b>\$844</b>	<b>\$171</b>	<b>\$259</b>

**GRB22H15** - coffee table height  
**GRB22H21** - end table height

**GRB22H26** - lounge height  
**GRB22** - seated height

**GRB22H35** - counter height  
**GRB22H41** - bar height

GSB19H15	18.5 x 18.5 x 15	43.7	3.52	<b>\$857</b>	<b>\$136</b>	<b>\$204</b>
GSB19H21	18.5 x 18.5 x 21	44.8	4.84	<b>\$857</b>	<b>\$136</b>	<b>\$204</b>
GSB19H26	18.5 x 18.5 x 26	50	5.94	<b>\$857</b>	<b>\$136</b>	<b>\$212</b>
GSB19	18.5 x 18.5 x 28	50	6.06	<b>\$857</b>	<b>\$136</b>	<b>\$212</b>
GSB19H35	18.5 x 18.5 x 35	51.8	7.52	<b>\$906</b>	<b>\$151</b>	<b>\$262</b>
GSB19H41	18.5 x 18.5 x 40.5	53.2	8.77	<b>\$937</b>	<b>\$166</b>	<b>\$267</b>

**GSB19H15** - coffee table height  
**GSB19H21** - end table height

**GSB19H26** - lounge height  
**GSB19** - seated height

**GSB1935** - counter height  
**GSB19H41** - bar height

Base comes fully assembled and features 0.5" adjustable glides to level on uneven surfaces. Screws included with base for attaching to appropriate top(s). Base top plate and base plate include pass-through for single port power or USB module (sold separately). Available in paint and plated finishes as listed on page 344. Upcharge applies on plated finishes.

SPUSBRW72	2.25 x - x 2.75	1.2	1.18	<b>\$228</b>	N/A	N/A
SPUSBRB72	2.25 x - x 2.75	1.2	1.18	<b>\$228</b>	N/A	N/A

Single port module with dual USB-A charging ports. Specify top with Q2 cut-out to accommodate. Specify code ending in **(W72)** for White or **(B72)** for Black.

SPSMXRW72	2.25 x - x 2.75	1.75	1.18	<b>\$101</b>	N/A	N/A
SPSMXRB72	2.25 x - x 2.75	1.75	1.18	<b>\$101</b>	N/A	N/A

Single port module with one simplex. Specify top with Q2 cut-out to accommodate. For use with top sizes 24" to 36" with single GRB22Hxxx or GSB19Hxx base only. Specify code ending in **(W72)** for White or **(B72)** for Black.

**Required specifications**

Finish

**Optional specifications**

Plated finish <sup>(1)</sup>

ROUND TOPS, 42" - 48"W

MODEL # DIMENSIONS WT/LB. CUBIC FT. LIST PRICE HP ADD GRADE 2 R3 ADD KS ADD

W x D x H

**Thermally fused laminate, flat edge** <sup>(1)</sup>

GRBTP42	42 x - x 1	44	2.5	<b>\$424</b>	<b>\$174</b>	N/A	N/A	N/A
GRBTP48	48 x - x 1	56	3	<b>\$452</b>	<b>\$188</b>	N/A	N/A	N/A

**High pressure laminate, knife edge**

GRBTP42LK	42 x - x 1.19	53	5	<b>\$1432</b>	N/A	N/A	N/A	N/A
GRBTP48LK	48 x - x 1.19	67	6.5	<b>\$1637</b>	N/A	N/A	N/A	N/A

**Veneer** <sup>(2)</sup>

GRBTP42V	42 x - x 1.19	53	5	<b>\$1718</b>	N/A	N/A	N/A	<b>\$72</b>
GRBTP48V	48 x - x 1.19	67	6.5	<b>\$1965</b>	N/A	N/A	N/A	<b>\$81</b>

**Solid surface, flat edge** <sup>(3)</sup>

GRBTP42SF	42 x - x 1.25	73	3.4	<b>\$4029</b>	N/A	<b>\$453</b>	N/A	N/A
GRBTP48SF	48 x - x 1.25	95	4.3	<b>\$4588</b>	N/A	<b>\$576</b>	N/A	N/A

**Solid surface, knife edge** <sup>(3)</sup>

GRBTP42SK	42 x - x 1.25	73	3.4	<b>\$4242</b>	N/A	<b>\$506</b>	N/A	N/A
GRBTP48SK	48 x - x 1.25	95	4.3	<b>\$5117</b>	N/A	<b>\$641</b>	N/A	N/A



Round Tops

**Applicable bases to use with above tops: GRB28 round base or GSB23 square base (28"H).** Tops feature metal inserts for ease of assembly to base. One base required.

SQUARE/RECTANGULAR TOPS, 42"W

**Thermally fused laminate, flat edge** <sup>(1)(4)</sup>

GSBTP3042	42 x 30 x 1	36	1.55	<b>\$392</b>	<b>\$169</b>	N/A	<b>\$39.20</b>	N/A
GSBTP3642	42 x 36 x 1	43	1.86	<b>\$421</b>	<b>\$182</b>	N/A	<b>\$42.10</b>	N/A
GSBTP42	42 x 42 x 1	58	2.5	<b>\$424</b>	<b>\$174</b>	N/A	<b>\$42.40</b>	N/A

**High pressure laminate, knife edge**

GSBTP3042LK	42 x 30 x 1.19	43	4	<b>\$1013</b>	N/A	N/A	N/A	N/A
GSBTP3642LK	42 x 36 x 1.19	52	4.5	<b>\$1075</b>	N/A	N/A	N/A	N/A
GSBTP42LK	42 x 42 x 1.19	70	5	<b>\$1120</b>	N/A	N/A	N/A	N/A

**Veneer** <sup>(2)</sup>

GSBTP3042V	42 x 30 x 1.19	43	4	<b>\$1274</b>	N/A	N/A	N/A	<b>\$56</b>
GSBTP3642V	42 x 36 x 1.19	52	4.5	<b>\$1330</b>	N/A	N/A	N/A	<b>\$66</b>
GSBTP42V	42 x 42 x 1.19	70	5	<b>\$1560</b>	N/A	N/A	N/A	<b>\$72</b>

**Solid surface, flat edge** <sup>(3)(4)</sup>

GSBTP3042SF	29.8 x 42 x 1.25	66	2.9	<b>\$2736</b>	N/A	<b>\$300</b>	<b>\$206</b>	N/A
GSBTP3642SF	36 x 42 x 1.25	79	2.9	<b>\$3511</b>	N/A	<b>\$400</b>	<b>\$206</b>	N/A
GSBTP42SF	42 x 42 x 1.25	92	3.4	<b>\$3659</b>	N/A	<b>\$436</b>	<b>\$206</b>	N/A

**Solid surface, knife edge** <sup>(3)(4)</sup>

GSBTP3042SK	29.8 x 42 x 1.25	66	2.9	<b>\$3205</b>	N/A	<b>\$353</b>	<b>\$206</b>	N/A
GSBTP3642SK	36 x 42 x 1.25	79	2.9	<b>\$4052</b>	N/A	<b>\$476</b>	<b>\$206</b>	N/A
GSBTP42SK	42 x 42 x 1.25	92	3.4	<b>\$4242</b>	N/A	<b>\$529</b>	<b>\$206</b>	N/A

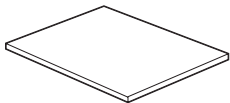

Rectangular Tops

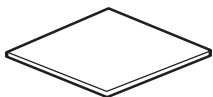

Square Tops

**Applicable bases to use with above tops: GRB28 round base or GSB23 square base (28"H).** Tops feature metal inserts for ease of assembly to base. One base required.

**Required specifications**

Top finish  
Edge finish <sup>(1)</sup>

**Optional specifications**

HP laminate <sup>(1)</sup>  
Knife edge <sup>(2)</sup>  
Grade 2 solid surface <sup>(3)</sup>  
3" radiused corners <sup>(4)</sup>

**Applicable bases**

GRB28 - round  
GSB23 - square



# S SWAP™ TABLES

BASES FOR TOPS 42" - 48"W

MODEL #

DIMENSIONS

WT/LB.

CUBIC FT.

LIST PRICE

BCH / CHM ACO / SBR

W x D x H

**BASES VALID FOR TOPS ON PAGE 357:**

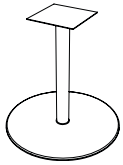

**28" Dia Round Base**

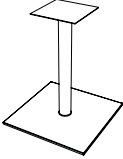

**23" Square Base**

GRB28	28 x - x 28	100	15.63	<b>\$1250</b>	<b>\$147</b>	<b>\$372</b>
seated height						

GSB23	22.5 x 22.5 x 28	82	9.33	<b>\$1146</b>	<b>\$136</b>	<b>\$235</b>
seated height						

Base comes fully assembled and features 0.5" adjustable glides to level on uneven surfaces. Screws included with base for attaching to appropriate top(s). Available in paint and plated finishes as listed on page 344. Upcharge applies on plated finishes.

**Required Specifications**  
Finish

**Optional Specifications**  
Plated finish

**ROUND TOPS, 54" - 60"W**      **MODEL #**      **DIMENSIONS**      **WT/LB.**      **CUBIC FT.**      **LIST PRICE**      **HP ADD**      **GRADE 2**      **R3 ADD**      **KS ADD**

W x D x H

**Thermally fused laminate, flat edge <sup>(1)</sup>**

GRBTP54	54 x - x 1	73	4.5	<b>\$603</b>	<b>\$271</b>	N/A	N/A	N/A
GRBTP60	60 x - x 1	92	5	<b>\$627</b>	<b>\$282</b>	N/A	N/A	N/A

**High pressure laminate, knife edge**

GRBTP54LK	54 x - x 1.19	88	8	<b>\$1847</b>	N/A	N/A	N/A	N/A
GRBTP60LK	60 x - x 1.19	110	10	<b>\$2276</b>	N/A	N/A	N/A	N/A

**Veneer <sup>(2)</sup>**

GRBTP54V	54 x - x 1.19	88	8	<b>\$2507</b>	N/A	N/A	N/A	<b>\$97</b>
GRBTP60V	60 x - x 1.19	110	10	<b>\$3094</b>	N/A	N/A	N/A	<b>\$102</b>

**Solid surface, flat edge <sup>(3)</sup>**

GRBTP54SF	54 x - x 1.25	120	5.4	<b>\$4971</b>	N/A	<b>\$706</b>	N/A	N/A
GRBTP60SF	60 x - x 1.25	148	6.7	<b>\$6530</b>	N/A	<b>\$882</b>	N/A	N/A

**Solid surface, knife edge <sup>(3)</sup>**

GRBTP54SK	54 x - x 1.25	120	5.4	<b>\$5876</b>	N/A	<b>\$888</b>	N/A	N/A
GRBTP60SK	60 x - x 1.25	148	6.7	<b>\$7189</b>	N/A	<b>\$1077</b>	N/A	N/A



Round Tops

**Applicable bases to use with above tops: GRB34 round base or GSB28 square base (28"H).** Tops feature metal inserts for ease of assembly to base. One base required.

**BASES FOR TOPS 54" - 60"W**      **MODEL #**      **DIMENSIONS**      **WT/LB.**      **CUBIC FT.**      **LIST PRICE**      **BCH / CHM**      **ACO / SBR**

W x D x H

**BASES VALID FOR TOPS ABOVE:**

Order the quantity of bases as indicated by each top size.

GRB34	34 x - x 28	135	20.56	<b>\$1538</b>	<b>\$147</b>	<b>\$449</b>
-------	-------------	-----	-------	---------------	--------------	--------------

seated height

GSB28	28.5 x 28.5 x 28	125	15.63	<b>\$1432</b>	<b>\$136</b>	<b>\$242</b>
-------	------------------	-----	-------	---------------	--------------	--------------

seated height

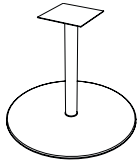

34" Dia Round Base

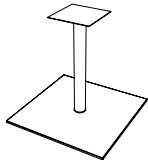

28" Square Base

Base comes fully assembled and features 0.5" adjustable glides to level on uneven surfaces. Screws included with base for attaching to appropriate top(s). Available in paint and plated finishes as listed on page 344. Upcharge applies on plated finishes.

**Required specifications**

Top finish  
Edge finish <sup>(1)</sup>  
Base finish

**Optional specifications**

HP laminate <sup>(1)</sup>  
Knife edge <sup>(2)</sup>  
Grade 2 solid surface <sup>(3)</sup>  
Base plated finish

**Applicable bases**

GRB34 - round  
GSB28 - square

RECTANGULAR LOUNGE TOPS, 24" D

MODEL # DIMENSIONS WT/LB. CUBIC FT. LIST PRICE HP ADD GRADE 2 R3 ADD KS ADD

W x D x H

**Thermally fused laminate, flat edge** <sup>(1)(4)</sup>

GRT5STP	60 x 24 x 1	41	1.79	<b>\$406</b>	<b>\$173</b>	N/A	<b>\$40.60</b>	N/A
GRT5HSTP	66 x 24 x 1	46	1.97	<b>\$474</b>	<b>\$173</b>	N/A	<b>\$47.40</b>	N/A
GRT6STP	72 x 24 x 1	49	2.14	<b>\$494</b>	<b>\$184</b>	N/A	<b>\$49.40</b>	N/A
GRT7STP	84 x 24 x 1	57	2.49	<b>\$573</b>	<b>\$219</b>	N/A	<b>\$49.40</b>	N/A
GRT8STP	96 x 24 x 1	66	2.84	<b>\$615</b>	<b>\$240</b>	N/A	<b>\$61.50</b>	N/A

**High pressure laminate, knife edge**

GRT5STPLK	60 x 24 x 1.19	49	4	<b>\$1100</b>	N/A	N/A	N/A	N/A
GRT5HSTPLK	66 x 24 x 1.19	55	4.5	<b>\$1166</b>	N/A	N/A	N/A	N/A
GRT6STPLK	72 x 24 x 1.19	59	5	<b>\$1228</b>	N/A	N/A	N/A	N/A
GRT7STPLK	84 x 24 x 1.19	68	5.5	<b>\$1356</b>	N/A	N/A	N/A	N/A
GRT8STPLK	96 x 24 x 1.19	79	6.5	<b>\$1535</b>	N/A	N/A	N/A	N/A

**Veneer** <sup>(2)</sup>

GRT5STPV	60 x 24 x 1.19	49	4	<b>\$1356</b>	N/A	N/A	N/A	<b>\$66</b>
GRT5HSTPV	66 x 24 x 1.19	55	4.5	<b>\$1422</b>	N/A	N/A	N/A	<b>\$66</b>
GRT6STPV	72 x 24 x 1.19	59	5	<b>\$1550</b>	N/A	N/A	N/A	<b>\$66</b>
GRT7STPV	84 x 24 x 1.19	68	5.5	<b>\$1806</b>	N/A	N/A	N/A	<b>\$66</b>
GRT8STPV	96 x 24 x 1.19	79	6.5	<b>\$2061</b>	N/A	N/A	N/A	<b>\$66</b>

**Solid surface, flat edge** <sup>(3)(4)</sup>

GRT5STPSF	60 x 24 x 1.25	75	2.8	<b>\$3941</b>	N/A	<b>\$441</b>	<b>\$206</b>	N/A
GRT5HSTPSF	66 x 24 x 1.25	83	3.1	<b>\$4117</b>	N/A	<b>\$453</b>	<b>\$206</b>	N/A
GRT6STPSF	71.8 x 24 x 1.25	90	3.3	<b>\$4341</b>	N/A	<b>\$464</b>	<b>\$206</b>	N/A
GRT7STPSF	84 x 24 x 1.25	105	3.9	<b>\$4824</b>	N/A	<b>\$606</b>	<b>\$206</b>	N/A
GRT8STPSF	96 x 24 x 1.25	120	4.4	<b>\$5294</b>	N/A	<b>\$617</b>	<b>\$206</b>	N/A

**Solid surface, knife edge** <sup>(3)(4)</sup>

GRT5STPSK	60 x 24 x 1.25	75	2.8	<b>\$4441</b>	N/A	<b>\$471</b>	<b>\$206</b>	N/A
GRT5HSTPSK	66 x 24 x 1.25	83	3.1	<b>\$4618</b>	N/A	<b>\$494</b>	<b>\$206</b>	N/A
GRT6STPSK	71.8 x 24 x 1.25	90	3.3	<b>\$4841</b>	N/A	<b>\$518</b>	<b>\$206</b>	N/A
GRT7STPSK	84 x 24 x 1.25	105	3.9	<b>\$5518</b>	N/A	<b>\$671</b>	<b>\$206</b>	N/A
GRT8STPSK	96 x 24 x 1.25	120	4.4	<b>\$6006</b>	N/A	<b>\$694</b>	<b>\$206</b>	N/A

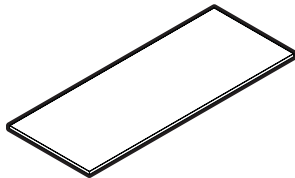

Rectangular Tops

**Applicable bases to use with above tops - two bases required: GRB22Hxx round bases or GSB19Hxx square bases (26", 35" or 40.5"H).** Tops feature metal inserts for ease of assembly to base. 24"D tops not recommended with 28"H bases.

**Required specifications**

Top finish  
Edge finish <sup>(1)</sup>

**Optional specifications**

HP laminate <sup>(1)</sup> Knife edge <sup>(2)</sup>  
Grade 2 solid surface <sup>(3)</sup>  
3" radiuses corners <sup>(4)</sup>  
Grommet position or power block cut-out

**Applicable bases (two required)**

Round bases:  
GRB22H26, GRB22H35, GRB22H41  
Square bases:  
GSB19H26, GSB19H35, GSB19H41

**Accessories**

Power block

RACETRACK LOUNGE TOPS, 24"D      MODEL #      DIMENSIONS      WT/LB.      CUBIC FT.      LIST PRICE      HP ADD      KS ADD

W x D x H

**Thermally fused laminate, flat edge <sup>(1)</sup>**

GRC5STP	60 x 24 x 1	41	1.79	<b>\$406</b>	<b>\$173</b>	N/A
GRC5HSTP	66 x 24 x 1	46	1.97	<b>\$474</b>	<b>\$173</b>	N/A
GRC6STP	72 x 24 x 1	49	2.14	<b>\$494</b>	<b>\$185</b>	N/A
GRC7STP	84 x 24 x 1	57	2.49	<b>\$573</b>	<b>\$222</b>	N/A
GRC8STP	96 x 24 x 1	66	2.84	<b>\$615</b>	<b>\$244</b>	N/A

**High pressure laminate, knife edge**

GRC5STPLK	60 x 24 x 1.19	49	4	<b>\$1356</b>	N/A	N/A
GRC5HSTPLK	66 x 24 x 1.19	55	4.5	<b>\$1484</b>	N/A	N/A
GRC6STPLK	72 x 24 x 1.19	59	5	<b>\$1612</b>	N/A	N/A
GRC7STPLK	84 x 24 x 1.19	68	5.5	<b>\$1739</b>	N/A	N/A
GRC8STPLK	96 x 24 x 1.19	79	6.5	<b>\$1868</b>	N/A	N/A

**Veneer <sup>(2)</sup>**

GRC5STPV	60 x 24 x 1.19	49	4	<b>\$1612</b>	N/A	<b>\$230</b>
GRC5HSTPV	66 x 24 x 1.19	55	4.5	<b>\$1766</b>	N/A	<b>\$256</b>
GRC6STPV	72 x 24 x 1.19	59	5	<b>\$1918</b>	N/A	<b>\$275</b>
GRC7STPV	84 x 24 x 1.19	68	5.5	<b>\$2225</b>	N/A	<b>\$275</b>
GRC8STPV	96 x 24 x 1.19	79	6.5	<b>\$2532</b>	N/A	<b>\$275</b>

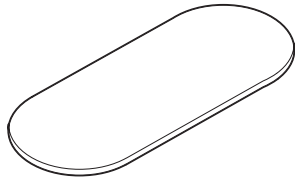

Racetrack Tops

**Applicable bases to use with above tops - two bases required: GRB22Hxx round bases or GSB19Hxx square bases (26", 35" or 40.5" H).** Tops feature metal inserts for ease of assembly to base. 24"D tops not recommended with 28"H bases.

**Required specifications**

Top finish  
Edge finish <sup>(1)</sup>

**Optional specifications**

HP laminate <sup>(1)</sup>  
Knife edge <sup>(2)</sup>  
Grommet position or power block cut-out

**Applicable bases (two required)**

Round bases:  
GRB22H26, GRB22H35, GRB22H41  
Square bases:  
GSB19H26, GSB19H35, GSB19H41

**Accessories**

Power block

RECTANGULAR TOPS, 60" - 96"W

MODEL # DIMENSIONS WT/LB. CUBIC FT. LIST PRICE HP ADD GRADE 2 R3 ADD KS ADD

W x D x H

**Thermally fused laminate, flat edge** <sup>(1)(4)</sup>

GRT5NTP	60 x 30 x 1	46	2.5	\$414	\$173	N/A	\$41.40	N/A
GRT5NHTP	66 x 30 x 1	56	2.44	\$443	\$184	N/A	\$44.30	N/A
GRT6NTP	72 x 30 x 1	62	3	\$449	\$194	N/A	\$44.90	N/A
GRT7NTP	84 x 30 x 1	72	7.5	\$536	\$231	N/A	\$53.60	N/A
GRT8NTP	96 x 30 x 1	80	8.5	\$592	\$241	N/A	\$59.20	N/A
GRT5TP	60 x 36 x 1	70	6.6	\$472	\$188	N/A	\$47.20	N/A
GRT5HTP	66 x 36 x 1	79	7.21	\$481	\$195	N/A	\$48.10	N/A
GRT6TP	72 x 36 x 1	72	8	\$481	\$195	N/A	\$48.10	N/A
GRT7TP	84 x 36 x 1	85	8.75	\$591	\$241	N/A	\$59.10	N/A
GRT8TP	96 x 36 x 1	94	9	\$648	\$275	N/A	\$64.80	N/A

**High pressure laminate, knife edge**

GRT5NTPLK	60 x 30 x 1.19	55	5	\$1218	N/A	N/A	N/A	N/A
GRT5NHTPLK	66 x 30 x 1.19	67	5.5	\$1330	N/A	N/A	N/A	N/A
GRT6NTPLK	72 x 30 x 1.19	74	6	\$1448	N/A	N/A	N/A	N/A
GRT7NTPLK	84 x 30 x 1.19	86	7	\$1668	N/A	N/A	N/A	N/A
GRT8NTPLK	96 x 30 x 1.19	96	8	\$1898	N/A	N/A	N/A	N/A
GRT5TPLK	60 x 36 x 1.19	84	6	\$1448	N/A	N/A	N/A	N/A
GRT5HTPLK	66 x 36 x 1.19	95	6.5	\$1581	N/A	N/A	N/A	N/A
GRT6TPLK	72 x 36 x 1.19	86	7	\$1719	N/A	N/A	N/A	N/A
GRT7TPLK	84 x 36 x 1.19	102	8	\$1990	N/A	N/A	N/A	N/A
GRT8TPLK	96 x 36 x 1.19	113	9	\$2266	N/A	N/A	N/A	N/A

**Veneer** <sup>(2)</sup>

GRT5NTPV	60 x 30 x 1.19	55	5	\$1663	N/A	N/A	N/A	\$77
GRT5NHTPV	66 x 30 x 1.19	67	5.5	\$1770	N/A	N/A	N/A	\$77
GRT6NTPV	72 x 30 x 1.19	74	6	\$1898	N/A	N/A	N/A	\$97
GRT7NTPV	84 x 30 x 1.19	86	7	\$2204	N/A	N/A	N/A	\$112
GRT8NTPV	96 x 30 x 1.19	96	8	\$2507	N/A	N/A	N/A	\$128
GRT5TPV	60 x 36 x 1.19	84	6	\$1898	N/A	N/A	N/A	\$97
GRT5HTPV	66 x 36 x 1.19	95	6.5	\$2072	N/A	N/A	N/A	\$128
GRT6TPV	72 x 36 x 1.19	86	7	\$2251	N/A	N/A	N/A	\$143
GRT7TPV	84 x 36 x 1.19	102	8	\$2614	N/A	N/A	N/A	\$164
GRT8TPV	96 x 36 x 1.19	113	9	\$2982	N/A	N/A	N/A	\$179

**Solid surface, flat edge** <sup>(3)(4)</sup>

GRT5NTPSF	60 x 29.8 x 1.25	94	3.4	\$4106	N/A	\$436	\$206	N/A
GRT5NHTPSF	66 x 29.8 x 1.25	104	3.8	\$4406	N/A	\$506	\$206	N/A
GRT6NTPSF	71.8 x 29.8 x 1.25	113	4.1	\$5029	N/A	\$706	\$206	N/A
GRT7NTPSF	84 x 29.8 x 1.25	132	4.8	\$5836	N/A	\$694	\$206	N/A
GRT8NTPSF	96 x 29.8 x 1.25	150	5.4	\$6423	N/A	\$900	\$206	N/A
GRT5TPSF	60 x 36 x 1.25	113	4.1	\$5465	N/A	\$647	\$206	N/A
GRT5HTPSF	66 x 36 x 1.25	124	4.5	\$5641	N/A	\$647	\$206	N/A
GRT6TPSF	71.8 x 36 x 1.25	135	4.9	\$6229	N/A	\$706	\$206	N/A
GRT7TPSF	84 x 36 x 1.25	158	5.7	\$6776	N/A	\$853	\$206	N/A
GRT8TPSF	96 x 36 x 1.25	180	6.5	\$7271	N/A	\$894	\$206	N/A

**Solid surface, knife edge** <sup>(3)(4)</sup>

GRT5NTPSK	60 x 29.8 x 1.25	94	3.4	\$4494	N/A	\$494	\$206	N/A
GRT5NHTPSK	66 x 29.8 x 1.25	104	3.8	\$4853	N/A	\$576	\$206	N/A
GRT6NTPSK	71.8 x 29.8 x 1.25	113	4.1	\$5470	N/A	\$789	\$206	N/A
GRT7NTPSK	84 x 29.8 x 1.25	132	4.8	\$6277	N/A	\$789	\$206	N/A
GRT8NTPSK	96 x 29.8 x 1.25	150	5.4	\$6971	N/A	\$1005	\$206	N/A
GRT5TPSK	60 x 36 x 1.25	113	4.1	\$6053	N/A	\$729	\$206	N/A
GRT5HTPSK	66 x 36 x 1.25	124	4.5	\$6206	N/A	\$741	\$206	N/A
GRT6TPSK	71.8 x 36 x 1.25	135	4.9	\$6876	N/A	\$812	\$206	N/A
GRT7TPSK	84 x 36 x 1.25	158	5.7	\$7429	N/A	\$970	\$206	N/A
GRT8TPSK	96 x 36 x 1.25	180	6.5	\$7911	N/A	\$1023	\$206	N/A

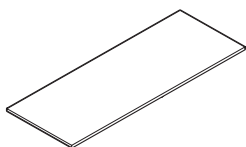

Rectangular Tops

**Applicable bases to use with above tops - two bases required: GRB22H26, GRB22, GRB22H35, GRB22H41 round bases or GSB19H26, GSB19, GSB19H35, GSB19H41 square bases.** Tops feature metal inserts for ease of assembly to base.

**Required specifications**

Top finish  
Edge finish <sup>(1)</sup>

**Optional specifications**

HP laminate <sup>(1)</sup> Knife edge <sup>(2)</sup>  
Grade 2 solid surface <sup>(3)</sup>  
3" radiused corners <sup>(4)</sup>  
Grommet position or power block cut-out

**Applicable bases (two required)**

Round bases:  
GRB22H26, GRB22, GRB22H35, GRB22H41  
Square bases:  
GSB19H26, GSB19, GSB19H35, GSB19H41

**Accessories**

Power block

RACETRACK TOPS, 60" - 96"W MODEL # DIMENSIONS WT/LB. CUBIC FT. LIST PRICE HP ADD KS ADD

W x D x H

**Thermally fused laminate, flat edge <sup>(1)</sup>**

GRC5NTP	60 x 30 x 1	46	2.5	\$422	\$178	N/A
GRC5NHTP	66 x 30 x 1	56	2.44	\$457	\$187	N/A
GRC6NTP	72 x 30 x 1	62	3	\$459	\$195	N/A
GRC7NTP	84 x 30 x 1	72	7.5	\$548	\$233	N/A
GRC8NTP	96 x 30 x 1	80	8.5	\$601	\$244	N/A
GRC5TP	60 x 36 x 1	70	6.6	\$483	\$195	N/A
GRC5HTP	66 x 36 x 1	79	7.21	\$488	\$199	N/A
GRC6TP	72 x 36 x 1	72	7.5	\$488	\$199	N/A
GRC7TP	84 x 36 x 1	85	8.75	\$600	\$244	N/A
GRC8TP	96 x 36 x 1	94	9	\$659	\$275	N/A

**High pressure laminate, knife edge**

GRC5NTPLK	60 x 30 x 1.19	55	5	\$1673	N/A	N/A
GRC5NHTPK	66 x 30 x 1.19	67	5.5	\$1826	N/A	N/A
GRC6NTPLK	72 x 30 x 1.19	74	6	\$1990	N/A	N/A
GRC7NTPLK	84 x 30 x 1.19	86	7	\$2133	N/A	N/A
GRC8NTPLK	96 x 30 x 1.19	96	8	\$2287	N/A	N/A
GRC5TPLK	60 x 36 x 1.19	84	6	\$1826	N/A	N/A
GRC5HTPLK	66 x 36 x 1.19	95	6.5	\$1980	N/A	N/A
GRC6TPLK	72 x 36 x 1.19	86	7	\$2144	N/A	N/A
GRC7TPLK	84 x 36 x 1.19	102	8	\$2451	N/A	N/A
GRC8TPLK	96 x 36 x 1.19	113	9	\$2758	N/A	N/A

**Veneer <sup>(2)</sup>**

GRC5NTPV	60 x 30 x 1.19	55	5	\$1882	N/A	\$271
GRC5NHTPV	66 x 30 x 1.19	67	5.5	\$2026	N/A	\$292
GRC6NTPV	72 x 30 x 1.19	74	6	\$2175	N/A	\$312
GRC7NTPV	84 x 30 x 1.19	86	7	\$2527	N/A	\$363
GRC8NTPV	96 x 30 x 1.19	96	8	\$2870	N/A	\$415
GRC5TPV	60 x 36 x 1.19	84	6	\$2175	N/A	\$312
GRC5HTPV	66 x 36 x 1.19	95	6.5	\$2374	N/A	\$343
GRC6TPV	72 x 36 x 1.19	86	7	\$2578	N/A	\$373
GRC7TPV	84 x 36 x 1.19	102	8	\$2998	N/A	\$435
GRC8TPV	96 x 36 x 1.19	113	9	\$3417	N/A	\$496

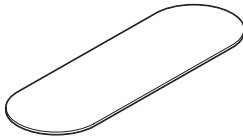

Racetrack Tops

Applicable bases to use with above tops - two bases required: GRB22H26, GRB22, GRB22H35, GRB22H41 round bases or GSB19H26, GSB19, GSB19H35, GSB19H41 square bases. Tops feature metal inserts for ease of assembly to base.

**Required specifications**

Top finish  
Edge finish <sup>(1)</sup>

**Optional specifications**

HP laminate <sup>(1)</sup>  
Knife edge <sup>(2)</sup>  
Grommet position or power block cut-out

**Applicable bases (two required)**

Round bases:  
GRB22H26, GRB22, GRB22H35, GRB22H41  
Square bases:  
GSB19H26, GSB19, GSB19H35, GSB19H41

**Accessories**

Power block

## BOAT SHAPE TOPS, 60" - 96"W

MODEL #      DIMENSIONS      WT/LB.      CUBIC FT.      LIST PRICE      HP ADD      KS ADD

W x D x H

### Thermally fused laminate, flat edge <sup>(1)</sup>

GBT5NTP	60 x 30 x 1	46	2.5	<b>\$422</b>	<b>\$178</b>	N/A
GBT5NHTP	66 x 30 x 1	56	2.44	<b>\$457</b>	<b>\$187</b>	N/A
GBT6NTP	72 x 30 x 1	62	3	<b>\$459</b>	<b>\$195</b>	N/A
GBT7NTP	84 x 30 x 1	72	7.5	<b>\$548</b>	<b>\$233</b>	N/A
GBT8NTP	96 x 30 x 1	80	8.5	<b>\$601</b>	<b>\$244</b>	N/A
GBT5TP	60 x 36 x 1	70	6.6	<b>\$483</b>	<b>\$195</b>	N/A
GBT5HTP	66 x 36 x 1	79	7.21	<b>\$488</b>	<b>\$199</b>	N/A
GBT6TP	72 x 36 x 1	72	7.5	<b>\$488</b>	<b>\$199</b>	N/A
GBT7TP	84 x 36 x 1	85	8.75	<b>\$600</b>	<b>\$244</b>	N/A
GBT8TP	96 x 36 x 1	94	9	<b>\$659</b>	<b>\$275</b>	N/A

### High pressure laminate, knife edge

GBT5NTPLK	60 x 30 x 1.19	55	5	<b>\$1673</b>	N/A	N/A
GBT5NHTPLK	66 x 30 x 1.19	67	5.5	<b>\$1826</b>	N/A	N/A
GBT6NTPLK	72 x 30 x 1.19	74	6	<b>\$1990</b>	N/A	N/A
GBT7NTPLK	84 x 30 x 1.19	86	7	<b>\$2133</b>	N/A	N/A
GBT8NTPLK	96 x 30 x 1.19	96	8	<b>\$2287</b>	N/A	N/A
GBT5TPLK	60 x 36 x 1.19	84	6	<b>\$1826</b>	N/A	N/A
GBT5HTPLK	66 x 36 x 1.19	95	6.5	<b>\$1980</b>	N/A	N/A
GBT6TPLK	72 x 36 x 1.19	86	7	<b>\$2144</b>	N/A	N/A
GBT7TPLK	84 x 36 x 1.19	102	8	<b>\$2451</b>	N/A	N/A
GBT8TPLK	96 x 36 x 1.19	113	9	<b>\$2758</b>	N/A	N/A

### Veneer <sup>(2)</sup>

GBT5NTPV	60 x 30 x 1.19	55	5	<b>\$1882</b>	N/A	<b>\$271</b>
GBT5NHTPV	66 x 30 x 1.19	67	5.5	<b>\$2026</b>	N/A	<b>\$292</b>
GBT6NTPV	72 x 30 x 1.19	74	6	<b>\$2175</b>	N/A	<b>\$312</b>
GBT7NTPV	84 x 30 x 1.19	86	7	<b>\$2527</b>	N/A	<b>\$363</b>
GBT8NTPV	96 x 30 x 1.19	96	8	<b>\$2870</b>	N/A	<b>\$415</b>
GBT5TPV	60 x 36 x 1.19	84	6	<b>\$2175</b>	N/A	<b>\$312</b>
GBT5HTPV	66 x 36 x 1.19	95	6.5	<b>\$2374</b>	N/A	<b>\$343</b>
GBT6TPV	72 x 36 x 1.19	86	7	<b>\$2578</b>	N/A	<b>\$373</b>
GBT7TPV	84 x 36 x 1.19	102	8	<b>\$2998</b>	N/A	<b>\$435</b>
GBT8TPV	96 x 36 x 1.19	113	9	<b>\$3417</b>	N/A	<b>\$496</b>

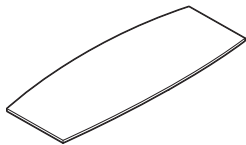

Boat Shape Tops

**Applicable bases to use with above tops - two bases required: GRB22H26, GRB22, GRB22H35, GRB22H41 round bases or GSB19H26, GSB19, GSB19H35, GSB19H41 square bases.** Tops feature metal inserts for ease of assembly to base.

- GBTxNTP/GBTxNHTP: 30"D across center and 24"D at ends.
- GBTxTP/GBTxHTP: 36"D across center and 28"D at ends.

#### Required specifications

Top finish  
Edge finish <sup>(1)</sup>

#### Optional specifications

HP laminate <sup>(1)</sup>  
Knife edge <sup>(2)</sup>  
Grommet position or power block cut-out

#### Applicable bases (two required)

Round bases:  
GRB22H26, GRB22, GRB22H35, GRB22H41  
Square bases:  
GSB19H26, GSB19, GSB19H35, GSB19H41

#### Accessories

Power block

BASES FOR TOPS 60" - 96"W	MODEL #	DIMENSIONS	WT/LB.	CUBIC FT.	LIST PRICE	BCH / CHM	ACO / SBR
---------------------------	---------	------------	--------	-----------	------------	-----------	-----------

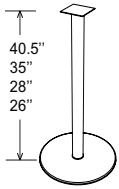

**22" Dia Round Bases**

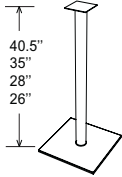

**18.5" Square Bases**

W x D x H

Order the quantity of bases as indicated by each top size.

GRB22H26	22 x - x 26	55	8.63	<b>\$793</b>	<b>\$147</b>	<b>\$221</b>
GRB22	22 x - x 28	55	9.33	<b>\$793</b>	<b>\$147</b>	<b>\$221</b>
GRB22H35	22 x - x 35	57.1	12	<b>\$831</b>	<b>\$164</b>	<b>\$253</b>
GRB22H41	22 x - x 40.5	58.3	14	<b>\$844</b>	<b>\$171</b>	<b>\$259</b>

**GRB22H26** - lounge height   **GRB22** - seated height   **GRB22H35** - counter height   **GRB22H41** - bar height

GSB19H26	18.5 x 18.5 x 26	50	5.94	<b>\$857</b>	<b>\$136</b>	<b>\$212</b>
GSB19	18.5 x 18.5 x 28	50	6.06	<b>\$857</b>	<b>\$136</b>	<b>\$212</b>
GSB19H35	18.5 x 18.5 x 35	51.8	7.52	<b>\$906</b>	<b>\$151</b>	<b>\$262</b>
GSB19H41	18.5 x 18.5 x 40.5	53.2	8.77	<b>\$937</b>	<b>\$166</b>	<b>\$267</b>

**GSB19H26** - lounge height   **GSB19** - seated height   **GSB19H35** - counter height   **GSB19H41** - bar height

Base comes fully assembled and features 0.5" adjustable glides to level on uneven surfaces. Screws included with base for attaching to appropriate top(s). Available in paint and plated finishes as listed on page 344. Upcharge applies on plated finishes.

**Required Specifications**  
Finish

**Optional Specifications**  
Plated finish



RECTANGULAR TOPS, 96" - 144"W

MODEL # DIMENSIONS WT/LB. CUBIC FT. LIST PRICE HP ADD R3 ADD KS ADD

W x D x H

**Thermally fused laminate, flat edge (1 piece top - 2 bases required) <sup>(1)(4)</sup>**

GRT8MTP	96 x 42 x 1	128	11.84	\$1221	\$504	\$122.10	N/A
GRT8WTP	96 x 48 x 1	190	14	\$1221	\$512	\$122.10	N/A

**Thermally fused laminate, flat edge (2 piece tops - 3 bases required) <sup>(1)(4)</sup>**

GRT10WTP	120 x 48 x 1	220	17	\$1537	\$636	\$153.70	N/A
GRT12WTP	144 x 48 x 1	262	21	\$1791	\$739	\$179.10	N/A

**High pressure laminate, knife edge (1 piece top - 2 bases required)**

GRT8MTPLK	96 x 42 x 1.19	154	11	\$3069	N/A	N/A	N/A
GRT8WTPLK	96 x 48 x 1.19	228	12	\$3432	N/A	N/A	N/A

**High pressure laminate, knife edge (2 piece tops - 3 bases required)**

GRT10WTPLK	120 x 48 x 1.19	264	15	\$4630	N/A	N/A	N/A
GRT12WTPLK	144 x 48 x 1.19	314	18	\$5524	N/A	N/A	N/A

**Veneer (1 piece top - 2 bases required) <sup>(2)</sup>**

GRT8MTPV	96 x 42 x 1.19	154	11	\$3903	N/A	N/A	\$378
GRT8WTPV	96 x 48 x 1.19	228	12	\$4389	N/A	N/A	\$430

**Veneer (2 piece tops - 3 bases required) <sup>(2)</sup>**

GRT10WTPV	120 x 48 x 1.19	264	15	\$5821	N/A	N/A	\$573
GRT12WTPV	144 x 48 x 1.19	314	18	\$6952	N/A	N/A	\$685

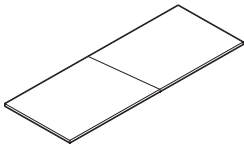

Rectangular Tops

**Applicable bases to use with above tops: GRB28 round base or GSB23 square base (28"H).**

**Two bases required for 96"W tops or three bases required for 120" and 144"W tops.**

Tops feature metal inserts for ease of assembly to base.

RACETRACK TOPS, 96" - 144"W

**Thermally fused laminate, flat edge (1 piece top - 2 bases required) <sup>(1)</sup>**

GRC8MTP	96 x 42 x 1	128	11.84	\$1240	\$504	N/A	N/A
GRC8WTP	96 x 48 x 1	190	14	\$1240	\$512	N/A	N/A

**Thermally fused laminate, flat edge (2 piece tops - 3 bases required) <sup>(1)</sup>**

GRC10WTP	120 x 48 x 1	220	17	\$1560	\$636	N/A	N/A
GRC12WTP	144 x 48 x 1	262	21	\$1818	\$739	N/A	N/A

**High pressure laminate, knife edge (1 piece top - 2 bases required)**

GRC8MTPLK	96 x 42 x 1.19	154	11	\$3658	N/A	N/A	N/A
GRC8WTPLK	96 x 48 x 1.19	228	12	\$4169	N/A	N/A	N/A

**High pressure laminate, knife edge (2 piece tops - 3 bases required)**

GRC10WTPLK	120 x 48 x 1.19	264	15	\$5192	N/A	N/A	N/A
GRC12WTPLK	144 x 48 x 1.19	314	18	\$6215	N/A	N/A	N/A

**Veneer (1 piece top - 2 bases required) <sup>(2)</sup>**

GRC8MTPV	96 x 42 x 1.19	154	11	\$4630	N/A	N/A	\$455
GRC8WTPV	96 x 48 x 1.19	228	12	\$5141	N/A	N/A	\$506

**Veneer (2 piece tops - 3 bases required) <sup>(2)</sup>**

GRC10WTPV	120 x 48 x 1.19	264	15	\$6727	N/A	N/A	\$666
GRC12WTPV	144 x 48 x 1.19	314	18	\$7954	N/A	N/A	\$788

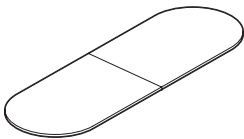

Racetrack Tops

**Applicable bases to use with above tops: GRB28 round base or GSB23 square base (28"H).**

**Two bases required for 96"W tops or three bases required for 120" and 144"W tops.**

Tops feature metal inserts for ease of assembly to base.

**Required specifications**

Top finish  
Edge finish <sup>(1)</sup>

**Optional specifications**

HP laminate <sup>(1)</sup>  
Knife edge <sup>(2)</sup>  
3" radiused corners <sup>(4)</sup>  
Grommet position or power block cut-out

**Applicable bases (two or three required)**

GRB28 - round  
GSB23 - square

**Accessories**

Power block

**BOAT SHAPE TOPS, 96" - 144"W**      **MODEL #**      **DIMENSIONS**      **WT/LB.**      **CUBIC FT.**      **LIST PRICE**      **HP ADD**      **KS ADD**

W x D x H

**Thermally fused laminate, flat edge (1 piece top - 2 bases required) <sup>(1)</sup>**

GBT8MTP	96 x 42 x 1	128	11.84	<b>\$1240</b>	<b>\$504</b>	N/A
GBT8WTP	96 x 48 x 1	190	14	<b>\$1240</b>	<b>\$512</b>	N/A

**Thermally fused laminate, flat edge (2 piece tops - 3 bases required) <sup>(1)</sup>**

GBT10WTP	120 x 48 x 1	220	17	<b>\$1560</b>	<b>\$636</b>	N/A
GBT12WTP	144 x 48 x 1	262	21	<b>\$1818</b>	<b>\$739</b>	N/A

**High pressure laminate, knife edge (1 piece top - 2 bases required)**

GBT8MTPLK	96 x 42 x 1.19	154	11	<b>\$3658</b>	N/A	N/A
GBT8WTPLK	96 x 48 x 1.19	228	12	<b>\$4169</b>	N/A	N/A

**High pressure laminate, knife edge (2 piece tops - 3 bases required)**

GBT10WTPLK	120 x 48 x 1.19	264	15	<b>\$5192</b>	N/A	N/A
GBT12WTPLK	144 x 48 x 1.19	314	18	<b>\$6215</b>	N/A	N/A

**Veneer (1 piece top - 2 bases required) <sup>(2)</sup>**

GBT8MTPV	96 x 42 x 1.19	154	11	<b>\$4630</b>	N/A	<b>\$455</b>
GBT8WTPV	96 x 48 x 1.19	228	12	<b>\$5141</b>	N/A	<b>\$506</b>

**Veneer (2 piece tops - 3 bases required) <sup>(2)</sup>**

GBT10WTPV	120 x 48 x 1.19	264	15	<b>\$6727</b>	N/A	<b>\$666</b>
GBT12WTPV	144 x 48 x 1.19	314	18	<b>\$7954</b>	N/A	<b>\$788</b>

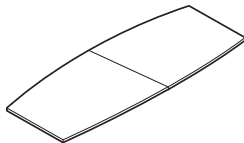

Boat Shape Tops

**Applicable bases to use with above tops: GRB28 round base or GSB23 square base (28"H).**

**Two bases required for 96"W tops or three bases required for 120" and 144"W tops.**

Tops feature metal inserts for ease of assembly to base.

- GBTxMTP: 42"D at center and 33"D at ends.
- GBTxxWTP: 48"D at center and 38"D at ends.

**BASES FOR TOPS 60" - 96"W**      **MODEL #**      **DIMENSIONS**      **WT/LB.**      **CUBIC FT.**      **LIST PRICE**      **BCH / CHM**      **ACO / SBR**

W x D x H

**BASE VALID FOR TOPS ON PAGES 366-367:**

**Order the quantity of bases as indicated by each top size.**

GRB28	28 x - x 28	100	15.63	<b>\$1250</b>	<b>\$147</b>	<b>\$372</b>
-------	-------------	-----	-------	---------------	--------------	--------------

seated height

GSB23	22.5 x 22.5 x 28	82	9.33	<b>\$1146</b>	<b>\$136</b>	<b>\$235</b>
-------	------------------	----	------	---------------	--------------	--------------

seated height

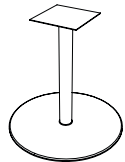

28" Dia Round Base

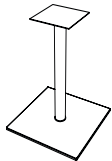

23" Square Base

Base comes fully assembled and features 0.5" adjustable glides to level on uneven surfaces. Screws included with base for attaching to appropriate top(s). Available in paint and plated finishes as listed on page 344. Upcharge applies on plated finishes.

**Required specifications**

- Top finish
- Edge finish <sup>(1)</sup>
- Base finish

**Optional specifications**

- HP laminate <sup>(1)</sup>
- Knife edge <sup>(2)</sup>
- Grommet position or power block cut-out
- Base plated finish

**Applicable bases (two or three required)**

- GRB28 - round
- GSB23 - square

**Accessories**

- Power block

## RECTANGULAR TOPS FOR DUAL COLUMN BASE

MODEL # DIMENSIONS WT/LB. CUBIC FT. LIST PRICE HP ADD R3 ADD KS ADD

W x D x H

### Thermally fused laminate, flat edge <sup>(1)(4)</sup>

GRTD5TP	60 x 36 x 1	60	6.6	\$472	\$188	\$47.20	N/A
GRTD5HTP	66 x 36 x 1	69	7.21	\$481	\$195	\$48.10	N/A
GRTD6TP	72 x 36 x 1	75	7.82	\$481	\$195	\$48.10	N/A
GRTD5MTP	60 x 42 x 1	73	7.62	\$633	\$273	\$63.30	N/A
GRTD5HMTP	66 x 42 x 1	81	8.32	\$675	\$294	\$67.50	N/A
GRTD6MTP	72 x 42 x 1	89	9.02	\$694	\$300	\$69.40	N/A

### High pressure laminate, knife edge

GRTD5TPLK	60 x 36 x 1.19	72	6	\$1448	N/A	N/A	N/A
GRTD5HTPLK	66 x 36 x 1.19	83	6.5	\$1581	N/A	N/A	N/A
GRTD6TPLK	72 x 36 x 1.19	90	7	\$1719	N/A	N/A	N/A
GRTD5MTPLK	60 x 42 x 1.19	88	7	\$1668	N/A	N/A	N/A
GRTD5HMTPLK	66 x 42 x 1.19	97	7.5	\$1832	N/A	N/A	N/A
GRTD6MTPLK	72 x 42 x 1.19	107	8	\$1990	N/A	N/A	N/A

### Veneer <sup>(2)</sup>

GRTD5TPV	60 x 36 x 1.19	72	6	\$1898	N/A	N/A	\$184
GRTD5HTPV	66 x 36 x 1.19	83	6.5	\$2072	N/A	N/A	\$199
GRTD6TPV	72 x 36 x 1.19	90	7	\$2251	N/A	N/A	\$215
GRTD5MTPV	60 x 42 x 1.19	88	7	\$2195	N/A	N/A	\$210
GRTD5HMTPV	66 x 42 x 1.19	97	7.5	\$2405	N/A	N/A	\$230
GRTD6MTPV	72 x 42 x 1.19	107	8	\$2614	N/A	N/A	\$256

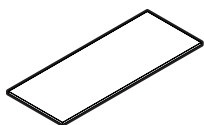

Rectangular Tops

Tops feature metal inserts for ease of assembly to base. One dual column base (**GDCB36H28**) required. Limited cut-out options available for power modules, include A2, E2, J2, or FOG2 only. Power modules corresponding to applicable cut-out codes ordered separately.

## RACETRACK TOPS FOR DUAL COLUMN BASE

### Thermally fused laminate, flat edge <sup>(1)</sup>

GRCD5TP	60 x 36 x 1	60	6.6	\$483	\$195	N/A	N/A
GRCD5HTP	66 x 36 x 1	69	7.21	\$488	\$199	N/A	N/A
GRCD6TP	72 x 36 x 1	75	7.82	\$488	\$199	N/A	N/A
GRCD5MTP	60 x 42 x 1	73	7.62	\$633	\$273	N/A	N/A
GRCD5HMTP	66 x 42 x 1	81	8.32	\$675	\$294	N/A	N/A
GRCD6MTP	72 x 42 x 1	89	9.02	\$694	\$300	N/A	N/A

### High pressure laminate, knife edge

GRCD5TPLK	60 x 36 x 1.19	72	6	\$1995	N/A	N/A	N/A
GRCD5HTPLK	66 x 36 x 1.19	83	6.5	\$2123	N/A	N/A	N/A
GRCD6TPLK	72 x 36 x 1.19	90	7	\$2251	N/A	N/A	N/A
GRCD5MTPLK	60 x 42 x 1.19	88	7	\$2379	N/A	N/A	N/A
GRCD5HMTPLK	66 x 42 x 1.19	97	7.5	\$2507	N/A	N/A	N/A
GRCD6MTPLK	72 x 42 x 1.19	107	8	\$2635	N/A	N/A	N/A

### Veneer <sup>(2)</sup>

GRCD5TPV	60 x 36 x 1.19	72	6	\$2379	N/A	N/A	\$230
GRCD5HTPV	66 x 36 x 1.19	83	6.5	\$2507	N/A	N/A	\$241
GRCD6TPV	72 x 36 x 1.19	90	7	\$2635	N/A	N/A	\$256
GRCD5MTPV	60 x 42 x 1.19	88	7	\$2762	N/A	N/A	\$271
GRCD5HMTPV	66 x 42 x 1.19	97	7.5	\$2891	N/A	N/A	\$282
GRCD6MTPV	72 x 42 x 1.19	107	8	\$3018	N/A	N/A	\$292



Racetrack Tops

Tops feature metal inserts for ease of assembly to base. One dual column base (**GDCB36H28**) required. Limited cut-out options available for power modules, include A2, E2, J2, or FOG2 only. Power modules corresponding to applicable cut-out codes ordered separately.

#### Required specifications

Top finish  
Edge finish <sup>(1)</sup>

#### Optional specifications

HP laminate <sup>(1)</sup>  
Knife edge <sup>(2)</sup>  
3" radiused corners <sup>(4)</sup>  
Grommet position or power block cut-out

#### Applicable bases

GDCB36H28

#### Accessories

Power block

**BOAT SHAPE TOPS FOR DUAL COLUMN BASE**

MODEL #	DIMENSIONS	WT/LB.	CUBIC FT.	LIST PRICE	HP ADD	KS ADD
W x D x H						
<b>Thermally fused laminate, flat edge <sup>(1)</sup></b>						
GBTD5TP	60 x 36 x 1	60	6.6	<b>\$483</b>	<b>\$195</b>	N/A
GBTD5HTP	66 x 36 x 1	69	7.21	<b>\$488</b>	<b>\$199</b>	N/A
GBTD6TP	72 x 36 x 1	75	7.82	<b>\$488</b>	<b>\$199</b>	N/A
GBTD5MTP	60 x 42 x 1	73	7.62	<b>\$633</b>	<b>\$273</b>	N/A
GBTD5HMTP	66 x 42 x 1	81	8.32	<b>\$675</b>	<b>\$294</b>	N/A
GBTD6MTP	72 x 42 x 1	89	9.02	<b>\$694</b>	<b>\$300</b>	N/A
<b>High pressure laminate, knife edge</b>						
GBTD5TPLK	60 x 36 x 1.19	72	6	<b>\$1995</b>	N/A	N/A
GBTD5HTPLK	66 x 36 x 1.19	83	6.5	<b>\$2123</b>	N/A	N/A
GBTD6TPLK	72 x 36 x 1.19	90	7	<b>\$2251</b>	N/A	N/A
GBTD5MTPLK	60 x 42 x 1.19	88	7	<b>\$2379</b>	N/A	N/A
GBTD5HMTPK	66 x 42 x 1.19	97	7.5	<b>\$2507</b>	N/A	N/A
GBTD6MTPLK	72 x 42 x 1.19	107	8	<b>\$2635</b>	N/A	N/A
<b>Veneer <sup>(2)</sup></b>						
GBTD5TPV	60 x 36 x 1.19	72	6	<b>\$2379</b>	N/A	<b>\$230</b>
GBTD5HTPV	66 x 36 x 1.19	83	6.5	<b>\$2507</b>	N/A	<b>\$241</b>
GBTD6TPV	72 x 36 x 1.19	90	7	<b>\$2635</b>	N/A	<b>\$256</b>
GBTD5MTPV	60 x 42 x 1.19	88	7	<b>\$2762</b>	N/A	<b>\$271</b>
GBTD5HMTPV	66 x 42 x 1.19	97	7.5	<b>\$2891</b>	N/A	<b>\$282</b>
GBTD6MTPV	72 x 42 x 1.19	107	8	<b>\$3018</b>	N/A	<b>\$292</b>

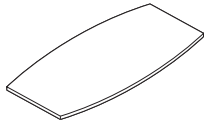

**Boat Shape Tops**

Tops feature metal inserts for ease of assembly to base. One dual column base (**GDCB36H28**) required. Limited cut-out options available for power modules, include A2, E2, J2, or FOG2 only. Power modules corresponding to applicable cut-out codes ordered separately.

- GBTDxTP/GBTDxHTP: 36"D at center and 28"D at ends
- GBTDxMTP/GBTDxHMTP: 42"D at center and 33"D at ends.

**DUAL COLUMN BASE FOR GxTDxxx TOPS**

MODEL #	DIMENSIONS	WT/LB.	CUBIC FT.	LIST PRICE	BCH / CHM	ACO / SBR
W x D x H						
<b>BASE VALID FOR TOPS ON PAGES 368-369:</b>						
GDCB36H28	19 x 36 x 28	116.23	12.16	<b>\$2103</b>	<b>\$582</b>	<b>\$768</b>
seated height						

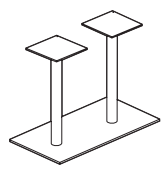

**28" H Dual Column Base**

Base ships knocked-down; assembly required. Features 0.5" adjustable glides to level on uneven surfaces. Screws included with base for attaching to appropriate top(s). Available in paint and plated finishes as listed on page 344. Upcharge applies on plated finishes.

Required specifications	Optional specifications	Applicable bases	Accessories
Top finish Edge finish <sup>(1)</sup> Base finish	HP laminate <sup>(1)</sup> Knife edge <sup>(2)</sup> Grommet position or power block cut-out Base plated finish	GDCB36H28	Power block

## HUDDLE TABLES OVERVIEW

Bring teams together to huddle, share and collaborate.

Three heights available - seated desk height: 29", counter height: 36", bar height: 41.5" with D top, wedge, rectangular or soft ellipse shaped tops.

Laminate kits (consisting of laminate top and U-base) are sold separately from metal bases for huddle tables. Tops include metal inserts for ease of assembly to metal base. All tops are standard with an edge scoop to help manage cables from wall mounted flat screen monitors and/or edge mounting power module (PS305057/PS305002 as an example). Support channels are included with tops over 60" wide.

Metal bases ship fully assembled and include 0.5" adjustable glides and metal screws for attaching to the top. Be sure to specify bases specific to huddle tables GRHB22Hxx or GSB19Hxx.

### D-TOP HUDDLE TABLES

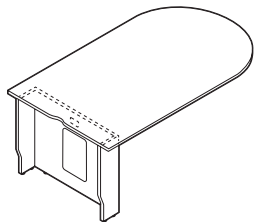

29"H D-Top Huddle

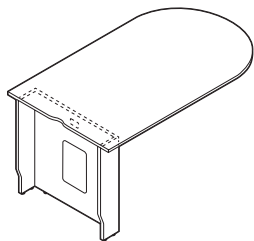

36"H D-Top Huddle

MODEL #	DIMENSIONS	WT/LB.	CUBIC FT.	LIST PRICE	HP ADD
<b>W x D x H</b>					
GDH364829	36 x 48 x 29	77.05	3.94	<b>\$952</b>	<b>\$188</b>
GDH366029	36 x 60 x 29	86.95	4.46	<b>\$1162</b>	<b>\$188</b>
GDH367229	36 x 72 x 29	97	4.99	<b>\$1295</b>	<b>\$195</b>
GDH426029	42 x 60 x 29	99.82	5.18	<b>\$1301</b>	<b>\$273</b>
GDH427229	42 x 72 x 29	111.5	5.79	<b>\$1459</b>	<b>\$300</b>
GDH428429	42 x 84 x 29	123.1	11.98	<b>\$1616</b>	<b>\$477</b>
GDH429629	42 x 96 x 29	134.74	13.31	<b>\$1746</b>	<b>\$504</b>
GDH486029	48 x 60 x 29	112.6	5.89	<b>\$1453</b>	<b>\$374</b>
GDH487229	48 x 72 x 29	126	6.58	<b>\$1626</b>	<b>\$443</b>
GDH488429	48 x 84 x 29	139.24	13.5	<b>\$1738</b>	<b>\$469</b>
GDH489629	48 x 96 x 29	152.56	15	<b>\$1880</b>	<b>\$512</b>

Laminate U-base support is 8"D with 7" inside clearance to wall. Access wall through 14.5"H x 9.5"W hinged door with touch latch in front panel of u-base support. U-base includes 0.5" adjustable glides. U-base side panels are tapered at the bottom to clear most baseboards. **Cut-out position available in position 2 only.**

- Metal bases sold separately. Compatible with **GRHB22H28** or **GSB19H28** only, requires one base.

GDH364836	36 x 48 x 36	85.95	4.31	<b>\$980</b>	<b>\$188</b>
GDH366036	36 x 60 x 36	95.85	4.84	<b>\$1189</b>	<b>\$188</b>
GDH367236	36 x 72 x 36	105.9	5.37	<b>\$1323</b>	<b>\$195</b>
GDH426036	42 x 60 x 36	109.82	5.61	<b>\$1332</b>	<b>\$273</b>
GDH427236	42 x 72 x 36	121.5	6.22	<b>\$1491</b>	<b>\$300</b>
GDH428436	42 x 84 x 36	133.1	12.4	<b>\$1646</b>	<b>\$477</b>
GDH429636	42 x 96 x 36	144.74	13.75	<b>\$1777</b>	<b>\$504</b>
GDH486036	48 x 60 x 36	123.6	6.38	<b>\$1488</b>	<b>\$374</b>
GDH487236	48 x 72 x 36	137	7.08	<b>\$1661</b>	<b>\$443</b>
GDH488436	48 x 84 x 36	150.24	14	<b>\$1773</b>	<b>\$469</b>
GDH489636	48 x 96 x 36	163.56	15.5	<b>\$1916</b>	<b>\$512</b>

Laminate U-base support is 8"D with 7" inside clearance to wall. Access wall through 14.5"H x 9.5"W hinged door with touch latch in front panel of U-base support. U-base includes 0.5" adjustable glides. U-base side panels are tapered at the bottom to clear most baseboards. **Cut-out position available in position 2 only.**

- Metal bases sold separately. Compatible with **GRHB22H35** or **GSB19H35** only, requires one base.

#### Required Specifications

Top finish  
Base finish

#### Optional Specifications

HP laminate  
Grommet position or power block cut-out

#### Accessories

Power block

**D-TOP HUDDLE TABLES**      **MODEL #**      **DIMENSIONS**      **WT/LB.**      **CUBIC FT.**      **LIST PRICE**      **HP ADD**

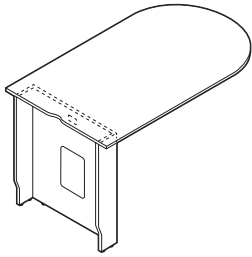

**41.5"H D-Top Huddle**

	<b>W x D x H</b>					
GDH364841	36 x 48	x 41.5	92.65	4.58	<b>\$1032</b>	<b>\$188</b>
GDH366041	36 x 60	x 41.5	102.55	5.11	<b>\$1241</b>	<b>\$188</b>
GDH367241	36 x 72	x 41.5	112.6	5.63	<b>\$1375</b>	<b>\$195</b>
GDH426041	42 x 60	x 41.5	117.32	5.92	<b>\$1392</b>	<b>\$273</b>
GDH427241	42 x 72	x 41.5	129	6.53	<b>\$1549</b>	<b>\$300</b>
GDH428441	42 x 84	x 41.5	140.6	12.72	<b>\$1706</b>	<b>\$477</b>
GDH429641	42 x 96	x 41.5	152.24	14.06	<b>\$1837</b>	<b>\$504</b>
GDH486041	48 x 60	x 41.5	130.1	6.74	<b>\$1552</b>	<b>\$374</b>
GDH487241	48 x 72	x 41.5	143.5	7.43	<b>\$1726</b>	<b>\$443</b>
GDH488441	48 x 84	x 41.5	156.74	14.53	<b>\$1839</b>	<b>\$469</b>
GDH489641	48 x 96	x 41.5	170.06	15.85	<b>\$1980</b>	<b>\$512</b>

Laminate U-base support is 8"D with 7" inside clearance to wall. Access wall through 14.5"H x 9.5"W hinged door with touch latch in front panel of U-base support. U-base includes 0.5" adjustable glides. U-base side panels are tapered at the bottom to clear most baseboards. **Cut-out position available in position 2 only.**

- Metal bases sold separately. Compatible with **GRHB22H41** or **GSHB19H41** only, requires one base.

**Required Specifications**

Top finish  
Base finish

**Optional Specifications**

HP laminate  
Grommet position or power block cut-out

**Accessories**

Power block

# S SWAP™ TABLES

## WEDGE HUDDLE TABLES

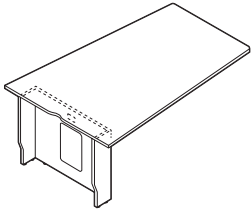

**29"H Wedge Huddle**

MODEL #	DIMENSIONS	WT/LB.	CUBIC FT.	LIST PRICE	HP ADD
W x D x H					
GWH486029	48 x 60 x 29	112.6	5.89	<b>\$1448</b>	<b>\$374</b>
GWH487229	48 x 72 x 29	126	6.58	<b>\$1626</b>	<b>\$443</b>
GWH488429	48 x 84 x 29	139.24	13.5	<b>\$1738</b>	<b>\$469</b>
GWH489629	48 x 96 x 29	152.56	15	<b>\$1880</b>	<b>\$512</b>

Laminate U-base support is 8"D with 7" inside clearance to wall. Access wall through 14.5"H x 9.5"W hinged door with touch latch in front panel of U-base support. U-base includes 0.5" adjustable glides. U-base side panels are tapered at the bottom to clear most baseboards. **Cut-out position available in position 2 only.**

- Metal bases sold separately. Compatible with **GRHB22H28** or **GSHB19H28** only, requires one base.

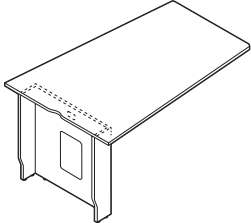

**36"H Wedge Huddle**

GWH486036	48 x 60 x 36	123.6	6.38	<b>\$1483</b>	<b>\$374</b>
GWH487236	48 x 72 x 36	137	7.08	<b>\$1661</b>	<b>\$443</b>
GWH488436	48 x 84 x 36	150.24	14	<b>\$1773</b>	<b>\$469</b>
GWH489636	48 x 96 x 36	163.56	15.5	<b>\$1916</b>	<b>\$512</b>

Laminate U-base support is 8"D with 7" inside clearance to wall. Access wall through 14.5"H x 9.5"W hinged door with touch latch in front panel of U-base support. U-base includes 0.5" adjustable glides. U-base side panels are tapered at the bottom to clear most baseboards. **Cut-out position available in position 2 only.**

- Metal bases sold separately. Compatible with **GRHB22H35** or **GSHB19H35** only, requires one base.

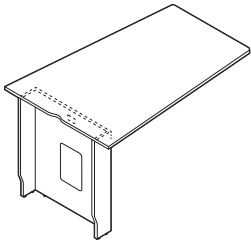

**41.5"H Wedge Huddle**

GWH486041	48 x 60 x 41.5	130.1	6.74	<b>\$1548</b>	<b>\$374</b>
GWH487241	48 x 72 x 41.5	143.5	7.43	<b>\$1726</b>	<b>\$443</b>
GWH488441	48 x 84 x 41.5	156.74	14.35	<b>\$1839</b>	<b>\$469</b>
GWH489641	48 x 96 x 41.5	170.06	15.85	<b>\$1980</b>	<b>\$512</b>

Laminate U-base support is 8"D with 7" inside clearance to wall. Access wall through 14.5"H x 9.5"W hinged door with touch latch in front panel of U-base support. U-base includes 0.5" adjustable glides. U-base side panels are tapered at the bottom to clear most baseboards. **Cut-out position available in position 2 only.**

- Metal bases sold separately. Compatible with **GRHB22H41** or **GSHB19H41** only, requires one base.

### Required Specifications

Top finish  
Base finish

### Optional Specifications

HP laminate  
Grommet position or power block cut-out

### Accessories

Power block

RECTANGULAR HUDDLE TABLES      MODEL #      DIMENSIONS      WT/LB.      CUBIC FT.      LIST PRICE      HP ADD

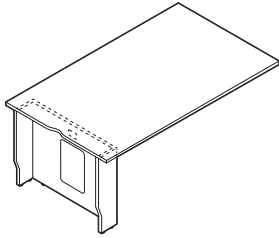

29"H Rectangular Huddle

	W x D x H				
GRH364829	36 x 48 x 29	77.05	3.94	\$952	\$188
GRH366029	36 x 60 x 29	86.95	4.46	\$1161	\$188
GRH367229	36 x 72 x 29	97	4.99	\$1295	\$195
GRH426029	42 x 60 x 29	99.82	5.18	\$1301	\$273
GRH427229	42 x 72 x 29	111.5	5.79	\$1459	\$300
GRH428429	42 x 84 x 29	123.1	11.98	\$1616	\$477
GRH429629	42 x 96 x 29	134.74	13.31	\$1746	\$504
GRH486029	48 x 60 x 29	112.6	5.89	\$1453	\$374
GRH487229	48 x 72 x 29	126	6.58	\$1626	\$443
GRH488429	48 x 84 x 29	139.24	13.5	\$1738	\$469
GRH489629	48 x 96 x 29	152.56	15	\$1880	\$512

Laminate u-base support is 8"D with 7" inside clearance to wall. Access wall through 14.5"H x 9.5"W hinged door with touch latch in front panel of u-base support. U-base includes 0.5" adjustable glides. U-base side panels are tapered at the bottom to clear most baseboards. **Cut-out position available in position 2 only.**

- Metal bases sold separately. Compatible with **GRHB22H28** or **GSHB19H28** only, requires one base.

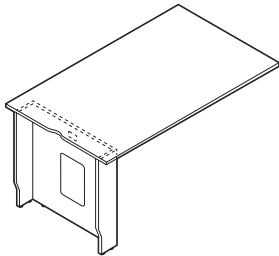

36"H Rectangular Huddle

GRH364836	36 x 48 x 36	85.95	4.31	\$980	\$188
GRH366036	36 x 60 x 36	95.85	4.84	\$1189	\$188
GRH367236	36 x 72 x 36	105.9	5.37	\$1323	\$195
GRH426036	42 x 60 x 36	109.82	5.61	\$1332	\$273
GRH427236	42 x 72 x 36	121.5	6.22	\$1491	\$300
GRH428436	42 x 84 x 36	133.1	12.41	\$1646	\$477
GRH429636	42 x 96 x 36	144.74	13.75	\$1777	\$504
GRH486036	48 x 60 x 36	123.6	6.38	\$1488	\$374
GRH487236	48 x 72 x 36	137	7.08	\$1661	\$443
GRH488436	48 x 84 x 36	150.24	14	\$1773	\$469
GRH489636	48 x 96 x 36	163.56	15.5	\$1916	\$512

Laminate u-base support is 8"D with 7" inside clearance to wall. Access wall through 14.5"H x 9.5"W hinged door with touch latch in front panel of u-base support. U-base includes 0.5" adjustable glides. U-base side panels are tapered at the bottom to clear most baseboards. **Cut-out position available in position 2 only.**

- Metal bases sold separately. Compatible with **GRHB22H35** or **GSHB19H35** only, requires one base.

**Required Specifications**

Top finish  
Base finish

**Optional Specifications**

HP laminate  
Grommet position or power block cut-out

**Accessories**

Power block



# S SWAP™ TABLES

## RECTANGULAR HUDDLE TABLES

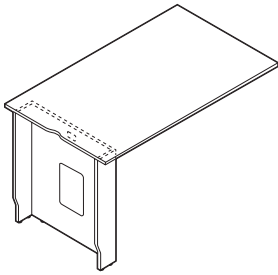

41.5"H Rectangular Huddle

MODEL #	DIMENSIONS	WT/LB.	CUBIC FT.	LIST PRICE	HP ADD
W x D x H					
GRH364841	36 x 48 x 41.5	92.65	4.58	<b>\$1032</b>	<b>\$188</b>
GRH366041	36 x 60 x 41.5	102.55	5.11	<b>\$1241</b>	<b>\$188</b>
GRH367241	36 x 72 x 41.5	112.6	5.63	<b>\$1375</b>	<b>\$195</b>
GRH426041	42 x 60 x 41.5	117.32	5.92	<b>\$1392</b>	<b>\$374</b>
GRH427241	42 x 72 x 41.5	129	6.53	<b>\$1549</b>	<b>\$300</b>
GRH428441	42 x 84 x 41.5	140.6	12.72	<b>\$1706</b>	<b>\$477</b>
GRH429641	42 x 96 x 41.5	152.24	14.06	<b>\$1837</b>	<b>\$504</b>
GRH486041	48 x 60 x 41.5	130.1	6.74	<b>\$1552</b>	<b>\$374</b>
GRH487241	48 x 72 x 41.5	143.5	7.43	<b>\$1726</b>	<b>\$443</b>
GRH488441	48 x 84 x 41.5	156.74	14.35	<b>\$1839</b>	<b>\$469</b>
GRH489641	48 x 96 x 41.5	170.06	15.85	<b>\$1980</b>	<b>\$512</b>

Laminate U-base support is 8"D with 7" inside clearance to wall. Access wall through 14.5"H x 9.5"W hinged door with touch latch in front panel of U-base support. U-base includes 0.5" adjustable glides. U-base side panels are tapered at the bottom to clear most baseboards. **Cut-out position available in position 2 only.**

- Metal bases sold separately. Compatible with **GRHB22H41** or **GSHB19H41** only, requires one base.

### Required Specifications

Top finish  
Base finish

### Optional Specifications

HP laminate  
Grommet position or power block cut-out

### Accessories

Power block

**SOFT ELLIPSE HUDDLE TABLES**

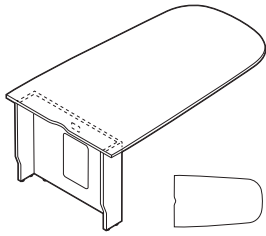

**29"H Soft Ellipse Huddle**

MODEL #	DIMENSIONS	WT/LB.	CUBIC FT.	LIST PRICE	HP ADD
<b>W x D x H</b>					
GSEH364829	36 x 48 x 29	77.05	3.94	<b>\$952</b>	<b>\$188</b>
GSEH366029	36 x 60 x 29	86.95	4.46	<b>\$1161</b>	<b>\$188</b>
GSEH367229	36 x 72 x 29	97	4.99	<b>\$1295</b>	<b>\$195</b>
GSEH426029	42 x 60 x 29	99.82	5.18	<b>\$1301</b>	<b>\$273</b>
GSEH427229	42 x 72 x 29	111.5	5.79	<b>\$1459</b>	<b>\$300</b>
GSEH428429	42 x 84 x 29	123.1	11.98	<b>\$1616</b>	<b>\$477</b>
GSEH429629	42 x 96 x 29	134.7	13.31	<b>\$1746</b>	<b>\$504</b>
GSEH486029	48 x 60 x 29	112.6	5.89	<b>\$1453</b>	<b>\$374</b>
GSEH487229	48 x 72 x 29	126	6.58	<b>\$1626</b>	<b>\$443</b>
GSEH488429	48 x 84 x 29	139.2	13.5	<b>\$1738</b>	<b>\$469</b>
GSEH489629	48 x 96 x 29	152.6	15	<b>\$1880</b>	<b>\$512</b>

Laminate u-base support is 8"D with 7" inside clearance to wall. Access wall through 14.5"H x 9.5"W hinged door with touch latch in front panel of u-base support. U-base includes 0.5" adjustable glides. U-base side panels are tapered at the bottom to clear most baseboards. **Cut-out position available in position 2 only.**

- Metal bases sold separately. Compatible with **GRHB22H28** or **GSHB19H28** only, requires one base.

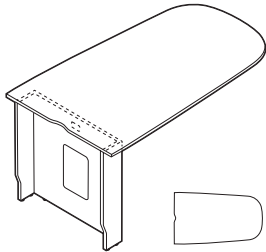

**36"H Soft Ellipse Huddle**

GSEH364836	36 x 48 x 36	86	4.31	<b>\$980</b>	<b>\$188</b>
GSEH366036	36 x 60 x 36	95.9	4.84	<b>\$1189</b>	<b>\$188</b>
GSEH367236	36 x 72 x 36	105.9	5.37	<b>\$1323</b>	<b>\$195</b>
GSEH426036	42 x 60 x 36	109.8	5.61	<b>\$1332</b>	<b>\$273</b>
GSEH427236	42 x 72 x 36	121.5	6.22	<b>\$1491</b>	<b>\$300</b>
GSEH428436	42 x 84 x 36	133.1	12.41	<b>\$1646</b>	<b>\$477</b>
GSEH429636	42 x 96 x 36	144.74	13.75	<b>\$1777</b>	<b>\$504</b>
GSEH486036	48 x 60 x 36	123.6	6.38	<b>\$1488</b>	<b>\$374</b>
GSEH487236	48 x 72 x 36	137	7.08	<b>\$1661</b>	<b>\$443</b>
GSEH488436	48 x 84 x 36	150.24	14	<b>\$1773</b>	<b>\$469</b>
GSEH489636	48 x 96 x 36	163.56	15.5	<b>\$1916</b>	<b>\$512</b>

Laminate u-base support is 8"D with 7" inside clearance to wall. Access wall through 14.5"H x 9.5"W hinged door with touch latch in front panel of u-base support. U-base includes 0.5" adjustable glides. U-base side panels are tapered at the bottom to clear most baseboards. **Cut-out position available in position 2 only.**

- Metal bases sold separately. Compatible with **GRHB22H35** or **GSHB19H35** only, requires one base.

**Required Specifications**

Top finish  
Base finish

**Optional Specifications**

HP laminate  
Grommet position or power block cut-out

**Accessories**

Power block

# S SWAP™ TABLES

## SOFT ELLIPSE HUDDLE TABLES

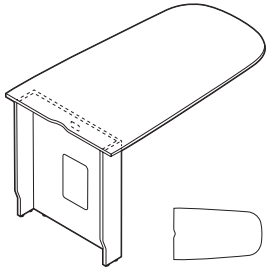

**41.5"H Soft Ellipse Huddle**

MODEL #	DIMENSIONS	WT/LB.	CUBIC FT.	LIST PRICE	HP ADD
---------	------------	--------	-----------	------------	--------

**W x D x H**

GSEH364841	36 x 48 x 41.5	92.65	4.58	<b>\$1032</b>	<b>\$188</b>
GSEH366041	36 x 60 x 41.5	102.55	5.11	<b>\$1241</b>	<b>\$188</b>
GSEH367241	36 x 72 x 41.5	112.6	5.63	<b>\$1375</b>	<b>\$195</b>
GSEH426041	42 x 60 x 41.5	117.32	5.92	<b>\$1392</b>	<b>\$273</b>
GSEH427241	42 x 72 x 41.5	129	6.53	<b>\$1549</b>	<b>\$300</b>
GSEH428441	42 x 84 x 41.5	140.6	12.72	<b>\$1706</b>	<b>\$477</b>
GSEH429641	42 x 96 x 41.5	152.24	14.06	<b>\$1837</b>	<b>\$504</b>
GSEH486041	48 x 60 x 41.5	130.1	6.74	<b>\$1552</b>	<b>\$374</b>
GSEH487241	48 x 72 x 41.5	143.5	7.43	<b>\$1726</b>	<b>\$443</b>
GSEH488441	48 x 84 x 41.5	156.74	14.35	<b>\$1839</b>	<b>\$469</b>
GSEH489641	48 x 96 x 41.5	170.06	15.85	<b>\$1980</b>	<b>\$512</b>

Laminate u-base support is 8"D with 7" inside clearance to wall. Access wall through 14.5"H x 9.5"W hinged door with touch latch in front panel of u-base support. U-base includes 0.5" adjustable glides. U-base side panels are tapered at the bottom to clear most baseboards. **Cut-out position available in position 2 only.**

- Metal bases sold separately. Compatible with **GRHB22H41** or **GSHB19H41** only, requires one base.

### Required Specifications

Top finish  
Base finish

### Optional Specifications

HP laminate  
Grommet position or power block cut-out

### Accessories

Power block

**HUDDLE BASES**      **MODEL #**      **DIMENSIONS**      **WT/LB.**      **CUBIC FT.**      **LIST PRICE**      **HP ADD**      **BCH / CHM**      **ACO / SBR**

W x D x H

**SELECT BASE COMPATIBLE WITH TOP HEIGHT:**

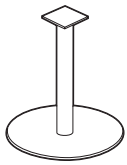

**22" Round Huddle Base**

GRHB22H28	22 x - x 28	60	10	<b>\$898</b>	N/A	<b>\$147</b>	<b>\$249</b>
GRHB22H35	22 x - x 35	62	12.7	<b>\$933</b>	N/A	<b>\$164</b>	<b>\$268</b>
GRHB22H41	22 x - x 40.5	63	14.2	<b>\$949</b>	N/A	<b>\$171</b>	<b>\$270</b>

**GRHB22H35** - counter height      **GRHB22H28** - seated height      **GRHB22H41** - bar height

Metal base ships fully assembled. Features 0.5" adjustable glides to level on uneven surfaces. Screws included with base for attaching to appropriate huddle table laminate pieces. See page 344 for available finishes.

Be sure to double check huddle table laminate units and metal bases are the same corresponding heights.

- Plated finishes are available at an upcharge.

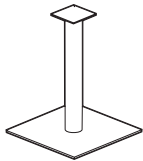

**18.5" Square Huddle Base**

GSHB19H28	18.5 x 18.5 x 28	55	6.94	<b>\$966</b>	N/A	<b>\$136</b>	<b>\$250</b>
GSHB19H35	18.5 x 18.5 x 35	57	8.8	<b>\$1022</b>	N/A	<b>\$151</b>	<b>\$287</b>
GSHB19H41	18.5 x 18.5 x 40.5	58	9.84	<b>\$1056</b>	N/A	<b>\$166</b>	<b>\$287</b>

**GSHB19H35** - counter height      **GSHB19H28** - seated height      **GSHB19H41** - bar height

Metal base ships fully assembled. Features 0.5" adjustable glides to level on uneven surfaces. Screws included with base for attaching to appropriate huddle table laminate pieces. See page 344 for available finishes.

Be sure to double check huddle table laminate units and metal bases are the same corresponding heights.

- Plated finishes are available at an upcharge.

**Required Specifications**

Finish

**Optional Specifications**