

# tables

## café, meeting and conference

Alba .....306  
Boardroom .....309

Swap.....321

## training

2gether .....358  
Bungee .....361  
Bungee SL .....379  
Duet .....411

Edventure.....414  
ConnecTABLES .....396  
Junction .....424  
Zook .....431

## reception and occasional

Citi .....443  
Cylinder and cube tables ..445  
River+ .....447

Sirena.....449  
Wind .....450  
Work tables .....452

---

# tables

## café, meeting and conference



Alba

306



Boardroom

309



Swap

321





Contemporary and stylish meeting tables with unique metal bases. Alba tables offer a variety of options to suit the needs of any office.

Tops are available in round and square shapes.

Sculpted four-legged base is available in Black (**BLK**) or Tungsten 2 (**TU2**).

Five edge options - self, bullnose, T-mold, built up and slant. Slant edge and metal base finishes are available in either Black (**BLK**) or Tungsten 2 (**TU2**).

No matter the size of the space or the style of the office, Global's laminate meeting tables will work in any setting.

Designed exclusively for Global by world renowned designer Zooney Chu.

#### Features and Benefits

- All tops and bases are assembled using a metal-to-metal connection.
- All tops are 1.125" thick.
- Bullnose edges available in Black or Grey.
- T-mold edge available in Black and Grey, also available in 22 coordinating laminate finishes.
- Self edge and built-up self edge available in same color as laminate finish.
- Slant edge is available in Black or Tungsten 2.
- All edges available on all tables.
- All metal bases are available in Black or Tungsten 2.

## GENERAL INFORMATION

- Designed by Zooney Chu.
- Ideal for small meeting spaces or cafeteria tables; 30" round or square top four-legged base.
- Five edge options: self (**SE**), bullnose (**BN**), T-mold (**TM**), built-up (**BU**) and slant (**ZS**).
- Sculpted four-legged base available in Black (**BLK**) or Tungsten 2 (**TU2**).
- For environmental certifications, please visit [globalfurnituregroup.com](http://globalfurnituregroup.com).

## CONSTRUCTION

- All tops are 1.125" thick with high performance, thermally fused laminate on both sides. A 1.75" built-up self edge is available on all models.
- All tops and bases use a metal-to-metal connection, allowing for easy installation.

## EDGE OPTIONS

- Self, bullnose, T-mold, built-up, and slant edges are available on all models. Corners of rectangular, square and boat tables ordered with T-mold or bullnose will be rounded.
- **Bullnose** edge is available in Black (**BLK**) only.
- **T-mold** edge is available in Black (**BLK**) or coordinating laminate finish (**ME**).
- **Slant** edge is available in Black (**BLK**) or Tungsten (**TU2**).
- **Self** edge and **built-up** edges are same color as laminate finish.

## LAMINATE FINISHES

|            |                 |            |                    |
|------------|-----------------|------------|--------------------|
| <b>ACJ</b> | Absolute Acajou | <b>FCL</b> | First Class        |
| <b>ASN</b> | Asian Night     | <b>NBL</b> | Noce Biondo        |
| <b>AWC</b> | Avant Cherry    | <b>NGL</b> | Noce Grigio        |
| <b>AWH</b> | Avant Honey     | <b>NEL</b> | Noce Leggero       |
| <b>BLK</b> | Black           | <b>NML</b> | Noce Medio         |
| <b>BZD</b> | Blizzard        | <b>QTM</b> | Quartered Mahogany |
| <b>BRC</b> | Brushed Cobalt  | <b>SBY</b> | Sheer Beauty       |
| <b>CMB</b> | Clear Maple     | <b>SDT</b> | Stonedust          |
| <b>CGY</b> | Custom Grey     | <b>SOG</b> | Storm Grey         |
| <b>DES</b> | Dark Espresso   | <b>WHE</b> | Walnut Heights     |
| <b>DWT</b> | Designer White  | <b>WHC</b> | White Chocolate    |
| <b>FAS</b> | Fashionista     | <b>WCR</b> | Winter Cherry      |

- The above laminate finishes are available in **high pressure**. Contact our Specials Department for a quote.
- If other than a Global standard laminate finish is preferred, contact our Specials Department. Information needed includes the name of the laminate manufacturer, color name, number and table model. You will then be given a quote for this special order.

# A ALBA™ TABLES

## ROUND TOPS



**Round Top - Four Leg Base**

| MODEL # | DIMENSIONS       | WT/LB. | CUBIC FT. | LIST PRICE   |
|---------|------------------|--------|-----------|--------------|
|         | <b>W x D x H</b> |        |           |              |
| C30CF   | 30 x - x 28.5    | 54.5   | 7.06      | <b>\$536</b> |

Please specify edge detail: self edge (**SE**), bullnose (**BN**), T-mold (**TM**), built-up (**BU**) or slant edge (**ZS**).  
Shipped easy to assemble in 2 cartons.

## SQUARE TOPS



**Square Top - Four Leg Base**

|       |                |      |      |              |
|-------|----------------|------|------|--------------|
| C30SF | 30 x 30 x 28.5 | 54.5 | 7.06 | <b>\$536</b> |
|-------|----------------|------|------|--------------|

Please specify edge detail: self edge (**SE**), bullnose (**BN**), T-mold (**TM**), built-up (**BU**) or slant edge (**ZS**).  
Shipped easy to assemble in 2 cartons.

**Required specifications**

Finish

Edge detail

## BOARDROOM & CAFETERIA TABLES



Sturdy and economically priced, Global boardroom and cafeteria tables are an excellent choice. All tables are made from thermally fused, high performance laminate and are easy to maintain.

Choose from four attractive table edges: self edge, bullnose, T-mold, or built-up self edge. Available in a variety of colors, all edge options are durable and wear-resistant.

Table tops are offered in six shapes - rectangular, racetrack, boat, elliptical, square and round - and a variety of bases including slab, cross, drum and arch. Add to this an impressive variety of laminate finishes that can be mixed and matched and you'll find Global can satisfy any and every business need.

From small meeting rooms to large boardrooms, from traditional to contemporary, Global's incredible range of table components, shapes, sizes and colors will enhance any office decor.

### Features and Benefits

- Tables 144" or less are standard in one piece.
- One piece tops can be cut into two pieces for an upcharge.
- All tops are 1.125" thick.
- Tops and bases boxed as appropriate.
- Custom finish laminate tables available as special order.
- Bullnose edges available in Black or Grey.
- T-mold edge available in Black, Grey or coordinating laminate finish.
- Self edge and built-up self edge available in same color as laminate finish.
- All edges available on all tables.
- Metal legs and bases are standard in Chrome - also available in Black or Grey.

# B BOARDROOM & CAFETERIA TABLES - NOTES

## GENERAL INFORMATION

- Practical and economical table solutions for cafeteria, meeting spaces and more.
- All tables are 29" high.
- Tops are thermally fused laminate with 45 lb. density particle board core.
- Multiple base styles available in thermally fused laminate or metal.
- Tables 72", 84", 96", 120", 144" are standard in one piece.
- One piece tops can be cut into two pieces for an upcharge.
- Six top shapes: rectangular, racetrack, boat, square, round, barrel and elliptical.
- Four edge options: self edge, bullnose, T-mold or built-up self edge.
- For environmental certifications, please visit [globalfurnituregroup.com](http://globalfurnituregroup.com).

## CONSTRUCTION

- All tables are 29" high and made of 45 lb. density particle board covered on both sides with high performance, thermally fused laminate. Table width is nominal.
- All tables with cross bases use Blum fasteners.
- Round and square tops up to 60" dia. are 1" thick; all other tops are 1.125" thick thick. Both thickness are in high performance, thermally fused laminate.
- Tops with built-up (BU) edge option have a 1.75" built-up self edge.
- Tops are crated and bases boxed or crated as appropriate.
- All tops are **PRE-MARKED** as to base location, and the slot and hook assembly method (on selected tables) allows for easy installation.
- All racetrack, boat and rectangular tables 144" and under are standard with two drum, slab, arch, 2-legged, or tubular bases and are priced accordingly.
- Custom table sizes must be quoted. Contact our Specials Department.

## LAMINATE FINISHES

|                            |                               |
|----------------------------|-------------------------------|
| <b>ACJ</b> Absolute Acajou | <b>FCL</b> First Class        |
| <b>ASN</b> Asian Night     | <b>NBL</b> Noce Biondo        |
| <b>AWC</b> Avant Cherry    | <b>NGL</b> Noce Grigio        |
| <b>AWH</b> Avant Honey     | <b>NEL</b> Noce Leggero       |
| <b>BLK</b> Black           | <b>NML</b> Noce Medio         |
| <b>BZD</b> Blizzard        | <b>QTM</b> Quartered Mahogany |
| <b>BRC</b> Brushed Cobalt  | <b>SBY</b> Sheer Beauty       |
| <b>CMB</b> Clear Maple     | <b>SDT</b> Stonedust          |
| <b>CGY</b> Custom Grey     | <b>SOG</b> Storm Grey         |
| <b>DES</b> Dark Espresso   | <b>WHE</b> Walnut Heights     |
| <b>DWT</b> Designer White  | <b>WHC</b> White Chocolate    |
| <b>FAS</b> Fashionista     | <b>WCR</b> Winter Cherry      |

- The above laminate finishes are also available in **high pressure laminate**. Contact our Specials Department for a quote.
- All tables with one or more drum bases require a minimum of 50 lbs. of sand in each base for stability. Sand is not included, to be sourced locally.

## METAL BASE FINISHES

- Available for CRRxx, CASxx, TCSxx, CARxx, TCRxx and CRSxx tables.

### Paint finishes

|                           |                     |
|---------------------------|---------------------|
| <b>TBL</b> Black          | <b>TIN</b> Ink      |
| <b>TBZ</b> Buzz Blue      | <b>TKA</b> Kalua    |
| <b>TCC</b> Cactus         | <b>TLA</b> Latte    |
| <b>TCR</b> Carrot         | <b>TMO</b> Mocha    |
| <b>TIV</b> Cloud          | <b>TNE</b> Nevada   |
| <b>TDW</b> Designer White | <b>TSN</b> Sand     |
| <b>TDJ</b> Dijon          | <b>TSR</b> Scarlet  |
| <b>TEG</b> Eggplant       | <b>TSH</b> Shadow   |
| <b>TFO</b> Fog            | <b>TOA</b> Toast    |
| <b>TFR</b> Frost          | <b>TTU</b> Tungsten |

### Plated finishes - upcharge applies

|                           |                        |
|---------------------------|------------------------|
| <b>ACO</b> Antique Copper | <b>CHM</b> Chrome      |
| <b>BCH</b> Brushed Chrome | <b>SBR</b> Satin Brass |

## EDGE OPTIONS

- Self, bullnose, T-mold and built-up edges are available on all models. Corners of rectangular, square and boat tables ordered with T-mold or bullnose will be rounded.
- **Bullnose** edge is available in Black (**BLK**) only.
- **T-mold** edge is available in Black (**BLK**) or coordinating laminate finish (**ME**) with upcharge (5%).
- **Self edge and built-up** edges are same color as laminate finish.

## GROMMETS

- Grommets available in standard table top locations (left, center or right). Order as: **FOG1, FOG2** or **FOG3**. **Add \$91**.
- Grommet hole dimensions are 3.25" wide x 1.875" deep.

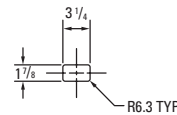

- Actual grommet locations will vary according to base selection.

## POWER BLOCK

- A power block (model **PMSPDM**) may be ordered on all worksurfaces.
- A power block is a rectangular worksurface power/data module with one electrical duplex receptacle and two data (RJ45) receptacles. 9' Black cord included. Power block dimensions are 6.5"W x 3.5"D x 2.75"H.
- Actual power block locations vary according to base selection. The locations will be left (E1), center (E2), and right (E3). **Example:** 8' table with drum base does not have a modesty panel, so the power block (E2) can be perfectly centered in the table. An 8' table with a slab base has the modesty panel, so the power block (E2) will be offset alongside the modesty panel.
- To purchase a power block, you must specify both the power block cut-out location and the power block model #. Order power block as **PMSPDM**. **Add \$268**.
- Power blocks are available in standard worksurface locations (left, center or right). Order as **E1, E2** or **E3**. **Add \$91**.



Power block **PMSPDM**. **Add \$268**.

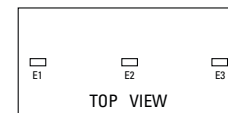

Specify location **E1, E2** or **E3**. **Add \$91**.

## SPECIFICATIONS

- Specifications marked with an \* are applicable to only those products which have the \* symbol beside the product name.

## SHIPPING

- Shipped easy to assemble.

## BASE SIZE CHART (table width is nominal)

### Round or Square Tops:

| Top | Slab | Drum | Arch | Cross | 4 Leg | Trumpet | Tube |
|-----|------|------|------|-------|-------|---------|------|
| 36" | N/A  | N/A  | N/A  | N/A   | 32"   | 24"     | 30"  |
| 42" | N/A  | 18"  | N/A  | 30"   | 32"   | 24"     | 30"  |
| 48" | N/A  | 24"  | N/A  | 30"   | 32"   | N/A     | 30"  |
| 60" | N/A  | 30"  | N/A  | 36"   | N/A   | N/A     | N/A  |

### Rectangular, Boat or Racetrack Tops:

| Top        | Slab | Drum | Arch | Cross | 2 Leg | Trumpet | Tube |
|------------|------|------|------|-------|-------|---------|------|
| 36" x 72"  | 24"  | 18"  | 24"  | N/A   | 32"   | N/A     | 30"  |
| 48" x 96"  | 28"  | 18"  | 28"  | N/A   | 32"   | N/A     | 30"  |
| 48" x 120" | 28"  | 24"  | 28"  | N/A   | 32"   | N/A     | 30"  |
| 48" x 144" | 28"  | 24"  | 28"  | N/A   | 32"   | N/A     | 30"  |

## TABLE NOTES - ESTIMATED CAPACITY

- Use the following to determine the size of a round table and the number of chairs needed for a conference area. All estimates are based on an average chair width of 23" with a 4" clearance between chairs. Adjust accordingly for a different chair size.

### NUMBER OF CHAIRS

| Top Size | Round | Square | Rectangular | Boat  | Racetrack | Elliptical |
|----------|-------|--------|-------------|-------|-----------|------------|
| 30 x 30  | 3     | 3      | N/A         | N/A   | N/A       | N/A        |
| 36 x 36  | 4     | 4      | N/A         | N/A   | N/A       | N/A        |
| 42 x 42  | 4     | 4      | N/A         | N/A   | N/A       | N/A        |
| 48 x 48  | 4     | 4      | N/A         | N/A   | N/A       | N/A        |
| 60 x 60  | 5     | 6      | N/A         | N/A   | N/A       | N/A        |
| 30 x 60  | N/A   | N/A    | 4-6         | 4-6   | 4-6       | 4          |
| 36 x 72  | N/A   | N/A    | 4-6         | 4-6   | 4-6       | 4          |
| 44 x 84  | N/A   | N/A    | 6-8         | 6-8   | 6-8       | 6          |
| 48 x 96  | N/A   | N/A    | 6-8         | 6-8   | 6-8       | 6          |
| 48 x 120 | N/A   | N/A    | 8-10        | 8-10  | 8-10      | 8          |
| 48 x 144 | N/A   | N/A    | 10-12       | 10-12 | 10-12     | 10         |
| 48 x 168 | N/A   | N/A    | 12-14       | 12-14 | 12-14     | 12         |
| 48 x 192 | N/A   | N/A    | 14-16       | 14-16 | 14-16     | 14         |
| 48 x 216 | N/A   | N/A    | 16-18       | 16-18 | 16-18     | 16         |
| 48 x 240 | N/A   | N/A    | 18-20       | 18-20 | 18-20     | 18         |
| 48 x 264 | N/A   | N/A    | 20-22       | 20-22 | 20-22     | 20         |
| 48 x 288 | N/A   | N/A    | 22-24       | 22-24 | 22-24     | 22         |

## BASE OPTIONS

### Laminate

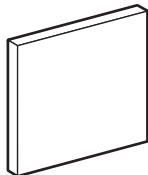

slab

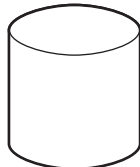

drum

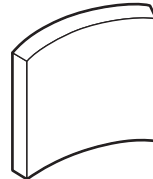

arch

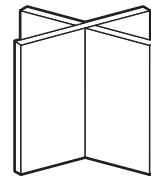

cross



self edge

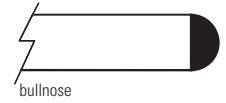

bullnose

### Metal

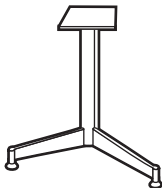

2-leg



4-leg

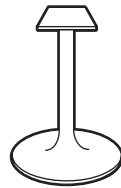

trumpet

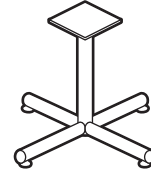

tube



T-mold

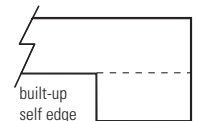

built-up self edge

T-mold matching edge available - add 5% upcharge.

## TABLE TOP STYLES



square

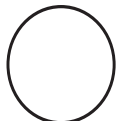

round

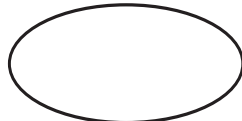

elliptical



racetrack

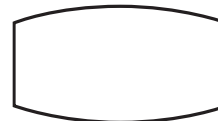

boat



rectangular



## B BOARDROOM & CAFETERIA TABLES

| ROUND TOPS | MODEL # | DIMENSIONS | WT/LB. | CUBIC FT. | LIST PRICE | BCH / CHM | ACO / SBR |
|------------|---------|------------|--------|-----------|------------|-----------|-----------|
|------------|---------|------------|--------|-----------|------------|-----------|-----------|

W x D x H

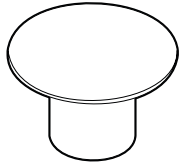

Round Top - Drum Base\*

|      |             |     |       |               |     |     |
|------|-------------|-----|-------|---------------|-----|-----|
| 42CZ | 42 x - x 29 | 150 | 12.5  | <b>\$1144</b> | N/A | N/A |
| 48CZ | 48 x - x 29 | 145 | 13.25 | <b>\$1264</b> | N/A | N/A |
| 60CZ | 60 x - x 29 | 194 | 19    | <b>\$1662</b> | N/A | N/A |

Please specify edge detail: self edge (**SE**), bullnose (**BN**), T-mold (**TM**) or built-up (**BU**).

Shipped easy to assemble in 2 cartons.

- All drum bases require approximately 50 lbs. of sand in each base for adequate stability. Sand is not included.



Round Top - Three Legs\*

|     |             |     |      |               |     |     |
|-----|-------------|-----|------|---------------|-----|-----|
| 48C | 48 x - x 29 | 99  | 6.5  | <b>\$1309</b> | N/A | N/A |
| 60C | 60 x - x 29 | 140 | 14.4 | <b>\$1534</b> | N/A | N/A |

Please specify edge detail: self edge (**SE**), bullnose (**BN**), T-mold (**TM**) or built-up (**BU**).

Shipped easy to assemble in 2 cartons.



Round Top - Three Tubular Legs\*

|      |             |     |      |               |     |     |
|------|-------------|-----|------|---------------|-----|-----|
| 60RC | 60 x - x 29 | 140 | 14.4 | <b>\$1769</b> | N/A | N/A |
|------|-------------|-----|------|---------------|-----|-----|

Please specify edge detail: self edge (**SE**), bullnose (**BN**), T-mold (**TM**) or built-up (**BU**).

Shipped easy to assemble in 2 cartons.



Round Top - Four Leg Base

|       |               |    |       |              |             |              |
|-------|---------------|----|-------|--------------|-------------|--------------|
| CAR30 | 30 x - x 29.5 | 35 | 9.49  | <b>\$431</b> | <b>\$40</b> | <b>\$242</b> |
| CAR36 | 36 x - x 29.5 | 42 | 12.31 | <b>\$538</b> | <b>\$73</b> | <b>\$273</b> |
| CAR42 | 42 x - x 29.5 | 52 | 12.61 | <b>\$621</b> | <b>\$73</b> | <b>\$273</b> |

Please specify edge detail: self edge (**SE**), bullnose (**BN**), T-mold (**TM**) or built-up (**BU**).

Shipped easy to assemble in 2 cartons.

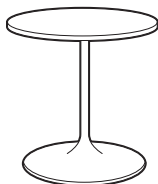

Round Top - Trumpet Base

|       |               |    |       |              |             |              |
|-------|---------------|----|-------|--------------|-------------|--------------|
| TCR24 | 24 x - x 29.5 | 30 | 9.09  | <b>\$497</b> | <b>\$73</b> | <b>\$299</b> |
| TCR30 | 30 x - x 29.5 | 35 | 9.49  | <b>\$590</b> | <b>\$73</b> | <b>\$299</b> |
| TCR36 | 36 x - x 29.5 | 42 | 12.31 | <b>\$707</b> | <b>\$73</b> | <b>\$299</b> |
| TCR42 | 42 x - x 29.5 | 52 | 12.61 | <b>\$787</b> | <b>\$73</b> | <b>\$299</b> |

Please specify edge detail: self edge (**SE**), bullnose (**BN**), T-mold (**TM**) or built-up (**BU**).

Shipped easy to assemble in 2 cartons.

### Required specifications

Top finish  
Base finish  
Edge detail

### Optional specifications

Grommet\*  
Power block cut-out\*

### Accessories

Power block\*

## ROUND TOPS



**Round Top - Tubular Base**

| MODEL # | DIMENSIONS<br>W x D x H | WT/LB. | CUBIC FT. | LIST PRICE   | BCH / CHM   | ACO / SBR    |
|---------|-------------------------|--------|-----------|--------------|-------------|--------------|
| CRR24   | 24 x - x 29.5           | 30     | 9.09      | <b>\$417</b> | <b>\$78</b> | <b>\$327</b> |
| CRR30   | 30 x - x 29.5           | 35     | 9.49      | <b>\$526</b> | <b>\$78</b> | <b>\$327</b> |
| CRR36   | 36 x - x 29.5           | 42     | 12.31     | <b>\$630</b> | <b>\$78</b> | <b>\$327</b> |
| CRR42   | 42 x - x 29.5           | 52     | 12.61     | <b>\$718</b> | <b>\$78</b> | <b>\$327</b> |
| CRR48   | 48 x - x 29.5           | 10     | 13.26     | <b>\$863</b> | <b>\$78</b> | <b>\$327</b> |

Please specify edge detail: self edge (**SE**), bullnose (**BN**), T-mold (**TM**) or built-up (**BU**).  
Shipped easy to assemble in 2 cartons.



**Round Top - Cross Base\***

|      |             |     |      |               |     |     |
|------|-------------|-----|------|---------------|-----|-----|
| 42CX | 42 x - x 29 | 100 | 3.5  | <b>\$1144</b> | N/A | N/A |
| 48CX | 48 x - x 29 | 120 | 4.25 | <b>\$1264</b> | N/A | N/A |
| 60CX | 60 x - x 29 | 144 | 6.2  | <b>\$1662</b> | N/A | N/A |

Please specify edge detail: self edge (**SE**), bullnose (**BN**), T-mold (**TM**) or built-up (**BU**).  
Shipped easy to assemble in 2 cartons.

## SQUARE TOPS

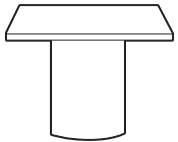

**Square Top - Drum Base\***

|      |              |     |       |               |     |     |
|------|--------------|-----|-------|---------------|-----|-----|
| 42SZ | 42 x 42 x 29 | 100 | 12.5  | <b>\$1144</b> | N/A | N/A |
| 48SZ | 48 x 48 x 29 | 160 | 13.16 | <b>\$1264</b> | N/A | N/A |
| 60SZ | 60 x 60 x 29 | 190 | 19    | <b>\$1662</b> | N/A | N/A |

Please specify edge detail: self edge (**SE**), bullnose (**BN**), T-mold (**TM**) or built-up (**BU**).  
Shipped easy to assemble in 2 cartons.

- All drum bases require approximately 50 lbs. of sand in each base for adequate stability. Sand is not included.

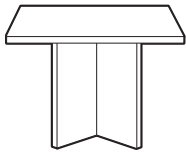

**Square Top - Cross Base\***

|      |              |     |      |               |     |     |
|------|--------------|-----|------|---------------|-----|-----|
| 42SH | 42 x 42 x 29 | 100 | 3.5  | <b>\$1144</b> | N/A | N/A |
| 48SH | 48 x 48 x 29 | 120 | 4.25 | <b>\$1264</b> | N/A | N/A |
| 60SH | 60 x 60 x 29 | 144 | 6.2  | <b>\$1662</b> | N/A | N/A |

Please specify edge detail: self edge (**SE**), bullnose (**BN**), T-mold (**TM**) or built-up (**BU**).  
Shipped easy to assemble in 2 cartons.



**Square Top - Four Leg Base**

|       |                |    |       |              |             |              |
|-------|----------------|----|-------|--------------|-------------|--------------|
| CAS30 | 30 x 30 x 29.5 | 37 | 9.49  | <b>\$431</b> | <b>\$40</b> | <b>\$242</b> |
| CAS36 | 36 x 36 x 29.5 | 44 | 12.31 | <b>\$538</b> | <b>\$73</b> | <b>\$273</b> |
| CAS42 | 42 x 42 x 29.5 | 54 | 12.61 | <b>\$621</b> | <b>\$73</b> | <b>\$273</b> |

Please specify edge detail: self edge (**SE**), bullnose (**BN**), T-mold (**TM**) or built-up (**BU**).  
Shipped easy to assemble in 2 cartons.



**Square Top - Trumpet Base**

|       |                |    |       |              |             |              |
|-------|----------------|----|-------|--------------|-------------|--------------|
| TCS24 | 24 x 24 x 29.5 | 32 | 9.09  | <b>\$497</b> | <b>\$73</b> | <b>\$299</b> |
| TCS30 | 30 x 30 x 29.5 | 37 | 9.49  | <b>\$590</b> | <b>\$73</b> | <b>\$299</b> |
| TCS36 | 36 x 36 x 29.5 | 44 | 12.31 | <b>\$707</b> | <b>\$73</b> | <b>\$299</b> |
| TCS42 | 42 x 42 x 29.5 | 54 | 12.61 | <b>\$787</b> | <b>\$73</b> | <b>\$299</b> |

Please specify edge detail: self edge (**SE**), bullnose (**BN**), T-mold (**TM**) or built-up (**BU**).  
Shipped easy to assemble in 2 cartons.

### Required specifications

Top finish  
Base finish  
Edge detail

### Optional specifications

Grommet\*  
Power block cut-out\*

### Accessories

Power block\*

## B BOARDROOM & CAFETERIA TABLES

### SQUARE TOPS



Square Top - Tubular Base

| MODEL # | DIMENSIONS<br>W x D x H | WT/LB. | CUBIC FT. | LIST PRICE   | BCH / CHM   | ACO / SBR    |
|---------|-------------------------|--------|-----------|--------------|-------------|--------------|
| CRS30   | 30 x 30 x 29.5          | 37     | 9.49      | <b>\$526</b> | <b>\$78</b> | <b>\$327</b> |
| CRS36   | 36 x 36 x 29.5          | 44     | 12.31     | <b>\$630</b> | <b>\$78</b> | <b>\$327</b> |
| CRS42   | 42 x 42 x 29.5          | 54     | 12.61     | <b>\$718</b> | <b>\$78</b> | <b>\$327</b> |

Please specify edge detail: self edge (**SE**), bullnose (**BN**), T-mold (**TM**) or built-up (**BU**).  
Shipped easy to assemble in 2 cartons.

### RECTANGULAR TOPS

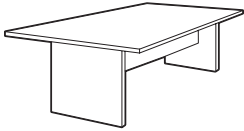

Rectangular Top - Two Slab Bases\*

|        |              |     |     |               |     |     |
|--------|--------------|-----|-----|---------------|-----|-----|
| CT6RX  | 72 x 36 x 29 | 114 | 4.6 | <b>\$1811</b> | N/A | N/A |
| CT8RX  | 96 x 36 x 29 | 144 | 7.3 | <b>\$1945</b> | N/A | N/A |
| CT8WRX | 96 x 48 x 29 | 154 | 7.3 | <b>\$2064</b> | N/A | N/A |

Please specify edge detail: self edge (**SE**), bullnose (**BN**), T-mold (**TM**) or built-up (**BU**).  
Shipped easy to assemble in 3 cartons (except CT6RX shipped easy to assemble in 2 cartons).

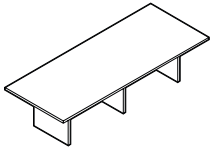

Rectangular Top - Three Slab Bases\*

|         |               |     |      |               |     |     |
|---------|---------------|-----|------|---------------|-----|-----|
| CT10RX  | 120 x 36 x 29 | 216 | 8.25 | <b>\$2968</b> | N/A | N/A |
| CT10WRX | 120 x 48 x 29 | 251 | 8.75 | <b>\$3330</b> | N/A | N/A |
| CT12WRX | 144 x 48 x 29 | 276 | 10.6 | <b>\$3499</b> | N/A | N/A |

Please specify edge detail: self edge (**SE**), bullnose (**BN**), T-mold (**TM**) or built-up (**BU**).  
Shipped easy to assemble in 2 cartons.

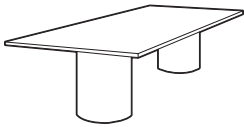

Rectangular Top - Two Drum Bases\*

|        |              |     |       |               |     |     |
|--------|--------------|-----|-------|---------------|-----|-----|
| CT6RZ  | 72 x 36 x 29 | 164 | 15.32 | <b>\$2064</b> | N/A | N/A |
| CT8RZ  | 96 x 36 x 29 | 194 | 16.35 | <b>\$2193</b> | N/A | N/A |
| CT8WRZ | 96 x 48 x 29 | 204 | 17.7  | <b>\$2324</b> | N/A | N/A |

Please specify edge detail: self edge (**SE**), bullnose (**BN**), T-mold (**TM**) or built-up (**BU**).  
Shipped easy to assemble in 2 cartons.  
• All drum bases require approximately 50 lbs. of sand in each base for adequate stability. Sand is not included.

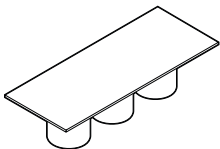

Rectangular Top - Three Drum Bases\*

|         |               |     |       |               |     |     |
|---------|---------------|-----|-------|---------------|-----|-----|
| CT10RZ  | 120 x 36 x 29 | 291 | 23.65 | <b>\$3206</b> | N/A | N/A |
| CT10WRZ | 120 x 48 x 29 | 326 | 25.3  | <b>\$3563</b> | N/A | N/A |
| CT12WRZ | 144 x 48 x 29 | 351 | 26.67 | <b>\$3766</b> | N/A | N/A |

Please specify edge detail: self edge (**SE**), bullnose (**BN**), T-mold (**TM**) or built-up (**BU**).  
Shipped easy to assemble in 2 cartons.  
• All drum bases require approximately 50 lbs. of sand in each base for adequate stability. Sand is not included.

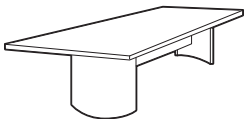

Rectangular Top - Two Arch Bases\*

|         |               |     |       |               |     |     |
|---------|---------------|-----|-------|---------------|-----|-----|
| CT6RA   | 72 x 36 x 29  | 114 | 5.6   | <b>\$2064</b> | N/A | N/A |
| CT8RA   | 96 x 36 x 29  | 144 | 7.1   | <b>\$2193</b> | N/A | N/A |
| CT8WRA  | 96 x 48 x 29  | 154 | 10.15 | <b>\$2324</b> | N/A | N/A |
| CT10RA  | 120 x 36 x 29 | 174 | 9.85  | <b>\$3206</b> | N/A | N/A |
| CT10WRA | 120 x 48 x 29 | 184 | 11.5  | <b>\$3563</b> | N/A | N/A |
| CT12WRA | 144 x 48 x 29 | 194 | 13.25 | <b>\$3766</b> | N/A | N/A |

Please specify edge detail: self edge (**SE**), bullnose (**BN**), T-mold (**TM**) or built-up (**BU**).  
Shipped easy to assemble in 3 cartons (except CT6RA shipped easy to assemble in 2 cartons).

#### Required specifications

Top finish  
Base finish (square tops)  
Edge detail

#### Optional specifications

Grommet\*  
Power block cut-out\*

#### Accessories

Power block\*

## RECTANGULAR TOPS



**Rectangular Top - Two Legs**

| MODEL # | DIMENSIONS<br>W x D x H | WT/LB. | CUBIC FT. | LIST PRICE    |
|---------|-------------------------|--------|-----------|---------------|
| CT6R    | 72 x 36 x 29            | 110    | 13.75     | <b>\$1202</b> |
| CT8R    | 96 x 36 x 29            | 140    | 14.75     | <b>\$1357</b> |
| CT8WR   | 96 x 48 x 29            | 150    | 16.25     | <b>\$1490</b> |

Please specify edge detail: self edge (**SE**), bullnose (**BN**), T-mold (**TM**) or built-up (**BU**).  
Shipped easy to assemble in 2 cartons.

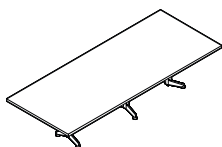

**Rectangular Top - Three Legs**

|        |               |     |       |               |
|--------|---------------|-----|-------|---------------|
| CT10R  | 120 x 36 x 29 | 210 | 15.75 | <b>\$1921</b> |
| CT10WR | 120 x 48 x 29 | 245 | 17.5  | <b>\$2321</b> |
| CT12WR | 144 x 48 x 29 | 270 | 19    | <b>\$2510</b> |

Please specify edge detail: self edge (**SE**), bullnose (**BN**), T-mold (**TM**) or built-up (**BU**).  
Shipped easy to assemble in 2 cartons.



**Rectangular Top - Two Tubular Legs**

|       |              |     |       |               |
|-------|--------------|-----|-------|---------------|
| CR6R  | 72 x 36 x 29 | 110 | 13.75 | <b>\$1357</b> |
| CR8R  | 96 x 36 x 29 | 10  | 14.75 | <b>\$1521</b> |
| CR8WR | 96 x 48 x 29 | 150 | 16.25 | <b>\$1648</b> |

Please specify edge detail: self edge (**SE**), bullnose (**BN**), T-mold (**TM**) or built-up (**BU**).  
Shipped easy to assemble in 2 cartons.

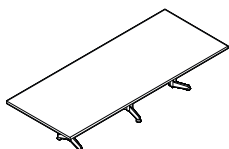

**Rectangular Top - Three Tubular Legs**

|        |               |     |       |               |
|--------|---------------|-----|-------|---------------|
| CR10R  | 120 x 36 x 29 | 210 | 15.75 | <b>\$2151</b> |
| CR10WR | 120 x 48 x 29 | 245 | 17.5  | <b>\$2558</b> |
| CR12WR | 144 x 48 x 29 | 270 | 19    | <b>\$2748</b> |

Please specify edge detail: self edge (**SE**), bullnose (**BN**), T-mold (**TM**) or built-up (**BU**).  
Shipped easy to assemble in 2 cartons.

## BOAT TOPS



**Boat Top - Two Slab Bases**

|        |              |     |     |               |
|--------|--------------|-----|-----|---------------|
| CT6BX  | 72 x 36 x 29 | 114 | 4.6 | <b>\$1811</b> |
| CT8BX  | 96 x 36 x 29 | 144 | 7.3 | <b>\$1945</b> |
| CT8WBX | 96 x 48 x 29 | 154 | 7.3 | <b>\$2064</b> |

Please specify edge detail: self edge (**SE**), bullnose (**BN**), T-mold (**TM**) or built-up (**BU**).  
Shipped easy to assemble in 3 cartons (except CT6BX shipped easy to assemble in 2 cartons).

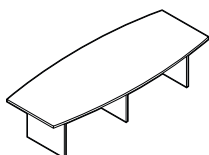

**Boat Top - Three Slab Bases**

|         |               |     |      |               |
|---------|---------------|-----|------|---------------|
| CT10BX  | 120 x 36 x 29 | 216 | 8.25 | <b>\$2968</b> |
| CT10WBX | 120 x 48 x 29 | 251 | 8.25 | <b>\$3330</b> |
| CT12WBX | 144 x 48 x 29 | 276 | 10.6 | <b>\$3499</b> |

Please specify edge detail: self edge (**SE**), bullnose (**BN**), T-mold (**TM**) or built-up (**BU**).  
Shipped easy to assemble in 3 cartons.

### Required specifications

Top finish  
Base finish (rectangular tops)  
Edge detail

### Optional specifications

Grommet  
Power block cut-out

### Accessories

Power block

## B BOARDROOM & CAFETERIA TABLES

### BOAT TOPS

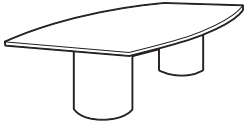

**Boat Top - Two Drum Bases**

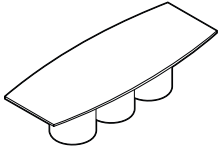

**Boat Top - Three Drum Bases**

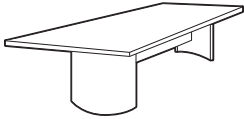

**Boat Top - Two Arch Bases**



**Boat Top - Two Legs\***

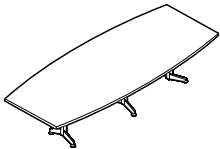

**Boat Top - Three Legs\***



**Boat Top - Two Tubular Legs\***

| MODEL # | DIMENSIONS | WT/LB. | CUBIC FT. | LIST PRICE |
|---------|------------|--------|-----------|------------|
|---------|------------|--------|-----------|------------|

**W x D x H**

|        |              |     |       |               |
|--------|--------------|-----|-------|---------------|
| CT6BZ  | 72 x 36 x 29 | 164 | 15.32 | <b>\$1993</b> |
| CT8BZ  | 96 x 36 x 29 | 194 | 16.35 | <b>\$2193</b> |
| CT8WBZ | 96 x 48 x 29 | 204 | 17.7  | <b>\$2244</b> |

Please specify edge detail: self edge (**SE**), bullnose (**BN**), T-mold (**TM**) or built-up (**BU**).

Shipped easy to assemble in 2 cartons.

- All drum bases require approximately 50 lbs. of sand in each base for adequate stability. Sand is not included.

|         |               |     |       |               |
|---------|---------------|-----|-------|---------------|
| CT10BZ  | 120 x 36 x 29 | 291 | 23.65 | <b>\$3206</b> |
| CT10WBZ | 120 x 48 x 29 | 326 | 25.3  | <b>\$3563</b> |
| CT12WBZ | 144 x 48 x 29 | 351 | 26.67 | <b>\$3734</b> |

Please specify edge detail: self edge (**SE**), bullnose (**BN**), T-mold (**TM**) or built-up (**BU**).

Shipped easy to assemble in 2 cartons.

- All drum bases require approximately 50 lbs. of sand in each base for adequate stability. Sand is not included.

|         |               |     |       |               |
|---------|---------------|-----|-------|---------------|
| CT6BA   | 72 x 36 x 29  | 114 | 5.6   | <b>\$2064</b> |
| CT8BA   | 96 x 36 x 29  | 144 | 7.1   | <b>\$2193</b> |
| CT8WBA  | 96 x 48 x 29  | 154 | 10.15 | <b>\$2324</b> |
| CT10BA  | 120 x 36 x 29 | 174 | 9.85  | <b>\$3206</b> |
| CT10WBA | 120 x 48 x 29 | 184 | 11.5  | <b>\$3563</b> |
| CT12WBA | 144 x 48 x 29 | 194 | 13.25 | <b>\$3734</b> |

Please specify edge detail: self edge (**SE**), bullnose (**BN**), T-mold (**TM**) or built-up (**BU**).

Shipped easy to assemble in 3 cartons, (except CT6BA shipped easy to assemble in 2 cartons).

|       |              |     |       |               |
|-------|--------------|-----|-------|---------------|
| CT6B  | 72 x 36 x 29 | 110 | 13.75 | <b>\$1202</b> |
| CT8B  | 96 x 36 x 29 | 140 | 14.75 | <b>\$1357</b> |
| CT8WB | 96 x 48 x 29 | 150 | 16.25 | <b>\$1490</b> |

Please specify edge detail: self edge (**SE**), bullnose (**BN**), T-mold (**TM**) or built-up (**BU**).

Shipped easy to assemble in 2 cartons.

|        |               |     |       |               |
|--------|---------------|-----|-------|---------------|
| CT10B  | 120 x 36 x 29 | 210 | 15.75 | <b>\$1921</b> |
| CT10WB | 120 x 48 x 29 | 245 | 17.5  | <b>\$2321</b> |
| CT12WB | 144 x 48 x 29 | 270 | 19    | <b>\$2510</b> |

Please specify edge detail: self edge (**SE**), bullnose (**BN**), T-mold (**TM**) or built-up (**BU**).

Shipped easy to assemble in 2 cartons.

|       |              |     |       |               |
|-------|--------------|-----|-------|---------------|
| CR6B  | 72 x 36 x 29 | 110 | 13.75 | <b>\$1357</b> |
| CR8B  | 96 x 36 x 29 | 140 | 14.75 | <b>\$1503</b> |
| CR8WB | 96 x 48 x 29 | 150 | 16.25 | <b>\$1648</b> |

Please specify edge detail: self edge (**SE**), bullnose (**BN**), T-mold (**TM**) or built-up (**BU**).

Shipped easy to assemble in 2 cartons.

#### Required specifications

Top finish  
Leg finish\*  
Edge detail

#### Optional specifications

Grommet  
Power block cut-out

#### Accessories

Power block

## BOAT TOPS



**Boat Top - Three Tubular Legs\***

| MODEL # | DIMENSIONS<br>W x D x H | WT/LB. | CUBIC FT. | LIST PRICE    |
|---------|-------------------------|--------|-----------|---------------|
| CR10B   | 120 x 36 x 29           | 210    | 20        | <b>\$2151</b> |
| CR10WB  | 120 x 48 x 29           | 245    | 23        | <b>\$2558</b> |
| CR12WB  | 144 x 48 x 29           | 270    | 19        | <b>\$2748</b> |

Please specify edge detail: self edge (**SE**), bullnose (**BN**), T-mold (**TM**) or built-up (**BU**).  
Shipped easy to assemble in 2 cartons.

## RACETRACK TOPS

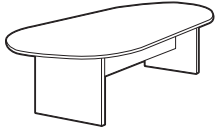

**Racetrack Top - Two Slab Bases**

|       |              |     |     |               |
|-------|--------------|-----|-----|---------------|
| RT6X  | 72 x 36 x 29 | 114 | 4.6 | <b>\$1811</b> |
| RT8X  | 96 x 36 x 29 | 144 | 7.3 | <b>\$1945</b> |
| RT8WX | 96 x 48 x 29 | 154 | 7.3 | <b>\$2064</b> |

Please specify edge detail: self edge (**SE**), bullnose (**BN**), T-mold (**TM**) or built-up (**BU**).  
Shipped easy to assemble in 3 cartons (except RT6X shipped easy to assemble in 2 cartons).

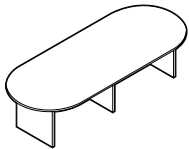

**Racetrack Top - Three Slab Bases**

|        |               |     |      |               |
|--------|---------------|-----|------|---------------|
| RT10X  | 120 x 36 x 29 | 216 | 8.25 | <b>\$2968</b> |
| RT10WX | 120 x 48 x 29 | 251 | 8.75 | <b>\$3330</b> |
| RT12WX | 144 x 48 x 29 | 276 | 10.6 | <b>\$3499</b> |

Please specify edge detail: self edge (**SE**), bullnose (**BN**), T-mold (**TM**) or built-up (**BU**).  
Shipped easy to assemble in 3 cartons.

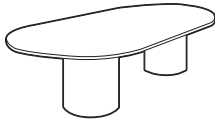

**Racetrack Top - Two Drum Bases**

|       |              |     |       |               |
|-------|--------------|-----|-------|---------------|
| RT6Z  | 72 x 36 x 29 | 164 | 15.32 | <b>\$2064</b> |
| RT8Z  | 96 x 36 x 29 | 194 | 16.35 | <b>\$2193</b> |
| RT8WZ | 96 x 48 x 29 | 204 | 17.7  | <b>\$2324</b> |

Please specify edge detail: self edge (**SE**), bullnose (**BN**), T-mold (**TM**) or built-up (**BU**).  
Shipped easy to assemble in 2 cartons.

- All drum bases require approximately 50 lbs. of sand in each base for adequate stability. Sand is not included.

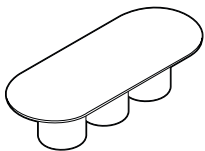

**Racetrack Top - Three Drum Bases**

|        |               |     |       |               |
|--------|---------------|-----|-------|---------------|
| RT10Z  | 120 x 36 x 29 | 291 | 23.65 | <b>\$3206</b> |
| RT10WZ | 120 x 48 x 29 | 326 | 25.3  | <b>\$3563</b> |
| RT12WZ | 144 x 48 x 29 | 351 | 26.67 | <b>\$3734</b> |

Please specify edge detail: self edge (**SE**), bullnose (**BN**), T-mold (**TM**) or built-up (**BU**).  
Shipped easy to assemble in 3 cartons.

- All drum bases require approximately 50 lbs. of sand in each base for adequate stability. Sand is not included.

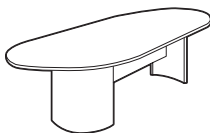

**Racetrack Top - Two Arch Bases**

|        |               |     |       |               |
|--------|---------------|-----|-------|---------------|
| RT6A   | 72 x 36 x 29  | 114 | 5.6   | <b>\$1993</b> |
| RT8A   | 96 x 36 x 29  | 144 | 7.1   | <b>\$2193</b> |
| RT8WA  | 96 x 48 x 29  | 154 | 10.15 | <b>\$2244</b> |
| RT10A  | 120 x 36 x 29 | 174 | 9.85  | <b>\$3206</b> |
| RT10WA | 120 x 48 x 29 | 184 | 11.5  | <b>\$3563</b> |
| RT12WA | 144 x 48 x 29 | 194 | 13.25 | <b>\$3734</b> |

Please specify edge detail: self edge (**SE**), bullnose (**BN**), T-mold (**TM**) or built-up (**BU**).  
Shipped easy to assemble in 3 cartons (except RT6A shipped easy to assemble in 2 cartons).

### Required specifications

Top finish  
Leg finish\*  
Edge detail

### Optional specifications

Grommet  
Power block cut-out

### Accessories

Power block

## B BOARDROOM & CAFETERIA TABLES

### RACETRACK TOPS



**Racetrack Top - Two Legs\***

| MODEL # | DIMENSIONS<br>W x D x H | WT/LB. | CUBIC FT. | LIST PRICE    |
|---------|-------------------------|--------|-----------|---------------|
| RT6     | 72 x 36 x 29            | 110    | 13.75     | <b>\$1202</b> |
| RT8     | 96 x 36 x 29            | 140    | 14.75     | <b>\$1357</b> |
| RT8W    | 96 x 48 x 29            | 150    | 16.25     | <b>\$1490</b> |

Please specify edge detail: self edge (**SE**), bullnose (**BN**), T-mold (**TM**) or built-up (**BU**).  
Shipped easy to assemble in 2 cartons.

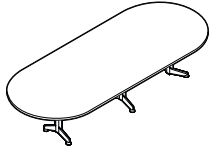

**Racetrack Top - Three Legs\***

|       |               |     |       |               |
|-------|---------------|-----|-------|---------------|
| RT10  | 120 x 36 x 29 | 210 | 15.75 | <b>\$1921</b> |
| RT10W | 120 x 48 x 29 | 245 | 17.5  | <b>\$2321</b> |
| RT12W | 144 x 48 x 29 | 270 | 19    | <b>\$2510</b> |

Please specify edge detail: self edge (**SE**), bullnose (**BN**), T-mold (**TM**) or built-up (**BU**).  
Shipped easy to assemble in 2 cartons.



**Racetrack Top - Two Tubular Legs\***

|       |              |     |       |               |
|-------|--------------|-----|-------|---------------|
| RT6R  | 72 x 36 x 29 | 110 | 13.75 | <b>\$1357</b> |
| RT8R  | 96 x 36 x 29 | 140 | 14.75 | <b>\$1503</b> |
| RT8WR | 96 x 48 x 29 | 150 | 16.25 | <b>\$1648</b> |

Please specify edge detail: self edge (**SE**), bullnose (**BN**), T-mold (**TM**) or built-up (**BU**).  
Shipped easy to assemble in 2 cartons.



**Racetrack Top - Three Tubular Legs\***

|        |               |     |       |               |
|--------|---------------|-----|-------|---------------|
| RT10R  | 120 x 36 x 29 | 210 | 15.75 | <b>\$2151</b> |
| RT10WR | 120 x 48 x 29 | 245 | 17.5  | <b>\$2558</b> |
| RT12WR | 144 x 48 x 29 | 270 | 19    | <b>\$2748</b> |

Please specify edge detail: self edge (**SE**), bullnose (**BN**), T-mold (**TM**) or built-up (**BU**).  
Shipped easy to assemble in 2 cartons.

### ELLIPTICAL TOPS

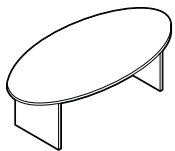

**Elliptical Top - Two Slab Bases**

|       |              |     |     |               |
|-------|--------------|-----|-----|---------------|
| EL6X  | 72 x 36 x 29 | 114 | 4.6 | <b>\$1811</b> |
| EL8X  | 96 x 36 x 29 | 144 | 7.3 | <b>\$1945</b> |
| EL8WX | 96 x 48 x 29 | 154 | 7.3 | <b>\$2064</b> |

Please specify edge detail: self edge (**SE**), bullnose (**BN**), T-mold (**TM**) or built-up (**BU**).  
Shipped easy to assemble in 3 cartons (except EL6X shipped easy to assemble in 2 cartons).

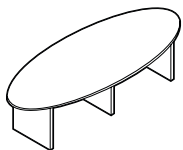

**Elliptical Top - Three Slab Bases**

|        |               |     |      |               |
|--------|---------------|-----|------|---------------|
| EL10X  | 120 x 36 x 29 | 216 | 8.25 | <b>\$2968</b> |
| EL10WX | 120 x 48 x 29 | 251 | 8.75 | <b>\$3330</b> |
| EL12WX | 144 x 48 x 29 | 276 | 10.6 | <b>\$3499</b> |

Please specify edge detail: self edge (**SE**), bullnose (**BN**), T-mold (**TM**) or built-up (**BU**).  
Shipped easy to assemble in 2 cartons.

#### Required specifications

Top finish  
Leg finish\*  
Edge detail

#### Optional specifications

Grommet  
Power block cut-out

#### Accessories

Power block

| ELLIPTICAL TOPS | MODEL # | DIMENSIONS | WT/LB. | CUBIC FT. | LIST PRICE |
|-----------------|---------|------------|--------|-----------|------------|
|-----------------|---------|------------|--------|-----------|------------|

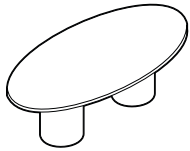

**Elliptical Top - Two Drum Bases**

|       | W x D x H    |     |       |               |  |
|-------|--------------|-----|-------|---------------|--|
| EL6Z  | 72 x 36 x 29 | 164 | 15.32 | <b>\$2064</b> |  |
| EL8Z  | 96 x 36 x 29 | 194 | 16.35 | <b>\$2193</b> |  |
| EL8WZ | 96 x 48 x 29 | 204 | 17.7  | <b>\$2324</b> |  |

Please specify edge detail: self edge (**SE**), bullnose (**BN**), T-mold (**TM**) or built-up (**BU**).  
 Shipped easy to assemble in 2 cartons.  
 • All drum bases require approximately 50 lbs. of sand in each base for adequate stability. Sand is not included.

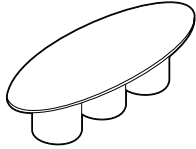

**Elliptical Top - Three Drum Bases**

|        |               |     |       |               |  |
|--------|---------------|-----|-------|---------------|--|
| EL10Z  | 120 x 36 x 29 | 291 | 23.65 | <b>\$3206</b> |  |
| EL10WZ | 120 x 48 x 29 | 326 | 25.3  | <b>\$3563</b> |  |
| EL12WZ | 144 x 48 x 29 | 351 | 26.67 | <b>\$3734</b> |  |

Please specify edge detail: self edge (**SE**), bullnose (**BN**), T-mold (**TM**) or built-up (**BU**).  
 Shipped easy to assemble in 2 cartons.  
 • All drum bases require approximately 50 lbs. of sand in each base for adequate stability. Sand is not included.

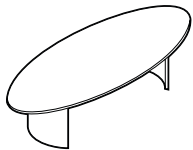

**Elliptical Top - Two Arch Bases**

|        |               |     |       |               |  |
|--------|---------------|-----|-------|---------------|--|
| EL6A   | 72 x 36 x 29  | 114 | 5.6   | <b>\$2064</b> |  |
| EL8A   | 96 x 36 x 29  | 144 | 7.1   | <b>\$2193</b> |  |
| EL8WA  | 96 x 48 x 29  | 154 | 10.15 | <b>\$2324</b> |  |
| EL10A  | 120 x 36 x 29 | 174 | 9.85  | <b>\$3206</b> |  |
| EL10WA | 120 x 48 x 29 | 184 | 11.5  | <b>\$3563</b> |  |
| EL12WA | 144 x 48 x 29 | 194 | 13.25 | <b>\$3734</b> |  |

Please specify edge detail: self edge (**SE**), bullnose (**BN**), T-mold (**TM**) or built-up (**BU**).  
 Shipped easy to assemble in 3 cartons (except EL6A shipped easy to assemble in 2 cartons).

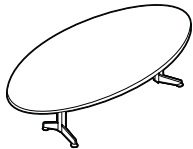

**Elliptical Top - Two Legs\***

|      |              |     |       |               |  |
|------|--------------|-----|-------|---------------|--|
| EL6  | 72 x 36 x 29 | 110 | 13.75 | <b>\$1202</b> |  |
| EL8  | 96 x 36 x 29 | 140 | 14.75 | <b>\$1357</b> |  |
| EL8W | 96 x 48 x 29 | 150 | 16.25 | <b>\$1490</b> |  |

Please specify edge detail: self edge (**SE**), bullnose (**BN**), T-mold (**TM**) or built-up (**BU**).  
 Shipped easy to assemble in 2 cartons.

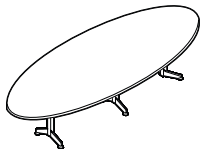

**Elliptical Top - Three Legs\***

|       |               |     |       |               |  |
|-------|---------------|-----|-------|---------------|--|
| EL10  | 120 x 36 x 29 | 210 | 15.75 | <b>\$1921</b> |  |
| EL10W | 120 x 48 x 29 | 245 | 17.5  | <b>\$2321</b> |  |
| EL12W | 144 x 48 x 29 | 270 | 19    | <b>\$2510</b> |  |

Please specify edge detail: self edge (**SE**), bullnose (**BN**), T-mold (**TM**) or built-up (**BU**).  
 Shipped easy to assemble in 2 cartons.



**Elliptical Top - Two Tubular Legs\***

|       |              |     |       |               |  |
|-------|--------------|-----|-------|---------------|--|
| EL6R  | 72 x 36 x 29 | 110 | 13.75 | <b>\$1357</b> |  |
| EL8R  | 96 x 36 x 29 | 140 | 14.75 | <b>\$1503</b> |  |
| EL8WR | 96 x 48 x 29 | 150 | 16.25 | <b>\$1648</b> |  |

Please specify edge detail: self edge (**SE**), bullnose (**BN**), T-mold (**TM**) or built-up (**BU**).  
 Shipped easy to assemble in 2 cartons.

| Required specifications                  | Optional specifications        | Accessories |
|--|--------------------------------|-------------|
| Top finish<br>Leg finish*<br>Edge detail | Grommet<br>Power block cut-out | Power block |



# B BOARDROOM & CAFETERIA TABLES

## ELLIPTICAL TOPS

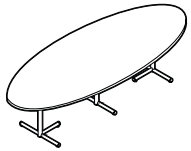

**Elliptical Top - Three Tubular Legs\***

| MODEL # | DIMENSIONS | WT/LB. | CUBIC FT. | LIST PRICE |
|---------|------------|--------|-----------|------------|
|---------|------------|--------|-----------|------------|

**W x D x H**

|        |               |     |       |               |
|--------|---------------|-----|-------|---------------|
| EL10R  | 120 x 36 x 29 | 210 | 15.75 | <b>\$2151</b> |
| EL10WR | 120 x 48 x 29 | 245 | 17.5  | <b>\$2558</b> |
| EL12WR | 144 x 48 x 29 | 270 | 19    | <b>\$2748</b> |

Please specify edge detail: self edge (**SE**), bullnose (**BN**), T-mold (**TM**) or built-up (**BU**).  
Shipped easy to assemble in 2 cartons.

**Required specifications**

Top finish  
Leg finish\*  
Edge detail\*

**Optional specifications**

Grommet  
Power block cut-out

**Accessories**

Power block

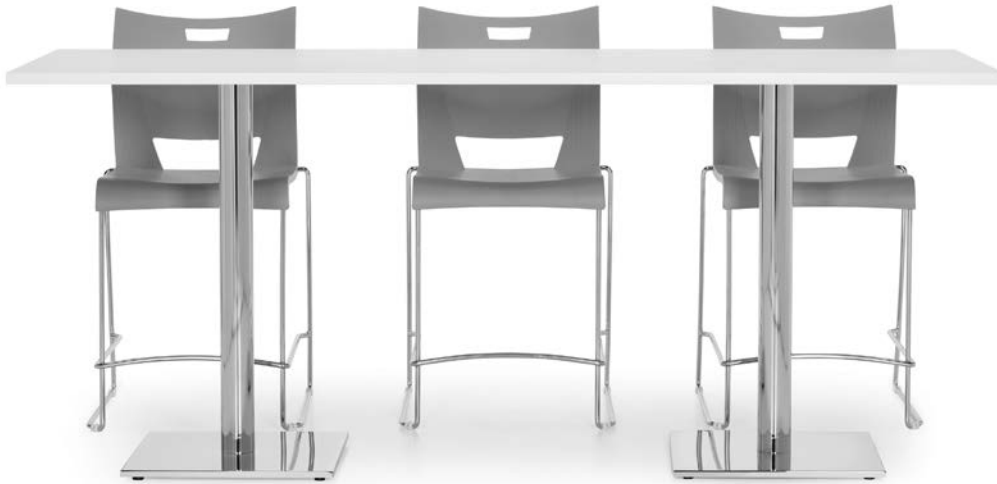

Global's Swap collection is a comprehensive offering including laptop tables, casual meeting tables, café tables, huddle tables and more. Suitable for a variety of applications: break rooms, dedicated/enclosed meeting rooms, casual/open area meeting spaces (lounges, seated, counter and bar height options), and private office (accommodate smaller 3-4 person discussions). Tops and bases are sold separately for ease of specification. Mix and match capabilities to create spaces for multi-purpose use. Choose your top, choose your base. Create the combination you desire for the way you want to work.

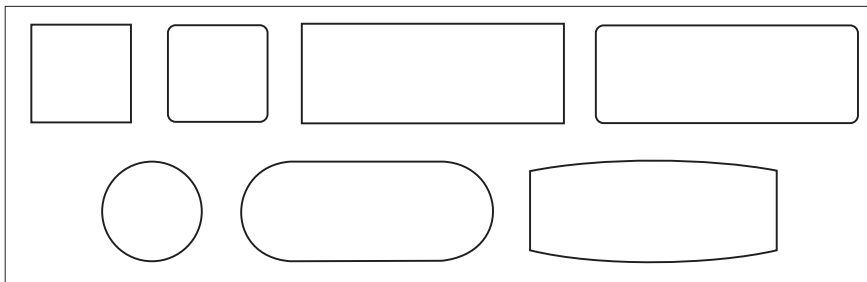

Top shapes

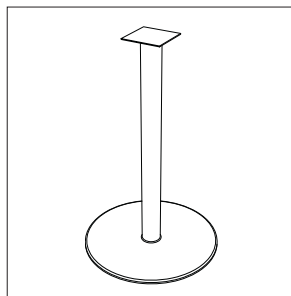

Round base

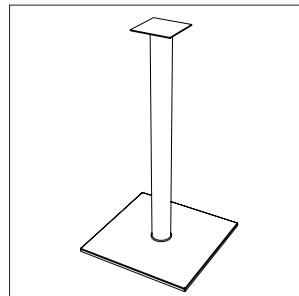

Square base

### Features and Benefits

- Tops are available in four materials to help perfect your interior design: thermally fused laminate, high pressure laminate, veneer and solid surface.
- **High performance thermally fused laminate** tops are 1" thick with a 45 lb. density particle board core and feature 2mm thick edgeband.
- **High pressure laminate** tops are 1 1/16" thick with 2mm flat edge or 1 3/16" thick with knife edge profile. Tops with flat edge have a 45 lb. density particle board core; tops with knife edge have a MDF core.
- **Veneer** tops are 1 3/16" thick overall with matching flat edge or knife edge.
- **Solid surface** tops are 1 1/4" thick with a plywood or particle board melamine subtop depending on size, available with flat edge or knife edge.
- Bases are constructed of a solid steel metal plate and cover - round or square.
- Power block cut-outs are available on most tables.
- 6 heights:  
Coffee table height at 16"H.  
End table height at 22"H.  
Lounge height at 27"H.  
Seated height at 29"H.  
Counter height at 36"H.  
Bar height at 41.5"H.

## GENERAL INFORMATION

- Swap is a series of tables for use in casual meeting spaces, lounges, café areas and more.
- The right proportions, flawless surfaces and a solid foundation is sure to become your favorite table series to spec.
- Finish palette coordinates with most Global laminate and veneer casegoods series as well as a variety of solid surface options to choose from - tables can stand-alone or blend with other solutions.
- Each component is packed individually. Bases are shipped assembled, 1 per carton. Easy to assemble.
- For environmental certifications, please visit [globalfurnituregroup.com](http://globalfurnituregroup.com).

## WORKSURFACES

- Four material choices: high performance thermally fused laminate, high pressure laminate, veneer and solid surface.
- **Thermally fused laminate** tops are 1" thick overall with a 45 lb. density particle board core and feature 2mm thick edgeband. Edgeband finish can be specified to match or contrast the surface finish.
- **High pressure laminate** tops are 1 1/16" thick with 2mm flat edge or 1 3/16" thick with knife edge. 1 1/16" thick tops have a 45 lb. density particle board core and the 2mm flat edge finish can be specified to match or complement the top surface. 1 3/16" thick tops have an MDF core and the knife edge finish will match top surface. Models ending in **(LK)** indicate high pressure laminate with knife edge.
- **Veneer** tops are 1 3/16" thick overall with choice of edge detail - flat edge or knife edge. Edge finish will correspond to surface finish. When flat edge, core material is 45 lb. density particle board; when knife edge, core material is MDF. Models ending in **(V)** indicate veneer.
- **Solid surface** tops are 1 1/4" thick overall with choice of edge detail - flat edge or knife edge. Solid surface material is 0.5" thick with built up edge profile over a particle board or plywood subtop depending on overall top size. Models ending in **(SF)** indicate solid surface with flat edge; models ending in **(SK)** indicate solid surface with knife edge.
- Please see model # for pricing and availability of various material and edge options.
- Refer to page 323 or [globalfurnituregroup.com](http://globalfurnituregroup.com) for available finish options.
- While not all sizes are available in all materials:
  - Worksurfaces of 96" or less in length are standard in one piece (1 carton).
  - Worksurfaces 120" to 144" in length are standard in two pieces (2 cartons).
  - Worksurfaces 96", 120" and 144" x 48" include support channels.

## BASES

- **Caution:** to meet BIFMA standards for performance and stability, appropriate base size must be specified with corresponding top sizes identified. **Top plates and base plates vary by base size and will only work with table shape sizes as referenced on the following pages.**
- Bases are constructed of a round or square solid steel metal plate for counter balance, covered with a finished steel shroud, affixed with four bolts to a cold rolled steel tube.
- GRB14H25 attaches to tops with a 6" x 6" steel plate, welded to a 1.5" diameter steel tube, bolted to a 0.5" thick solid steel counter balance. Not to be used on tops greater than 22" x 22" in size.
- GSB13H25 and GSOB13H25 attach to tops with a 6" x 6" steel plate, welded to a 1.5" diameter steel tube, bolted to a 0.5" thick solid steel counter balance. Not to be used on tops greater than 22" x 22" in size.
- GRB22H15, GRB22H21, GRB22H26, GRB22, GRB22H35, GRB22H41, GSB19H15, GSB19H21, GSB19H26, GSB19, GSB19H35 and GSB19H41 attach to tops with a 6" x 6" steel plate, welded to a 3" diameter steel tube, bolted to a 0.5" thick solid steel counter balance.
- Top plate and base plate of GRB22 and GSB19 models in all heights, have pass-through cut-outs to accommodate a single port simplex or dual USB module to deliver power or USB charging to the surface. This allows the module to be mounted directly above the base and to pass the unit's cord through the base column resulting in the cord and plug head exiting from the bottom of the base for plugging into a floor or wall mount power source.
- GRB28, GRB34, GSB23 and GSB28 attach to tops with an 11" x 11" steel plate, welded to a 4" diameter steel tube, bolted to a 0.375" thick solid steel counter balance.
- Bases are available PAINTED in "Sandtex" finish for extra durability. Also available in plated finishes (see page 323) at an upcharge and with an extended lead time. Please see model # for pricing.
- All bases come with six height adjustable glides with 0.75" of adjustability.
- Round bases available in 22", 28" and 34" dia.
- Square bases available in 18.5", 22.5" and 28.5".

1. SPECIFY MODEL NUMBER

2. SPECIFY FINISH

Laminate finishes (thermally fused and high pressure laminate):

|                            |                               |
|----------------------------|-------------------------------|
| <b>ACJ</b> Absolute Acajou | <b>FCL</b> First Class        |
| <b>ASN</b> Asian Night     | <b>NBL</b> Noce Biondo        |
| <b>AWC</b> Avant Cherry    | <b>NGL</b> Noce Grigio        |
| <b>AWH</b> Avant Honey     | <b>NEL</b> Noce Leggero       |
| <b>BLK</b> Black           | <b>NML</b> Noce Medio         |
| <b>BZD</b> Blizzard        | <b>QTM</b> Quartered Mahogany |
| <b>BRC</b> Brushed Cobalt  | <b>SBY</b> Sheer Beauty       |
| <b>CMB</b> Clear Maple     | <b>SDT</b> Stonedust          |
| <b>CGY</b> Custom Grey     | <b>SOG</b> Storm Grey         |
| <b>DES</b> Dark Espresso   | <b>WHE</b> Walnut Heights     |
| <b>DWT</b> Designer White  | <b>WHC</b> White Chocolate    |
| <b>FAS</b> Fashionista     | <b>WCR</b> Winter Cherry      |

Veneer finishes (applicable for models ending in **V** only):

|                          |                               |
|--------------------------|-------------------------------|
| <b>AMW</b> Almond Cherry | <b>LTW</b> Latte              |
| <b>ACW</b> Amber Cherry  | <b>MHW</b> Mahogany on Walnut |
| <b>BTW</b> Biscotti      | <b>MPW</b> Natural Maple      |
| <b>CAW</b> Cocoa Walnut  | <b>MTW</b> Milestone          |
| <b>CRW</b> Coral         | <b>NLW</b> Natural Walnut     |
| <b>DCW</b> Dark Cherry   | <b>RCW</b> Red Cherry         |
| <b>DWW</b> Dark Walnut   | <b>ULW</b> Umber Walnut       |
| <b>EWV</b> Espresso      | <b>VNW</b> Vintage Cherry     |
| <b>EVW</b> Evening Oak   | <b>WLW</b> Walnut             |
| <b>GRW</b> Grey on Oak   | <b>WMW</b> White Maple        |
| <b>HAW</b> Hazelnut      | <b>WCW</b> Warm Cherry        |
| <b>JAW</b> Java          |                               |

Solid surface (applicable for models ending in **SF** or **SK** only):

|                           |                                |
|---------------------------|--------------------------------|
| <b>Grade 1</b>            | <b>Grade 2</b>                 |
| <b>SWH</b> Designer White | <b>SBT</b> Beige Tempest       |
|                           | <b>SBX</b> Black Onyx Mirage   |
|                           | <b>SFW</b> Frosty White Mirage |
|                           | <b>SHS</b> Hot Stone           |
|                           | <b>SMG</b> Milk Glass Spectra  |
|                           | <b>SNM</b> Northern Melange    |

Bases (paint finishes):

|                           |                     |
|---------------------------|---------------------|
| <b>TBL</b> Black          | <b>TIN</b> Ink      |
| <b>TBZ</b> Buzz Blue      | <b>TKA</b> Kalua    |
| <b>TCC</b> Cactus         | <b>TLA</b> Latte    |
| <b>TCR</b> Carrot         | <b>TMO</b> Mocha    |
| <b>TIV</b> Cloud          | <b>TNE</b> Nevada   |
| <b>TDW</b> Designer White | <b>TSN</b> Sand     |
| <b>TDJ</b> Dijon          | <b>TSR</b> Scarlet  |
| <b>TEG</b> Eggplant       | <b>TSH</b> Shadow   |
| <b>TFO</b> Fog            | <b>TOA</b> Toast    |
| <b>TFR</b> Frost          | <b>TTU</b> Tungsten |

Bases (plated finishes - upcharge applies):

|                           |                        |
|---------------------------|------------------------|
| <b>ACO</b> Antique Copper | <b>CHM</b> Chrome      |
| <b>BCH</b> Brushed Chrome | <b>SBR</b> Satin Brass |

3. SPECIFY EDGE PROFILE (where applicable)

- Thermally fused laminate and high pressure with flat edge tops:
  - Flat edge (FE) - default profile
  - 3" radiused corners (R3) - optional for square and rectangular tops, upcharge applies
- High pressure laminate tops (models ending in **LK**):
  - Knife edge only
  - 3" radiused corners available by quote request only
- Veneer tops (models ending in **V**):
  - Flat edge (FE) - default profile
  - Knife edge (KS) - optional
  - 3" radiused corners available by quote request only
- Solid surface tops (models ending is **SF**):
  - Flat edge (FE) - default profile
  - 3" radiused corners (R3) - optional for square and rectangular tops, upcharge applies
- Solid surface tops (models ending is **SK**):
  - Knife edge (KS) - default profile
  - Knife edge with 3" radiused corners (KR) - optional for square and rectangular tops, upcharge applies

4. SPECIFY EDGE FINISH

Edge finish only applicable for thermally fused laminate and high pressure tops with flat edge (FE)

|                            |                           |                             |
|----------------------------|---------------------------|-----------------------------|
| <b>AAE</b> Absolute Acajou | <b>CGY</b> Custom Grey    | <b>NML</b> Noce Medio       |
| <b>ASE</b> Asian Night     | <b>DEE</b> Dark Espresso  | <b>QTM</b> Quarter Mahogany |
| <b>ACE</b> Avant Cherry    | <b>DWE</b> Designer White | <b>SAR</b> Scarlet          |
| <b>AHE</b> Avant Honey     | <b>DJN</b> Dijon          | <b>SHW</b> Shadow           |
| <b>BLK</b> Black           | <b>FAS</b> Fashionista    | <b>SBY</b> Sheer Beauty     |
| <b>BZD</b> Blizzard        | <b>FCL</b> First Class    | <b>SDT</b> Stonedust        |
| <b>BRC</b> Brushed Cobalt  | <b>FOG</b> Fog            | <b>SOG</b> Storm Grey       |
| <b>BZB</b> Buzz Blue       | <b>LAB</b> Latte          | <b>WHE</b> Walnut Heights   |
| <b>CCT</b> Cactus          | <b>NBL</b> Noce Biondo    | <b>CBE</b> White Chocolate  |
| <b>CRO</b> Carrot          | <b>NGL</b> Noce Grigio    | <b>WCE</b> Winter Cherry    |
| <b>CME</b> Clear Maple     | <b>NEL</b> Noce Leggero   |                             |

## 5. SPECIFY OPTIONS

### POWER BLOCKS AND CUT-OUTS LOCATIONS

- A power block delivers power/data to the table surface.
- Power block modules are ordered separately.
- Not all power block locations are available on all table sizes. Please refer to the top/base chart on the following pages for more information.
- To purchase a power block, you must specify the power block cut-out location when ordering the top and order the power block separately.
- Optional cut-out available in standard worksurface locations (left, center or right) for all table shapes.  
Example: Order as **E1, R1, T1**, etc. **Add \$91** for each cut-out.
- Cut-outs may be placed at non-standard locations. Please contact Customer Service.
- Select power block option from Productivity Solutions pages 465-468.
- Custom locations or cut-outs available (drawing required). **Add \$132.**

### POWER BLOCK OPTIONS AND CUT-OUT LOCATIONS

(Power modules and blocks can be found in the Productivity Solutions section of the price list)

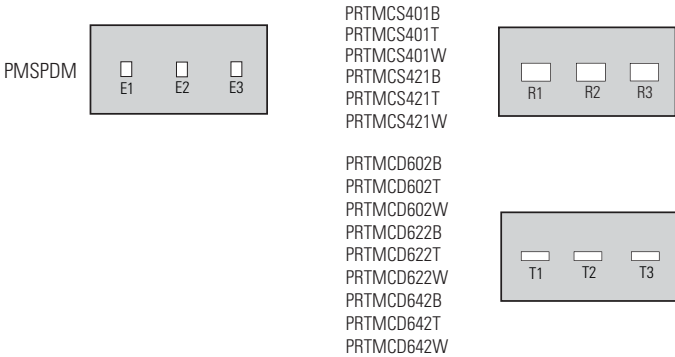

- Match power block desired with cut-out code and location from above grid.
- Example: If power block module # PRTMC401B is required in the center position, specify cut-out option R2 when specifying the top.

### SINGLE PORT MODULES

- Single port module with one simplex or one dual USB charging port centered over the base, available for tops supported with single GRB22xx or GSB19xx base in any height
- Specify optional cut-out (**Q2**) to accommodate when specifying tops. **Add \$91** to list.
- Modules are listed on product pages with applicable tops and bases. Modules are ordered separately.

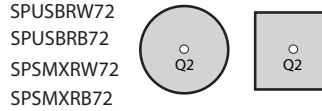

- For White colored modules, specify code ending in (**W72**); for Black colored modules, specify code ending in (**B72**).









### SPECIFICATIONS



- Required and optional specifications marked with an \* on the pricelist pages with products are applicable to only those products which have the \* symbol beside the product name.

**TABLE NOTES - ESTIMATED CAPACITY**

- Use the following to determine the size of a table and the number of chairs needed for a conference area.
- All estimates are based on an average chair width of 23" with a 4" clearance between chairs. Adjust accordingly for a different chair size.







| Top Size | NUMBER OF CHAIRS |        |             |       |           |  |
|----------|------------------|--------|-------------|-------|-----------|--|
|          | Round            | Square | Rectangular | Boat  | Racetrack |  |
| 24 x 24  | 2                | 2      | N/A         | N/A   | N/A       |  |
| 24 x 30  | N/A              | N/A    | 2-3         | N/A   | N/A       |  |
| 24 x 36  | N/A              | N/A    | 3-4         | N/A   | N/A       |  |
| 30 x 30  | 3                | 4      | N/A         | N/A   | N/A       |  |
| 30 x 36  | N/A              | N/A    | 4           | N/A   | N/A       |  |
| 30 x 42  | N/A              | N/A    | 4           | N/A   | N/A       |  |
| 36 x 36  | 4                | 4      | N/A         | N/A   | N/A       |  |
| 36 x 42  | N/A              | N/A    | 4           | N/A   | N/A       |  |
| 42 x 42  | 4                | 4      | N/A         | N/A   | N/A       |  |
| 48 x 48  | 4                | 4      | N/A         | N/A   | N/A       |  |
| 54 x 54  | 5                | 6      | N/A         | N/A   | N/A       |  |
| 60 x 60  | 5                | 6      | N/A         | N/A   | N/A       |  |
| 24 x 60  | N/A              | N/A    | 4-6         | N/A   | 4-6       |  |
| 24 x 66  | N/A              | N/A    | 4-6         | N/A   | 4-6       |  |
| 24 x 72  | N/A              | N/A    | 4-6         | N/A   | 4-6       |  |
| 24 x 84  | N/A              | N/A    | 4-6         | N/A   | 4-6       |  |
| 24 x 96  | N/A              | N/A    | 6-8         | N/A   | 6-8       |  |
| 30 x 60  | N/A              | N/A    | 4-6         | 4-6   | 4-6       |  |
| 30 x 66  | N/A              | N/A    | 4-6         | 4-6   | 4-6       |  |
| 30 x 72  | N/A              | N/A    | 4-6         | 4-6   | 4-6       |  |
| 30 x 84  | N/A              | N/A    | 4-6         | 4-6   | 4-6       |  |
| 30 x 96  | N/A              | N/A    | 6-8         | 6-8   | 6-8       |  |
| 36 x 60  | N/A              | N/A    | 4-6         | 4-6   | 4-6       |  |
| 36 x 66  | N/A              | N/A    | 4-6         | 4-6   | 4-6       |  |
| 36 x 72  | N/A              | N/A    | 4-6         | 4-6   | 4-6       |  |
| 36 x 84  | N/A              | N/A    | 4-6         | 4-6   | 4-6       |  |
| 36 x 96  | N/A              | N/A    | 6-8         | 6-8   | 6-8       |  |
| 48 x 84  | N/A              | N/A    | 6-8         | 6-8   | 6-8       |  |
| 48 x 96  | N/A              | N/A    | 6-8         | 6-8   | 6-8       |  |
| 48 x 120 | N/A              | N/A    | 8-10        | 8-10  | 8-10      |  |
| 48 x 144 | N/A              | N/A    | 10-12       | 10-12 | 10-12     |  |

| APPLICABLE BASE OPTIONS FOR CORRESPONDING TOP  |            |   |  |   |  |   |  |  |  | POWER MGMT OPTIONS |              |   |
|--|------------|---|--|---|--|---|--|--|--|--------------------|--------------|---|
| Table Shape/Size   | Top #      | Lounge Height 27"H  |  | Seated Height 28.5"H  |  | Counter Height 36"H   |  | Bar Height 41.5"H  |  | Base Qty.          | # top pieces | Grommet and Power Block Cut-outs Available                                  |
|  |            | Round base 22"<br> | Square base 18.5"<br> | Round base 22", 28", 34"<br> | Square base 18.5", 22.5", 28.5"<br> | Round base 22"<br> | Square base 18.5"<br> | Round base 22"<br> | Square base 18.5"<br> |                    |              |   |
| <b>Round</b> ○ <b>Nominal base plate dimension indicated by 4th and 5th characters in base model numbers</b> |            |   |  |   |  |   |  |  |  |                    |              |   |
| 24" diameter top   | GRBTP24_   | GRB22H26  | GSB19H26   | GRB22   | GSB19  | GRB22H35  | GSB19H35   | GRB22H41   | GSB19H41   | 1                  | 1            | Q2 only   |
| 30" diameter top   | GRBTP30_   | GRB22H26  | GSB19H26   | GRB22   | GSB19  | GRB22H35  | GSB19H35   | GRB22H41   | GSB19H41   | 1                  | 1            | Q2 only   |
| 36" diameter top   | GRBTP36_   | GRB22H26  | GSB19H26   | GRB22   | GSB19  | GRB22H35  | GSB19H35   | GRB22H41   | GSB19H41   | 1                  | 1            | Q2 only   |
| 42" diameter top   | GRBTP42_   | N/A   | N/A  | GRB28   | GSB23  | N/A   | N/A  | N/A  | N/A  | 1                  | 1            | None  |
| 48" diameter top   | GRBTP48_   | N/A   | N/A  | GRB28   | GSB23  | N/A   | N/A  | N/A  | N/A  | 1                  | 1            | None  |
| 54" diameter top   | GRBTP54_   | N/A   | N/A  | GRB34   | GSB28  | N/A   | N/A  | N/A  | N/A  | 1                  | 1            | None  |
| 60" diameter top   | GRBTP60_   | N/A   | N/A  | GRB34   | GSB28  | N/A   | N/A  | N/A  | N/A  | 1                  | 1            | None  |
| <b>Square</b> □  |            |   |  |   |  |   |  |  |  |                    |              |   |
| 24" square top   | GSBTP24_   | GRB22H26  | GSB19H26   | GRB22   | GSB19  | GRB22H35  | GSB19H35   | GRB22H41   | GSB19H41   | 1                  | 1            | Q2 only   |
| 30" square top   | GSBTP30_   | GRB22H26  | GSB19H26   | GRB22   | GSB19  | GRB22H35  | GSB19H35   | GRB22H41   | GSB19H41   | 1                  | 1            | Q2 only   |
| 36" square top   | GSBTP36_   | GRB22H26  | GSB19H26   | GRB22   | GSB19  | GRB22H35  | GSB19H35   | GRB22H41   | GSB19H41   | 1                  | 1            | Q2 only   |
| 42" square top   | GSBTP42_   | N/A   | N/A  | GRB28   | GSB23  | N/A   | N/A  | N/A  | N/A  | 1                  | 1            | None  |
| <b>Rectangular</b> ▭   |            |   |  |   |  |   |  |  |  |                    |              |   |
| 30x24 Rectangular  | GSBTP2430_ | GRB22H26  | GSB19H26   | GRB22   | GSB19  | GRB22H35  | GSB19H35   | GRB22H41   | GSB19H41   | 1                  | 1            | Q2 only   |
| 36x24 Rectangular  | GSBTP2436_ | GRB22H26  | GSB19H26   | GRB22   | GSB19  | GRB22H35  | GSB19H35   | GRB22H41   | GSB19H41   | 1                  | 1            | Q2 only   |
| 36x30 Rectangular  | GSBTP3036_ | GRB22H26  | GSB19H26   | GRB22   | GSB19  | GRB22H35  | GSB19H35   | GRB22H41   | GSB19H41   | 1                  | 1            | Q2 only   |
| 42x30 Rectangular  | GSBTP3042_ | N/A   | N/A  | GRB28   | GSB23  | N/A   | N/A  | N/A  | N/A  | 1                  | 1            | None  |
| 42x36 Rectangular  | GSBTP3642_ | N/A   | N/A  | GRB28   | GSB23  | N/A   | N/A  | N/A  | N/A  | 1                  | 1            | None  |
| 60x24 Rectangular  | GRT5STP_   | GRB22H26  | GSB19H26   | N/A   | N/A  | GRB22H35  | GSB19H35   | GRB22H41   | GSB19H41   | 2                  | 1            | Center:<br>E2, R2, T2, FOG2   |
| 66x24 Rectangular  | GRT5HSTP_  | GRB22H26  | GSB19H26   | N/A   | N/A  | GRB22H35  | GSB19H35   | GRB22H41   | GSB19H41   | 2                  | 1            |   |
| 72x24 Rectangular  | GRT6STP_   | GRB22H26  | GSB19H26   | N/A   | N/A  | GRB22H35  | GSB19H35   | GRB22H41   | GSB19H41   | 2                  | 1            |   |
| 84x24 Rectangular  | GRT7STP_   | GRB22H26  | GSB19H26   | N/A   | N/A  | GRB22H35  | GSB19H35   | GRB22H41   | GSB19H41   | 2                  | 1            | 3 positions - Left/<br>Center/Right   |
| 96x24 Rectangular  | GRT8STP_   | GRB22H26  | GSB19H26   | N/A   | N/A  | GRB22H35  | GSB19H35   | GRB22H41   | GSB19H41   | 2                  | 1            |   |
| 60x30 Rectangular  | GRT5NTP_   | GRB22H26  | GSB19H26   | GRB22   | GSB19  | GRB22H35  | GSB19H35   | GRB22H41   | GSB19H41   | 2                  | 1            | Center: E2, R2, T2,<br>FOG2   |
| 60x36 Rectangular  | GRT5TP_    | GRB22H26  | GSB19H26   | GRB22   | GSB19  | GRB22H35  | GSB19H35   | GRB22H41   | GSB19H41   | 2                  | 1            |   |
| 66x30 Rectangular  | GRT5NHTP_  | GRB22H26  | GSB19H26   | GRB22   | GSB19  | GRB22H35  | GSB19H35   | GRB22H41   | GSB19H41   | 2                  | 1            |   |
| 66x36 Rectangular  | GRT5HTP_   | GRB22H26  | GSB19H26   | GRB22   | GSB19  | GRB22H35  | GSB19H35   | GRB22H41   | GSB19H41   | 2                  | 1            |   |
| 72x30 Rectangular  | GRT6NTP_   | GRB22H26  | GSB19H26   | GRB22   | GSB19  | GRB22H35  | GSB19H35   | GRB22H41   | GSB19H41   | 2                  | 1            |   |
| 72x36 Rectangular  | GRT6TP_    | GRB22H26  | GSB19H26   | GRB22   | GSB19  | GRB22H35  | GSB19H35   | GRB22H41   | GSB19H41   | 2                  | 1            |   |
| 84x30 Rectangular  | GRT7NTP_   | GRB22H26  | GSB19H26   | GRB22   | GSB19  | GRB22H35  | GSB19H35   | GRB22H41   | GSB19H41   | 2                  | 1            | 3 positions - Left/<br>Center/Right:<br>E1/2/3, R1/2/3,<br>T1/2/3, FOG1/2/3 |
| 84x36 Rectangular  | GRT7TP_    | GRB22H26  | GSB19H26   | GRB22   | GSB19  | GRB22H35  | GSB19H35   | GRB22H41   | GSB19H41   | 2                  | 1            |   |
| 96x30 Rectangular  | GRT8NTP_   | GRB22H26  | GSB19H26   | GRB22   | GSB19  | GRB22H35  | GSB19H35   | GRB22H41   | GSB19H41   | 2                  | 1            |   |
| 96x36 Rectangular  | GRT8TP_    | GRB22H26  | GSB19H26   | GRB22   | GSB19  | GRB22H35  | GSB19H35   | GRB22H41   | GSB19H41   | 2                  | 1            |   |
| 96x42 Rectangular  | GRT8MTP_   | N/A   | N/A  | GRB28   | GSB23  | N/A   | N/A  | N/A  | N/A  | 2                  | 1            |   |
| 96x48 Rectangular  | GRT8WTP_   | N/A   | N/A  | GRB28   | GSB23  | N/A   | N/A  | N/A  | N/A  | 2                  | 1            |   |
| 120x48 Rectangular   | GRT10WTP_  | N/A   | N/A  | GRB28   | GSB23  | N/A   | N/A  | N/A  | N/A  | 3                  | 2            | Both ends:<br>E1, E3, R1, R3, T1,<br>T3, FOG1, FOG3                         |
| 144x48 Rectangular   | GRT12WTP_  | N/A   | N/A  | GRB28   | GSB23  | N/A   | N/A  | N/A  | N/A  | 3                  | 2            |   |

| APPLICABLE BASE OPTIONS FOR CORRESPONDING TOP  |           |                    |                   |                          |                                 |                     |                   |                   |                   | POWER MGMT OPTIONS |              |   |
|--|-----------|--------------------|-------------------|--------------------------|---------------------------------|---------------------|-------------------|-------------------|-------------------|--------------------|--------------|---|
| Table Shape/Size   | Top #     | Lounge Height 27"H |                   | Seated Height 28.5"H     |                                 | Counter Height 36"H |                   | Bar Height 41.5"H |                   | Base Qty.          | # top pieces | Grommet and Power Block Cut-outs Available                                  |
|  |           | Round base 22"     | Square base 18.5" | Round base 22", 28", 34" | Square base 18.5", 22.5", 28.5" | Round base 22"      | Square base 18.5" | Round base 22"    | Square base 18.5" |                    |              |   |
| <b>Racetrack</b>  <span style="margin-left: 100px;">Nominal base plate dimension indicated by 4th and 5th characters in base model numbers</span> |           |                    |                   |                          |                                 |                     |                   |                   |                   |                    |              |   |
| 60X24 Racetrack  | GRC5STP_  | GRB22H26           | GSB19H26          | N/A                      | N/A                             | GRB22H35            | GSB19H35          | GRB22H41          | GSB19H41          | 2                  | 1            | Center:<br>E2, R2, T2, FOG2   |
| 66X24 Racetrack  | GRC5HSTP_ | GRB22H26           | GSB19H26          | N/A                      | N/A                             | GRB22H35            | GSB19H35          | GRB22H41          | GSB19H41          | 2                  | 1            |   |
| 72X24 Racetrack  | GRC6STP_  | GRB22H26           | GSB19H26          | N/A                      | N/A                             | GRB22H35            | GSB19H35          | GRB22H41          | GSB19H41          | 2                  | 1            | 3 positions - Left/<br>Center/Right   |
| 84X24 Racetrack  | GRC7STP_  | GRB22H26           | GSB19H26          | N/A                      | N/A                             | GRB22H35            | GSB19H35          | GRB22H41          | GSB19H41          | 2                  | 1            |   |
| 96X24 Racetrack  | GRC8STP_  | GRB22H26           | GSB19H26          | N/A                      | N/A                             | GRB22H35            | GSB19H35          | GRB22H41          | GSB19H41          | 2                  | 1            | Center: E2, R2, T2,<br>FOG2   |
| 60x30 Racetrack  | GRC5NTP_  | GRB22H26           | GSB19H26          | GRB22                    | GSB19                           | GRB22H35            | GSB19H35          | GRB22H41          | GSB19H41          | 2                  | 1            |   |
| 60X36 Racetrack  | GRC5TP_   | GRB22H26           | GSB19H26          | GRB22                    | GSB19                           | GRB22H35            | GSB19H35          | GRB22H41          | GSB19H41          | 2                  | 1            |   |
| 66x30 Racetrack  | GRC5NHTP_ | GRB22H26           | GSB19H26          | GRB22                    | GSB19                           | GRB22H35            | GSB19H35          | GRB22H41          | GSB19H41          | 2                  | 1            |   |
| 66X36 Racetrack  | GRC5HTP_  | GRB22H26           | GSB19H26          | GRB22                    | GSB19                           | GRB22H35            | GSB19H35          | GRB22H41          | GSB19H41          | 2                  | 1            |   |
| 72x30 Racetrack  | GRC6NTP_  | GRB22H26           | GSB19H26          | GRB22                    | GSB19                           | GRB22H35            | GSB19H35          | GRB22H41          | GSB19H41          | 2                  | 1            |   |
| 72x36 Racetrack  | GRC6TP_   | GRB22H26           | GSB19H26          | GRB22                    | GSB19                           | GRB22H35            | GSB19H35          | GRB22H41          | GSB19H41          | 2                  | 1            | 3 positions - Left/<br>Center/Right:<br>E1/2/3; R1/2/3,<br>T1/2/3, FOG1/2/3 |
| 84x30 Racetrack  | GRC7NTP_  | GRB22H26           | GSB19H26          | GRB22                    | GSB19                           | GRB22H35            | GSB19H35          | GRB22H41          | GSB19H41          | 2                  | 1            |   |
| 84x36 Racetrack  | GRC7TP_   | GRB22H26           | GSB19H26          | GRB22                    | GSB19                           | GRB22H35            | GSB19H35          | GRB22H41          | GSB19H41          | 2                  | 1            |   |
| 96x30 Racetrack  | GRC8NTP_  | GRB22H26           | GSB19H26          | GRB22                    | GSB19                           | GRB22H35            | GSB19H35          | GRB22H41          | GSB19H41          | 2                  | 1            |   |
| 96x36 Racetrack  | GRC8TP_   | GRB22H26           | GSB19H26          | GRB22                    | GSB19                           | GRB22H35            | GSB19H35          | GRB22H41          | GSB19H41          | 2                  | 1            |   |
| 96x42 Racetrack  | GRC8MTP_  | N/A                | N/A               | GRB28                    | GSB23                           | N/A                 | N/A               | N/A               | N/A               | 2                  | 1            |   |
| 96x48 Racetrack  | GRC8WTP_  | N/A                | N/A               | GRB28                    | GSB23                           | N/A                 | N/A               | N/A               | N/A               | 2                  | 1            | Both ends:<br>E1, E3; R1, R3, T1,<br>T3, FOG1, FOG3                         |
| 120x48 Racetrack   | GRC10WTP_ | N/A                | N/A               | GRB28                    | GSB23                           | N/A                 | N/A               | N/A               | N/A               | 3                  | 2            |   |
| 144x48 Racetrack   | GRC12WTP_ | N/A                | N/A               | GRB28                    | GSB23                           | N/A                 | N/A               | N/A               | N/A               | 3                  | 2            |   |
| <b>Boat Shape</b>   |           |                    |                   |                          |                                 |                     |                   |                   |                   |                    |              |   |
| 60x30 Boat shape   | GBT5NTP_  | GRB22H26           | GSB19H26          | GRB22                    | GSB19                           | GRB22H35            | GSB19H35          | GRB22H41          | GSB19H41          | 2                  | 1            | Center: E2, R2, T2,<br>FOG2   |
| 60X36 Boat shape   | GBT5TP_   | GRB22H26           | GSB19H26          | GRB22                    | GSB19                           | GRB22H35            | GSB19H35          | GRB22H41          | GSB19H41          | 2                  | 1            |   |
| 66x30 Boat shape   | GBT5NHTP_ | GRB22H26           | GSB19H26          | GRB22                    | GSB19                           | GRB22H35            | GSB19H35          | GRB22H41          | GSB19H41          | 2                  | 1            |   |
| 66X36 Boat shape   | GBT5HTP_  | GRB22H26           | GSB19H26          | GRB22                    | GSB19                           | GRB22H35            | GSB19H35          | GRB22H41          | GSB19H41          | 2                  | 1            |   |
| 72x30 Boat shape   | GBT6NTP_  | GRB22H26           | GSB19H26          | GRB22                    | GSB19                           | GRB22H35            | GSB19H35          | GRB22H41          | GSB19H41          | 2                  | 1            |   |
| 72x36 Boat shape   | GBT6TP_   | GRB22H26           | GSB19H26          | GRB22                    | GSB19                           | GRB22H35            | GSB19H35          | GRB22H41          | GSB19H41          | 2                  | 1            | 3 positions - Left/<br>Center/Right:<br>E1/2/3; R1/2/3,<br>T1/2/3, FOG1/2/3 |
| 84x30 Boat shape   | GBT7NTP_  | GRB22H26           | GSB19H26          | GRB22                    | GSB19                           | GRB22H35            | GSB19H35          | GRB22H41          | GSB19H41          | 2                  | 1            |   |
| 84x36 Boat shape   | GBT7TP_   | GRB22H26           | GSB19H26          | GRB22                    | GSB19                           | GRB22H35            | GSB19H35          | GRB22H41          | GSB19H41          | 2                  | 1            |   |
| 96x30 Boat shape   | GBT8NTP_  | GRB22H26           | GSB19H26          | GRB22                    | GSB19                           | GRB22H35            | GSB19H35          | GRB22H41          | GSB19H41          | 2                  | 1            |   |
| 96x36 Boat shape   | GBT8TP_   | GRB22H26           | GSB19H26          | GRB22                    | GSB19                           | GRB22H35            | GSB19H35          | GRB22H41          | GSB19H41          | 2                  | 1            |   |
| 96X42 Boat shape   | GBT8MTP_  | N/A                | N/A               | GRB28                    | GSB23                           | N/A                 | N/A               | N/A               | N/A               | 2                  | 1            |   |
| 96x48 Boat shape   | GBT8WTP_  | N/A                | N/A               | GRB28                    | GSB23                           | N/A                 | N/A               | N/A               | N/A               | 2                  | 1            | Both ends:<br>E1, E3; R1, R2, T1,<br>T2, FOG1, FOG 3                        |
| 120x48 Boat shape  | GBT10WTP_ | N/A                | N/A               | GRB28                    | GSB23                           | N/A                 | N/A               | N/A               | N/A               | 3                  | 2            |   |
| 144x48 Boat shape  | GBT12WTP_ | N/A                | N/A               | GRB28                    | GSB23                           | N/A                 | N/A               | N/A               | N/A               | 3                  | 2            |   |



# S SWAP™ TABLES - NOTES

| APPLICABLE BASE OPTIONS FOR CORRESPONDING TOP  |            |   |   |   |   | POWER MGMT OPTIONS |              |                                |
|--|------------|---|---|---|---|--------------------|--------------|--------------------------------|
| Table Shape/Size   | Top #      | Laptop Height 25.6" H   |   |   |   | Base Qty.          | # Top pieces | Power Block Cut-outs available |
|  |            | Round base 14" Centered column  | Square base 12.5" Centered column   | Round base  | Square base 12.5" Offset column   |                    |              |                                |
|  |            |    |    | N/A   |    |                    |              |                                |
| <b>Round Laptop</b> ○ <i>*Nominal base plate dimension indicated by 4th and 5th characters in base model numbers.</i>            |            |   |   |   |   |                    |              |                                |
| 16.5" dia  | GRBTP16_   | GRB14H25  | GSB13H25  | N/A   | N/A   | 1                  | 1            | None                           |
| 20" dia  | GRBTP20_   | GRB14H25  | GSB13H25  | N/A   | N/A   | 1                  | 1            | None                           |
| 22" dia  | GRBTP22_   | GRB14H25  | GSB13H25  | N/A   | N/A   | 1                  | 1            | None                           |
| 16.5" dia  | GRBOTP16_  | N/A   | N/A   | N/A   | GSOB13H25   | 1                  | 1            | None                           |
| 20" dia  | GRBOTP20_  | N/A   | N/A   | N/A   | GSOB13H25   | 1                  | 1            | None                           |
| 22" dia  | GRBOTP22_  | N/A   | N/A   | N/A   | GSOB13H25   | 1                  | 1            | None                           |
| <b>Square Laptop</b> □   |            |   |   |   |   |                    |              |                                |
| 16.5"x16.5"  | GSBTP16_   | GRB14H25  | GSB13H25  | N/A   | N/A   | 1                  | 1            | None                           |
| 20"x20"  | GSBTP20_   | GRB14H25  | GSB13H25  | N/A   | N/A   | 1                  | 1            | None                           |
| 22"x22"  | GSBTP22_   | GRB14H25  | GSB13H25  | N/A   | N/A   | 1                  | 1            | None                           |
| 16.5"x16.5"  | GSBOTP16_  | N/A   | N/A   | N/A   | GSOB13H25   | 1                  | 1            | None                           |
| 20"x20"  | GSBOTP20_  | N/A   | N/A   | N/A   | GSOB13H25   | 1                  | 1            | None                           |
| 22"x22"  | GSBOTP22_  | N/A   | N/A   | N/A   | GSOB13H25   | 1                  | 1            | None                           |
| <b>Rectangular Laptop</b> □  |            |   |   |   |   |                    |              |                                |
| 16"x20"  | GSBTP1620_ | GRB14H25  | GSB13H25  | N/A   | N/A   | 1                  | 1            | None                           |
| 16"x22"  | GSBTP1622_ | GRB14H25  | GSB13H25  | N/A   | N/A   | 1                  | 1            | None                           |
| 16"x20"  | GSBOT1620_ | N/A   | N/A   | N/A   | GSOB13H25   | 1                  | 1            | None                           |
| 16"x22"  | GSBOT1622_ | N/A   | N/A   | N/A   | GSOB13H25   | 1                  | 1            | None                           |
| APPLICABLE BASE OPTIONS FOR CORRESPONDING TOP  |            |   |   |   |   | POWER MGMT OPTIONS |              |                                |
| Table Shape  | Top #      | Coffee Table 16" H  |   | End Table 22" H   |   | Base Qty.          | # top pieces | Power Block Cut-outs available |
|  |            | Round base 22"  | Square base 18.5"   | Round base 22"  | Square base 18.5"   |                    |              |                                |
|  |            |  |  |  |  |                    |              |                                |
| <b>Round Coffee/End Tables</b> ○ <i>*Nominal base plate dimension indicated by 4th and 5th characters in base model numbers.</i> |            |   |   |   |   |                    |              |                                |
| 24" dia  | GRBTP24_   | GRB22H15  | GSB19H15  | GRB22H21  | GSB19H21  | 1                  | 1            | Q2 only                        |
| 30" dia  | GRBTP30_   | GRB22H15  | GSB19H15  | GRB22H21  | GSB19H21  | 1                  | 1            | Q2 only                        |
| 36" dia  | GRBTP36_   | GRB22H15  | GSB19H15  | GRB22H21  | GSB19H21  | 1                  | 1            | Q2 only                        |
| <b>Square Coffee/End Tables</b> □  |            |   |   |   |   |                    |              |                                |
| 24" square   | GSBTP24_   | GRB22H15  | GSB19H15  | GRB22H21  | GSB19H21  | 1                  | 1            | Q2 only                        |
| 30" square   | GSBTP30_   | GRB22H15  | GSB19H15  | GRB22H21  | GSB19H21  | 1                  | 1            | Q2 only                        |
| 36" square   | GSBTP36_   | GRB22H15  | GSB19H15  | GRB22H21  | GSB19H21  | 1                  | 1            | Q2 only                        |

ROUND LAPTOP TABLES FOR CENTER BASE

| MODEL # | DIMENSIONS | WT/LB. | CUBIC FT. | LIST PRICE | HP ADD | GRADE 2 | R3 ADD | KS ADD |
|---------|------------|--------|-----------|------------|--------|---------|--------|--------|
|---------|------------|--------|-----------|------------|--------|---------|--------|--------|

W x D x H

**Thermally fused laminate, flat edge <sup>(1)</sup>**

|         |              |   |     |              |             |     |     |     |
|---------|--------------|---|-----|--------------|-------------|-----|-----|-----|
| GRBTP16 | 16.5 x - x 1 | 6 | 0.3 | <b>\$188</b> | <b>\$80</b> | N/A | N/A | N/A |
| GRBTP20 | 20 x - x 1   | 9 | 0.5 | <b>\$206</b> | <b>\$89</b> | N/A | N/A | N/A |
| GRBTP22 | 22 x - x 1   | 9 | 0.5 | <b>\$206</b> | <b>\$89</b> | N/A | N/A | N/A |

**High pressure laminate, knife edge**

|           |                 |     |     |              |     |     |     |     |
|-----------|-----------------|-----|-----|--------------|-----|-----|-----|-----|
| GRBTP16LK | 16.5 x - x 1.19 | 7.5 | 1   | <b>\$537</b> | N/A | N/A | N/A | N/A |
| GRBTP20LK | 20 x - x 1.19   | 11  | 1.5 | <b>\$608</b> | N/A | N/A | N/A | N/A |
| GRBTP22LK | 22 x - x 1.19   | 11  | 2   | <b>\$660</b> | N/A | N/A | N/A | N/A |

**Veneer <sup>(2)</sup>**

|          |                 |     |     |              |     |     |     |             |
|----------|-----------------|-----|-----|--------------|-----|-----|-----|-------------|
| GRBTP16V | 16.5 x - x 1.19 | 7.5 | 1   | <b>\$809</b> | N/A | N/A | N/A | <b>\$77</b> |
| GRBTP20V | 20 x - x 1.19   | 11  | 1.5 | <b>\$875</b> | N/A | N/A | N/A | <b>\$77</b> |
| GRBTP22V | 22 x - x 1.19   | 11  | 2   | <b>\$942</b> | N/A | N/A | N/A | <b>\$77</b> |

**Solid surface, flat edge <sup>(3)</sup>**

|           |                 |    |     |               |     |              |     |     |
|-----------|-----------------|----|-----|---------------|-----|--------------|-----|-----|
| GRBTP16SF | 16.5 x - x 1.25 | 11 | 0.6 | <b>\$1689</b> | N/A | <b>\$88</b>  | N/A | N/A |
| GRBTP20SF | 20 x - x 1.25   | 16 | 1   | <b>\$1982</b> | N/A | <b>\$118</b> | N/A | N/A |
| GRBTP22SF | 22 x - x 1.25   | 20 | 1   | <b>\$2077</b> | N/A | <b>\$171</b> | N/A | N/A |

**Solid surface, knife edge <sup>(3)</sup>**

|           |                 |    |     |               |     |              |     |     |
|-----------|-----------------|----|-----|---------------|-----|--------------|-----|-----|
| GRBTP16SK | 16.5 x - x 1.25 | 11 | 0.6 | <b>\$1789</b> | N/A | <b>\$100</b> | N/A | N/A |
| GRBTP20SK | 20 x - x 1.25   | 16 | 1   | <b>\$2088</b> | N/A | <b>\$123</b> | N/A | N/A |
| GRBTP22SK | 22 x - x 1.25   | 20 | 1   | <b>\$2188</b> | N/A | <b>\$176</b> | N/A | N/A |



Round Tops, for Centered Base

**Only applicable bases to use with above tops: GRB14H25 round base or GSB13H25 square base with centered column.**

Tops feature metal inserts for ease of assembly to base. One base required.

SQUARE LAPTOP TABLES FOR CENTER BASE

**Thermally fused laminate, flat edge <sup>(1)(4)</sup>**

|         |                 |    |     |              |             |     |                |     |
|---------|-----------------|----|-----|--------------|-------------|-----|----------------|-----|
| GSBTP16 | 16.5 x 16.5 x 1 | 7  | 0.3 | <b>\$188</b> | <b>\$80</b> | N/A | <b>\$18.80</b> | N/A |
| GSBTP20 | 20 x 20 x 1     | 11 | 0.5 | <b>\$206</b> | <b>\$89</b> | N/A | <b>\$20.60</b> | N/A |
| GSBTP22 | 22 x 22 x 1     | 13 | 0.5 | <b>\$206</b> | <b>\$89</b> | N/A | <b>\$20.60</b> | N/A |

**High pressure laminate, knife edge**

|           |                    |     |     |              |     |     |     |     |
|-----------|--------------------|-----|-----|--------------|-----|-----|-----|-----|
| GSBTP16LK | 16.5 x 16.5 x 1.19 | 8.5 | 1   | <b>\$359</b> | N/A | N/A | N/A | N/A |
| GSBTP20LK | 20 x 20 x 1.19     | 13  | 1.5 | <b>\$450</b> | N/A | N/A | N/A | N/A |
| GSBTP22LK | 22 x 22 x 1.19     | 16  | 2   | <b>\$491</b> | N/A | N/A | N/A | N/A |

**Veneer <sup>(2)</sup>**

|          |                    |     |     |              |     |     |     |             |
|----------|--------------------|-----|-----|--------------|-----|-----|-----|-------------|
| GSBTP16V | 16.5 x 16.5 x 1.19 | 8.5 | 1   | <b>\$461</b> | N/A | N/A | N/A | <b>\$72</b> |
| GSBTP20V | 20 x 20 x 1.19     | 13  | 1.5 | <b>\$578</b> | N/A | N/A | N/A | <b>\$87</b> |
| GSBTP22V | 22 x 22 x 1.19     | 16  | 2   | <b>\$635</b> | N/A | N/A | N/A | <b>\$97</b> |

**Solid surface, flat edge <sup>(3)(4)</sup>**

|           |                    |    |     |               |     |              |              |     |
|-----------|--------------------|----|-----|---------------|-----|--------------|--------------|-----|
| GSBTP16SF | 16.5 x 16.5 x 1.25 | 14 | 0.6 | <b>\$1447</b> | N/A | <b>\$83</b>  | <b>\$206</b> | N/A |
| GSBTP20SF | 20 x 20 x 1.25     | 21 | 1   | <b>\$1736</b> | N/A | <b>\$123</b> | <b>\$206</b> | N/A |
| GSBTP22SF | 22 x 22 x 1.25     | 26 | 1   | <b>\$1829</b> | N/A | <b>\$147</b> | <b>\$206</b> | N/A |

**Solid surface, knife edge <sup>(3)(4)</sup>**

|           |                    |    |     |               |     |              |              |     |
|-----------|--------------------|----|-----|---------------|-----|--------------|--------------|-----|
| GSBTP16SK | 16.5 x 16.5 x 1.25 | 14 | 0.6 | <b>\$1789</b> | N/A | <b>\$100</b> | <b>\$206</b> | N/A |
| GSBTP20SK | 20 x 20 x 1.25     | 21 | 1   | <b>\$2088</b> | N/A | <b>\$130</b> | <b>\$206</b> | N/A |
| GSBTP22SK | 22 x 22 x 1.25     | 26 | 1   | <b>\$2188</b> | N/A | <b>\$176</b> | <b>\$206</b> | N/A |

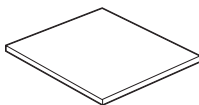

Square Tops, for Centered Base

**Only applicable bases to use with above tops: GRB14H25 round base or GSB13H25 square base with centered column.**

Tops feature metal inserts for ease of assembly to base. One base required.

**Required specifications**

Top finish  
Edge finish <sup>(1)</sup>

**Optional specifications**

HP laminate <sup>(1)</sup>  
Knife edge <sup>(2)</sup>  
Grade 2 solid surface <sup>(3)</sup>  
3" radiused corners <sup>(4)</sup>

**Applicable bases**

GRB14H25 - round  
GSB13H25 - square

# S SWAP™ TABLES

## RECTANGULAR LAPTOP TABLES FOR CENTER BASE

MODEL # DIMENSIONS WT/LB. CUBIC FT. LIST PRICE HP ADD GRADE 2 R3 ADD KS ADD

W x D x H

### Thermally fused laminate, flat edge <sup>(1)(4)</sup>

|           |             |    |     |       |      |     |         |     |
|-----------|-------------|----|-----|-------|------|-----|---------|-----|
| GSBTP1620 | 16 x 20 x 1 | 9  | 0.4 | \$206 | \$89 | N/A | \$20.60 | N/A |
| GSBTP1622 | 16 x 22 x 1 | 11 | 0.5 | \$206 | \$89 | N/A | \$20.60 | N/A |

### High pressure laminate, knife edge

|             |                |    |     |       |     |     |     |     |
|-------------|----------------|----|-----|-------|-----|-----|-----|-----|
| GSBTP1620LK | 20 x 16 x 1.19 | 11 | 1   | \$461 | N/A | N/A | N/A | N/A |
| GSBTP1622LK | 22 x 16 x 1.19 | 13 | 1.5 | \$506 | N/A | N/A | N/A | N/A |

### Veneer <sup>(2)</sup>

|            |                |    |     |       |     |     |     |      |
|------------|----------------|----|-----|-------|-----|-----|-----|------|
| GSBTP1620V | 20 x 16 x 1.19 | 11 | 1   | \$568 | N/A | N/A | N/A | \$87 |
| GSBTP1622V | 22 x 16 x 1.19 | 13 | 1.5 | \$624 | N/A | N/A | N/A | \$92 |

### Solid surface, flat edge <sup>(3)(4)</sup>

|             |                |    |     |        |     |       |       |     |
|-------------|----------------|----|-----|--------|-----|-------|-------|-----|
| GSBTP1620SF | 16 x 20 x 1.25 | 17 | 0.8 | \$1606 | N/A | \$100 | \$206 | N/A |
| GSBTP1622SF | 16 x 22 x 1.25 | 19 | 0.8 | \$1629 | N/A | \$106 | \$206 | N/A |

### Solid surface, knife edge <sup>(3)(4)</sup>

|             |                |    |     |        |     |       |       |     |
|-------------|----------------|----|-----|--------|-----|-------|-------|-----|
| GSBTP1620SK | 16 x 20 x 1.25 | 17 | 0.8 | \$1929 | N/A | \$123 | \$206 | N/A |
| GSBTP1622SK | 16 x 22 x 1.25 | 19 | 0.8 | \$1965 | N/A | \$141 | \$206 | N/A |

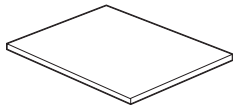

Rectangular Tops, for Centered Base

Only applicable bases to use with above tops: GRB14H25 round base or GSB13H25 square base with centered column. Tops feature metal inserts for ease of assembly to base. One base required.

## ROUND LAPTOP TABLES FOR OFFSET BASE

### Thermally fused laminate, flat edge <sup>(1)</sup>

|          |              |    |     |       |      |     |     |     |
|----------|--------------|----|-----|-------|------|-----|-----|-----|
| GRBOTP16 | 16.5 x - x 1 | 6  | 0.3 | \$188 | \$80 | N/A | N/A | N/A |
| GRBOTP20 | 20 x - x 1   | 9  | 0.5 | \$206 | \$89 | N/A | N/A | N/A |
| GRBOTP22 | 22 x - x 1   | 11 | 0.7 | \$206 | \$89 | N/A | N/A | N/A |

### High pressure laminate, knife edge

|            |                 |    |     |       |     |     |     |     |
|------------|-----------------|----|-----|-------|-----|-----|-----|-----|
| GRBOTP16LK | 16.5 x - x 1.19 | 8  | 1   | \$537 | N/A | N/A | N/A | N/A |
| GRBOTP20LK | 20 x - x 1.19   | 13 | 1.5 | \$608 | N/A | N/A | N/A | N/A |
| GRBOTP22LK | 22 x - x 1.19   | 16 | 2   | \$660 | N/A | N/A | N/A | N/A |

### Veneer <sup>(2)</sup>

|           |                 |    |     |       |     |     |     |      |
|-----------|-----------------|----|-----|-------|-----|-----|-----|------|
| GRBOTP16V | 16.5 x - x 1.19 | 8  | 1   | \$809 | N/A | N/A | N/A | \$77 |
| GRBOTP20V | 20 x - x 1.19   | 13 | 1.5 | \$875 | N/A | N/A | N/A | \$77 |
| GRBOTP22V | 22 x - x 1.19   | 16 | 2   | \$942 | N/A | N/A | N/A | \$77 |

### Solid surface, flat edge <sup>(3)</sup>

|            |                 |    |     |        |     |       |     |     |
|------------|-----------------|----|-----|--------|-----|-------|-----|-----|
| GRBOTP16SF | 16.5 x - x 1.25 | 11 | 0.6 | \$1689 | N/A | \$88  | N/A | N/A |
| GRBOTP20SF | 20 x - x 1.25   | 16 | 1   | \$1982 | N/A | \$118 | N/A | N/A |
| GRBOTP22SF | 22 x - x 1.25   | 20 | 1   | \$2077 | N/A | \$171 | N/A | N/A |

### Solid surface, knife edge <sup>(3)</sup>

|            |                 |    |     |        |     |       |     |     |
|------------|-----------------|----|-----|--------|-----|-------|-----|-----|
| GRBOTP16SK | 16.5 x - x 1.25 | 11 | 0.6 | \$1789 | N/A | \$100 | N/A | N/A |
| GRBOTP20SK | 20 x - x 1.25   | 16 | 1   | \$2088 | N/A | \$123 | N/A | N/A |
| GRBOTP22SK | 22 x - x 1.25   | 20 | 1   | \$2188 | N/A | \$176 | N/A | N/A |



Round Tops, for Offset Base

Only applicable bases to use with above tops: GSOB13H25 square base with OFFSET column. Tops feature metal inserts for ease of assembly to base. One base required.

#### Required specifications

Top finish  
Edge finish <sup>(1)</sup>

#### Optional specifications

HP laminate <sup>(1)</sup>  
Knife edge <sup>(2)</sup>  
Grade 2 solid surface <sup>(3)</sup>  
3" radiused corners <sup>(4)</sup>

#### Applicable bases

GRB14H25 - round centered  
GSB13H25 - square centered  
GSOB13H25 - square offset

**SQUARE LAPTOP TABLES FOR OFFSET BASE**

| MODEL #  | DIMENSIONS         | WT/LB. | CUBIC FT. | LIST PRICE    | HP ADD      | GRADE 2      | R3 ADD         | KS ADD      |
|--|--------------------|--------|-----------|---------------|-------------|--------------|----------------|-------------|
| W x D x H  |                    |        |           |               |             |              |                |             |
| <b>Thermally fused laminate, flat edge</b> <sup>(1)(4)</sup> |                    |        |           |               |             |              |                |             |
| GSBOTP16   | 16.5 x 16.5 x 1    | 7      | 0.3       | <b>\$188</b>  | <b>\$80</b> | N/A          | <b>\$18.80</b> | N/A         |
| GSBOTP20   | 20 x 20 x 1        | 11     | 0.5       | <b>\$206</b>  | <b>\$89</b> | N/A          | <b>\$20.60</b> | N/A         |
| GSBOTP22   | 22 x 22 x 1        | 13     | 0.7       | <b>\$206</b>  | <b>\$89</b> | N/A          | <b>\$20.60</b> | N/A         |
| <b>High pressure laminate, knife edge</b>                    |                    |        |           |               |             |              |                |             |
| GSBOTP16LK   | 16.5 x 16.5 x 1.19 | 8.5    | 1         | <b>\$359</b>  | N/A         | N/A          | N/A            | N/A         |
| GSBOTP20LK   | 20 x 20 x 1.19     | 13     | 1.5       | <b>\$450</b>  | N/A         | N/A          | N/A            | N/A         |
| GSBOTP22LK   | 22 x 22 x 1.19     | 16     | 2         | <b>\$491</b>  | N/A         | N/A          | N/A            | N/A         |
| <b>Veneer</b> <sup>(2)</sup>                                 |                    |        |           |               |             |              |                |             |
| GSBOTP16V  | 16.5 x 16.5 x 1.19 | 8.5    | 1         | <b>\$461</b>  | N/A         | N/A          | N/A            | <b>\$72</b> |
| GSBOTP20V  | 20 x 20 x 1.19     | 13     | 1.5       | <b>\$578</b>  | N/A         | N/A          | N/A            | <b>\$87</b> |
| GSBOTP22V  | 22 x 22 x 1.19     | 16     | 2         | <b>\$635</b>  | N/A         | N/A          | N/A            | <b>\$97</b> |
| <b>Solid surface, flat edge</b> <sup>(3)(4)</sup>            |                    |        |           |               |             |              |                |             |
| GSBOTP16SF   | 16.5 x 16.5 x 1.25 | 14     | 0.6       | <b>\$1447</b> | N/A         | <b>\$83</b>  | <b>\$206</b>   | N/A         |
| GSBOTP20SF   | 20 x 20 x 1.25     | 21     | 1         | <b>\$1736</b> | N/A         | <b>\$123</b> | <b>\$206</b>   | N/A         |
| GSBOTP22SF   | 22 x 22 x 1.25     | 26     | 1         | <b>\$1829</b> | N/A         | <b>\$147</b> | <b>\$206</b>   | N/A         |
| <b>Solid surface, knife edge</b> <sup>(3)(4)</sup>           |                    |        |           |               |             |              |                |             |
| GSBOTP16SK   | 16.5 x 16.5 x 1.25 | 14     | 0.6       | <b>\$1789</b> | N/A         | <b>\$100</b> | <b>\$206</b>   | N/A         |
| GSBOTP20SK   | 20 x 20 x 1.25     | 21     | 1         | <b>\$2088</b> | N/A         | <b>\$130</b> | <b>\$206</b>   | N/A         |
| GSBOTP22SK   | 22 x 22 x 1.25     | 26     | 1         | <b>\$2188</b> | N/A         | <b>\$176</b> | <b>\$206</b>   | N/A         |

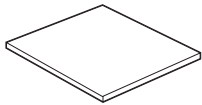

Square Tops, for Offset Base

**Only applicable bases to use with above tops: GSOB13H25 square base with OFFSET column.**  
Tops feature metal inserts for ease of assembly to base. One base required.

**RECTANGULAR LAPTOP TABLES FOR OFFSET BASE**

|  |                |    |     |               |             |              |              |             |
|--|----------------|----|-----|---------------|-------------|--------------|--------------|-------------|
| <b>Thermally fused laminate, flat edge</b> <sup>(1)(4)</sup> |                |    |     |               |             |              |              |             |
| GSBOT1620  | 16 x 20 x 1    | 9  | 0.4 | <b>\$210</b>  | <b>\$91</b> | N/A          | <b>\$21</b>  | N/A         |
| GSBOT1622  | 16 x 22 x 1    | 11 | 0.5 | <b>\$210</b>  | <b>\$91</b> | N/A          | <b>\$21</b>  | N/A         |
| <b>High pressure laminate, knife edge</b>                    |                |    |     |               |             |              |              |             |
| GSBOT1620LK  | 20 x 16 x 1.19 | 11 | 1.5 | <b>\$461</b>  | N/A         | N/A          | N/A          | N/A         |
| GSBOT1622LK  | 22 x 16 x 1.19 | 13 | 2   | <b>\$506</b>  | N/A         | N/A          | N/A          | N/A         |
| <b>Veneer</b> <sup>(2)</sup>                                 |                |    |     |               |             |              |              |             |
| GSBOT1620V   | 20 x 16 x 1.19 | 11 | 1.5 | <b>\$568</b>  | N/A         | N/A          | N/A          | <b>\$87</b> |
| GSBOT1622V   | 22 x 16 x 1.19 | 13 | 2   | <b>\$624</b>  | N/A         | N/A          | N/A          | <b>\$92</b> |
| <b>Solid surface, flat edge</b> <sup>(3)(4)</sup>            |                |    |     |               |             |              |              |             |
| GSBOT1620SF  | 16 x 20 x 1.25 | 17 | 0.8 | <b>\$1606</b> | N/A         | <b>\$100</b> | <b>\$206</b> | N/A         |
| GSBOT1622SF  | 16 x 22 x 1.25 | 19 | 0.8 | <b>\$1629</b> | N/A         | <b>\$106</b> | <b>\$206</b> | N/A         |
| <b>Solid surface, knife edge</b> <sup>(3)(4)</sup>           |                |    |     |               |             |              |              |             |
| GSBOT1620SK  | 16 x 20 x 1.25 | 17 | 0.8 | <b>\$1929</b> | N/A         | <b>\$123</b> | <b>\$206</b> | N/A         |
| GSBOT1622SK  | 16 x 22 x 1.25 | 19 | 0.8 | <b>\$1965</b> | N/A         | <b>\$141</b> | <b>\$206</b> | N/A         |

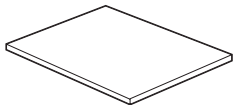

Rectangular Tops, for Offset Base

**Only applicable bases to use with above tops: GSOB13H25 square base with OFFSET column.**  
Tops feature metal inserts for ease of assembly to base. One base required.

**Required specifications**

Top finish  
Edge finish <sup>(1)</sup>

**Optional specifications**

HP laminate <sup>(1)</sup>  
Knife edge <sup>(2)</sup>  
Grade 2 solid surface <sup>(3)</sup>  
3" radiused corners <sup>(4)</sup>

**Applicable base**

GSOB13H25 - square

# S SWAP™ TABLES

| LAPTOP TABLE BASES | MODEL # | DIMENSIONS | WT/LB. | CUBIC FT. | LIST PRICE | BCH / CHM | ACO / SBR |
|--------------------|---------|------------|--------|-----------|------------|-----------|-----------|
|--------------------|---------|------------|--------|-----------|------------|-----------|-----------|

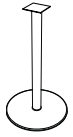

**14" Round Centered Base**

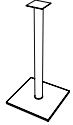

**12.5" Square Centered Base**



**12.5" Square Offset Base**

|           | W x D x H          |    |      |              |             |              |  |
|-----------|--------------------|----|------|--------------|-------------|--------------|--|
| GRB14H25  | 14 x - x 24.6      | 27 | 3.26 | <b>\$633</b> | <b>\$87</b> | <b>\$172</b> |  |
| GSB13H25  | 12.5 x 12.5 x 24.6 | 26 | 3.26 | <b>\$653</b> | <b>\$87</b> | <b>\$186</b> |  |
| GSOB13H25 | 12.5 x 12.5 x 24.6 | 26 | 3.26 | <b>\$653</b> | <b>\$87</b> | <b>\$186</b> |  |

1.5" diameter column. Weighted base for balance includes top plate, 0.5" adjustable glides to level on uneven surfaces. Screws included with base for attaching to appropriate top(s). Available in paint and plated finishes as listed on page 323. Upcharge applies on plated finishes.

**Required specifications**  
Finish

**Optional specifications**  
Plated finish

**ROUND TOPS, 24" - 36"W**

| MODEL #   | DIMENSIONS      | WT/LB. | CUBIC FT. | LIST PRICE    | HP ADD       | GRADE 2      | R3 ADD | KS ADD      |
|---|-----------------|--------|-----------|---------------|--------------|--------------|--------|-------------|
| W x D x H   |                 |        |           |               |              |              |        |             |
| <b>Thermally fused laminate, flat edge <sup>(1)</sup></b> |                 |        |           |               |              |              |        |             |
| GRBTP24   | 24 x - x 1      | 16     | 1         | <b>\$206</b>  | <b>\$91</b>  | N/A          | N/A    | N/A         |
| GRBTP30   | 30 x - x 1      | 25     | 1.5       | <b>\$239</b>  | <b>\$108</b> | N/A          | N/A    | N/A         |
| GRBTP36   | 36 x - x 1      | 36     | 2         | <b>\$303</b>  | <b>\$136</b> | N/A          | N/A    | N/A         |
| <b>High pressure laminate, knife edge</b>                 |                 |        |           |               |              |              |        |             |
| GRBTP24LK   | 24 x - x 1.19   | 19     | 2         | <b>\$845</b>  | N/A          | N/A          | N/A    | N/A         |
| GRBTP30LK   | 30 x - x 1.19   | 30     | 3         | <b>\$1038</b> | N/A          | N/A          | N/A    | N/A         |
| GRBTP36LK   | 36 x - x 1.19   | 43     | 4         | <b>\$1228</b> | N/A          | N/A          | N/A    | N/A         |
| <b>Veneer <sup>(2)</sup></b>                              |                 |        |           |               |              |              |        |             |
| GRBTP24V  | 24 x - x 1.19   | 19     | 2         | <b>\$1008</b> | N/A          | N/A          | N/A    | <b>\$77</b> |
| GRBTP30V  | 30 x - x 1.19   | 30     | 3         | <b>\$1202</b> | N/A          | N/A          | N/A    | <b>\$77</b> |
| GRBTP36V  | 36 x - x 1.19   | 43     | 4         | <b>\$1407</b> | N/A          | N/A          | N/A    | <b>\$77</b> |
| <b>Solid surface, flat edge <sup>(3)</sup></b>            |                 |        |           |               |              |              |        |             |
| GRBTP24SF   | 24 x - x 1.25   | 24     | 1.2       | <b>\$2130</b> | N/A          | <b>\$171</b> | N/A    | N/A         |
| GRBTP30SF   | 29.8 x - x 1.25 | 37     | 1.8       | <b>\$2323</b> | N/A          | <b>\$235</b> | N/A    | N/A         |
| GRBTP36SF   | 36 x - x 1.25   | 53     | 2.5       | <b>\$2970</b> | N/A          | <b>\$353</b> | N/A    | N/A         |
| <b>Solid surface, knife edge <sup>(3)</sup></b>           |                 |        |           |               |              |              |        |             |
| GRBTP24SK   | 24 x - x 1.25   | 24     | 1.2       | <b>\$2188</b> | N/A          | <b>\$183</b> | N/A    | N/A         |
| GRBTP30SK   | 29.8 x - x 1.25 | 37     | 1.8       | <b>\$2411</b> | N/A          | <b>\$253</b> | N/A    | N/A         |
| GRBTP36SK   | 36 x - x 1.25   | 53     | 2.5       | <b>\$3147</b> | N/A          | <b>\$376</b> | N/A    | N/A         |



Round Tops

**Applicable bases to use with above tops: GRB22Hxx round base or GSB19Hxx square base (15", 21", 26", 28" 35" or 40.5"H).** Tops feature metal inserts for ease of assembly to base. One base required.

**SQUARE TOPS, 24" - 36"W**

|  |                    |    |     |               |              |              |                |             |
|--|--------------------|----|-----|---------------|--------------|--------------|----------------|-------------|
| <b>Thermally fused laminate, flat edge <sup>(1)(4)</sup></b> |                    |    |     |               |              |              |                |             |
| GSBTP24  | 24 x 24 x 1        | 20 | 1   | <b>\$206</b>  | <b>\$91</b>  | N/A          | <b>\$20.60</b> | N/A         |
| GSBTP30  | 30 x 30 x 1        | 30 | 1.5 | <b>\$239</b>  | <b>\$108</b> | N/A          | <b>\$23.90</b> | N/A         |
| GSBTP36  | 36 x 36 x 1        | 44 | 2   | <b>\$303</b>  | <b>\$136</b> | N/A          | <b>\$30.30</b> | N/A         |
| <b>High pressure laminate, knife edge</b>                    |                    |    |     |               |              |              |                |             |
| GSBTP24LK  | 24 x 24 x 1.19     | 24 | 2   | <b>\$768</b>  | N/A          | N/A          | N/A            | N/A         |
| GSBTP30LK  | 30 x 30 x 1.19     | 36 | 3   | <b>\$834</b>  | N/A          | N/A          | N/A            | N/A         |
| GSBTP36LK  | 36 x 36 x 1.19     | 53 | 4   | <b>\$895</b>  | N/A          | N/A          | N/A            | N/A         |
| <b>Veneer <sup>(2)</sup></b>                                 |                    |    |     |               |              |              |                |             |
| GSBTP24V   | 24 x 24 x 1.19     | 24 | 2   | <b>\$1038</b> | N/A          | N/A          | N/A            | <b>\$72</b> |
| GSBTP30V   | 30 x 30 x 1.19     | 36 | 3   | <b>\$1100</b> | N/A          | N/A          | N/A            | <b>\$72</b> |
| GSBTP36V   | 36 x 36 x 1.19     | 53 | 4   | <b>\$1166</b> | N/A          | N/A          | N/A            | <b>\$72</b> |
| <b>Solid surface, flat edge <sup>(3)(4)</sup></b>            |                    |    |     |               |              |              |                |             |
| GSBTP24SF  | 24 x 24 x 1.25     | 30 | 1.2 | <b>\$1882</b> | N/A          | <b>\$176</b> | <b>\$206</b>   | N/A         |
| GSBTP30SF  | 29.8 x 29.8 x 1.25 | 47 | 1.8 | <b>\$2323</b> | N/A          | <b>\$235</b> | <b>\$206</b>   | N/A         |
| GSBTP36SF  | 36 x 36 x 1.25     | 68 | 2.5 | <b>\$3024</b> | N/A          | <b>\$288</b> | <b>\$206</b>   | N/A         |
| <b>Solid surface, knife edge <sup>(1)(4)</sup></b>           |                    |    |     |               |              |              |                |             |
| GSBTP24SK  | 24 x 24 x 1.25     | 30 | 1.2 | <b>\$1942</b> | N/A          | <b>\$188</b> | <b>\$206</b>   | N/A         |
| GSBTP30SK  | 29.8 x 29.8 x 1.25 | 47 | 1.8 | <b>\$2912</b> | N/A          | <b>\$265</b> | <b>\$206</b>   | N/A         |
| GSBTP36SK  | 36 x 36 x 1.25     | 68 | 2.5 | <b>\$3606</b> | N/A          | <b>\$329</b> | <b>\$206</b>   | N/A         |

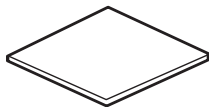

Square Tops

**Applicable bases to use with above tops: GRB22Hxx round base or GSB19Hxx square base (15", 21", 26", 28" 35" or 40.5"H).** Tops feature metal inserts for ease of assembly to base. One base required.

**Required specifications**

Top finish  
Edge finish <sup>(1)</sup>

**Optional specifications**

HP laminate <sup>(1)</sup> Knife edge <sup>(2)</sup>  
Grade 2 solid surface <sup>(3)</sup>  
3" radiused corners <sup>(4)</sup>  
Q2 cut-out for single port module

**Applicable bases**

Round bases: GRB22H15, GRB22H21, GRB22H26, GRB22, GRB22H35, GRB22H41  
Square bases: GSB19H15, GSB19H21, GSB19H26, GSB19, GSB19H35, GSB19H41

**Accessories**

Single port modules

RECTANGULAR TOPS, SMALL

MODEL # DIMENSIONS WT/LB. CUBIC FT. LIST PRICE HP ADD GRADE 2 R3 ADD KS ADD

W x D x H

**Thermally fused laminate, flat edge** <sup>(1)(4)</sup>

|           |             |    |      |              |              |     |                |     |
|-----------|-------------|----|------|--------------|--------------|-----|----------------|-----|
| GSBTP2430 | 30 x 24 x 1 | 20 | 0.91 | <b>\$235</b> | <b>\$103</b> | N/A | <b>\$23.50</b> | N/A |
| GSBTP2436 | 36 x 24 x 1 | 24 | 1.08 | <b>\$271</b> | <b>\$117</b> | N/A | <b>\$27.10</b> | N/A |
| GSBTP3036 | 36 x 30 x 1 | 31 | 1.34 | <b>\$297</b> | <b>\$128</b> | N/A | <b>\$29.70</b> | N/A |

**High pressure laminate, knife edge**

|             |                |    |     |              |     |     |     |     |
|-------------|----------------|----|-----|--------------|-----|-----|-----|-----|
| GSBTP2430LK | 30 x 24 x 1.19 | 24 | 2.5 | <b>\$768</b> | N/A | N/A | N/A | N/A |
| GSBTP2436LK | 36 x 24 x 1.19 | 29 | 3   | <b>\$895</b> | N/A | N/A | N/A | N/A |
| GSBTP3036LK | 36 x 30 x 1.19 | 37 | 3.5 | <b>\$942</b> | N/A | N/A | N/A | N/A |

**Veneer** <sup>(2)</sup>

|            |                |    |     |               |     |     |     |             |
|------------|----------------|----|-----|---------------|-----|-----|-----|-------------|
| GSBTP2430V | 30 x 24 x 1.19 | 24 | 2.5 | <b>\$1038</b> | N/A | N/A | N/A | <b>\$72</b> |
| GSBTP2436V | 36 x 24 x 1.19 | 29 | 3   | <b>\$1100</b> | N/A | N/A | N/A | <b>\$72</b> |
| GSBTP3036V | 36 x 30 x 1.19 | 37 | 3.5 | <b>\$1166</b> | N/A | N/A | N/A | <b>\$72</b> |

**Solid surface, flat edge** <sup>(3)(4)</sup>

|             |                  |    |     |               |     |              |              |     |
|-------------|------------------|----|-----|---------------|-----|--------------|--------------|-----|
| GSBTP2430SF | 24 x 29.8 x 1.25 | 38 | 1.8 | <b>\$2035</b> | N/A | <b>\$176</b> | <b>\$206</b> | N/A |
| GSBTP2436SF | 24 x 36 x 1.25   | 45 | 2.1 | <b>\$2295</b> | N/A | <b>\$223</b> | <b>\$206</b> | N/A |
| GSBTP3036SF | 29.8 x 36 x 1.25 | 57 | 2.1 | <b>\$2606</b> | N/A | <b>\$248</b> | <b>\$206</b> | N/A |

**Solid surface, knife edge** <sup>(3)(4)</sup>

|             |                  |    |     |               |     |              |              |     |
|-------------|------------------|----|-----|---------------|-----|--------------|--------------|-----|
| GSBTP2430SK | 24 x 29.8 x 1.25 | 38 | 1.8 | <b>\$2453</b> | N/A | <b>\$218</b> | <b>\$206</b> | N/A |
| GSBTP2436SK | 24 x 36 x 1.25   | 45 | 2.1 | <b>\$2664</b> | N/A | <b>\$271</b> | <b>\$206</b> | N/A |
| GSBTP3036SK | 29.8 x 36 x 1.25 | 57 | 2.1 | <b>\$3006</b> | N/A | <b>\$300</b> | <b>\$206</b> | N/A |

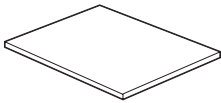

Rectangular Tops

**Applicable bases to use with above tops: GRB22Hxx round base or GSB19Hxx square base (15", 21", 26", 28" 35" or 40.5"H).** Tops feature metal inserts for ease of assembly to base. One base required.

**Required specifications**

Top finish  
Edge finish <sup>(1)</sup>

**Optional specifications**

HP laminate <sup>(1)</sup> Knife edge <sup>(2)</sup>  
Grade 2 solid surface <sup>(3)</sup>  
3" radiused corners <sup>(4)</sup>  
Q2 cut-out for single port module

**Applicable bases**

Round bases: GRB22H15, GRB22H21, GRB22H26, GRB22, GRB22H35, GRB22H41  
Square bases: GSB19H15, GSB19H21, GSB19H26, GSB19, GSB19H35, GSB19H41

**Accessories**

Single port modules

**BASES FOR TOPS 24" - 36"W      MODEL #      DIMENSIONS      WT/LB.      CUBIC FT.      LIST PRICE      BCH / CHM      ACO / SBR**

W x D x H

**BASE VALID FOR TOPS ON PAGES 333-334:**

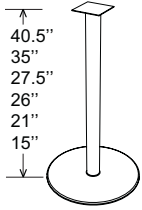

**22" Dia Round Bases <sup>(1)</sup>**

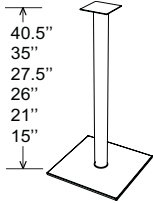

**18.5" Square Bases <sup>(1)</sup>**

|          |               |      |      |              |              |              |
|----------|---------------|------|------|--------------|--------------|--------------|
| GRB22H15 | 22 x - x 15   | 47.6 | 4.69 | <b>\$793</b> | <b>\$147</b> | <b>\$211</b> |
| GRB22H21 | 22 x - x 21   | 48.6 | 6.45 | <b>\$793</b> | <b>\$147</b> | <b>\$211</b> |
| GRB22H26 | 22 x - x 26   | 55   | 8.63 | <b>\$793</b> | <b>\$147</b> | <b>\$221</b> |
| GRB22    | 22 x - x 27.5 | 55   | 9.33 | <b>\$793</b> | <b>\$147</b> | <b>\$221</b> |
| GRB22H35 | 22 x - x 35   | 57.1 | 12   | <b>\$831</b> | <b>\$164</b> | <b>\$253</b> |
| GRB22H41 | 22 x - x 40.5 | 58.3 | 14   | <b>\$844</b> | <b>\$171</b> | <b>\$259</b> |

**GRB22H15** - coffee table height      **GRB22H26** - lounge height      **GRB22H35** - counter height  
**GRB22H21** - end table height      **GRB22** - seated height      **GRB22H41** - bar height

|          |                    |      |      |              |              |              |
|----------|--------------------|------|------|--------------|--------------|--------------|
| GSB19H15 | 18.5 x 18.5 x 15   | 43.7 | 3.52 | <b>\$857</b> | <b>\$136</b> | <b>\$204</b> |
| GSB19H21 | 18.5 x 18.5 x 21   | 44.8 | 4.84 | <b>\$857</b> | <b>\$136</b> | <b>\$204</b> |
| GSB19H26 | 18.5 x 18.5 x 26   | 50   | 5.94 | <b>\$857</b> | <b>\$136</b> | <b>\$212</b> |
| GSB19    | 18.5 x 18.5 x 27.5 | 50   | 6.06 | <b>\$857</b> | <b>\$136</b> | <b>\$212</b> |
| GSB19H35 | 18.5 x 18.5 x 35   | 51.8 | 7.52 | <b>\$906</b> | <b>\$151</b> | <b>\$262</b> |
| GSB19H41 | 18.5 x 18.5 x 40.5 | 53.2 | 8.77 | <b>\$937</b> | <b>\$166</b> | <b>\$267</b> |

**GSB19H15** - coffee table height      **GSB19H26** - lounge height      **GSB1935** - counter height  
**GSB19H21** - end table height      **GSB19** - seated height      **GSB19H41** - bar height

Base comes fully assembled and features 0.5" adjustable glides to level on uneven surfaces. Screws included with base for attaching to appropriate top(s). Base top plate and base plate include pass-through for single port power or USB module (sold separately). Available in paint and plated finishes as listed on page 323. Upcharge applies on plated finishes.

**Required specifications**  
 Finish

**Optional specifications**  
 Plated finish <sup>(1)</sup>



# S SWAP™ TABLES

## ROUND TOPS, 42" - 48"W

MODEL # DIMENSIONS WT/LB. CUBIC FT. LIST PRICE HP ADD GRADE 2 R3 ADD KS ADD

W x D x H

### Thermally fused laminate, flat edge <sup>(1)</sup>

|         |            |    |     |       |       |     |     |     |
|---------|------------|----|-----|-------|-------|-----|-----|-----|
| GRBTP42 | 42 x - x 1 | 44 | 2.5 | \$424 | \$174 | N/A | N/A | N/A |
| GRBTP48 | 48 x - x 1 | 56 | 3   | \$452 | \$188 | N/A | N/A | N/A |

### High pressure laminate, knife edge

|           |               |    |     |        |     |     |     |     |
|-----------|---------------|----|-----|--------|-----|-----|-----|-----|
| GRBTP42LK | 42 x - x 1.19 | 53 | 5   | \$1432 | N/A | N/A | N/A | N/A |
| GRBTP48LK | 48 x - x 1.19 | 67 | 6.5 | \$1637 | N/A | N/A | N/A | N/A |

### Veneer <sup>(2)</sup>

|          |               |    |     |        |     |     |     |      |
|----------|---------------|----|-----|--------|-----|-----|-----|------|
| GRBTP42V | 42 x - x 1.19 | 53 | 5   | \$1718 | N/A | N/A | N/A | \$72 |
| GRBTP48V | 48 x - x 1.19 | 67 | 6.5 | \$1965 | N/A | N/A | N/A | \$81 |

### Solid surface, flat edge <sup>(3)</sup>

|           |               |    |     |        |     |       |     |     |
|-----------|---------------|----|-----|--------|-----|-------|-----|-----|
| GRBTP42SF | 42 x - x 1.25 | 73 | 3.4 | \$4029 | N/A | \$453 | N/A | N/A |
| GRBTP48SF | 48 x - x 1.25 | 95 | 4.3 | \$4588 | N/A | \$576 | N/A | N/A |

### Solid surface, knife edge <sup>(3)</sup>

|           |               |    |     |        |     |       |     |     |
|-----------|---------------|----|-----|--------|-----|-------|-----|-----|
| GRBTP42SK | 42 x - x 1.25 | 73 | 3.4 | \$4242 | N/A | \$506 | N/A | N/A |
| GRBTP48SK | 48 x - x 1.25 | 95 | 4.3 | \$5117 | N/A | \$641 | N/A | N/A |



Round Tops

Applicable bases to use with above tops: GRB28 round base or GSB23 square base (28"H). Tops feature metal inserts for ease of assembly to base. One base required.

## SQUARE/RECTANGULAR TOPS, 42"W

### Thermally fused laminate, flat edge <sup>(1)(4)</sup>

|           |             |    |      |       |       |     |         |     |
|-----------|-------------|----|------|-------|-------|-----|---------|-----|
| GSBTP3042 | 42 x 30 x 1 | 36 | 1.55 | \$392 | \$169 | N/A | \$39.20 | N/A |
| GSBTP3642 | 42 x 36 x 1 | 43 | 1.86 | \$421 | \$182 | N/A | \$42.10 | N/A |
| GSBTP42   | 42 x 42 x 1 | 58 | 2.5  | \$424 | \$174 | N/A | \$42.40 | N/A |

### High pressure laminate, knife edge

|             |                |    |     |        |     |     |     |     |
|-------------|----------------|----|-----|--------|-----|-----|-----|-----|
| GSBTP3042LK | 42 x 30 x 1.19 | 43 | 4   | \$1013 | N/A | N/A | N/A | N/A |
| GSBTP3642LK | 42 x 36 x 1.19 | 52 | 4.5 | \$1075 | N/A | N/A | N/A | N/A |
| GSBTP42LK   | 42 x 42 x 1.19 | 70 | 5   | \$1120 | N/A | N/A | N/A | N/A |

### Veneer <sup>(2)</sup>

|            |                |    |     |        |     |     |     |      |
|------------|----------------|----|-----|--------|-----|-----|-----|------|
| GSBTP3042V | 42 x 30 x 1.19 | 43 | 4   | \$1274 | N/A | N/A | N/A | \$56 |
| GSBTP3642V | 42 x 36 x 1.19 | 52 | 4.5 | \$1330 | N/A | N/A | N/A | \$66 |
| GSBTP42V   | 42 x 42 x 1.19 | 70 | 5   | \$1560 | N/A | N/A | N/A | \$72 |

### Solid surface, flat edge <sup>(3)(4)</sup>

|             |                  |    |     |        |     |       |       |     |
|-------------|------------------|----|-----|--------|-----|-------|-------|-----|
| GSBTP3042SF | 29.8 x 42 x 1.25 | 66 | 2.9 | \$2736 | N/A | \$300 | \$206 | N/A |
| GSBTP3642SF | 36 x 42 x 1.25   | 79 | 2.9 | \$3511 | N/A | \$400 | \$206 | N/A |
| GSBTP42SF   | 42 x 42 x 1.25   | 92 | 3.4 | \$3659 | N/A | \$436 | \$206 | N/A |

### Solid surface, knife edge <sup>(3)(4)</sup>

|             |                  |    |     |        |     |       |       |     |
|-------------|------------------|----|-----|--------|-----|-------|-------|-----|
| GSBTP3042SK | 29.8 x 42 x 1.25 | 66 | 2.9 | \$3205 | N/A | \$353 | \$206 | N/A |
| GSBTP3642SK | 36 x 42 x 1.25   | 79 | 2.9 | \$4052 | N/A | \$476 | \$206 | N/A |
| GSBTP42SK   | 42 x 42 x 1.25   | 92 | 3.4 | \$4242 | N/A | \$529 | \$206 | N/A |

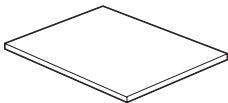

Rectangular Tops

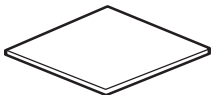

Square Tops

Applicable bases to use with above tops: GRB28 round base or GSB23 square base (28"H). Tops feature metal inserts for ease of assembly to base. One base required.

#### Required specifications

Top finish  
Edge finish <sup>(1)</sup>

#### Optional specifications

HP laminate <sup>(1)</sup>  
Knife edge <sup>(2)</sup>  
Grade 2 solid surface <sup>(3)</sup>  
3" radiused corners <sup>(4)</sup>

#### Applicable bases

GRB28 - round  
GSB23 - square

**BASES FOR TOPS 42" - 48"W      MODEL #      DIMENSIONS      WT/LB.      CUBIC FT.      LIST PRICE      BCH / CHM      ACO / SBR**

W x D x H

**BASES VALID FOR TOPS ON PAGE 336:**

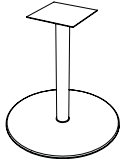

**28" Dia Round Base**

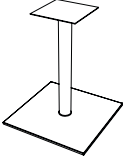

**23" Square Base**

|               |               |     |       |               |              |              |
|---------------|---------------|-----|-------|---------------|--------------|--------------|
| GRB28         | 28 x - x 27.5 | 100 | 15.63 | <b>\$1250</b> | <b>\$147</b> | <b>\$372</b> |
| seated height |               |     |       |               |              |              |

|               |                    |    |      |               |              |              |
|---------------|--------------------|----|------|---------------|--------------|--------------|
| GSB23         | 22.5 x 22.5 x 27.5 | 82 | 9.33 | <b>\$1146</b> | <b>\$136</b> | <b>\$235</b> |
| seated height |                    |    |      |               |              |              |

Base comes fully assembled and features 0.5" adjustable glides to level on uneven surfaces. Screws included with base for attaching to appropriate top(s). Available in paint and plated finishes as listed on page 323. Upcharge applies on plated finishes.

**Required Specifications**  
Finish

**Optional Specifications**  
Plated finish

# S SWAP™ TABLES

## ROUND TOPS, 54" - 60"W

| MODEL # | DIMENSIONS | WT/LB. | CUBIC FT. | LIST PRICE | HP ADD | GRADE 2 | R3 ADD | KS ADD |
|---------|------------|--------|-----------|------------|--------|---------|--------|--------|
|---------|------------|--------|-----------|------------|--------|---------|--------|--------|

W x D x H

### Thermally fused laminate, flat edge <sup>(1)</sup>

|         |            |    |     |              |              |     |     |     |
|---------|------------|----|-----|--------------|--------------|-----|-----|-----|
| GRBTP54 | 54 x - x 1 | 73 | 4.5 | <b>\$603</b> | <b>\$271</b> | N/A | N/A | N/A |
| GRBTP60 | 60 x - x 1 | 92 | 5   | <b>\$627</b> | <b>\$282</b> | N/A | N/A | N/A |

### High pressure laminate, knife edge

|           |               |     |    |               |     |     |     |     |
|-----------|---------------|-----|----|---------------|-----|-----|-----|-----|
| GRBTP54LK | 54 x - x 1.19 | 88  | 8  | <b>\$1847</b> | N/A | N/A | N/A | N/A |
| GRBTP60LK | 60 x - x 1.19 | 110 | 10 | <b>\$2276</b> | N/A | N/A | N/A | N/A |

### Veneer <sup>(2)</sup>

|          |               |     |    |               |     |     |     |              |
|----------|---------------|-----|----|---------------|-----|-----|-----|--------------|
| GRBTP54V | 54 x - x 1.19 | 88  | 8  | <b>\$2507</b> | N/A | N/A | N/A | <b>\$97</b>  |
| GRBTP60V | 60 x - x 1.19 | 110 | 10 | <b>\$3094</b> | N/A | N/A | N/A | <b>\$102</b> |

### Solid surface, flat edge <sup>(3)</sup>

|           |               |     |     |               |     |              |     |     |
|-----------|---------------|-----|-----|---------------|-----|--------------|-----|-----|
| GRBTP54SF | 54 x - x 1.25 | 120 | 5.4 | <b>\$4971</b> | N/A | <b>\$706</b> | N/A | N/A |
| GRBTP60SF | 60 x - x 1.25 | 148 | 6.7 | <b>\$6530</b> | N/A | <b>\$882</b> | N/A | N/A |

### Solid surface, knife edge <sup>(3)</sup>

|           |               |     |     |               |     |               |     |     |
|-----------|---------------|-----|-----|---------------|-----|---------------|-----|-----|
| GRBTP54SK | 54 x - x 1.25 | 120 | 5.4 | <b>\$5876</b> | N/A | <b>\$888</b>  | N/A | N/A |
| GRBTP60SK | 60 x - x 1.25 | 148 | 6.7 | <b>\$7189</b> | N/A | <b>\$1077</b> | N/A | N/A |



Round Tops

**Applicable bases to use with above tops: GRB34 round base or GSB28 square base (28"H).** Tops feature metal inserts for ease of assembly to base. One base required.

## BASES FOR TOPS 54" - 60"W

| MODEL # | DIMENSIONS | WT/LB. | CUBIC FT. | LIST PRICE | BCH / CHM | ACO / SBR |
|---------|------------|--------|-----------|------------|-----------|-----------|
|---------|------------|--------|-----------|------------|-----------|-----------|

W x D x H

### BASES VALID FOR TOPS ABOVE:

Order the quantity of bases as indicated by each top size.

|       |               |     |       |               |              |              |
|-------|---------------|-----|-------|---------------|--------------|--------------|
| GRB34 | 34 x - x 27.5 | 135 | 20.56 | <b>\$1538</b> | <b>\$147</b> | <b>\$449</b> |
|-------|---------------|-----|-------|---------------|--------------|--------------|

seated height

|       |                    |     |       |               |              |              |
|-------|--------------------|-----|-------|---------------|--------------|--------------|
| GSB28 | 28.5 x 28.5 x 27.5 | 125 | 15.63 | <b>\$1432</b> | <b>\$136</b> | <b>\$242</b> |
|-------|--------------------|-----|-------|---------------|--------------|--------------|

seated height

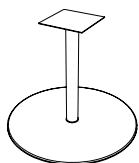

34" Dia Round Base

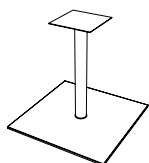

28" Square Base

Base comes fully assembled and features 0.5" adjustable glides to level on uneven surfaces. Screws included with base for attaching to appropriate top(s). Available in paint and plated finishes as listed on page 323. Upcharge applies on plated finishes.

### Required specifications

Top finish  
Edge finish <sup>(1)</sup>  
Base finish

### Optional specifications

HP laminate <sup>(1)</sup>  
Knife edge <sup>(2)</sup>  
Grade 2 solid surface <sup>(3)</sup>  
Base plated finish

### Applicable bases

GRB34 - round  
GSB28 - square

**RECTANGULAR LOUNGE TOPS, 24" D**      **MODEL #**      **DIMENSIONS**      **WT/LB.**      **CUBIC FT.**      **LIST PRICE**      **HP ADD**      **GRADE 2**      **R3 ADD**      **KS ADD**

W x D x H

**Thermally fused laminate, flat edge** <sup>(1)(4)</sup>

|          |             |    |      |              |              |     |                |     |
|----------|-------------|----|------|--------------|--------------|-----|----------------|-----|
| GRT5STP  | 60 x 24 x 1 | 41 | 1.79 | <b>\$406</b> | <b>\$173</b> | N/A | <b>\$40.60</b> | N/A |
| GRT5HSTP | 66 x 24 x 1 | 46 | 1.97 | <b>\$474</b> | <b>\$173</b> | N/A | <b>\$47.40</b> | N/A |
| GRT6STP  | 72 x 24 x 1 | 49 | 2.14 | <b>\$494</b> | <b>\$184</b> | N/A | <b>\$49.40</b> | N/A |
| GRT7STP  | 84 x 24 x 1 | 57 | 2.49 | <b>\$573</b> | <b>\$219</b> | N/A | <b>\$49.40</b> | N/A |
| GRT8STP  | 96 x 24 x 1 | 66 | 2.84 | <b>\$615</b> | <b>\$240</b> | N/A | <b>\$61.50</b> | N/A |

**High pressure laminate, knife edge**

|            |                |    |     |               |     |     |     |     |
|------------|----------------|----|-----|---------------|-----|-----|-----|-----|
| GRT5STPLK  | 60 x 24 x 1.19 | 49 | 4   | <b>\$1100</b> | N/A | N/A | N/A | N/A |
| GRT5HSTPLK | 66 x 24 x 1.19 | 55 | 4.5 | <b>\$1166</b> | N/A | N/A | N/A | N/A |
| GRT6STPLK  | 72 x 24 x 1.19 | 59 | 5   | <b>\$1228</b> | N/A | N/A | N/A | N/A |
| GRT7STPLK  | 84 x 24 x 1.19 | 68 | 5.5 | <b>\$1356</b> | N/A | N/A | N/A | N/A |
| GRT8STPLK  | 96 x 24 x 1.19 | 79 | 6.5 | <b>\$1535</b> | N/A | N/A | N/A | N/A |

**Veneer** <sup>(2)</sup>

|           |                |    |     |               |     |     |     |             |
|-----------|----------------|----|-----|---------------|-----|-----|-----|-------------|
| GRT5STPV  | 60 x 24 x 1.19 | 49 | 4   | <b>\$1356</b> | N/A | N/A | N/A | <b>\$66</b> |
| GRT5HSTPV | 66 x 24 x 1.19 | 55 | 4.5 | <b>\$1422</b> | N/A | N/A | N/A | <b>\$66</b> |
| GRT6STPV  | 72 x 24 x 1.19 | 59 | 5   | <b>\$1550</b> | N/A | N/A | N/A | <b>\$66</b> |
| GRT7STPV  | 84 x 24 x 1.19 | 68 | 5.5 | <b>\$1806</b> | N/A | N/A | N/A | <b>\$66</b> |
| GRT8STPV  | 96 x 24 x 1.19 | 79 | 6.5 | <b>\$2061</b> | N/A | N/A | N/A | <b>\$66</b> |

**Solid surface, flat edge** <sup>(3)(4)</sup>

|            |                  |     |     |               |     |              |              |     |
|------------|------------------|-----|-----|---------------|-----|--------------|--------------|-----|
| GRT5STPSF  | 60 x 24 x 1.25   | 75  | 2.8 | <b>\$3941</b> | N/A | <b>\$441</b> | <b>\$206</b> | N/A |
| GRT5HSTPSF | 66 x 24 x 1.25   | 83  | 3.1 | <b>\$4117</b> | N/A | <b>\$453</b> | <b>\$206</b> | N/A |
| GRT6STPSF  | 71.8 x 24 x 1.25 | 90  | 3.3 | <b>\$4341</b> | N/A | <b>\$464</b> | <b>\$206</b> | N/A |
| GRT7STPSF  | 84 x 24 x 1.25   | 105 | 3.9 | <b>\$4824</b> | N/A | <b>\$606</b> | <b>\$206</b> | N/A |
| GRT8STPSF  | 96 x 24 x 1.25   | 120 | 4.4 | <b>\$5294</b> | N/A | <b>\$617</b> | <b>\$206</b> | N/A |

**Solid surface, knife edge** <sup>(3)(4)</sup>

|            |                  |     |     |               |     |              |              |     |
|------------|------------------|-----|-----|---------------|-----|--------------|--------------|-----|
| GRT5STPSK  | 60 x 24 x 1.25   | 75  | 2.8 | <b>\$4441</b> | N/A | <b>\$471</b> | <b>\$206</b> | N/A |
| GRT5HSTPSK | 66 x 24 x 1.25   | 83  | 3.1 | <b>\$4618</b> | N/A | <b>\$494</b> | <b>\$206</b> | N/A |
| GRT6STPSK  | 71.8 x 24 x 1.25 | 90  | 3.3 | <b>\$4841</b> | N/A | <b>\$518</b> | <b>\$206</b> | N/A |
| GRT7STPSK  | 84 x 24 x 1.25   | 105 | 3.9 | <b>\$5518</b> | N/A | <b>\$671</b> | <b>\$206</b> | N/A |
| GRT8STPSK  | 96 x 24 x 1.25   | 120 | 4.4 | <b>\$6006</b> | N/A | <b>\$694</b> | <b>\$206</b> | N/A |

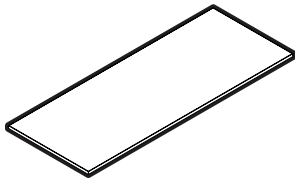

**Rectangular Tops**

**Applicable bases to use with above tops - two bases required: GRB22Hxx round bases or GSB19Hxx square bases (26", 35" or 40.5" H).** Tops feature metal inserts for ease of assembly to base. 24"D tops not recommended with 28"H bases.

**Required specifications**

Top finish  
Edge finish <sup>(1)</sup>

**Optional specifications**

HP laminate <sup>(1)</sup>      Knife edge <sup>(2)</sup>  
Grade 2 solid surface <sup>(3)</sup>  
3" radiused corners <sup>(4)</sup>  
Grommet position or power block cut-out

**Applicable bases (two required)**

Round bases:  
GRB22H26, GRB22H35, GRB22H41  
Square bases:  
GSB19H26, GSB19H35, GSB19H41

**Accessories**

Power block

RACETRACK LOUNGE TOPS, 24"D

MODEL # DIMENSIONS WT/LB. CUBIC FT. LIST PRICE HP ADD KS ADD

W x D x H

**Thermally fused laminate, flat edge <sup>(1)</sup>**

|          |             |    |      |              |              |     |
|----------|-------------|----|------|--------------|--------------|-----|
| GRC5STP  | 60 x 24 x 1 | 41 | 1.79 | <b>\$406</b> | <b>\$173</b> | N/A |
| GRC5HSTP | 66 x 24 x 1 | 46 | 1.97 | <b>\$474</b> | <b>\$173</b> | N/A |
| GRC6STP  | 72 x 24 x 1 | 49 | 2.14 | <b>\$494</b> | <b>\$185</b> | N/A |
| GRC7STP  | 84 x 24 x 1 | 57 | 2.49 | <b>\$573</b> | <b>\$222</b> | N/A |
| GRC8STP  | 96 x 24 x 1 | 66 | 2.84 | <b>\$615</b> | <b>\$244</b> | N/A |

**High pressure laminate, knife edge**

|            |                |    |     |               |     |     |
|------------|----------------|----|-----|---------------|-----|-----|
| GRC5STPLK  | 60 x 24 x 1.19 | 49 | 4   | <b>\$1356</b> | N/A | N/A |
| GRC5HSTPLK | 66 x 24 x 1.19 | 55 | 4.5 | <b>\$1484</b> | N/A | N/A |
| GRC6STPLK  | 72 x 24 x 1.19 | 59 | 5   | <b>\$1612</b> | N/A | N/A |
| GRC7STPLK  | 84 x 24 x 1.19 | 68 | 5.5 | <b>\$1739</b> | N/A | N/A |
| GRC8STPLK  | 96 x 24 x 1.19 | 79 | 6.5 | <b>\$1868</b> | N/A | N/A |

**Veneer <sup>(2)</sup>**

|           |                |    |     |               |     |              |
|-----------|----------------|----|-----|---------------|-----|--------------|
| GRC5STPV  | 60 x 24 x 1.19 | 49 | 4   | <b>\$1612</b> | N/A | <b>\$230</b> |
| GRC5HSTPV | 66 x 24 x 1.19 | 55 | 4.5 | <b>\$1766</b> | N/A | <b>\$256</b> |
| GRC6STPV  | 72 x 24 x 1.19 | 59 | 5   | <b>\$1918</b> | N/A | <b>\$275</b> |
| GRC7STPV  | 84 x 24 x 1.19 | 68 | 5.5 | <b>\$2225</b> | N/A | <b>\$275</b> |
| GRC8STPV  | 96 x 24 x 1.19 | 79 | 6.5 | <b>\$2532</b> | N/A | <b>\$275</b> |

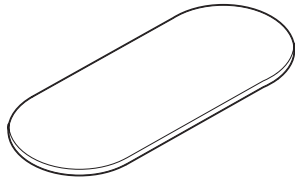

Racetrack Tops

**Applicable bases to use with above tops - two bases required: GRB22Hxx round bases or GSB19Hxx square bases (26", 35" or 40.5" H).** Tops feature metal inserts for ease of assembly to base. 24"D tops not recommended with 28"H bases.

**Required specifications**

Top finish  
Edge finish <sup>(1)</sup>

**Optional specifications**

HP laminate <sup>(1)</sup>  
Knife edge <sup>(2)</sup>  
Grommet position or power block cut-out

**Applicable bases (two required)**

Round bases:  
GRB22H26, GRB22H35, GRB22H41  
Square bases:  
GSB19H26, GSB19H35, GSB19H41

**Accessories**

Power block

RECTANGULAR TOPS, 60" - 96"W

| MODEL # | DIMENSIONS | WT/LB. | CUBIC FT. | LIST PRICE | HP ADD | GRADE 2 | R3 ADD | KS ADD |
|---------|------------|--------|-----------|------------|--------|---------|--------|--------|
|---------|------------|--------|-----------|------------|--------|---------|--------|--------|

W x D x H

**Thermally fused laminate, flat edge** <sup>(1)(4)</sup>

|          |             |    |      |       |       |     |         |     |
|----------|-------------|----|------|-------|-------|-----|---------|-----|
| GRT5NTP  | 60 x 30 x 1 | 46 | 2.5  | \$414 | \$173 | N/A | \$41.40 | N/A |
| GRT5NHTP | 66 x 30 x 1 | 56 | 2.44 | \$443 | \$184 | N/A | \$44.30 | N/A |
| GRT6NTP  | 72 x 30 x 1 | 62 | 3    | \$449 | \$194 | N/A | \$44.90 | N/A |
| GRT7NTP  | 84 x 30 x 1 | 72 | 7.5  | \$536 | \$231 | N/A | \$53.60 | N/A |
| GRT8NTP  | 96 x 30 x 1 | 80 | 8.5  | \$592 | \$241 | N/A | \$59.20 | N/A |
| GRT5TP   | 60 x 36 x 1 | 70 | 6.6  | \$472 | \$188 | N/A | \$47.20 | N/A |
| GRT5HTP  | 66 x 36 x 1 | 79 | 7.21 | \$481 | \$195 | N/A | \$48.10 | N/A |
| GRT6TP   | 72 x 36 x 1 | 72 | 8    | \$481 | \$195 | N/A | \$48.10 | N/A |
| GRT7TP   | 84 x 36 x 1 | 85 | 8.75 | \$591 | \$241 | N/A | \$59.10 | N/A |
| GRT8TP   | 96 x 36 x 1 | 94 | 9    | \$648 | \$275 | N/A | \$64.80 | N/A |

**High pressure laminate, knife edge**

|            |                |     |     |        |     |     |     |     |
|------------|----------------|-----|-----|--------|-----|-----|-----|-----|
| GRT5NTPLK  | 60 x 30 x 1.19 | 55  | 5   | \$1218 | N/A | N/A | N/A | N/A |
| GRT5NHTPLK | 66 x 30 x 1.19 | 67  | 5.5 | \$1330 | N/A | N/A | N/A | N/A |
| GRT6NTPLK  | 72 x 30 x 1.19 | 74  | 6   | \$1448 | N/A | N/A | N/A | N/A |
| GRT7NTPLK  | 84 x 30 x 1.19 | 86  | 7   | \$1668 | N/A | N/A | N/A | N/A |
| GRT8NTPLK  | 96 x 30 x 1.19 | 96  | 8   | \$1898 | N/A | N/A | N/A | N/A |
| GRT5TPLK   | 60 x 36 x 1.19 | 84  | 6   | \$1448 | N/A | N/A | N/A | N/A |
| GRT5HTPLK  | 66 x 36 x 1.19 | 95  | 6.5 | \$1581 | N/A | N/A | N/A | N/A |
| GRT6TPLK   | 72 x 36 x 1.19 | 86  | 7   | \$1719 | N/A | N/A | N/A | N/A |
| GRT7TPLK   | 84 x 36 x 1.19 | 102 | 8   | \$1990 | N/A | N/A | N/A | N/A |
| GRT8TPLK   | 96 x 36 x 1.19 | 113 | 9   | \$2266 | N/A | N/A | N/A | N/A |

**Veneer** <sup>(2)</sup>

|           |                |     |     |        |     |     |     |       |
|-----------|----------------|-----|-----|--------|-----|-----|-----|-------|
| GRT5NTPV  | 60 x 30 x 1.19 | 55  | 5   | \$1663 | N/A | N/A | N/A | \$77  |
| GRT5NHTPV | 66 x 30 x 1.19 | 67  | 5.5 | \$1770 | N/A | N/A | N/A | \$77  |
| GRT6NTPV  | 72 x 30 x 1.19 | 74  | 6   | \$1898 | N/A | N/A | N/A | \$97  |
| GRT7NTPV  | 84 x 30 x 1.19 | 86  | 7   | \$2204 | N/A | N/A | N/A | \$112 |
| GRT8NTPV  | 96 x 30 x 1.19 | 96  | 8   | \$2507 | N/A | N/A | N/A | \$128 |
| GRT5TPV   | 60 x 36 x 1.19 | 84  | 6   | \$1898 | N/A | N/A | N/A | \$97  |
| GRT5HTPV  | 66 x 36 x 1.19 | 95  | 6.5 | \$2072 | N/A | N/A | N/A | \$128 |
| GRT6TPV   | 72 x 36 x 1.19 | 86  | 7   | \$2251 | N/A | N/A | N/A | \$143 |
| GRT7TPV   | 84 x 36 x 1.19 | 102 | 8   | \$2614 | N/A | N/A | N/A | \$164 |
| GRT8TPV   | 96 x 36 x 1.19 | 113 | 9   | \$2982 | N/A | N/A | N/A | \$179 |

**Solid surface, flat edge** <sup>(3)(4)</sup>

|            |                    |     |     |        |     |       |       |     |
|------------|--------------------|-----|-----|--------|-----|-------|-------|-----|
| GRT5NTPSF  | 60 x 29.8 x 1.25   | 94  | 3.4 | \$4106 | N/A | \$436 | \$206 | N/A |
| GRT5NHTPSF | 66 x 29.8 x 1.25   | 104 | 3.8 | \$4406 | N/A | \$506 | \$206 | N/A |
| GRT6NTPSF  | 71.8 x 29.8 x 1.25 | 113 | 4.1 | \$5029 | N/A | \$706 | \$206 | N/A |
| GRT7NTPSF  | 84 x 29.8 x 1.25   | 132 | 4.8 | \$5836 | N/A | \$694 | \$206 | N/A |
| GRT8NTPSF  | 96 x 29.8 x 1.25   | 150 | 5.4 | \$6423 | N/A | \$900 | \$206 | N/A |
| GRT5TPSF   | 60 x 36 x 1.25     | 113 | 4.1 | \$5465 | N/A | \$647 | \$206 | N/A |
| GRT5HTPSF  | 66 x 36 x 1.25     | 124 | 4.5 | \$5641 | N/A | \$647 | \$206 | N/A |
| GRT6TPSF   | 71.8 x 36 x 1.25   | 135 | 4.9 | \$6229 | N/A | \$706 | \$206 | N/A |
| GRT7TPSF   | 84 x 36 x 1.25     | 158 | 5.7 | \$6776 | N/A | \$853 | \$206 | N/A |
| GRT8TPSF   | 96 x 36 x 1.25     | 180 | 6.5 | \$7271 | N/A | \$894 | \$206 | N/A |

**Solid surface, knife edge** <sup>(3)(4)</sup>

|            |                    |     |     |        |     |        |       |     |
|------------|--------------------|-----|-----|--------|-----|--------|-------|-----|
| GRT5NTPSK  | 60 x 29.8 x 1.25   | 94  | 3.4 | \$4494 | N/A | \$494  | \$206 | N/A |
| GRT5NHTPSK | 66 x 29.8 x 1.25   | 104 | 3.8 | \$4853 | N/A | \$576  | \$206 | N/A |
| GRT6NTPSK  | 71.8 x 29.8 x 1.25 | 113 | 4.1 | \$5470 | N/A | \$789  | \$206 | N/A |
| GRT7NTPSK  | 84 x 29.8 x 1.25   | 132 | 4.8 | \$6277 | N/A | \$789  | \$206 | N/A |
| GRT8NTPSK  | 96 x 29.8 x 1.25   | 150 | 5.4 | \$6971 | N/A | \$1005 | \$206 | N/A |
| GRT5TPSK   | 60 x 36 x 1.25     | 113 | 4.1 | \$6053 | N/A | \$729  | \$206 | N/A |
| GRT5HTPSK  | 66 x 36 x 1.25     | 124 | 4.5 | \$6206 | N/A | \$741  | \$206 | N/A |
| GRT6TPSK   | 71.8 x 36 x 1.25   | 135 | 4.9 | \$6876 | N/A | \$812  | \$206 | N/A |
| GRT7TPSK   | 84 x 36 x 1.25     | 158 | 5.7 | \$7429 | N/A | \$970  | \$206 | N/A |
| GRT8TPSK   | 96 x 36 x 1.25     | 180 | 6.5 | \$7911 | N/A | \$1023 | \$206 | N/A |

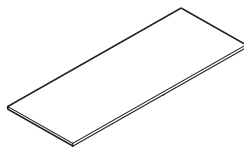

Rectangular Tops

**Applicable bases to use with above tops - two bases required: GRB22H26, GRB22, GRB22H35, GRB22H41 round bases or GSB19H26, GSB19, GSB19H35, GSB19H41 square bases.** Tops feature metal inserts for ease of assembly to base.

**Required specifications**

Top finish  
Edge finish <sup>(1)</sup>

**Optional specifications**

HP laminate <sup>(1)</sup> Knife edge <sup>(2)</sup>  
Grade 2 solid surface <sup>(3)</sup>  
3" radiused corners <sup>(4)</sup>  
Grommet position or power block cut-out

**Applicable bases (two required)**

Round bases:  
GRB22H26, GRB22, GRB22H35, GRB22H41  
Square bases:  
GSB19H26, GSB19, GSB19H35, GSB19H41

**Accessories**

Power block

RACETRACK TOPS, 60" - 96"W

MODEL # DIMENSIONS WT/LB. CUBIC FT. LIST PRICE HP ADD KS ADD

W x D x H

**Thermally fused laminate, flat edge <sup>(1)</sup>**

|          |             |    |      |       |       |     |
|----------|-------------|----|------|-------|-------|-----|
| GRC5NTP  | 60 x 30 x 1 | 46 | 2.5  | \$422 | \$178 | N/A |
| GRC5NHTP | 66 x 30 x 1 | 56 | 2.44 | \$457 | \$187 | N/A |
| GRC6NTP  | 72 x 30 x 1 | 62 | 3    | \$459 | \$195 | N/A |
| GRC7NTP  | 84 x 30 x 1 | 72 | 7.5  | \$548 | \$233 | N/A |
| GRC8NTP  | 96 x 30 x 1 | 80 | 8.5  | \$601 | \$244 | N/A |
| GRC5TP   | 60 x 36 x 1 | 70 | 6.6  | \$483 | \$195 | N/A |
| GRC5HTP  | 66 x 36 x 1 | 79 | 7.21 | \$488 | \$199 | N/A |
| GRC6TP   | 72 x 36 x 1 | 72 | 7.5  | \$488 | \$199 | N/A |
| GRC7TP   | 84 x 36 x 1 | 85 | 8.75 | \$600 | \$244 | N/A |
| GRC8TP   | 96 x 36 x 1 | 94 | 9    | \$659 | \$275 | N/A |

**High pressure laminate, knife edge**

|            |                |     |     |        |     |     |
|------------|----------------|-----|-----|--------|-----|-----|
| GRC5NTPLK  | 60 x 30 x 1.19 | 55  | 5   | \$1673 | N/A | N/A |
| GRC5NHTPLK | 66 x 30 x 1.19 | 67  | 5.5 | \$1826 | N/A | N/A |
| GRC6NTPLK  | 72 x 30 x 1.19 | 74  | 6   | \$1990 | N/A | N/A |
| GRC7NTPLK  | 84 x 30 x 1.19 | 86  | 7   | \$2133 | N/A | N/A |
| GRC8NTPLK  | 96 x 30 x 1.19 | 96  | 8   | \$2287 | N/A | N/A |
| GRC5TPLK   | 60 x 36 x 1.19 | 84  | 6   | \$1826 | N/A | N/A |
| GRC5HTPLK  | 66 x 36 x 1.19 | 95  | 6.5 | \$1980 | N/A | N/A |
| GRC6TPLK   | 72 x 36 x 1.19 | 86  | 7   | \$2144 | N/A | N/A |
| GRC7TPLK   | 84 x 36 x 1.19 | 102 | 8   | \$2451 | N/A | N/A |
| GRC8TPLK   | 96 x 36 x 1.19 | 113 | 9   | \$2758 | N/A | N/A |

**Veneer <sup>(2)</sup>**

|           |                |     |     |        |     |       |
|-----------|----------------|-----|-----|--------|-----|-------|
| GRC5NTPV  | 60 x 30 x 1.19 | 55  | 5   | \$1882 | N/A | \$271 |
| GRC5NHTPV | 66 x 30 x 1.19 | 67  | 5.5 | \$2026 | N/A | \$292 |
| GRC6NTPV  | 72 x 30 x 1.19 | 74  | 6   | \$2175 | N/A | \$312 |
| GRC7NTPV  | 84 x 30 x 1.19 | 86  | 7   | \$2527 | N/A | \$363 |
| GRC8NTPV  | 96 x 30 x 1.19 | 96  | 8   | \$2870 | N/A | \$415 |
| GRC5TPV   | 60 x 36 x 1.19 | 84  | 6   | \$2175 | N/A | \$312 |
| GRC5HTPV  | 66 x 36 x 1.19 | 95  | 6.5 | \$2374 | N/A | \$343 |
| GRC6TPV   | 72 x 36 x 1.19 | 86  | 7   | \$2578 | N/A | \$373 |
| GRC7TPV   | 84 x 36 x 1.19 | 102 | 8   | \$2998 | N/A | \$435 |
| GRC8TPV   | 96 x 36 x 1.19 | 113 | 9   | \$3417 | N/A | \$496 |

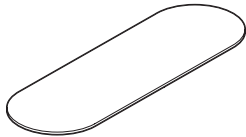

Racetrack Tops

**Applicable bases to use with above tops - two bases required: GRB22H26, GRB22, GRB22H35, GRB22H41 round bases or GSB19H26, GSB19, GSB19H35, GSB19H41 square bases.** Tops feature metal inserts for ease of assembly to base.

**Required specifications**

Top finish  
Edge finish <sup>(1)</sup>

**Optional specifications**

HP laminate <sup>(1)</sup>  
Knife edge <sup>(2)</sup>  
Grommet position or power block cut-out

**Applicable bases (two required)**

Round bases:  
GRB22H26, GRB22, GRB22H35, GRB22H41  
Square bases:  
GSB19H26, GSB19, GSB19H35, GSB19H41

**Accessories**

Power block

**BOAT SHAPE TOPS, 60" - 96"W**      **MODEL #**      **DIMENSIONS**      **WT/LB.**      **CUBIC FT.**      **LIST PRICE**      **HP ADD**      **KS ADD**

W x D x H

**Thermally fused laminate, flat edge <sup>(1)</sup>**

|          |             |    |      |              |              |     |
|----------|-------------|----|------|--------------|--------------|-----|
| GBT5NTP  | 60 x 30 x 1 | 46 | 2.5  | <b>\$422</b> | <b>\$178</b> | N/A |
| GBT5NHTP | 66 x 30 x 1 | 56 | 2.44 | <b>\$457</b> | <b>\$187</b> | N/A |
| GBT6NTP  | 72 x 30 x 1 | 62 | 3    | <b>\$459</b> | <b>\$195</b> | N/A |
| GBT7NTP  | 84 x 30 x 1 | 72 | 7.5  | <b>\$548</b> | <b>\$233</b> | N/A |
| GBT8NTP  | 96 x 30 x 1 | 80 | 8.5  | <b>\$601</b> | <b>\$244</b> | N/A |
| GBT5TP   | 60 x 36 x 1 | 70 | 6.6  | <b>\$483</b> | <b>\$195</b> | N/A |
| GBT5HTP  | 66 x 36 x 1 | 79 | 7.21 | <b>\$488</b> | <b>\$199</b> | N/A |
| GBT6TP   | 72 x 36 x 1 | 72 | 7.5  | <b>\$488</b> | <b>\$199</b> | N/A |
| GBT7TP   | 84 x 36 x 1 | 85 | 8.75 | <b>\$600</b> | <b>\$244</b> | N/A |
| GBT8TP   | 96 x 36 x 1 | 94 | 9    | <b>\$659</b> | <b>\$275</b> | N/A |

**High pressure laminate, knife edge**

|            |                |     |     |               |     |     |
|------------|----------------|-----|-----|---------------|-----|-----|
| GBT5NTPLK  | 60 x 30 x 1.19 | 55  | 5   | <b>\$1673</b> | N/A | N/A |
| GBT5NHTPLK | 66 x 30 x 1.19 | 67  | 5.5 | <b>\$1826</b> | N/A | N/A |
| GBT6NTPLK  | 72 x 30 x 1.19 | 74  | 6   | <b>\$1990</b> | N/A | N/A |
| GBT7NTPLK  | 84 x 30 x 1.19 | 86  | 7   | <b>\$2133</b> | N/A | N/A |
| GBT8NTPLK  | 96 x 30 x 1.19 | 96  | 8   | <b>\$2287</b> | N/A | N/A |
| GBT5TPLK   | 60 x 36 x 1.19 | 84  | 6   | <b>\$1826</b> | N/A | N/A |
| GBT5HTPLK  | 66 x 36 x 1.19 | 95  | 6.5 | <b>\$1980</b> | N/A | N/A |
| GBT6TPLK   | 72 x 36 x 1.19 | 86  | 7   | <b>\$2144</b> | N/A | N/A |
| GBT7TPLK   | 84 x 36 x 1.19 | 102 | 8   | <b>\$2451</b> | N/A | N/A |
| GBT8TPLK   | 96 x 36 x 1.19 | 113 | 9   | <b>\$2758</b> | N/A | N/A |

**Veneer <sup>(2)</sup>**

|           |                |     |     |               |     |              |
|-----------|----------------|-----|-----|---------------|-----|--------------|
| GBT5NTPV  | 60 x 30 x 1.19 | 55  | 5   | <b>\$1882</b> | N/A | <b>\$271</b> |
| GBT5NHTPV | 66 x 30 x 1.19 | 67  | 5.5 | <b>\$2026</b> | N/A | <b>\$292</b> |
| GBT6NTPV  | 72 x 30 x 1.19 | 74  | 6   | <b>\$2175</b> | N/A | <b>\$312</b> |
| GBT7NTPV  | 84 x 30 x 1.19 | 86  | 7   | <b>\$2527</b> | N/A | <b>\$363</b> |
| GBT8NTPV  | 96 x 30 x 1.19 | 96  | 8   | <b>\$2870</b> | N/A | <b>\$415</b> |
| GBT5TPV   | 60 x 36 x 1.19 | 84  | 6   | <b>\$2175</b> | N/A | <b>\$312</b> |
| GBT5HTPV  | 66 x 36 x 1.19 | 95  | 6.5 | <b>\$2374</b> | N/A | <b>\$343</b> |
| GBT6TPV   | 72 x 36 x 1.19 | 86  | 7   | <b>\$2578</b> | N/A | <b>\$373</b> |
| GBT7TPV   | 84 x 36 x 1.19 | 102 | 8   | <b>\$2998</b> | N/A | <b>\$435</b> |
| GBT8TPV   | 96 x 36 x 1.19 | 113 | 9   | <b>\$3417</b> | N/A | <b>\$496</b> |

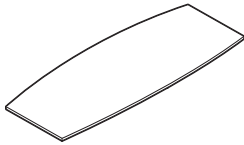

**Boat Shape Tops**

**Applicable bases to use with above tops - two bases required: GRB22H26, GRB22, GRB22H35, GRB22H41 round bases or GSB19H26, GSB19, GSB19H35, GSB19H41 square bases.** Tops feature metal inserts for ease of assembly to base.

- GBTxNTP/GBTxNHTP: 30"D across center and 24"D at ends.
- GBTxTP/GBTxHTP: 36"D across center and 28"D at ends.

**Required specifications**

Top finish  
Edge finish <sup>(1)</sup>

**Optional specifications**

HP laminate <sup>(1)</sup>  
Knife edge <sup>(2)</sup>  
Grromet position or power block cut-out

**Applicable bases (two required)**

Round bases:  
GRB22H26, GRB22, GRB22H35, GRB22H41  
Square bases:  
GSB19H26, GSB19, GSB19H35, GSB19H41

**Accessories**

Power block



# S SWAP™ TABLES

## BASES FOR TOPS 60" - 96"W

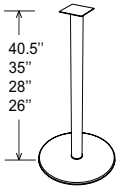

**22" Dia Round Bases**

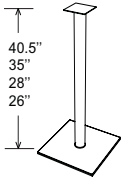

**18.5" Square Bases**

| MODEL # | DIMENSIONS | WT/LB. | CUBIC FT. | LIST PRICE | BCH / CHM | ACO / SBR |
|---------|------------|--------|-----------|------------|-----------|-----------|
|---------|------------|--------|-----------|------------|-----------|-----------|

W x D x H

Order the quantity of bases as indicated by each top size.

|          |               |      |      |              |              |              |
|----------|---------------|------|------|--------------|--------------|--------------|
| GRB22H26 | 22 x - x 26   | 55   | 8.63 | <b>\$793</b> | <b>\$147</b> | <b>\$221</b> |
| GRB22    | 22 x - x 27.5 | 55   | 9.33 | <b>\$793</b> | <b>\$147</b> | <b>\$221</b> |
| GRB22H35 | 22 x - x 35   | 57.1 | 12   | <b>\$831</b> | <b>\$164</b> | <b>\$253</b> |
| GRB22H41 | 22 x - x 40.5 | 58.3 | 14   | <b>\$844</b> | <b>\$171</b> | <b>\$259</b> |

**GRB22H26** - lounge height   **GRB22** - seated height   **GRB22H35** - counter height   **GRB22H41** - bar height

|          |                    |      |      |              |              |              |
|----------|--------------------|------|------|--------------|--------------|--------------|
| GSB19H26 | 18.5 x 18.5 x 26   | 50   | 5.94 | <b>\$857</b> | <b>\$136</b> | <b>\$212</b> |
| GSB19    | 18.5 x 18.5 x 27.5 | 50   | 6.06 | <b>\$857</b> | <b>\$136</b> | <b>\$212</b> |
| GSB19H35 | 18.5 x 18.5 x 35   | 51.8 | 7.52 | <b>\$906</b> | <b>\$151</b> | <b>\$262</b> |
| GSB19H41 | 18.5 x 18.5 x 40.5 | 53.2 | 8.77 | <b>\$937</b> | <b>\$166</b> | <b>\$267</b> |

**GSB19H26** - lounge height   **GSB19** - seated height   **GSB19H35** - counter height   **GSB19H41** - bar height

Base comes fully assembled and features 0.5" adjustable glides to level on uneven surfaces. Screws included with base for attaching to appropriate top(s). Available in paint and plated finishes as listed on page 323. Upcharge applies on plated finishes.

### Required Specifications

Finish

### Optional Specifications

Plated finish

**RECTANGULAR TOPS, 96" - 144"W**

| MODEL #  | DIMENSIONS      | WT/LB. | CUBIC FT. | LIST PRICE    | HP ADD       | R3 ADD          | KS ADD       |
|--|-----------------|--------|-----------|---------------|--------------|-----------------|--------------|
| <b>W x D x H</b>   |                 |        |           |               |              |                 |              |
| <b>Thermally fused laminate, flat edge (1 piece top - 2 bases required) <sup>(1)(4)</sup></b>  |                 |        |           |               |              |                 |              |
| GRT8MTP  | 96 x 42 x 1     | 128    | 11.84     | <b>\$1221</b> | <b>\$504</b> | <b>\$122.10</b> | N/A          |
| GRT8WTP  | 96 x 48 x 1     | 190    | 14        | <b>\$1221</b> | <b>\$512</b> | <b>\$122.10</b> | N/A          |
| <b>Thermally fused laminate, flat edge (2 piece tops - 3 bases required) <sup>(1)(4)</sup></b> |                 |        |           |               |              |                 |              |
| GRT10WTP   | 120 x 48 x 1    | 220    | 17        | <b>\$1537</b> | <b>\$636</b> | <b>\$153.70</b> | N/A          |
| GRT12WTP   | 144 x 48 x 1    | 262    | 21        | <b>\$1791</b> | <b>\$739</b> | <b>\$179.10</b> | N/A          |
| <b>High pressure laminate, knife edge (1 piece top - 2 bases required)</b>                     |                 |        |           |               |              |                 |              |
| GRT8MTPLK  | 96 x 42 x 1.19  | 154    | 11        | <b>\$3069</b> | N/A          | N/A             | N/A          |
| GRT8WTPLK  | 96 x 48 x 1.19  | 228    | 12        | <b>\$3432</b> | N/A          | N/A             | N/A          |
| <b>High pressure laminate, knife edge (2 piece tops - 3 bases required)</b>                    |                 |        |           |               |              |                 |              |
| GRT10WTPLK   | 120 x 48 x 1.19 | 264    | 15        | <b>\$4630</b> | N/A          | N/A             | N/A          |
| GRT12WTPLK   | 144 x 48 x 1.19 | 314    | 18        | <b>\$5524</b> | N/A          | N/A             | N/A          |
| <b>Veneer (1 piece top - 2 bases required) <sup>(2)</sup></b>                                  |                 |        |           |               |              |                 |              |
| GRT8MTPV   | 96 x 42 x 1.19  | 154    | 11        | <b>\$3903</b> | N/A          | N/A             | <b>\$378</b> |
| GRT8WTPV   | 96 x 48 x 1.19  | 228    | 12        | <b>\$4389</b> | N/A          | N/A             | <b>\$430</b> |
| <b>Veneer (2 piece tops - 3 bases required) <sup>(2)</sup></b>                                 |                 |        |           |               |              |                 |              |
| GRT10WTPV  | 120 x 48 x 1.19 | 264    | 15        | <b>\$5821</b> | N/A          | N/A             | <b>\$573</b> |
| GRT12WTPV  | 144 x 48 x 1.19 | 314    | 18        | <b>\$6952</b> | N/A          | N/A             | <b>\$685</b> |

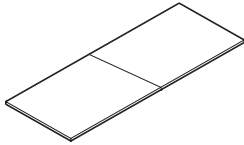

Rectangular Tops

**Applicable bases to use with above tops: GRB28 round base or GSB23 square base (28" H).**  
**Two bases required for 96"W tops or three bases required for 120" and 144"W tops.**  
 Tops feature metal inserts for ease of assembly to base.

**RACETRACK TOPS, 96" - 144"W**

|   |                 |     |       |               |              |     |              |
|---|-----------------|-----|-------|---------------|--------------|-----|--------------|
| <b>Thermally fused laminate, flat edge (1 piece top - 2 bases required) <sup>(1)</sup></b>  |                 |     |       |               |              |     |              |
| GRC8MTP   | 96 x 42 x 1     | 128 | 11.84 | <b>\$1240</b> | <b>\$504</b> | N/A | N/A          |
| GRC8WTP   | 96 x 48 x 1     | 190 | 14    | <b>\$1240</b> | <b>\$512</b> | N/A | N/A          |
| <b>Thermally fused laminate, flat edge (2 piece tops - 3 bases required) <sup>(1)</sup></b> |                 |     |       |               |              |     |              |
| GRC10WTP  | 120 x 48 x 1    | 220 | 17    | <b>\$1560</b> | <b>\$636</b> | N/A | N/A          |
| GRC12WTP  | 144 x 48 x 1    | 262 | 21    | <b>\$1818</b> | <b>\$739</b> | N/A | N/A          |
| <b>High pressure laminate, knife edge (1 piece top - 2 bases required)</b>                  |                 |     |       |               |              |     |              |
| GRC8MTPLK   | 96 x 42 x 1.19  | 154 | 11    | <b>\$3658</b> | N/A          | N/A | N/A          |
| GRC8WTPLK   | 96 x 48 x 1.19  | 228 | 12    | <b>\$4169</b> | N/A          | N/A | N/A          |
| <b>High pressure laminate, knife edge (2 piece tops - 3 bases required)</b>                 |                 |     |       |               |              |     |              |
| GRC10WTPLK  | 120 x 48 x 1.19 | 264 | 15    | <b>\$5192</b> | N/A          | N/A | N/A          |
| GRC12WTPLK  | 144 x 48 x 1.19 | 314 | 18    | <b>\$6215</b> | N/A          | N/A | N/A          |
| <b>Veneer (1 piece top - 2 bases required) <sup>(2)</sup></b>                               |                 |     |       |               |              |     |              |
| GRC8MTPV  | 96 x 42 x 1.19  | 154 | 11    | <b>\$4630</b> | N/A          | N/A | <b>\$455</b> |
| GRC8WTPV  | 96 x 48 x 1.19  | 228 | 12    | <b>\$5141</b> | N/A          | N/A | <b>\$506</b> |
| <b>Veneer (2 piece tops - 3 bases required) <sup>(2)</sup></b>                              |                 |     |       |               |              |     |              |
| GRC10WTPV   | 120 x 48 x 1.19 | 264 | 15    | <b>\$6727</b> | N/A          | N/A | <b>\$666</b> |
| GRC12WTPV   | 144 x 48 x 1.19 | 314 | 18    | <b>\$7954</b> | N/A          | N/A | <b>\$788</b> |

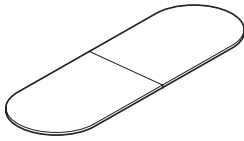

Racetrack Tops

**Applicable bases to use with above tops: GRB28 round base or GSB23 square base (28" H).**  
**Two bases required for 96"W tops or three bases required for 120" and 144"W tops.**  
 Tops feature metal inserts for ease of assembly to base.

| Required specifications                  | Optional specifications  | Applicable bases (two or three required) | Accessories |
|--|--|--|-------------|
| Top finish<br>Edge finish <sup>(1)</sup> | HP laminate <sup>(1)</sup><br>Knife edge <sup>(2)</sup><br>3" radiused corners <sup>(4)</sup><br>Grommet position or power block cut-out | GRB28 - round<br>GSB23 - square          | Power block |

## BOAT SHAPE TOPS, 96" - 144"W

| MODEL # | DIMENSIONS | WT/LB. | CUBIC FT. | LIST PRICE | HP ADD | KS ADD |
|---------|------------|--------|-----------|------------|--------|--------|
|---------|------------|--------|-----------|------------|--------|--------|

W x D x H

**Thermally fused laminate, flat edge (1 piece top - 2 bases required) <sup>(1)</sup>**

|         |             |     |       |               |              |     |
|---------|-------------|-----|-------|---------------|--------------|-----|
| GBT8MTP | 96 x 42 x 1 | 128 | 11.84 | <b>\$1240</b> | <b>\$504</b> | N/A |
| GBT8WTP | 96 x 48 x 1 | 190 | 14    | <b>\$1240</b> | <b>\$512</b> | N/A |

**Thermally fused laminate, flat edge (2 piece tops - 3 bases required) <sup>(1)</sup>**

|          |              |     |    |               |              |     |
|----------|--------------|-----|----|---------------|--------------|-----|
| GBT10WTP | 120 x 48 x 1 | 220 | 17 | <b>\$1560</b> | <b>\$636</b> | N/A |
| GBT12WTP | 144 x 48 x 1 | 262 | 21 | <b>\$1818</b> | <b>\$739</b> | N/A |

**High pressure laminate, knife edge (1 piece top - 2 bases required)**

|           |                |     |    |               |     |     |
|-----------|----------------|-----|----|---------------|-----|-----|
| GBT8MTPLK | 96 x 42 x 1.19 | 154 | 11 | <b>\$3658</b> | N/A | N/A |
| GBT8WTPLK | 96 x 48 x 1.19 | 228 | 12 | <b>\$4169</b> | N/A | N/A |

**High pressure laminate, knife edge (2 piece tops - 3 bases required)**

|            |                 |     |    |               |     |     |
|------------|-----------------|-----|----|---------------|-----|-----|
| GBT10WTPLK | 120 x 48 x 1.19 | 264 | 15 | <b>\$5192</b> | N/A | N/A |
| GBT12WTPLK | 144 x 48 x 1.19 | 314 | 18 | <b>\$6215</b> | N/A | N/A |

**Veneer (1 piece top - 2 bases required) <sup>(2)</sup>**

|          |                |     |    |               |     |              |
|----------|----------------|-----|----|---------------|-----|--------------|
| GBT8MTPV | 96 x 42 x 1.19 | 154 | 11 | <b>\$4630</b> | N/A | <b>\$455</b> |
| GBT8WTPV | 96 x 48 x 1.19 | 228 | 12 | <b>\$5141</b> | N/A | <b>\$506</b> |

**Veneer (2 piece tops - 3 bases required) <sup>(2)</sup>**

|           |                 |     |    |               |     |              |
|-----------|-----------------|-----|----|---------------|-----|--------------|
| GBT10WTPV | 120 x 48 x 1.19 | 264 | 15 | <b>\$6727</b> | N/A | <b>\$666</b> |
| GBT12WTPV | 144 x 48 x 1.19 | 314 | 18 | <b>\$7954</b> | N/A | <b>\$788</b> |

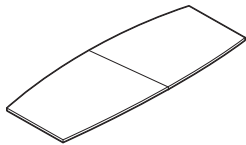

Boat Shape Tops

**Applicable bases to use with above tops: GRB28 round base or GSB23 square base (28"H).**

**Two bases required for 96"W tops or three bases required for 120" and 144"W tops.**

Tops feature metal inserts for ease of assembly to base.

- GBTxMTP: 42"D at center and 33"D at ends.
- GBTxxWTP: 48"D at center and 38"D at ends.

## BASES FOR TOPS 60" - 96"W

| MODEL # | DIMENSIONS | WT/LB. | CUBIC FT. | LIST PRICE | BCH / CHM | ACO / SBR |
|---------|------------|--------|-----------|------------|-----------|-----------|
|---------|------------|--------|-----------|------------|-----------|-----------|

W x D x H

**BASE VALID FOR TOPS ON PAGES 345-346:**

**Order the quantity of bases as indicated by each top size.**

|       |               |     |       |               |              |              |
|-------|---------------|-----|-------|---------------|--------------|--------------|
| GRB28 | 28 x - x 27.5 | 100 | 15.63 | <b>\$1250</b> | <b>\$147</b> | <b>\$372</b> |
|-------|---------------|-----|-------|---------------|--------------|--------------|

seated height

|       |                    |    |      |               |              |              |
|-------|--------------------|----|------|---------------|--------------|--------------|
| GSB23 | 22.5 x 22.5 x 27.5 | 82 | 9.33 | <b>\$1146</b> | <b>\$136</b> | <b>\$235</b> |
|-------|--------------------|----|------|---------------|--------------|--------------|

seated height

Base comes fully assembled and features 0.5" adjustable glides to level on uneven surfaces. Screws included with base for attaching to appropriate top(s). Available in paint and plated finishes as listed on page 323. Upcharge applies on plated finishes.

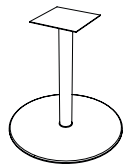

28" Dia Round Base

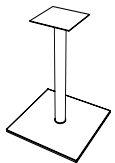

23" Square Base

**Required specifications**

Top finish  
Edge finish <sup>(1)</sup>  
Base finish

**Optional specifications**

HP laminate <sup>(1)</sup>  
Knife edge <sup>(2)</sup>  
Grommet position or power block cut-out  
Base plated finish

**Applicable bases (two or three required)**

GRB28 - round  
GSB23 - square

**Accessories**

Power block

**RECTANGULAR TOPS FOR DUAL COLUMN BASE**

| MODEL #  | DIMENSIONS     | WT/LB. | CUBIC FT. | LIST PRICE | HP ADD | R3 ADD  | KS ADD |
|--|----------------|--------|-----------|------------|--------|---------|--------|
| W x D x H  |                |        |           |            |        |         |        |
| <b>Thermally fused laminate, flat edge <sup>(1)(4)</sup></b> |                |        |           |            |        |         |        |
| GRTD5TP  | 60 x 36 x 1    | 60     | 6.6       | \$472      | \$188  | \$47.20 | N/A    |
| GRTD5HTP   | 66 x 36 x 1    | 69     | 7.21      | \$481      | \$195  | \$48.10 | N/A    |
| GRTD6TP  | 72 x 36 x 1    | 75     | 7.82      | \$481      | \$195  | \$48.10 | N/A    |
| GRTD5MTP   | 60 x 42 x 1    | 73     | 7.62      | \$633      | \$273  | \$63.30 | N/A    |
| GRTD5HMTP  | 66 x 42 x 1    | 81     | 8.32      | \$675      | \$294  | \$67.50 | N/A    |
| GRTD6MTP   | 72 x 42 x 1    | 89     | 9.02      | \$694      | \$300  | \$69.40 | N/A    |
| <b>High pressure laminate, knife edge</b>                    |                |        |           |            |        |         |        |
| GRTD5TPLK  | 60 x 36 x 1.19 | 72     | 6         | \$1448     | N/A    | N/A     | N/A    |
| GRTD5HTPLK   | 66 x 36 x 1.19 | 83     | 6.5       | \$1581     | N/A    | N/A     | N/A    |
| GRTD6TPLK  | 72 x 36 x 1.19 | 90     | 7         | \$1719     | N/A    | N/A     | N/A    |
| GRTD5MTPLK   | 60 x 42 x 1.19 | 88     | 7         | \$1668     | N/A    | N/A     | N/A    |
| GRTD5HMTPK   | 66 x 42 x 1.19 | 97     | 7.5       | \$1832     | N/A    | N/A     | N/A    |
| GRTD6MTPLK   | 72 x 42 x 1.19 | 107    | 8         | \$1990     | N/A    | N/A     | N/A    |
| <b>Veneer <sup>(2)</sup></b>                                 |                |        |           |            |        |         |        |
| GRTD5TPV   | 60 x 36 x 1.19 | 72     | 6         | \$1898     | N/A    | N/A     | \$184  |
| GRTD5HTPV  | 66 x 36 x 1.19 | 83     | 6.5       | \$2072     | N/A    | N/A     | \$199  |
| GRTD6TPV   | 72 x 36 x 1.19 | 90     | 7         | \$2251     | N/A    | N/A     | \$215  |
| GRTD5MTPV  | 60 x 42 x 1.19 | 88     | 7         | \$2195     | N/A    | N/A     | \$210  |
| GRTD5HMTPV   | 66 x 42 x 1.19 | 97     | 7.5       | \$2405     | N/A    | N/A     | \$230  |
| GRTD6MTPV  | 72 x 42 x 1.19 | 107    | 8         | \$2614     | N/A    | N/A     | \$256  |



Rectangular Tops

Tops feature metal inserts for ease of assembly to base. One dual column base (GDCB36H28) required. Limited cut-out options available for power modules, include E2 or FOG2 only. Power modules corresponding to applicable cut-out codes ordered separately.

**RACETRACK TOPS FOR DUAL COLUMN BASE**

| MODEL #   | DIMENSIONS     | WT/LB. | CUBIC FT. | LIST PRICE | HP ADD | R3 ADD | KS ADD |
|---|----------------|--------|-----------|------------|--------|--------|--------|
| <b>Thermally fused laminate, flat edge <sup>(1)</sup></b> |                |        |           |            |        |        |        |
| GRCD5TP   | 60 x 36 x 1    | 60     | 6.6       | \$483      | \$195  | N/A    | N/A    |
| GRCD5HTP  | 66 x 36 x 1    | 69     | 7.21      | \$488      | \$199  | N/A    | N/A    |
| GRCD6TP   | 72 x 36 x 1    | 75     | 7.82      | \$488      | \$199  | N/A    | N/A    |
| GRCD5MTP  | 60 x 42 x 1    | 73     | 7.62      | \$633      | \$273  | N/A    | N/A    |
| GRCD5HMTP   | 66 x 42 x 1    | 81     | 8.32      | \$675      | \$294  | N/A    | N/A    |
| GRCD6MTP  | 72 x 42 x 1    | 89     | 9.02      | \$694      | \$300  | N/A    | N/A    |
| <b>High pressure laminate, knife edge</b>                 |                |        |           |            |        |        |        |
| GRCD5TPLK   | 60 x 36 x 1.19 | 72     | 6         | \$1995     | N/A    | N/A    | N/A    |
| GRCD5HTPLK  | 66 x 36 x 1.19 | 83     | 6.5       | \$2123     | N/A    | N/A    | N/A    |
| GRCD6TPLK   | 72 x 36 x 1.19 | 90     | 7         | \$2251     | N/A    | N/A    | N/A    |
| GRCD5MTPLK  | 60 x 42 x 1.19 | 88     | 7         | \$2379     | N/A    | N/A    | N/A    |
| GRCD5HMTPK  | 66 x 42 x 1.19 | 97     | 7.5       | \$2507     | N/A    | N/A    | N/A    |
| GRCD6MTPLK  | 72 x 42 x 1.19 | 107    | 8         | \$2635     | N/A    | N/A    | N/A    |
| <b>Veneer <sup>(2)</sup></b>                              |                |        |           |            |        |        |        |
| GRCD5TPV  | 60 x 36 x 1.19 | 72     | 6         | \$2379     | N/A    | N/A    | \$230  |
| GRCD5HTPV   | 66 x 36 x 1.19 | 83     | 6.5       | \$2507     | N/A    | N/A    | \$241  |
| GRCD6TPV  | 72 x 36 x 1.19 | 90     | 7         | \$2635     | N/A    | N/A    | \$256  |
| GRCD5MTPV   | 60 x 42 x 1.19 | 88     | 7         | \$2762     | N/A    | N/A    | \$271  |
| GRCD5HMTPV  | 66 x 42 x 1.19 | 97     | 7.5       | \$2891     | N/A    | N/A    | \$282  |
| GRCD6MTPV   | 72 x 42 x 1.19 | 107    | 8         | \$3018     | N/A    | N/A    | \$292  |



Racetrack Tops

Tops feature metal inserts for ease of assembly to base. One dual column base (GDCB36H28) required. Limited cut-out options available for power modules, include E2 or FOG2 only. Power modules corresponding to applicable cut-out codes ordered separately.

| Required specifications                  | Optional specifications  | Applicable bases | Accessories |
|--|--|------------------|-------------|
| Top finish<br>Edge finish <sup>(1)</sup> | HP laminate <sup>(1)</sup><br>Knife edge <sup>(2)</sup><br>3" radiused corners <sup>(4)</sup><br>Grommet position or power block cut-out | GDCB36H28        | Power block |

## BOAT SHAPE TOPS FOR DUAL COLUMN BASE

MODEL # DIMENSIONS WT/LB. CUBIC FT. LIST PRICE HP ADD KS ADD

W x D x H

### Thermally fused laminate, flat edge <sup>(1)</sup>

|           |             |    |      |              |              |     |
|-----------|-------------|----|------|--------------|--------------|-----|
| GBTD5TP   | 60 x 36 x 1 | 60 | 6.6  | <b>\$483</b> | <b>\$195</b> | N/A |
| GBTD5HTP  | 66 x 36 x 1 | 69 | 7.21 | <b>\$488</b> | <b>\$199</b> | N/A |
| GBTD6TP   | 72 x 36 x 1 | 75 | 7.82 | <b>\$488</b> | <b>\$199</b> | N/A |
| GBTD5MTP  | 60 x 42 x 1 | 73 | 7.62 | <b>\$633</b> | <b>\$273</b> | N/A |
| GBTD5HMTP | 66 x 42 x 1 | 81 | 8.32 | <b>\$675</b> | <b>\$294</b> | N/A |
| GBTD6MTP  | 72 x 42 x 1 | 89 | 9.02 | <b>\$694</b> | <b>\$300</b> | N/A |

### High pressure laminate, knife edge

|             |                |     |     |               |     |     |
|-------------|----------------|-----|-----|---------------|-----|-----|
| GBTD5TPLK   | 60 x 36 x 1.19 | 72  | 6   | <b>\$1995</b> | N/A | N/A |
| GBTD5HTPLK  | 66 x 36 x 1.19 | 83  | 6.5 | <b>\$2123</b> | N/A | N/A |
| GBTD6TPLK   | 72 x 36 x 1.19 | 90  | 7   | <b>\$2251</b> | N/A | N/A |
| GBTD5MTPLK  | 60 x 42 x 1.19 | 88  | 7   | <b>\$2379</b> | N/A | N/A |
| GBTD5HMTPLK | 66 x 42 x 1.19 | 97  | 7.5 | <b>\$2507</b> | N/A | N/A |
| GBTD6MTPLK  | 72 x 42 x 1.19 | 107 | 8   | <b>\$2635</b> | N/A | N/A |

### Veneer <sup>(2)</sup>

|            |                |     |     |               |     |              |
|------------|----------------|-----|-----|---------------|-----|--------------|
| GBTD5TPV   | 60 x 36 x 1.19 | 72  | 6   | <b>\$2379</b> | N/A | <b>\$230</b> |
| GBTD5HTPV  | 66 x 36 x 1.19 | 83  | 6.5 | <b>\$2507</b> | N/A | <b>\$241</b> |
| GBTD6TPV   | 72 x 36 x 1.19 | 90  | 7   | <b>\$2635</b> | N/A | <b>\$256</b> |
| GBTD5MTPV  | 60 x 42 x 1.19 | 88  | 7   | <b>\$2762</b> | N/A | <b>\$271</b> |
| GBTD5HMTPV | 66 x 42 x 1.19 | 97  | 7.5 | <b>\$2891</b> | N/A | <b>\$282</b> |
| GBTD6MTPV  | 72 x 42 x 1.19 | 107 | 8   | <b>\$3018</b> | N/A | <b>\$292</b> |

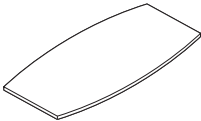

Boat Shape Tops

Tops feature metal inserts for ease of assembly to base. One dual column base (**GDCB36H28**) required.

Limited cut-out options available for power modules, include E2 or FOG2 only. Power modules corresponding to applicable cut-out codes ordered separately.

- GBTDxTP/GBTDxHTP: 36"D at center and 28"D at ends
- GBTDxMTP/GBTDxHMTP: 42"D at center and 33"D at ends.

## DUAL COLUMN BASE FOR GxTDxxx TOPS

MODEL # DIMENSIONS WT/LB. CUBIC FT. LIST PRICE BCH / CHM ACO / SBR

W x D x H

### BASE VALID FOR TOPS ON PAGES 347-348:

|           |              |        |       |               |              |              |
|-----------|--------------|--------|-------|---------------|--------------|--------------|
| GDCB36H28 | 19 x 36 x 28 | 116.23 | 12.16 | <b>\$2103</b> | <b>\$582</b> | <b>\$768</b> |
|-----------|--------------|--------|-------|---------------|--------------|--------------|

seated height

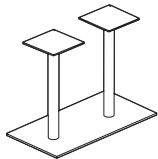

28"H Dual Column Base

Base ships knocked-down; assembly required. Features 0.5" adjustable glides to level on uneven surfaces. Screws included with base for attaching to appropriate top(s). Available in paint and plated finishes as listed on page 323. Upcharge applies on plated finishes.

#### Required specifications

Top finish  
Edge finish <sup>(1)</sup>  
Base finish

#### Optional specifications

HP laminate <sup>(1)</sup>  
Knife edge <sup>(2)</sup>  
Grommet position or power block cut-out  
Base plated finish

#### Applicable bases

GDCB36H28

#### Accessories

Power block

**HUDDLE TABLES OVERVIEW**

Bring teams together to huddle, share and collaborate.

Three heights available - seated desk height: 29", counter height: 36", bar height: 41.5" with D top, wedge, rectangular or soft ellipse shaped tops.

Laminate kits (consisting of laminate top and U-base) are sold separately from metal bases for huddle tables. Tops include metal inserts for ease of assembly to metal base. All tops are standard with an edge scoop to help manage cables from wall mounted flat screen monitors and/or edge mounting power module (PS305057/PS305002 as an example). Support channels are included with tops over 60" wide.

Metal bases ship fully assembled and include 0.5" adjustable glides and metal screws for attaching to the top. Be sure to specify bases specific to huddle tables GRHB22Hxx or GSB19Hxx.

**D-TOP HUDDLE TABLES**

| MODEL #          | DIMENSIONS   | WT/LB. | CUBIC FT. | LIST PRICE    | HP ADD       |
|------------------|--------------|--------|-----------|---------------|--------------|
| <b>W x D x H</b> |              |        |           |               |              |
| GDH364829        | 36 x 48 x 29 | 77.05  | 3.94      | <b>\$952</b>  | <b>\$188</b> |
| GDH366029        | 36 x 60 x 29 | 86.95  | 4.46      | <b>\$1162</b> | <b>\$188</b> |
| GDH367229        | 36 x 72 x 29 | 97     | 4.99      | <b>\$1295</b> | <b>\$195</b> |
| GDH426029        | 42 x 60 x 29 | 99.82  | 5.18      | <b>\$1301</b> | <b>\$273</b> |
| GDH427229        | 42 x 72 x 29 | 111.5  | 5.79      | <b>\$1459</b> | <b>\$300</b> |
| GDH428429        | 42 x 84 x 29 | 123.1  | 11.98     | <b>\$1616</b> | <b>\$477</b> |
| GDH429629        | 42 x 96 x 29 | 134.74 | 13.31     | <b>\$1746</b> | <b>\$504</b> |
| GDH486029        | 48 x 60 x 29 | 112.6  | 5.89      | <b>\$1453</b> | <b>\$374</b> |
| GDH487229        | 48 x 72 x 29 | 126    | 6.58      | <b>\$1626</b> | <b>\$443</b> |
| GDH488429        | 48 x 84 x 29 | 139.24 | 13.5      | <b>\$1738</b> | <b>\$469</b> |
| GDH489629        | 48 x 96 x 29 | 152.56 | 15        | <b>\$1880</b> | <b>\$512</b> |

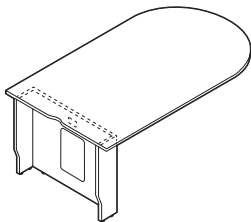

**29"H D-Top Huddle**

Laminate U-base support is 8"D with 7" inside clearance to wall. Access wall through 14.5"H x 9.5"W hinged door with touch latch in front panel of u-base support. U-base includes 0.5" adjustable glides. U-base side panels are tapered at the bottom to clear most baseboards. **Cut-out locations available in positions 1 or 2 only (except for model GDH364829 - cut-out position available in position 1 only).**

- Metal bases sold separately. Compatible with **GRHB22H28** or **GSHB19H28** only, requires one base.

|           |              |        |       |               |              |
|-----------|--------------|--------|-------|---------------|--------------|
| GDH364836 | 36 x 48 x 36 | 85.95  | 4.31  | <b>\$980</b>  | <b>\$188</b> |
| GDH366036 | 36 x 60 x 36 | 95.85  | 4.84  | <b>\$1189</b> | <b>\$188</b> |
| GDH367236 | 36 x 72 x 36 | 105.9  | 5.37  | <b>\$1323</b> | <b>\$195</b> |
| GDH426036 | 42 x 60 x 36 | 109.82 | 5.61  | <b>\$1332</b> | <b>\$273</b> |
| GDH427236 | 42 x 72 x 36 | 121.5  | 6.22  | <b>\$1491</b> | <b>\$300</b> |
| GDH428436 | 42 x 84 x 36 | 133.1  | 12.4  | <b>\$1646</b> | <b>\$477</b> |
| GDH429636 | 42 x 96 x 36 | 144.74 | 13.75 | <b>\$1777</b> | <b>\$504</b> |
| GDH486036 | 48 x 60 x 36 | 123.6  | 6.38  | <b>\$1488</b> | <b>\$374</b> |
| GDH487236 | 48 x 72 x 36 | 137    | 7.08  | <b>\$1661</b> | <b>\$443</b> |
| GDH488436 | 48 x 84 x 36 | 150.24 | 14    | <b>\$1773</b> | <b>\$469</b> |
| GDH489636 | 48 x 96 x 36 | 163.56 | 15.5  | <b>\$1916</b> | <b>\$512</b> |

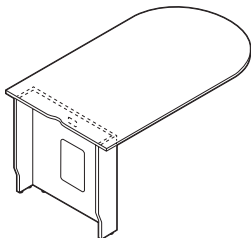

**36"H D-Top Huddle**

Laminate U-base support is 8"D with 7" inside clearance to wall. Access wall through 14.5"H x 9.5"W hinged door with touch latch in front panel of U-base support. U-base includes 0.5" adjustable glides. U-base side panels are tapered at the bottom to clear most baseboards. **Cut-out locations available in positions 1 or 2 only (except for model GDH364836 - cut-out position available in position 1 only).**

- Metal bases sold separately. Compatible with **GRHB22H35** or **GSHB19H35** only, requires one base.

**Required Specifications**

Top finish  
Base finish

**Optional Specifications**

HP laminate  
Grommet position or power block cut-out

**Accessories**

Power block

# S SWAP™ TABLES

## D-TOP HUDDLE TABLES

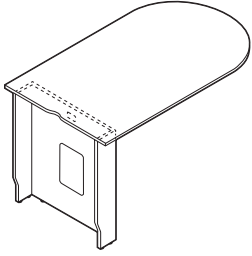

41.5"H D-Top Huddle

| MODEL #   | DIMENSIONS<br>W x D x H | WT/LB. | CUBIC FT. | LIST PRICE    | HP ADD       |
|-----------|-------------------------|--------|-----------|---------------|--------------|
| GDH364841 | 36 x 48 x 41.5          | 92.65  | 4.58      | <b>\$1032</b> | <b>\$188</b> |
| GDH366041 | 36 x 60 x 41.5          | 102.55 | 5.11      | <b>\$1241</b> | <b>\$188</b> |
| GDH367241 | 36 x 72 x 41.5          | 112.6  | 5.63      | <b>\$1375</b> | <b>\$195</b> |
| GDH426041 | 42 x 60 x 41.5          | 117.32 | 5.92      | <b>\$1392</b> | <b>\$273</b> |
| GDH427241 | 42 x 72 x 41.5          | 129    | 6.53      | <b>\$1549</b> | <b>\$300</b> |
| GDH428441 | 42 x 84 x 41.5          | 140.6  | 12.72     | <b>\$1706</b> | <b>\$477</b> |
| GDH429641 | 42 x 96 x 41.5          | 152.24 | 14.06     | <b>\$1837</b> | <b>\$504</b> |
| GDH486041 | 48 x 60 x 41.5          | 130.1  | 6.74      | <b>\$1552</b> | <b>\$374</b> |
| GDH487241 | 48 x 72 x 41.5          | 143.5  | 7.43      | <b>\$1726</b> | <b>\$443</b> |
| GDH488441 | 48 x 84 x 41.5          | 156.74 | 14.53     | <b>\$1839</b> | <b>\$469</b> |
| GDH489641 | 48 x 96 x 41.5          | 170.06 | 15.85     | <b>\$1980</b> | <b>\$512</b> |

Laminate U-base support is 8"D with 7" inside clearance to wall. Access wall through 14.5"H x 9.5"W hinged door with touch latch in front panel of U-base support. U-base includes 0.5" adjustable glides. U-base side panels are tapered at the bottom to clear most baseboards. **Cut-out locations available in positions 1 or 2 only (except for model GDH364841 - cut-out position available in position 1 only).**

- Metal bases sold separately. Compatible with **GRHB22H41** or **GSHB19H41** only, requires one base.

### Required Specifications

Top finish  
Base finish

### Optional Specifications

HP laminate  
Grommet position or power block cut-out

### Accessories

Power block

**WEDGE HUDDLE TABLES**      **MODEL #**      **DIMENSIONS**      **WT/LB.**      **CUBIC FT.**      **LIST PRICE**      **HP ADD**

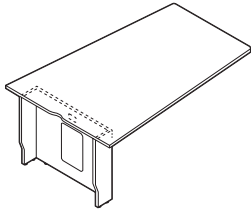

**29"H Wedge Huddle**

|           | <b>W x D x H</b> |        |      |               |              |  |
|-----------|------------------|--------|------|---------------|--------------|--|
| GWH486029 | 48 x 60 x 29     | 112.6  | 5.89 | <b>\$1448</b> | <b>\$374</b> |  |
| GWH487229 | 48 x 72 x 29     | 126    | 6.58 | <b>\$1626</b> | <b>\$443</b> |  |
| GWH488429 | 48 x 84 x 29     | 139.24 | 13.5 | <b>\$1738</b> | <b>\$469</b> |  |
| GWH489629 | 48 x 96 x 29     | 152.56 | 15   | <b>\$1880</b> | <b>\$512</b> |  |

Laminate U-base support is 8"D with 7" inside clearance to wall. Access wall through 14.5"H x 9.5"W hinged door with touch latch in front panel of U-base support. U-base includes 0.5" adjustable glides. U-base side panels are tapered at the bottom to clear most baseboards. **Cut-out locations available in positions 1 or 2 only.**

- Metal bases sold separately. Compatible with **GRHB22H28** or **GSHB19H28** only, requires one base.

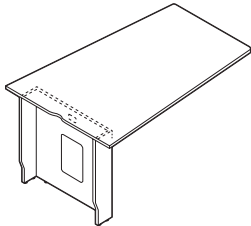

**36"H Wedge Huddle**

|           |              |        |      |               |              |  |
|-----------|--------------|--------|------|---------------|--------------|--|
| GWH486036 | 48 x 60 x 36 | 123.6  | 6.38 | <b>\$1483</b> | <b>\$374</b> |  |
| GWH487236 | 48 x 72 x 36 | 137    | 7.08 | <b>\$1661</b> | <b>\$443</b> |  |
| GWH488436 | 48 x 84 x 36 | 150.24 | 14   | <b>\$1773</b> | <b>\$469</b> |  |
| GWH489636 | 48 x 96 x 36 | 163.56 | 15.5 | <b>\$1916</b> | <b>\$512</b> |  |

Laminate U-base support is 8"D with 7" inside clearance to wall. Access wall through 14.5"H x 9.5"W hinged door with touch latch in front panel of U-base support. U-base includes 0.5" adjustable glides. U-base side panels are tapered at the bottom to clear most baseboards. **Cut-out locations available in positions 1 or 2 only.**

- Metal bases sold separately. Compatible with **GRHB22H35** or **GSHB19H35** only, requires one base.

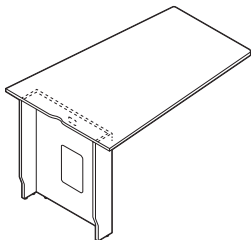

**41.5"H Wedge Huddle**

|           |                |        |       |               |              |  |
|-----------|----------------|--------|-------|---------------|--------------|--|
| GWH486041 | 48 x 60 x 41.5 | 130.1  | 6.74  | <b>\$1548</b> | <b>\$374</b> |  |
| GWH487241 | 48 x 72 x 41.5 | 143.5  | 7.43  | <b>\$1726</b> | <b>\$443</b> |  |
| GWH488441 | 48 x 84 x 41.5 | 156.74 | 14.35 | <b>\$1839</b> | <b>\$469</b> |  |
| GWH489641 | 48 x 96 x 41.5 | 170.06 | 15.85 | <b>\$1980</b> | <b>\$512</b> |  |

Laminate U-base support is 8"D with 7" inside clearance to wall. Access wall through 14.5"H x 9.5"W hinged door with touch latch in front panel of U-base support. U-base includes 0.5" adjustable glides. U-base side panels are tapered at the bottom to clear most baseboards. **Cut-out locations available in positions 1 or 2 only.**

- Metal bases sold separately. Compatible with **GRHB22H41** or **GSHB19H41** only, requires one base.

**Required Specifications**

Top finish  
Base finish

**Optional Specifications**

HP laminate  
Grommet position or power block cut-out

**Accessories**

Power block



# S SWAP™ TABLES

## RECTANGULAR HUDDLE TABLES

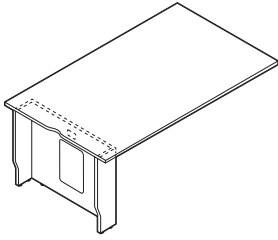

**29"H Rectangular Huddle**

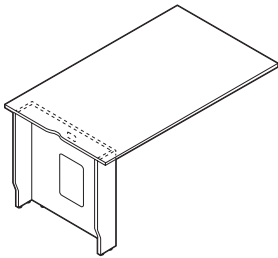

**36"H Rectangular Huddle**

| MODEL #   | DIMENSIONS   | WT/LB. | CUBIC FT. | LIST PRICE    | HP ADD       |
|-----------|--------------|--------|-----------|---------------|--------------|
| W x D x H |              |        |           |               |              |
| GRH364829 | 36 x 48 x 29 | 77.05  | 3.94      | <b>\$952</b>  | <b>\$188</b> |
| GRH366029 | 36 x 60 x 29 | 86.95  | 4.46      | <b>\$1161</b> | <b>\$188</b> |
| GRH367229 | 36 x 72 x 29 | 97     | 4.99      | <b>\$1295</b> | <b>\$195</b> |
| GRH426029 | 42 x 60 x 29 | 99.82  | 5.18      | <b>\$1301</b> | <b>\$273</b> |
| GRH427229 | 42 x 72 x 29 | 111.5  | 5.79      | <b>\$1459</b> | <b>\$300</b> |
| GRH428429 | 42 x 84 x 29 | 123.1  | 11.98     | <b>\$1616</b> | <b>\$477</b> |
| GRH429629 | 42 x 96 x 29 | 134.74 | 13.31     | <b>\$1746</b> | <b>\$504</b> |
| GRH486029 | 48 x 60 x 29 | 112.6  | 5.89      | <b>\$1453</b> | <b>\$374</b> |
| GRH487229 | 48 x 72 x 29 | 126    | 6.58      | <b>\$1626</b> | <b>\$443</b> |
| GRH488429 | 48 x 84 x 29 | 139.24 | 13.5      | <b>\$1738</b> | <b>\$469</b> |
| GRH489629 | 48 x 96 x 29 | 152.56 | 15        | <b>\$1880</b> | <b>\$512</b> |

Laminate u-base support is 8"D with 7" inside clearance to wall. Access wall through 14.5"H x 9.5"W hinged door with touch latch in front panel of u-base support. U-base includes 0.5" adjustable glides. U-base side panels are tapered at the bottom to clear most baseboards. **Cut-out locations available in positions 1 or 2 only (except for model GRH364829 - cut-out position available in position 1 only).**

- Metal bases sold separately. Compatible with **GRHB22H28** or **GSHB19H28** only, requires one base.

|           |              |        |       |               |              |
|-----------|--------------|--------|-------|---------------|--------------|
| GRH364836 | 36 x 48 x 36 | 85.95  | 4.31  | <b>\$980</b>  | <b>\$188</b> |
| GRH366036 | 36 x 60 x 36 | 95.85  | 4.84  | <b>\$1189</b> | <b>\$188</b> |
| GRH367236 | 36 x 72 x 36 | 105.9  | 5.37  | <b>\$1323</b> | <b>\$195</b> |
| GRH426036 | 42 x 60 x 36 | 109.82 | 5.61  | <b>\$1332</b> | <b>\$273</b> |
| GRH427236 | 42 x 72 x 36 | 121.5  | 6.22  | <b>\$1491</b> | <b>\$300</b> |
| GRH428436 | 42 x 84 x 36 | 133.1  | 12.41 | <b>\$1646</b> | <b>\$477</b> |
| GRH429636 | 42 x 96 x 36 | 144.74 | 13.75 | <b>\$1777</b> | <b>\$504</b> |
| GRH486036 | 48 x 60 x 36 | 123.6  | 6.38  | <b>\$1488</b> | <b>\$374</b> |
| GRH487236 | 48 x 72 x 36 | 137    | 7.08  | <b>\$1661</b> | <b>\$443</b> |
| GRH488436 | 48 x 84 x 36 | 150.24 | 14    | <b>\$1773</b> | <b>\$469</b> |
| GRH489636 | 48 x 96 x 36 | 163.56 | 15.5  | <b>\$1916</b> | <b>\$512</b> |

Laminate u-base support is 8"D with 7" inside clearance to wall. Access wall through 14.5"H x 9.5"W hinged door with touch latch in front panel of u-base support. U-base includes 0.5" adjustable glides. U-base side panels are tapered at the bottom to clear most baseboards. **Cut-out locations available in positions 1 or 2 only (except for model GRH364836 - cut-out position available in position 1 only).**

- Metal bases sold separately. Compatible with **GRHB22H35** or **GSHB19H35** only, requires one base.

### Required Specifications

Top finish  
Base finish

### Optional Specifications

HP laminate  
Grommet position or power block cut-out

### Accessories

Power block

RECTANGULAR HUDDLE TABLES      MODEL #      DIMENSIONS      WT/LB.      CUBIC FT.      LIST PRICE      HP ADD

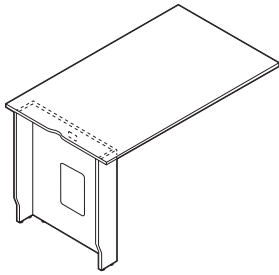

41.5"H Rectangular Huddle

|           | W x D x H      |        |       |               |              |
|-----------|----------------|--------|-------|---------------|--------------|
| GRH364841 | 36 x 48 x 41.5 | 92.65  | 4.58  | <b>\$1032</b> | <b>\$188</b> |
| GRH366041 | 36 x 60 x 41.5 | 102.55 | 5.11  | <b>\$1241</b> | <b>\$188</b> |
| GRH367241 | 36 x 72 x 41.5 | 112.6  | 5.63  | <b>\$1375</b> | <b>\$195</b> |
| GRH426041 | 42 x 60 x 41.5 | 117.32 | 5.92  | <b>\$1392</b> | <b>\$374</b> |
| GRH427241 | 42 x 72 x 41.5 | 129    | 6.53  | <b>\$1549</b> | <b>\$300</b> |
| GRH428441 | 42 x 84 x 41.5 | 140.6  | 12.72 | <b>\$1706</b> | <b>\$477</b> |
| GRH429641 | 42 x 96 x 41.5 | 152.24 | 14.06 | <b>\$1837</b> | <b>\$504</b> |
| GRH486041 | 48 x 60 x 41.5 | 130.1  | 6.74  | <b>\$1552</b> | <b>\$374</b> |
| GRH487241 | 48 x 72 x 41.5 | 143.5  | 7.43  | <b>\$1726</b> | <b>\$443</b> |
| GRH488441 | 48 x 84 x 41.5 | 156.74 | 14.35 | <b>\$1839</b> | <b>\$469</b> |
| GRH489641 | 48 x 96 x 41.5 | 170.06 | 15.85 | <b>\$1980</b> | <b>\$512</b> |

Laminate U-base support is 8"D with 7" inside clearance to wall. Access wall through 14.5"H x 9.5"W hinged door with touch latch in front panel of U-base support. U-base includes 0.5" adjustable glides. U-base side panels are tapered at the bottom to clear most baseboards. **Cut-out locations available in positions 1 or 2 only (except for model GRH364841 - cut-out position available in position 1 only).**

- Metal bases sold separately. Compatible with **GRHB22H41** or **GSHB19H41** only, requires one base.

**Required Specifications**

Top finish  
Base finish

**Optional Specifications**

HP laminate  
Grommet position or power block cut-out

**Accessories**

Power block

# S SWAP™ TABLES

## SOFT ELLIPSE HUDDLE TABLES

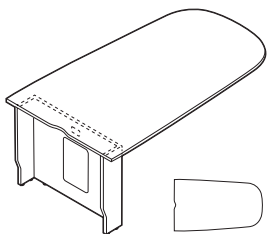

**29"H Soft Ellipse Huddle**

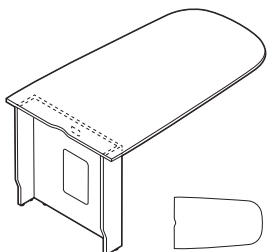

**36"H Soft Ellipse Huddle**

| MODEL #    | DIMENSIONS   | WT/LB. | CUBIC FT. | LIST PRICE    | HP ADD       |
|------------|--------------|--------|-----------|---------------|--------------|
| W x D x H  |              |        |           |               |              |
| GSEH364829 | 36 x 48 x 29 | 77.05  | 3.94      | <b>\$952</b>  | <b>\$188</b> |
| GSEH366029 | 36 x 60 x 29 | 86.95  | 4.46      | <b>\$1161</b> | <b>\$188</b> |
| GSEH367229 | 36 x 72 x 29 | 97     | 4.99      | <b>\$1295</b> | <b>\$195</b> |
| GSEH426029 | 42 x 60 x 29 | 99.82  | 5.18      | <b>\$1301</b> | <b>\$273</b> |
| GSEH427229 | 42 x 72 x 29 | 111.5  | 5.79      | <b>\$1459</b> | <b>\$300</b> |
| GSEH428429 | 42 x 84 x 29 | 123.1  | 11.98     | <b>\$1616</b> | <b>\$477</b> |
| GSEH429629 | 42 x 96 x 29 | 134.7  | 13.31     | <b>\$1746</b> | <b>\$504</b> |
| GSEH486029 | 48 x 60 x 29 | 112.6  | 5.89      | <b>\$1453</b> | <b>\$374</b> |
| GSEH487229 | 48 x 72 x 29 | 126    | 6.58      | <b>\$1626</b> | <b>\$443</b> |
| GSEH488429 | 48 x 84 x 29 | 139.2  | 13.5      | <b>\$1738</b> | <b>\$469</b> |
| GSEH489629 | 48 x 96 x 29 | 152.6  | 15        | <b>\$1880</b> | <b>\$512</b> |

Laminate u-base support is 8"D with 7" inside clearance to wall. Access wall through 14.5"H x 9.5"W hinged door with touch latch in front panel of u-base support. U-base includes 0.5" adjustable glides. U-base side panels are tapered at the bottom to clear most baseboards. **Cut-out locations available in positions 1 or 2 only (except for model GSEH364829 - cut-out position available in position 1 only).**

- Metal bases sold separately. Compatible with **GRHB22H28** or **GSHB19H28** only, requires one base.

|            |              |        |       |               |              |
|------------|--------------|--------|-------|---------------|--------------|
| GSEH364836 | 36 x 48 x 36 | 86     | 4.31  | <b>\$980</b>  | <b>\$188</b> |
| GSEH366036 | 36 x 60 x 36 | 95.9   | 4.84  | <b>\$1189</b> | <b>\$188</b> |
| GSEH367236 | 36 x 72 x 36 | 105.9  | 5.37  | <b>\$1323</b> | <b>\$195</b> |
| GSEH426036 | 42 x 60 x 36 | 109.8  | 5.61  | <b>\$1332</b> | <b>\$273</b> |
| GSEH427236 | 42 x 72 x 36 | 121.5  | 6.22  | <b>\$1491</b> | <b>\$300</b> |
| GSEH428436 | 42 x 84 x 36 | 133.1  | 12.41 | <b>\$1646</b> | <b>\$477</b> |
| GSEH429636 | 42 x 96 x 36 | 144.74 | 13.75 | <b>\$1777</b> | <b>\$504</b> |
| GSEH486036 | 48 x 60 x 36 | 123.6  | 6.38  | <b>\$1488</b> | <b>\$374</b> |
| GSEH487236 | 48 x 72 x 36 | 137    | 7.08  | <b>\$1661</b> | <b>\$443</b> |
| GSEH488436 | 48 x 84 x 36 | 150.24 | 14    | <b>\$1773</b> | <b>\$469</b> |
| GSEH489636 | 48 x 96 x 36 | 163.56 | 15.5  | <b>\$1916</b> | <b>\$512</b> |

Laminate u-base support is 8"D with 7" inside clearance to wall. Access wall through 14.5"H x 9.5"W hinged door with touch latch in front panel of u-base support. U-base includes 0.5" adjustable glides. U-base side panels are tapered at the bottom to clear most baseboards. **Cut-out locations available in positions 1 or 2 only (except for model GSEH364836 - cut-out position available in position 1 only).**

- Metal bases sold separately. Compatible with **GRHB22H35** or **GSHB19H35** only, requires one base.

### Required Specifications

Top finish  
Base finish

### Optional Specifications

HP laminate  
Grommet position or power block cut-out

### Accessories

Power block

SOFT ELLIPSE HUDDLE TABLES

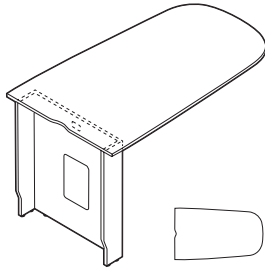

41.5"H Soft Ellipse Huddle

| MODEL #          | DIMENSIONS     | WT/LB. | CUBIC FT. | LIST PRICE    | HP ADD       |
|------------------|----------------|--------|-----------|---------------|--------------|
| <b>W x D x H</b> |                |        |           |               |              |
| GSEH364841       | 36 x 48 x 41.5 | 92.65  | 4.58      | <b>\$1032</b> | <b>\$188</b> |
| GSEH366041       | 36 x 60 x 41.5 | 102.55 | 5.11      | <b>\$1241</b> | <b>\$188</b> |
| GSEH367241       | 36 x 72 x 41.5 | 112.6  | 5.63      | <b>\$1375</b> | <b>\$195</b> |
| GSEH426041       | 42 x 60 x 41.5 | 117.32 | 5.92      | <b>\$1392</b> | <b>\$273</b> |
| GSEH427241       | 42 x 72 x 41.5 | 129    | 6.53      | <b>\$1549</b> | <b>\$300</b> |
| GSEH428441       | 42 x 84 x 41.5 | 140.6  | 12.72     | <b>\$1706</b> | <b>\$477</b> |
| GSEH429641       | 42 x 96 x 41.5 | 152.24 | 14.06     | <b>\$1837</b> | <b>\$504</b> |
| GSEH486041       | 48 x 60 x 41.5 | 130.1  | 6.74      | <b>\$1552</b> | <b>\$374</b> |
| GSEH487241       | 48 x 72 x 41.5 | 143.5  | 7.43      | <b>\$1726</b> | <b>\$443</b> |
| GSEH488441       | 48 x 84 x 41.5 | 156.74 | 14.35     | <b>\$1839</b> | <b>\$469</b> |
| GSEH489641       | 48 x 96 x 41.5 | 170.06 | 15.85     | <b>\$1980</b> | <b>\$512</b> |

Laminate u-base support is 8"D with 7" inside clearance to wall. Access wall through 14.5"H x 9.5"W hinged door with touch latch in front panel of u-base support. U-base includes 0.5" adjustable glides. U-base side panels are tapered at the bottom to clear most baseboards. **Cut-out locations available in positions 1 or 2 only (except for model GSEH364841 - cut-out position available in position 1 only).**

- Metal bases sold separately. Compatible with **GRHB22H41** or **GSHB19H41** only, requires one base.

**Required Specifications**

Top finish  
Base finish

**Optional Specifications**

HP laminate  
Grommet position or power block cut-out

**Accessories**

Power block

## HUDDLE BASES

MODEL # DIMENSIONS WT/LB. CUBIC FT. LIST PRICE HP ADD BCH / CHM ACO / SBR

W x D x H

### SELECT BASE COMPATIBLE WITH TOP HEIGHT:

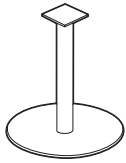

**22" Round Huddle Base**

|           |               |    |      |              |     |              |              |
|-----------|---------------|----|------|--------------|-----|--------------|--------------|
| GRHB22H28 | 22 x - x 28   | 60 | 10   | <b>\$898</b> | N/A | <b>\$147</b> | <b>\$249</b> |
| GRHB22H35 | 22 x - x 35   | 62 | 12.7 | <b>\$933</b> | N/A | <b>\$164</b> | <b>\$268</b> |
| GRHB22H41 | 22 x - x 40.5 | 63 | 14.2 | <b>\$949</b> | N/A | <b>\$171</b> | <b>\$270</b> |

**GRHB22H35** - counter height      **GRHB22H28** - seated height      **GRHB22H41** - bar height

Metal base ships fully assembled. Features 0.5" adjustable glides to level on uneven surfaces. Screws included with base for attaching to appropriate huddle table laminate pieces. See page 323 for available finishes.

Be sure to double check huddle table laminate units and metal bases are the same corresponding heights.

- Plated finishes are available at an upcharge.

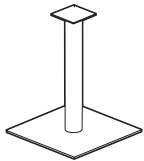

**18.5" Square Huddle Base**

|           |                    |    |      |               |     |              |              |
|-----------|--------------------|----|------|---------------|-----|--------------|--------------|
| GSHB19H28 | 18.5 x 18.5 x 28   | 55 | 6.94 | <b>\$966</b>  | N/A | <b>\$136</b> | <b>\$250</b> |
| GSHB19H35 | 18.5 x 18.5 x 35   | 57 | 8.8  | <b>\$1022</b> | N/A | <b>\$151</b> | <b>\$287</b> |
| GSHB19H41 | 18.5 x 18.5 x 40.5 | 58 | 9.84 | <b>\$1056</b> | N/A | <b>\$166</b> | <b>\$287</b> |

**GSHB19H35** - counter height      **GSHB19H28** - seated height      **GSHB19H41** - bar height

Metal base ships fully assembled. Features 0.5" adjustable glides to level on uneven surfaces. Screws included with base for attaching to appropriate huddle table laminate pieces. See page 323 for available finishes.

Be sure to double check huddle table laminate units and metal bases are the same corresponding heights.

- Plated finishes are available at an upcharge.

### Required Specifications

Finish

### Optional Specifications

# tables training



2gether 358



Bungee/Bungee SL 361



ConnectTABLES 396



Duet 411



Edventure 414



Junction 422



Zook 429



2gether tables are multi-purpose flip-top tables that create dynamic spaces for people to easily connect and learn; ideal for collaborative, classroom, training and conference applications.

2gether tables feature an intuitive “easy touch” mechanism (located at both ends of the table) which allows the user to flip the tables up or down with ease.

2gether tables can be joined in rows for seminars, rearranged in groups to exchange ideas or set up in rows for training rooms. When they are no longer needed, they can be easily folded down and rolled away for compact storage.

2gether works great and looks great in any setting, any time.

**Features and Benefits**

- Flip-top tables.
- Worksurfaces feature 2mm edging in matching color.
- Tops and bases boxed as appropriate.
- Adjustable leveling casters provide smooth mobility.
- Bumpers prevent tables from being damaged while nested.
- Optional modesty panel with integrated wire trough available.
- Optional Black grommets for convenient wire management can be ordered “factory installed”.
- Easy to assemble.
- Available in three sizes: 18”D x 60”W, 24”D x 60”W and 24”D x 72”W
- 2gether table tops are available in a variety of Global laminate finishes.
- Champagne base finish.



Bumpers on legs and undercarriage provide protection while nested.



Offset “Y” leg allows for in line space saving when nested.

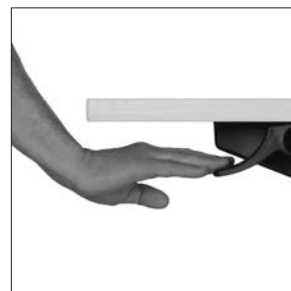

Easy touch lever releases mechanism for effortless movement of table surface.

**GENERAL INFORMATION**

- 2gether is a series of multi-purpose flip-top tables for collaborative, classroom, training and conference applications.
- Created by the designers of G20 seating.
- Off-set “Y” sculpted legs allow for parallel space saving table nesting, to minimize footprint required for storage.
- Optional modesty panels with integrated wire troughs are available.
- Grommets are available on 24” deep worksurfaces.
- Available in three sizes: 18”D x 60”W, 24”D x 60”W and 24”D x 72”W.
- Shipped easy to assemble. Each component is packaged individually; legs are shipped 1 per carton.
- Deliver power to the table top with individually corded modules or the ModPower daisy chain solution.
- For environmental certifications, please visit [globalfurnituregroup.com](http://globalfurnituregroup.com).

**WORKSURFACES**

- 1” thick tops constructed of 45 lb. density particle board with high performance thermally fused laminate.

**CONSTRUCTION**

- “Easy touch” lever located at both sides of the table for flip-top operation from either side.
- 60” and 72” tops include a steel support channel for structural rigidity.
- All finishes feature Global’s preferred edging in matching color (i.e. woodgrain surfaces feature edging with matching printed woodgrain).
- Tops are predrilled with threaded steel inserts.
- 14.25” high optional articulating modesty panel attaches to underside of flip-top.
- Bumpers on legs and under carriage prevent tables from being damaged while nested.
- Champagne base finish.

**FINISHES**

|                            |                               |
|----------------------------|-------------------------------|
| <b>ACJ</b> Absolute Acajou | <b>FCL</b> First Class        |
| <b>ASN</b> Asian Night     | <b>NBL</b> Noce Biondo        |
| <b>AWC</b> Avant Cherry    | <b>NGL</b> Noce Grigio        |
| <b>AWH</b> Avant Honey     | <b>NEL</b> Noce Leggero       |
| <b>BLK</b> Black           | <b>NML</b> Noce Medio         |
| <b>BZD</b> Blizzard        | <b>QTM</b> Quartered Mahogany |
| <b>BRC</b> Brushed Cobalt  | <b>SBY</b> Sheer Beauty       |
| <b>CMB</b> Clear Maple     | <b>SDT</b> Stonedust          |
| <b>CGY</b> Custom Grey     | <b>SOG</b> Storm Grey         |
| <b>DES</b> Dark Espresso   | <b>WHE</b> Walnut Heights     |
| <b>DWT</b> Designer White  | <b>WHC</b> White Chocolate    |
| <b>FAS</b> Fashionista     | <b>WCR</b> Winter Cherry      |

**EDGE DETAIL**

- 2mm matching edge is standard.

**MODESTY PANEL**

- Optional articulating modesty panel available. Champagne finish.

**CASTERS**

- Adjustable leveling casters and two locking casters (**BLK**) on Champagne finish legs are standard.

**WIRE MANAGEMENT**

- Standard with integrated trough underneath table.

**GANGING CONNECTORS**

- Ganging connectors (model **CNGFP**) are available for adjoining tables together, to be ordered separately.
- Tops include predrilled threaded inserts to accept ganging connectors.

**SPECIFICATIONS**

- Specifications marked with an \* are applicable to only those products which have the \* symbol beside the product name.

**GROMMETS**

- Grommets are optional on 24” deep tops only.
- Additional grommets available in standard worksurface locations (left, center or right). Order as: **FOG1, FOG2 or FOG3. Add \$91.**  
**E1, E2 or E3. Add \$91.**
- Grommet hole dimensions are 3.25” wide x 1.875” deep.

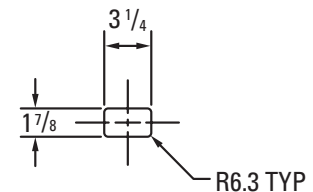

- Actual grommet locations on the worksurface are depicted in the example drawings shown above. Dimensions shown are actual measurements (in inches).

**POWER BLOCK**

- An individual corded power block (model **PMSPDM**) may be ordered for 24”D worksurfaces.
- A power block is a rectangular worksurface power/data module with one electrical duplex receptacle and two data (RJ45) receptacles. 9’ Black cord included. Power block dimensions are 6.5”W x 3.5”D x 2.75”H. Units cannot be daisy-chained.
- To purchase a power block, you must specify both the power block cut-out location and the power block model #. Order power block as **PMSPDM. Add \$268.** Power blocks are available in standard worksurface locations (left, center or right). Order as **E1, E2 or E3. Add \$91.**



Power block **PMSPDM. Add \$268.**

**MODPOWER DAISY CHAIN SOLUTION**

- Add flexible power and USB charging to 2gether tables. Connect up to four units with a single corded infeed with NEMA plug.
- ModPower units are sold separately, refer to Productivity Solutions page 471.
- Begin run with a starter unit which includes a corded infeed. Add additional middle or end units as required. Middle and end units are equipped with connecting cables.
- To be used with **rectangular tables IT2460RX and IT2472RX** only.
- On-surface modules clamp on or screw mount to the table tops.
- In-surface modules require table top cut-outs for mounting. Specify cut-out option:
  - **MPS** for a single cut-out to accommodate one ModPower in-surface unit (cut-out will be centered on the approach side). Add **\$91.**
  - **MPD** for two cut-outs in the left and right positions, 15” from ends to center of unit on approach side. Add **\$183.**



## 2 2GETHER™ TABLES

### TABLES AND MODESTY PANELS

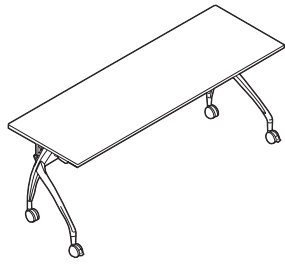

**Flip-Top Rectangular Table\***

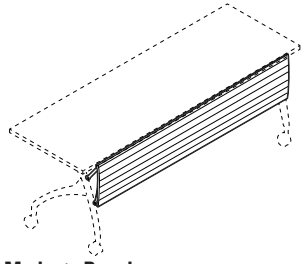

**Modesty Panel**

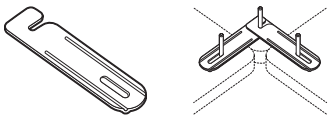

**Ganging Connector**

| MODEL # | DIMENSIONS | WT/LB. | CUBIC FT. | LIST PRICE |
|---------|------------|--------|-----------|------------|
|---------|------------|--------|-----------|------------|

**W x D x H**

|          |              |      |     |               |
|----------|--------------|------|-----|---------------|
| IT1860RX | 60 x 18 x 29 | 63.4 | 7   | <b>\$1552</b> |
| IT2460RX | 60 x 24 x 29 | 73.6 | 7.7 | <b>\$1584</b> |
| IT2472RX | 72 x 24 x 29 | 83.4 | 8.7 | <b>\$1766</b> |

Flip-top table on four adjustable leveling casters, two locking. Easy-touch lever located at both ends of the table allows for activation on either side of the table; offset Y leg accommodates in line nesting for space saving storage. Champagne finish leg. Black/dark grey casters. Optional articulating modesty panel available. Shipped easy to assemble in 3 cartons.

|        |                   |     |     |              |
|--------|-------------------|-----|-----|--------------|
| IT60MP | 51 x 2.75 x 14.25 | 8.4 | 1.6 | <b>\$287</b> |
| IT72MP | 63 x 2.75 x 14.25 | 9.3 | 2   | <b>\$315</b> |

Articulating modesty panel for use with flip-top or fixed top 2gether tables. Champagne finish. Integrated wire management trough. Shipped easy to assemble in 1 carton.

|       |                |     |     |             |
|-------|----------------|-----|-----|-------------|
| CNGFP | 2.5 x 5 x 1.13 | 0.2 | 0.1 | <b>\$33</b> |
|-------|----------------|-----|-----|-------------|

Black epoxy coated 13 gauge steel with two thumbscrews included. Used to connect table tops together for additional stability or for connecting freestanding tops together. Holes with steel inserts are located in the corner of all tops to accommodate this plate. **Sold individually.**

**Required specifications**

Top finish\*

**Optional specifications**

Grommet\* (24" deep only)  
Power block cut-out\* (24" deep only)

**Accessories**

Modesty panel\*



Bungee is a series of freestanding tables and accessories designed for classrooms, training rooms, boardrooms and any other multi-functional space that may require frequent configurations. Tables are sold complete with legs and Bungee cords so they may quickly and easily be connected together without searching for tools or worrying about loose parts.

Bungee tables feature optional rounded corners with a unique Bubble molding that is engineered to compress under the tension of the Bungee cords. The compressed molding creates a seal that serves to locate and align interconnected tables while also providing a soft and forgiving edge. Four additional edge options are available.

Choose from a variety of top shapes and laminate finishes to create your individual style. In addition, most tables offer a choice of tapered legs or spider legs in a Black or Tungsten finish with adjustable levelers or optional casters. Optional modesty panels, grommets, wire management and power blocks further enhance your workspace.

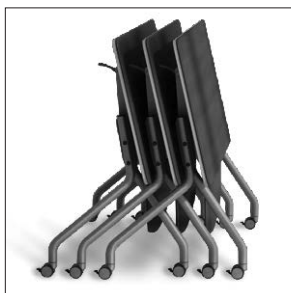

Flip-top tables can be nested and easily stored by activating the single hand release mechanism from the left or right side.

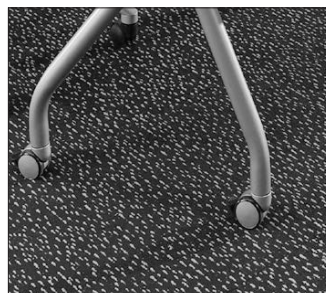

Optional locking casters are available in Black or Tungsten finish (standard on flip-top models).

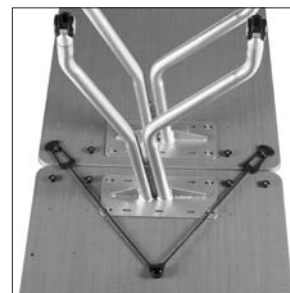

Bungee cords are utilized to quickly and easily reconfigure tables.

## Features and Benefits

- Bungee tables are complete with top, legs and Bungee cords.
- Bungee cords provide a fast and easy method of reconfiguring tables without requiring tools.
- Tops are 1" thick and are offered in a variety of shapes and sizes.
- Legs are offered in tapered or spider design in a Black or Tungsten finish.
- Levelers on legs are standard.
- Laminate modesty panels and filler modesty inserts help conceal wires and enhance visual appeal.
- Wire management tracks neatly contain wires, using two separate channels for data and voice wires.
- Optional grommets or power blocks offer technological flexibility.
- Models with handles feature a bow handle in Silver or Black Nickel finish.
- Metal feet are height adjustable and offered in Black or Tungsten finish.
- Boardrooms were never easier to specify - table "sets" and accessories such as AV cabinets and credenza buffets are specified with one model number.

## GENERAL INFORMATION

- Bungee is a series of freestanding tables and accessories designed for classrooms, training rooms, boardrooms and any other multifunctional space that requires frequent reconfigurations.
- Bungee tables come complete with a work top, a set of legs and built-in Bungee cord connectors.
- Bungee cords allow the movement and reconfiguration of tables without a risk of damage or losing loose parts.
- High pressure tops are available in all Bungee laminate finishes at an extended lead time - please see model # for pricing.
- Unique “bubble molding” edging is specially engineered to create a secure seal to align interconnected tables. Alternate edge options are also available.
- Bungee products have been tested and comply with all mechanical tests.
- For environmental certifications, please visit [globalfurnituregroup.com](http://globalfurnituregroup.com).

## CONSTRUCTION

- Tops are 1" thick. Modesty panels are 11/16" thick.
- All components are made of 45 lb. commercial density particle board, covered on both sides with high performance, thermally fused laminate.
- Tops 54" and over feature a built-in support bar.

## BUNGEE CORDS

- Bungee cords are patented elastic devices designed to provide a rapid, no-tool method of attaching tables of the same depth.
- The elastic nature of cords allows two connected tables to be moved around without risk of damage to the table top or connecting hardware.
- Bungee cords are included with all freestanding tables and carry a Lifetime Warranty.

## EDGE DETAIL

- Six edge details to choose from.
- Unique “bubble molding” is engineered to compress under the tension of the Bungee cords, creating a seal that serves to locate and align interconnected tables.
- Bubble molding finish matches surface laminate with Silver (**BS**) or Black (**BB**) accent trim.
- Split color flat edge top half matches surfaces laminate with Silver (**AS**) or Black (**AB**) bottom accent trim.
- For matching 2mm flat edge, specify (**A3**).
- For matching bicut edge, specify (**AR**).
- Cabinetry and accessories feature Global's preferred edging in matching color.

## LEGS

- Tables feature two styles of legs - tapered leg and spider leg. Available in Black (**TBL**) or Tungsten (**TTU**) finish.
- Levelers are standard. Optional locking casters are available at no upcharge, specify Black (**TBC**) or Tungsten (**TTC**) finish.  
(Casters must match base finish.) Adjust 3mm - 10mm in height.



tapered leg



spider leg

## HANDLES

- Metal handles are standard on all drawers and doors. Handles are offered in two finishes: Silver (**HS**) or Black Nickel (**HT**), please specify.
- Handle finish will match leg finish.



bow handle, Silver finish  
specify (**HS**)



bow handle, Black Nickel finish  
specify (**HT**)

## FEET

- Metal feet are standard on all cabinets. Feet adjust 0.75" in height.
- Feet are available in Black (**TBL**) or Tungsten (**TTU**) finish, please specify.



**TBL** - Black



**TTU** - Tungsten

## MODESTY PANELS

- Panels are 13" high, recessed 0.75" from the back and inset 7" from the sides.
- Panels feature a built-in flexible wire pass-through.
- Available in all Bungee laminate finishes.

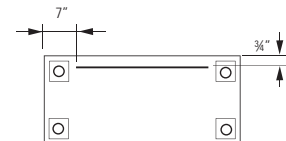
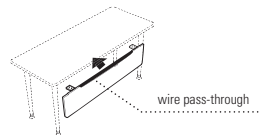

## FILLER MODESTY PANELS

- Used to fill the space between two modesty panels when two tables are linked together. Helps conceal wires and enhance visual appeal.
- Available in Silver finish (**SI**) or Black finish (**BK**), please specify.

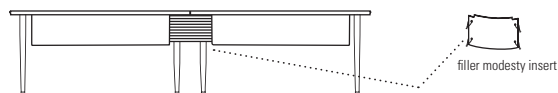

## WIRE MANAGEMENT

- Wire management tracks are mounted to the underside of the worksurface. Available in 5" and 22" track lengths.
- 5" track includes one wire clamp; 22" track includes two wire clamps.
- Data and voice wires can be routed separately using two separate channels on each clamp.
- Available in Black only.

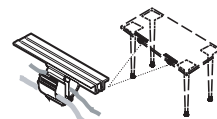

5" wire management track

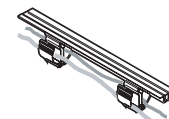

22" wire management track

## 1. SPECIFY MODEL NUMBER

## 2. SPECIFY FINISH

### Laminate Finishes:

|                            |                               |
|----------------------------|-------------------------------|
| <b>ACJ</b> Absolute Acajou | <b>FCL</b> First Class        |
| <b>ASN</b> Asian Night     | <b>NBL</b> Noce Biondo        |
| <b>AWC</b> Avant Cherry    | <b>NGL</b> Noce Grigio        |
| <b>AWH</b> Avant Honey     | <b>NEL</b> Noce Leggero       |
| <b>BLK</b> Black           | <b>NML</b> Noce Medio         |
| <b>BZD</b> Blizzard        | <b>QTM</b> Quartered Mahogany |
| <b>BRC</b> Brushed Cobalt  | <b>SBY</b> Sheer Beauty       |
| <b>CMB</b> Clear Maple     | <b>SDT</b> Stonedust          |
| <b>CGY</b> Custom Grey     | <b>SOG</b> Storm Grey         |
| <b>DES</b> Dark Espresso   | <b>WHE</b> Walnut Heights     |
| <b>DWT</b> Designer White  | <b>WHC</b> White Chocolate    |
| <b>FAS</b> Fashionista     | <b>WCR</b> Winter Cherry      |

### Edge:

|  |
|--|
| <b>BB</b> Bubble edge with Black trim            |
| <b>BS</b> Bubble edge with Silver trim           |
| <b>AB</b> Split color flat edge with Black trim  |
| <b>AS</b> Split color flat edge with Silver trim |
| <b>A3</b> Matching 2mm flat edge                 |
| <b>AR</b> Matching bicut edge                    |

### Legs:

|                     |
|---------------------|
| <b>TBL</b> Black    |
| <b>TTU</b> Tungsten |

### Casters:

|                     |
|---------------------|
| <b>TBC</b> Black    |
| <b>TTC</b> Tungsten |

### Handles:

|                         |
|-------------------------|
| <b>HS</b> Silver finish |
| <b>HT</b> Black finish  |

### Modesty Panel Edge:

|                        |
|------------------------|
| <b>SI</b> Silver       |
| <b>BK</b> Black Nickel |

### Feet

|                  |                     |
|------------------|---------------------|
| <b>TBL</b> Black | <b>TTU</b> Tungsten |
|------------------|---------------------|

## 3. SPECIFY OPTIONS

### GROMMETS

- Optional grommets available in standard worksurface locations (left, center or right) for **rectangular tops** (48" wide and up). Order as: **FOG1, FOG2 or FOG3. Add \$91.**
- Optional grommets are available in **center position only** for **rectangular tops** (36" and 42" wide), **trapezoid tables** and **ALL flip-top and transformer tables.** Order as **FOG2. Add \$91** per table.
- FOG2** when selected will apply to all 4 or 6 tables in transformer table kits accordingly.
- Grommet hole dimensions are 3.25" wide x 1.875" deep.
- Grommets may be placed at non-standard locations. Order as: **CSG. Add \$132.** A drawing must be supplied with vertical and horizontal dimensions to the center of the cut-out (as in drawing above). Please refer to the **custom grommet location form** in the back reference section.

### Grommet hole dimensions

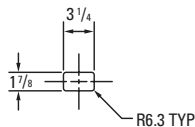

### Grommet

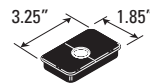

### Rectangular Tops

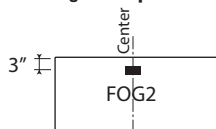

For 36", 42" and 48" wide units

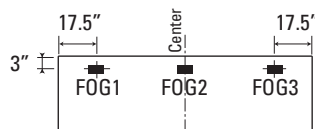

For 60" and 72" wide units

### Trapezoid Tables and all Flip-Top Tables

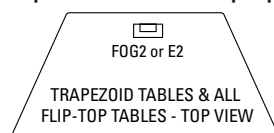

grommet location  
**FOG2. Add \$91.**

### Transformer Tables

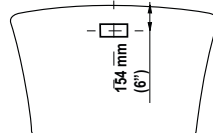

grommet location  
**FOG2. Add \$91** x number of tables in kit

### POWER BLOCK

- An individual corded power block is a rectangular worksurface power/data module with one electrical duplex receptacle and two data (RJ45) receptacles. 9' Black cord included. Power block dimensions are 6.5"W x 3.5"D x 2.75"H. Power blocks are ordered separately. Units cannot be daisy-chained.
- A power block cut-out may be ordered for **rectangular tables** (60" wide and up) in left, center or right position. Order as **E1, E2 or E3. Add \$91.**
- A power block cut-out may be ordered for **rectangular tables** (36", 42" and 48" wide), **all trapezoid tables, flip-top and transformer tables** as an option in center position only, order as **E2. Add \$91** per table.
- E2** when selected will apply to all 4 or 6 tables in transformer table kit accordingly.
- Power block(s) ordered separately, specify model **PMSPPM. Add \$268** each.
- See left example for placement.**

### Rectangular Tops



For 36", 42" and 48" wide units

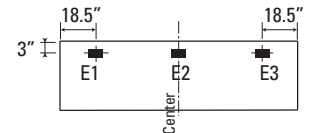

For 60" and 72" wide units

### Transformer Tables

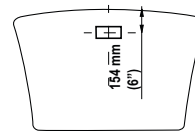

cut-out location



Power block **PMSPPM. Add \$268.**

### MODPOWER DAISY-CHAIN SOLUTION

- Add flexible power and USB charging to Bungee **rectangular tables.** Connect up to four units with a single corded infeed with NEMA plug.
- ModPower units are sold separately, refer to Productivity Solutions page 471.
- Begin run with a starter unit which includes a corded infeed. Add additional middle or end units as required. Middle and end units are equipped with connecting cables.
- On-surface modules clamp on or screw mount to the table tops.
- In-surface modules require table top cut-outs for mounting. Specify cut-out option:
  - **MPS** for a single cut-out to accommodate one ModPower in-surface unit (cut-out will be centered on the approach side) for **42" to 72" wide fixed top** rectangular tables and **48" to 72" wide flip-top** rectangular tables. Add **\$91.** Note: MPS not available for 36" wide fixed top tables or 42" wide flip-top tables.
  - **MPD** for two cut-outs in the left and right positions, 18.25" from ends to center of unit on approach side for **60", 66" and 72" wide rectangular tables.** Add **\$183.**

### SPECIFICATIONS

- Specifications marked with an \* are applicable to only those products which have the \* symbol beside the product name.

# B BUNGEE™ TABLES - NOTES

## CONNECTING CONDITIONS

- Bungee cords allow for fast and easy reconfiguring of tables whenever needed. Due to the elastic nature of the Bungee cord, two tables connected with Bungee cords can be moved around without risk of damage to the table top or the connecting hardware.
- Connecting tables is simple and intuitive. Tools are not required and there are no loose parts that may be misplaced.
- Bungee cords connect tables of the same depth in all directions.
- Rectangular tables 48" and longer connect in both straight and "L" configurations. Rectangular tables 36" and 42" connect in straight configurations only.

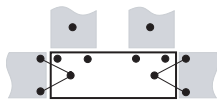
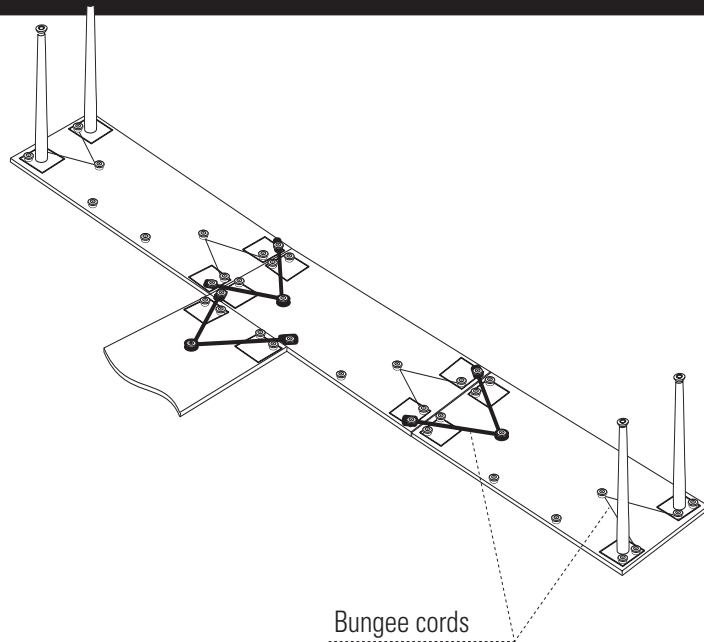

rectangular tables

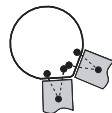

round wedge tables

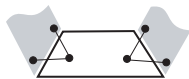

trapezoid tables

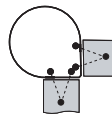

teardrop tables

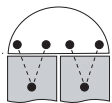

half moon tables

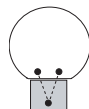

flat round tables

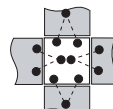

square tables



keystone tables



wedge tables

## SAMPLE TABLE CONFIGURATIONS

- The following table configurations can be created using Bungee boardroom table sets only. See pages 372-373 for specific models / configurations.

meeting/boardroom table



meeting/boardroom table



training

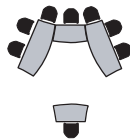

lecture/  
AV presentations

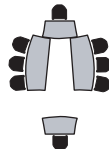

small  
teaming stations



large  
teaming stations



meeting/boardroom table



training



## FLIP-TOP TABLE NESTING DIAGRAM

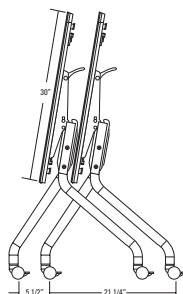
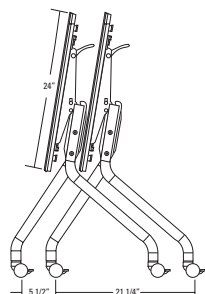

**RECTANGULAR TABLES**

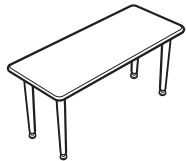
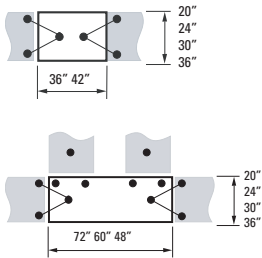

**Rectangular Table - Tapered Legs**

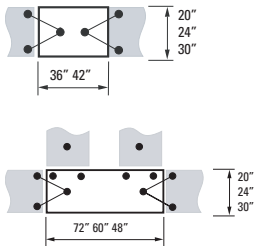

**Rectangular Table - Spider Legs**

| MODEL #   | DIMENSIONS     | WT/LB. | CUBIC FT. | LIST PRICE    | HP ADD       |
|-----------|----------------|--------|-----------|---------------|--------------|
| W x D x H |                |        |           |               |              |
| B2036REF  | 36 x 20 x 28.7 | 59     | 5.25      | <b>\$717</b>  | <b>\$169</b> |
| B2042REF  | 42 x 20 x 28.7 | 62     | 5.75      | <b>\$740</b>  | <b>\$226</b> |
| B2048REF  | 48 x 20 x 28.7 | 67     | 6         | <b>\$773</b>  | <b>\$226</b> |
| B2060REF  | 60 x 20 x 28.7 | 74     | 7         | <b>\$881</b>  | <b>\$310</b> |
| B2072REF  | 72 x 20 x 28.7 | 81     | 7.25      | <b>\$965</b>  | <b>\$352</b> |
| B2436REF  | 36 x 24 x 28.7 | 65     | 5.75      | <b>\$762</b>  | <b>\$169</b> |
| B2442REF  | 42 x 24 x 28.7 | 69     | 6         | <b>\$789</b>  | <b>\$226</b> |
| B2448REF  | 48 x 24 x 28.7 | 72     | 6.5       | <b>\$813</b>  | <b>\$226</b> |
| B2460REF  | 60 x 24 x 28.7 | 82     | 7.25      | <b>\$938</b>  | <b>\$339</b> |
| B2472REF  | 72 x 24 x 28.7 | 91     | 8         | <b>\$1020</b> | <b>\$527</b> |
| B3036REF  | 36 x 30 x 28.7 | 70     | 7.25      | <b>\$757</b>  | <b>\$317</b> |
| B3042REF  | 42 x 30 x 28.7 | 78     | 7.5       | <b>\$789</b>  | <b>\$352</b> |
| B3048REF  | 48 x 30 x 28.7 | 81     | 7.5       | <b>\$813</b>  | <b>\$386</b> |
| B3060REF  | 60 x 30 x 28.7 | 92     | 8.25      | <b>\$938</b>  | <b>\$386</b> |
| B3072REF  | 72 x 30 x 28.7 | 102    | 9         | <b>\$1033</b> | <b>\$527</b> |
| B3642REF  | 42 x 36 x 28.7 | 83     | 7.5       | <b>\$870</b>  | <b>\$339</b> |
| B3648REF  | 48 x 36 x 28.7 | 91     | 8         | <b>\$952</b>  | <b>\$352</b> |
| B3660REF  | 60 x 36 x 28.7 | 103    | 9         | <b>\$1033</b> | <b>\$386</b> |
| B3672REF  | 72 x 36 x 28.7 | 116    | 10        | <b>\$1159</b> | <b>\$527</b> |

Freestanding table includes four tapered legs with levelers and Bungee cords. When **(BB)** or **(BS)** edge option is specified, surface corners are radiused; when **(AS)**, **(AB)**, **(A3)** or **(AR)** edge option is specified, surface corners are square. Each table can be "Bungee-tied" to other tables of the same depth. Shipped easy to assemble in 2 cartons. Modesty panels available, see page 370.

- **Tables 48" and longer connect in both straight and "L" configurations.**
- **Tables 36" and 42" connect in straight configurations only.**
- Available with optional locking casters, specify Black **(TBC)** or Tungsten **(TTC)**.

|          |                |     |       |               |              |
|----------|----------------|-----|-------|---------------|--------------|
| B2036RES | 36 x 20 x 28.7 | 57  | 6.75  | <b>\$813</b>  | <b>\$169</b> |
| B2042RES | 42 x 20 x 28.7 | 60  | 7.25  | <b>\$837</b>  | <b>\$226</b> |
| B2048RES | 48 x 20 x 28.7 | 65  | 7.5   | <b>\$870</b>  | <b>\$226</b> |
| B2060RES | 60 x 20 x 28.7 | 72  | 8.5   | <b>\$975</b>  | <b>\$310</b> |
| B2072RES | 72 x 20 x 28.7 | 79  | 8.75  | <b>\$1063</b> | <b>\$352</b> |
| B2436RES | 36 x 24 x 28.7 | 62  | 7.25  | <b>\$857</b>  | <b>\$169</b> |
| B2442RES | 42 x 24 x 28.7 | 67  | 7.5   | <b>\$881</b>  | <b>\$226</b> |
| B2448RES | 48 x 24 x 28.7 | 71  | 10    | <b>\$912</b>  | <b>\$226</b> |
| B2460RES | 60 x 24 x 28.7 | 80  | 10.75 | <b>\$1033</b> | <b>\$339</b> |
| B2472RES | 72 x 24 x 28.7 | 89  | 11.25 | <b>\$1119</b> | <b>\$527</b> |
| B3036RES | 36 x 30 x 28.7 | 72  | 10.25 | <b>\$881</b>  | <b>\$317</b> |
| B3042RES | 42 x 30 x 28.7 | 80  | 10.5  | <b>\$909</b>  | <b>\$352</b> |
| B3048RES | 48 x 30 x 28.7 | 83  | 10.5  | <b>\$938</b>  | <b>\$386</b> |
| B3060RES | 60 x 30 x 28.7 | 94  | 11.25 | <b>\$1063</b> | <b>\$386</b> |
| B3072RES | 72 x 30 x 28.7 | 104 | 12    | <b>\$1144</b> | <b>\$528</b> |

Freestanding table includes two spider legs with levelers and Bungee cords. When **(BB)** or **(BS)** edge option is specified, surface corners are radiused; when **(AS)**, **(AB)**, **(A3)** or **(AR)** edge option is specified, surface corners are square. Each table can be "Bungee-tied" to other tables of the same depth. Shipped easy to assemble in 2 cartons. Modesty panels available, see page 370.

- **Tables 48" and longer connect in both straight and "L" configurations.**
- **Tables 36" and 42" connect in straight configurations only.**
- Available with optional locking casters, specify Black **(TBC)** or Tungsten **(TTC)**.

**Required specifications**

Top finish  
Edge detail  
Leg finish

**Optional specifications**

Casters  
Grommet  
Power block cut-out  
HP laminate

**Accessories**

Power block

# B BUNGEE™ TABLES

## TRAPEZOID TABLES

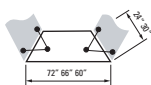

Trapezoid Table - Tapered Legs

| MODEL #  | DIMENSIONS<br>W x D x H | WT/LB. | CUBIC FT. | LIST PRICE    | HP ADD       |
|----------|-------------------------|--------|-----------|---------------|--------------|
| B2460TRF | 60 x 24 x 28.7          | 71     | 7.5       | <b>\$870</b>  | <b>\$339</b> |
| B2466TRF | 66 x 24 x 28.7          | 74     | 8         | <b>\$881</b>  | <b>\$527</b> |
| B2472TRF | 72 x 24 x 28.7          | 78     | 8.25      | <b>\$952</b>  | <b>\$527</b> |
| B3060TRF | 60 x 30 x 28.7          | 78     | 8.5       | <b>\$926</b>  | <b>\$386</b> |
| B3066TRF | 66 x 30 x 28.7          | 81     | 9.5       | <b>\$965</b>  | <b>\$527</b> |
| B3072TRF | 72 x 30 x 28.7          | 85     | 9.5       | <b>\$1020</b> | <b>\$527</b> |

Freestanding table includes four tapered legs with levelers and Bungee cords. Bubble edge options (**BB**) or (**BS**) only apply (edge options (**AS**), (**AB**), (**A3**) and (**AR**) are not applicable on trapezoid tables). Each table can be "Bungee-tied" to other tables of the same depth. Shipped easy to assemble in 2 cartons. Modesty panels available, see pages 370-371.

- Available with optional locking casters, specify Black (**TBC**) or Tungsten (**TTC**).

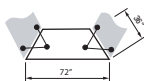
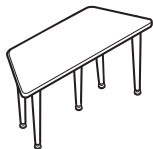

Trapezoid Table - Tapered Legs

|          |                |    |      |               |     |
|----------|----------------|----|------|---------------|-----|
| B3672TRF | 72 x 36 x 28.7 | 91 | 10.5 | <b>\$1185</b> | N/A |
|----------|----------------|----|------|---------------|-----|

Freestanding table includes five tapered legs with levelers and Bungee cords. Bubble edge options (**BB**) or (**BS**) only apply (edge options (**AS**), (**AB**), (**A3**) and (**AR**) are not applicable on trapezoid tables). Each table can be "Bungee-tied" to other tables of the same depth. Shipped easy to assemble in 2 cartons. Modesty panels available, see pages 370-371.

- Available with optional locking casters, specify Black (**TBC**) or Tungsten (**TTC**).

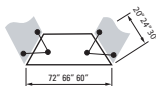

Trapezoid Table - Spider Legs

|          |                |    |      |               |              |
|----------|----------------|----|------|---------------|--------------|
| B2060TRS | 60 x 20 x 28.7 | 67 | 8.75 | <b>\$938</b>  | <b>\$310</b> |
| B2066TRS | 66 x 20 x 28.7 | 68 | 9    | <b>\$965</b>  | <b>\$352</b> |
| B2072TRS | 72 x 20 x 28.7 | 74 | 9.25 | <b>\$1005</b> | <b>\$352</b> |
| B2460TRS | 60 x 24 x 28.7 | 69 | 9.25 | <b>\$965</b>  | <b>\$339</b> |
| B2466TRS | 66 x 24 x 28.7 | 72 | 9.75 | <b>\$1005</b> | <b>\$527</b> |
| B2472TRS | 72 x 24 x 28.7 | 76 | 10   | <b>\$1047</b> | <b>\$527</b> |
| B3060TRS | 60 x 30 x 28.7 | 79 | 11.5 | <b>\$1038</b> | <b>\$386</b> |
| B3066TRS | 66 x 30 x 28.7 | 83 | 12.5 | <b>\$1078</b> | <b>\$527</b> |
| B3072TRS | 72 x 30 x 28.7 | 87 | 12.5 | <b>\$1134</b> | <b>\$527</b> |

Freestanding table includes two spider legs with levelers and Bungee cords. Bubble edge options (**BB**) or (**BS**) only apply (edge options (**AS**), (**AB**), (**A3**) and (**AR**) are not applicable on trapezoid tables). Each table can be "Bungee-tied" to other tables of the same depth. Shipped easy to assemble in 2 cartons. Modesty panels available, see pages 370-371.

- Available with optional locking casters, specify Black (**TBC**) or Tungsten (**TTC**).

## KEYSTONE TABLES

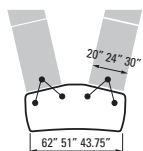
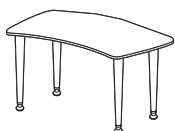

Keystone Table - Tapered Legs

|        |                   |    |     |              |              |
|--------|-------------------|----|-----|--------------|--------------|
| B30KSF | 62 x 30 x 28.7    | 69 | 7.6 | <b>\$998</b> | <b>\$377</b> |
| B24KSF | 51 x 24 x 28.7    | 60 | 6.5 | <b>\$920</b> | <b>\$251</b> |
| B20KSF | 43.75 x 20 x 28.7 | 58 | 6.5 | <b>\$909</b> | <b>\$199</b> |

Freestanding table includes four tapered legs with levelers and Bungee cords. When (**BB**) or (**BS**) edge option is specified, surface corners are radiused; when (**AS**), (**AB**), (**A3**) or (**AR**) edge option is specified, surface corners are square. Each table can be "Bungee-tied" to other tables of 24" and 30" depth. Shipped easy to assemble in 2 cartons. Modesty panels or filler panels are NOT available.

### Required specifications

Top finish  
Edge detail  
Leg finish

### Optional specifications

Grommet (only trapezoid tables)  
Casters (only trapezoid tables)  
Power block cut-out (only trapezoid tables)  
HP laminate

### Accessories

Power block (only trapezoid tables)

**KEYSTONE TABLES**

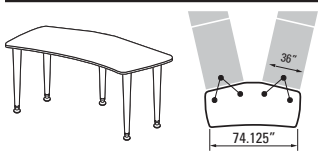

**Keystone Table - Tapered Legs**

| MODEL # | DIMENSIONS<br>W x D x H | WT/LB. | CUBIC FT. | LIST PRICE    | HP ADD       |
|---------|-------------------------|--------|-----------|---------------|--------------|
| B36KSF  | 74.13 x 36 x 28.7       | 84     | 8.4       | <b>\$1232</b> | <b>\$527</b> |

Freestanding table includes five tapered legs with levelers and Bungee cords. When **(BB)** or **(BS)** edge option is specified, surface corners are radiused; when **(AS)**, **(AB)**, **(A3)** or **(AR)** edge option is specified, surface corners are square. Each table can be "Bungee-tied" to other tables of 36" depth. Shipped easy to assemble in 2 cartons. Modesty panels or filler panels are NOT available.

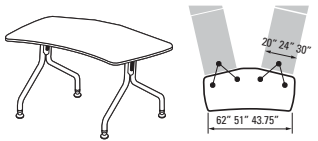

**Keystone Table - Spider Legs**

|        |                   |    |     |               |              |
|--------|-------------------|----|-----|---------------|--------------|
| B30KSS | 62 x 30 x 28.7    | 77 | 7.6 | <b>\$1164</b> | <b>\$377</b> |
| B24KSS | 51 x 24 x 28.7    | 66 | 6.5 | <b>\$1059</b> | <b>\$251</b> |
| B20KSS | 43.75 x 20 x 28.7 | 64 | 6.5 | <b>\$1059</b> | <b>\$199</b> |

Freestanding table includes two spider legs with levelers and Bungee cords. When **(BB)** or **(BS)** edge option is specified, surface corners are radiused; when **(AS)**, **(AB)**, **(A3)** or **(AR)** edge option is specified, surface corners are square. Each table can be "Bungee-tied" to other tables of 24" and 30" depth. Shipped easy to assemble in 2 cartons. Modesty panels or filler panels are NOT available.

**WEDGE TABLES**

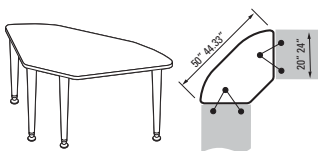

**Wedge Table - Tapered Legs**

|        |                |    |     |              |              |
|--------|----------------|----|-----|--------------|--------------|
| B24WEF | 63 x 24 x 28.7 | 54 | 6.6 | <b>\$957</b> | <b>\$251</b> |
| B20WEF | 57 x 20 x 28.7 | 46 | 5.1 | <b>\$881</b> | <b>\$199</b> |

Freestanding table includes four tapered legs with levelers and Bungee cords. When **(BB)** or **(BS)** edge option is specified, surface corners are radiused; when **(AS)**, **(AB)**, **(A3)** or **(AR)** edge option is specified, surface corners are square. Each table can be "Bungee-tied" to other tables of the same depth. Shipped easy to assemble in 2 cartons. Modesty panels available, see page 370.

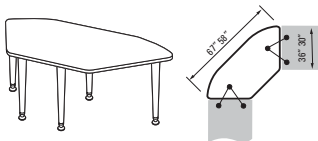

**Wedge Table - Tapered Legs**

|        |                |    |     |               |              |
|--------|----------------|----|-----|---------------|--------------|
| B36WEF | 80 x 36 x 28.7 | 84 | 9.4 | <b>\$1310</b> | <b>\$450</b> |
| B30WEF | 70 x 30 x 28.7 | 70 | 7.2 | <b>\$1164</b> | <b>\$312</b> |

Freestanding table includes five tapered legs with levelers and Bungee cords. When **(BB)** or **(BS)** edge option is specified, surface corners are radiused; when **(AS)**, **(AB)**, **(A3)** or **(AR)** edge option is specified, surface corners are square. Each table can be "Bungee-tied" to other tables of the same depth. Shipped easy to assemble in 2 cartons. Modesty panels available, see page 370.

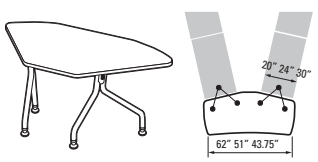

**Wedge Table - Spider Legs**

|        |                |    |     |               |              |
|--------|----------------|----|-----|---------------|--------------|
| B30WES | 70 x 30 x 28.7 | 73 | 7.2 | <b>\$1151</b> | <b>\$312</b> |
| B24WES | 63 x 24 x 28.7 | 62 | 6.6 | <b>\$1073</b> | <b>\$251</b> |
| B20WES | 57 x 20 x 28.7 | 52 | 5.1 | <b>\$998</b>  | <b>\$199</b> |

Freestanding table includes two spider legs with levelers and Bungee cords. When **(BB)** or **(BS)** edge option is specified, surface corners are radiused; when **(AS)**, **(AB)**, **(A3)** or **(AR)** edge option is specified, surface corners are square. Each table can be "Bungee-tied" to other tables of the same depth. Shipped easy to assemble in 2 cartons. Modesty panels available, see page 370.

**Required specifications**

Top finish  
Edge detail  
Leg finish

**Optional specifications**

Casters (only half moon tables)  
Grommet (only half moon tables)  
HP laminate

**Accessories**

Power block (only position 2)



## B BUNGEE™ TABLES

### HALF MOON TABLES

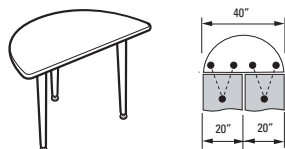

Half Moon Table - Tapered Legs

| MODEL #  | DIMENSIONS<br>W x D x H | WT/LB. | CUBIC FT. | LIST PRICE   | HP ADD       |
|----------|-------------------------|--------|-----------|--------------|--------------|
| B2040HMF | 40 x 20 x 28.7          | 49     | 6         | <b>\$567</b> | <b>\$226</b> |

Freestanding table includes three tapered legs with levelers and Bungee cords. When **(BB)** or **(BS)** edge option is specified, surface corners are radiused; when **(AS)**, **(AB)**, **(A3)** or **(AR)** edge option is specified, surface corners are square. Each table can be "Bungee-tied" to other tables of the same depth. Shipped easy to assemble in 2 cartons. Modesty panels or filler panels are NOT available.

- Available with optional locking casters, specify Black **(TBC)** or Tungsten **(TTC)**.

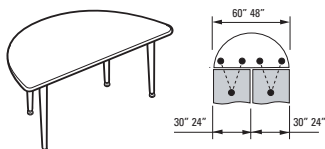

Half Moon Table - Tapered Legs

|          |                |     |      |              |              |
|----------|----------------|-----|------|--------------|--------------|
| B2448HMF | 48 x 24 x 28.7 | 110 | 7.75 | <b>\$740</b> | <b>\$226</b> |
| B3060HMF | 60 x 30 x 28.7 | 81  | 8.5  | <b>\$789</b> | <b>\$386</b> |

Freestanding table includes four tapered legs with levelers and Bungee cords. When **(BB)** or **(BS)** edge option is specified, surface corners are radiused; when **(AS)**, **(AB)**, **(A3)** or **(AR)** edge option is specified, surface corners are square. Each table can be "Bungee-tied" to other tables of the same depth. Shipped easy to assemble in 2 cartons. Modesty panels or filler panels are NOT available.

- Available with optional locking casters, specify Black **(TBC)** or Tungsten **(TTC)**.

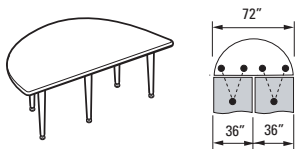

Half Moon Table - Tapered Legs

|          |                |     |      |               |              |
|----------|----------------|-----|------|---------------|--------------|
| B3672HMF | 72 x 36 x 28.7 | 110 | 11.5 | <b>\$1114</b> | <b>\$527</b> |
|----------|----------------|-----|------|---------------|--------------|

Freestanding table includes five tapered legs with levelers and Bungee cords. When **(BB)** or **(BS)** edge option is specified, surface corners are radiused; when **(AS)**, **(AB)**, **(A3)** or **(AR)** edge option is specified, surface corners are square. Each table can be "Bungee-tied" to other tables of the same depth. Shipped easy to assemble in 2 cartons. Modesty panels or filler panels are NOT available.

- Available with optional locking casters, specify Black **(TBC)** or Tungsten **(TTC)**.

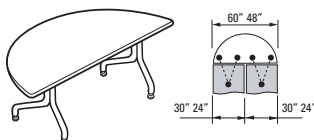

Half Moon Table - Spider Legs\*

|          |                |    |      |              |              |
|----------|----------------|----|------|--------------|--------------|
| B2448HMS | 48 x 24 x 28.7 | 67 | 9.25 | <b>\$844</b> | <b>\$226</b> |
| B3060HMS | 60 x 30 x 28.7 | 83 | 11.5 | <b>\$909</b> | <b>\$386</b> |

Freestanding table includes two spider legs with levelers and Bungee cords. When **(BB)** or **(BS)** edge option is specified, surface corners are radiused; when **(AS)**, **(AB)**, **(A3)** or **(AR)** edge option is specified, surface corners are square. Each table can be "Bungee-tied" to other tables of the same depth. Shipped easy to assemble in 2 cartons. Modesty panels or filler panels are NOT available.

- Available with optional locking casters, specify Black **(TBC)** or Tungsten **(TTC)**.

### SQUARE TABLES

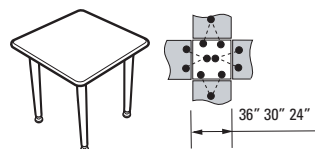

Square Table - Tapered Legs

|          |                |    |     |              |              |
|----------|----------------|----|-----|--------------|--------------|
| B2424SQF | 24 x 24 x 28.7 | 55 | 4.6 | <b>\$705</b> | <b>\$141</b> |
| B3030SQF | 30 x 30 x 28.7 | 65 | 7.5 | <b>\$717</b> | <b>\$209</b> |
| B3636SQF | 36 x 36 x 28.7 | 78 | 8   | <b>\$824</b> | <b>\$253</b> |

Freestanding table includes four tapered legs with levelers and Bungee cords. When **(BB)** or **(BS)** edge option is specified, surface corners are radiused; when **(AS)**, **(AB)**, **(A3)** or **(AR)** edge option is specified, surface corners are square. Each table can be "Bungee-tied" to other tables of the same depth. Shipped easy to assemble in 2 cartons. Note: Square tables will NOT accept laminate modesty panels.

- Available with optional locking casters, specify (Black **(TBC)** or Tungsten **(TTC)**).

#### Required specifications

Top finish  
Edge detail  
Leg finish

#### Optional specifications

Casters  
HP laminate  
Grommet\*

**ROUND WEDGE TABLES**

**MODEL #                      DIMENSIONS                      WT/LB.                      CUBIC FT.                      LIST PRICE                      HP ADD**

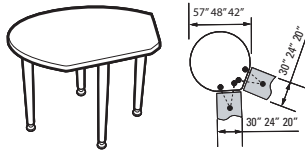

**Round Wedge 120° Table**

|          | W x D x H |    |      |     |       |                           |
|----------|-----------|----|------|-----|-------|---------------------------|
| B2042RWF | 42        | 20 | 28.7 | 76  | 8.25  | <b>\$789</b> <b>\$494</b> |
| B2448RWF | 48        | 24 | 28.7 | 85  | 10.75 | <b>\$813</b> <b>\$494</b> |
| B3057RWF | 57        | 30 | 28.7 | 102 | 12    | <b>\$965</b> <b>\$703</b> |

Freestanding table includes four tapered legs with levelers and Bungee cords. Bubble edge options **(BB)** or **(BS)** only apply (edge options **(AS)**, **(AB)**, **(A3)** and **(AR)** are not applicable on round wedge tables). Each table can be "Bungee-tied" to other tables of the same depth. Shipped easy to assemble in 2 cartons. Modesty panels or filler panels are NOT available.

- Available with optional locking casters, specify Black **(TBC)** or Tungsten **(TTC)**.

**TEARDROP TABLES**

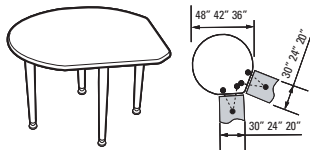

**Teardrop 90° Table**

|          |    |    |      |    |     |                           |
|----------|----|----|------|----|-----|---------------------------|
| B2036TDF | 36 | 20 | 28.7 | 71 | 8   | <b>\$740</b> <b>\$317</b> |
| B2442TDF | 42 | 24 | 28.7 | 81 | 8.5 | <b>\$813</b> <b>\$494</b> |
| B3048TDF | 48 | 30 | 28.7 | 91 | 11  | <b>\$891</b> <b>\$459</b> |

Freestanding table includes four tapered legs with levelers and Bungee cords. Bubble edge options **(BB)** or **(BS)** only apply (edge options **(AS)**, **(AB)**, **(A3)** and **(AR)** are not applicable on teardrop tables). Each table can be "Bungee-tied" to other tables of the same depth. Shipped easy to assemble in 2 cartons. Filler modesty panels available, see page 371.

- Available with optional locking casters, specify Black **(TBC)** or Tungsten **(TTC)**.

**FLAT ROUND TABLES**

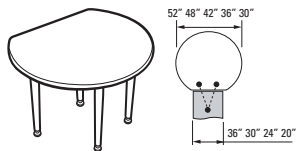

**Flat Round Table**

|          |    |    |      |    |      |                           |
|----------|----|----|------|----|------|---------------------------|
| B2030FRF | 30 | 20 | 28.7 | 56 | 6    | <b>\$717</b> <b>\$283</b> |
| B2036FRF | 36 | 20 | 28.7 | 66 | 7.25 | <b>\$717</b> <b>\$317</b> |
| B2436FRF | 36 | 24 | 28.7 | 64 | 7.25 | <b>\$717</b> <b>\$317</b> |
| B2442FRF | 42 | 24 | 28.7 | 76 | 8.25 | <b>\$857</b> <b>\$494</b> |
| B3042FRF | 42 | 30 | 28.7 | 74 | 8    | <b>\$857</b> <b>\$494</b> |
| B3048FRF | 48 | 30 | 28.7 | 88 | 11   | <b>\$857</b> <b>\$494</b> |
| B3648FRF | 48 | 36 | 28.7 | 85 | 11   | <b>\$952</b> N/A          |
| B3652FRF | 52 | 36 | 28.7 | 93 | 11   | <b>\$952</b> N/A          |

Freestanding table includes four tapered legs with levelers and Bungee cords. Bubble edge options **(BB)** or **(BS)** only apply (edge options **(AS)**, **(AB)**, **(A3)** and **(AR)** are not applicable on flat round tables). Each table can be "Bungee-tied" to other tables of the same depth. Shipped easy to assemble in 2 cartons. Modesty panels or filler panels are NOT available.

- Available with optional locking casters, specify Black **(TBC)** or Tungsten **(TTC)**.

**Required specifications**

op finish  
Edge detail  
Leg finish

**Optional specifications**

Casters  
HP laminate

## B BUNGEE™ TABLES

### MODESTY PANELS - SQUARE

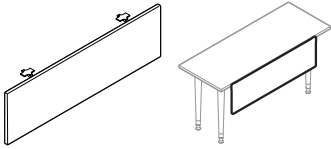

Modesty Panel - Square

| MODEL # | DIMENSIONS<br>W x D x H | WT/LB. | CUBIC FT. | LIST PRICE   | HP ADD |
|---------|-------------------------|--------|-----------|--------------|--------|
| BX36QMP | 21 x 0.69 x 9.6         | 6      | 0.9       | <b>\$97</b>  | N/A    |
| BX42QMP | 27 x 0.69 x 9.6         | 7      | 1.1       | <b>\$101</b> | N/A    |
| BX48QMP | 33 x 0.69 x 9.6         | 9      | 1.2       | <b>\$109</b> | N/A    |
| BX60QMP | 45 x 0.69 x 9.6         | 12     | 1.6       | <b>\$117</b> | N/A    |
| BX66QMP | 51 x 0.69 x 9.6         | 13     | 1.8       | <b>\$123</b> | N/A    |
| BX72QMP | 57 x 0.69 x 9.6         | 14     | 2         | <b>\$127</b> | N/A    |

For use on **rectangular** tables. Includes hinged mounting bracket.

Available in standard line finishes. Edging only available in Silver (**SI**) or Black (**BK**). Please specify.

- Modesty panel model number indicates the width of table to be used on.

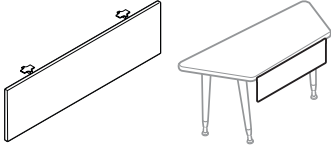

Modesty Panel - Square

|          |                 |    |     |              |     |
|----------|-----------------|----|-----|--------------|-----|
| BXM60QMP | 27 x 0.69 x 9.6 | 7  | 1.1 | <b>\$101</b> | N/A |
| BXM66QMP | 33 x 0.69 x 9.6 | 9  | 1.2 | <b>\$109</b> | N/A |
| BXM72QMP | 39 x 0.69 x 9.6 | 10 | 1.4 | <b>\$113</b> | N/A |
| BXL60QMP | 21 x 0.69 x 9.6 | 6  | 0.9 | <b>\$98</b>  | N/A |
| BXL66QMP | 27 x 0.69 x 9.6 | 7  | 1.1 | <b>\$101</b> | N/A |
| BXL72QMP | 33 x 0.69 x 9.6 | 9  | 1.2 | <b>\$109</b> | N/A |

For use on **trapezoid** tables. Includes hinged mounting bracket. Intended for use on the short side of the table; may be used on long side but leaves a larger gap.

Available in standard line finishes. Edging only available in Silver (**SI**) or Black (**BK**). Please specify.

- Modesty panel model number indicates the width of table to be used on.
- Specify **BXM** models for 24"D tables and **BXL** models for 30"D tables.

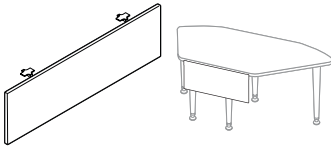

Modesty Panel - Square

|        |                 |   |     |              |     |
|--------|-----------------|---|-----|--------------|-----|
| BXWQMP | 27 x 0.69 x 9.6 | 7 | 1.1 | <b>\$101</b> | N/A |
|--------|-----------------|---|-----|--------------|-----|

For use on **wedge** tables. Includes hinged mounting bracket. Intended for use on the short side of the table.

Available in standard line finishes. Edging only available in Silver (**SI**) or Black (**BK**). Please specify.

### FILLER MODESTY PANELS

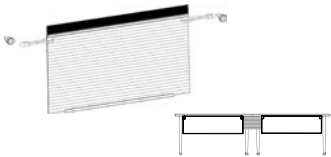

Filler Modesty Panel - Straight

|       |               |   |     |             |     |
|-------|---------------|---|-----|-------------|-----|
| BSFMS | 21 x 0.25 x 9 | 1 | 0.3 | <b>\$98</b> | N/A |
|-------|---------------|---|-----|-------------|-----|

Used to fill the space between two **square** modesty panels where tables are linked in a straight configuration.

Available in Silver (**SI**) or Black (**BK**). Please specify.

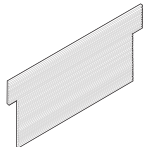

Filler Modesty Panel - Straight to Wedge

|       |                 |   |     |              |     |
|-------|-----------------|---|-----|--------------|-----|
| BSWFM | 19.6 x 9 x 0.25 | 2 | 0.1 | <b>\$127</b> | N/A |
|-------|-----------------|---|-----|--------------|-----|

Used to fill the space between a straight modesty panel and wedge table.

Use for regular wedge table - tapered legs and flip-top wedge - spider legs.

#### Required specifications

Finish

**FILLER MODESTY PANELS**      **MODEL #**      **DIMENSIONS**      **WT/LB.**      **CUBIC FT.**      **LIST PRICE**

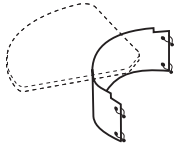

**Filler Modesty Panel - Inside Curve**

|         | W x D x H     |   |     |              |
|---------|---------------|---|-----|--------------|
| B23IFMS | 23 x 0.06 x 9 | 3 | 1.5 | <b>\$127</b> |
| B29IFMS | 29 x 0.06 x 9 | 3 | 1.5 | <b>\$127</b> |
| B30IFMS | 30 x 0.06 x 9 | 3 | 1.5 | <b>\$127</b> |

Used to fill the space (inside curve) between two modesty panels where tables are linked at an angle or curve. Use for the inside curve of round wedge tables, teardrop tables or trapezoid tables.

- Use model **B23IFMS** for trapezoid tables inside curve only.
  - Use model **B29IFMS** for teardrop tables inside curve only.
  - Use model **B30IFMS** for round wedge tables inside curve only.
- Available in Silver (**SI**) or Black (**BK**). Please specify.

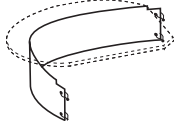

**Filler Modesty Panel - Outside Curve**

|      |               |   |     |              |
|------|---------------|---|-----|--------------|
| B56S | 56 x 0.06 x 9 | 4 | 1.5 | <b>\$178</b> |
| B62S | 62 x 0.06 x 9 | 4 | 1.5 | <b>\$194</b> |
| B71S | 71 x 0.06 x 9 | 4 | 1.5 | <b>\$206</b> |

Used to fill the space (outside curve) between two modesty panels where tables are linked at an angle or curve. Use for teardrop tables only (**B2036TDF, B2442TDF and B3048TDF**).

- Use model **B56S** for **B2036TDF** teardrop tables outside curve only.
  - Use model **B62S** for **B2442TDF** teardrop tables outside curve only.
  - Use model **B71S** for **B3048TDF** teardrop tables outside curve only.
- Available in Silver (**SI**) or Black (**BK**). Please specify.

**WIRE MANAGEMENT**

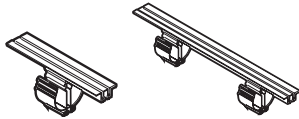

**Wire Management - 5" / 22" Track**

|        |              |     |     |             |
|--------|--------------|-----|-----|-------------|
| BWMS5  | 5 x 2 x 3.5  | 1   | 0.1 | <b>\$6</b>  |
| BWMD22 | 22 x 2 x 3.5 | 1.5 | 0.1 | <b>\$15</b> |

Retrofittable track mounts to the underside of worksurface. Includes wire clamp that can route data and voice wires separately. Black only. There are no specifications for Wire Management.

- For a 5" track, order model **BWMS5** - includes one wire clamp.
- For a 22" track, order model **BWMD22** - includes two wire clamps.

**Required specifications**  
Finish (only modesty panels)

# B BUNGEE™ TABLES

## TRANSFORMER TABLES - 11 FT.

### 11 Foot Configurations

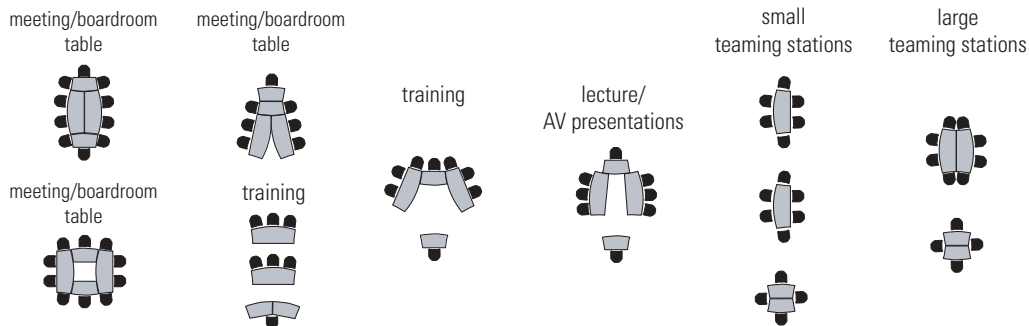

## TRANSFORMER TABLES - 11 FT.

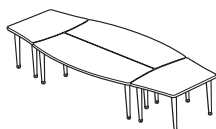

**Transformer Table Set - 11 Foot\***



**Transformer Table Set - 11 Foot\***

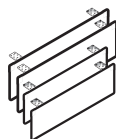

**Square Modesty Panel Set For 11 Foot Transformer Table Set\*\***

| MODEL # | DIMENSIONS | WT/LB. | CUBIC FT. | LIST PRICE |
|---------|------------|--------|-----------|------------|
|---------|------------|--------|-----------|------------|

**W x D x H**

|        |                 |     |       |               |
|--------|-----------------|-----|-------|---------------|
| BK132F | 132 x 60 x 28.7 | 290 | 19.25 | <b>\$3499</b> |
|--------|-----------------|-----|-------|---------------|

Includes four freestanding tables. Each table includes **four tapered legs** with levelers and Bungee cords to be "Bungee-tied" together. Corners of all tops in the set are radiused for all edge options **(BB)**, **(BS)**, **(AB)**, **(AS)**, **(A3)** and **(AR)** due to geometry of the tables together. Shipped easy to assemble in 6 cartons. Modesty panel set available, order **BXK132QMP**.

- Available with optional locking casters, specify Black **(TBC)** or Tungsten **(TTC)**.

|        |                 |     |       |               |
|--------|-----------------|-----|-------|---------------|
| BK132S | 132 x 60 x 28.7 | 290 | 22.25 | <b>\$3936</b> |
|--------|-----------------|-----|-------|---------------|

Includes four freestanding tables. Each table includes **two spider legs** with levelers and Bungee cords to be "Bungee-tied" together. Corners of all tops in the set are radiused for all edge options **(BB)**, **(BS)**, **(AB)**, **(AS)**, **(A3)** and **(AR)** due to geometry of the tables together. Shipped easy to assemble in 6 cartons. Modesty panel set available, order **BXK132QMP**.

- Available with optional locking casters, specify Black **(TBC)** or Tungsten **(TTC)**.

|           |                 |    |     |              |
|-----------|-----------------|----|-----|--------------|
| BXK132QMP | 45 x 0.69 x 9.6 | 31 | 3.2 | <b>\$402</b> |
|-----------|-----------------|----|-----|--------------|

For use on **11 Foot Transformer Table Set**. Includes mounting bracket and wire access sweep. Available in standard line finishes. Edging only available in Silver **(SI)** or Black **(BK)**. Please specify.

#### Required specifications

|                      |              |
|----------------------|--------------|
| Top finish*          | Edge detail* |
| Leg finish*          |              |
| Modesty panel finish |              |
| Edge finish**        |              |

#### Optional specifications

|                      |
|----------------------|
| Casters*             |
| Grommet*             |
| Power block cut-out* |

#### Accessories

|              |
|--------------|
| Power block* |
|--------------|

TRANSFORMER TABLES - 13 AND 15 FT.

13/15 Foot Configurations

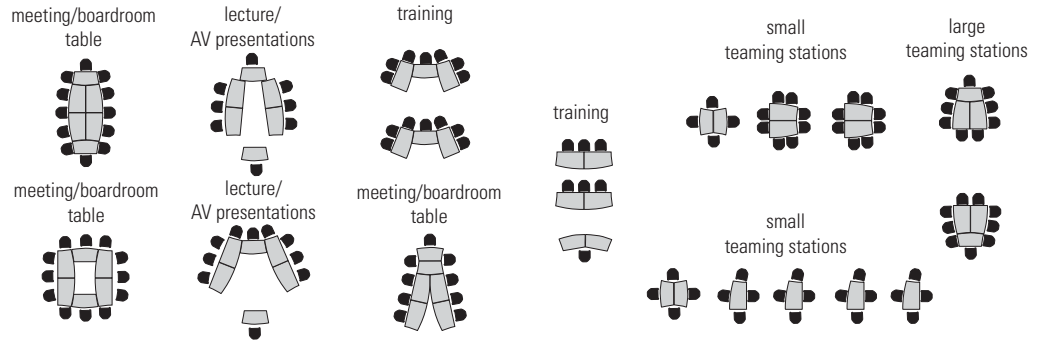

TRANSFORMER TABLES - 13 AND 15 FT.

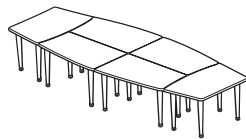

Transformer Table Set - 13 and 15 Foot\*

| MODEL # | DIMENSIONS<br>W x D x H | WT/LB. | CUBIC FT. | LIST PRICE |
|---------|-------------------------|--------|-----------|------------|
| BK156F  | 156 x 60 x 28.7         | 374    | 26.25     | \$5154     |
| BK180F  | 180 x 60 x 28.7         | 420    | 29.75     | \$5622     |

Includes six freestanding tables. Each table includes **four tapered legs** with levelers and Bungee cords to be "Bungee-tied" together. Corners of all tops in the set are radiused for all edge options **(BB)**, **(BS)**, **(AB)**, **(AS)**, **(A3)** and **(AR)** due to geometry of the tables together. Shipped easy to assemble in 9 cartons.

Modesty panel set available, order **BXK156QMP/BXK180QMP**.

- Available with optional locking casters, specify Black **(TBC)** or Tungsten **(TTC)**.

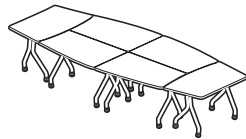

Transformer Table Set - 13 and 15 Foot\*

|        |                 |     |       |        |
|--------|-----------------|-----|-------|--------|
| BK156S | 156 x 60 x 28.7 | 374 | 28.75 | \$5327 |
| BK180S | 180 x 60 x 28.7 | 420 | 32.5  | \$5772 |

Includes six freestanding tables. Each table includes **two spider legs** with levelers and Bungee cords to be "Bungee-tied" together. Corners of all tops in the set are radiused for all edge options **(BB)**, **(BS)**, **(AB)**, **(AS)**, **(A3)** and **(AR)** due to geometry of the tables together. Shipped easy to assemble in 9 cartons.

Modesty panel set available, order **BXK156QMP/BXK180QMP**.

- Available with optional locking casters, specify Black **(TBC)** or Tungsten **(TTC)**.

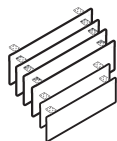

Square Modesty Panel Set for 13 and 15 Foot Transformer Table Sets\*\*

|           |                 |    |     |       |
|-----------|-----------------|----|-----|-------|
| BXK156QMP | 33 x 0.69 x 9.6 | 41 | 3.8 | \$680 |
| BXK180QMP | 45 x 0.69 x 9.6 | 51 | 4.2 | \$655 |

For use on **13 & 15 foot transformer table sets**. Includes mounting bracket and wire access sweep. Available in standard line finishes. Edging only available in Silver **(SI)** or Black **(BK)**. Please specify.

- Use model **BXK156QMP** for **BK156F/S** transformer table set.
- Use model **BXK180QMP** for **BK180F/S** transformer table set.

Required specifications

Top finish\*                      Edge detail\*  
 Leg finish\*  
 Modesty panel finish  
 Edge finish\*\*

Optional specifications

Grommet\*  
 Casters\*  
 Power block cut-out\*

Accessories

Power block\*

# B BUNGEE™ TABLES

## SPIDER LEG TABLES - FLIP-TOP

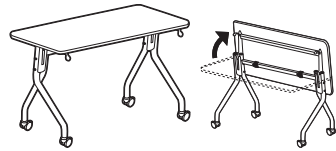
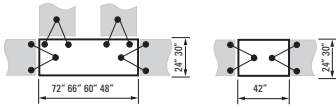

**Flip-Top Rectangular Table - Spider Legs\***

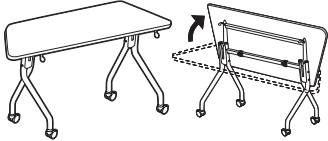
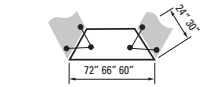

**Flip-Top Trapezoid Table - Spider Legs\***

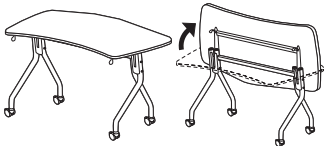

**Flip-Top Keystone Table - Spider Legs**

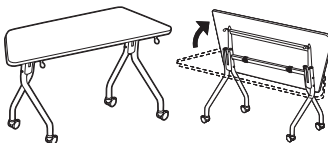

**Flip-Top Wedge Table - Spider Legs\***

| MODEL #   | DIMENSIONS<br>W x D x H | WT/LB. | CUBIC FT. | LIST PRICE    | HP ADD       |
|-----------|-------------------------|--------|-----------|---------------|--------------|
|           |                         |        |           |               |              |
| BX2442RES | 42 x 24 x 29.2          | 66     | 20.75     | <b>\$1407</b> | <b>\$199</b> |
| BX2448RES | 48 x 24 x 29.2          | 72     | 23.5      | <b>\$1423</b> | <b>\$199</b> |
| BX2460RES | 60 x 24 x 29.2          | 84     | 29        | <b>\$1443</b> | <b>\$251</b> |
| BX2466RES | 66 x 24 x 29.2          | 97     | 31.75     | <b>\$1462</b> | <b>\$299</b> |
| BX2472RES | 72 x 24 x 29.2          | 102    | 34.75     | <b>\$1497</b> | <b>\$299</b> |
| BX3042RES | 42 x 30 x 29.2          | 73     | 25.5      | <b>\$1412</b> | <b>\$251</b> |
| BX3048RES | 48 x 30 x 29.2          | 79     | 28.75     | <b>\$1431</b> | <b>\$251</b> |
| BX3060RES | 60 x 30 x 29.2          | 94     | 35.75     | <b>\$1462</b> | <b>\$312</b> |
| BX3066RES | 66 x 30 x 29.2          | 106    | 39.25     | <b>\$1482</b> | <b>\$377</b> |
| BX3072RES | 72 x 30 x 29.2          | 112    | 42.5      | <b>\$1516</b> | <b>\$377</b> |

Table features a flip-top worksurface for ease of storage. When **(BB)** or **(BS)** edge option is specified, surface corners are radiused; when **(AS)**, **(AB)**, **(A3)** or **(AR)** edge option is specified, surface corners are square. Single hand release mechanism can be activated from left or right side of the table. Tables can be nested when folded. Each table can be "Bungee-tied" to other tables of the same depth. Shipped in 1 carton. Folding modesty panels available, see page 375.

- **Tables 48" and longer connect in both straight and "L" configurations.**
- Standard with locking casters, specify Black **(TBC)** or Tungsten **(TTC)**.

|           |                |    |       |               |              |
|-----------|----------------|----|-------|---------------|--------------|
| BX2460TRS | 60 x 24 x 29.2 | 69 | 29    | <b>\$1343</b> | <b>\$251</b> |
| BX2466TRS | 66 x 24 x 29.2 | 74 | 31.75 | <b>\$1360</b> | <b>\$299</b> |
| BX2472TRS | 72 x 24 x 29.2 | 80 | 34.75 | <b>\$1381</b> | <b>\$299</b> |
| BX3060TRS | 60 x 30 x 29.2 | 72 | 35.75 | <b>\$1356</b> | <b>\$312</b> |
| BX3066TRS | 66 x 30 x 29.2 | 78 | 39.25 | <b>\$1374</b> | <b>\$377</b> |
| BX3072TRS | 72 x 30 x 29.2 | 84 | 42.5  | <b>\$1392</b> | <b>\$377</b> |

Table features a flip-top worksurface for ease of storage. Bubble edge options **(BB)** or **(BS)** only apply (edge options **(AS)**, **(AB)**, **(A3)** and **(AR)** are not applicable on trapezoid tables). Single hand release mechanism can be activated from left or right side of the table. Tables can be nested when folded. Each table can be "Bungee-tied" to other tables of the same depth. Shipped in 1 carton. Folding modesty panels available, see page 375.

- Standard with locking casters, specify Black **(TBC)** or Tungsten **(TTC)**.

|         |                |    |       |               |              |
|---------|----------------|----|-------|---------------|--------------|
| BX24KSS | 51 x 24 x 29.2 | 69 | 24.75 | <b>\$1317</b> | <b>\$251</b> |
| BX30KSS | 62 x 30 x 29.2 | 79 | 36.75 | <b>\$1370</b> | <b>\$377</b> |

Table features a flip-top worksurface for ease of storage. When **(BB)** or **(BS)** edge option is specified, surface corners are radiused; when **(AS)**, **(AB)**, **(A3)** or **(AR)** edge option is specified, surface corners are square. Single hand release mechanism can be activated from left or right side of the table. Tables can be nested when folded. Each table can be "Bungee-tied" to other tables of the same depth. Shipped in 1 carton. Modesty panels or filler panels are NOT available.

- Standard with locking casters, specify Black **(TBC)** or Tungsten **(TTC)**.

|         |                |    |    |               |              |
|---------|----------------|----|----|---------------|--------------|
| BX24WES | 63 x 24 x 29.2 | 76 | 33 | <b>\$1654</b> | <b>\$377</b> |
| BX30WES | 70 x 30 x 29.2 | 84 | 33 | <b>\$1680</b> | <b>\$377</b> |

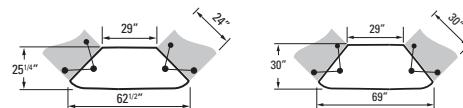

Table features a flip-top worksurface for ease of storage. When **(BB)** or **(BS)** edge option is specified, surface corners are radiused; when **(AS)**, **(AB)**, **(A3)** or **(AR)** edge option is specified, surface corners are square. Single hand release mechanism can be activated from left or right side of the table. Tables can be nested when folded. Each table can be "Bungee-tied" to other tables of the same depth. Shipped in 1 carton. Folding modesty panels available, see page 375.

- Standard with locking casters, specify Black **(TBC)** or Tungsten **(TTC)**.

### Required specifications

Top finish\*  
Edge detail\*  
Leg finish\*

### Optional specifications

Grommet\*  
Power block cut-out\*  
HP laminate\*

### Accessories

Power block\*

**MODESTY PANELS - FLIP-TOP - SQUARE**      **MODEL #**      **DIMENSIONS**      **WT/LB.**      **CUBIC FT.**      **LIST PRICE**      **HP ADD**

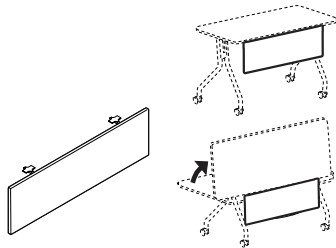

**Modesty Panel - Square**

|         | W x D x H       |    |     |              |  |
|---------|-----------------|----|-----|--------------|--|
| BX36QMP | 21 x 0.69 x 9.6 | 6  | 0.9 | <b>\$97</b>  |  |
| BX42QMP | 27 x 0.69 x 9.6 | 7  | 1.1 | <b>\$101</b> |  |
| BX48QMP | 33 x 0.69 x 9.6 | 9  | 1.2 | <b>\$109</b> |  |
| BX60QMP | 45 x 0.69 x 9.6 | 12 | 1.6 | <b>\$117</b> |  |
| BX66QMP | 51 x 0.69 x 9.6 | 13 | 1.8 | <b>\$123</b> |  |
| BX72QMP | 57 x 0.69 x 9.6 | 14 | 2   | <b>\$127</b> |  |

For use on **flip-top rectangular tables**. Includes hinged mounting bracket. Available in standard line finishes. Edging only available in Silver (**SI**) or Black (**BK**). Please specify.

- Modesty panel model number indicates the width of table to be used on.

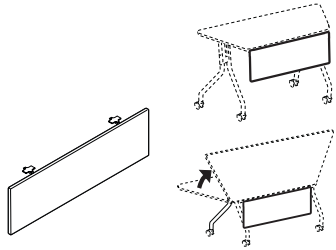

**Modesty Panel - Square**

|          |                 |    |     |              |  |
|----------|-----------------|----|-----|--------------|--|
| BXM60QMP | 27 x 0.69 x 9.6 | 7  | 1.1 | <b>\$101</b> |  |
| BXM66QMP | 33 x 0.69 x 9.6 | 9  | 1.2 | <b>\$109</b> |  |
| BXM72QMP | 39 x 0.69 x 9.6 | 10 | 1.4 | <b>\$113</b> |  |
| BXL60QMP | 21 x 0.69 x 9.6 | 6  | 0.9 | <b>\$98</b>  |  |
| BXL66QMP | 27 x 0.69 x 9.6 | 7  | 1.1 | <b>\$101</b> |  |
| BXL72QMP | 33 x 0.69 x 9.6 | 9  | 1.2 | <b>\$109</b> |  |

For use on **flip-top trapezoid tables**. Includes hinged mounting bracket. Intended for use on the short side of the table; may be used on long side but leaves a larger gap. Available in standard line finishes. Edging only available in Silver (**SI**) or Black (**BK**). Please specify.

- Modesty panel model number indicates the width of table to be used on.

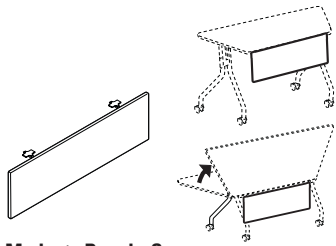

**Modesty Panel - Square**

|        |                 |   |     |              |  |
|--------|-----------------|---|-----|--------------|--|
| BXWQMP | 27 x 0.69 x 9.6 | 7 | 1.1 | <b>\$101</b> |  |
|--------|-----------------|---|-----|--------------|--|

For use on **flip-top wedge tables**. Includes hinged mounting bracket. Intended for use on the short side of the table. Available in standard line finishes. Edging only available in Silver (**SI**) or Black (**BK**). Please specify.

- Modesty panel model number indicates the width of table to be used on.

**Required specifications**

- Modesty panel finish
- Edge finish



# B BUNGEE™ TABLES

## TRANSFORMER TABLES - FLIP-TOP - 4 PC.

### 4 pc. Configurations

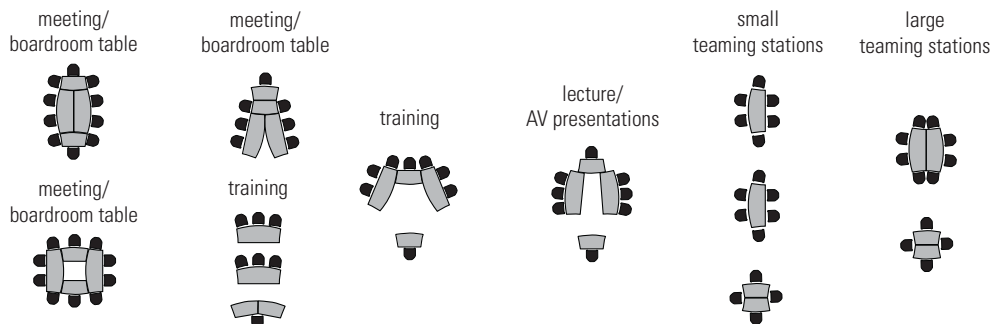

## TRANSFORMER TABLES - FLIP-TOP - 4 PC.

| MODEL # | DIMENSIONS | WT/LB. | CUBIC FT. | LIST PRICE | HP ADD |
|---------|------------|--------|-----------|------------|--------|
|---------|------------|--------|-----------|------------|--------|

W x D x H

|         |                 |     |        |        |        |
|---------|-----------------|-----|--------|--------|--------|
| BXK132S | 132 x 60 x 29.2 | 352 | 151.25 | \$5525 | \$1442 |
|---------|-----------------|-----|--------|--------|--------|



### Transformer Table Set - 4pc. Flip-Top

Includes four freestanding tables with spider legs. All tables feature a flip-top worksurface for ease of storage. Single hand release mechanism can be activated from left or right side of the table. Tables can be nested when folded. Each table can be "Bungee-tied" to other tables. Corners of all tops in the set are radiused for all edge options (**BB**), (**BS**), (**AB**), (**AS**), (**A3**) and (**AR**) due to geometry of the tables together. Shipped in 4 cartons.

Folding modesty panel set available, order **BXK132QMP**.

- Standard with locking casters, specify Black (**TBC**) or Tungsten (**TTC**).

|           |                 |    |     |       |     |
|-----------|-----------------|----|-----|-------|-----|
| BXK132QMP | 45 x 0.69 x 9.6 | 31 | 3.2 | \$402 | N/A |
|-----------|-----------------|----|-----|-------|-----|

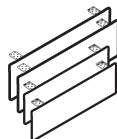

### Square Modesty Panel Set for 4 pc. Flip-Top Table\*

For use on **4 pc. flip-top table kits**. Modesty panels flip down for storage. Features Black wire access sweep. Available in standard line finishes. Edging only available in Silver (**SI**) or Black (**BK**). Please specify.

#### Required specifications

|                      |              |
|----------------------|--------------|
| Top finish           | Edge detail* |
| Leg finish           |              |
| Modesty panel finish |              |
| Edge finish*         |              |

#### Optional specifications

|                     |
|---------------------|
| HP laminate         |
| Grommet             |
| Casters             |
| Power block cut-out |

#### Accessories

|             |
|-------------|
| Power block |
|-------------|

TRANSFORMER TABLES - FLIP-TOP - 6 PC.

6 pc. Configurations

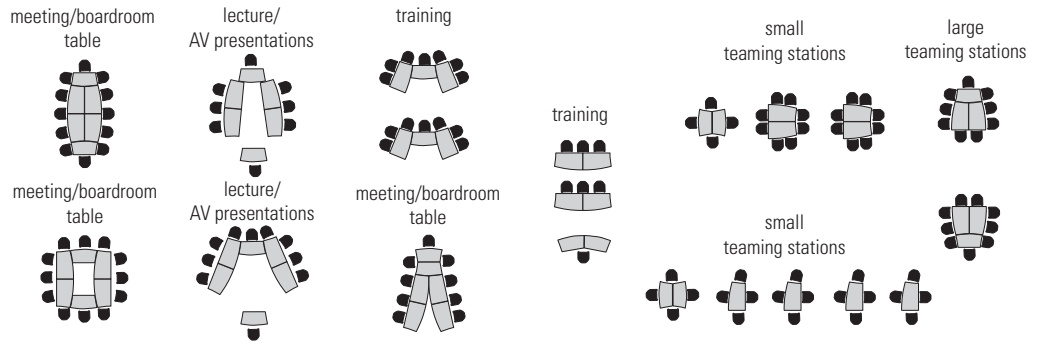

TRANSFORMER TABLES - FLIP-TOP - 6 PC.

| MODEL # | DIMENSIONS | WT/LB. | CUBIC FT. | LIST PRICE | HP ADD |
|---------|------------|--------|-----------|------------|--------|
|---------|------------|--------|-----------|------------|--------|

W x D x H

|         |                 |     |        |               |               |
|---------|-----------------|-----|--------|---------------|---------------|
| BXK156S | 156 x 60 x 29.2 | 452 | 181.75 | <b>\$8115</b> | <b>\$1659</b> |
| BXK180S | 180 x 60 x 29.2 | 507 | 209.5  | <b>\$8253</b> | <b>\$1911</b> |

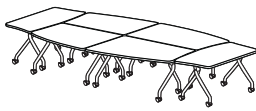

Transformer Table Set - 6 pc. Flip-Top\*

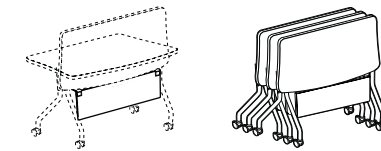

Includes six freestanding tables with spider legs. All tables feature a flip-top worksurface for ease of storage. Single hand release mechanism can be activated from left or right side of the table. Tables can be nested when folded. Each table can be "Bungee-tied" to other tables. Corners of all tops in the set are radiused for all edge options (BB), (BS), (AB), (AS), (A3) and (AR) due to geometry of the tables together. Shipped in 6 cartons.

Folding modesty panel set available, order **BXK156QMP/ BXK180QMP**.

- Standard with locking casters, specify Black (TBC) or Tungsten (TTC).

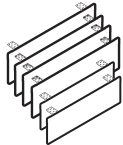

Square Modesty Panel Set for 6 pc. Flip-Top Table\*\*

|           |                 |    |     |              |     |
|-----------|-----------------|----|-----|--------------|-----|
| BXK156QMP | 33 x 0.69 x 9.6 | 41 | 3.8 | <b>\$680</b> | N/A |
| BXK180QMP | 45 x 0.69 x 9.6 | 51 | 4.2 | <b>\$655</b> | N/A |

For use on 6 pc. flip-top table kits. Modesty panels flip down for storage. Features Black wire access sweep. Available in standard line finishes. Edging only available in Silver (SI) or Black (BK). Please specify.

Required specifications

|                      |              |
|----------------------|--------------|
| Top finish*          | Edge detail* |
| Leg finish*          |              |
| Modesty panel finish |              |
| Edge finish**        |              |

Optional specifications

|                      |
|----------------------|
| Grommet*             |
| Casters*             |
| Power block cut-out* |
| HP laminate*         |

Accessories

|              |
|--------------|
| Power block* |
|--------------|

# B BUNGEE™ TABLES

| ACCESSORIES | MODEL # | DIMENSIONS | WT/LB. | CUBIC FT. | LIST PRICE | HP ADD |
|-------------|---------|------------|--------|-----------|------------|--------|
|-------------|---------|------------|--------|-----------|------------|--------|

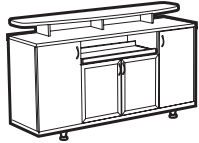

**Credenza Buffet\*\***

|          | W x D x H    |     |      |               |              |  |
|----------|--------------|-----|------|---------------|--------------|--|
| B2072BUF | 72 x 20 x 42 | 305 | 37.5 | <b>\$3055</b> | <b>\$520</b> |  |

Pull-out shelf. Top transaction shelf has optional edge details **(BB)**, **(BS)**, **(AB)**, **(AS)**, **(A3)** or **(AR)**; surface corners are always radiused. Side storage compartments feature a laminate door and one adjustable shelf each. Center storage features frosted aluminum doors with one adjustable shelf. Leveler feet are standard. Some assembly required.

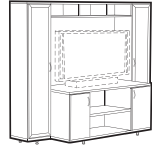

**Audio/Visual Cabinet**

|           |              |     |      |               |              |  |
|-----------|--------------|-----|------|---------------|--------------|--|
| B249072AV | 90 x 24 x 72 | 530 | 52.5 | <b>\$5042</b> | <b>\$527</b> |  |
|-----------|--------------|-----|------|---------------|--------------|--|

Top pigeon holes and center adjustable shelf accommodate electronic equipment, CDs and other media. Bottom storage compartments feature laminate doors and one adjustable shelf. Side storage towers feature frosted aluminum doors with three adjustable shelves each. Accommodates TVs up to 58"W x 34"H x 24"D. Some assembly required.



**Lectern**

|        |              |    |      |              |     |  |
|--------|--------------|----|------|--------------|-----|--|
| B44LEC | 22 x 17 x 44 | 36 | 12.5 | <b>\$801</b> | N/A |  |
|--------|--------------|----|------|--------------|-----|--|

Features angled stand with pencil ledge. Optional edge details for angled surface **(BB)**, **(BS)**, **(AB)**, **(AS)**, **(A3)** or **(AR)**; surface corners are always radiused. Locking casters. Specify Black **(TBC)** or Tungsten **(TTC)**. Shipped assembled in 1 carton.

**Required specifications**

Finish  
Fabric\*  
Handles\*\*

**Optional specifications**

**GENERAL INFORMATION**

- Introducing Bungee SL - a product line to complement and coordinate with the top selling Bungee training tables series.
- Bungee SL takes the popular aesthetic of the Bungee series and allows tables to be specified in shared leg and permanent applications - great for benching, training, teaming and academic areas.
- Bungee SL tops and legs are sold separately, increasing the flexibility of the product in the future and allows for space saving in areas where real estate is a premium.
- High pressure tops are available in all Bungee SL laminates at an extended lead time - please refer to model # for pricing.
- For environmental certifications, please visit [globalfurnituregroup.com](http://globalfurnituregroup.com).

**CONSTRUCTION**

- Tops are 1" thick.
- All laminate components are made of 45 lb. density particle board with high performance thermally fused laminate.
- Tops 60" and over feature a built-in support bar. The support bar is 10" from the **approach** side, and clearance to the bottom of the support bar is 27" from the floor.
- **BUNGEE CORDS ARE NOT INCLUDED AND ARE NOT COMPATIBLE WITH BUNGEE SL TOPS.**

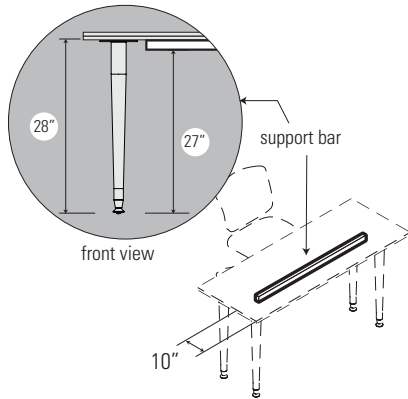

**EDGE DETAIL**

- Bungee SL comes with a choice of four edge styles (two with two-trim finish options):



**A3** - square corner, matching edge



**AR** - square corner, matching bicut edge

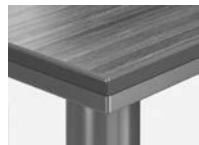

**AS** - square corner, Silver

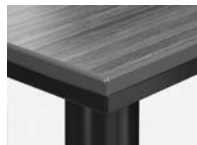

**AB** - square corner, Black

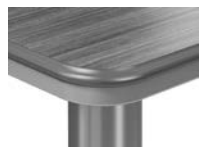

**BS** - rounded corner, Silver



**BB** - rounded corner, Black

- **BB/BS** - Bungee bubble edge: Unique "bubble" molding found on original Bungee.
- **AB/AS** - Split color PVC edge: Edge matches split color aesthetic of the bubble edge, but allows for 90 degree corners and a cleaner look.
- **A3** - 2mm preferred matching edge. Coordinates well with Adaptabilities and Zira 1" tops.
- **AR** - Bicut edge. Coordinates well with Adaptabilities and Zira 1" tops.

**LEGS**

- Two leg styles are available: tapered and spider leg. Available in Black (**TBL**) or Tungsten (**TTU**) finish, please specify. Levelers are standard; casters are not available for Bungee SL legs. Levelers adjust 3mm - 10mm in height.

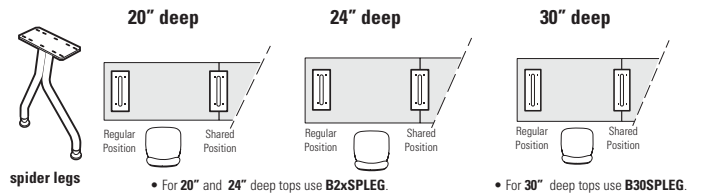

**MODESTY PANELS**

- See **POWER AND DATA MANAGEMENT TROUGHS**, pages 394-394.
- For modesty panels without power and data management, see **Bungee modesty panels**, pages 370-371.

**WIRE MANAGEMENT / POWER OPTIONS**

- **TO UTILIZE BUNGEE SL TO THE FULLEST EXTENT, SPECIFY POWER AND DATA MANAGEMENT TROUGHS**, see page 391.
- For basic wire management see details on pages 393-394.

**SPECIFICATIONS**

- Specifications marked with an \* are applicable to only those products which have the \* symbol beside the product name.

# B BUNGEE SL™ - HOW TO SPECIFY

## 1. SPECIFY MODEL NUMBER

## 2. SPECIFY FINISH

|                            |                               |
|----------------------------|-------------------------------|
| <b>ACJ</b> Absolute Acajou | <b>FCL</b> First Class        |
| <b>ASN</b> Asian Night     | <b>NBL</b> Noce Biondo        |
| <b>AWC</b> Avant Cherry    | <b>NGL</b> Noce Grigio        |
| <b>AWH</b> Avant Honey     | <b>NEL</b> Noce Leggero       |
| <b>BLK</b> Black           | <b>NML</b> Noce Medio         |
| <b>BZD</b> Blizzard        | <b>QTM</b> Quartered Mahogany |
| <b>BRC</b> Brushed Cobalt  | <b>SBY</b> Sheer Beauty       |
| <b>CMB</b> Clear Maple     | <b>SDT</b> Stonedust          |
| <b>CGY</b> Custom Grey     | <b>SOG</b> Storm Grey         |
| <b>DES</b> Dark Espresso   | <b>WHE</b> Walnut Heights     |
| <b>DWT</b> Designer White  | <b>WHC</b> White Chocolate    |
| <b>FAS</b> Fashionista     | <b>WCR</b> Winter Cherry      |

**Edge:**

|           |                                     |
|-----------|-------------------------------------|
| <b>BB</b> | Bungee bubble edge with Black trim  |
| <b>BS</b> | Bungee bubble edge with Silver trim |
| <b>AB</b> | Split color edge with Black trim    |
| <b>AS</b> | Split color edge with Silver trim   |
| <b>A3</b> | Matching 2mm flat edge              |
| <b>AR</b> | Matching bicut edge                 |

**Legs:**

|            |          |
|------------|----------|
| <b>TBL</b> | Black    |
| <b>TTU</b> | Tungsten |

## 3. SPECIFY OPTIONS

### GROMMETS

- Optional grommets available in standard worksurface locations (left, center or right) for **rectangular tops 48" and up**. Order as: **FOG1, FOG2** or **FOG3**. **Add \$91**.
- Optional grommet is available in **center position only for rectangular tops (36" and 42")**, **keystone, half moon and wedge tops**. Order as **FOG2**. **Add \$91**.
- Grommet hole dimensions are 3.25" wide x 1.875" deep.
- Grommets may be placed at non-standard locations. Order as: **CSG**. **Add \$132**. A drawing must be supplied with vertical and horizontal dimensions to the center of the cut-out (as in drawing below). Please refer to the **custom grommet location form** in the back reference section.

### Grommet hole dimensions

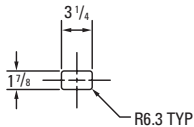

### Grommet

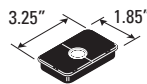

### Keystone

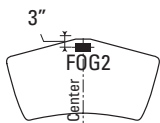

### Half Moon

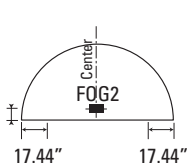

### Wedge

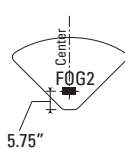

### Rectangular Tops

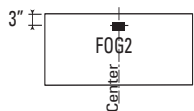

For **36" and 42"** wide units

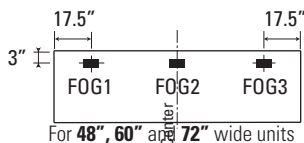

For **48", 60" and 72"** wide units

### POWER BLOCK

- An individual corded power block is a rectangular worksurface power/data module with one electrical duplex receptacle and two data (RJ45) receptacles. 9' Black cord included. Power block dimensions are 6.5"W x 3.5"D x 2.75"H. Power block cut-out dimensions are 2.75" deep x 6" wide. Units cannot be daisy-chained.
- A power block cut-out (model **PMSPPDM**) may be ordered for **rectangular tops (60" and up)** in place of standard grommets. Order as **E1, E2** or **E3**. **Add \$91**.
- A power block cut-out (model **PMSPPDM**) may be ordered in the **center position only for rectangular tops (36", 42" and 48")**, **keystone and half moon tops**. Order as **E2**. **Add \$91**.
- To purchase a power block, you must specify both the power block cut-out location and the power block model #. Order power block separately as **PMSPPDM**. **Add \$268**.

### Keystone

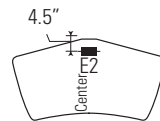

### Half moon

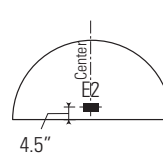

### Power block

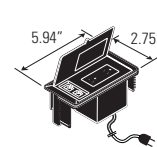

### Rectangular tops

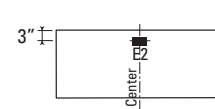

For **36", 42" and 48"** wide units

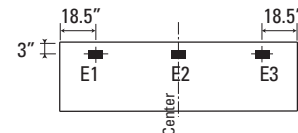

For **60" and 72"** wide units

### MODPOWER DAISY-CHAIN SOLUTION

- Add flexible power and USB charging to Bungee SL rectangular tables. Connect up to four units with a single corded infeed with NEMA plug.
- ModPower units are sold separately, refer to Productivity Solutions page 471.
- Begin run with a starter unit which includes a corded infeed. Add additional middle or end units as required. Middle and end units are equipped with connecting cables.
- On-surface modules clamp on or screw mount to the table tops.
- In-surface modules require table top cut-outs for mounting. Specify cut-out option:
  - **MPS** for a single cut-out to accommodate one ModPower in-surface unit (cut-out will be centered on the approach side) for **42" to 72" wide rectangular tables**. **Add \$91**.
  - **MPD** for two cut-outs in the left and right positions, 18.25" from ends to center of unit on approach side for **60" and 72" wide rectangular tables**. **Add \$183**.

**Square corner**

AB/AS/A3 or AR edge only

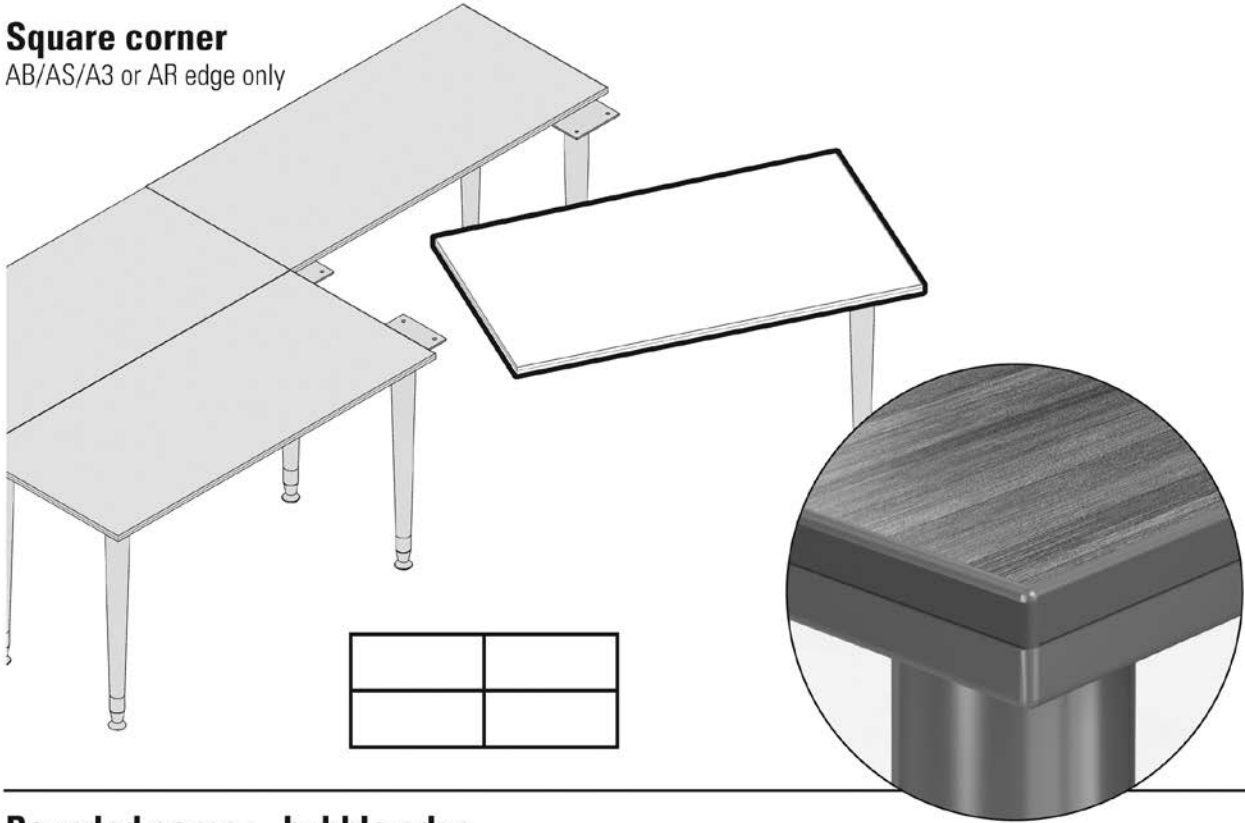
**Rounded corner - bubble edge**

BB/BS edge only

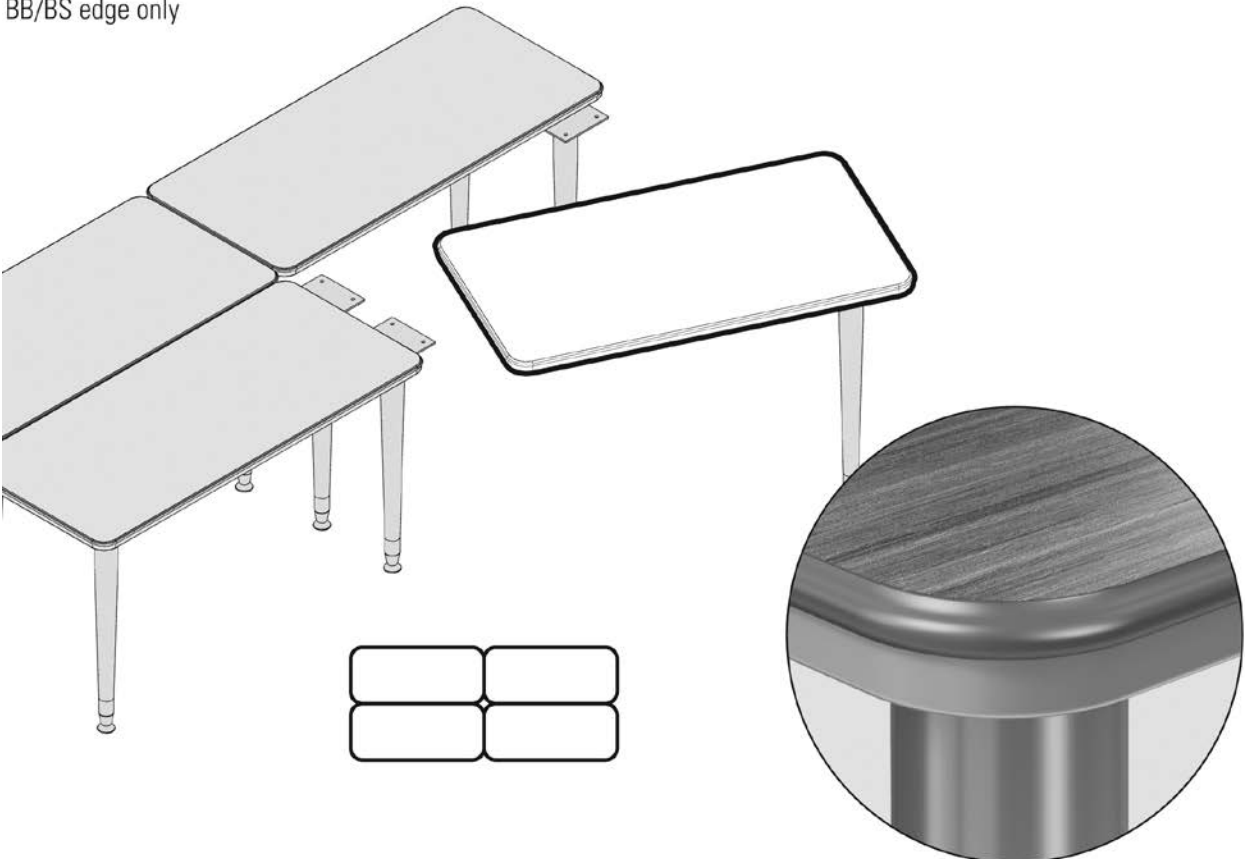

**Tops with Legs and Plates Condition**

**Rectangular Tops**

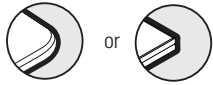
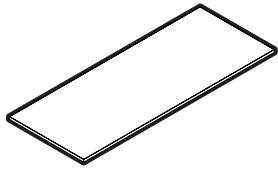

- Legs not included
- Support bar included for units with 60" and 72" width

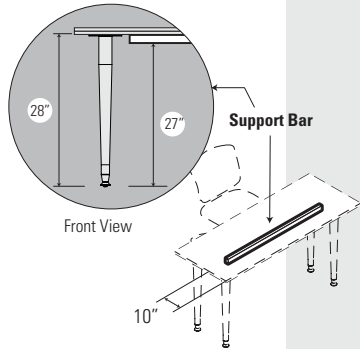

**Tapered Legs**

**Single Straight Running Applications**

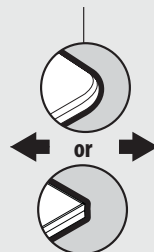
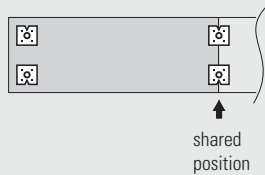

Square or Rounded Corner

**Back-to-Back Applications**

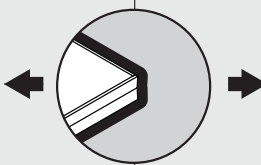
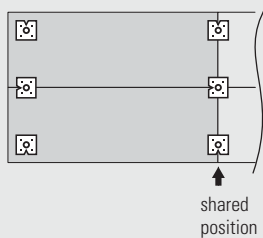

Square Corner

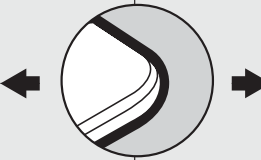
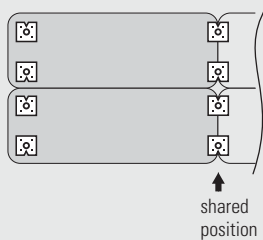

Rounded Corner

**Spider Legs**

**Single Straight Running Applications**

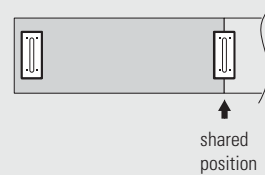

**Back-to-Back Applications**

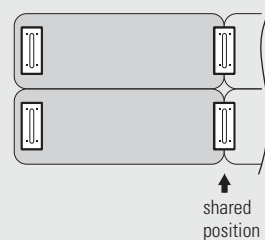
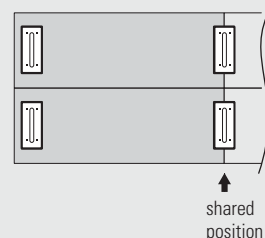

**Rectangular Return Tops**

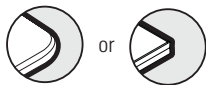
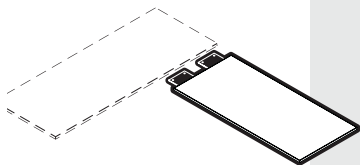

- 2 flat brackets included
- Legs not included
- Maximum width: 54"

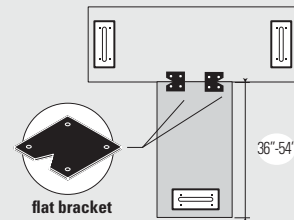
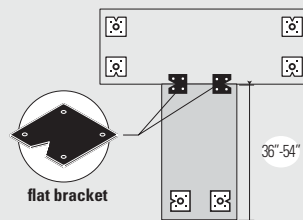
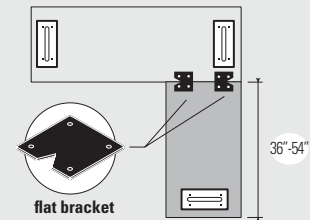
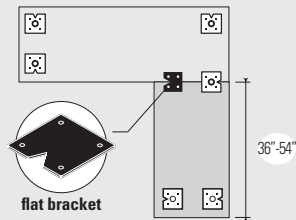

**Legend:**

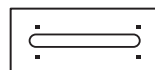

spider leg



tapered leg



flat bracket

**Tops with Legs and Plates Condition**

**Half Moon Tops**

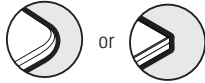
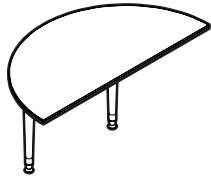

- 2 tapered legs with levelers included
- 1 flat bracket included
- Not available with spider legs
- Does not connect with spider leg tables

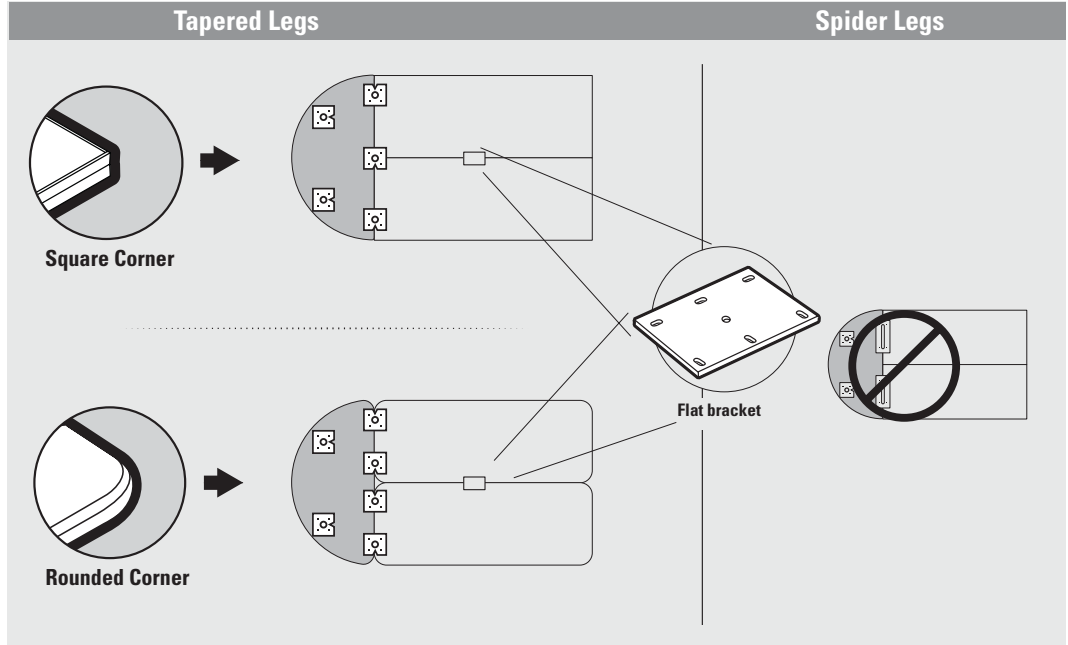

**Keystone Tops**

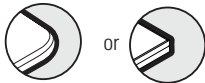
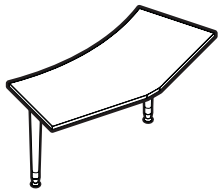

- 2 tapered legs with levelers included
- Not available with spider legs
- Does not connect with spider leg tables

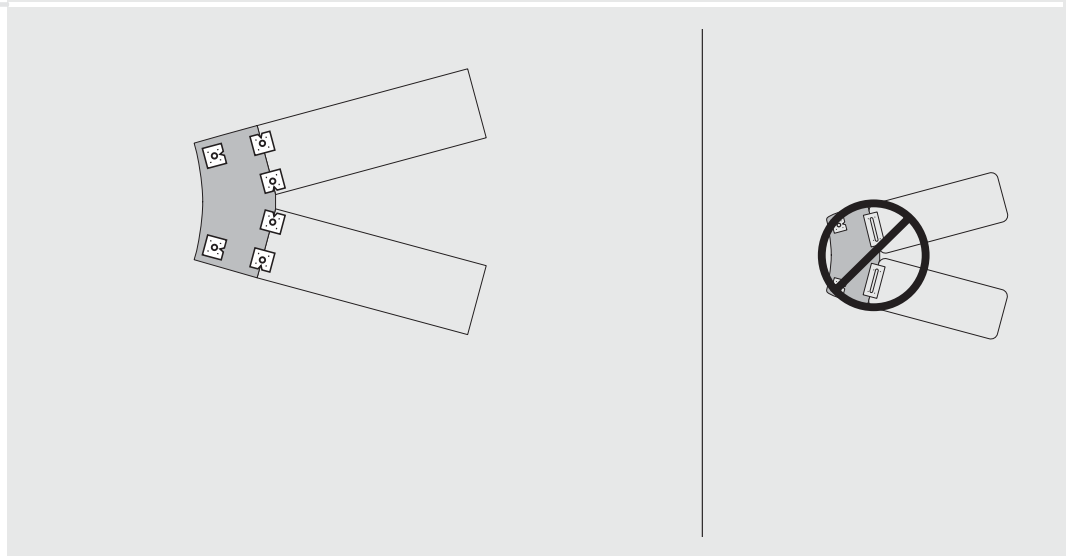

**90° Wedge Tops**

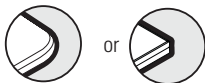

- Legs not included
- Connect to 20" or 24" deep rectangular table

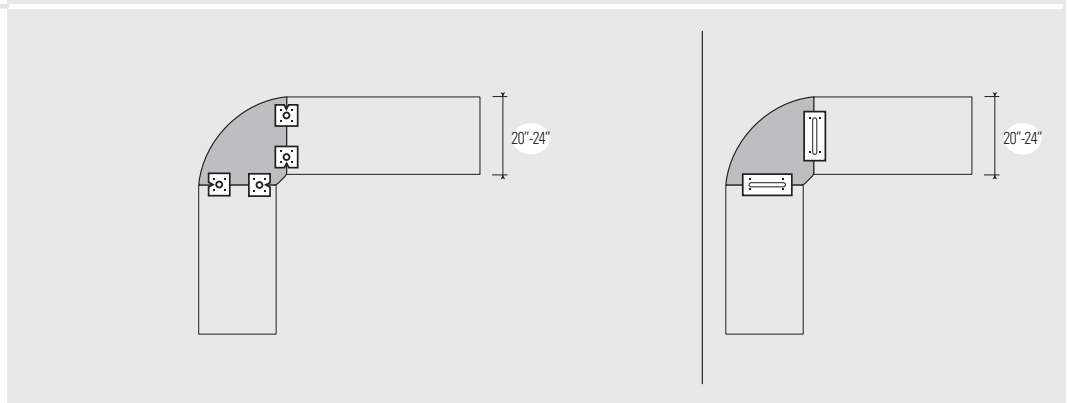

Legend:

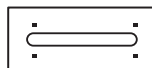

spider leg



tapered leg



plate



## TOPS WITH SQUARE CORNERS

| MODEL # | DIMENSIONS | WT/LB. | CUBIC FT. | LIST PRICE | HP ADD |
|---------|------------|--------|-----------|------------|--------|
|---------|------------|--------|-----------|------------|--------|

W x D x H

|           |             |    |     |              |              |
|-----------|-------------|----|-----|--------------|--------------|
| BS3072REC | 72 x 30 x 1 | 60 | 4   | <b>\$499</b> | <b>\$463</b> |
| BS3060REC | 60 x 30 x 1 | 53 | 3.4 | <b>\$417</b> | <b>\$383</b> |
| BS3048REC | 48 x 30 x 1 | 46 | 2.7 | <b>\$253</b> | <b>\$309</b> |
| BS3042REC | 42 x 30 x 1 | 42 | 2.4 | <b>\$249</b> | <b>\$268</b> |
| BS3036REC | 36 x 30 x 1 | 38 | 2.1 | <b>\$199</b> | <b>\$231</b> |
| BS2472REC | 72 x 24 x 1 | 51 | 3.3 | <b>\$437</b> | <b>\$371</b> |
| BS2460REC | 60 x 24 x 1 | 44 | 2.8 | <b>\$380</b> | <b>\$309</b> |
| BS2448REC | 48 x 24 x 1 | 37 | 2.3 | <b>\$215</b> | <b>\$246</b> |
| BS2442REC | 42 x 24 x 1 | 33 | 2   | <b>\$206</b> | <b>\$215</b> |
| BS2436REC | 36 x 24 x 1 | 29 | 1.8 | <b>\$194</b> | <b>\$185</b> |
| BS2072REC | 72 x 20 x 1 | 43 | 2.9 | <b>\$404</b> | <b>\$309</b> |
| BS2060REC | 60 x 20 x 1 | 37 | 2.4 | <b>\$342</b> | <b>\$257</b> |
| BS2048REC | 48 x 20 x 1 | 30 | 2   | <b>\$202</b> | <b>\$215</b> |
| BS2042REC | 42 x 20 x 1 | 27 | 1.8 | <b>\$186</b> | <b>\$185</b> |
| BS2036REC | 36 x 20 x 1 | 24 | 1.5 | <b>\$173</b> | <b>\$185</b> |

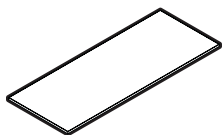

**Rectangular Top - Square Corners**

Rectangular 1" thick worksurface with **square corners**. Can accept tapered (B29TPLEG) or spider legs (B2XSPLEG / B30SPLEG) in "end of run" or shared leg positions. Tops 60" and up include a built-in support bar. Compatible with **power and data management troughs**, see page 391 or standard modesty panels, see page 370. Shipped easy to assemble in 1 carton.

- Do not use as return top.
- Legs sold separately.

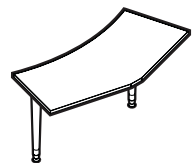

**Keystone Table - Square Corners\***

|         |                     |    |     |              |              |
|---------|---------------------|----|-----|--------------|--------------|
| BS30KSF | 62.75 x 30.5 x 28.7 | 58 | 4   | <b>\$887</b> | <b>\$463</b> |
| BS24KSF | 52 x 28.75 x 28.7   | 50 | 3.7 | <b>\$801</b> | <b>\$339</b> |
| BS20KSF | 44 x 27.75 x 28.7   | 46 | 3   | <b>\$732</b> | <b>\$278</b> |

1" thick worksurface with **square corners**. Includes **two** tapered legs. *Not available with spider legs*. Connects to other tops of 20", 24" or 30" depths. Modesty panels or filler panels are NOT available. Shipped easy to assemble in 2 cartons.

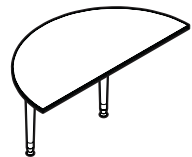

**Half Moon Table - Square Corners\***

|           |                     |    |   |              |              |
|-----------|---------------------|----|---|--------------|--------------|
| BS3060HMF | 59.4 x 29.75 x 28.7 | 57 | 4 | <b>\$837</b> | <b>\$383</b> |
| BS2448HMF | 48.2 x 24 x 28.7    | 45 | 3 | <b>\$785</b> | <b>\$246</b> |

1" thick worksurface with **square corners**. Includes **two** tapered legs. *Not available with spider legs*. Connects to other tables equaling the same length. Modesty panels or filler panels are NOT available. Shipped easy to assemble in 2 cartons.

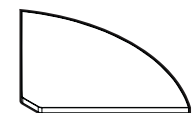

**90° Wedge Top - Square Corners**

|        |                 |    |     |              |              |
|--------|-----------------|----|-----|--------------|--------------|
| BS24WE | 26.8 x 26.8 x 1 | 15 | 1.5 | <b>\$240</b> | <b>\$215</b> |
| BS20WE | 22.8 x 22.8 x 1 | 10 | 1.2 | <b>\$173</b> | <b>\$185</b> |

1" thick worksurface with **square corners**. Can accept tapered (B29TPLEG) or spider legs (B2XSPLEG / B30SPLEG) in shared positions only. Accepts filler modesty panels. Shipped easy to assemble in 1 carton.

- Legs sold separately.

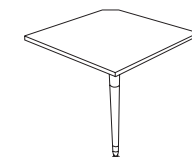

**90° Corner Table - Square Corners\***

|        |                    |    |     |              |              |
|--------|--------------------|----|-----|--------------|--------------|
| BS30CN | 33.2 x 33.2 x 28.7 | 36 | 2.5 | <b>\$542</b> | <b>\$193</b> |
|--------|--------------------|----|-----|--------------|--------------|

Connects to 30" deep rectangular tables. Includes **one** tapered leg. *Not available with spider legs*. Shipped easy to assemble in 1 carton.

### Required specifications

Top finish  
Edge detail  
Leg finish\*

### Optional specifications

HP laminate  
Grommet position or power block cut-out

### Accessories

Power block  
Power/data management troughs  
Modesty panel

**RECTANGULAR RETURN TOPS**      **MODEL #**      **DIMENSIONS**      **WT/LB.**      **CUBIC FT.**      **LIST PRICE**      **HP ADD**

W x D x H

|           |             |    |     |              |              |
|-----------|-------------|----|-----|--------------|--------------|
| BS3054RRE | 54 x 30 x 1 | 50 | 3.1 | <b>\$271</b> | <b>\$347</b> |
| BS3048RRE | 48 x 30 x 1 | 46 | 2.7 | <b>\$253</b> | <b>\$309</b> |
| BS3042RRE | 42 x 30 x 1 | 42 | 2.4 | <b>\$249</b> | <b>\$268</b> |
| BS3036RRE | 36 x 30 x 1 | 38 | 2.1 | <b>\$199</b> | <b>\$231</b> |
| BS2454RRE | 54 x 24 x 1 | 40 | 2.5 | <b>\$233</b> | <b>\$278</b> |
| BS2448RRE | 48 x 24 x 1 | 37 | 2.3 | <b>\$215</b> | <b>\$246</b> |
| BS2442RRE | 42 x 24 x 1 | 33 | 2   | <b>\$206</b> | <b>\$215</b> |
| BS2436RRE | 36 x 24 x 1 | 29 | 1.8 | <b>\$194</b> | <b>\$185</b> |
| BS2054RRE | 54 x 20 x 1 | 33 | 2.2 | <b>\$220</b> | <b>\$231</b> |
| BS2048RRE | 48 x 20 x 1 | 30 | 2   | <b>\$202</b> | <b>\$207</b> |
| BS2042RRE | 42 x 20 x 1 | 27 | 1.8 | <b>\$186</b> | <b>\$185</b> |
| BS2036RRE | 36 x 20 x 1 | 24 | 1.5 | <b>\$173</b> | <b>\$154</b> |

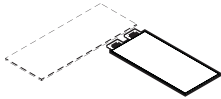

**Rectangular Return Tops - Square Corners\***

Rectangular 1" thick worksurface with **square corners**. Includes two flat brackets to attach to another worksurface on one end. Can accept tapered (B29TPLEG) or spider legs (B2XSPLEG / B30SPLEG) on the other end. 54" tops include a built-in support bar. Compatible with standard modesty panels, see page 370. Shipped easy to assemble in 1 carton.

- For worksurfaces to be used as a main surface, please see rectangular tops.
- Legs sold separately.

**TOPS WITH ROUNDED CORNERS**

|           |             |    |     |              |              |
|-----------|-------------|----|-----|--------------|--------------|
| BB3072REC | 72 x 30 x 1 | 59 | 4   | <b>\$641</b> | <b>\$463</b> |
| BB3060REC | 60 x 30 x 1 | 52 | 3.4 | <b>\$535</b> | <b>\$383</b> |
| BB3048REC | 48 x 30 x 1 | 45 | 2.7 | <b>\$326</b> | <b>\$309</b> |
| BB3042REC | 42 x 30 x 1 | 41 | 2.4 | <b>\$318</b> | <b>\$268</b> |
| BB3036REC | 36 x 30 x 1 | 37 | 2.1 | <b>\$254</b> | <b>\$231</b> |
| BB2472REC | 72 x 24 x 1 | 50 | 3.3 | <b>\$562</b> | <b>\$371</b> |
| BB2460REC | 60 x 24 x 1 | 43 | 2.8 | <b>\$487</b> | <b>\$309</b> |
| BB2448REC | 48 x 24 x 1 | 36 | 2.3 | <b>\$276</b> | <b>\$246</b> |
| BB2442REC | 42 x 24 x 1 | 32 | 2   | <b>\$262</b> | <b>\$215</b> |
| BB2436REC | 36 x 24 x 1 | 28 | 1.8 | <b>\$249</b> | <b>\$185</b> |
| BB2072REC | 72 x 20 x 1 | 42 | 2.9 | <b>\$518</b> | <b>\$309</b> |
| BB2060REC | 60 x 20 x 1 | 36 | 2.4 | <b>\$438</b> | <b>\$257</b> |
| BB2048REC | 48 x 20 x 1 | 29 | 2   | <b>\$260</b> | <b>\$215</b> |
| BB2042REC | 42 x 20 x 1 | 26 | 1.8 | <b>\$239</b> | <b>\$185</b> |
| BB2036REC | 36 x 20 x 1 | 23 | 1.5 | <b>\$223</b> | <b>\$185</b> |



**Rectangular Top - Rounded Corners\***

Rectangular 1" thick worksurface with **rounded corners**. Can accept tapered (B29TPLEG) or spider legs (B2XSPLEG / B30SPLEG) in "end of run" or shared leg positions. Tops 60" and up include a built-in support bar. Compatible with **power and data management troughs**, see page 391 or standard modesty panels, see page 370.

Shipped easy to assemble in 1 carton.

- For worksurfaces to be used as a return, please see return tops.
- Legs sold separately.

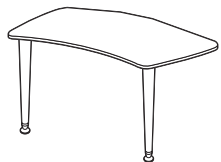

**Keystone Table - Rounded Corners**

|         |                     |    |   |               |              |
|---------|---------------------|----|---|---------------|--------------|
| BB30KSF | 62.75 x 30.5 x 28.7 | 57 | 4 | <b>\$1058</b> | <b>\$463</b> |
| BB24KSF | 52 x 28.75 x 28.7   | 49 | 3 | <b>\$950</b>  | <b>\$339</b> |
| BB20KSF | 44 x 27.75 x 28.7   | 45 | 3 | <b>\$860</b>  | <b>\$278</b> |

1" thick worksurface with **rounded corners**. Includes **two** tapered legs. *Not available with spider legs*. Connects to other tops of 20", 24" or 30" depths. Modesty panels or filler panels are NOT available. Shipped easy to assemble in 2 cartons.

**Required specifications**

Top finish  
Edge detail  
Leg finish (only BBxxKSF)

**Optional specifications**

HP laminate  
Grommet position or power block cut-out\*

**Accessories**

Power block  
Modesty panel\*  
Power/data management troughs\*

# B BUNGEE SL™

## TOPS WITH ROUNDED CORNERS

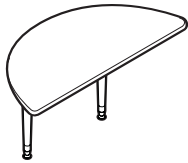

**Half Moon Table - Rounded Corners\***

| MODEL #   | DIMENSIONS<br>W x D x H | WT/LB. | CUBIC FT. | LIST PRICE   | HP ADD       |
|-----------|-------------------------|--------|-----------|--------------|--------------|
| BB3060HMF | 59.4 x 29.75 x 28.7     | 56     | 4         | <b>\$999</b> | <b>\$383</b> |
| BB2448HMF | 48.2 x 24 x 28.7        | 44     | 3.1       | <b>\$930</b> | <b>\$246</b> |

1" thick worksurface with **rounded corners**. Includes **two** tapered legs. *Not available with spider legs*. Connects to other tables equaling the same length. Modesty panels or filler panels are NOT available. Shipped easy to assemble in 2 cartons.



**90° Wedge Top - Rounded Corners**

|        |                 |    |     |              |              |
|--------|-----------------|----|-----|--------------|--------------|
| BB24WE | 26.8 x 26.8 x 1 | 14 | 1.5 | <b>\$308</b> | <b>\$215</b> |
| BB20WE | 22.8 x 22.8 x 1 | 9  | 1.2 | <b>\$223</b> | <b>\$185</b> |

1" thick worksurface with **rounded corners**. Can accept tapered (B29TPLEG) or spider legs (B2XSPLLEG / B30SPLEG) in shared positions only. Accepts filler modesty panels. Shipped easy to assemble in 1 carton.

- Legs sold separately.

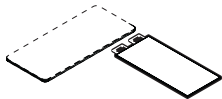

**Rectangular Return Tops - Rounded Corners**

|           |             |    |     |              |              |
|-----------|-------------|----|-----|--------------|--------------|
| BB3054RRE | 54 x 30 x 1 | 50 | 3.1 | <b>\$349</b> | <b>\$347</b> |
| BB3048RRE | 48 x 30 x 1 | 46 | 2.7 | <b>\$326</b> | <b>\$309</b> |
| BB3042RRE | 42 x 30 x 1 | 42 | 2.4 | <b>\$318</b> | <b>\$268</b> |
| BB3036RRE | 36 x 30 x 1 | 38 | 2.1 | <b>\$254</b> | <b>\$231</b> |
| BB2454RRE | 54 x 24 x 1 | 40 | 2.5 | <b>\$299</b> | <b>\$278</b> |
| BB2448RRE | 48 x 24 x 1 | 37 | 2.3 | <b>\$276</b> | <b>\$246</b> |
| BB2442RRE | 42 x 24 x 1 | 33 | 2   | <b>\$262</b> | <b>\$215</b> |
| BB2436RRE | 36 x 24 x 1 | 29 | 1.8 | <b>\$249</b> | <b>\$185</b> |
| BB2054RRE | 54 x 20 x 1 | 33 | 2.2 | <b>\$286</b> | <b>\$231</b> |
| BB2048RRE | 48 x 20 x 1 | 30 | 2   | <b>\$260</b> | <b>\$207</b> |
| BB2042RRE | 42 x 20 x 1 | 27 | 1.8 | <b>\$239</b> | <b>\$185</b> |
| BB2036RRE | 36 x 20 x 1 | 24 | 1.5 | <b>\$223</b> | <b>\$154</b> |

Rectangular 1" thick worksurface with **rounded corners**. Includes two flat brackets to attach to another worksurface on one end. Can accept tapered (B29TPLEG) or spider legs (B2XSPLLEG / B30SPLEG) on the other end. 54" tops include a built-in support bar. Compatible with standard modesty panels, see page 370. Shipped easy to assemble in 1 carton.

- For worksurfaces to be used as a main surface, please see rectangular tops.
- Legs sold separately.

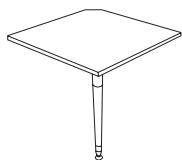

**90° Corner Table - Rounded Corners\***

|        |                      |    |     |              |              |
|--------|----------------------|----|-----|--------------|--------------|
| BB30CN | 33.17 x 33.17 x 28.7 | 36 | 2.5 | <b>\$578</b> | <b>\$193</b> |
|--------|----------------------|----|-----|--------------|--------------|

Connects to 30" deep rectangular tables. Includes **one** tapered leg. *Not available with spider legs*. Shipped easy to assemble in 1 carton.

### Required specifications



Top finish  
Edge detail  
Leg finish\*

### Optional specifications

Grommet  
HP laminate

### Accessories

Power block (rectangular return tops)  
Modesty panel (rectangular return tops)

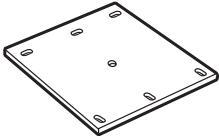
| LEGS  | MODEL #  | DIMENSIONS<br>W x D x H | WT/LB. | CUBIC FT. | LIST PRICE   | HP ADD |
|---|----------|-------------------------|--------|-----------|--------------|--------|
|  <p><b>Spider Legs for 30" D Tables</b></p>  | B30SPLEG | 6 x 25 x 27.7           | 16     | 2.9       | <b>\$349</b> | N/A    |
| <p>Spider leg with levelers. Shipped 1 per carton. <b>Tops sold separately.</b></p> <ul style="list-style-type: none"> <li>• Available in Black (<b>TBL</b>) or Tungsten (<b>TTU</b>), please specify.</li> <li>• <b>To be used with 30" deep tops only.</b></li> </ul>           |          |                         |        |           |              |        |
|  <p><b>Spider Legs for 20" &amp; 24" D Tables</b></p>  | B2XSPLEG | 6 x 20 x 27.7           | 14     | 2.2       | <b>\$299</b> | N/A    |
| <p>Spider leg with levelers. Shipped 1 per carton. <b>Tops sold separately.</b></p> <ul style="list-style-type: none"> <li>• Available in Black (<b>TBL</b>) or Tungsten (<b>TTU</b>), please specify.</li> <li>• <b>To be used with 24" &amp; 24" deep tops only.</b></li> </ul> |          |                         |        |           |              |        |
|  <p><b>Tapered Leg</b></p>   | B29TPLEG | 6 x 6 x 27.7            | 11     | 0.75      | <b>\$139</b> | N/A    |
| <p>Tapered leg with levelers for tables of all depths. Shipped 1 per carton. <b>Tops sold separately.</b></p> <ul style="list-style-type: none"> <li>• Available in Black (<b>TBL</b>) or Tungsten (<b>TTU</b>), please specify.</li> </ul>                                       |          |                         |        |           |              |        |
|  <p><b>Flat Bracket</b></p>  | B6PLT    | 6 x 6 x 0.25            | 2      | 0.1       | <b>\$45</b>  | N/A    |
| <p>To be used as a mending plate for Bungee SL. Black only. Shipped/sold 1 per pack. There are no specifications for Flat Bracket.</p>  |          |                         |        |           |              |        |

**Required specifications**  
Leg finish

# B BUNGEE SL™ POWER/DATA MANAGEMENT TROUGHS - NOTES

## GENERAL INFORMATION

- Power and data management troughs for the Bungee SL table series. Add Global's proprietary 4-wire power kits and create cost effective and versatile training, benching, academic and meeting areas.
- Front panels are available in laminate. A center spine version allows for inexpensive double-sided applications.
- **POWER AND DATA MANAGEMENT TROUGHS** are sold separately and are meant to be used on **Bungee SL only**.
- **POWER AND DATA MANAGEMENT TROUGHS** accept Global's 4-wire power kit in addition to numerous data, phone and other multimedia wires.
- Filler modesty panels conceal wiring in spaces not covered by troughs.
- For environmental certifications, please visit [globalfurnituregroup.com](http://globalfurnituregroup.com).

## FINISHES

### Laminate:

|                            |                               |
|----------------------------|-------------------------------|
| <b>ACJ</b> Absolute Acajou | <b>FCL</b> First Class        |
| <b>ASN</b> Asian Night     | <b>NBL</b> Noce Biondo        |
| <b>AWC</b> Avant Cherry    | <b>NGL</b> Noce Grigio        |
| <b>AWH</b> Avant Honey     | <b>NEL</b> Noce Leggero       |
| <b>BLK</b> Black           | <b>NML</b> Noce Medio         |
| <b>BZD</b> Blizzard        | <b>QTM</b> Quartered Mahogany |
| <b>BRC</b> Brushed Cobalt  | <b>SBY</b> Sheer Beauty       |
| <b>CMB</b> Clear Maple     | <b>SDT</b> Stonedust          |
| <b>CGY</b> Custom Grey     | <b>SOG</b> Storm Grey         |
| <b>DES</b> Dark Espresso   | <b>WHE</b> Walnut Heights     |
| <b>DWT</b> Designer White  | <b>WHC</b> White Chocolate    |
| <b>FAS</b> Fashionista     | <b>WCR</b> Winter Cherry      |

### Aluminum Trough, Filler Panels and End Caps:

Black (**BLK**)      Tungsten (**TUN**)

### LAMINATE FACE PANEL (LFP)

- Laminate face panel (LFP) on the approach side is 1/16" thick. LFP height is 13".
- Rear access panel is 0.25" thick laminate. Rear panel height is 7.25".
- LFP and rear panel swing up to allow wire access and feature a flexible sweep at the top.
- All laminate components are made of 45 lb. commercial density particle board, covered on both sides with high performance, thermally fused laminate.
- The trough portion of the unit is made of a heavy duty aluminum extrusion to allow wire systems (including Global's 4-Wire System) to lie within the bottom.
- LFP is available in all standard laminates, aluminum trough available in Black (**BLK**) or Tungsten (**TUN**) finish, please specify (rear access panel is finished in Brushed Cobalt (**BRC**) laminate when TUN is specified, or Black (**BLK**) laminate when BLK is specified).
- End caps (JBEC) sold separately.

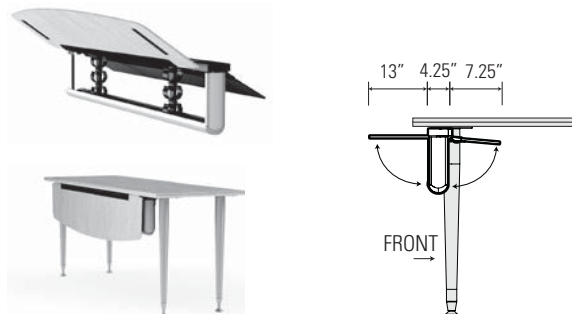

Tops, legs and end caps not included.

### CENTER SPINE (CS)

- 0.25" thick laminate panels on both sides of the unit. Panel height is 7.25".
- Both panels swing up to allow wire access and feature a flexible sweep at the top.
- All laminate components are made of 45 lb. commercial density particle board, covered on both sides with high performance, thermally fused laminate.
- The trough portion of the unit is made of a heavy duty aluminum extrusion to allow wire systems (like Global's 4-Wire System) to lie within the bottom.
- Aluminum trough available in Black (**BLK**) or Tungsten (**TUN**) finish, please specify (rear access panel is finished in Brushed Cobalt (**BRC**) laminate when TUN is specified, or both access panels are finished in Black (**BLK**) laminate when BLK is specified).
- End caps (JBEC) sold separately.



Tops, legs and end caps not included.

### FILLER MODESTY PANELS

- Used to fill the space between two power and data management troughs and conceal wiring from the approach side.
- Straight filler allows for use in straight configurations between two rectangular tables with power and data management troughs.
- Curved filler allows for use at curve with 90° wedge tables between two rectangular tables with power and data management troughs.
- Available in Silver (**SI**) or Black (**BK**) finish, please specify.

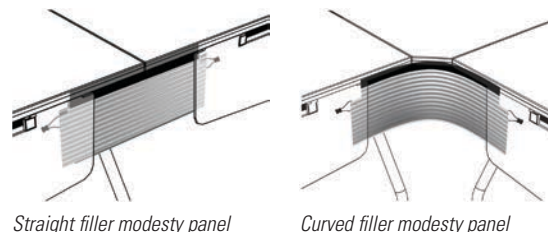

Straight filler modesty panel

Curved filler modesty panel

## END CAPS

- Plastic end caps with decorative insert. Required for beginning and end of runs.
- Cap can be notched in field to allow wire infeed pass-through.
- Available in Black (**BLK**) or Tungsten (**TUN**) finish, please specify.



## WIRE MANAGEMENT

- Two wire manager clamps are included within all power and data management troughs.
- Attached to the unit, they can slide from side-to-side to accommodate wiring systems.
- Data, voice, multimedia and power can be routed separately using channels on each wire manager.
- Additional wire manager clamps are available to retrofit.
- Available in Black only.



## POWER SNAKE

- Attaches to underside of worksurface to organize and manage wires from the power trough to the floor in-feed.
- Black finish only.

## GLOBAL 4-WIRE POWER SYSTEM

- Global's proprietary power system comes with everything you need to power your **Bungee SL** layouts. Kits coordinate to the size of the table being used and fit snugly into the bottom of the power and data management trough.
- Single duplex kits come with one duplex - centered on the wiring harness. Duplexes are 6" wide.
- Double duplex kits come with two duplexes - 11" of wiring on each side of the harness allows for flexibility between connections. Duplexes are 6" wide.
- One end of the harness kit features a female connection, while the opposite end features a male connection for a quick and easy connect/disconnect.
- Actual kit length is 1" longer than nominal.
- Must be hardwired using infeeds (specified separately) by a licensed electrician.
- All conduits are enclosed in a Black nylon sleeve to reduce visibility.
- All duplexes and connectors are plastic. Black only.
- **8 DUPLEXES PER CIRCUIT MAXIMUM** - maximums are to national electric code (NEC) - some local codes vary from NEC code - it is the customer's responsibility to follow all applicable local codes and guidelines.

## ELECTRICAL SYSTEM

4-2 Wiring Schematic

4-Wire Shared Neutral

Complies with National Electric Code

UL Listed

All circuits rated for 20 AMP

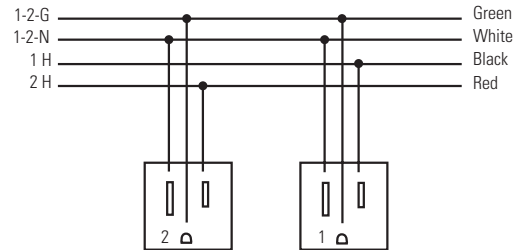

| PRODUCT | MAX UNITS PER CIRCUIT |
|---------|-----------------------|
| P42S    | 8 units per circuit   |
| P42D    | 4 units per circuit   |

# B BUNGEE SL™ POWER/DATA MANAGEMENT TROUGHS - NOTES

## POWER/DATA MANAGEMENT TROUGH PLACEMENT

### Single Table - AFP or LFP

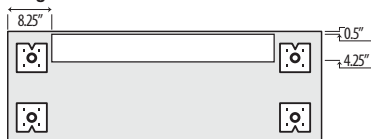

### Shared Leg Tables - AFP or LFP

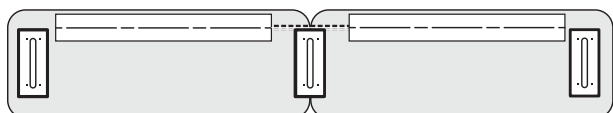
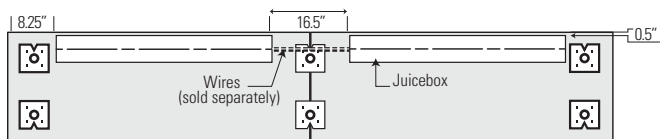

CS

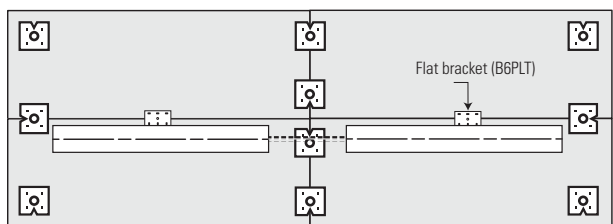

CS

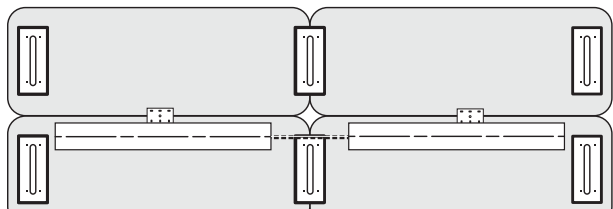

## GLOBAL 4-WIRE POWER TO POWER/DATA MANAGEMENT TROUGH:

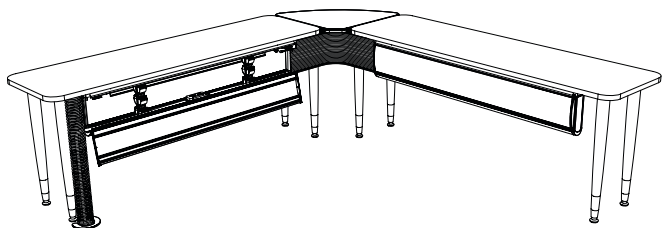

Bungee SL with AFP Power/Data Management Trough - 90° Corner Application

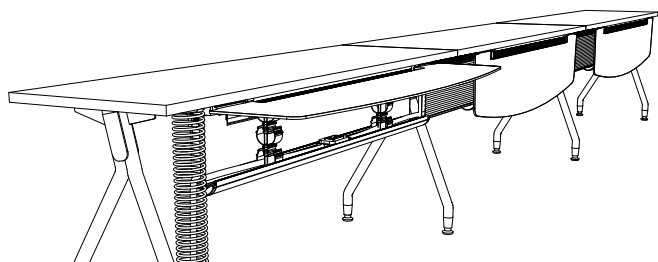

Bungee SL with LFP Power/Data Management Trough - Single Sided Straight Run  
(available in Black finish only)



Bungee SL with CS Power/Data Management Trough - Back to Back Application  
(shown with power snake)

## UTILIZING POWER BLOCKS AND GROMMETS WITH POWER/DATA MANAGEMENT TROUGH

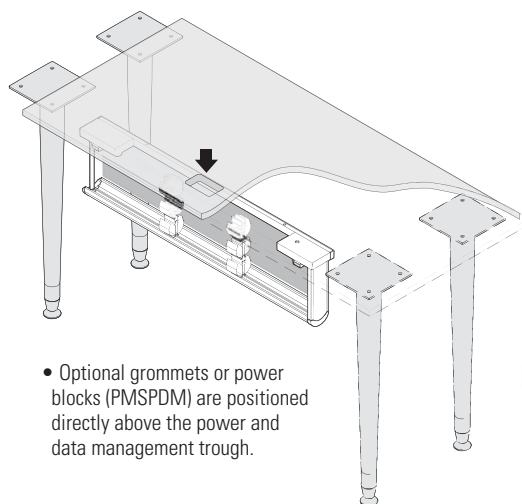

Grommet



Power block

- Optional grommets or power blocks (PMSPDM) are positioned directly above the power and data management trough.

| TROUGHS | MODEL # | DIMENSIONS | WT/LB. | CUBIC FT. | LIST PRICE |
|---------|---------|------------|--------|-----------|------------|
|---------|---------|------------|--------|-----------|------------|



**Trough w/Laminate Face Panel (LFP)**

|       | W x D x H         |    |     |              |  |
|-------|-------------------|----|-----|--------------|--|
| JB72L | 55.75 x 4.33 x 13 | 23 | 2.9 | <b>\$710</b> |  |
| JB60L | 43.75 x 4.33 x 13 | 18 | 2.3 | <b>\$635</b> |  |
| JB48L | 31.75 x 4.33 x 13 | 14 | 1.7 | <b>\$550</b> |  |
| JB42L | 25.75 x 4.33 x 13 | 12 | 1.5 | <b>\$510</b> |  |
| JB36L | 19.75 x 4.33 x 13 | 10 | 1.2 | <b>\$467</b> |  |

For use on rectangular Bungee SL surfaces only. Out-facing laminate panel swings up to allow wire access and features flexible sweep at the top. In-facing laminate panel swings up to allow wire access and features flexible sweep at the top. **Black finish only.** Black wire management clamps included.

- To fill the gap between two power/data management trough (LFP) modules in a straight run, a single filler modesty panel (JBSFM) is recommended.
- To fill the gap between two power/data management trough (LFP) modules at 90°, a corner filler modesty panel (JBCFM) is recommended.
- Model # corresponds to the size of table the power/data management trough will fit on (i.e. JB72L will fit a 72" wide table).



**Trough w/Center Spine (CS)**

|       |                   |    |     |              |  |
|-------|-------------------|----|-----|--------------|--|
| JB72C | 55.75 x 4.33 x 10 | 19 | 2.2 | <b>\$640</b> |  |
| JB60C | 43.75 x 4.33 x 10 | 15 | 1.8 | <b>\$601</b> |  |
| JB48C | 31.75 x 4.33 x 10 | 12 | 1.3 | <b>\$510</b> |  |
| JB42C | 25.75 x 4.33 x 10 | 10 | 1.1 | <b>\$473</b> |  |
| JB36C | 19.75 x 4.33 x 10 | 8  | 0.8 | <b>\$439</b> |  |

For use on rectangular Bungee SL surfaces only in back-to-back applications only. Two laminate panels swing up to allow wire access and feature flexible sweep at the top. Black wire management clamps included.





- To fill the gap between two power/data management trough (CS) modules in a straight run, two filler modesty panels (JBSFM) are recommended to conceal wiring from both sides.
- Model # corresponds to the size of table the power/data management trough will fit on (i.e. JB72C will fit a 72" wide table).

**Required specifications**  
 Aluminum face panel finish (AFP)  
 Power/data trough finish  
 Trough finish, laminate face panel (LFP)

**Accessories**  
 4-wire power system  
 End cap  
 Power snake

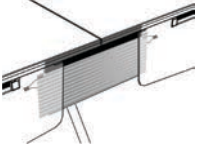

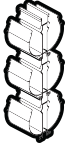
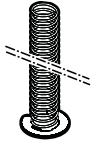
## B BUNGEE SL™ POWER/DATA MANAGEMENT TROUGHS

| ACCESSORIES  | MODEL # | DIMENSIONS<br>W x D x H | WT/LB. | CUBIC FT. | LIST PRICE   |
|--|---------|-------------------------|--------|-----------|--------------|
|  <p><b>Straight Filler Modesty Panel</b></p> | JBSFM   | 22.5 x 0.25 x 9         | 1.6    | 0.4       | <b>\$153</b> |
|  <p><b>Curved Filler Modesty Panel</b></p>   | JBCFM   | 28.5 x 0.25 x 9         | 1.8    | 0.5       | <b>\$183</b> |
|  <p><b>End Cap</b></p>                      | JBEC    | 8 x 3 x 1               | 1      | 0.15      | <b>\$35</b>  |
|  <p><b>Wire Management Clamp</b></p>       | JBWM2   | 8.5 x 3 x 2             | 1      | 0.1       | <b>\$138</b> |
|  <p><b>Power Snake</b></p>                | JBPS    | 4 x 4 x 34              | 2      | 0.25      | <b>\$151</b> |
|  <p><b>Cable Terminator Mount</b></p>     | JBCTM   | 7 x 6.5 x -             | 1      | 0.1       | <b>\$69</b>  |

Straight filler modesty is used to fill the space between two power/data management trough modules where tables are linked in a straight configuration.

- In center spine applications, two straight filler modesty panels should be specified to cover cabling and wires from both sides.

Curved filler modesty is used to fill the space between two power/data management troughs where tables are linked at a 90° curve.

- *For interior curves only.*

Plastic end cap to be snapped into place at the end of power/data management troughs. To be specified for the beginning and end of runs for a finished look. Charcoal finish only.

- Plastic cap can be notched in the field to allow infeed or data cable pass-through.

Wire management track with double wire clamp - triple height. Can be affixed to the underside of worksurface using double-sided tape (supplied) or retrofit into power/data management trough modules. Black finish only.

- Recommended for use at 90° corners.
- Retrofitting requires disassembly of power/data management trough modules.

Attaches to the underside of worksurface with supplied wood screws. Used to organize and channel wires from the power/data management trough down to the floor infeed. Black finish only.

Secures terminated data or telephone cables. Attaches with two screws to aluminum trough, inside power trough. Designed to hold multiple data solutions. Inserts not included. Black finish only.

## 4-WIRE POWER SYSTEM

MODEL #      DIMENSIONS      WT/LB.      CUBIC FT.      LIST PRICE

W x D x H

### Circuit 1

|           |            |     |      |              |
|-----------|------------|-----|------|--------------|
| PP42SO721 | 72 x - x - | 3.2 | 0.1  | <b>\$167</b> |
| PP42SO661 | 66 x - x - | 3   | 0.09 | <b>\$160</b> |
| PP42SO601 | 60 x - x - | 2.8 | 0.09 | <b>\$154</b> |
| PP42SO541 | 54 x - x - | 2.6 | 0.08 | <b>\$148</b> |
| PP42SO481 | 48 x - x - | 2.4 | 0.08 | <b>\$141</b> |
| PP42SO421 | 42 x - x - | 2.3 | 0.07 | <b>\$133</b> |
| PP42SO361 | 36 x - x - | 2.1 | 0.06 | <b>\$127</b> |
| PP42SO301 | 30 x - x - | 1.9 | 0.06 | <b>\$120</b> |
| PP42SO241 | 24 x - x - | 1.7 | 0.05 | <b>\$110</b> |

### Circuit 2

|           |            |     |      |              |
|-----------|------------|-----|------|--------------|
| PP42SO722 | 72 x - x - | 3.2 | 0.1  | <b>\$167</b> |
| PP42SO662 | 66 x - x - | 3   | 0.09 | <b>\$160</b> |
| PP42SO602 | 60 x - x - | 2.8 | 0.09 | <b>\$154</b> |
| PP42SO542 | 54 x - x - | 2.6 | 0.08 | <b>\$148</b> |
| PP42SO482 | 48 x - x - | 2.4 | 0.08 | <b>\$141</b> |
| PP42SO422 | 42 x - x - | 2.3 | 0.07 | <b>\$133</b> |
| PP42SO362 | 36 x - x - | 2.1 | 0.06 | <b>\$127</b> |
| PP42SO302 | 30 x - x - | 1.9 | 0.06 | <b>\$120</b> |
| PP42SO242 | 24 x - x - | 1.7 | 0.05 | <b>\$110</b> |

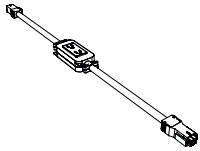

**Single Duplex Kit**

Single duplex kit includes one Black plastic duplex connected to harnesses. Male connection (IN) on one side with female connection (OUT) on the opposite for easy connect and disconnect. Conduit is wrapped in Black nylon sleeve. Actual length is 1" longer than nominal.

- Please specify Circuit 1 or Circuit 2.
- Model # corresponds to the size of table the power/data management trough will fit on (i.e. PP42SO481 will fit a JB48A, JB48L or JB48C module).
- Infeed required for connection to building power. Sold separately, see page 394.

### Circuit 1

|           |            |     |      |              |
|-----------|------------|-----|------|--------------|
| PP42DO721 | 72 x - x - | 3   | 0.1  | <b>\$193</b> |
| PP42DO661 | 66 x - x - | 2.8 | 0.09 | <b>\$187</b> |
| PP42DO601 | 60 x - x - | 2.6 | 0.09 | <b>\$180</b> |
| PP42DO541 | 54 x - x - | 2.4 | 0.08 | <b>\$173</b> |
| PP42DO481 | 48 x - x - | 2.3 | 0.08 | <b>\$166</b> |
| PP42DO421 | 42 x - x - | 2.1 | 0.07 | <b>\$158</b> |
| PP42DO361 | 36 x - x - | 1.9 | 0.06 | <b>\$153</b> |

### Circuit 2

|           |            |     |      |              |
|-----------|------------|-----|------|--------------|
| PP42DO722 | 72 x - x - | 3   | 0.1  | <b>\$193</b> |
| PP42DO662 | 66 x - x - | 2.8 | 0.09 | <b>\$187</b> |
| PP42DO602 | 60 x - x - | 2.6 | 0.09 | <b>\$180</b> |
| PP42DO542 | 54 x - x - | 2.4 | 0.08 | <b>\$173</b> |
| PP42DO482 | 48 x - x - | 2.3 | 0.08 | <b>\$166</b> |
| PP42DO422 | 42 x - x - | 2.1 | 0.07 | <b>\$158</b> |
| PP42DO362 | 36 x - x - | 1.9 | 0.06 | <b>\$153</b> |

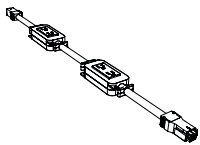

**Double Duplex Kit**

Double duplex kit includes two Black plastic duplexes connected to harnesses. Male connection (IN) on one side with female connection (OUT) on the opposite for easy connect and disconnect. Conduit is wrapped in Black nylon sleeve. Actual length is 1" longer than nominal.

- Please specify Circuit 1 or Circuit 2. Both duplexes on the kit will be assigned to the same circuit.
- Model # corresponds to the size of table the power/data management trough will fit on (i.e. PP42DO481 will fit a JB48A, JB48L or JB48C module).
- Infeed required for connection to building power. Sold separately, see page 394.

## B BUNGEE SL™ POWER/DATA MANAGEMENT TROUGHS

### 4-WIRE POWER SYSTEM



#### Power Harness Jumper

| MODEL # | DIMENSIONS | WT/LB. | CUBIC FT. | LIST PRICE   |
|---------|------------|--------|-----------|--------------|
|         | W x D x H  |        |           |              |
| PP42J72 | 73 x - x - | 3      | 0.1       | <b>\$146</b> |
| PP42J66 | 67 x - x - | 2.91   | 0.09      | <b>\$141</b> |
| PP42J60 | 61 x - x - | 2.73   | 0.09      | <b>\$137</b> |
| PP42J54 | 55 x - x - | 2.54   | 0.08      | <b>\$132</b> |
| PP42J48 | 49 x - x - | 2.35   | 0.08      | <b>\$127</b> |
| PP42J42 | 43 x - x - | 2.16   | 0.07      | <b>\$122</b> |
| PP42J36 | 37 x - x - | 1.98   | 0.06      | <b>\$117</b> |
| PP42J30 | 31 x - x - | 1.79   | 0.06      | <b>\$113</b> |
| PP42J24 | 25 x - x - | 1.6    | 0.05      | <b>\$109</b> |
| PP42J18 | 19 x - x - | 1.41   | 0.04      | <b>\$102</b> |

Male connection (IN) on one side with female connection (OUT) on the opposite for easy connect and disconnect. Conduit is wrapped in Black nylon sleeve. Actual length is 1" longer than nominal.

- Use PP42J18 between two power/data management troughs separated by Bungee SL wedge, keystone or half moon tables
- Use all other sizes to jump between power kits on power/data management troughs that are NOT powered (i.e. use a PP42J60 as a pass-through on a 60" wide non-powered table between POWERED power/data management trough modules.

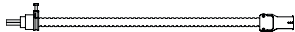

#### 72" Multi-Circuit Hardwire Infeed

|          |            |     |     |              |
|----------|------------|-----|-----|--------------|
| PP42HW72 | 72 x - x - | 6.5 | 0.3 | <b>\$165</b> |
|----------|------------|-----|-----|--------------|

72" multi-circuit hardwire infeed (up to 20 AMPS per circuit), two circuits. Provides single power entry from floor or wall located building power supply. Conduit is wrapped in Black nylon sleeve.

- Connects P42S or P42D kits.
- **TO BE HARDWIRED BY LICENSED ELECTRICIAN.** UL listed.
- Where liquid tight conduit is required, specify P42HW-72L.

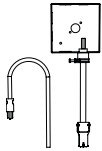

#### Single-Circuit 3-Prong Infeed

|           |           |     |      |              |
|-----------|-----------|-----|------|--------------|
| PP42TP120 | 4 x 8 x 2 | 6.1 | 0.3  | <b>\$173</b> |
| PP42TP72  | 4 x 8 x 4 | 4.5 | 0.15 | <b>\$155</b> |

Hardwire junction box included (to be mounted on underside of table). Provides single power entry from floor or wall located building power supply. Conduit is wrapped in Black nylon sleeve. Allows for quick and easy disconnection from the wall. Available in 72" or 120" overall lengths.

- Connects P42S or P42D kits. **Power Circuit 1 only.**
- **TO BE HARDWIRED BY LICENSED ELECTRICIAN.** UL listed.

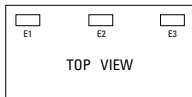
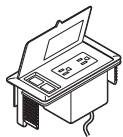

#### Power/Data Block

|         |                  |   |     |              |
|---------|------------------|---|-----|--------------|
| PMSPPDM | 6.5 x 3.5 x 2.75 | 2 | 0.1 | <b>\$268</b> |
|---------|------------------|---|-----|--------------|

Worksurface power and data module. Two power receptacles and two data receptacles. 9' Black cord. Specify position and **Add \$91** for cut-out in worksurface. See page 394 for required locations. Black only.



ConnecTABLES provides solutions for a variety of day-to-day work environments. Designed as easy-to-use linking or freestanding tables, ConnecTABLES is limited only by your imagination.

**Open Conference**

Many ConnecTABLES tops can be assembled to be freestanding. When combined with locking casters and the flip-top T-leg, the result is easy storage and complete portability.

**Meeting Rooms**

ConnecTABLES modular units provide quick and affordable answers for all sizes and shapes of rooms and applications.

**Educational and Training Rooms**

ConnecTABLES table tops configure easily into temporary or permanent educational applications.



T-leg with leveling glides.



Modesty panel.

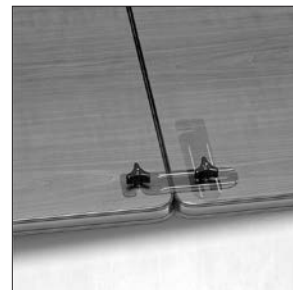

Optional ganging connector.

**Features and Benefits**

- Optional, easy-to-use thumbscrews allow installation without tools.
- Optional zinc-plated steel ganging hardware connects freestanding tops without moving T-leg position.
- Optional modesty panel wire management unit available.
- Casters will not affect table height when used in conjunction with or in place of glides.
- Optional Black grommets for convenient wire management can be ordered "factory installed".
- Tops are 1" thick and constructed of 45 lb. density particle board.
- Optional casters available with or without manual locks provide mobility.
- ConnecTABLES tops are available in all Global laminate finishes with three leg and two edge color options.

## GENERAL INFORMATION

- ConnecTABLES is an affordable and highly flexible system of modular tables. Designed as easy-to-use linking or freestanding tables, ConnecTABLES adapts to every requirement: seminar or training room, meeting room, personal workstations, educational, conferencing and team cluster workgroups.
- ConnecTABLES have eight basic top shapes available in various sizes.
- ConnecTABLES edges **do not match** any other Global product in either color or style.
- For environmental certifications, please visit [globalfurnituregroup.com](http://globalfurnituregroup.com).

## WORKSURFACES

- Tops are 1" thick, made of 45 lb. density particle board covered on both sides with high performance thermally fused laminate.
- Laminate finishes are available in high pressure. Contact your Customer Service representative for a quote.
- If other than a Global standard laminate finish is preferred, contact your Customer Service representative. Information needed includes the name of the laminate manufacturer, color name, number and model of table. You will then be given a quote for this special order.
- **ConnecTABLES edges do not match any other Global product in either color or style.**

## CONSTRUCTION

- Some components can stand-alone when the "T" base is set in the freestanding position. When the "T" base is in the linking position, all the components can be used in grouping configurations (clusters).
- Optional wire grommets not available on 45° wedge and the 60° triangle.
- Rectangular tops 54" in length and longer are supplied with a 16" gauge steel support channel. Top is predrilled for placement.
- Shipped easy to assemble.
- Special width tops are available. Use next size up.
- Adjustable levelers offer up to 1" adjustability.
- Elliptical column cover, glides, casters, thumbscrews and endcaps available in Black only.
- MUST specify top, edge, and "T" base color with each order.

## LEGS

- T-leg is coated with environmentally friendly, recyclable paint electrostatically applied epoxy powder coating for a very durable finish in three colors as specified below. Only the bottom horizontal portion of the painted leg is visible.
- Black plastic leveling glides offer 1" adjustability.
- Two Black plastic elliptical column caps cover each leg column.
- Casters will not affect table height when used in conjunction with or in place of glides.
- Casters can facilitate mobility in installations which need to be moved frequently.
- Legs when used with casters have no adjustability for leveling.

## LAMINATE FINISHES

|                            |                               |
|----------------------------|-------------------------------|
| <b>ACJ</b> Absolute Acajou | <b>FCL</b> First Class        |
| <b>ASN</b> Asian Night     | <b>NBL</b> Noce Biondo        |
| <b>AWC</b> Avant Cherry    | <b>NGL</b> Noce Grigio        |
| <b>AWH</b> Avant Honey     | <b>NEL</b> Noce Leggero       |
| <b>BLK</b> Black           | <b>NML</b> Noce Medio         |
| <b>BZD</b> Blizzard        | <b>QTM</b> Quartered Mahogany |
| <b>BRC</b> Brushed Cobalt  | <b>SBY</b> Sheer Beauty       |
| <b>CMB</b> Clear Maple     | <b>SDT</b> Stonedust          |
| <b>CGY</b> Custom Grey     | <b>SOG</b> Storm Grey         |
| <b>DES</b> Dark Espresso   | <b>WHE</b> Walnut Heights     |
| <b>DWT</b> Designer White  | <b>WHC</b> White Chocolate    |
| <b>FAS</b> Fashionista     | <b>WCR</b> Winter Cherry      |

## EDGE COLORS

Black (BLK)

## LEG COLORS

Black (TBL) Shadow (TSH)  
 Chrome (CHM)\* Tungsten (TTU)  
 \*optional on foot only

## GROMMETS

- Optional grommets are available in standard worksurface locations (left, center or right) **for rectangular tables**. Order as: **FOG1, FOG2 or FOG3. Add \$91.**
- Grommet hole dimensions are 3.25" wide x 1.875" deep.

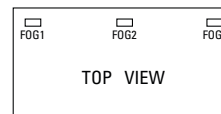
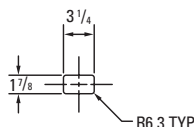

- Grommets may be placed at non-standard locations. Order as: **CSG. Add \$132.** A drawing must be supplied with vertical and horizontal dimensions to the center of the cut-out (as in drawing above). Please refer to the **custom grommet location form** in the back reference section.
- If adding **Cove mini power block** to FOG cut-out, cannot use with modesties.

## POWER BLOCK

- An individual corded power block (model **PMSPDM**) may be ordered on all worksurfaces.
- Power block is a configured with one electrical duplex receptacle and two data (RJ45) receptacles. 9' Black cord included. Power block dimensions are 6.5"W x 3.5"D x 2.75"H. Units cannot be daisy-chained and cannot be used with modesties.
- To purchase a power block, you must specify both the power block cut-out location and the power block model #. Order power block as **PMSPDM. Add \$268.** Power blocks are available in standard worksurface locations (left, center or right). Order as **E1, E2 or E3. Add \$91.**

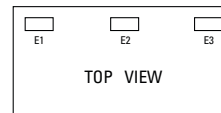
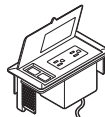

Power block **PMSPDM. Add \$268.** Specify location **E1, E2 or E3. Add \$91.**

## EXAMPLES OF POWER BLOCK POSITIONS

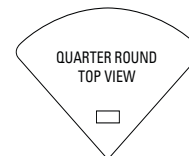
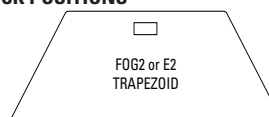
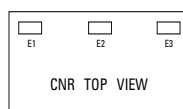

## MODPOWER DAISY-CHAIN SOLUTION

- Add flexible power and USB charging to ConnecTables rectangular tables. Connect up to four units with a single corded infeed with NEMA plug.
- ModPower units are sold separately, refer to Productivity Solutions page 471.
- Begin run with a starter unit which includes a corded infeed. Add additional middle or end units as required. Middle and end units are equipped with connecting cables.
- On-surface modules clamp on or screw mount to the table tops.
- In-surface modules require table top cut-outs for mounting (cannot be used with modesties):
  - Specify cut-out option **MPS** for a single cut-out to accommodate one ModPower in-surface unit (cut-out will be centered on the approach side) for **30" to 72" wide rectangular tables. Add \$91.**
  - Specify cut-out option **MPD** for two cut-outs in the left and right positions, 15" from ends to center of unit on approach side for **60", 66" and 72" wide rectangular tables. Add \$183.**

**SPECIFICATIONS**

- Specifications marked with an \* are applicable to only those products which have the \* symbol beside the product name.

**TOP & EDGE OPTIONS**

- ConnectTABLES have nine basic top shapes available in various sizes. All top shapes have a variety of straight or curved edges which are referred to as **Working (W)**, **Connecting (C) or End (E) edges**. Edges can also have a combination of edge types as shown.

\*cannot freestand

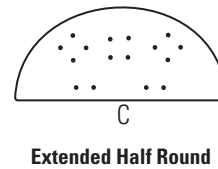
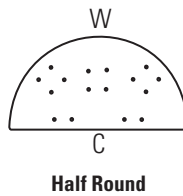
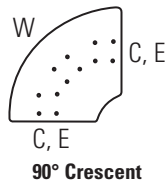
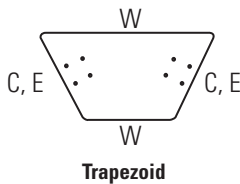
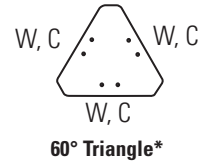
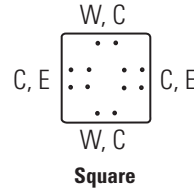
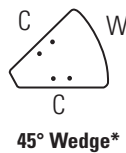
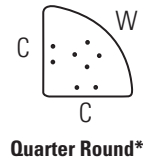
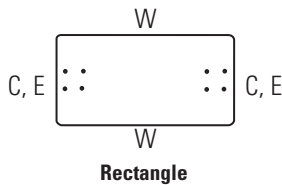

**Working edge (1)** - Edges designated with the letter "W" indicate that this is a **working** or sitting edge. These edges can be connected with optional ganging hardware in freestanding applications.

**Connecting edge (2)** - Edges designated with the letter "C" indicate that this is a **connecting** edge. These edges can be connected to any other connecting edge of equal width, regardless of the top shape or size.

**End edge (3)** - Edges designated with the letter "E" indicate that this is an **end** edge or an edge that can finish a run of tops. If a top has two end edges it can be freestanding. 90° crescent tops can be freestanding if the optional center leg is added.

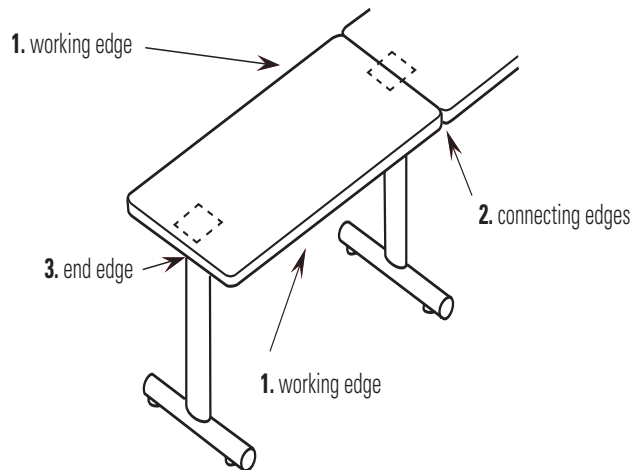

**FREESTANDING AND CONNECTING CONDITIONS**

**Freestanding tables** are defined as any one worksurface supported by two or more legs; **connecting tables** are defined as more than one worksurface supported by a single leg at each point of connection. The rule to determine the quantity of legs of an open configuration is the number of worksurfaces plus one (See Figure 1).

On closed configurations, the number of legs is equal to the number of worksurfaces (See Figure 2). There are some exceptions, such as when optional third legs are used on quarter round or 90° crescent shapes.

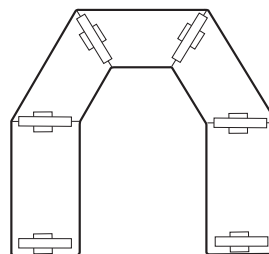

**Figure 1.**  
**Open Configuration**  
Number of surfaces = 5  
Number of legs = 6

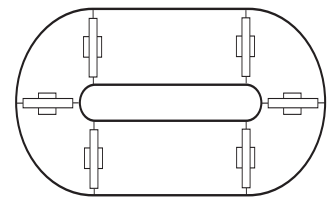

**Figure 2.**  
**Closed Configuration**  
Number of surfaces = 6  
Number of legs = 6

# C CONNECTABLES® - NOTES

## FREESTANDING CONDITIONS

- All square, rectangle and trapezoid shapes are able to act as freestanding tables (**Figure 3**).
- When trapezoid tops are freestanding, legs must be on the outer left and right sides (**Figure 4**).
- 90° crescent worksurfaces have provision for an optional third center leg for additional stability when heavy loads are applied to the outside edge. They can also be used as freestanding tables when a third leg is added (**Figure 5**).
- All freestanding tables can be connected with optional ganging hardware.
- Freestanding tables can be ganged with connected tables in some cases, providing that the number and size of connected tables is easily movable (**Figure 6**).

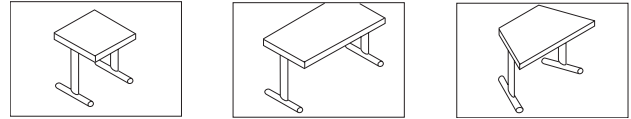
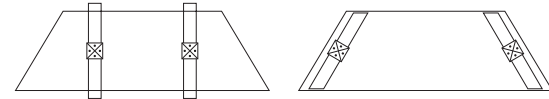

Figure 3 - Freestanding Tables



Incorrect Correct  
Figure 4 - Trapezoid Tops

### • DO NOT DRAG TABLES WHEN RE-CONFIGURING.

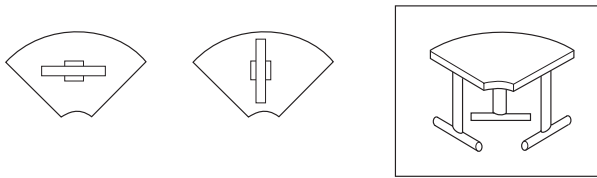

Figure 5 - Adding a Third Leg

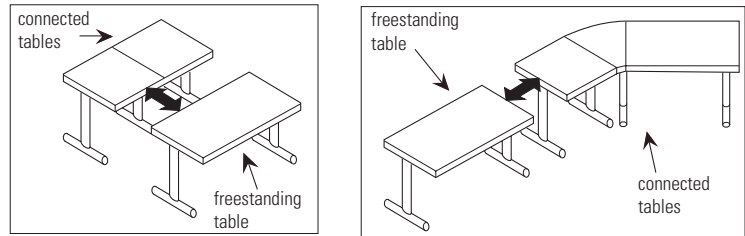

Figure 6 - Ganging with Connected Tables

## CONNECTING CONDITIONS

- Any two worksurfaces of equal depth (24"D, 30"D or 36"D) can be connected with one leg, at the connecting or end edges (**Figure 8**).
- Half round worksurfaces can be used in the following ways: They must be of equal width when connected to each other (**Figure 7**) or the connecting shapes must be equal to half the width of the connecting half round (**Figure 8**).
- ConnectABLES is designed with the leg to be fastened parallel to connecting edges, but in some cases you may wish to fasten legs at 90° to connecting edges. This could allow for increased leg or knee clearance, depending on the intended use (**Figure 9**).
- Quarter round and 90° crescent worksurfaces have provision for an optional third leg for additional stability when heavy loads are applied to the outside edge. For quarter round worksurfaces, it is recommended that configuration "A" be used since the outside end of the center leg in configuration "B" is almost flush with the outside edge of the worksurface. If configuration "B" is installed against a wall or where there will be no traffic flow, then configuration "B" can be used.

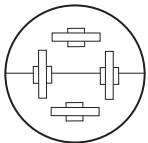

Figure 7

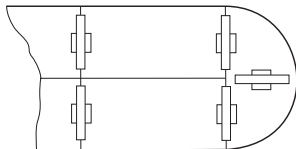

Figure 8

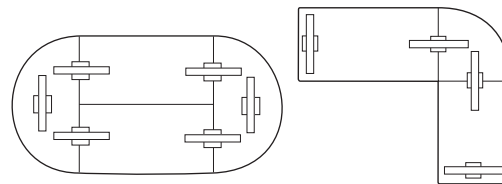
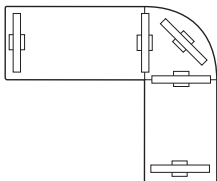
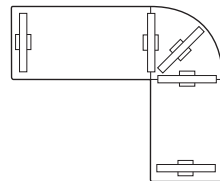

Figure 9 - 90° Leg Connections



Configuration A



Configuration B

Legs are fastened to worksurfaces utilizing a steel-to-steel connection. Each leg comes equipped with four 0.25" x 0.875" screws. machine screws. Screws are inserted through the four oval shaped holes only. **Do not use wood screws.** When fastening legs to worksurfaces, hand thread screws into position to prevent any cross threading. When all screws have been hand threaded, tighten firmly with screwdriver to secure. Optional thumbscrews can be used in place of machine screws. Thumbscrews eliminate the need for a screwdriver, whether assembling or disassembling tables. **Do not use power tools for assembly of legs.**

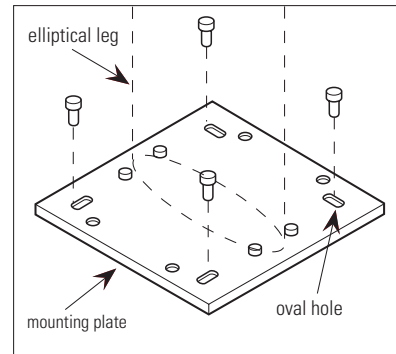

## FREESTANDING TABLES

1. Turn worksurface upside-down on clean floor. (You may want to use carton from packaging as a protective assembly surface to protect the top from scratching.)
2. Position leg mounting plate holes over threaded steel inserts in top.
3. Fasten each leg to top with four 0.25" x 0.875" screws.
4. Turn table right-side up.
5. Level table by adjusting glides.

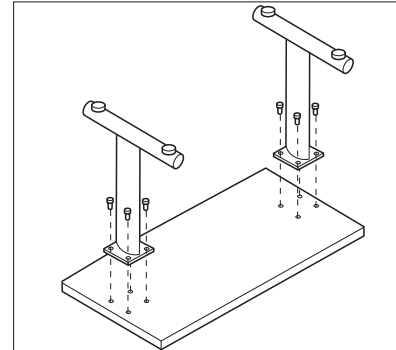

## CONNECTING TABLES

1. Determine approximate location of desired configuration in room and turn worksurfaces upside down on floor. (Remember you are working in reverse.)
2. Position leg mounting plate so it is centered over the connecting edge of the first worksurface. Fasten leg with two 0.25" x 0.875" screws.
3. Repeat step 2 and 3 on the opposite edge of the first worksurface.
4. Turn table right side up.
5. Turn table right side up and fasten to the previous top from the underside.
6. To add additional worksurfaces repeat step 5.
7. When all the tops have been connected, level complete configuration by adjusting glides.

**Note:** Use the same procedures as above when using optional thumb screws.

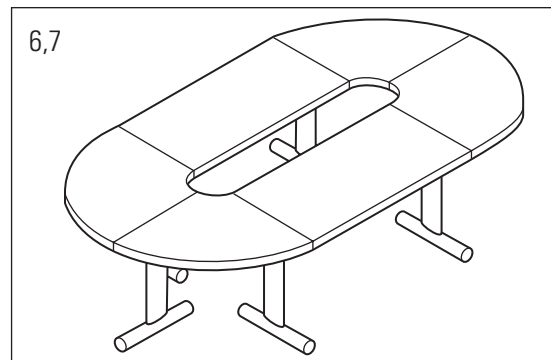
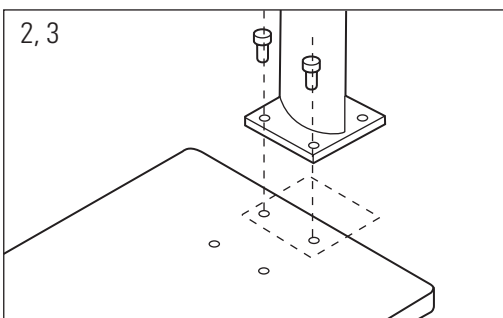
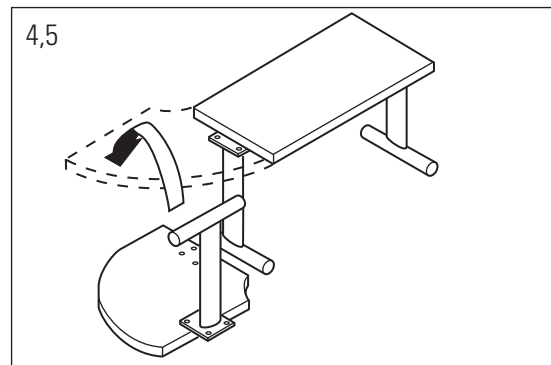
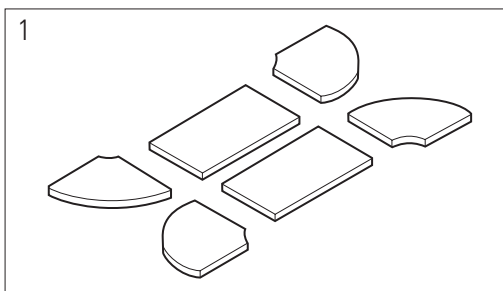



## C CONNECTABLES® - PUTTING IT ALL TOGETHER

### OPTIONAL CASTERS

1. Turn worksurface upside down on floor.
2. Remove existing glide if previously installed.
3. Fasten caster to T-leg by threading caster stem into base of T-leg and secure by tightening lock nut.
4. If casters are used in combination with glides, level table by adjusting glides.

**Note:** Casters are available in locking or non-locking styles.

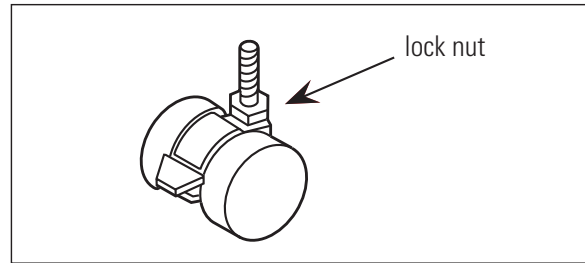

### OPTIONAL GANGING HARDWARE

1. Optional ganging hardware should be used when quick and frequent reconfigurations are required.
2. Turn worksurfaces to be ganged upside-down on floor.
3. Remove ganging hardware from package. Holes with steel inserts are located in the corner of tops.
4. Fasten ganging hardware to each worksurface with supplied thumb screws.
5. Projected arm from ganging hardware can pivot out of the way when not in use.

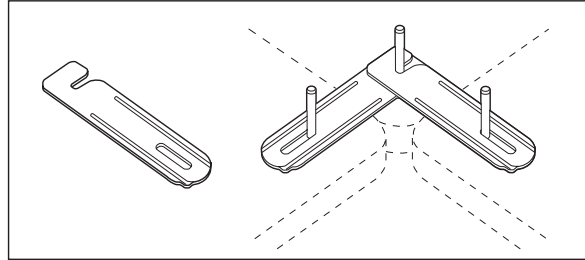

**SQUARE TOPS** **MODEL #** **DIMENSIONS** **WT/LB.** **CUBIC FT.** **LIST PRICE**

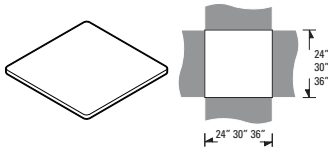

**Square Top**

|         | W x D x H   |    |      |              |
|---------|-------------|----|------|--------------|
| CNS2424 | 24 x 24 x 1 | 18 | 1    | <b>\$266</b> |
| CNS3030 | 30 x 30 x 1 | 27 | 1.56 | <b>\$324</b> |
| CNS3636 | 36 x 36 x 1 | 39 | 2    | <b>\$330</b> |

T-mold edging. Predrilled with threaded steel inserts for freestanding and linking installations.

**RECTANGULAR TOPS**

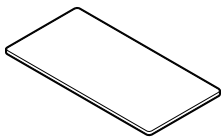
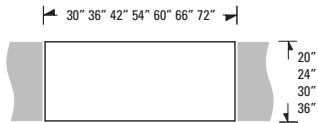

**Rectangle Top**

|          |             |       |      |              |
|----------|-------------|-------|------|--------------|
| CNR2030  | 30 x 20 x 1 | 22    | 1.25 | <b>\$183</b> |
| CNR2036  | 20 x 36 x 1 | 22.5  | 0.46 | <b>\$198</b> |
| CNR2042  | 42 x 20 x 1 | 31    | 1.75 | <b>\$224</b> |
| CNR2048  | 48 x 20 x 1 | 35    | 2    | <b>\$244</b> |
| CNRU2054 | 54 x 20 x 1 | 33.75 | 0.69 | <b>\$323</b> |
| CNRU2060 | 60 x 20 x 1 | 37.5  | 1.4  | <b>\$343</b> |
| CNRU2066 | 66 x 20 x 1 | 41.25 | 0.84 | <b>\$376</b> |
| CNRU2072 | 72 x 20 x 1 | 45    | 1    | <b>\$397</b> |
| CNR2430  | 30 x 24 x 1 | 22    | 1.25 | <b>\$193</b> |
| CNR2436  | 36 x 24 x 1 | 26    | 1.5  | <b>\$211</b> |
| CNR2442  | 42 x 24 x 1 | 31    | 1.75 | <b>\$234</b> |
| CNR2448  | 48 x 24 x 1 | 35    | 2    | <b>\$255</b> |
| CNRU2454 | 54 x 24 x 1 | 42    | 2.34 | <b>\$338</b> |
| CNRU2460 | 60 x 24 x 1 | 47    | 2.5  | <b>\$358</b> |
| CNRU2466 | 66 x 24 x 1 | 52    | 2.8  | <b>\$390</b> |
| CNRU2472 | 72 x 24 x 1 | 57    | 3    | <b>\$415</b> |
| CNR3036  | 36 x 30 x 1 | 33    | 1.88 | <b>\$255</b> |
| CNR3042  | 42 x 30 x 1 | 38    | 2.19 | <b>\$279</b> |
| CNR3048  | 48 x 30 x 1 | 44    | 2.5  | <b>\$302</b> |
| CNRU3054 | 54 x 30 x 1 | 52    | 2.8  | <b>\$387</b> |
| CNRU3060 | 60 x 30 x 1 | 59    | 3.13 | <b>\$411</b> |
| CNRU3066 | 66 x 30 x 1 | 64    | 3.44 | <b>\$439</b> |
| CNRU3072 | 72 x 30 x 1 | 70    | 3.75 | <b>\$466</b> |
| CNR3642  | 42 x 36 x 1 | 52.5  | 1.6  | <b>\$354</b> |
| CNR3648  | 48 x 36 x 1 | 60    | 1.8  | <b>\$387</b> |
| CNRU3654 | 54 x 36 x 1 | 70    | 2    | <b>\$495</b> |
| CNRU3660 | 60 x 36 x 1 | 78    | 2.2  | <b>\$538</b> |
| CNRU3666 | 66 x 36 x 1 | 87    | 2.4  | <b>\$592</b> |
| CNRU3672 | 72 x 36 x 1 | 94    | 2.6  | <b>\$647</b> |

T-mold edging. Predrilled with threaded steel inserts for freestanding and linking installations. **Tops 54" and longer are standard with a 16 gauge steel support channel.**

**TRAPEZOID TOPS**

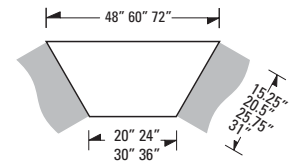

**Trapezoid Top**

|         |                |       |      |              |
|---------|----------------|-------|------|--------------|
| CNT2048 | 48 x 17.5 x 1  | 26.25 | 0.55 | <b>\$252</b> |
| CNT2060 | 60 x 17.5 x 1  | 44    | 1.85 | <b>\$307</b> |
| CNT2448 | 48 x 20.5 x 1  | 21    | 2    | <b>\$268</b> |
| CNT2460 | 60 x 20.5 x 1  | 44    | 1.85 | <b>\$324</b> |
| CNT3060 | 60 x 25.75 x 1 | 35    | 3.13 | <b>\$353</b> |
| CNT3072 | 72 x 25.75 x 1 | 66    | 2.2  | <b>\$397</b> |
| CNT3660 | 60 x 31 x 1    | 66    | 2.2  | <b>\$482</b> |
| CNT3672 | 72 x 31 x 1    | 79.2  | 3.5  | <b>\$578</b> |

T-mold edging. Predrilled with threaded steel inserts for freestanding and linking installations.

**Required specifications**

Top finish  
Edge finish

**Optional specifications**

Grommet

**Accessories**

Power block

# C CONNECTABLES®

## 90° CRESCENT TOPS

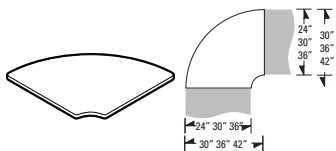

90° Crescent Top\*

| MODEL #   | DIMENSIONS  | WT/LB. | CUBIC FT. | LIST PRICE   |
|-----------|-------------|--------|-----------|--------------|
| W x D x H |             |        |           |              |
| CNC2430   | 30 x 30 x 1 | 20     | 1.56      | <b>\$280</b> |
| CNC3036   | 36 x 36 x 1 | 30     | 2.25      | <b>\$403</b> |
| CNC3642   | 42 x 42 x 1 | 50     | 3.15      | <b>\$556</b> |

T-mold edging. Predrilled with threaded steel inserts for freestanding and linking installations.

- **CNC2430** for use with 24" deep tops.
- **CNC3036** for use with 30" deep tops.
- **CNC3642** for use with 36" deep tops.
- **CNC2430** does not require a center leg.

## QUARTER ROUND TOPS

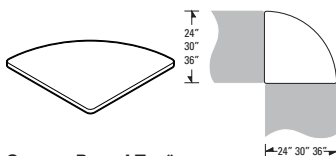

Quarter Round Top\*

|         |             |    |      |              |
|---------|-------------|----|------|--------------|
| CNQ2424 | 24 x 24 x 1 | 14 | 1    | <b>\$172</b> |
| CNQ3030 | 30 x 30 x 1 | 21 | 1.56 | <b>\$213</b> |
| CNQ3636 | 36 x 36 x 1 | 45 | 1.3  | <b>\$351</b> |

T-mold edging. Predrilled with threaded steel inserts for **linking installations only**.

## 45° WEDGE TOPS

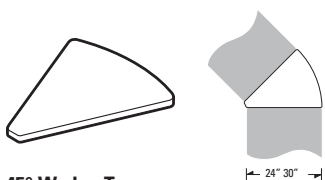

45° Wedge Top

|         |             |    |      |              |
|---------|-------------|----|------|--------------|
| CNW2424 | 24 x 24 x 1 | 10 | 1    | <b>\$190</b> |
| CNW3030 | 30 x 30 x 1 | 14 | 1.56 | <b>\$231</b> |

T-mold edging. Predrilled with threaded steel inserts for **linking installations only**.

## THREE WAY CONNECTOR TOPS

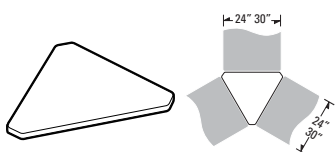

Three Way Connector Top

|         |             |    |      |              |
|---------|-------------|----|------|--------------|
| CNY2424 | 24 x 24 x 1 | 13 | 1    | <b>\$172</b> |
| CNY3030 | 30 x 30 x 1 | 18 | 1.56 | <b>\$210</b> |

T-mold edging. Predrilled with threaded steel inserts for **linking installations only**.

## HALF ROUND TOPS

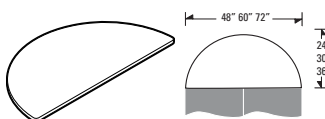

Half Round Top\*

|           |             |    |      |              |
|-----------|-------------|----|------|--------------|
| CNHFS2448 | 48 x 24 x 1 | 36 | 2    | <b>\$274</b> |
| CNHFS3060 | 60 x 30 x 1 | 56 | 3.13 | <b>\$360</b> |
| CNHFS3672 | 72 x 36 x 1 | 81 | 3.3  | <b>\$624</b> |

T-mold edging. Predrilled with threaded steel inserts for freestanding and linking installations.

- *Requires three legs for freestanding.*

## EXTENDED HALF ROUND TOPS

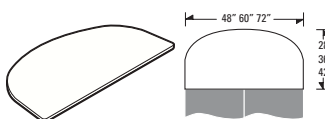

Extended Half Round Top

|        |             |     |      |              |
|--------|-------------|-----|------|--------------|
| CNHE24 | 48 x 28 x 1 | 50  | 1.88 | <b>\$311</b> |
| CNHE30 | 60 x 36 x 1 | 75  | 2.87 | <b>\$442</b> |
| CNHE36 | 72 x 42 x 1 | 102 | 3.88 | <b>\$706</b> |

T-mold edging. Predrilled with threaded steel inserts for **linking installations ONLY**.

### Required specifications

Top finish  
Edge finish

### Optional specifications

Grommet\*

### Accessories

Power block

## MODESTY PANELS



Modesty Panel

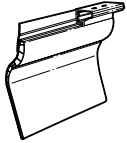

Modesty Panel



Modesty Panel

## MODEL # DIMENSIONS WT/LB. CUBIC FT. LIST PRICE

## W x D x H

|          |                   |     |     |              |
|----------|-------------------|-----|-----|--------------|
| CNCA2430 | 35 x 2.75 x 11.75 | 2.8 | 0.5 | <b>\$145</b> |
| CNCA3036 | 43 x 2.75 x 11.75 | 3.3 | 0.6 | <b>\$172</b> |
| CNCA3642 | 53 x 2.75 x 11.75 | 3.9 | 0.7 | <b>\$230</b> |

For use with **CNC crescent tops**. 11.75" high, Black plastic, attractive ribbed design. Includes two fold-away installation clips and flexible privacy strips. Connects to predrilled holes in table top.

- *Cannot be used when worksurface tops are attached to flip-top legs.*

|          |                   |     |     |              |
|----------|-------------------|-----|-----|--------------|
| CNQA2424 | 27 x 2.75 x 11.75 | 2.2 | 0.4 | <b>\$123</b> |
| CNQA3030 | 35 x 2.75 x 11.75 | 2.8 | 0.5 | <b>\$145</b> |
| CNQA3636 | 44 x 2.75 x 11.75 | 3.3 | 0.6 | <b>\$172</b> |

For use with **CNQ quarter round tops**. 11.75" high, Black plastic, attractive ribbed design. Includes two fold-away installation clips and flexible privacy strips. Connects to predrilled holes in table top.

- *Cannot be used when worksurface tops are attached to flip-top legs.*

|          |                 |      |      |              |
|----------|-----------------|------|------|--------------|
| CNRA2030 | 29.5 x 3 x 10.5 | 2.5  | 0.54 | <b>\$123</b> |
| CNRA2036 | 35.5 x 3 x 10.5 | 2.65 | 0.65 | <b>\$145</b> |
| CNRA2042 | 41.5 x 3 x 10.5 | 2.9  | 0.76 | <b>\$172</b> |
| CNRA2048 | 47.5 x 3 x 10.5 | 3.1  | 0.86 | <b>\$196</b> |
| CNRA2054 | 53.5 x 3 x 10.5 | 3.25 | 0.98 | <b>\$230</b> |
| CNRA2060 | 59.5 x 3 x 10.5 | 3.4  | 1.1  | <b>\$245</b> |
| CNRA2066 | 65.5 x 3 x 10.5 | 3.6  | 1.2  | <b>\$270</b> |
| CNRA2072 | 71.5 x 3 x 10.5 | 3.8  | 1.3  | <b>\$299</b> |

|          |                   |     |     |              |
|----------|-------------------|-----|-----|--------------|
| CNRA2430 | 29 x 2.75 x 11.75 | 2.8 | 0.5 | <b>\$123</b> |
| CNRA2436 | 35 x 2.75 x 11.75 | 3.3 | 0.6 | <b>\$145</b> |
| CNRA2442 | 41 x 2.75 x 11.75 | 3.9 | 0.7 | <b>\$172</b> |
| CNRA2448 | 47 x 2.75 x 11.75 | 4.4 | 0.8 | <b>\$196</b> |
| CNRA2454 | 53 x 2.75 x 11.75 | 5   | 0.9 | <b>\$230</b> |
| CNRA2460 | 59 x 2.75 x 11.75 | 5.5 | 1   | <b>\$245</b> |
| CNRA2466 | 65 x 2.75 x 11.75 | 6.1 | 1.1 | <b>\$270</b> |
| CNRA2472 | 71 x 2.75 x 11.75 | 6.6 | 1.2 | <b>\$299</b> |

|          |                   |     |     |              |
|----------|-------------------|-----|-----|--------------|
| CNRA3036 | 35 x 2.75 x 11.75 | 3.3 | 0.6 | <b>\$145</b> |
| CNRA3042 | 41 x 2.75 x 11.75 | 3.9 | 0.7 | <b>\$172</b> |
| CNRA3048 | 47 x 2.75 x 11.75 | 4.4 | 0.8 | <b>\$196</b> |
| CNRA3054 | 53 x 2.75 x 11.75 | 5   | 0.9 | <b>\$230</b> |
| CNRA3060 | 59 x 2.75 x 11.75 | 5.5 | 1   | <b>\$245</b> |
| CNRA3066 | 65 x 2.75 x 11.75 | 6.1 | 1.1 | <b>\$270</b> |
| CNRA3072 | 71 x 2.75 x 11.75 | 6.6 | 1.2 | <b>\$299</b> |

|          |                   |     |     |              |
|----------|-------------------|-----|-----|--------------|
| CNRA3642 | 41 x 2.75 x 11.75 | 3.9 | 0.7 | <b>\$172</b> |
| CNRA3648 | 47 x 2.75 x 11.75 | 4.4 | 0.8 | <b>\$196</b> |
| CNRA3654 | 53 x 2.75 x 11.75 | 5   | 0.9 | <b>\$230</b> |
| CNRA3660 | 59 x 2.75 x 11.75 | 5.5 | 1   | <b>\$245</b> |
| CNRA3666 | 65 x 2.75 x 11.75 | 6.1 | 1.1 | <b>\$270</b> |
| CNRA3672 | 71 x 2.75 x 11.75 | 6.6 | 1.2 | <b>\$299</b> |

For use with **CNR/CNRU rectangular tops**. 11.75" high, Black plastic, attractive ribbed design. Includes two fold-away installation clips and flexible privacy strips. Connects to predrilled holes in table top.

- *Cannot be used when worksurface tops are attached to flip-top legs.*

## MODESTY PANELS

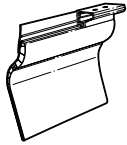

**Modesty Panel**

| MODEL #  | DIMENSIONS<br>W x D x H | WT/LB. | CUBIC FT. | LIST PRICE   |
|----------|-------------------------|--------|-----------|--------------|
| CNSA2424 | 23 x 2.75 x 11.75       | 2.2    | 0.4       | <b>\$96</b>  |
| CNSA3030 | 29 x 2.75 x 11.75       | 2.8    | 0.5       | <b>\$123</b> |
| CNSA3636 | 35 x 2.75 x 11.75       | 3.3    | 0.6       | <b>\$145</b> |

For use with **long side of CNS square tops**. 11.75" high, Black plastic, attractive ribbed design. Includes two fold-away installation clips and flexible privacy strips. Connects to predrilled holes in table top.

- *Cannot be used when worksurface tops are attached to flip-top legs.*

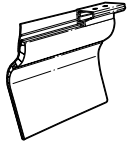

**Modesty Panel**

|           |                   |     |     |              |
|-----------|-------------------|-----|-----|--------------|
| CNTA2448L | 43 x 2.75 x 11.75 | 4.4 | 0.8 | <b>\$172</b> |
| CNTA2460L | 55 x 2.75 x 11.75 | 5.5 | 1.2 | <b>\$230</b> |
| CNTA3060L | 55 x 2.75 x 11.75 | 5.5 | 1.2 | <b>\$230</b> |
| CNTA3072L | 67 x 2.75 x 11.75 | 6.6 | 1.4 | <b>\$270</b> |
| CNTA3660L | 55 x 2.75 x 11.75 | 5.5 | 1.2 | <b>\$230</b> |
| CNTA3672L | 67 x 2.75 x 11.75 | 6.6 | 1.4 | <b>\$270</b> |

For use with **long side of CNT trapezoid tops**. 11.75" high, Black plastic, attractive ribbed design. Includes two fold-away installation clips and flexible privacy strips. Connects to predrilled holes in table top.

- *Cannot be used when worksurface tops are attached to flip-top legs.*

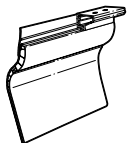

**Modesty Panel**

|           |                   |     |     |              |
|-----------|-------------------|-----|-----|--------------|
| CNTA2448S | 23 x 2.75 x 11.75 | 2.2 | 0.4 | <b>\$96</b>  |
| CNTA2460S | 35 x 2.75 x 11.75 | 2.2 | 0.4 | <b>\$145</b> |
| CNTA3060S | 29 x 2.75 x 11.75 | 2.8 | 0.5 | <b>\$123</b> |
| CNTA3072S | 41 x 2.75 x 11.75 | 2.8 | 0.5 | <b>\$172</b> |
| CNTA3660S | 23 x 2.75 x 11.75 | 3.3 | 0.6 | <b>\$96</b>  |
| CNTA3672S | 35 x 2.75 x 11.75 | 3.3 | 0.6 | <b>\$145</b> |

For use with **short side of CNT trapezoid tops**. 11.75" high, Black plastic, attractive ribbed design. Includes two fold-away installation clips and flexible privacy strips. Connects to predrilled holes in table top.

- *Cannot be used when worksurface tops are attached to flip-top legs.*

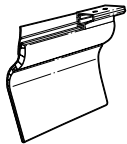

**Modesty Panel**

|          |                   |     |     |             |
|----------|-------------------|-----|-----|-------------|
| CNWA2424 | 17 x 2.75 x 11.75 | 2.2 | 0.4 | <b>\$75</b> |
| CNWA3030 | 22 x 2.75 x 11.75 | 2.8 | 0.5 | <b>\$96</b> |

For use with **CNW wedge tops**. 11.75" high, Black plastic, attractive ribbed design. Includes two fold-away installation clips and flexible privacy strips. Connects to predrilled holes in table top.

- *Cannot be used when worksurface tops are attached to flip-top legs.*

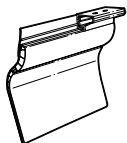

**Modesty Panel**

|          |                   |     |     |              |
|----------|-------------------|-----|-----|--------------|
| CNYA2424 | 22 x 2.75 x 11.75 | 2.2 | 0.4 | <b>\$96</b>  |
| CNYA3030 | 27 x 2.75 x 11.75 | 2.8 | 0.5 | <b>\$123</b> |

For use with **CNY triangle tops**. 11.75" high, Black plastic, attractive ribbed design. Includes two fold-away installation clips and flexible privacy strips. Connects to predrilled holes in table top.

- *Cannot be used when worksurface tops are attached to flip-top legs.*

## WIRE MANAGEMENT UNITS

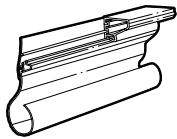

Wire Management Unit

| MODEL #  | DIMENSIONS<br>W x D x H | WT/LB. | CUBIC FT. | LIST PRICE   |
|----------|-------------------------|--------|-----------|--------------|
|          |                         |        |           |              |
| CNCB3036 | 43 x 2.75 x 6           | 1.8    | 0.6       | <b>\$120</b> |
| CNCB3642 | 53 x 2.75 x 6           | 2.1    | 0.7       | <b>\$161</b> |

For use with **CNC crescent tops**. 6" high, Black plastic, attractive ribbed design. Includes two fold-away installation clips and flexible privacy strips. Connects to predrilled holes in table top. Can be used with or without wire management grommet.

- *Cannot be used when worksurface tops are attached to flip-top legs.*

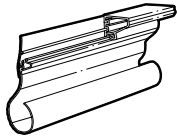

Wire Management Unit

|          |               |     |     |              |
|----------|---------------|-----|-----|--------------|
| CNOB2424 | 27 x 2.75 x 6 | 1.2 | 0.4 | <b>\$88</b>  |
| CNOB3030 | 35 x 2.75 x 6 | 1.5 | 0.5 | <b>\$108</b> |
| CNOB3636 | 44 x 2.75 x 6 | 1.8 | 0.6 | <b>\$120</b> |

For use with **CNO quarter round tops**. 6" high, Black plastic, attractive ribbed design. Includes two fold-away installation clips and flexible privacy strips. Connects to predrilled holes in table top. Can be used with or without wire management grommet.

- *Cannot be used when worksurface tops are attached to flip-top legs.*

|          |               |     |     |              |
|----------|---------------|-----|-----|--------------|
| CNRB2430 | 29 x 2.75 x 6 | 1.5 | 0.5 | <b>\$88</b>  |
| CNRB2436 | 35 x 2.75 x 6 | 1.8 | 0.6 | <b>\$108</b> |
| CNRB2442 | 41 x 2.75 x 6 | 2.1 | 0.7 | <b>\$120</b> |
| CNRB2448 | 47 x 2.75 x 6 | 2.4 | 0.8 | <b>\$142</b> |
| CNRB2454 | 53 x 2.75 x 6 | 2.7 | 0.9 | <b>\$161</b> |
| CNRB2460 | 59 x 2.75 x 6 | 3   | 1   | <b>\$177</b> |
| CNRB2466 | 65 x 2.75 x 6 | 3.3 | 1.1 | <b>\$177</b> |
| CNRB2472 | 71 x 2.75 x 6 | 3.6 | 1.2 | <b>\$245</b> |

|          |               |     |     |              |
|----------|---------------|-----|-----|--------------|
| CNRB3036 | 35 x 2.75 x 6 | 1.8 | 0.6 | <b>\$108</b> |
| CNRB3042 | 41 x 2.75 x 6 | 2.1 | 0.7 | <b>\$120</b> |
| CNRB3048 | 47 x 2.75 x 6 | 2.4 | 0.8 | <b>\$142</b> |
| CNRB3054 | 53 x 2.75 x 6 | 2.7 | 0.9 | <b>\$161</b> |
| CNRB3060 | 59 x 2.75 x 6 | 3   | 1   | <b>\$177</b> |
| CNRB3066 | 65 x 2.75 x 6 | 3.3 | 1.1 | <b>\$177</b> |
| CNRB3072 | 71 x 2.75 x 6 | 3.6 | 1.2 | <b>\$245</b> |

|          |               |     |     |              |
|----------|---------------|-----|-----|--------------|
| CNRB3642 | 41 x 2.75 x 6 | 2.1 | 0.7 | <b>\$120</b> |
| CNRB3648 | 47 x 2.75 x 6 | 2.4 | 0.8 | <b>\$142</b> |
| CNRB3654 | 53 x 2.75 x 6 | 2.7 | 0.9 | <b>\$161</b> |
| CNRB3660 | 59 x 2.75 x 6 | 3   | 1   | <b>\$177</b> |
| CNRB3666 | 65 x 2.75 x 6 | 3.3 | 1.1 | <b>\$177</b> |
| CNRB3672 | 71 x 2.75 x 6 | 3.6 | 1.2 | <b>\$245</b> |

For use with **CNR/CNRU rectangular tops**. 6" high, Black plastic, attractive ribbed design. Includes two fold-away installation clips and flexible privacy strips. Connects to predrilled holes in table top. Can be used with or without wire management grommet.

- *Cannot be used when worksurface tops are attached to flip-top legs.*

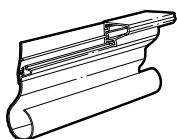

Wire Management Unit

# C CONNECTABLES®

## WIRE MANAGEMENT UNITS

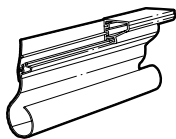

Wire Management Unit

| MODEL #  | DIMENSIONS<br>W x D x H | WT/LB. | CUBIC FT. | LIST PRICE   |
|----------|-------------------------|--------|-----------|--------------|
| CNSB2424 | 23 x 2.75 x 6           | 1.8    | 0.4       | <b>\$72</b>  |
| CNSB3030 | 29 x 2.75 x 6           | 1.5    | 0.5       | <b>\$88</b>  |
| CNSB3636 | 35 x 2.75 x 6           | 1.8    | 0.6       | <b>\$108</b> |

For use with **CNS square tops**. 6" high, Black plastic, attractive ribbed design. Includes two fold-away installation clips and flexible privacy strips. Connects to predrilled holes in table top. Can be used with or without wire management grommet.

- *Cannot be used when worksurface tops are attached to flip-top legs.*

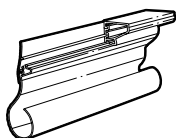

Wire Management Unit

|           |               |     |     |              |
|-----------|---------------|-----|-----|--------------|
| CNTB2448L | 43 x 2.75 x 6 | 2.4 | 0.8 | <b>\$120</b> |
| CNTB2460L | 55 x 2.75 x 6 | 3   | 1   | <b>\$161</b> |
| CNTB3060L | 55 x 2.75 x 6 | 3   | 1   | <b>\$161</b> |
| CNTB3072L | 67 x 2.75 x 6 | 3.6 | 1.2 | <b>\$230</b> |
| CNTB3660L | 55 x 2.75 x 6 | 3   | 1   | <b>\$161</b> |
| CNTB3672L | 67 x 2.75 x 6 | 3.6 | 1.2 | <b>\$230</b> |

For use with **long side of CNT trapezoid tops**. 6" high, Black plastic, attractive ribbed design. Includes two fold-away installation clips and flexible privacy strips. Connects to predrilled holes in table top. Can be used with or without wire management grommet.

- *Cannot be used when worksurface tops are attached to flip-top legs.*

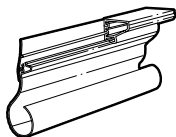

Wire Management Unit

|           |               |     |     |              |
|-----------|---------------|-----|-----|--------------|
| CNTB2448S | 23 x 2.75 x 6 | 1.2 | 0.4 | <b>\$72</b>  |
| CNTB2460S | 35 x 2.75 x 6 | 1.2 | 0.4 | <b>\$108</b> |
| CNTB3060S | 29 x 2.75 x 6 | 1.5 | 0.5 | <b>\$88</b>  |
| CNTB3072S | 41 x 2.75 x 6 | 1.5 | 0.5 | <b>\$120</b> |
| CNTB3660S | 23 x 2.75 x 6 | 1.8 | 0.6 | <b>\$72</b>  |
| CNTB3672S | 35 x 2.75 x 6 | 1.8 | 0.6 | <b>\$108</b> |

For use with **short side of CNT trapezoid tops**. 6" high, Black plastic, attractive ribbed design. Includes two fold-away installation clips and flexible privacy strips. Connects to predrilled holes in table top. Can be used with or without wire management grommet.

- *Cannot be used when worksurface tops are attached to flip-top legs.*

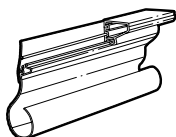

Wire Management Unit

|          |               |     |     |             |
|----------|---------------|-----|-----|-------------|
| CNWB2424 | 17 x 2.75 x 6 | 1.2 | 0.4 | <b>\$57</b> |
| CNWB3030 | 22 x 2.75 x 6 | 1.5 | 0.5 | <b>\$72</b> |

For use with **CNW wedge tops**. 6" high, Black plastic, attractive ribbed design. Includes two fold-away installation clips and flexible privacy strips. Connects to predrilled holes in table top. Can be used with or without wire management grommet.

- *Cannot be used when worksurface tops are attached to flip-top legs.*

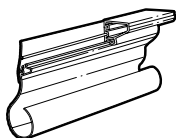

Wire Management Unit

|          |               |     |     |             |
|----------|---------------|-----|-----|-------------|
| CNYB2424 | 22 x 2.75 x 6 | 1.2 | 0.4 | <b>\$72</b> |
| CNYB3030 | 27 x 2.75 x 6 | 1.5 | 0.5 | <b>\$88</b> |

For use with **CNY triangle tops**. 6" high, Black plastic, attractive ribbed design. Includes two fold-away installation clips and flexible privacy strips. Connects to predrilled holes in table top. Can be used with or without wire management grommet.

- *Cannot be used when worksurface tops are attached to flip-top legs.*

**MODESTY PANELS W/WIRE MANAGEMENT      MODEL #      DIMENSIONS      WT/LB.      CUBIC FT.      LIST PRICE**

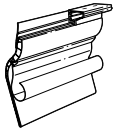

**Modesty Panel w/Wire Management**

|          | W x D x H         |     |     |              |
|----------|-------------------|-----|-----|--------------|
| CNCC2430 | 35 x 2.75 x 11.75 | 4.3 | 0.5 | <b>\$161</b> |
| CNCC3036 | 43 x 2.75 x 11.75 | 5.1 | 0.6 | <b>\$184</b> |
| CNCC3642 | 53 x 2.75 x 11.75 | 6   | 0.7 | <b>\$238</b> |

For use with **CNC crescent tops**. 11.75" high, Black plastic, attractive ribbed design. Includes two fold-away installation clips and flexible privacy strips. Connects to predrilled holes in table top. Can be used with or without wire management grommet.

- *Cannot be used when worksurface tops are attached to flip-top legs.*

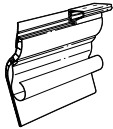

**Modesty Panel w/ Wire Management**

|          |                   |     |     |              |
|----------|-------------------|-----|-----|--------------|
| CNQC2424 | 27 x 2.75 x 11.75 | 3.4 | 0.4 | <b>\$133</b> |
| CNQC3030 | 35 x 2.75 x 11.75 | 4.3 | 0.5 | <b>\$161</b> |
| CNQC3636 | 44 x 2.75 x 11.75 | 5.1 | 0.6 | <b>\$184</b> |

For use with **CNC quarter round tops**. 11.75" high, Black plastic, attractive ribbed design. Includes two fold-away installation clips and flexible privacy strips. Connects to predrilled holes in table top. Can be used with or without wire management grommet.

- *Cannot be used when worksurface tops are attached to flip-top legs.*

|          |                 |      |      |              |
|----------|-----------------|------|------|--------------|
| CNRC2030 | 29.5 x 3 x 10.5 | 3.75 | 0.54 | <b>\$133</b> |
| CNRC2036 | 35.5 x 3 x 10.5 | 4    | 0.65 | <b>\$161</b> |
| CNRC2042 | 41.5 x 3 x 10.5 | 4.25 | 0.76 | <b>\$184</b> |
| CNRC2048 | 47.5 x 3 x 10.5 | 4.5  | 0.86 | <b>\$213</b> |
| CNRC2054 | 53.5 x 3 x 10.5 | 7.7  | 0.9  | <b>\$238</b> |
| CNRC2060 | 59.5 x 3 x 10.5 | 8.5  | 1    | <b>\$268</b> |
| CNRC2066 | 65.5 x 3 x 10.5 | 5.25 | 1.2  | <b>\$291</b> |
| CNRC2072 | 71.5 x 3 x 10.5 | 5.5  | 1.3  | <b>\$307</b> |

|          |                   |      |     |              |
|----------|-------------------|------|-----|--------------|
| CNRC2430 | 29 x 2.75 x 11.75 | 4.3  | 0.5 | <b>\$133</b> |
| CNRC2436 | 35 x 2.75 x 11.75 | 5.1  | 0.6 | <b>\$161</b> |
| CNRC2442 | 41 x 2.75 x 11.75 | 6    | 0.7 | <b>\$184</b> |
| CNRC2448 | 47 x 2.75 x 11.75 | 6.8  | 0.8 | <b>\$213</b> |
| CNRC2454 | 53 x 2.75 x 11.75 | 7.7  | 0.9 | <b>\$238</b> |
| CNRC2460 | 59 x 2.75 x 11.75 | 8.5  | 1   | <b>\$268</b> |
| CNRC2466 | 65 x 2.75 x 11.75 | 9.4  | 1.1 | <b>\$291</b> |
| CNRC2472 | 71 x 2.75 x 11.75 | 10.2 | 1.2 | <b>\$307</b> |

|          |                   |      |     |              |
|----------|-------------------|------|-----|--------------|
| CNRC3036 | 35 x 2.75 x 11.75 | 5.1  | 0.6 | <b>\$161</b> |
| CNRC3042 | 41 x 2.75 x 11.75 | 6    | 0.7 | <b>\$184</b> |
| CNRC3048 | 47 x 2.75 x 11.75 | 6.8  | 0.8 | <b>\$213</b> |
| CNRC3054 | 53 x 2.75 x 11.75 | 7.7  | 0.9 | <b>\$238</b> |
| CNRC3060 | 59 x 2.75 x 11.75 | 8.5  | 1   | <b>\$268</b> |
| CNRC3066 | 65 x 2.75 x 11.75 | 9.4  | 1.1 | <b>\$291</b> |
| CNRC3072 | 71 x 2.75 x 11.75 | 10.2 | 1.2 | <b>\$307</b> |

|          |                   |      |     |              |
|----------|-------------------|------|-----|--------------|
| CNRC3642 | 41 x 2.75 x 11.75 | 6    | 0.7 | <b>\$184</b> |
| CNRC3648 | 47 x 2.75 x 11.75 | 6.8  | 0.8 | <b>\$213</b> |
| CNRC3654 | 53 x 2.75 x 11.75 | 7.7  | 0.9 | <b>\$238</b> |
| CNRC3660 | 59 x 2.75 x 11.75 | 8.5  | 1   | <b>\$268</b> |
| CNRC3666 | 65 x 2.75 x 11.75 | 9.4  | 1.1 | <b>\$291</b> |
| CNRC3672 | 71 x 2.75 x 11.75 | 10.2 | 1.2 | <b>\$307</b> |

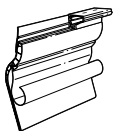

**Modesty Panel w/Wire Management**

For use with **CNR/CNRU rectangular tops**. 11.75" high, Black plastic, attractive ribbed design. Includes two fold-away installation clips and flexible privacy strips. Connects to predrilled holes in table top. Can be used with or without wire management grommet.

- *Cannot be used when worksurface tops are attached to flip-top legs.*



# C CONNECTABLES®

## MODESTY PANEL w/WIRE MANAGEMENT

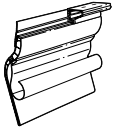

**Modesty Panel w/Wire Management**

| MODEL #  | DIMENSIONS<br>W x D x H | WT/LB. | CUBIC FT. | LIST PRICE   |
|----------|-------------------------|--------|-----------|--------------|
| CNSC2424 | 23 x 2.75 x 11.75       | 3.5    | 0.4       | <b>\$108</b> |
| CNSC3030 | 29 x 2.75 x 11.75       | 4.3    | 0.5       | <b>\$133</b> |
| CNSC3636 | 35 x 2.75 x 11.75       | 5.1    | 0.6       | <b>\$161</b> |

For use with **CNC square tops**. 11.75" high, Black plastic, attractive ribbed design. Includes two fold-away installation clips and flexible privacy strips. Connects to predrilled holes in table top. Can be used with or without wire management grommet.

- *Cannot be used when worksurface tops are attached to flip-top legs.*

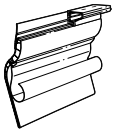

**Modesty Panel w/Wire Management**

|           |                   |      |     |              |
|-----------|-------------------|------|-----|--------------|
| CNTC2048L | 43 x 2.75 x 11.75 | 6.8  | 0.8 | <b>\$184</b> |
| CNTC2060L | 55 x 2.75 x 11.75 | 8.5  | 1   | <b>\$238</b> |
| CNTC2448L | 43 x 2.75 x 11.75 | 6.8  | 0.8 | <b>\$184</b> |
| CNTC2460L | 55 x 2.75 x 11.75 | 8.5  | 1   | <b>\$238</b> |
| CNTC3060L | 55 x 2.75 x 11.75 | 8.5  | 1   | <b>\$238</b> |
| CNTC3072L | 67 x 2.75 x 11.75 | 10.2 | 1.2 | <b>\$291</b> |
| CNTC3660L | 55 x 2.75 x 11.75 | 8.5  | 1   | <b>\$238</b> |
| CNTC3672L | 67 x 2.75 x 11.75 | 10.2 | 1.2 | <b>\$291</b> |

For use with **long side of CNT trapezoid tops**. 11.75" high, Black plastic, attractive ribbed design. Includes two fold-away installation clips and flexible privacy strips. Connects to predrilled holes in table top. Can be used with or without wire management grommet.

- *Cannot be used when worksurface tops are attached to flip-top legs.*

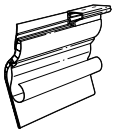

**Modesty Panel w/Wire Management**

|           |                   |     |     |              |
|-----------|-------------------|-----|-----|--------------|
| CNTC2048S | 23 x 2.75 x 11.75 | 3.4 | 0.4 | <b>\$108</b> |
| CNTC2060S | 35 x 2.75 x 11.75 | 3.5 | 0.5 | <b>\$161</b> |
| CNTC2448S | 23 x 2.75 x 11.75 | 3.4 | 0.4 | <b>\$108</b> |
| CNTC2460S | 35 x 2.75 x 11.75 | 3.4 | 0.4 | <b>\$161</b> |
| CNTC3060S | 29 x 2.75 x 11.75 | 4.3 | 0.5 | <b>\$133</b> |
| CNTC3072S | 41 x 2.75 x 11.75 | 4.3 | 0.5 | <b>\$184</b> |
| CNTC3660S | 23 x 2.75 x 11.75 | 5.1 | 0.6 | <b>\$108</b> |
| CNTC3672S | 35 x 2.75 x 11.75 | 5.1 | 0.6 | <b>\$161</b> |

For use with **short side of CNT trapezoid tops**. 11.75" high, Black plastic, attractive ribbed design. Includes two fold-away installation clips and flexible privacy strips. Connects to predrilled holes in table top. Can be used with or without wire management grommet.

- *Cannot be used when worksurface tops are attached to flip-top legs.*

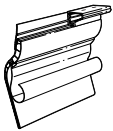

**Modesty Panel w/Wire Management**

|          |                   |     |     |              |
|----------|-------------------|-----|-----|--------------|
| CNWC2424 | 17 x 2.75 x 11.75 | 3.4 | 0.4 | <b>\$84</b>  |
| CNWC3030 | 22 x 2.75 x 11.75 | 4.3 | 0.5 | <b>\$108</b> |

For use with **CNW wedge tops**. 11.75" high, Black plastic, attractive ribbed design. Includes two fold-away installation clips and flexible privacy strips. Connects to predrilled holes in table top. Can be used with or without wire management grommet.

- *Cannot be used when worksurface tops are attached to flip-top legs.*

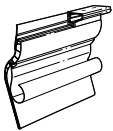

**Modesty Panel w/Wire Management**

|          |                   |     |     |              |
|----------|-------------------|-----|-----|--------------|
| CNYC2424 | 22 x 2.75 x 11.75 | 3.4 | 0.4 | <b>\$108</b> |
| CNYC3030 | 27 x 2.75 x 11.75 | 4.3 | 0.5 | <b>\$133</b> |

For use with **CNY triangle tops**. 11.75" high, Black plastic, attractive ribbed design. Includes two fold-away installation clips and flexible privacy strips. Connects to predrilled holes in table top. Can be used with or without wire management grommet.

- *Cannot be used when worksurface tops are attached to flip-top legs.*

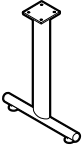
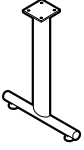
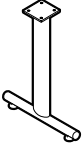
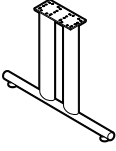
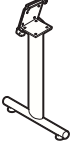
| T-LEGS  | MODEL #  | DIMENSIONS          |               | WT/LB. | CUBIC FT. | LIST PRICE   |
|---|--|---------------------|---------------|--------|-----------|--------------|
|   |  | W x D x H           |               |        |           |              |
|  <p><b>T-leg</b></p>   | CNTLEG18   | 17.1 x 1.75 x 27.8  |               | 9      | 2.1       | <b>\$176</b> |
|   | CNTLEG18P  | 17.1 x 1.75 x 27.8  |               | 13     | 2.4       | <b>\$354</b> |
| <p>18" long with plastic elliptical column cover, leveling glides and end caps. <b>For assembly with 20" tops.</b></p> <ul style="list-style-type: none"> <li>• For a single leg, order <b>CNTLEG18</b>. For a pair of legs (set of 2), order <b>CNTLEG18P</b>.</li> <li>• Chrome (<b>CHM</b>) is available (on foot only). <b>Add \$74</b> list for model CNTLEG18. <b>Add \$148</b> list for model CNTLEG18P.</li> <li>• Depth dimension reflects the T-leg bottom tube diameter.</li> </ul>  |  |                     |               |        |           |              |
|  <p><b>T-leg</b></p>   | CNTLEG24   | 20.8 x 1.75 x 27.8  |               | 9      | 2.1       | <b>\$176</b> |
|   | CNTLEG24P  | 20.8 x 1.75 x 27.8  |               | 17     | 2.4       | <b>\$354</b> |
| <p>20" long with plastic elliptical column cover, leveling glides and end caps. <b>For assembly with 24" tops.</b></p> <ul style="list-style-type: none"> <li>• For a single leg, order <b>CNTLEG24</b>. For a pair of legs (set of 2), order <b>CNTLEG24P</b>.</li> <li>• Chrome (<b>CHM</b>) is available (on foot only). <b>Add \$74</b> list for model CNTLEG24. <b>Add \$148</b> list for model CNTLEG24P.</li> <li>• Depth dimension reflects the T-leg bottom tube diameter.</li> </ul>  |  |                     |               |        |           |              |
|  <p><b>T-leg</b></p>   | CNTLEG30   | 27.25               | x 1.75 x 27.8 | 10     | 2.6       | <b>\$195</b> |
|   | CNTLEG30P  | 27.25               | x 1.75 x 27.8 | 19     | 3         | <b>\$388</b> |
| <p>26" long with plastic elliptical column cover, leveling glides and end caps. <b>For assembly with 30" tops.</b></p> <ul style="list-style-type: none"> <li>• For a single leg, order <b>CNTLEG30</b>. For a pair of legs (set of 2), order <b>CNTLEG30P</b>.</li> <li>• Chrome (<b>CHM</b>) is available (on foot only). <b>Add \$74</b> list for model CNTLEG30. <b>Add \$148</b> list for model CNTLEG30P.</li> <li>• Depth dimension reflects the T-leg bottom tube diameter.</li> </ul>  |  |                     |               |        |           |              |
|  <p><b>Dual Post T-leg</b></p>   | CNTLEG36   | 33.25 x 1.75 x 27.8 |               | 14     | 3.3       | <b>\$376</b> |
|   | <p>32" long with double post plastic elliptical column cover, leveling glides and end caps. <b>For assembly with 36" tops.</b></p> <ul style="list-style-type: none"> <li>• For a single leg.</li> <li>• Chrome (<b>CHM</b>) is available (on foot only). <b>Add \$74</b> list.</li> <li>• Depth dimension reflects the T-leg bottom tube diameter.</li> </ul> |                     |               |        |           |              |
|  <p><b>Flip-Top T-leg*</b></p>   | CNTFLEG24  | 20.8 x 1.75 x 28    |               | 10     | 2.4       | <b>\$311</b> |
|   | CNTFLG24P  | 20.8 x 1.75 x 28    |               | 20     | 2.1       | <b>\$621</b> |
| <p>20" long with plastic elliptical column cover, leveling glides and end caps. <b>For assembly with 24" deep rectangular and square tops only.</b> Hinged plate with locking mechanism to lock in open or closed position. Cannot be installed with thumbscrews.</p> <ul style="list-style-type: none"> <li>• Cannot be used when modesty panels and wire management are attached to worksurface tops.</li> <li>• For a single leg, order <b>CNTFLEG24</b>. For a pair of legs (set of 2), order <b>CNTFLG24P</b>.</li> <li>• Chrome (<b>CHM</b>) is available (on foot only). <b>Add \$74</b> list for model CNTFLEG24. <b>Add \$148</b> list for model CNTFLG24P.</li> <li>• Depth dimension reflects the T-leg bottom tube diameter.</li> </ul> |  |                     |               |        |           |              |

**Required specifications**

Leg finish

# C CONNECTABLES®

| ACCESSORIES | MODEL # | DIMENSIONS | WT/LB. | CUBIC FT. | LIST PRICE |
|-------------|---------|------------|--------|-----------|------------|
|-------------|---------|------------|--------|-----------|------------|



**Flip-Top T-leg\***

|           | W x D x H         |    |   |              |
|-----------|-------------------|----|---|--------------|
| CNTFLEG30 | 27.25 x 1.75 x 28 | 14 | 3 | <b>\$323</b> |
| CNTFLG30P | 27.25 x 1.75 x 28 | 28 | 6 | <b>\$647</b> |

26" long with plastic elliptical column cover, leveling glides and end caps. **For assembly with 30" deep rectangular and square tops only.** Hinged plate with locking mechanism to lock in open or closed position. Cannot be installed with thumbscrews.

- Cannot be used when modesty panels and wire management are attached to worksurface tops.
- For a single leg, order **CNTFLEG30**. For a pair of legs (set of 2), order **CNTFLG30P**.
- Chrome (**CHM**) is available (on foot only). **Add \$74** list for model CNTFLEG30. **Add \$148** list for model CNTFLG30P.
- Depth dimension reflects the T-leg bottom tube diameter

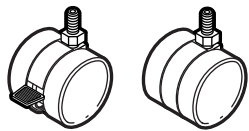

**Casters**

|      |             |   |   |             |
|------|-------------|---|---|-------------|
| CNCP | - x - x 1.5 | - | - | <b>\$30</b> |
|------|-------------|---|---|-------------|

**Set of 2** - 1.5" dual wheel casters, one locking. Suggested for hard floor surfaces and industrial carpeting. Not suitable for hardwood floors. Casters are fully interchangeable with glides. Black only.

- For use with *ConnectTABLES* units only.
- Casters **DO NOT** affect table height.



**Thumbscrews**

|      |                   |      |      |             |
|------|-------------------|------|------|-------------|
| CNTS | 1.25 x 1.25 x 1.5 | 0.04 | 0.02 | <b>\$20</b> |
|------|-------------------|------|------|-------------|

Triangular thumbscrew with 0.75" steel thread. **Set of 4.** Can be used in place of factory supplied screws to allow installation of T-legs to tops without tools. Black only.

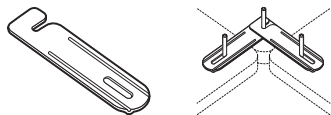

**Ganging Connector**

|       |                |     |     |             |
|-------|----------------|-----|-----|-------------|
| CNGFP | 2.5 x 5 x 1.13 | 0.2 | 0.1 | <b>\$33</b> |
|-------|----------------|-----|-----|-------------|

Black epoxy coated 13 gauge steel with two thumbscrews included. Used to connect table tops together for additional stability or for connecting freestanding tops together. Holes with steel inserts are located in the corner of all tops to accommodate this plate. **Sold individually.**

**Required specifications**

Leg finish\*

# DUET™ STACKING TABLES



Duet tables are multi-purpose high density stacking tables that offer optimum space utilization and flexibility. Their personality and simple design make them ideal for use in any learning or training environment at post-secondary and adult levels. Temporarily and easily convert auditoriums and other spaces into examination and seminar spaces. They can be partnered with stacking chairs such as Duet or Popcorn in matching or complementary colors (stacking chairs can be found in the Multi-Purpose section of the Seating price list).

The one-piece molded top and modesty are gently contoured providing an eased edge with an elegant waterfall transition from top to modesty.

Tops are available in a wide array of colors in 0.5" thick polypropylene. Polypropylene material offers strength and ease of cleaning with a slightly textured surface to offer scratch resistance.

## Features and Benefits

- One-piece molded top and modesty are 0.5" thick polypropylene.
- Tables are rated 250 lbs. capacity.
- Surface includes factory installed metal inserts for solid and secure connection to the sled base.
- 0.5" diameter solid steel rod sled base frame.
- Bumpers on the underside for protection when stacking.
- Model with ADA width compliant base is available.
- Shipped fully assembled.



One-piece top and modesty.



Stacks 5 high on floor or 20 high on dolly.



Ganging base to keep tables evenly aligned.

## GENERAL INFORMATION

- Duet tables are high density multi-purpose stacking tables ideal for auditoriums, seminars or any learning or training environment.
- Lightweight and easy to handle whether stacking for storage or setting up a room.
- Made of durable materials to withstand more demanding environments.
- Shipped fully assembled. Packaged 4 per carton.
- For environmental certifications, please visit [globalfurnituregroup.com](http://globalfurnituregroup.com).
- Covered by Global's Lifetime Warranty.

## WORKSURFACES

- Top and modesty are a one-piece injection molded design in 0.5" thick polypropylene.
- Available in a wide array of colors (see right column "FINISHES") to complement any space or to define sections by color.
- One-piece molded top and modesty are contoured providing an eased user edge, with an elegant waterfall transition from top to modesty.

26"W x 18"D x 9.75"H

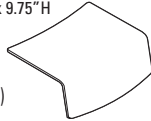

## CONSTRUCTION

- Surface includes molded in threaded inserts to provide a secure metal-to-metal connection to the sled base.
- Bumpers are included on the underside of top and inside modesty to protect surfaces when stacking.

## BASE

- 0.5" diameter solid steel rod sled base frame.
- Available in a durable Chrome finish.
- Model with ganging frame keeps tables evenly positioned and aligned. No tools or fasteners required for ganging; the bases simply interlock.
- Model with ADA compliant base is also available. The frame is 33" wide and the polypropylene top/modesty remain a constant size.
- Tables are standard without glides and are suitable for carpet, rubber or cork flooring.
- Glide options are available (see right column "GLIDES"). Glides must be chosen to best suit flooring type and site conditions. Upcharges apply.

## DOLLY

- For space saving storage and transport.
- Constructed from 1.5" x 0.5" steel tubing with heavy duty casters (two locking) and a removable handle.
- Dolly can stack up to 20 tables.
- Stacking height on dolly is up to 68".

## FINISHES

|     |           |     |         |
|-----|-----------|-----|---------|
| BZB | Buzz Blue | FRO | Frost   |
| CCT | Cactus    | INK | Ink     |
| CRO | Carrot    | LAB | Latte   |
| IVC | Cloud     | BLK | Night   |
| DJN | Dijon     | SND | Sand    |
| EGP | Eggplant  | SAR | Scarlet |
| FOG | Fog       | SHW | Shadow  |

## GLIDES

|    |   |
|----|---|
| CG | Clear polycarbonate (for carpet, rubber or concrete flooring).<br>Height added to table: 0.18". Add \$9/set.                    |
| SG | Glides with stainless steel pads (for carpet or rubber flooring).<br>Height added to table: 0.17". Add \$19/set.                |
| FG | Glides with felt pads (for vinyl, cork or laminate flooring).<br>Height added to table: 0.24". Add \$19/set.                    |
| RG | Glides with rubber pads (for vinyl, hardwood, laminate, stone or ceramic flooring). Height added to table: 0.16". Add \$19/set. |

## SPECIFICATIONS

- Specifications marked with an \* are applicable to only those products which have the\* symbol beside the product name.

## EXAMPLE DUET TABLE ORDER CODE:

*Duet stacking table, polypropylene surface in Shadow, clear polycarbonate glides*

|          |                |        |
|----------|----------------|--------|
| DTS1828P | -SHW           | -CG    |
| Model #  | Surface finish | Glides |

**STACKING TABLES**      **MODEL #**      **DIMENSIONS**      **WT/LB.**      **CUBIC FT.**      **LIST PRICE**

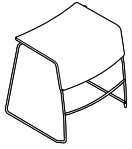

**Stacking Table\***

|          | W x D x H    |    |    |              |
|----------|--------------|----|----|--------------|
| DTS1828P | 29 x 25 x 28 | 23 | 23 | <b>\$469</b> |

One-piece polypropylene top and modesty with Chrome base. Dimensions listed include frame footprint, 26"W x 18"D top and 9.75'H modesty. Shipped fully assembled, 4 per carton.  
 • Price shown is per table. It is recommended to order in multiples of 4.

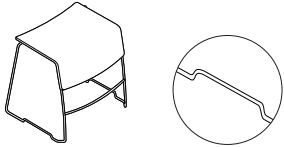

**Stacking Table, Ganging Frame\***

|           |                 |    |    |              |
|-----------|-----------------|----|----|--------------|
| DTS1828PG | 30.75 x 25 x 28 | 23 | 23 | <b>\$494</b> |
|-----------|-----------------|----|----|--------------|

One-piece polypropylene top and modesty with Chrome ganging base. Dimensions listed include frame footprint, 26"W x 18"D top and 9.75'H modesty. Shipped fully assembled, 4 per carton.  
 • Price shown is per table. It is recommended to order in multiples of 4.

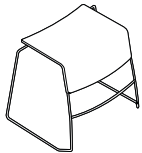

**Stacking Table, 32" Wide**

|          |              |    |    |              |
|----------|--------------|----|----|--------------|
| DTA1832P | 33 x 25 x 28 | 24 | 23 | <b>\$532</b> |
|----------|--------------|----|----|--------------|

ADA (American with Disabilities Act) compliant. 33" wide. One-piece polypropylene top and modesty with Chrome base. Dimensions listed include frame footprint, 26"W x 18"D top and 9.75'H modesty. Underside clearance is 27.1"H (extra height if glides are selected). Stacks up to 5 high on floor only; dolly does not accommodate. Shipped fully assembled, 4 per carton.  
 • Price shown is per table. It is recommended to order in multiples of 4.

**DOLLY**



**Dolly**

|       |                  |    |    |              |
|-------|------------------|----|----|--------------|
| DTD20 | 29.5 x 63 x 38.5 | 50 | 21 | <b>\$734</b> |
|-------|------------------|----|----|--------------|

For use with tables DTS1828P and DTS1828PG. Can stack up to 20 tables. Black only. Removable handle for storage. Shipped fully assembled in 1 carton.

**Required specifications**  
 Surface finish (not DTD20)

**Optional specifications**  
 Glides (not DTD20)

**Accessories**  
 Dolly\*



Edventure is a value series collection that offers a range of teacher desks, student desks and study carrels for more traditional learning environments. Designed to withstand daily rigorous use, traditional style meets modern performance.

Tops are available in a wide array of finishes in 1" thick thermally fused laminate or 1 1/16" high pressure laminate with matching or complementary 2mm PVC edgebanding.

Mobile teacher desks offer versatility with storage options for educators on the move.

Single and connecting study carrels create quiet work areas with optional power and data to stay connected.

**Features and Benefits**

- Tops are 1" thick thermally fused laminate or 1 1/16" high pressure laminate.
- Tops are constructed of 45 lb. density particle board.
- Matching or complementary 2mm PVC edgebanding.
- Surfaces include factory installed metal inserts for solid and secure leg connections.
- H-leg design on teacher and student desks.
- Teacher desk includes modesty panel and is available with or without casters.
- Teacher desk with left or right hand box/box/file pedestal available on casters only.
- Study carrel features curved side panels for seated privacy with a 29"H worksurface.
- Easy to assemble.



H-legs with cross bar.



Mobile teacher desk with modesty panel.



Freestanding and add-on study carrels.

**GENERAL INFORMATION**

- Edventure series is an affordable collection of teacher desks, student desks and study carrels with personal storage options, that bring a traditional element to the classroom.
- Simple and elegant design respects space requirements to accommodate various teaching styles.
- Edventure series is a high achiever, built to withstand the most demanding environments.
- Shipped easy to assemble.
- For environmental certifications, please visit [globalfurnituregroup.com](http://globalfurnituregroup.com).

**WORKSURFACES**

- Tops are available in 1" thick thermally fused laminate or 1 1/16" thick high pressure laminate.
- Available in an array of finishes (see page 477) in both thermally fused laminate or high pressure laminate. Color palette also includes nine new bold finishes available for high pressure laminate only, a complementary edge finish must be selected.
- Teacher desks are optional with grommets FOG1, FOG2 or FOG3 or cut-outs E1, E2 or E3 for power block PMSPDM ordered separately.

**CONSTRUCTION**

- Top core is made of 45 lb. density particle board.
- Surfaces include factory installed metal inserts for solid and secure leg connections.

**EDGE DETAIL**

- Global's preferred 2mm PVC edgebanding is standard.
- Edgebanding may be specified in a matching or a complementary finish for tops in standard Global laminates.

**LEGS**

- H-legs are 28" high and constructed from 2" x 2" square tubing with a 1" x 2" rectangular cross bar and adjustable leveling glides.
- Available in Black (TBL), Buzz Blue (TBZ), Cactus (TCC), Carrot (TCR), Cloud (TIV), Designer White (TDW), Dijon (TDJ), Eggplant (TEG), Fog (TFO), Frost (TFR), Ink (TIN), Kalua (TKA), Latte (TLA), Mocha (TMO), Nevada (TNE), Sand (TSN), Scarlet (TSR), Shadow (TSH), Toast (TOA) or Tungsten (TTU) paint finishes, Sandtex finish applied.

**CASTERS**

- Teacher desks and lecterns are available with locking casters. See models ending in C.
- Casters are 3 1/2" high overall.

**MODESTY PANELS**

- 12"H modesty panel is included with teacher desks.
- Available in an array of finishes (see page 475) in thermally fused laminate with matching edge only.

**STUDY CARRELS**

- The study carrel features a 29" high worksurface and curved side panels for privacy.
- Freestanding (starter) and add-on models are available. Legs and privacy panels are shared between adjoining add-on carrels.
- The back panel is inset to hide connecting fasteners from user's view. The inset back also creates a wire drop for the optional LED task light cord.
- Carrels with an optional shelf are available. See models ending in S.
- Optional LED task light is available for carrel with shelf, see page 419
- Optional Cove Daisylink system is available to bring power, USB charging or data to the carrel surface for desktop access, see pages 420-421

**SPECIFICATIONS**

- Specifications marked with an \* are applicable to only those products which have the\* symbol beside the product name.

**COVE DAISYLINK COMPONENTS**

- A daisy-chainable power solution with a unique "no particular order" feature, making installation or reconfiguration easy.
- Cove Daisylink modules must be ordered separately and are available for study carrels only.
- You must specify the cut-out for Cove Daisylink modules when ordering the study carrels. Specify (CV). Order the Cove kits (modules and jumpers) and infeed separately.
- 29", 30", 35" and 36" study carrels have **one** optional cut-out. **Add \$91.**
- 59", 60", 71" and 72" study carrels have **two** optional cut-outs. **Add \$185.**
- For Cove Daisylink components, see pages 420-421.
- Maximum of 9 Cove modules per each infeed.

**GROMMETS**

- Optional grommets are available in standard worksurface locations (left, center or right) **for teacher desks.**
- Order as: **FOG1, FOG2 or FOG3. Add \$91.**
- Grommet hole dimensions are 3.25" wide x 1.875" deep.

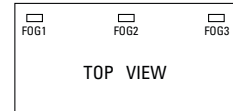

**POWER BLOCK**

- An individual corded power block is a rectangular worksurface power/data module with one electrical duplex receptacle and two data (RJ45) receptacles. 9' Black cord included. Power block dimensions are 6.5"W x 3.5"D x 2.75"H. Units cannot be daisy-chained.

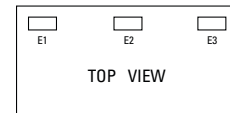

Power block **PMSPDM. Add \$268.** Specify location **E1, E2 or E3. Add \$91.**

**MODPOWER DAISY-CHAIN SOLUTION**

- Add flexible power and USB charging to Edventure study carrels. Connect up to four units with a single corded infeed with NEMA plug.
- ModPower units are sold separately, refer to Productivity Solutions page 471.
- Begin run with a starter unit which includes a corded infeed. Add additional middle or end units as required. Middle and end units are equipped with connecting cables.
- On-surface modules clamp on or screw mount to the table tops.
- In-surface modules require table top cut-outs for mounting:
  - Specify cut-out option **MPS** for a single cut-out to accommodate one ModPower in-surface unit (cut-out will be centered on the back edge of surface) for **29" to 72" wide study carrels. Add \$91.**
  - Specify cut-out option **MPD** for two cut-outs in the left and right positions, 15" from ends to center of unit on the back edge of surface for **59" to 72" wide study carrels. Add \$183.**



## FINISHES

### Thermally Fused or High Pressure Laminate Tops

|                            |                               |
|----------------------------|-------------------------------|
| <b>ACJ</b> Absolute Acajou | <b>FCL</b> First Class        |
| <b>ASN</b> Asian Night     | <b>NBL</b> Noce Biondo        |
| <b>AWC</b> Avant Cherry    | <b>NGL</b> Noce Grigio        |
| <b>AWH</b> Avant Honey     | <b>NEL</b> Noce Leggero       |
| <b>BLK</b> Black           | <b>NML</b> Noce Medio         |
| <b>BZD</b> Blizzard        | <b>QTM</b> Quartered Mahogany |
| <b>BRC</b> Brushed Cobalt  | <b>SBY</b> Sheer Beauty       |
| <b>CMB</b> Clear Maple     | <b>SDT</b> Stonedust          |
| <b>CGY</b> Custom Grey     | <b>SOG</b> Storm Grey         |
| <b>DES</b> Dark Espresso   | <b>WHE</b> Walnut Heights     |
| <b>DWT</b> Designer White  | <b>WHC</b> White Chocolate    |
| <b>FAS</b> Fashionista     | <b>WCR</b> Winter Cherry      |

### 2mm Thick Edgebanding

|                            |                             |
|----------------------------|-----------------------------|
| <b>AAE</b> Absolute Acajou | <b>FCL</b> First Class      |
| <b>ASE</b> Asian Night     | <b>FOG</b> Fog              |
| <b>ACE</b> Avant Cherry    | <b>LAB</b> Latte            |
| <b>AHE</b> Avant Honey     | <b>NBL</b> Noce Biondo      |
| <b>BLK</b> Black           | <b>NGL</b> Noce Grigio      |
| <b>BZD</b> Blizzard        | <b>NEL</b> Noce Leggero     |
| <b>BRC</b> Brushed Cobalt  | <b>NML</b> Noce Medio       |
| <b>BZB</b> Buzz Blue       | <b>QTM</b> Quarter Mahogany |
| <b>CCT</b> Cactus          | <b>SAR</b> Scarlet          |
| <b>CRO</b> Carrot          | <b>SHW</b> Shadow           |
| <b>CME</b> Clear Maple     | <b>SBY</b> Sheer Beauty     |
| <b>CGY</b> Custom Grey     | <b>SDT</b> Stonedust        |
| <b>DEE</b> Dark Espresso   | <b>SOG</b> Storm Grey       |
| <b>DWE</b> Designer White  | <b>WHE</b> Walnut Heights   |
| <b>DJN</b> Dijo            | <b>CBE</b> White Chocolate  |
| <b>FAS</b> Fashionista     | <b>WCE</b> Winter Cherry    |

### Leg finishes

|                           |                     |
|---------------------------|---------------------|
| <b>TBL</b> Black          | <b>TIN</b> Ink      |
| <b>TBZ</b> Buzz Blue      | <b>TKA</b> Kalua    |
| <b>TCC</b> Cactus         | <b>TLA</b> Latte    |
| <b>TCR</b> Carrot         | <b>TMO</b> Mocha    |
| <b>TIV</b> Cloud          | <b>TNE</b> Nevada   |
| <b>TDW</b> Designer White | <b>TSN</b> Sand     |
| <b>TDJ</b> Dijon          | <b>TSR</b> Scarlet  |
| <b>TEG</b> Eggplant       | <b>TSH</b> Shadow   |
| <b>TFO</b> Fog            | <b>TOA</b> Toast    |
| <b>TFR</b> Frost          | <b>TTU</b> Tungsten |

### Paint Finishes for Metal Storage Lecterns

|                            |  |
|----------------------------|--|
| <b>BLK</b> Black           | <b>MET</b> Metro                       |
| <b>BKC</b> Black Coffee*   | <b>MCH</b> Mocha*                      |
| <b>BZD</b> Blizzard*       | <b>MOS</b> Moss                        |
| <b>BNE</b> Bone            | <b>NAV</b> Navy                        |
| <b>BGR</b> Business Grey   | <b>NEV</b> Nevada                      |
| <b>CHR</b> Charcoal        | <b>OYS</b> Oyster                      |
| <b>CLT</b> Claret          | <b>SKY</b> Sky                         |
| <b>DCH</b> Dark Chocolate* | <b>SIL</b> Silver                      |
| <b>DPT</b> Desert Putty    | <b>STN</b> Stone                       |
| <b>DWT</b> Designer White  | <b>SDT</b> Stonedust*                  |
| <b>FOG</b> Fog             | <b>SGR</b> Storm Grey                  |
| <b>GRY</b> Grey            | <b>TSA</b> Tahiti Sand                 |
| <b>ICE</b> Ice             | <b>TPE</b> Taupe                       |
| <b>IVR</b> Ivory           | <b>TUN</b> Tungsten (add 10% upcharge) |
| <b>LGR</b> Light Grey      |  |

\*textured finishes

Note: Modesty panel are available in thermally fused laminate finishes only. Modesty panel and pedestal edging will match thermally fused laminate finish specified.

## TO SPECIFY:

### 1. SPECIFY MODEL NUMBER

### 2. SPECIFY THE FOLLOWING:

#### FOR TEACHER AND STUDENT DESKS:

- Top finish
- Optional HP laminate
- Edge finish (top only)
- Modesty finish if applicable
- Pedestal finish if applicable
- Leg finish
- Optional FOG grommet or cut-out for PMSDDM, if applicable
- Optional key alike or select number (#100-120) applicable on teacher desks with pedestal

#### FOR STUDY CARRELS:

- Top surface finish (shelf, if applicable, will be in the same finish)
- Optional HP laminate
- Edge finish
- Leg finish
- Surround finish (side and back panels)
- Optional cut-out(s) for Cove Daisylink components

### EXAMPLE EDVENTURE ORDER CODES:

#### Teacher desk

|          |            |                        |             |            |                      |
|----------|------------|------------------------|-------------|------------|----------------------|
| ENTD7230 | -ACJ       | -HPL                   | -AAE        | -TTU       | -DWT                 |
| Model #  | Top finish | High pressure laminate | Edge finish | Leg finish | Modesty panel finish |

#### Study carrel

|          |            |                        |                 |            |                 |                  |
|----------|------------|------------------------|-----------------|------------|-----------------|------------------|
| ENFC3024 | -ACJ       | -HPL                   | -AAE            | -TTU       | -DWT            | -CV              |
| Model #  | Top finish | High pressure laminate | Top edge finish | Leg finish | Surround finish | Cut-out for Cove |

**TEACHER DESKS**

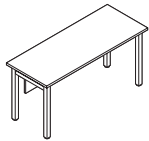

**Teacher Desk, 24" Deep\***

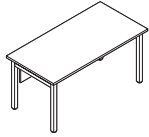

**Teacher Desk, 30" Deep\***

| MODEL #          | DIMENSIONS   | WT/LB. | CUBIC FT. | LIST PRICE   | HP ADD       |
|------------------|--------------|--------|-----------|--------------|--------------|
| <b>W x D x H</b> |              |        |           |              |              |
| ENTD4824         | 48 x 24 x 29 | 74     | 4.6       | <b>\$912</b> | <b>\$152</b> |
| ENTD5424         | 54 x 24 x 29 | 80     | 4.7       | <b>\$922</b> | <b>\$173</b> |
| ENTD6024         | 60 x 24 x 29 | 86     | 4.9       | <b>\$935</b> | <b>\$186</b> |

12"H modesty panel included. Shipped easy to assemble in 2 cartons.

|          |              |     |     |               |              |
|----------|--------------|-----|-----|---------------|--------------|
| ENTD6030 | 60 x 30 x 29 | 96  | 6.4 | <b>\$993</b>  | <b>\$202</b> |
| ENTD6630 | 66 x 30 x 29 | 103 | 6.6 | <b>\$1032</b> | <b>\$249</b> |
| ENTD7230 | 72 x 30 x 29 | 110 | 6.8 | <b>\$1064</b> | <b>\$263</b> |

12"H modesty panel included. Shipped easy to assemble in 2 cartons.

**MOBILE TEACHER DESKS**

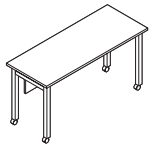

**Mobile Teacher Desk, 24" Deep\***

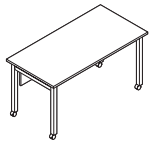

**Mobile Teacher Desk, 30" Deep\***

|           |              |    |     |               |              |
|-----------|--------------|----|-----|---------------|--------------|
| ENTD4824C | 48 x 24 x 29 | 75 | 4.6 | <b>\$1059</b> | <b>\$152</b> |
| ENTD5424C | 54 x 24 x 29 | 81 | 4.7 | <b>\$1069</b> | <b>\$173</b> |
| ENTD6024C | 60 x 24 x 29 | 87 | 4.9 | <b>\$1082</b> | <b>\$186</b> |

12"H modesty panel included. Shipped easy to assemble in 2 cartons.

|           |              |    |     |               |              |
|-----------|--------------|----|-----|---------------|--------------|
| ENTD6030C | 60 x 30 x 29 | 98 | 5.4 | <b>\$1142</b> | <b>\$202</b> |
|-----------|--------------|----|-----|---------------|--------------|

12"H modesty panel included. Shipped easy to assemble in 2 cartons.

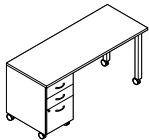

**Mobile Teacher Desk w/Single Pedestal, 24" Deep - LEFT\***

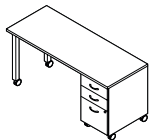

**Mobile Teacher Desk w/Single Pedestal, 24" Deep - RIGHT\***

|             |              |     |      |               |              |
|-------------|--------------|-----|------|---------------|--------------|
| ET6024BBFLC | 60 x 24 x 29 | 155 | 12.4 | <b>\$1872</b> | <b>\$186</b> |
| ET6624BBFLC | 66 x 24 x 29 | 161 | 12.6 | <b>\$1909</b> | <b>\$215</b> |
| ET7224BBFLC | 72 x 24 x 29 | 167 | 12.8 | <b>\$1943</b> | <b>\$244</b> |

Flush **left** hand locking box/box/file pedestal (top box drawer is non-locking) and 12"H modesty panel included. Shipped easy to assemble in 3 cartons (pedestal is fully assembled).

|             |              |     |      |               |              |
|-------------|--------------|-----|------|---------------|--------------|
| ET6024BBFRC | 60 x 24 x 29 | 155 | 12.4 | <b>\$1872</b> | <b>\$186</b> |
| ET6624BBFRC | 66 x 24 x 29 | 161 | 12.6 | <b>\$1909</b> | <b>\$215</b> |
| ET7224BBFRC | 72 x 24 x 29 | 167 | 12.8 | <b>\$1943</b> | <b>\$244</b> |

Flush **right** hand locking box/box/file pedestal (top box drawer is non-locking) and 12"H modesty panel included. Shipped easy to assemble in 3 cartons (pedestal is fully assembled).

**Required specifications**

Top finish Modesty finish  
Leg finish Pedestal finish\*  
Edge finish

**Optional specifications**

HP laminate  
FOG grommet or cut-out for PMSPDM  
Key alike/Key #\*

**Accessories**

Lectern shelf\*

## MOBILE TEACHER DESKS

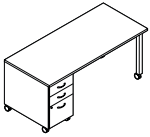

**Mobile Teacher Desk w/Single Pedestal, 30" Deep - LEFT\***

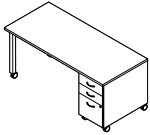

**Mobile Teacher Desk w/Single Pedestal, 30" Deep - RIGHT\***

| MODEL #     | DIMENSIONS<br>W x D x H | WT/LB. | CUBIC FT. | LIST PRICE    | HP ADD       |
|-------------|-------------------------|--------|-----------|---------------|--------------|
| ET6030BBFLC | 60 x 30 x 29            | 193    | 14.7      | <b>\$1980</b> | <b>\$202</b> |
| ET6630BBFLC | 66 x 30 x 29            | 201    | 14.9      | <b>\$2017</b> | <b>\$249</b> |
| ET7230BBFLC | 72 x 30 x 29            | 210    | 15.1      | <b>\$2050</b> | <b>\$263</b> |

Flush **left** hand locking box/box/file pedestal (top box drawer is non-locking) and 12"H modesty panel included. Shipped easy to assemble in 3 cartons (pedestal is fully assembled).

|             |              |     |      |               |              |
|-------------|--------------|-----|------|---------------|--------------|
| ET6030BBFRC | 60 x 30 x 29 | 193 | 14.7 | <b>\$1980</b> | <b>\$202</b> |
| ET6630BBFRC | 66 x 30 x 29 | 201 | 14.9 | <b>\$2017</b> | <b>\$249</b> |
| ET7230BBFRC | 72 x 30 x 29 | 210 | 15.1 | <b>\$2050</b> | <b>\$263</b> |

Flush **right** hand locking box/box/file pedestal (top box drawer is non-locking) and 12"H modesty panel included. Shipped easy to assemble in 3 cartons (pedestal is fully assembled).

## STUDENT DESKS

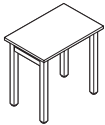

**Student Desk\*\***

|          |              |    |     |              |              |
|----------|--------------|----|-----|--------------|--------------|
| ENST3020 | 30 x 20 x 29 | 49 | 3.9 | <b>\$461</b> | <b>\$106</b> |
|----------|--------------|----|-----|--------------|--------------|

Shipped easy to assemble in 2 cartons.

### Required specifications

Top finish      Modesty finish\*  
 Leg finish      Pedestal finish\*

### Optional specifications

HP laminate (teacher and student desks)  
 FOG grommet or cut-out for PMSPDM\*  
 Key alike/Key #\*

### Accessories

Lectern shelf\*  
 Book box\*\*

**FREESTANDING OR STARTER STUDY CARRELS**

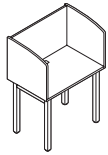

**Freestanding/Starter Study Carrel\***

| MODEL #  | DIMENSIONS<br>W x D x H | WT/LB. | CUBIC FT. | LIST PRICE    | HP ADD       | CUT-OUT ADD  |
|----------|-------------------------|--------|-----------|---------------|--------------|--------------|
| ENFC3024 | 30 x 24 x 50            | 89     | 4.44      | <b>\$890</b>  | <b>\$107</b> | <b>\$91</b>  |
| ENFC3624 | 36 x 24 x 50            | 97.5   | 4.72      | <b>\$942</b>  | <b>\$107</b> | <b>\$91</b>  |
| ENFC6024 | 60 x 24 x 50            | 115    | 5.8       | <b>\$1097</b> | <b>\$186</b> | <b>\$185</b> |
| ENFC7224 | 72 x 24 x 50            | 123.5  | 6.34      | <b>\$1172</b> | <b>\$213</b> | <b>\$185</b> |

Features a 29" high worksurface with curved side privacy panels. Shown with optional cut-out. Bring power and USB charging to the user with Cove Daisylink components, see pages 420-421. Shipped easy to assemble in 2 cartons.

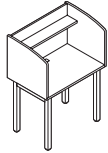

**Freestanding/Starter Study Carrel w/Shelf\***

|           |              |       |      |               |              |              |
|-----------|--------------|-------|------|---------------|--------------|--------------|
| ENFC3024S | 30 x 24 x 50 | 93    | 4.44 | <b>\$947</b>  | <b>\$107</b> | <b>\$91</b>  |
| ENFC3624S | 36 x 24 x 50 | 102.5 | 4.72 | <b>\$991</b>  | <b>\$107</b> | <b>\$91</b>  |
| ENFC6024S | 60 x 24 x 50 | 122   | 5.8  | <b>\$1175</b> | <b>\$186</b> | <b>\$185</b> |
| ENFC7224S | 72 x 24 x 50 | 131.5 | 6.34 | <b>\$1261</b> | <b>\$186</b> | <b>\$185</b> |

Features a 29" high worksurface with curved side privacy panels. Shown with optional cut-out. Shelf is 6" deep and accepts optional LED task light. Bring power and USB charging to the user with Cove Daisylink components, see pages 420-421. Shipped easy to assemble in 2 cartons.

**ADD-ON STUDY CARRELS**

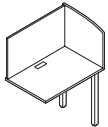

**Add-On Study Carrel\***

|          |              |      |      |              |              |              |
|----------|--------------|------|------|--------------|--------------|--------------|
| ENAC2924 | 29 x 24 x 50 | 63   | 4.4  | <b>\$677</b> | <b>\$107</b> | <b>\$91</b>  |
| ENAC3524 | 35 x 24 x 50 | 71.5 | 4.67 | <b>\$704</b> | <b>\$122</b> | <b>\$91</b>  |
| ENAC5924 | 59 x 24 x 50 | 89   | 5.75 | <b>\$865</b> | <b>\$186</b> | <b>\$185</b> |
| ENAC7124 | 71 x 24 x 50 | 97.5 | 6.3  | <b>\$939</b> | <b>\$186</b> | <b>\$185</b> |

Features a 29" high worksurface with curved side privacy panels. Shown with optional cut-out. Bring power and USB charging to the user with Cove Daisylink components, see pages 420-421. Shipped easy to assemble in 2 cartons.

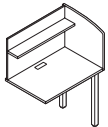

**Add-On Study Carrel w/Shelf\***

|           |              |       |      |               |              |              |
|-----------|--------------|-------|------|---------------|--------------|--------------|
| ENAC2924S | 29 x 24 x 50 | 67    | 4.4  | <b>\$710</b>  | <b>\$107</b> | <b>\$91</b>  |
| ENAC3524S | 35 x 24 x 50 | 76.5  | 4.67 | <b>\$755</b>  | <b>\$107</b> | <b>\$91</b>  |
| ENAC5924S | 59 x 24 x 50 | 96    | 5.75 | <b>\$944</b>  | <b>\$186</b> | <b>\$185</b> |
| ENAC7124S | 71 x 24 x 50 | 105.5 | 6.3  | <b>\$1029</b> | <b>\$186</b> | <b>\$185</b> |

Features a 29" high worksurface with curved side privacy panels. Shown with optional cut-out. Shelf is 6" deep and accepts optional LED task light. Bring power and USB charging to the user with Cove Daisylink components, see pages 420-421. Shipped easy to assemble in 2 cartons.

**LED TASK LIGHTS**

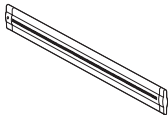

**LED Task Light**

|         |                  |   |     |              |     |     |
|---------|------------------|---|-----|--------------|-----|-----|
| PLED30  | 15.5 x 1.5 x 0.5 | 2 | 0.5 | <b>\$344</b> | N/A | N/A |
| PLED100 | 43.5 x 1.5 x 0.5 | 3 | 0.5 | <b>\$461</b> | N/A | N/A |

Energy efficient LED. Ultra slim design. Suitable for mounting on the underside of the shelf of a study carrel. 6' power cord.

**Required specifications**

- Top finish\*
- Edge finish\*
- Leg finish\*
- Surround finish\*

**Optional specifications**

- HP laminate\*
- Cut-out for Cove Daisylink modules\*

**Accessories**

- Cove Daisylink modules\*
- LED task lights\*

## COVE DAISYLINK COMPONENTS

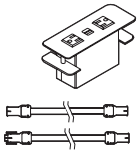

### Single Power/USB for 29"/30" Carrels

| MODEL #   | DIMENSIONS<br>W x D x H | WT/LB. | CUBIC FT. | LIST PRICE    |
|-----------|-------------------------|--------|-----------|---------------|
| ECV2PU30B | 30 x 2 x -              | 4.5    | 0.5       | <b>\$1010</b> |
| ECV2PU30S | 30 x 2 x -              | 4.5    | 0.5       | <b>\$1010</b> |

Cove single desktop module with two power outlets and two 2.1A USB charging ports. Includes four cable clamps, one 14" female/male connecting cable and one 14" female/female connecting cable. Connecting cables will daisy-chain modules between two 30" wide starter carrels, one 30" wide starter carrel and one 29" wide add-on carrel, or two 29" wide add-on carrels. Available in Black (**B**) or Silver (**S**) - indicated by last letter of the model number. Infeed to be ordered separately.

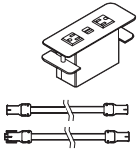

### Single Power/USB for 35"/36" Carrels

|           |            |     |     |               |
|-----------|------------|-----|-----|---------------|
| ECV2PU36B | 36 x 2 x - | 4.6 | 0.5 | <b>\$1022</b> |
| ECV2PU36S | 36 x 2 x - | 4.6 | 0.5 | <b>\$1022</b> |

Cove single desktop module includes two power outlets and two 2.1A USB charging ports. Includes four cable clamps, one 17" female/male connecting cable and one 17" female/female connecting cable. Connecting cables will daisy-chain modules between two 36" wide starter carrels, one 36" wide starter carrel and one 35" wide add-on carrel, or two 35" wide add-on carrels. Available in Black (**B**) or Silver (**S**) - indicated by last letter of the model number. Infeed to be ordered separately.

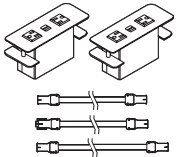

### Double Power/USB for 59"/60" Carrels

|           |            |     |     |               |
|-----------|------------|-----|-----|---------------|
| ECV2PU60B | 60 x 2 x - | 4.6 | 0.5 | <b>\$1880</b> |
| ECV2PU60S | 60 x 2 x - | 4.6 | 0.5 | <b>\$1880</b> |

Cove double desktop modules - each module includes two power outlets and two 2.1A USB charging ports. Includes four cable clamps, one 12" female/male connecting cable, one 12" female/female connecting cable and one 26" female/female interconnecting cable. Connecting cables will daisy-chain modules between two 60" wide starter carrels, one 60" wide starter carrel and one 59" wide add-on carrel, or two 59" wide add-on carrels. Available in Black (**B**) or Silver (**S**) - indicated by last letter of the model number.

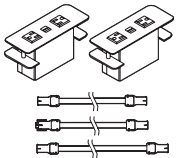

### Double Power/USB for 71"/72" Carrels

|           |            |     |     |               |
|-----------|------------|-----|-----|---------------|
| ECV2PU72B | 72 x 2 x - | 4.6 | 0.5 | <b>\$1901</b> |
| ECV2PU72S | 72 x 2 x - | 4.6 | 0.5 | <b>\$1901</b> |

Cove double desktop modules - each module includes two power outlets and two 2.1A USB charging ports. Includes four cable clamps, one 15" female/male connecting cable, one 15" female/female connecting cable and one 31" female/female interconnecting cable. Connecting cables will daisy-chain modules between two 72" wide starter carrels, one 72" wide starter carrel and one 71" wide add-on carrel, or two 71" wide add-on carrels. Available in Black (**B**) or Silver (**S**) - indicated by last letter of the model number.

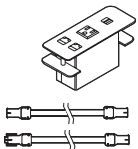

### Single Power/Data/USB for 29"/30" Carrels

|           |            |     |     |              |
|-----------|------------|-----|-----|--------------|
| ECVPUD30B | 30 x 2 x - | 4.6 | 0.5 | <b>\$955</b> |
| ECVPUD30S | 30 x 2 x - | 4.6 | 0.5 | <b>\$955</b> |

Cove single desktop module includes one power outlet, two data knockouts and two 2.1A USB charging ports. Includes four cable clamps, one 14" female/male connecting cable and one 14" female/female connecting cable. Data/telecom options to be ordered separately. Connecting cables will daisy-chain modules between two 30" wide starter carrels, one 30" wide starter carrel and one 29" wide add-on carrel, or two 29" wide add-on carrels. Available in Black (**B**) or Silver (**S**) - indicated by last letter of the model number. Infeed to be ordered separately.

**COVE DAISYLINK COMPONENTS**      **MODEL #**      **DIMENSIONS**      **WT/LB.**      **CUBIC FT.**      **LIST PRICE**

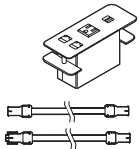

**Single Power/Data/USB for 35"/36" Carrels**

|           | W x D x H  |     |     |              |
|-----------|------------|-----|-----|--------------|
| ECVPUD36B | 36 x 2 x - | 4.6 | 0.5 | <b>\$967</b> |
| ECVPUD36S | 36 x 2 x - | 4.6 | 0.5 | <b>\$967</b> |

Cove single desktop module includes one power outlet, two data knockouts and two 2.1A USB charging ports. Includes four cable clamps, one 17" female/male connecting cable and one 17" female/female connecting cable. Data/telecom options to be ordered separately. Connecting cables will daisy-chain modules between two 36" wide starter carrels, one 36" wide starter carrel and one 35" wide add-on carrel, or two 35" wide add-on carrels. Available in Black (B) or Silver (S) - indicated by last letter of the model number. Infeed to be ordered separately.

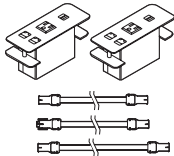

**Double Power/Data/USB for 59"/60" Carrels**

|           |            |     |     |               |
|-----------|------------|-----|-----|---------------|
| ECVPUD60B | 60 x 2 x - | 4.6 | 0.5 | <b>\$1769</b> |
| ECVPUD60S | 60 x 2 x - | 4.6 | 0.5 | <b>\$1769</b> |

Cove double desktop modules - each module includes one power outlet, two data knockouts and two 2.1A USB charging ports. Includes four cable clamps, one 12" female/male connecting cable, one 12" female/female connecting cable and one 26" female/female interconnecting cable. Data/telecom options to be ordered separately. Connecting cables will daisy-chain modules between two 60" wide starter carrels, one 60" wide starter carrel and one 59" wide add-on carrel, or two 59" wide add-on carrels. Available in Black (B) or Silver (S) - indicated by last letter of the model number. Infeed to be ordered separately.

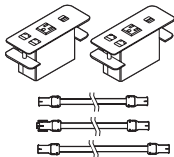

**Double Power/Data/USB for 71"/72" Carrels**

|           |            |     |     |               |
|-----------|------------|-----|-----|---------------|
| ECVPUD72B | 72 x 2 x - | 4.6 | 0.5 | <b>\$1790</b> |
| ECVPUD72S | 72 x 2 x - | 4.6 | 0.5 | <b>\$1790</b> |

Cove double desktop modules - each module includes one power outlet, two data knockouts and two 2.1A USB charging ports. Includes four cable clamps, one 15" female/male connecting cable, one 15" female/female connecting cable and one 31" female/female interconnecting cable. Data/telecom options to be ordered separately. Connecting cables will daisy-chain modules between two 72" wide starter carrels, one 72" wide starter carrel and one 71" wide add-on carrel, or two 71" wide add-on carrels. Available in Black (B) or Silver (S) - indicated by last letter of the model number. Infeed to be ordered separately.



**Single-Circuit Corded Infeed, 72"**

|         |      |   |     |              |
|---------|------|---|-----|--------------|
| ENCOVC1 | 72"W | 3 | 0.5 | <b>\$369</b> |
|---------|------|---|-----|--------------|

72" corded infeed to start a run of Cove Daisylink modules. Maximum of 9 Cove modules per each infeed (Cove double counts as two modules).



**Multi-Circuit Power Hardware Infeed, 72"**

|          |      |      |     |              |
|----------|------|------|-----|--------------|
| ENCOVHW1 | 72"W | 2.75 | 0.5 | <b>\$238</b> |
|----------|------|------|-----|--------------|

Hardware infeed to start a run of Cove Daisylink modules. Maximum of 9 Cove modules per each infeed (Cove double counts as two modules). Certified electrician required for installation.

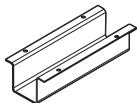

**Jumper Guards - Set of 4**

|         |              |    |     |              |
|---------|--------------|----|-----|--------------|
| ENCVG12 | 12 x 5 x 3.1 | 14 | 1.1 | <b>\$143</b> |
|---------|--------------|----|-----|--------------|

Metal channel to protect jumper connection to Cove Daisylink module. Black only. Mounts directly to the underside of surface.



Designed by Zoey Chu, Junction provides an affordable solution for your table applications. Choose from a variety of table top designs: rectangular, half round, trapezoid and keystone to create a unique table for your boardroom, classroom or presentation room application.

A freestanding or shared leg configuration with the unique “Y” leg allows you to either create a permanent table or one that can be reconfigured quickly and easily. A straight leg is available for use with half round and keystone tops.

Shared leg configurations allow more legroom and can also decrease cost because they use fewer components. Freestanding configurations provide more flexibility for changing environments.

**Features and Benefits**

- Tops are 1” thick and constructed of 45 lb. density particle board.
- 2mm matching edge is standard.
- Optional radius corners (**RM**) available at no upcharge.
- Optional modesty panel with integrated wire trough available.
- Casters available with or without manual locks provide mobility.
- Black grommets for convenient wire management can be ordered factory installed.
- Optional, easy-to-use thumbscrews allow installation without tools.
- Junction tops are available in Global laminate finishes with two leg options.



Y leg design.



Modesty panel.



Shared leg configuration provides more legroom and decreases the overall costs.

## GENERAL INFORMATION

- Junction is a series of multi-purpose tables for classroom, training room and boardroom applications.
- Ability for tables to be set up as freestanding or shared leg configuration.
- Unique design by Zooey Chu.
- Half round, trapezoid and keystone tops are available to create a variety of package configurations.
- Rectangular tops are available in 20", 24" and 30" depths.
- Optional modesty panels with integrated wire troughs are available.
- Optional large electrical manager provides a safe environment for equipment wires.
- Special width tops are available. Use next size up.
- Shipped easy to assemble. Each component is packaged individually; legs are shipped 1 per carton.
- For environmental certifications, please visit [globalfurnituregroup.com](http://globalfurnituregroup.com).

## WORKSURFACES

- Tops are 1" thick, made of 45 lb. density particle board covered on both sides with high performance thermally fused melamine.
- Laminate finishes are available in high pressure. Contact your Customer Service representative for a quote.
- If other than a Global standard laminate finish is preferred, contact your Customer Service representative. Information needed includes the name of the laminate manufacturer, color name, number and model of table. You will then be given a quote for this special order.

## CONSTRUCTION

- Rectangular tops 54" in length and longer include a steel support channel for structural rigidity.
- Tops are predrilled with threaded steel inserts.
- Special width tops are available. Use next size up (add 10% upcharge).
- Adjustable levelers offer up to 1" adjustability.

## EDGE DETAIL

- Global's preferred matching edge is standard.
- Optional radius corners (**RM**) are available on rectangular tops at no upcharge.

## LEGS

- Unique Y design.
- Straight leg available for assembly with half round tops and keystone tops.
- Heavy duty steel construction.
- Coated with environmentally friendly recycled paint that provides a durable finish.
- Black plastic leveling glides offer  $\frac{5}{8}$ " adjustability.
- Available in Black (**TBL**), Cloud (**TIV**), Designer White (**TDW**), Fog (**TFO**), Frost (**TFR**), Kalua (**TKA**), Latte (**TLA**), Mocha (**TMO**), Nevada (**TNE**), Sand (**TSN**), Shadow (**TSH**), Toast (**TOA**) or Tungsten (**TTU**) finish.
- Y legs: 17.5" leg span - 20"D top, 21.5" leg span - 24"D top, 24.5" leg span - 30"D top.

## CASTERS

- Optional casters are available.
- 1.5" dual wheel casters with or without manual lock. Full 360° swivel.
- Can be used in any combination with or without standard glides.
- Suggested for carpeted surfaces.
- Available in Black only.
- Sold in packages of two.

## GANGING

- Ganging plates are available for ganging workstations together.
- Ganging plates are Black epoxy coated steel plates with two thumbscrews.
- Provides maximum stability and torque reduction.

## FLUSH PLATE

- Suggested for top clusters (fixed configurations for additional stability).
- Sold individually and shipped with two thumbscrews for mounting.
- No tools required.
- Flush plate allows for ganging together of two or more tops.

## WIRE MANAGEMENT

- Available for managing additional larger wires and power connectors.
- 3.5" high x 4.25" deep Black PVC channel attaches to the underside of top.

## SPECIFICATIONS

- Specifications marked with an \* are applicable to only those products which have the\* symbol beside the product name.



## 1. SPECIFY MODEL NUMBER

## 2. SPECIFY FINISH

### Laminate Finishes:

|                            |                               |
|----------------------------|-------------------------------|
| <b>ACJ</b> Absolute Acajou | <b>FCL</b> First Class        |
| <b>ASN</b> Asian Night     | <b>NBL</b> Noce Biondo        |
| <b>AWC</b> Avant Cherry    | <b>NGL</b> Noce Grigio        |
| <b>AWH</b> Avant Honey     | <b>NEL</b> Noce Leggero       |
| <b>BLK</b> Black           | <b>NML</b> Noce Medio         |
| <b>BZD</b> Blizzard        | <b>QTM</b> Quartered Mahogany |
| <b>BRC</b> Brushed Cobalt  | <b>SBY</b> Sheer Beauty       |
| <b>CMB</b> Clear Maple     | <b>SDT</b> Stonedust          |
| <b>CGY</b> Custom Grey     | <b>SOG</b> Storm Grey         |
| <b>DES</b> Dark Espresso   | <b>WHE</b> Walnut Heights     |
| <b>DWT</b> Designer White  | <b>WHC</b> White Chocolate    |
| <b>FAS</b> Fashionista     | <b>WCR</b> Winter Cherry      |

### Legs:

|                           |                     |
|---------------------------|---------------------|
| <b>TBL</b> Black          | <b>TMO</b> Mocha    |
| <b>TIV</b> Cloud          | <b>TNE</b> Nevada   |
| <b>TDW</b> Designer White | <b>TSN</b> Sand     |
| <b>TFO</b> Fog            | <b>TSH</b> Shadow   |
| <b>TFR</b> Frost          | <b>TOA</b> Toast    |
| <b>TKA</b> Kalua          | <b>TTU</b> Tungsten |
| <b>TLA</b> Latte          |                     |

## 3. SPECIFY OPTIONS

### MODESTY PANELS

- 11.25" high panel attaches to the underside of worksurface top.
- Standard with integrated wire trough.
- Available in Black PVC.

### GROMMETS

- Grommets are available in **rectangular and trapezoid** tops (left, center or right). See below for available locations. Order as: **FOG1, FOG2** or **FOG3**. Add \$91. For **keystone** worksurface locations, order as **FOG2**. Add \$91.
- Grommet hole dimensions are 3.25" wide x 1.875" deep.

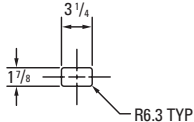

- Grommets may be placed at non-standard locations. Order as: **CSG**. Add \$132. A drawing must be supplied with vertical and horizontal dimensions to the center of the cut-out (as in drawing above). Please refer to the **custom grommet location form** in the back reference section.

### POWER BLOCK

- A power block (model **PMSPDM**) may be ordered on all worksurfaces.
- A power block is a rectangular worksurface power/data module with one electrical duplex receptacle and two data (RJ45) receptacles. 9' Black cord included. Power block dimensions are 6.5"W x 3.5"D x 2.75"H.
- To purchase a power block, you must specify both the power block cut-out location and the power block model #. Order power block as **PMSPDM**. Add \$268. Power blocks are available in standard worksurface locations (left, center or right). Order as **E1, E2** or **E3**. Add \$91.

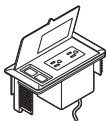

Power block **PMSPDM**. Add \$268.

### EXAMPLES OF GROMMET AND POWER BLOCK POSITIONS

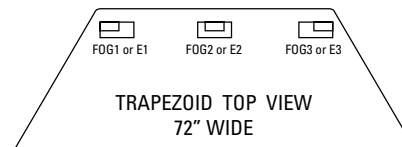
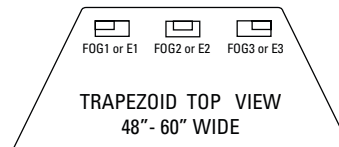
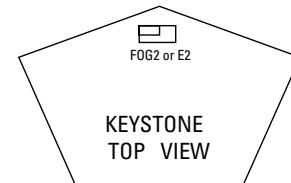
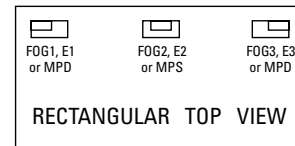

### MODPOWER DAISY CHAIN SOLUTION

- Add flexible power and USB charging to Junction **rectangular tables** only. Connect up to four units with a single corded infeed with NEMA plug.
- ModPower units are sold separately, refer to Productivity Solutions page 471.
- Begin run with a starter unit which includes a corded infeed. Add additional middle or end units as required. Middle and end units are equipped with connecting cables.
- On-surface modules clamp on or screw mount to the table tops.
- In-surface modules require table top cut-outs for mounting (cannot be used with modesties). Specify cut-out option:
  - **MPS** for a single cut-out to accommodate one ModPower in-surface unit (cut-out will be centered on the approach side) for **30" to 72" wide rectangular tables**. Add \$91.
  - **MPD** for two cut-outs in the left and right positions, 15" from ends to center of unit on approach side for 60", 66" and 72" wide rectangular tables. Add \$183.

**RECTANGULAR TOPS**      **MODEL #**      **DIMENSIONS**      **WT/LB.**      **CUBIC FT.**      **LIST PRICE**      **HP ADD**

W x D x H

|          |             |    |      |              |                 |  |
|----------|-------------|----|------|--------------|-----------------|--|
| JNR2042  | 42 x 20 x 1 | 26 | 1.1  | <b>\$190</b> | <b>\$95</b>     |  |
| JNR2048  | 48 x 20 x 1 | 29 | 1.15 | <b>\$199</b> | <b>\$99.50</b>  |  |
| JNRU2054 | 54 x 20 x 1 | 33 | 1.3  | <b>\$279</b> | <b>\$139.50</b> |  |
| JNRU2060 | 60 x 20 x 1 | 37 | 1.4  | <b>\$295</b> | <b>\$147.50</b> |  |
| JNRU2066 | 66 x 20 x 1 | 41 | 1.55 | <b>\$320</b> | <b>\$160</b>    |  |
| JNRU2072 | 72 x 20 x 1 | 45 | 1.66 | <b>\$344</b> | <b>\$172</b>    |  |
|          |             |    |      |              |                 |  |
| JNR2442  | 42 x 24 x 1 | 31 | 1.25 | <b>\$210</b> | <b>\$105</b>    |  |
| JNR2448  | 48 x 24 x 1 | 35 | 1.4  | <b>\$227</b> | <b>\$113.50</b> |  |
| JNRU2454 | 54 x 24 x 1 | 42 | 1.52 | <b>\$317</b> | <b>\$158.50</b> |  |
| JNRU2460 | 60 x 24 x 1 | 47 | 1.67 | <b>\$337</b> | <b>\$168.50</b> |  |
| JNRU2466 | 66 x 24 x 1 | 52 | 1.82 | <b>\$365</b> | <b>\$182.50</b> |  |
| JNRU2472 | 72 x 24 x 1 | 57 | 2    | <b>\$390</b> | <b>\$195</b>    |  |
|          |             |    |      |              |                 |  |
| JNR3042  | 42 x 30 x 1 | 38 | 1.51 | <b>\$248</b> | <b>\$124</b>    |  |
| JNR3048  | 48 x 30 x 1 | 44 | 1.7  | <b>\$270</b> | <b>\$135</b>    |  |
| JNRU3054 | 54 x 30 x 1 | 52 | 1.9  | <b>\$362</b> | <b>\$181</b>    |  |
| JNRU3060 | 60 x 30 x 1 | 59 | 2.1  | <b>\$386</b> | <b>\$193</b>    |  |
| JNRU3066 | 66 x 30 x 1 | 64 | 2.26 | <b>\$415</b> | <b>\$207.50</b> |  |
| JNRU3072 | 72 x 30 x 1 | 70 | 2.5  | <b>\$442</b> | <b>\$221</b>    |  |

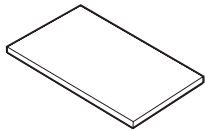

**Rectangular Top\***

Predrilled with threaded steel inserts for freestanding and linking installations. **Tops 54" and longer are standard with a 16 gauge steel support channel.**

**HALF ROUND TOPS**

|           |             |       |      |              |                 |
|-----------|-------------|-------|------|--------------|-----------------|
| JNHFS2040 | 40 x 20 x 1 | 23    | 1.05 | <b>\$227</b> | <b>\$113.50</b> |
| JNHFS2048 | 48 x 20 x 1 | 27.5  | 1.15 | <b>\$236</b> | <b>\$118</b>    |
|           |             |       |      |              |                 |
| JNHFS2448 | 48 x 24 x 1 | 34    | 1.4  | <b>\$250</b> | <b>\$125</b>    |
| JNHFS2454 | 54 x 27 x 1 | 38.25 | 1.52 | <b>\$315</b> | <b>\$157.50</b> |
|           |             |       |      |              |                 |
| JNHFS3060 | 60 x 30 x 1 | 53    | 1.67 | <b>\$335</b> | <b>\$167.50</b> |
| JNHFS3066 | 66 x 33 x 1 | 58.3  | 1.82 | <b>\$431</b> | <b>\$215.50</b> |

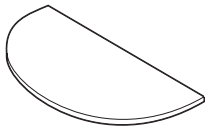

**Half Round Top**

Predrilled with threaded steel inserts for freestanding and linking installations. Four legs are required for freestanding configurations.

- **JNHFS2040/JNHFS2048** for use with 20" deep joining edge.
- **JNHFS2448/JNHFS2454** for use with 24" deep joining edge.
- **JNHFS3060/JNHFS3066** for use with 30" deep joining edge.

**TRAPEZOID TOPS**

|          |                |       |      |              |                 |
|----------|----------------|-------|------|--------------|-----------------|
| JNTT2048 | 48 x 15.25 x 1 | 27.5  | 1.15 | <b>\$222</b> | <b>\$111</b>    |
| JNTT2060 | 60 x 15.25 x 1 | 34    | 1.4  | <b>\$265</b> | <b>\$132.50</b> |
|          |                |       |      |              |                 |
| JNTT2448 | 48 x 20.5 x 1  | 33    | 1.4  | <b>\$239</b> | <b>\$119.50</b> |
| JNTT2460 | 60 x 20.5 x 1  | 41.25 | 1.67 | <b>\$290</b> | <b>\$145</b>    |
|          |                |       |      |              |                 |
| JNTT3060 | 60 x 25.75 x 1 | 50.5  | 2.1  | <b>\$314</b> | <b>\$157</b>    |
| JNTT3072 | 72 x 25.75 x 1 | 61    | 2.5  | <b>\$358</b> | <b>\$179</b>    |

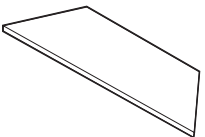

**Trapezoid Top**

Predrilled with threaded steel inserts for freestanding and linking installations.

- **JNTT2040/JNTT2048** for use with 20" deep joining edge.
- **JNTT2448/JNTT2454** for use with 24" deep joining edge.
- **JNTT3060/JNTT3066** for use with 30" deep joining edge.

**Required specifications**  
Finish

**Optional specifications**  
Grommet\*

**Accessories**  
Power block\*

## KEYSTONE TOPS

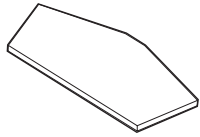

**Keystone Tops**

| MODEL #  | DIMENSIONS<br>W x D x H | WT/LB. | CUBIC FT. | LIST PRICE   | HD ADD          |
|----------|-------------------------|--------|-----------|--------------|-----------------|
| JN5S2424 | 42 x 24 x 1             | 35     | 1.4       | <b>\$270</b> | <b>\$135</b>    |
| JN5S3030 | 54 x 30 x 1             | 53     | 2.1       | <b>\$345</b> | <b>\$172.50</b> |

Predrilled with threaded steel inserts for linking installations. Keystone shape is for V configurations/shared leg applications only, not intended for freestanding applications.

- **JN5S2424** for use with 24" deep joining edge.
- **JN5S3030** for use with 30" deep joining edge.

## MODESTY PANELS

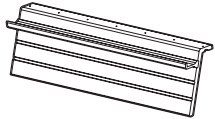

**Modesty Panel**

|        |                      |     |      |              |     |
|--------|----------------------|-----|------|--------------|-----|
| JNMP42 | 29.19 x 6.92 x 11.25 | 3.7 | 1.5  | <b>\$186</b> | N/A |
| JNMP48 | 35.19 x 6.92 x 11.25 | 4.5 | 1.75 | <b>\$210</b> | N/A |
| JNMP54 | 41.19 x 6.92 x 11.25 | 5   | 2    | <b>\$234</b> | N/A |
| JNMP60 | 47.19 x 6.92 x 11.25 | 5.9 | 2.25 | <b>\$260</b> | N/A |
| JNMP66 | 53.19 x 6.92 x 11.25 | 6.6 | 2.5  | <b>\$274</b> | N/A |
| JNMP72 | 59.19 x 6.92 x 11.25 | 7.4 | 2.75 | <b>\$300</b> | N/A |

For use with **JNR rectangular tops**. 11.25" high, Black plastic, attractive ribbed design. Includes integrated wire trough. Connects to predrilled holes in table top.

## WIRE MANAGEMENT



**Wire Manager**

|        |                    |   |     |             |     |
|--------|--------------------|---|-----|-------------|-----|
| JNEC5S | 12.5 x 4.14 x 3.63 | 1 | 0.1 | <b>\$46</b> | N/A |
|--------|--------------------|---|-----|-------------|-----|

For use with **JN5S keystone**. For managing additional wires and power connectors. 3.5" high Black PVC channel connects to predrilled holes in table top.



**Wire Manager**

|        |                     |      |      |              |     |
|--------|---------------------|------|------|--------------|-----|
| JNEC42 | 41.75 x 4.14 x 3.63 | 2.52 | 0.33 | <b>\$117</b> | N/A |
| JNEC48 | 47.75 x 4.14 x 3.63 | 2.88 | 0.38 | <b>\$139</b> | N/A |
| JNEC54 | 53.75 x 4.14 x 3.63 | 3.24 | 0.43 | <b>\$153</b> | N/A |
| JNEC60 | 59.75 x 4.14 x 3.63 | 3.6  | 0.48 | <b>\$172</b> | N/A |
| JNEC66 | 65.75 x 4.14 x 3.63 | 3.96 | 0.53 | <b>\$172</b> | N/A |
| JNEC72 | 71.75 x 4.14 x 3.63 | 4.32 | 0.58 | <b>\$234</b> | N/A |

For use with **JNR rectangular tops**. For managing additional wires and power connectors. 3.5" high Black PVC channel connects to predrilled holes in the table top.

**Required specifications**  
Finish (keystone)

**Optional specifications**  
Grommet (keystone)

**Accessories**  
Power block (keystone)

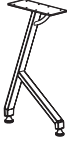
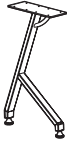
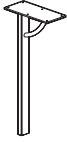
| LEGS   | MODEL #  | DIMENSIONS      | WT/LB. | CUBIC FT. | LIST PRICE   |
|--|--|-----------------|--------|-----------|--------------|
|  <p><b>"Y" Leg</b></p>        | JNLEG20  | 2 x 17.4 x 27.3 | 8.5    | 2         | <b>\$170</b> |
|  | <p>Leg span is 17.5". Leveling glides are standard. <b>For assembly with 20" deep tops.</b></p> <ul style="list-style-type: none"> <li>List price is per each leg.</li> <li>See page 424 for available finishes.</li> </ul>                                    |                 |        |           |              |
|  | JNLEG24  | 2 x 21.5 x 27.3 | 10     | 2.5       | <b>\$170</b> |
|  | <p>Leg span is 21.5". Leveling glides are standard. <b>For assembly with 24" deep tops.</b></p> <ul style="list-style-type: none"> <li>List price is per each leg.</li> <li>See page 424 for available finishes.</li> </ul>                                    |                 |        |           |              |
|  <p><b>"Y" Leg</b></p>        | JNLEG30  | 2 x 24.5 x 27.3 | 11     | 2.85      | <b>\$187</b> |
|  | <p>Leg span is 24.5". Leveling glides are standard. <b>For assembly with 30" deep tops.</b></p> <ul style="list-style-type: none"> <li>List price is per each leg.</li> <li>See page 424 for available finishes.</li> </ul>                                    |                 |        |           |              |
|  <p><b>Straight Leg</b></p> | JNLEG  | 2 x 1 x 27.3    | 6      | 1.3       | <b>\$155</b> |
|  | <p>Leveling glides are standard. <b>For assembly with half round and keystone tops.</b> Mounting plate is 11" deep by 5" wide.</p> <ul style="list-style-type: none"> <li>List price is per each leg.</li> <li>See page 424 for available finishes.</li> </ul> |                 |        |           |              |

**Required specifications**  
 Finish (not JNECTxxxx)

| CASTERS | MODEL # | DIMENSIONS | WT/LB. | CUBIC FT. | LIST PRICE |
|---------|---------|------------|--------|-----------|------------|
|---------|---------|------------|--------|-----------|------------|

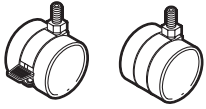

**Casters**

|      | W x D x H   |   |   |             |
|------|-------------|---|---|-------------|
| JNCP | - x - x 1.5 | - | - | <b>\$30</b> |

**Set of 2** - 1.5" dual wheel casters, one locking. Suggested for carpeted surfaces. Casters are fully interchangeable with glides. Black only.

- For use with Junction units only.
- Casters DO NOT affect table height.

| ACCESSORIES |  |  |  |  |  |
|-------------|--|--|--|--|--|
|-------------|--|--|--|--|--|



**Thumbscrews**

|      |                   |   |   |             |
|------|-------------------|---|---|-------------|
| JNTS | 1.25 x 1.25 x 1.5 | - | - | <b>\$17</b> |
|------|-------------------|---|---|-------------|

Triangular thumbscrew with 0.75" steel thread. Set of 4. Can be used in place of factory supplied screws to allow installation of "Y" legs to tops without tools. Black only.

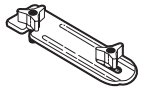

**Ganging Flush Plate**

|       |                |     |     |             |
|-------|----------------|-----|-----|-------------|
| JNGFP | 2.5 x 5 x 1.13 | 0.2 | 0.1 | <b>\$28</b> |
|-------|----------------|-----|-----|-------------|

Black epoxy coated steel plates with 2 thumbscrews included. Used to connect table tops together for additional stability or for connecting freestanding tops together. Holes with steel inserts are located in the corner of the tops to accommodate this plate. Sold individually.



**Flush Plate**

|       |                    |     |      |             |
|-------|--------------------|-----|------|-------------|
| JNFP1 | 5.25 x 5.25 x 0.37 | 1.3 | 0.02 | <b>\$5</b>  |
| JNFP4 | 5.25 x 5.25 x 0.37 | 5.2 | 0.2  | <b>\$20</b> |

Assures alignment on adjoining worksurfaces of the same height. Bolts included. Available in Black only.  
**JNFP1** - 1 per carton.  
**JNFP4** - 4 per carton.



Zook was designed for today's dynamic and diverse learning environments. The tables are lightweight and can be reconfigured easily to create interactive environments and support collaboration.

Choose from a variety of organic and geometric shaped table tops to optimize flexibility. They are available in a wide array of sizes and finishes in both thermally fused laminate and high pressure laminate with matching or complementary edgeband and an array of painted finishes for metal legs.

Tops are available in 1" thick thermally fused laminate or 1 1/16" high pressure laminate with 2mm PVC edgebanding or a new optional ergo friendly edge.

**Features and Benefits**

- Tops are 1" thick thermally fused laminate or 1 1/16" high pressure laminate.
- Tops are constructed of 45 lb. density particle board.
- 2mm PVC edgebanding or optional ergo friendly edge (with some exceptions).
- Tops are available in organic and geometric shapes.
- Surfaces include factory installed metal inserts for solid and secure leg connections.
- Cable tower on group tables is constructed from thermally fused laminate with a removable access panel and inside clearance of 8" x 8.6". Available on group tables ZK44848P, ZK45959P and ZK65990 only.
- Easy to assemble.



Variety of organic and geometric shapes.



Multiple table configurations. Ideal for group study and encouraging collaboration.



Optional ergo friendly edge.

## GENERAL INFORMATION

- Zook is a series of tables designed for classrooms and diverse learning environments.
- Organic shapes and rectangular tops are available to create a variety of configurations that naturally bring people together.
- Choose from Zook group tables for groups of 4 to 6 people, pod tables for individuals, activity tables or flip-top tables.
- Create spaces that encourage discussion and the sharing of ideas.
- Supports multi-use, active learning spaces and a variety of teaching styles.
- Materials and workmanship stand up to the rigorous demands of today's learning environments.
- Shipped easy to assemble. Tops include factory installed metal inserts to accept leg attachment.
- For environmental certification, please visit [globalfurnituregroup.com](http://globalfurnituregroup.com).

## ZOOK GROUP TABLES

- Organic shaped tops available in three sizes: 48" x 48", 59" x 59" or 59" x 90".
- Tops supported by 3" diameter fixed height post legs.
- Select models available with cut-out options for power modules; these select models also include a cable tower for managing cables to floor monuments.

## ZOOK POD TABLES

- Available in four geometric shapes; three that when used adjacent to one another, can create various pod configurations as well as rectangular tables in a number of sizes.
- ADA compliant heights available for select models.
- 1.5" diameter fixed height post legs.
- Tables may be specified on levelers or with casters for greater mobility and flexibility.

## ZOOK ACTIVITY TABLES

- Available in three shapes, all based on a 54" wide footprint.
- Tops are available with two types of mating edges: curved or straight. When planning to mate tables, do not mix mating edge styles.
- 2" diameter tapered legs on levelers or casters.

## ZOOK FLIP-TOP TABLES

- Available in three sizes: 30"W x 22"D with concave shaped top; 30"W x 24"D and 60" W x 24"D rectangular top with radiused corners.
- Supported by Y-legs equipped with smooth glide casters (two locking). H-legs are in Tungsten (TTU) finish only.
- 60" wide table tops optional with FOG1, FOG2 or FOG3 grommet. **Add \$91.**
- Modesty panels are available separately in Tungsten (TUN) finish only.

## WORKSURFACES

- Tops are available in 1" thick thermally fused laminate or 1 1/16" thick high pressure laminate.
- See page 477 for a list of thermally fused and high pressure laminate finishes available, including nine bold finishes in high pressure laminate only.
- Worksurface cores are 45 lb. density particle board.
- All surfaces include factory installed metal inserts for solid and secure leg connections.

## WRITABLE SURFACE OPTION

- Available on group, pod, activity, flip-top and rectangular tables.
- High gloss White, non-magnetic dry-erase surface.
- Complementary or contrasting edge to be specified, darker edge finish recommended.
- Specify (WRW) for top finish. For upcharge, refer to finish option per product.

## EDGE DETAIL

- Global's preferred (2mm flat edge) matching edge is standard.
- Optional ergo friendly edge is available at an upcharge (varies by item; see product for details).
- Rectangular tops feature rounded 2.5" radius corners.



Ergo friendly edge



2mm flat edge

## LEGS

- **Group tables:** 3" diameter steel post legs and are 28" high with adjustable 3" diameter plastic glides. Each leg includes a 6" x 6" metal top plate and ships with truss head screws to connect to tops. See page 431 for available finishes.
- **Pod tables:** 1.5" diameter tube steel legs are available with adjustable levelers or dual wheel locking casters. Each leg includes top plate and hardware for mounting. See page 431 for available finishes. Optional Chrome (CHM) finish is available, upcharge applies. **Add \$79** for three-legged models or **add \$106** for four-legged models.
- **Activity tables:** 2" diameter tapered legs are available with adjustable levelers or optional locking casters. Each leg includes top plate and hardware for mounting. See page 431 for available finishes. Optional Chrome (CHM) finish is available, upcharge applies. **Add \$147.**

### Group tables

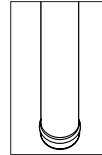

3" leg dia

### Pod tables

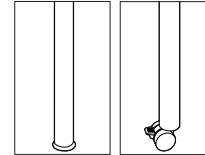

1.5" leg dia  
1.5" leg dia  
with caster

### Activity tables

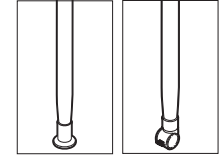

Tapered leg  
with leveler  
Tapered leg  
with caster

## CASTERS

- Pod table models ending in C, indicate legs equipped with casters. 1.5" dual wheel locking casters, available in black only.
- Activity table models ending in C, indicate legs equipped with 2" dia locking casters. Casters are black only.

## GROUP TABLE with CABLE TOWER

- Constructed from thermally fused laminate with a removable access panel.
- Inside clearance of 8" x 8.6" will conceal most floor monuments but still provide easy access.
- Available on group tables ZK44848P, ZK45959P and ZK65990P only.
- Must specify cut-out option when ordering group tables to accommodate select power module. Power modules sold separately.
- Available in Black (BLK), Brushed Cobalt (BRC) or Designer White (DWT) finish.

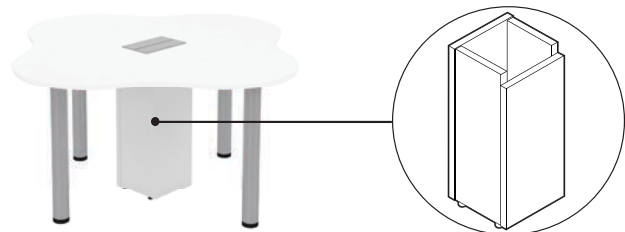

Cable tower

**1. SPECIFY MODEL NUMBER**

**2. SPECIFY TOP FINISH**

**Thermally Fused and High Pressure Laminate Finishes**

|                            |                           |                               |                              |
|----------------------------|---------------------------|-------------------------------|------------------------------|
| <b>ACJ</b> Absolute Acajou | <b>CMB</b> Clear Maple    | <b>NGL</b> Noce Grigio        | <b>WHE</b> Walnut Heights    |
| <b>ASN</b> Asian Night     | <b>CGY</b> Custom Grey    | <b>NEL</b> Noce Leggero       | <b>WHC</b> White Chocolate   |
| <b>AWC</b> Avant Cherry    | <b>DES</b> Dark Espresso  | <b>NML</b> Noce Medio         | <b>WCR</b> Winter Cherry     |
| <b>AWH</b> Avant Honey     | <b>DWT</b> Designer White | <b>OTM</b> Quartered Mahogany | <b>WRW</b> Writable surface* |
| <b>BLK</b> Black           | <b>FAS</b> Fashionista    | <b>SBY</b> Sheer Beauty       |                              |
| <b>BZD</b> Blizzard        | <b>FCL</b> First Class    | <b>SDT</b> Stonedust          |                              |
| <b>BRC</b> Brushed Cobalt  | <b>NBL</b> Noce Biondo    | <b>SOG</b> Storm Grey         |                              |

\*Upcharge varies by product as noted on the individual product pages.

\*\*Select edge finish separately from above (see step #3).

Upcharge varies for high pressure laminate by product. Refer to products for details.

**3. SPECIFY EDGE FINISH**

**2mm Thick Edgebanding**

|                            |                           |                             |
|----------------------------|---------------------------|-----------------------------|
| <b>AAE</b> Absolute Acajou | <b>CME</b> Clear Maple    | <b>NGL</b> Noce Grigio      |
| <b>ASE</b> Asian Night     | <b>CGY</b> Custom Grey    | <b>NEL</b> Noce Leggero     |
| <b>ACE</b> Avant Cherry    | <b>DEE</b> Dark Espresso  | <b>NML</b> Noce Medio       |
| <b>AHE</b> Avant Honey     | <b>DWE</b> Designer White | <b>OTM</b> Quarter Mahogany |
| <b>BLK</b> Black           | <b>DJN</b> Dijon          | <b>SAR</b> Scarlet          |
| <b>BZD</b> Blizzard        | <b>FAS</b> Fashionista    | <b>SHW</b> Shadow           |
| <b>BRC</b> Brushed Cobalt  | <b>FCL</b> First Class    | <b>SBY</b> Sheer Beauty     |
| <b>BZB</b> Buzz Blue       | <b>FOG</b> Fog            | <b>SDT</b> Stonedust        |
| <b>CCT</b> Cactus          | <b>LAB</b> Latte          | <b>SOG</b> Storm Grey       |
| <b>CRO</b> Carrot          | <b>NBL</b> Noce Biondo    | <b>WHE</b> Walnut Heights   |

**Ergo Friendly Edge Finishes  
(optional - upcharge applies)**

|                           |
|---------------------------|
| <b>EBL</b> Black          |
| <b>ECF</b> Latte          |
| <b>ECG</b> Charcoal Grey  |
| <b>EDW</b> Designer White |
| <b>EGR</b> Grey           |

**4. SPECIFY LEG FINISH**

**Legs**

| Table type | TBL | TBZ | TCC | TCR | TIV | TDW | TDJ | TEG | TFO | TFR | TIN | TKA | TLA | TMO | TNE | TSN | TSR | TSH | TOA | TTU | CHM |
|------------|-----|-----|-----|-----|-----|-----|-----|-----|-----|-----|-----|-----|-----|-----|-----|-----|-----|-----|-----|-----|-----|
| Pod        | •   | •   | •   | •   | •   | •   | •   | •   | •   | •   | •   | •   | •   | •   | •   | •   | •   | •   | •   | •   | •   |
| Group      | •   | •   | •   | •   | •   | •   | •   | •   | •   | •   | •   | •   | •   | •   | •   | •   | •   | •   | •   | •   | N/A |
| Activity   | •   | •   | •   | •   | •   | •   | •   | •   | •   | •   | •   | •   | •   | •   | •   | •   | •   | •   | •   | •   | •   |
| Flip-top   | N/A | N/A | N/A | N/A | N/A | N/A | N/A | N/A | N/A | N/A | N/A | N/A | N/A | N/A | N/A | N/A | N/A | N/A | N/A | N/A | N/A |

Note: Leg finish is not optional on flip-top tables, available in Tungsten (TTU) only.

N/A = not available

**5. SPECIFY CABLE TOWER FINISH - ZK44848P, ZK45959P and ZK65990P only**

**Cable Tower Finishes**

|                  |                           |                           |
|------------------|---------------------------|---------------------------|
| <b>BLK</b> Black | <b>BRC</b> Brushed Cobalt | <b>DWT</b> Designer White |
|------------------|---------------------------|---------------------------|

**6. SPECIFY CUT-OUT OPTION - remember to order power module separately**

**POWER BLOCK AND CUT-OUT OPTIONS**

- A power block delivers power/data to the table surface.
- Power block modules must be ordered separately and available for models ZK44848P, ZK45959P and ZK65990P only.
- Must specify the power block cut-out option when ordering the table.
- Optional cut-out available in the **center position** only and corresponds to select power modules. Order as **R2** or **T2**, depending on the power module ordered.
- For a custom size cut-out (must be in center position), please contact Customer Service.
- Select power block option on pages 467-468.

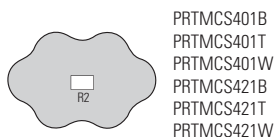

PRTMCS401B  
PRTMCS401T  
PRTMCS401W  
PRTMCS421B  
PRTMCS421T  
PRTMCS421W

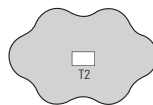

PRTMCD602B  
PRTMCD602T  
PRTMCD602W  
PRTMCD622B  
PRTMCD622T  
PRTMCD622W  
PRTMCD642B  
PRTMCD642T  
PRTMCD642W

- Match power block desired with cut-out code and location from above grid.
- Example: For power block module # PRTMCS401B, specify cut-out option R2.

**MODPOWER DAISY-CHAIN SOLUTION**

- Add flexible power and USB charging to select Zook tables. Connect up to four units with a single corded infeed with NEMA plug.
  - ModPower units are sold separately, refer to Productivity Solutions page 471.
  - Begin run with a starter unit which includes a corded infeed. Add additional middle or end units as required. Middle and end units are equipped with connecting cables.
  - On-surface modules clamp on or screw mount to the table tops.
  - In-surface modules require table top cut-outs for mounting:
    - Specify cut-out option **MPS** for a single cut-out to accommodate one ModPower in-surface unit (cut-out will be centered on the approach side) for **ZKRxxxx(L/C), ZKFR3024\*** and **ZKFR6024\***. Add **\$91**.
    - Specify cut-out option **MPD** for two cut-outs in the left and right positions, 15" from ends to center of unit on the approach side for **ZKR54xx(L/C), ZKR60xx(L/C), ZKR72xx(L/C)** and **ZKFR6024\***. Add **\$183**.
- \*Note: not for use with Zook flip-top tables if optional modesty panel is specified.*



4 TO 6-PERSON GROUP TABLES

| MODEL # | DIMENSIONS | WT/LB. | CUBIC FT. | LIST PRICE | HP ADD | ERGO EDGE ADD | WRW |
|---------|------------|--------|-----------|------------|--------|---------------|-----|
|---------|------------|--------|-----------|------------|--------|---------------|-----|

W x D x H

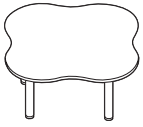

4-Person Table, 20”H

|           |              |     |     |               |              |              |              |
|-----------|--------------|-----|-----|---------------|--------------|--------------|--------------|
| ZK4484820 | 48 x 48 x 20 | 92  | 7.1 | <b>\$1015</b> | <b>\$285</b> | <b>\$147</b> | <b>\$296</b> |
| ZK4595920 | 59 x 59 x 20 | 123 | 9   | <b>\$1059</b> | <b>\$355</b> | <b>\$181</b> | <b>\$459</b> |

4-person table includes top and four steel post legs. Top includes factory installed metal inserts for solid and secure leg connections. Legs are 3” in diameter x 19” high each with an adjustable 3” diameter plastic glide and a 6” x 6” metal top plate. Shipped easy to assemble in 5 cartons.



4-Person Table, 29”H

|         |              |     |     |               |              |              |              |
|---------|--------------|-----|-----|---------------|--------------|--------------|--------------|
| ZK44848 | 48 x 48 x 29 | 215 | 7.1 | <b>\$1053</b> | <b>\$279</b> | <b>\$132</b> | <b>\$312</b> |
| ZK45959 | 59 x 59 x 29 | 220 | 9.2 | <b>\$1079</b> | <b>\$339</b> | <b>\$173</b> | <b>\$471</b> |

4-person table includes top and four steel post legs. Top includes factory installed metal inserts for solid and secure leg connections. Legs are 3” in diameter x 28” high each with an adjustable 3” diameter plastic glide and a 6” x 6” metal top plate. Shipped easy to assemble in 5 cartons.

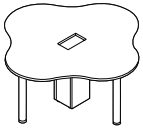

4-Person Table w/Cable Tower, 29”H\*

|          |              |     |     |               |              |              |              |
|----------|--------------|-----|-----|---------------|--------------|--------------|--------------|
| ZK44848P | 48 x 48 x 29 | 265 | 8.9 | <b>\$1437</b> | <b>\$279</b> | <b>\$132</b> | <b>\$312</b> |
| ZK45959P | 59 x 59 x 29 | 270 | 11  | <b>\$1461</b> | <b>\$339</b> | <b>\$173</b> | <b>\$471</b> |

4-person table includes top, four steel post legs and cable tower. Top includes factory installed metal inserts for solid and secure leg connections. Legs are 3” in diameter x 28” high each with an adjustable 3” diameter plastic glide and a 6” x 6” metal top plate. Shipped easy to assemble in 6 cartons. For power block options, see pages 467-468.

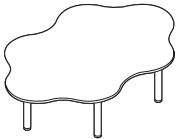

6-Person Table, 20”H

|           |              |       |    |               |              |              |              |
|-----------|--------------|-------|----|---------------|--------------|--------------|--------------|
| ZK6599020 | 90 x 59 x 20 | 247.5 | 14 | <b>\$1630</b> | <b>\$624</b> | <b>\$229</b> | <b>\$741</b> |
|-----------|--------------|-------|----|---------------|--------------|--------------|--------------|

6-person table includes top and seven steel post legs. Top includes factory installed metal inserts for solid and secure leg connections. Legs are 3” in diameter x 19” high each with an adjustable 3” diameter plastic glide and a 6” x 6” metal top plate. Shipped easy to assemble in 8 cartons.

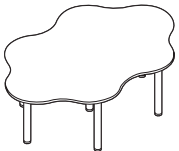

6-Person Table, 29”H

|         |              |     |      |               |              |              |              |
|---------|--------------|-----|------|---------------|--------------|--------------|--------------|
| ZK65990 | 90 x 59 x 29 | 245 | 13.5 | <b>\$1668</b> | <b>\$595</b> | <b>\$252</b> | <b>\$781</b> |
|---------|--------------|-----|------|---------------|--------------|--------------|--------------|

6-person table includes top and seven steel post legs. Top includes factory installed metal inserts for solid and secure leg connections. Legs are 3” in diameter x 28” high each with an adjustable 3” diameter plastic glide and a 6” x 6” metal top plate. Shipped easy to assemble in 8 cartons.

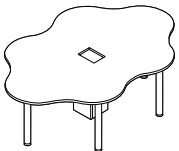

6-Person Table w/Cable Tower, 29”H\*

|          |              |     |      |               |              |              |              |
|----------|--------------|-----|------|---------------|--------------|--------------|--------------|
| ZK65990P | 90 x 59 x 29 | 295 | 15.3 | <b>\$1976</b> | <b>\$595</b> | <b>\$252</b> | <b>\$781</b> |
|----------|--------------|-----|------|---------------|--------------|--------------|--------------|

6-person table includes top, six steel post legs and cable tower. Top includes factory installed metal inserts for solid and secure leg connections. Legs are 3” in diameter x 28” high with an adjustable 3” diameter plastic glide and a 6” x 6” metal top plate. Shipped easy to assemble in 8 cartons. For power block options, see pages 467-468.

**Required specifications**

Top finish  
Edge finish  
Leg finish

**Optional specifications**

HP laminate  
Ergo friendly edge and finish  
Power block cut-out\*

**Accessories**

Power block\*

POD TABLES

Sample pod table configurations

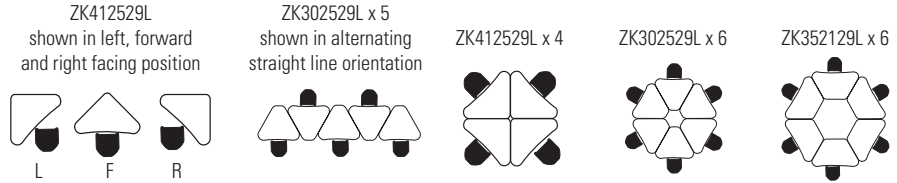

POD TABLES - 29" HIGH



Small Pod Table w/3 Legs

| MODEL #   | DIMENSIONS<br>W x D x H | WT/LB. | CUBIC FT. | LIST PRICE | HP ADD | ERGO EDGE ADD | WRW   |
|-----------|-------------------------|--------|-----------|------------|--------|---------------|-------|
| ZK302529L | 30 x 24.6 x 29          | 37     | 2.01      | \$344      | \$61   | \$62          | \$143 |

Triangular table with three round tube 18 gauge steel legs. Can be used individually, can alternate front-to-back in a straight row, or can be arranged in groups of six to create a round table effect. Top includes factory installed metal inserts for solid and secure leg connections. Legs are 1.5" in diameter x 28" high with adjustable levelers. Shipped easy to assemble in 4 cartons, top separate from legs (legs individually packed).



Medium Pod Table w/4 Legs

|           |                |    |      |       |      |      |       |
|-----------|----------------|----|------|-------|------|------|-------|
| ZK352129L | 35 x 20.9 x 29 | 41 | 2.43 | \$433 | \$75 | \$68 | \$142 |
|-----------|----------------|----|------|-------|------|------|-------|

Trapezoid table with four round tube 18 gauge steel legs. Can be used individually or can be arranged in groups of six to create a round table effect. Top includes factory installed metal inserts for solid and secure leg connections. Legs are 1.5" in diameter x 28" high with adjustable levelers. Shipped easy to assemble in 5 cartons, top separate from legs (legs individually packed).



Large Pod Table w/3 Legs

|           |                |    |      |       |      |      |       |
|-----------|----------------|----|------|-------|------|------|-------|
| ZK412529L | 41 x 25.7 x 29 | 48 | 2.26 | \$444 | \$92 | \$85 | \$164 |
|-----------|----------------|----|------|-------|------|------|-------|

Triangular table with three round tube 18 gauge steel legs. Can be used individually or can be arranged in groups of four to create a square table effect. Top includes factory installed metal inserts for solid and secure leg connections. Legs are 1.5" in diameter x 28" high with adjustable levelers. Shipped easy to assemble in 4 cartons, top separate from legs (legs individually packed).

POD TABLES - 32" HIGH



Medium Pod Table w/4 Legs

|           |                |    |      |       |      |      |       |
|-----------|----------------|----|------|-------|------|------|-------|
| ZK352132L | 35 x 20.9 x 32 | 41 | 2.59 | \$440 | \$75 | \$68 | \$142 |
|-----------|----------------|----|------|-------|------|------|-------|

**ADA compliant** table with four round tube 18 gauge steel legs. Can be used individually or can be arranged in groups of six to create a round table effect. Top includes factory installed metal inserts for solid and secure leg connections. Legs are 1.5" in diameter x 31" high with adjustable levelers. Shipped easy to assemble in 5 cartons, top separate from legs (legs individually packed).

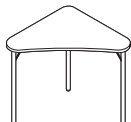

Large Pod Table w/3 Legs

|           |                |    |      |       |      |      |       |
|-----------|----------------|----|------|-------|------|------|-------|
| ZK412532L | 41 x 25.7 x 32 | 48 | 2.38 | \$450 | \$92 | \$85 | \$164 |
|-----------|----------------|----|------|-------|------|------|-------|

**ADA compliant** table with three round tube 18 gauge steel legs. Can be used individually or can be arranged in groups of four to create a square table effect. Top includes factory installed metal inserts for solid and secure leg connections. Legs are 1.5" in diameter x 31" high with adjustable levelers. Shipped easy to assemble in 4 cartons, top separate from legs (legs individually packed).

Required specifications

Top finish  
Edge finish  
Leg finish

Optional specifications

HP laminate  
Ergo friendly edge and finish

**MOBILE POD TABLES - 29" HIGH**

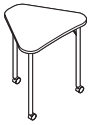

**Small Mobile Pod Table w/3 Legs**

| MODEL #   | DIMENSIONS<br>W x D x H | WT/LB. | CUBIC FT. | LIST PRICE   | HP ADD      | ERGO EDGE ADD | WRW          |
|-----------|-------------------------|--------|-----------|--------------|-------------|---------------|--------------|
| ZK302529C | 30 x 24.6 x 29          | 37     | 2.01      | <b>\$374</b> | <b>\$61</b> | <b>\$62</b>   | <b>\$143</b> |

Triangular table with three round tube 18 gauge steel legs. Can be used individually, can alternate front-to-back in a straight row, or can be arranged in groups of six to create a round table effect. Top includes factory installed metal inserts for solid and secure leg connections. Legs are 1.5" in diameter x 28" high with 1.5" dual wheel locking casters. Shipped easy to assemble in 4 cartons, top separate from legs (legs individually packed).



**Medium Mobile Pod Table w/4 Legs**

|           |                |    |      |              |             |             |              |
|-----------|----------------|----|------|--------------|-------------|-------------|--------------|
| ZK352129C | 35 x 20.9 x 29 | 41 | 2.43 | <b>\$470</b> | <b>\$75</b> | <b>\$68</b> | <b>\$142</b> |
|-----------|----------------|----|------|--------------|-------------|-------------|--------------|

Trapezoid table with four round tube 18 gauge steel legs. Can be used individually or can be arranged in groups of six to create a round table effect. Top includes factory installed metal inserts for solid and secure leg connections. Legs are 1.5" in diameter x 28" high with 1.5" dual wheel locking casters. Shipped easy to assemble in 5 cartons, top separate from legs (legs individually packed).



**Large Mobile Pod Table w/3 Legs**

|           |                |    |      |              |             |             |              |
|-----------|----------------|----|------|--------------|-------------|-------------|--------------|
| ZK412529C | 41 x 25.7 x 29 | 48 | 2.26 | <b>\$474</b> | <b>\$92</b> | <b>\$85</b> | <b>\$164</b> |
|-----------|----------------|----|------|--------------|-------------|-------------|--------------|

Triangular table with three round tube 18 gauge steel legs. Can be used individually or can be arranged in groups of four to create a square table effect. Top includes factory installed metal inserts for solid and secure leg connections. Legs are 1.5" in diameter x 28" high with 1.5" dual wheel locking casters. Shipped easy to assemble in 4 cartons, top separate from legs (legs individually packed).

**RECTANGULAR TABLES - 29" HIGH**

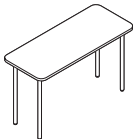

**Rectangular Table, 20" Deep**

|          |              |    |      |              |              |              |              |
|----------|--------------|----|------|--------------|--------------|--------------|--------------|
| ZKR3020L | 30 x 20 x 29 | 49 | 2.56 | <b>\$419</b> | <b>\$97</b>  | <b>\$69</b>  | <b>\$131</b> |
| ZKR3620L | 36 x 20 x 29 | 50 | 2.68 | <b>\$433</b> | <b>\$113</b> | <b>\$77</b>  | <b>\$141</b> |
| ZKR4820L | 48 x 20 x 29 | 57 | 2.98 | <b>\$477</b> | <b>\$153</b> | <b>\$94</b>  | <b>\$160</b> |
| ZKR5420L | 54 x 20 x 29 | 63 | 3.18 | <b>\$557</b> | <b>\$172</b> | <b>\$103</b> | <b>\$168</b> |
| ZKR6020L | 60 x 20 x 29 | 69 | 3.28 | <b>\$576</b> | <b>\$191</b> | <b>\$110</b> | <b>\$177</b> |
| ZKR7220L | 72 x 20 x 29 | 84 | 3.58 | <b>\$633</b> | <b>\$230</b> | <b>\$127</b> | <b>\$196</b> |

Table with four round tube 18 gauge steel legs. Legs are 1.5" in diameter x 28" high with adjustable levelers. Top features 2.5" radius rounded corners and includes factory installed metal inserts for solid and secure leg connections. Tables 54" and wider include support channel. Shipped easy to assemble in 5 cartons, top separate from legs (legs individually packed).

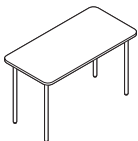

**Rectangular Table, 24" Deep**

|          |              |    |      |              |              |              |              |
|----------|--------------|----|------|--------------|--------------|--------------|--------------|
| ZKR3024L | 30 x 24 x 29 | 50 | 2.78 | <b>\$424</b> | <b>\$113</b> | <b>\$75</b>  | <b>\$141</b> |
| ZKR3624L | 36 x 24 x 29 | 52 | 2.88 | <b>\$457</b> | <b>\$140</b> | <b>\$83</b>  | <b>\$151</b> |
| ZKR4824L | 48 x 24 x 29 | 58 | 3.28 | <b>\$508</b> | <b>\$184</b> | <b>\$99</b>  | <b>\$174</b> |
| ZKR5424L | 54 x 24 x 29 | 64 | 3.38 | <b>\$591</b> | <b>\$207</b> | <b>\$108</b> | <b>\$185</b> |
| ZKR6024L | 60 x 24 x 29 | 70 | 3.58 | <b>\$615</b> | <b>\$230</b> | <b>\$116</b> | <b>\$196</b> |
| ZKR7224L | 72 x 24 x 29 | 85 | 3.98 | <b>\$675</b> | <b>\$275</b> | <b>\$132</b> | <b>\$218</b> |

Table with four round tube 18 gauge steel legs. Legs are 1.5" in diameter x 28" high with adjustable levelers. Top features 2.5" radius rounded corners and includes factory installed metal inserts for solid and secure leg connections. Tables 54" and wider include support channel. Shipped easy to assemble in 5 cartons, top separate from legs (legs individually packed).

**Required specifications**

Top finish  
Edge finish  
Leg finish

**Optional specifications**

HP laminate  
Ergo friendly edge and finish

**MOBILE RECTANGULAR TABLES - 29" HIGH**

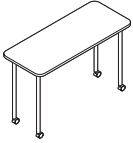

**Mobile Rectangular Table, 20" Deep**

| MODEL #  | DIMENSIONS<br>W x D x H | WT/LB. | CUBIC FT. | LIST PRICE   | HP ADD       | ERGO EDGE ADD | WRW          |
|----------|-------------------------|--------|-----------|--------------|--------------|---------------|--------------|
| ZKR3020C | 30 x 20 x 29            | 50     | 2.56      | <b>\$458</b> | <b>\$97</b>  | <b>\$69</b>   | <b>\$131</b> |
| ZKR3620C | 36 x 20 x 29            | 51     | 2.68      | <b>\$470</b> | <b>\$113</b> | <b>\$77</b>   | <b>\$141</b> |
| ZKR4820C | 48 x 20 x 29            | 58     | 2.98      | <b>\$515</b> | <b>\$153</b> | <b>\$94</b>   | <b>\$160</b> |
| ZKR5420C | 54 x 20 x 29            | 64     | 3.18      | <b>\$594</b> | <b>\$172</b> | <b>\$103</b>  | <b>\$168</b> |
| ZKR6020C | 60 x 20 x 29            | 70     | 3.28      | <b>\$615</b> | <b>\$191</b> | <b>\$110</b>  | <b>\$177</b> |
| ZKR7220C | 72 x 20 x 29            | 85     | 3.58      | <b>\$672</b> | <b>\$230</b> | <b>\$127</b>  | <b>\$196</b> |

Table with four round tube 18 gauge steel legs. Legs are 1.5" in diameter x 28" high with 1.5" dual wheel locking casters. Top features 2.5" radius rounded corners and includes factory installed metal inserts for solid and secure leg connections. Tables 54" and wider include support channel. Shipped easy to assemble in 5 cartons, top separate from legs (legs individually packed).

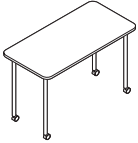

**Mobile Rectangular Table, 24" Deep**

|          |              |    |      |              |              |              |              |
|----------|--------------|----|------|--------------|--------------|--------------|--------------|
| ZKR3024C | 30 x 24 x 29 | 51 | 2.78 | <b>\$461</b> | <b>\$113</b> | <b>\$75</b>  | <b>\$141</b> |
| ZKR3624C | 36 x 24 x 29 | 53 | 2.88 | <b>\$492</b> | <b>\$140</b> | <b>\$83</b>  | <b>\$151</b> |
| ZKR4824C | 48 x 24 x 29 | 59 | 3.28 | <b>\$547</b> | <b>\$184</b> | <b>\$99</b>  | <b>\$174</b> |
| ZKR5424C | 54 x 24 x 29 | 65 | 3.38 | <b>\$628</b> | <b>\$207</b> | <b>\$108</b> | <b>\$185</b> |
| ZKR6024C | 60 x 24 x 29 | 71 | 3.58 | <b>\$653</b> | <b>\$230</b> | <b>\$116</b> | <b>\$196</b> |
| ZKR7224C | 72 x 24 x 29 | 86 | 3.98 | <b>\$714</b> | <b>\$275</b> | <b>\$132</b> | <b>\$218</b> |

Table with four round tube 18 gauge steel legs. Legs are 1.5" in diameter x 28" high with 1.5" dual wheel locking casters. Top features 2.5" radius rounded corners and includes factory installed metal inserts for solid and secure leg connections. Tables 54" and wider include support channel. Shipped easy to assemble in 5 cartons, top separate from legs (legs individually packed).

**Required specifications**

- Top finish
- Edge finish
- Leg finish

**Optional specifications**

- HP laminate
- Ergo friendly edge and finish

ACTIVITY TABLES

Sample activity table configurations

Straight mating edges

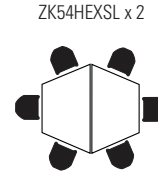
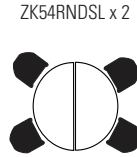
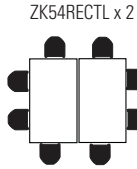

Curved mating edges

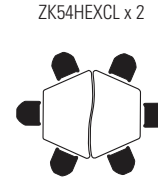
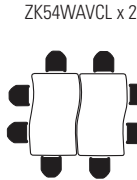

Mixed shapes  
Curved mating edges shown.  
Can also do the same with straight mating edge tables.

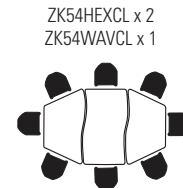
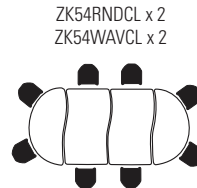

ACTIVITY TABLES - 29" HIGH, CURVED

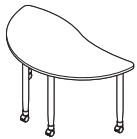

Curved Half Round Table w/Casters

| MODEL # | DIMENSIONS<br>W x D x H | WT/LB. | CUBIC FT. | LIST PRICE | HP ADD | ERGO EDGE ADD | WRW |
|---------|-------------------------|--------|-----------|------------|--------|---------------|-----|
|---------|-------------------------|--------|-----------|------------|--------|---------------|-----|

|           |                   |      |     |       |       |       |       |
|-----------|-------------------|------|-----|-------|-------|-------|-------|
| ZK54RNDCC | 54 x 28.4 x 28.75 | 67.4 | 2.8 | \$821 | \$188 | \$114 | \$185 |
|-----------|-------------------|------|-----|-------|-------|-------|-------|

44.3" inside clearance between legs on curved edge, 22.9" on narrow depth side and 24" on other side. Dual leg position on front interferes with users sitting on ends in a racetrack configuration, oriented to seat two one either side. Top includes factory installed inserts for metal-to-metal leg connection. Shipped easy to assemble in 2 cartons, top separate from legs.

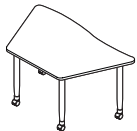

Curved Half Hex Table w/Casters

|           |                   |      |      |       |       |       |       |
|-----------|-------------------|------|------|-------|-------|-------|-------|
| ZK54HEXCC | 54 x 32.4 x 28.75 | 76.4 | 2.99 | \$887 | \$219 | \$119 | \$185 |
|-----------|-------------------|------|------|-------|-------|-------|-------|

42.9" inside clearance between legs on curved edge, 22.3" on narrow depth side and 24" on other side, 22.8" on straight end. Top includes factory installed inserts for metal-to-metal leg connection. Shipped easy to assemble in 2 cartons, top separate from legs.



Wave Table w/Casters

|           |                   |      |      |       |       |       |       |
|-----------|-------------------|------|------|-------|-------|-------|-------|
| ZK54WAVCC | 54 x 33.8 x 28.75 | 77.4 | 3.04 | \$912 | \$232 | \$121 | \$185 |
|-----------|-------------------|------|------|-------|-------|-------|-------|

44.9" inside clearance between legs on curved edges and 21.9" on sides. Top includes factory installed inserts for metal-to-metal leg connection. Shipped easy to assemble in 2 cartons, top separate from leg.

Required specifications

- Top finish
- Edge finish
- Leg finish

Optional specifications

- HP laminate
- Ergo friendly edge and finish

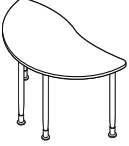
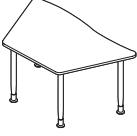
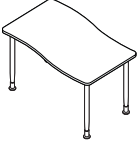
| ACTIVITY TABLES - 29" HIGH, CURVED  |   | MODEL #  | DIMENSIONS        | WT/LB. | CUBIC FT. | LIST PRICE   | HP ADD       | ERGO EDGE ADD | WRW          |
|---|---|--|-------------------|--------|-----------|--------------|--------------|---------------|--------------|
|   |   |  | W x D x H         |        |           |              |              |               |              |
|  | <b>Curved Half Round Table w/Levelers</b> | ZK54RNDCL  | 54 x 28.4 x 28.25 | 67.4   | 2.8       | <b>\$821</b> | <b>\$188</b> | <b>\$114</b>  | <b>\$185</b> |
|   |   | 44.3" inside clearance between legs on curved edge, 22.9" on narrow depth side and 24" on other side. Dual leg position on front interferes with users sitting on ends in a racetrack configuration, oriented to seat two one either side. Top includes factory installed inserts for metal-to-metal leg connection. Shipped easy to assemble in 2 cartons, top separate from leg. |                   |        |           |              |              |               |              |
|  | <b>Curved Half Hex Table w/Levelers*</b>  | ZK54HEXCL  | 54 x 32.4 x 28.25 | 76.4   | 2.99      | <b>\$887</b> | <b>\$219</b> | <b>\$119</b>  | <b>\$185</b> |
|   |   | 42.9" inside clearance between legs on curved edge, 22.3" on narrow depth side and 24" on other side, 22.8" on straight end. Top includes factory installed inserts for metal-to-metal leg connection. Shipped easy to assemble in 2 cartons, top separate from leg.   |                   |        |           |              |              |               |              |
|  | <b>Wave Table w/Levelers*</b>             | ZK54WAVCL  | 54 x 33.8 x 28.25 | 77.4   | 3.04      | <b>\$912</b> | <b>\$232</b> | <b>\$121</b>  | <b>\$185</b> |
|   |   | 44.9" inside clearance between legs on curved edges and 21.9" on sides. Top includes factory installed inserts for metal-to-metal leg connection. Shipped easy to assemble in 2 cartons, top separate from leg.  |                   |        |           |              |              |               |              |

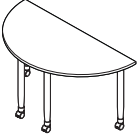
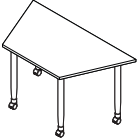
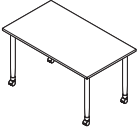
| ACTIVITY TABLES - 29" HIGH, STRAIGHT  |  | MODEL #   | DIMENSIONS      | WT/LB. | CUBIC FT. | LIST PRICE   | HP ADD       | ERGO EDGE ADD | WRW          |
|---|--|---|-----------------|--------|-----------|--------------|--------------|---------------|--------------|
|   | <b>Straight Half Round Table w/Casters</b> | ZK54RNDSC   | 54 x 28 x 28.75 | 67.4   | 2.8       | <b>\$777</b> | <b>\$168</b> | N/A           | <b>\$185</b> |
|   |  | 44.2" inside clearance between legs on long side, 23.7" on the sides. Dual leg position at front interferes with users sitting on ends in a racetrack configuration, oriented to seat two one on either side. Top includes factory installed inserts for metal-to-metal leg connection. Shipped easy to assemble in 2 cartons, top separate from leg. |                 |        |           |              |              |               |              |
|  | <b>Straight Half Hex Table w/Casters</b>   | ZK54HEXSC   | 54 x 34 x 28.75 | 73.4   | 2.99      | <b>\$802</b> | <b>\$178</b> | N/A           | <b>\$185</b> |
|   |  | 40.6" inside clearance between legs on long side, 21.4" on sides and 22.3" on short side. Top includes factory installed inserts for metal-to-metal leg connection. Shipped easy to assemble in 2 cartons, top separate from leg.   |                 |        |           |              |              |               |              |
|  | <b>Rectangular Table w/Casters</b>         | ZK54RECTC   | 54 x 34 x 28.75 | 73.4   | 3.04      | <b>\$847</b> | <b>\$201</b> | N/A           | <b>\$185</b> |
|   |  | 45.3" inside clearance between legs on long sides and 22.3" on short sides. Top includes factory installed inserts for metal-to-metal leg connection. Shipped easy to assemble in 2 cartons, top separate from leg.   |                 |        |           |              |              |               |              |

**Required specifications**

Top finish  
Edge finish  
Leg finish

**Optional specifications**

HP laminate  
Ergo friendly edge and finish\*

ACTIVITY TABLES - 29" HIGH, STRAIGHT



**Straight Half Round Table w/Levelers**

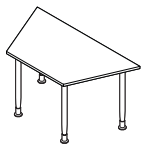

**Straight Half Hex Table w/Levelers**



**Rectangular Table w/Levelers**

| MODEL #   | DIMENSIONS<br>W x D x H | WT/LB. | CUBIC FT. | LIST PRICE   | HP ADD       | ERGO EDGE ADD | WRW          |
|---|-------------------------|--------|-----------|--------------|--------------|---------------|--------------|
| ZK54RNDL  | 54 x 28 x 28.25         | 67.4   | 2.8       | <b>\$777</b> | <b>\$168</b> | N/A           | <b>\$185</b> |
| 44.2" inside clearance between legs on long side, 23.7" on the sides. Dual leg position at front interferes with users sitting on ends in a racetrack configuration, oriented to seat two one on either side. Top includes factory installed inserts for metal-to-metal leg connection. Shipped easy to assemble in 2 cartons, top separate from leg. |                         |        |           |              |              |               |              |
| ZK54HEXSL   | 54 x 34 x 28.25         | 73.4   | 2.99      | <b>\$802</b> | <b>\$178</b> | N/A           | <b>\$185</b> |
| 40.6" inside clearance between legs on long side, 21.4" on sides and 22.3" on short side. Top includes factory installed inserts for metal-to-metal leg connection. Shipped easy to assemble in 2 cartons, top separate from leg.   |                         |        |           |              |              |               |              |
| ZK54RECTL   | 54 x 34 x 28.25         | 73.4   | 3.04      | <b>\$847</b> | <b>\$201</b> | N/A           | <b>\$185</b> |
| 45.3" inside clearance between legs on long sides and 22.3" on short sides. Top includes factory installed inserts for metal-to-metal leg connection. Shipped easy to assemble in 2 cartons, top separate from leg.   |                         |        |           |              |              |               |              |

**Required specifications**

Top finish  
Edge finish  
Leg finish

**Optional specifications**

HP laminate

**FLIP-TOP TABLES - 29.5" HIGH**      **MODEL #**      **DIMENSIONS**      **WT/LB.**      **CUBIC FT.**      **LIST PRICE**      **HP ADD**      **ERGO EDGE ADD**      **WRW**

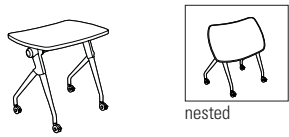

**Flip-Top Table, Contoured Top**

|          | W x D x H      |      |      |              |              |             |              |  |
|----------|----------------|------|------|--------------|--------------|-------------|--------------|--|
| ZKFC3022 | 30 x 22 x 29.5 | 47.1 | 4.07 | <b>\$757</b> | <b>\$113</b> | <b>\$72</b> | <b>\$135</b> |  |

Mobile flip-top table with smooth glide locking casters. Easy to operate twist knob with integrated thumb tab. Top includes factory installed inserts for metal-to-metal leg connection. When nested each additional table adds 5.25" to footprint needed for storage. Optional modesty (ZKFTM30) available separately. Shipped easy to assemble in 2 cartons, top and base shipped separately.

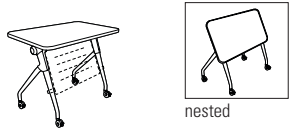

**Flip-Top Table, Rectangular Top\*\***

|          |                |    |      |              |              |             |              |  |
|----------|----------------|----|------|--------------|--------------|-------------|--------------|--|
| ZKFR3024 | 30 x 24 x 29.5 | 48 | 4.15 | <b>\$765</b> | <b>\$125</b> | <b>\$74</b> | <b>\$141</b> |  |
|----------|----------------|----|------|--------------|--------------|-------------|--------------|--|

Mobile flip-top table with smooth glide locking casters. Easy to operate twist knob with integrated thumb tab. Top includes factory installed inserts for metal-to-metal leg connection. When nested each additional table adds 5.25" to footprint needed for storage. Optional modesty (ZKFTM30) available separately. Shipped easy to assemble in 2 cartons, top and base shipped separately.

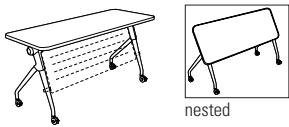

**Flip-Top Table, Rectangular Top\***

|          |                |      |      |              |              |              |              |  |
|----------|----------------|------|------|--------------|--------------|--------------|--------------|--|
| ZKFR6024 | 60 x 24 x 29.5 | 73.9 | 5.28 | <b>\$956</b> | <b>\$187</b> | <b>\$116</b> | <b>\$196</b> |  |
|----------|----------------|------|------|--------------|--------------|--------------|--------------|--|

Mobile flip-top table with smooth glide locking casters. Easy to operate twist knob with integrated thumb tab. Top includes factory installed inserts for metal-to-metal leg connection. When nested each additional table adds 5.25" to footprint needed for storage. Optional modesty (ZKFTM60) available separately. Shipped easy to assemble in 3 cartons, top and base shipped separately.



**Modesty Panel for ZKFC3022 / ZKFC3024**

|         |                     |     |      |             |     |     |     |  |
|---------|---------------------|-----|------|-------------|-----|-----|-----|--|
| ZKFTM30 | 17.75 x 0.5 x 13.75 | 6.6 | 0.22 | <b>\$37</b> | N/A | N/A | N/A |  |
|---------|---------------------|-----|------|-------------|-----|-----|-----|--|

Hardware included to attach to ZKFC3022 or ZKFR3024. Tungsten finish only. Shipped in 1 carton.

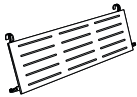

**Modesty Panel for ZKFR6024**

|         |                     |      |      |             |     |     |     |  |
|---------|---------------------|------|------|-------------|-----|-----|-----|--|
| ZKFTM60 | 47.25 x 0.5 x 13.75 | 14.3 | 0.57 | <b>\$83</b> | N/A | N/A | N/A |  |
|---------|---------------------|------|------|-------------|-----|-----|-----|--|

Hardware included to attach to ZKFR6024. Tungsten finish only. Shipped in 1 carton.

**Required specifications**

Top finish  
Edge finish

**Optional specifications**

HP laminate  
Ergo friendly edge and finish  
Grommet\* (FOG1, FOG2 or FOG3)  
Grommet\*\* (FOG2 only)



# tables

## reception and occasional



Citi 441

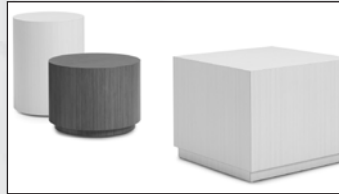

Occasional tables 443



River+ 445



Sirena 447



Wind 448



Work tables 450

CITI TABLES

Notes:

- Citi tables complement the contemporary timeless decor of many offices.
- Legs are **standard** in Tungsten (**TTU**) and also available in Black (**TBL**) finish at no upcharge. A Chrome (**CHM**) finish is available. **Add \$68.**
- Table tops are available in either tempered glass or laminate.
- Citi tables are offered in the following finishes to coordinate with Global casegoods and wood seating:

|                            |                               |
|----------------------------|-------------------------------|
| <b>ACJ</b> Absolute Acajou | <b>FCL</b> First Class        |
| <b>ASN</b> Asian Night     | <b>NBL</b> Noce Biondo        |
| <b>AWC</b> Avant Cherry    | <b>NGL</b> Noce Grigio        |
| <b>AWH</b> Avant Honey     | <b>NEL</b> Noce Leggero       |
| <b>BLK</b> Black           | <b>NML</b> Noce Medio         |
| <b>BZD</b> Blizzard        | <b>QTM</b> Quartered Mahogany |
| <b>BRC</b> Brushed Cobalt  | <b>SBY</b> Sheer Beauty       |
| <b>CMB</b> Clear Maple     | <b>SDT</b> Stonedust          |
| <b>CGY</b> Custom Grey     | <b>SOG</b> Storm Grey         |
| <b>DES</b> Dark Espresso   | <b>WHE</b> Walnut Heights     |
| <b>DWT</b> Designer White  | <b>WHC</b> White Chocolate    |
| <b>FAS</b> Fashionista     | <b>WCR</b> Winter Cherry      |

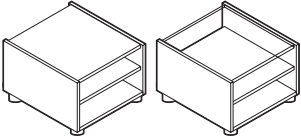
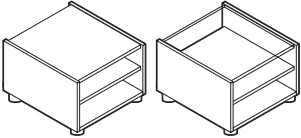
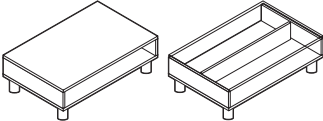
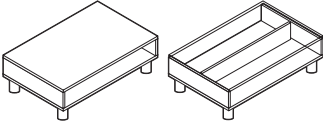
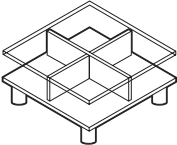
| CITI TABLES   | MODEL #        | DIMENSIONS   | WT/LB. | CUBIC FT. | LIST PRICE    |
|---|----------------|--------------|--------|-----------|---------------|
| <b>W x D x H</b>  |                |              |        |           |               |
|              | 7885           | 20 x 24 x 20 | 45     | 6         | <b>\$715</b>  |
|   | (laminate top) |              |        |           |               |
|              | 7886           | 20 x 24 x 20 | 52     | 6         | <b>\$934</b>  |
|   | (glass top)    |              |        |           |               |
| Metal tubular legs. Laminate or tempered glass tops available. Shipped assembled in 1 carton. |                |              |        |           |               |
|            | 7887           | 40 x 20 x 15 | 50     | 6.5       | <b>\$747</b>  |
|   | (laminate top) |              |        |           |               |
|            | 7888           | 40 x 20 x 15 | 65     | 6.5       | <b>\$1079</b> |
|   | (glass top)    |              |        |           |               |
| Metal tubular legs. Laminate or tempered glass tops available. Shipped assembled in 1 carton. |                |              |        |           |               |
|            | 7889           | 33 x 33 x 15 | 80     | 8.75      | <b>\$1283</b> |
|   | (glass top)    |              |        |           |               |
| Metal tubular legs. Tempered glass top. Shipped assembled in 1 carton.                        |                |              |        |           |               |

End Table

Coffee Table - Rectangular

Coffee Table - Square

**Required specifications**

- Top finish
- Leg finish

# C COAT TREES

| COAT TREES | MODEL # | DIMENSIONS | WT/LB. | CUBIC FT. | LIST PRICE |
|------------|---------|------------|--------|-----------|------------|
|------------|---------|------------|--------|-----------|------------|



Coat Tree

|       | W x D x H    |   |       |  |              |
|-------|--------------|---|-------|--|--------------|
| PCOS2 | 25 x 25 x 60 | 8 | 14.21 |  | <b>\$186</b> |
| PCOS3 | 25 x 25 x 60 | 8 | 14.21 |  | <b>\$186</b> |

Square tube metal frame. Four Chrome double hooks. Adjustable glides. 60" high. 3 per carton (pricing and specifications are for one coat tree).

Shipped assembled in 1 carton.

- PCOS2 is finished in **Black (BLK)**.
- PCOS3 is finished in **Chrome (CHM)**.



Coat Tree

|     |              |   |   |  |              |
|-----|--------------|---|---|--|--------------|
| PCT | 25 x 25 x 65 | 6 | 3 |  | <b>\$228</b> |
|-----|--------------|---|---|--|--------------|

Square tube wood frame. Complete with four satin brass double hooks. 65" high. Available in the following finishes: Absolute (AAM), Black (BKM), Cherry (ACM), English Oak (EOM), Espresso Cafe (ECM), Gray (HGM), Honey (AHM), Maple (AVM), Medium Walnut (MWM), Night (ASM), Sandy Beach (SBM), Shaker Cherry (SKM), Tiger Fruitwood (TFM), Tiger Mahogany (TMM), Tiger Walnut (TWM), WC Cream (WTM), White (WHM) and Winter Cherry (WCM).  
1 per carton. Shipped assembled in 1 carton.

**Required specifications**

Finish

CYLINDER AND CUBE OCCASIONAL TABLES

Notes:

- High pressure laminate exterior with adjustable plastic glides.
- Premium cylinder tables have a flexible plywood core construction ideal for institutional and high traffic environments.
- Ideal for reception areas - colors coordinate with all Global desks, conference tables and accessories.
- Shipped assembled in 1 carton.
- WT/LB. are shipping weights.
- Available to either match or coordinate with most Global laminate desk series. Available finishes:

|                            |                               |
|----------------------------|-------------------------------|
| <b>ACJ</b> Absolute Acajou | <b>FCL</b> First Class        |
| <b>ASN</b> Asian Night     | <b>NBL</b> Noce Biondo        |
| <b>AWC</b> Avant Cherry    | <b>NGL</b> Noce Grigio        |
| <b>AWH</b> Avant Honey     | <b>NEL</b> Noce Leggero       |
| <b>BLK</b> Black           | <b>NML</b> Noce Medio         |
| <b>BZD</b> Blizzard        | <b>QTM</b> Quartered Mahogany |
| <b>BRC</b> Brushed Cobalt  | <b>SBY</b> Sheer Beauty       |
| <b>CMB</b> Clear Maple     | <b>SDT</b> Stonedust          |
| <b>CGY</b> Custom Grey     | <b>SGG</b> Storm Grey         |
| <b>DES</b> Dark Espresso   | <b>WHE</b> Walnut Heights     |
| <b>DWT</b> Designer White  | <b>WHC</b> White Chocolate    |
| <b>FAS</b> Fashionista     | <b>WCR</b> Winter Cherry      |

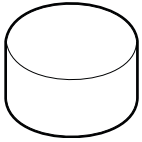
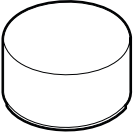
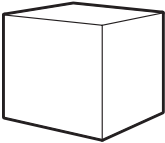
| CYLINDER AND CUBE OCCASIONAL TABLES  | MODEL #          | DIMENSIONS   | WT/LB. | CUBIC FT. | LIST PRICE    |
|--|------------------|--------------|--------|-----------|---------------|
|  <p><b>Premium Cylinder Tables</b></p>                    | <b>W x D x H</b> |              |        |           |               |
|  | CPFD1816         | 18 x - x 16  | 23     | 6.5       | <b>\$832</b>  |
|  | CPFD1821         | 18 x - x 21  | 26.5   | 8         | <b>\$856</b>  |
|  | CPFD2416         | 24 x - x 16  | 32.5   | 11        | <b>\$865</b>  |
|  | CPFD2421         | 24 x - x 21  | 35     | 12.5      | <b>\$886</b>  |
|  | CPFD3016         | 30 x - x 16  | 45.5   | 15.5      | <b>\$1024</b> |
|  | CPFD3021         | 30 x - x 21  | 48     | 17        | <b>\$1079</b> |
| <sup>11</sup> / <sub>32</sub> " thick flexible plywood covered in high pressure laminate. Adjustable plastic glides. <b>Flush base.</b>    |                  |              |        |           |               |
|  <p><b>Premium Plinth Cylinder Tables</b></p>           | CPPD1816         | 18 x - x 16  | 27.5   | 6.5       | <b>\$877</b>  |
|  | CPPD1821         | 18 x - x 21  | 31     | 8         | <b>\$898</b>  |
|  | CPPD2416         | 24 x - x 16  | 38.7   | 11        | <b>\$908</b>  |
|  | CPPD2421         | 24 x - x 21  | 41.2   | 12.5      | <b>\$931</b>  |
|  | CPPD3016         | 30 x - x 16  | 54.5   | 15.5      | <b>\$1038</b> |
|  | CPPD3021         | 30 x - x 21  | 57     | 17        | <b>\$1138</b> |
| <sup>11</sup> / <sub>32</sub> " thick flexible plywood covered in high pressure laminate. Adjustable plastic glides. <b>Recessed base.</b> |                  |              |        |           |               |
|  <p><b>Cube Table</b></p>                               | CU1816           | 18 x 18 x 16 | 26     | 3.3       | <b>\$502</b>  |
|  | CU1821           | 18 x 18 x 21 | 30     | 4         | <b>\$544</b>  |
|  | CU2416           | 24 x 24 x 16 | 38     | 6         | <b>\$526</b>  |
|  | CU2421           | 24 x 24 x 21 | 43.5   | 7         | <b>\$569</b>  |
|  | CU3016           | 30 x 30 x 16 | 50.8   | 6.5       | <b>\$553</b>  |
|  | CU3021           | 30 x 30 x 21 | 57.5   | 8         | <b>\$595</b>  |
| 0.75" thick plywood covered in high pressure laminate. Adjustable plastic glides. <b>Flush base.</b>                                       |                  |              |        |           |               |

**Required specifications**

Finish

# 0 OCCASIONAL TABLES

## CYLINDER AND CUBE OCCASIONAL TABLES

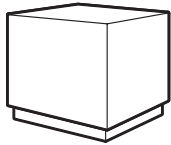

**Plinth Cube Table**

| MODEL # | DIMENSIONS<br>W x D x H | WT/LB. | CUBIC FT. | LIST PRICE   |
|---------|-------------------------|--------|-----------|--------------|
| CUP1816 | 18 x 18 x 16            | 28     | 3         | <b>\$545</b> |
| CUP1821 | 18 x 18 x 21            | 33.5   | 4         | <b>\$586</b> |
| CUP2416 | 24 x 24 x 16            | 41.5   | 6         | <b>\$573</b> |
| CUP2421 | 24 x 24 x 21            | 48     | 7         | <b>\$615</b> |
| CUP3016 | 30 x 30 x 16            | 53.8   | 6.5       | <b>\$638</b> |
| CUP3021 | 30 x 30 x 21            | 62.3   | 8         | <b>\$695</b> |

0.75" thick plywood covered in high pressure laminate. Adjustable plastic glides. **Recessed base.**

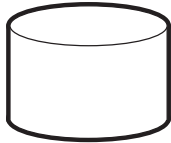

**Cylinder Table**

|        |             |      |     |              |
|--------|-------------|------|-----|--------------|
| CY1816 | 18 x - x 16 | 21   | 3.3 | <b>\$465</b> |
| CY1821 | 18 x - x 21 | 27   | 4.3 | <b>\$512</b> |
| CY2416 | 24 x - x 16 | 33   | 6   | <b>\$485</b> |
| CY2421 | 24 x - x 21 | 39   | 7   | <b>\$526</b> |
| CY3016 | 30 x - x 16 | 44.5 | 8   | <b>\$573</b> |
| CY3021 | 30 x - x 21 | 52.7 | 11  | <b>\$616</b> |

0.375" thick foundation board covered in high pressure laminate. Adjustable plastic glides. **Flush base.**

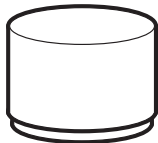

**Plinth Cylinder Table**

|         |             |      |     |              |
|---------|-------------|------|-----|--------------|
| CYP1816 | 18 x - x 16 | 26.5 | 3.3 | <b>\$502</b> |
| CYP1821 | 18 x - x 21 | 32   | 4.3 | <b>\$545</b> |
| CYP2416 | 24 x - x 16 | 40   | 6   | <b>\$522</b> |
| CYP2421 | 24 x - x 21 | 46   | 7   | <b>\$564</b> |
| CYP3016 | 30 x - x 16 | 52.3 | 8   | <b>\$614</b> |
| CYP3021 | 30 x - x 21 | 60.5 | 11  | <b>\$654</b> |

0.375" thick foundation board covered in high pressure laminate. Adjustable plastic glides. **Recessed base.**

### Required specifications

Finish

RIVER+ TABLES

Notes:

River+ tables are made with high pressure laminate and are offered in following finishes to coordinate with Global casegoods and wood seating:

|                            |                               |
|----------------------------|-------------------------------|
| <b>ACJ</b> Absolute Acajou | <b>FCL</b> First Class        |
| <b>ASN</b> Asian Night     | <b>NBL</b> Noce Biondo        |
| <b>AWC</b> Avant Cherry    | <b>NGL</b> Noce Grigio        |
| <b>AWH</b> Avant Honey     | <b>NEL</b> Noce Leggero       |
| <b>BLK</b> Black           | <b>NML</b> Noce Medio         |
| <b>BZD</b> Blizzard        | <b>QTM</b> Quartered Mahogany |
| <b>BRC</b> Brushed Cobalt  | <b>SBY</b> Sheer Beauty       |
| <b>CMB</b> Clear Maple     | <b>SDT</b> Stonedust          |
| <b>CGY</b> Custom Grey     | <b>SOG</b> Storm Grey         |
| <b>DES</b> Dark Espresso   | <b>WHE</b> Walnut Heights     |
| <b>DWT</b> Designer White  | <b>WHC</b> White Chocolate    |
| <b>FAS</b> Fashionista     | <b>WCR</b> Winter Cherry      |

- Custom high pressure laminate finishes will be considered upon request.
- Legs are straight as standard in Chrome (**CHM**) with Black non-marking height adjustable glides.
- Legs are also available in the following finishes: Black (**TBL**), Cloud (**TIV**), Designer White (**TDW**), Fog (**TFO**), Frost (**TFR**), Kalua (**TKA**), Latte (**TLA**), Mocha (**TMO**), Nevada (**TNE**), Sand (**TSN**), Shadow (**TSH**), Toast (**TOA**) and Tungsten (**TTU**). No upcharge. Please specify.
- The unique tapered legs are made of welded steel, with each leg bolted directly to the unit frame. All units have the same standard leg height of 6.5". The leg height makes it easier to clean under the product. Legs are also available in 3" and 8" heights. All heights are available with fixed-to-floor option. Please specify:
  - (S6) Standard height (6.5") w/adjustable glides. No upcharge.      (F6) Standard height (6.5"), fixed to floor. **Add \$90.**
  - (S3) Low (3") w/adjustable glides. No upcharge.      (F3) Low (3"), fixed to floor. **Add \$90.**
  - (S8) High (8") w/adjustable glides. No upcharge.      (F8) High (8"), fixed to floor. **Add \$90.**
- Products can be weighted to reduce the ease of movement. For additional weight options, please specify (**CW**) - see each model for available additional weight and upcharge.
- Tables can be specified with power/USB units, which include one power outlets, one double USB terminals and a Black 120" 3-prong power cord in predetermined locations - **E1**, **E2**, **F3** or **T1** as shown in the electrical illustrations below. Electrical units must be factory installed. **Add \$881** per unit.
- Power/USB units are available with either Jet Black (**J**) face plate with Black power/USB receptacles or with a White (**W**) face plate with White power/USB receptacles.
- Tamperproof fasteners (**TP**) are available. Please specify. **Add \$119.**
- Refer to the Seating price list, under lounge seating for the full range of River+ products available.

ELECTRICAL PLACEMENT

Coffee Tables

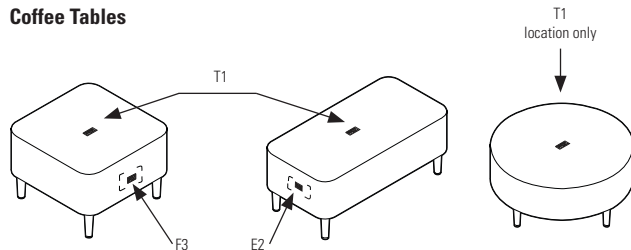

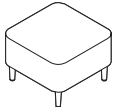
| RIVER+ TABLES  | MODEL#   | DIMENSIONS<br>W x D x H | WT/LB. | CUBIC FT. | LIST PRICE    |
|--|--|-------------------------|--------|-----------|---------------|
|  <p><b>24" Square Laminate Coffee Table</b></p> | R27855   | 24 x 24 x 17            | 40     | 10.7      | <b>\$1329</b> |
|  | Freestanding unit only. For additional weight, please specify ( <b>CW</b> ). <b>Add \$533</b> for 36 lbs.<br>Power/USB units can be specified in position F3 or T1 only. <b>Add \$881.</b> |                         |        |           |               |

Required specifications

Top finish  
Leg finish/height

Optional specifications

Power/USB finish  
Power/USB location  
Tamperproof

# R RIVER+ TABLES

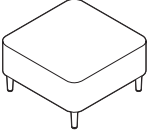
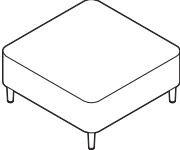
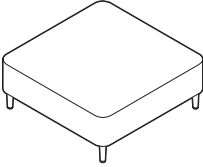
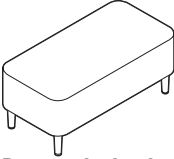
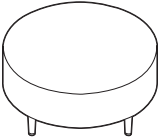
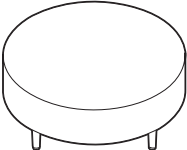
| RIVER+ TABLES   | MODEL # | DIMENSIONS<br>W x D x H | WT/LB. | CUBIC FT. | LIST PRICE    |
|---|---------|-------------------------|--------|-----------|---------------|
|  <p><b>30" Square Laminate Coffee Table</b></p>   | R27856  | 30 x 30 x 17            | 53     | 15.3      | <b>\$1392</b> |
| <p>Freestanding unit only. For additional weight, please specify (CW). <b>Add \$400</b> for 27 lbs. Power/USB units can be specified in position F3 or T1 only. <b>Add \$881.</b></p>     |         |                         |        |           |               |
|  <p><b>36" Square Laminate Coffee Table</b></p>   | R27857  | 36 x 36 x 17            | 75     | 20.6      | <b>\$1541</b> |
| <p>Freestanding unit only. No additional weight is required. Power/USB units can be specified in position F3 or T1 only. <b>Add \$881.</b></p>  |         |                         |        |           |               |
|  <p><b>42" Square Laminate Coffee Table</b></p>   | R27858  | 42 x 42 x 17            | 115    | 26.7      | <b>\$1706</b> |
| <p>Freestanding unit only. No additional weight is required. Power/USB units can be specified in position F3 or T1 only. <b>Add \$881.</b></p>  |         |                         |        |           |               |
|  <p><b>Rectangular Laminate Coffee Table</b></p>   | R27859  | 40 x 20 x 17            | 55     | 14.2      | <b>\$1400</b> |
| <p>Freestanding unit only. For additional weight, please specify (CW). <b>Add \$267</b> for 18 lbs. Power/USB units can be specified in position E1, E2 or T1 only. <b>Add \$881.</b></p> |         |                         |        |           |               |
|  <p><b>36" Dia. Round Laminate Coffee Table</b></p>   | R27860  | 36 x 36 x 17            | 63     | 15.3      | <b>\$1729</b> |
| <p>Freestanding unit only. For additional weight, please specify (CW). <b>Add \$267</b> for 18 lbs. Power/USB units can be specified in position T1 only. <b>Add \$881.</b></p>           |         |                         |        |           |               |
|  <p><b>42" Dia. Round Laminate Coffee Table</b></p>   | R27861  | 42 x 42 x 17            | 85     | 20.6      | <b>\$1889</b> |
| <p>Freestanding unit only. No additional weight is required. Power/USB units can be specified in position T1 only. <b>Add \$881.</b></p>  |         |                         |        |           |               |

**Required specifications**

Top finish  
Leg finish/height

**Optional specifications**

Power/USB finish  
Power/USB location  
Tamperproof



SIRENA TABLES

Notes:

- Modern tables for reception areas, meeting rooms, and private office use.
- Sirena tables are offered in the following finishes to coordinate with Global casegoods and wood seating:

|                            |                               |
|----------------------------|-------------------------------|
| <b>ACJ</b> Absolute Acajou | <b>FCL</b> First Class        |
| <b>ASN</b> Asian Night     | <b>NBL</b> Noce Biondo        |
| <b>AWC</b> Avant Cherry    | <b>NGL</b> Noce Grigio        |
| <b>AWH</b> Avant Honey     | <b>NEL</b> Noce Leggero       |
| <b>BLK</b> Black           | <b>NML</b> Noce Medio         |
| <b>BZD</b> Blizzard        | <b>QTM</b> Quartered Mahogany |
| <b>CMB</b> Clear Maple     | <b>SBY</b> Sheer Beauty       |
| <b>CGY</b> Custom Grey     | <b>SDT</b> Stonedust          |
| <b>DES</b> Dark Espresso   | <b>WHE</b> Walnut Heights     |
| <b>DWT</b> Designer White  | <b>WHC</b> White Chocolate    |
| <b>FAS</b> Fashionista     | <b>WCR</b> Winter Cherry      |

- Laminate tops are 1" thick to coordinate with Global casegoods and wood seating.
- Table legs are available in Black (TBL) or Tungsten (TTU) at no upcharge. Not available in Chrome.
- Legs are 1.5" steel tubing, tapered toward the bottom of the leg to 0.875", equipped with self-leveling pivoting steel glide.

| SIRENA TABLES  | MODEL#                  | DIMENSIONS       | WT/LB. | CUBIC FT. | LIST PRICE    |
|--|-------------------------|------------------|--------|-----------|---------------|
|  <p><b>Coffee Table</b></p>  <p><b>Coffee Table</b></p>  <p><b>End Table</b></p> |                         | <b>W x D x H</b> |        |           |               |
|  | 3400<br>(laminated top) | 48 x 22 x 14.5   | 44     | 17.25     | <b>\$1214</b> |
|  | Rectangle coffee table. |                  |        |           |               |
|  | 3401<br>(laminated top) | 56 x 22 x 14.5   | 50     | 19        | <b>\$1346</b> |
|  | Rectangle coffee table. |                  |        |           |               |
|  | 3402<br>(laminated top) | 17 x 22 x 14.5   | 20     | 7.75      | <b>\$1007</b> |
|  | Rectangle end table.    |                  |        |           |               |

**Required specifications**

- Top finish
- Leg finish



# W WIND TABLES





## WIND TABLES

### Notes:

- Wind tables complement the modern decor of many offices.
- Legs are standard in Chrome (**CHM**). Also available in Black (**TBL**), Shadow (**TSH**) or Tungsten (**TTU**) finish at no upcharge.
- 1" laminate tops are offered in the following finishes to coordinate with Global casegoods and wood seating:

|                            |                               |
|----------------------------|-------------------------------|
| <b>ACJ</b> Absolute Acajou | <b>FCL</b> First Class        |
| <b>ASN</b> Asian Night     | <b>NBL</b> Noce Biondo        |
| <b>AWC</b> Avant Cherry    | <b>NGL</b> Noce Grigio        |
| <b>AWH</b> Avant Honey     | <b>NEL</b> Noce Leggero       |
| <b>BLK</b> Black           | <b>NML</b> Noce Medio         |
| <b>BZD</b> Blizzard        | <b>OTM</b> Quartered Mahogany |
| <b>BRC</b> Brushed Cobalt  | <b>SBY</b> Sheer Beauty       |
| <b>CMB</b> Clear Maple     | <b>SDT</b> Stonedust          |
| <b>CGY</b> Custom Grey     | <b>SOG</b> Storm Grey         |
| <b>DES</b> Dark Espresso   | <b>WHE</b> Walnut Heights     |
| <b>DWT</b> Designer White  | <b>WHC</b> White Chocolate    |
| <b>FAS</b> Fashionista     | <b>WCR</b> Winter Cherry      |

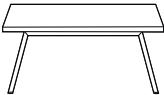
- High pressure laminate (**HPL**) tops are available at a 20% upcharge for models 3366, 3367, 3368, 3870 and 3871. Please specify HPL in addition to the finish. HPL not available for models 3878, 3879 and 3880.

| WIND TABLES   | MODEL #   | DIMENSIONS       | WT/LB. | CUBIC FT.     | LIST PRICE   |
|---|---|------------------|--------|---------------|--------------|
| <br><b>End Table</b><br><br><br><b>Rectangular Coffee Table</b><br><br><br><b>Square Coffee Table</b><br><br><br><b>Round Table</b><br><br><br><b>Round Coffee Table</b> |   | <b>W x D x H</b> |        |               |              |
|   | 3366<br>(laminate top)  | 24 x 24 x 17     | 24     | 11.5          | <b>\$661</b> |
|   | Steel tubular base. Tops are available with a laminate finish. Shipped assembled in 1 carton. |                  |        |               |              |
|   | 3367<br>(laminate top)  | 48 x 20 x 15     | 39     | 16            | <b>\$886</b> |
|   | Steel tubular base. Tops are available with a laminate finish. Shipped assembled in 1 carton. |                  |        |               |              |
| 3368<br>(laminate top)  | 36 x 36 x 15  | 50               | 22     | <b>\$1214</b> |              |
| Steel tubular base. Tops are available with a laminate finish. Shipped assembled in 1 carton.   |   |                  |        |               |              |
| 3870<br>(laminate top)  | 24 x 24 x 17  | 30               | 11.5   | <b>\$721</b>  |              |
| Steel tubular base. Tops are available with a laminate finish. Shipped assembled in 1 carton.   |   |                  |        |               |              |
| 3871<br>(laminate top)  | 36 x 36 x 15  | 50               | 22     | <b>\$1115</b> |              |
| Steel tubular base. Tops are available with a laminate finish. Shipped assembled in 1 carton.   |   |                  |        |               |              |

**Required specifications**  
Top finish

**Optional specifications**  
Edge detail  
Leg finish

WIND TABLES      MODEL #      DIMENSIONS      WT/LB.      CUBIC FT.      LIST PRICE

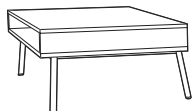

**Freestanding Rectangular End Table**

| W x D x H |              |    |      |               |  |
|-----------|--------------|----|------|---------------|--|
| 3878      | 20 x 25 x 16 | 30 | 11.5 | <b>\$1112</b> |  |

Steel tubular base. Laminate top is 5" thick with opening on front for storage and visual recess at rear. Shipped assembled in 1 carton.

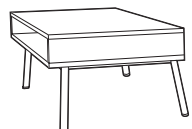

**Freestanding Corner Table**

|      |              |    |      |               |  |
|------|--------------|----|------|---------------|--|
| 3879 | 25 x 25 x 16 | 32 | 11.5 | <b>\$1241</b> |  |
|------|--------------|----|------|---------------|--|

Steel tubular base. Laminate top is 5" thick with opening on front for storage and visual recess at rear. Shipped assembled in 1 carton.

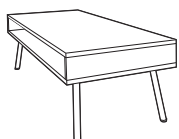

**Freestanding Coffee Table**

|      |              |    |    |               |  |
|------|--------------|----|----|---------------|--|
| 3880 | 54 x 20 x 15 | 39 | 16 | <b>\$1393</b> |  |
|------|--------------|----|----|---------------|--|

Steel tubular base. Laminate top is 5" thick with opening on front for storage and visual recess at rear. Shipped assembled in 1 carton.

**Required specifications**  
Top finish

**Optional specifications**  
Edge detail  
Leg finish

# W WORK TABLES

## WORK TABLES

### Notes:

- Work tables are offered in the following top finishes to coordinate with Global casegoods and wood seating:

|                            |                               |
|----------------------------|-------------------------------|
| <b>ACJ</b> Absolute Acajou | <b>FCL</b> First Class        |
| <b>ASN</b> Asian Night     | <b>NBL</b> Noce Biondo        |
| <b>AWC</b> Avant Cherry    | <b>NGL</b> Noce Grigio        |
| <b>AWH</b> Avant Honey     | <b>NEL</b> Noce Leggero       |
| <b>BLK</b> Black           | <b>NML</b> Noce Medio         |
| <b>BZD</b> Blizzard        | <b>QTM</b> Quartered Mahogany |
| <b>BRC</b> Brushed Cobalt  | <b>SBY</b> Sheer Beauty       |
| <b>CMB</b> Clear Maple     | <b>SDT</b> Stonedust          |
| <b>CGY</b> Custom Grey     | <b>SOG</b> Storm Grey         |
| <b>DES</b> Dark Espresso   | <b>WHE</b> Walnut Heights     |
| <b>DWT</b> Designer White  | <b>WHC</b> White Chocolate    |
| <b>FAS</b> Fashionista     | <b>WCR</b> Winter Cherry      |

- T-mold (**TM**) edging available in Black (**BLK**), please specify. No upcharge.
- Legs are available in Chrome (**CHM**) or Black (**TBL**).

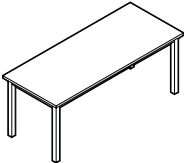
| WORK TABLES  | MODEL # | DIMENSIONS   | WT/LB. | CUBIC FT. | LIST PRICE   |
|--|---------|--------------|--------|-----------|--------------|
|  |         | W x D x H    |        |           |              |
|  <p><b>Work Tables</b></p>   | AT7236  | 72 x 36 x 29 | 110    | 6         | <b>\$784</b> |
|  | AT7230  | 72 x 30 x 29 | 100    | 5         | <b>\$616</b> |
|  | AT6030  | 60 x 30 x 29 | 90     | 5         | <b>\$540</b> |
| <p>1" high performance thermally fused laminate with self edge top. Black metal skirt. Rectangle top with metal legs and leveling glides. Self edge is standard. Black legs are optional, no upcharge. Shipped easy to assemble in 1 carton.</p> |         |              |        |           |              |

### Required specifications

Top finish  
Leg finish

### Optional specifications

HP laminate