

tables

café, meeting and conference

Alba306
Boardroom309

Swap.....321

training

2gether358
Bungee361
Bungee SL379
Duet411

Edventure.....414
ConnecTABLES396
Junction424
Zook431

reception and occasional

Citi443
Cylinder and cube tables ..445
River+447

Sirena.....449
Wind450
Work tables452

tables

café, meeting and conference



Alba

306



Boardroom

309



Swap

321





Contemporary and stylish meeting tables with unique metal bases. Alba tables offer a variety of options to suit the needs of any office.

Tops are available in round and square shapes.

Sculpted four-legged base is available in Black (**BLK**) or Tungsten 2 (**TU2**).

Five edge options - self, bullnose, T-mold, built up and slant. Slant edge and metal base finishes are available in either Black (**BLK**) or Tungsten 2 (**TU2**).

No matter the size of the space or the style of the office, Global's laminate meeting tables will work in any setting.

Designed exclusively for Global by world renowned designer Zooney Chu.

Features and Benefits

- All tops and bases are assembled using a metal-to-metal connection.
- All tops are 1.125" thick.
- Bullnose edges available in Black or Grey.
- T-mold edge available in Black and Grey, also available in 22 coordinating laminate finishes.
- Self edge and built-up self edge available in same color as laminate finish.
- Slant edge is available in Black or Tungsten 2.
- All edges available on all tables.
- All metal bases are available in Black or Tungsten 2.

GENERAL INFORMATION

- Designed by Zooney Chu.
- Ideal for small meeting spaces or cafeteria tables; 30" round or square top four-legged base.
- Five edge options: self (**SE**), bullnose (**BN**), T-mold (**TM**), built-up (**BU**) and slant (**ZS**).
- Sculpted four-legged base available in Black (**BLK**) or Tungsten 2 (**TU2**).
- For environmental certifications, please visit globalfurnituregroup.com.

CONSTRUCTION

- All tops are 1.125" thick with high performance, thermally fused laminate on both sides. A 1.75" built-up self edge is available on all models.
- All tops and bases use a metal-to-metal connection, allowing for easy installation.

EDGE OPTIONS

- Self, bullnose, T-mold, built-up, and slant edges are available on all models. Corners of rectangular, square and boat tables ordered with T-mold or bullnose will be rounded.
- **Bullnose** edge is available in Black (**BLK**) only.
- **T-mold** edge is available in Black (**BLK**) or coordinating laminate finish (**ME**).
- **Slant** edge is available in Black (**BLK**) or Tungsten (**TU2**).
- **Self** edge and **built-up** edges are same color as laminate finish.

LAMINATE FINISHES

ACJ	Absolute Acajou	FCL	First Class
ASN	Asian Night	NBL	Noce Biondo
AWC	Avant Cherry	NGL	Noce Grigio
AWH	Avant Honey	NEL	Noce Leggero
BLK	Black	NML	Noce Medio
BZD	Blizzard	QTM	Quartered Mahogany
BRC	Brushed Cobalt	SBY	Sheer Beauty
CMB	Clear Maple	SDT	Stonedust
CGY	Custom Grey	SOG	Storm Grey
DES	Dark Espresso	WHE	Walnut Heights
DWT	Designer White	WHC	White Chocolate
FAS	Fashionista	WCR	Winter Cherry

- The above laminate finishes are available in **high pressure**. Contact our Specials Department for a quote.
- If other than a Global standard laminate finish is preferred, contact our Specials Department. Information needed includes the name of the laminate manufacturer, color name, number and table model. You will then be given a quote for this special order.

A ALBA™ TABLES

ROUND TOPS



Round Top - Four Leg Base

MODEL #	DIMENSIONS	WT/LB.	CUBIC FT.	LIST PRICE
	W x D x H			
C30CF	30 x - x 28.5	54.5	7.06	\$536

Please specify edge detail: self edge (**SE**), bullnose (**BN**), T-mold (**TM**), built-up (**BU**) or slant edge (**ZS**).
Shipped easy to assemble in 2 cartons.

SQUARE TOPS



Square Top - Four Leg Base

C30SF	30 x 30 x 28.5	54.5	7.06	\$536
-------	----------------	------	------	--------------

Please specify edge detail: self edge (**SE**), bullnose (**BN**), T-mold (**TM**), built-up (**BU**) or slant edge (**ZS**).
Shipped easy to assemble in 2 cartons.

Required specifications

Finish
Edge detail

BOARDROOM & CAFETERIA TABLES



Sturdy and economically priced, Global boardroom and cafeteria tables are an excellent choice. All tables are made from thermally fused, high performance laminate and are easy to maintain.

Choose from four attractive table edges: self edge, bullnose, T-mold, or built-up self edge. Available in a variety of colors, all edge options are durable and wear-resistant.

Table tops are offered in six shapes - rectangular, racetrack, boat, elliptical, square and round - and a variety of bases including slab, cross, drum and arch. Add to this an impressive variety of laminate finishes that can be mixed and matched and you'll find Global can satisfy any and every business need.

From small meeting rooms to large boardrooms, from traditional to contemporary, Global's incredible range of table components, shapes, sizes and colors will enhance any office decor.

Features and Benefits

- Tables 144" or less are standard in one piece.
- One piece tops can be cut into two pieces for an upcharge.
- All tops are 1.125" thick.
- Tops and bases boxed as appropriate.
- Custom finish laminate tables available as special order.
- Bullnose edges available in Black or Grey.
- T-mold edge available in Black, Grey or coordinating laminate finish.
- Self edge and built-up self edge available in same color as laminate finish.
- All edges available on all tables.
- Metal legs and bases are standard in Chrome - also available in Black or Grey.

B BOARDROOM & CAFETERIA TABLES - NOTES

GENERAL INFORMATION

- Practical and economical table solutions for cafeteria, meeting spaces and more.
- All tables are 29" high.
- Tops are thermally fused laminate with 45 lb. density particle board core.
- Multiple base styles available in thermally fused laminate or metal.
- Tables 72", 84", 96", 120", 144" are standard in one piece.
- One piece tops can be cut into two pieces for an upcharge.
- Six top shapes: rectangular, racetrack, boat, square, round, barrel and elliptical.
- Four edge options: self edge, bullnose, T-mold or built-up self edge.
- For environmental certifications, please visit globalfurnituregroup.com.

CONSTRUCTION

- All tables are 29" high and made of 45 lb. density particle board covered on both sides with high performance, thermally fused laminate. Table width is nominal.
- All tables with cross bases use Blum fasteners.
- Round and square tops up to 60" dia. are 1" thick; all other tops are 1.125" thick thick. Both thickness are in high performance, thermally fused laminate.
- Tops with built-up (BU) edge option have a 1.75" built-up self edge.
- Tops are crated and bases boxed or crated as appropriate.
- All tops are **PRE-MARKED** as to base location, and the slot and hook assembly method (on selected tables) allows for easy installation.
- All racetrack, boat and rectangular tables 144" and under are standard with two drum, slab, arch, 2-legged, or tubular bases and are priced accordingly.
- Custom table sizes must be quoted. Contact our Specials Department.

LAMINATE FINISHES

ACJ Absolute Acajou	FCL First Class
ASN Asian Night	NBL Noce Biondo
AWC Avant Cherry	NGL Noce Grigio
AWH Avant Honey	NEL Noce Leggero
BLK Black	NML Noce Medio
BZD Blizzard	QTM Quartered Mahogany
BRC Brushed Cobalt	SBY Sheer Beauty
CMB Clear Maple	SDT Stonedust
CGY Custom Grey	SOG Storm Grey
DES Dark Espresso	WHE Walnut Heights
DWT Designer White	WHC White Chocolate
FAS Fashionista	WCR Winter Cherry

- The above laminate finishes are also available in **high pressure laminate**. Contact our Specials Department for a quote.
- All tables with one or more drum bases require a minimum of 50 lbs. of sand in each base for stability. Sand is not included, to be sourced locally.

METAL BASE FINISHES

- Available for CRRxx, CASxx, TCSxx, CARxx, TCRxx and CRSxx tables.

Paint finishes

TBL Black	TIN Ink
TBZ Buzz Blue	TKA Kalua
TCC Cactus	TLA Latte
TCR Carrot	TMO Mocha
TIV Cloud	TNE Nevada
TDW Designer White	TSN Sand
TDJ Dijon	TSR Scarlet
TEG Eggplant	TSH Shadow
TFO Fog	TOA Toast
TFR Frost	TTU Tungsten

Plated finishes - upcharge applies

ACO Antique Copper	CHM Chrome
BCH Brushed Chrome	SBR Satin Brass

EDGE OPTIONS

- Self, bullnose, T-mold and built-up edges are available on all models. Corners of rectangular, square and boat tables ordered with T-mold or bullnose will be rounded.
- **Bullnose** edge is available in Black (**BLK**) only.
- **T-mold** edge is available in Black (**BLK**) or coordinating laminate finish (**ME**) with upcharge (5%).
- **Self edge and built-up** edges are same color as laminate finish.

GROMMETS

- Grommets available in standard table top locations (left, center or right). Order as: **FOG1, FOG2** or **FOG3**. **Add \$91**.
- Grommet hole dimensions are 3.25" wide x 1.875" deep.

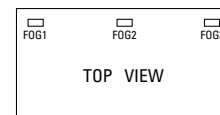
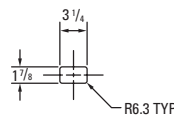

- Actual grommet locations will vary according to base selection.

POWER BLOCK

- A power block (model **PMSPDM**) may be ordered on all worksurfaces.
- A power block is a rectangular worksurface power/data module with one electrical duplex receptacle and two data (RJ45) receptacles. 9' Black cord included. Power block dimensions are 6.5"W x 3.5"D x 2.75"H.
- Actual power block locations vary according to base selection. The locations will be left (E1), center (E2), and right (E3). **Example:** 8' table with drum base does not have a modesty panel, so the power block (E2) can be perfectly centered in the table. An 8' table with a slab base has the modesty panel, so the power block (E2) will be offset alongside the modesty panel.
- To purchase a power block, you must specify both the power block cut-out location and the power block model #. Order power block as **PMSPDM**. **Add \$268**.
- Power blocks are available in standard worksurface locations (left, center or right). Order as **E1, E2** or **E3**. **Add \$91**.

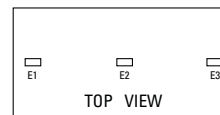
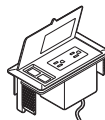

Power block **PMSPDM**. **Add \$268**.

Specify location **E1, E2** or **E3**. **Add \$91**.

SPECIFICATIONS

- Specifications marked with an * are applicable to only those products which have the * symbol beside the product name.

SHIPPING

- Shipped easy to assemble.

BASE SIZE CHART (table width is nominal)

Round or Square Tops:

Top	Slab	Drum	Arch	Cross	4 Leg	Trumpet	Tube
36"	N/A	N/A	N/A	N/A	32"	24"	30"
42"	N/A	18"	N/A	30"	32"	24"	30"
48"	N/A	24"	N/A	30"	32"	N/A	30"
60"	N/A	30"	N/A	36"	N/A	N/A	N/A

Rectangular, Boat or Racetrack Tops:

Top	Slab	Drum	Arch	Cross	2 Leg	Trumpet	Tube
36" x 72"	24"	18"	24"	N/A	32"	N/A	30"
48" x 96"	28"	18"	28"	N/A	32"	N/A	30"
48" x 120"	28"	24"	28"	N/A	32"	N/A	30"
48" x 144"	28"	24"	28"	N/A	32"	N/A	30"

TABLE NOTES - ESTIMATED CAPACITY

- Use the following to determine the size of a round table and the number of chairs needed for a conference area. All estimates are based on an average chair width of 23" with a 4" clearance between chairs. Adjust accordingly for a different chair size.

NUMBER OF CHAIRS

Top Size	Round	Square	Rectangular	Boat	Racetrack	Elliptical
30 x 30	3	3	N/A	N/A	N/A	N/A
36 x 36	4	4	N/A	N/A	N/A	N/A
42 x 42	4	4	N/A	N/A	N/A	N/A
48 x 48	4	4	N/A	N/A	N/A	N/A
60 x 60	5	6	N/A	N/A	N/A	N/A
30 x 60	N/A	N/A	4-6	4-6	4-6	4
36 x 72	N/A	N/A	4-6	4-6	4-6	4
44 x 84	N/A	N/A	6-8	6-8	6-8	6
48 x 96	N/A	N/A	6-8	6-8	6-8	6
48 x 120	N/A	N/A	8-10	8-10	8-10	8
48 x 144	N/A	N/A	10-12	10-12	10-12	10
48 x 168	N/A	N/A	12-14	12-14	12-14	12
48 x 192	N/A	N/A	14-16	14-16	14-16	14
48 x 216	N/A	N/A	16-18	16-18	16-18	16
48 x 240	N/A	N/A	18-20	18-20	18-20	18
48 x 264	N/A	N/A	20-22	20-22	20-22	20
48 x 288	N/A	N/A	22-24	22-24	22-24	22

BASE OPTIONS

Laminate

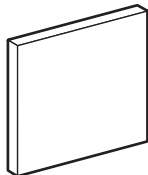

slab

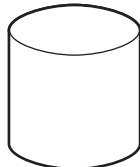

drum

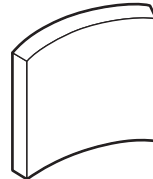

arch

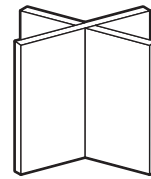

cross



self edge

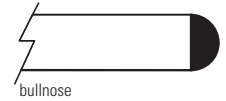

bullnose

Metal



2-leg



4-leg

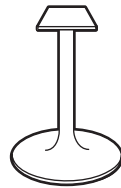

trumpet

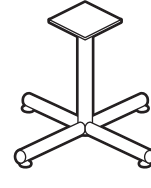

tube

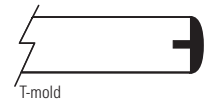

T-mold

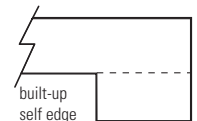

built-up self edge

T-mold matching edge available - add 5% upcharge.

TABLE TOP STYLES



square

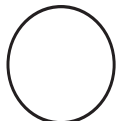

round

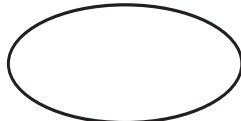

elliptical



racetrack

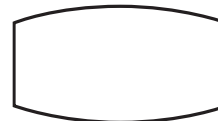

boat



rectangular

B BOARDROOM & CAFETERIA TABLES

ROUND TOPS	MODEL #	DIMENSIONS	WT/LB.	CUBIC FT.	LIST PRICE	BCH / CHM	ACO / SBR
------------	---------	------------	--------	-----------	------------	-----------	-----------

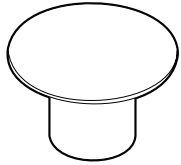

Round Top - Drum Base*

	W x D x H						
42CZ	42 x - x 29	150	12.5	\$1144	N/A	N/A	
48CZ	48 x - x 29	145	13.25	\$1264	N/A	N/A	
60CZ	60 x - x 29	194	19	\$1662	N/A	N/A	

Please specify edge detail: self edge (**SE**), bullnose (**BN**), T-mold (**TM**) or built-up (**BU**).

Shipped easy to assemble in 2 cartons.

- All drum bases require approximately 50 lbs. of sand in each base for adequate stability. Sand is not included.



Round Top - Three Legs*

48C	48 x - x 29	99	6.5	\$1309	N/A	N/A	
60C	60 x - x 29	140	14.4	\$1534	N/A	N/A	

Please specify edge detail: self edge (**SE**), bullnose (**BN**), T-mold (**TM**) or built-up (**BU**).

Shipped easy to assemble in 2 cartons.



Round Top - Three Tubular Legs*

60RC	60 x - x 29	140	14.4	\$1769	N/A	N/A	
------	-------------	-----	------	---------------	-----	-----	--

Please specify edge detail: self edge (**SE**), bullnose (**BN**), T-mold (**TM**) or built-up (**BU**).

Shipped easy to assemble in 2 cartons.



Round Top - Four Leg Base

CAR30	30 x - x 29.5	35	9.49	\$431	\$40	\$242	
CAR36	36 x - x 29.5	42	12.31	\$538	\$73	\$273	
CAR42	42 x - x 29.5	52	12.61	\$621	\$73	\$273	

Please specify edge detail: self edge (**SE**), bullnose (**BN**), T-mold (**TM**) or built-up (**BU**).

Shipped easy to assemble in 2 cartons.

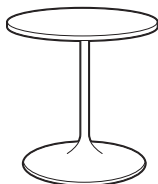

Round Top - Trumpet Base

TCR24	24 x - x 29.5	30	9.09	\$497	\$73	\$299	
TCR30	30 x - x 29.5	35	9.49	\$590	\$73	\$299	
TCR36	36 x - x 29.5	42	12.31	\$707	\$73	\$299	
TCR42	42 x - x 29.5	52	12.61	\$787	\$73	\$299	

Please specify edge detail: self edge (**SE**), bullnose (**BN**), T-mold (**TM**) or built-up (**BU**).

Shipped easy to assemble in 2 cartons.

Required specifications

Top finish
Base finish
Edge detail

Optional specifications

Grommet*
Power block cut-out*

Accessories

Power block*

ROUND TOPS



Round Top - Tubular Base

MODEL #	DIMENSIONS W x D x H	WT/LB.	CUBIC FT.	LIST PRICE	BCH / CHM	ACO / SBR
CRR24	24 x - x 29.5	30	9.09	\$417	\$78	\$327
CRR30	30 x - x 29.5	35	9.49	\$526	\$78	\$327
CRR36	36 x - x 29.5	42	12.31	\$630	\$78	\$327
CRR42	42 x - x 29.5	52	12.61	\$718	\$78	\$327
CRR48	48 x - x 29.5	10	13.26	\$863	\$78	\$327

Please specify edge detail: self edge (**SE**), bullnose (**BN**), T-mold (**TM**) or built-up (**BU**).
Shipped easy to assemble in 2 cartons.



Round Top - Cross Base*

42CX	42 x - x 29	100	3.5	\$1144	N/A	N/A
48CX	48 x - x 29	120	4.25	\$1264	N/A	N/A
60CX	60 x - x 29	144	6.2	\$1662	N/A	N/A

Please specify edge detail: self edge (**SE**), bullnose (**BN**), T-mold (**TM**) or built-up (**BU**).
Shipped easy to assemble in 2 cartons.

SQUARE TOPS

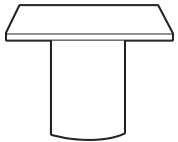

Square Top - Drum Base*

42SZ	42 x 42 x 29	100	12.5	\$1144	N/A	N/A
48SZ	48 x 48 x 29	160	13.16	\$1264	N/A	N/A
60SZ	60 x 60 x 29	190	19	\$1662	N/A	N/A

Please specify edge detail: self edge (**SE**), bullnose (**BN**), T-mold (**TM**) or built-up (**BU**).
Shipped easy to assemble in 2 cartons.

- All drum bases require approximately 50 lbs. of sand in each base for adequate stability. Sand is not included.

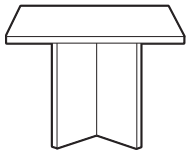

Square Top - Cross Base*

42SH	42 x 42 x 29	100	3.5	\$1144	N/A	N/A
48SH	48 x 48 x 29	120	4.25	\$1264	N/A	N/A
60SH	60 x 60 x 29	144	6.2	\$1662	N/A	N/A

Please specify edge detail: self edge (**SE**), bullnose (**BN**), T-mold (**TM**) or built-up (**BU**).
Shipped easy to assemble in 2 cartons.



Square Top - Four Leg Base

CAS30	30 x 30 x 29.5	37	9.49	\$431	\$40	\$242
CAS36	36 x 36 x 29.5	44	12.31	\$538	\$73	\$273
CAS42	42 x 42 x 29.5	54	12.61	\$621	\$73	\$273

Please specify edge detail: self edge (**SE**), bullnose (**BN**), T-mold (**TM**) or built-up (**BU**).
Shipped easy to assemble in 2 cartons.



Square Top - Trumpet Base

TCS24	24 x 24 x 29.5	32	9.09	\$497	\$73	\$299
TCS30	30 x 30 x 29.5	37	9.49	\$590	\$73	\$299
TCS36	36 x 36 x 29.5	44	12.31	\$707	\$73	\$299
TCS42	42 x 42 x 29.5	54	12.61	\$787	\$73	\$299

Please specify edge detail: self edge (**SE**), bullnose (**BN**), T-mold (**TM**) or built-up (**BU**).
Shipped easy to assemble in 2 cartons.

Required specifications

Top finish
Base finish
Edge detail

Optional specifications

Grommet*
Power block cut-out*

Accessories

Power block*

B BOARDROOM & CAFETERIA TABLES

SQUARE TOPS



Square Top - Tubular Base

MODEL #	DIMENSIONS W x D x H	WT/LB.	CUBIC FT.	LIST PRICE	BCH / CHM	ACO / SBR
CRS30	30 x 30 x 29.5	37	9.49	\$526	\$78	\$327
CRS36	36 x 36 x 29.5	44	12.31	\$630	\$78	\$327
CRS42	42 x 42 x 29.5	54	12.61	\$718	\$78	\$327

Please specify edge detail: self edge (**SE**), bullnose (**BN**), T-mold (**TM**) or built-up (**BU**).
Shipped easy to assemble in 2 cartons.

RECTANGULAR TOPS

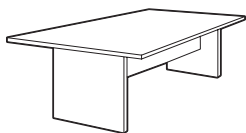

Rectangular Top - Two Slab Bases*

CT6RX	72 x 36 x 29	114	4.6	\$1811	N/A	N/A
CT8RX	96 x 36 x 29	144	7.3	\$1945	N/A	N/A
CT8WRX	96 x 48 x 29	154	7.3	\$2064	N/A	N/A

Please specify edge detail: self edge (**SE**), bullnose (**BN**), T-mold (**TM**) or built-up (**BU**).
Shipped easy to assemble in 3 cartons (except CT6RX shipped easy to assemble in 2 cartons).

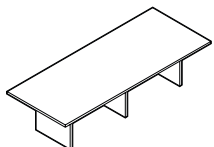

Rectangular Top - Three Slab Bases*

CT10RX	120 x 36 x 29	216	8.25	\$2968	N/A	N/A
CT10WRX	120 x 48 x 29	251	8.75	\$3330	N/A	N/A
CT12WRX	144 x 48 x 29	276	10.6	\$3499	N/A	N/A

Please specify edge detail: self edge (**SE**), bullnose (**BN**), T-mold (**TM**) or built-up (**BU**).
Shipped easy to assemble in 2 cartons.

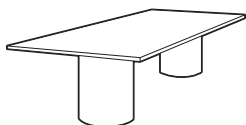

Rectangular Top - Two Drum Bases*

CT6RZ	72 x 36 x 29	164	15.32	\$2064	N/A	N/A
CT8RZ	96 x 36 x 29	194	16.35	\$2193	N/A	N/A
CT8WRZ	96 x 48 x 29	204	17.7	\$2324	N/A	N/A

Please specify edge detail: self edge (**SE**), bullnose (**BN**), T-mold (**TM**) or built-up (**BU**).
Shipped easy to assemble in 2 cartons.
• All drum bases require approximately 50 lbs. of sand in each base for adequate stability. Sand is not included.

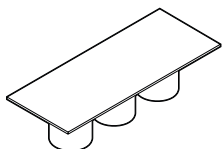

Rectangular Top - Three Drum Bases*

CT10RZ	120 x 36 x 29	291	23.65	\$3206	N/A	N/A
CT10WRZ	120 x 48 x 29	326	25.3	\$3563	N/A	N/A
CT12WRZ	144 x 48 x 29	351	26.67	\$3766	N/A	N/A

Please specify edge detail: self edge (**SE**), bullnose (**BN**), T-mold (**TM**) or built-up (**BU**).
Shipped easy to assemble in 2 cartons.
• All drum bases require approximately 50 lbs. of sand in each base for adequate stability. Sand is not included.

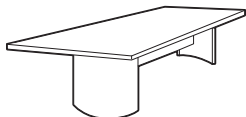

Rectangular Top - Two Arch Bases*

CT6RA	72 x 36 x 29	114	5.6	\$2064	N/A	N/A
CT8RA	96 x 36 x 29	144	7.1	\$2193	N/A	N/A
CT8WRA	96 x 48 x 29	154	10.15	\$2324	N/A	N/A
CT10RA	120 x 36 x 29	174	9.85	\$3206	N/A	N/A
CT10WRA	120 x 48 x 29	184	11.5	\$3563	N/A	N/A
CT12WRA	144 x 48 x 29	194	13.25	\$3766	N/A	N/A

Please specify edge detail: self edge (**SE**), bullnose (**BN**), T-mold (**TM**) or built-up (**BU**).
Shipped easy to assemble in 3 cartons (except CT6RA shipped easy to assemble in 2 cartons).

Required specifications

Top finish
Base finish (square tops)
Edge detail

Optional specifications

Grommet*
Power block cut-out*

Accessories

Power block*

RECTANGULAR TOPS



Rectangular Top - Two Legs

MODEL #	DIMENSIONS W x D x H	WT/LB.	CUBIC FT.	LIST PRICE
CT6R	72 x 36 x 29	110	13.75	\$1202
CT8R	96 x 36 x 29	140	14.75	\$1357
CT8WR	96 x 48 x 29	150	16.25	\$1490

Please specify edge detail: self edge (**SE**), bullnose (**BN**), T-mold (**TM**) or built-up (**BU**).
Shipped easy to assemble in 2 cartons.

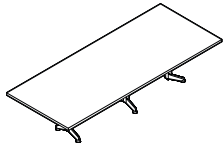

Rectangular Top - Three Legs

CT10R	120 x 36 x 29	210	15.75	\$1921
CT10WR	120 x 48 x 29	245	17.5	\$2321
CT12WR	144 x 48 x 29	270	19	\$2510

Please specify edge detail: self edge (**SE**), bullnose (**BN**), T-mold (**TM**) or built-up (**BU**).
Shipped easy to assemble in 2 cartons.



Rectangular Top - Two Tubular Legs

CR6R	72 x 36 x 29	110	13.75	\$1357
CR8R	96 x 36 x 29	10	14.75	\$1521
CR8WR	96 x 48 x 29	150	16.25	\$1648

Please specify edge detail: self edge (**SE**), bullnose (**BN**), T-mold (**TM**) or built-up (**BU**).
Shipped easy to assemble in 2 cartons.

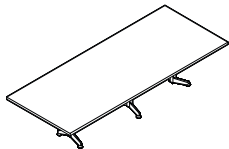

Rectangular Top - Three Tubular Legs

CR10R	120 x 36 x 29	210	15.75	\$2151
CR10WR	120 x 48 x 29	245	17.5	\$2558
CR12WR	144 x 48 x 29	270	19	\$2748

Please specify edge detail: self edge (**SE**), bullnose (**BN**), T-mold (**TM**) or built-up (**BU**).
Shipped easy to assemble in 2 cartons.

BOAT TOPS

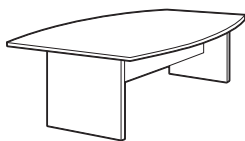

Boat Top - Two Slab Bases

CT6BX	72 x 36 x 29	114	4.6	\$1811
CT8BX	96 x 36 x 29	144	7.3	\$1945
CT8WBX	96 x 48 x 29	154	7.3	\$2064

Please specify edge detail: self edge (**SE**), bullnose (**BN**), T-mold (**TM**) or built-up (**BU**).
Shipped easy to assemble in 3 cartons (except CT6BX shipped easy to assemble in 2 cartons).

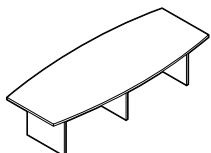

Boat Top - Three Slab Bases

CT10BX	120 x 36 x 29	216	8.25	\$2968
CT10WBX	120 x 48 x 29	251	8.25	\$3330
CT12WBX	144 x 48 x 29	276	10.6	\$3499

Please specify edge detail: self edge (**SE**), bullnose (**BN**), T-mold (**TM**) or built-up (**BU**).
Shipped easy to assemble in 3 cartons.

Required specifications

Top finish
Base finish (rectangular tops)
Edge detail

Optional specifications

Grommet
Power block cut-out

Accessories

Power block

B BOARDROOM & CAFETERIA TABLES

BOAT TOPS

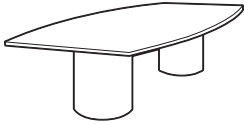

Boat Top - Two Drum Bases

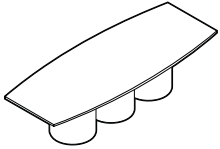

Boat Top - Three Drum Bases

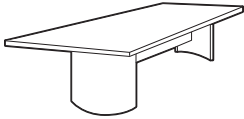

Boat Top - Two Arch Bases



Boat Top - Two Legs*

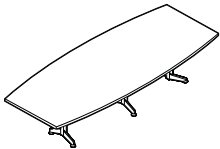

Boat Top - Three Legs*



Boat Top - Two Tubular Legs*

MODEL #	DIMENSIONS	WT/LB.	CUBIC FT.	LIST PRICE
---------	------------	--------	-----------	------------

W x D x H

CT6BZ	72 x 36 x 29	164	15.32	\$1993
CT8BZ	96 x 36 x 29	194	16.35	\$2193
CT8WBZ	96 x 48 x 29	204	17.7	\$2244

Please specify edge detail: self edge (**SE**), bullnose (**BN**), T-mold (**TM**) or built-up (**BU**).
Shipped easy to assemble in 2 cartons.

- All drum bases require approximately 50 lbs. of sand in each base for adequate stability. Sand is not included.

CT10BZ	120 x 36 x 29	291	23.65	\$3206
CT10WBZ	120 x 48 x 29	326	25.3	\$3563
CT12WBZ	144 x 48 x 29	351	26.67	\$3734

Please specify edge detail: self edge (**SE**), bullnose (**BN**), T-mold (**TM**) or built-up (**BU**).
Shipped easy to assemble in 2 cartons.

- All drum bases require approximately 50 lbs. of sand in each base for adequate stability. Sand is not included.

CT6BA	72 x 36 x 29	114	5.6	\$2064
CT8BA	96 x 36 x 29	144	7.1	\$2193
CT8WBA	96 x 48 x 29	154	10.15	\$2324
CT10BA	120 x 36 x 29	174	9.85	\$3206
CT10WBA	120 x 48 x 29	184	11.5	\$3563
CT12WBA	144 x 48 x 29	194	13.25	\$3734

Please specify edge detail: self edge (**SE**), bullnose (**BN**), T-mold (**TM**) or built-up (**BU**).
Shipped easy to assemble in 3 cartons, (except CT6BA shipped easy to assemble in 2 cartons).

CT6B	72 x 36 x 29	110	13.75	\$1202
CT8B	96 x 36 x 29	140	14.75	\$1357
CT8WB	96 x 48 x 29	150	16.25	\$1490

Please specify edge detail: self edge (**SE**), bullnose (**BN**), T-mold (**TM**) or built-up (**BU**).
Shipped easy to assemble in 2 cartons.

CT10B	120 x 36 x 29	210	15.75	\$1921
CT10WB	120 x 48 x 29	245	17.5	\$2321
CT12WB	144 x 48 x 29	270	19	\$2510

Please specify edge detail: self edge (**SE**), bullnose (**BN**), T-mold (**TM**) or built-up (**BU**).
Shipped easy to assemble in 2 cartons.

CR6B	72 x 36 x 29	110	13.75	\$1357
CR8B	96 x 36 x 29	140	14.75	\$1503
CR8WB	96 x 48 x 29	150	16.25	\$1648

Please specify edge detail: self edge (**SE**), bullnose (**BN**), T-mold (**TM**) or built-up (**BU**).
Shipped easy to assemble in 2 cartons.

Required specifications

Top finish
Leg finish*
Edge detail

Optional specifications

Grommet
Power block cut-out

Accessories

Power block

BOAT TOPS



Boat Top - Three Tubular Legs*

MODEL #	DIMENSIONS W x D x H	WT/LB.	CUBIC FT.	LIST PRICE
CR10WB	120 x 48 x 29	245	23	\$2558
CR12WB	144 x 48 x 29	270	19	\$2748

Please specify edge detail: self edge (**SE**), bullnose (**BN**), T-mold (**TM**) or built-up (**BU**).
Shipped easy to assemble in 2 cartons.

RACETRACK TOPS

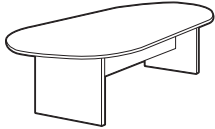

Racetrack Top - Two Slab Bases

RT6X	72 x 36 x 29	114	4.6	\$1811
RT8X	96 x 36 x 29	144	7.3	\$1945
RT8WX	96 x 48 x 29	154	7.3	\$2064

Please specify edge detail: self edge (**SE**), bullnose (**BN**), T-mold (**TM**) or built-up (**BU**).
Shipped easy to assemble in 3 cartons (except RT6X shipped easy to assemble in 2 cartons).

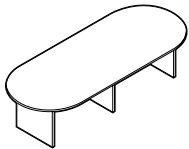

Racetrack Top - Three Slab Bases

RT10X	120 x 36 x 29	216	8.25	\$2968
RT10WX	120 x 48 x 29	251	8.75	\$3330
RT12WX	144 x 48 x 29	276	10.6	\$3499

Please specify edge detail: self edge (**SE**), bullnose (**BN**), T-mold (**TM**) or built-up (**BU**).
Shipped easy to assemble in 3 cartons.

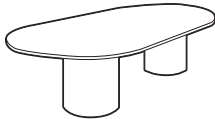

Racetrack Top - Two Drum Bases

RT6Z	72 x 36 x 29	164	15.32	\$2064
RT8Z	96 x 36 x 29	194	16.35	\$2193
RT8WZ	96 x 48 x 29	204	17.7	\$2324

Please specify edge detail: self edge (**SE**), bullnose (**BN**), T-mold (**TM**) or built-up (**BU**).
Shipped easy to assemble in 2 cartons.
• All drum bases require approximately 50 lbs. of sand in each base for adequate stability. Sand is not included.

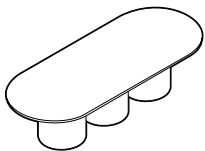

Racetrack Top - Three Drum Bases

RT10Z	120 x 36 x 29	291	23.65	\$3206
RT10WZ	120 x 48 x 29	326	25.3	\$3563
RT12WZ	144 x 48 x 29	351	26.67	\$3734

Please specify edge detail: self edge (**SE**), bullnose (**BN**), T-mold (**TM**) or built-up (**BU**).
Shipped easy to assemble in 3 cartons.
• All drum bases require approximately 50 lbs. of sand in each base for adequate stability. Sand is not included.

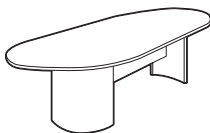

Racetrack Top - Two Arch Bases

RT6A	72 x 36 x 29	114	5.6	\$1993
RT8A	96 x 36 x 29	144	7.1	\$2193
RT8WA	96 x 48 x 29	154	10.15	\$2244
RT10A	120 x 36 x 29	174	9.85	\$3206
RT10WA	120 x 48 x 29	184	11.5	\$3563
RT12WA	144 x 48 x 29	194	13.25	\$3734

Please specify edge detail: self edge (**SE**), bullnose (**BN**), T-mold (**TM**) or built-up (**BU**).
Shipped easy to assemble in 3 cartons (except RT6A shipped easy to assemble in 2 cartons).

Required specifications

Top finish
Leg finish*
Edge detail

Optional specifications

Grommet
Power block cut-out

Accessories

Power block

B BOARDROOM & CAFETERIA TABLES

RACETRACK TOPS



Racetrack Top - Two Legs*

MODEL #	DIMENSIONS	WT/LB.	CUBIC FT.	LIST PRICE
---------	------------	--------	-----------	------------

W x D x H

RT6	72 x 36 x 29	110	13.75	\$1202
RT8	96 x 36 x 29	140	14.75	\$1357
RT8W	96 x 48 x 29	150	16.25	\$1490

Please specify edge detail: self edge (**SE**), bullnose (**BN**), T-mold (**TM**) or built-up (**BU**).
Shipped easy to assemble in 2 cartons.

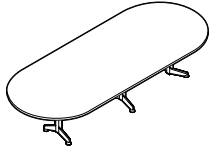

Racetrack Top - Three Legs*

RT10	120 x 36 x 29	210	15.75	\$1921
RT10W	120 x 48 x 29	245	17.5	\$2321
RT12W	144 x 48 x 29	270	19	\$2510

Please specify edge detail: self edge (**SE**), bullnose (**BN**), T-mold (**TM**) or built-up (**BU**).
Shipped easy to assemble in 2 cartons.



Racetrack Top - Two Tubular Legs*

RT6R	72 x 36 x 29	110	13.75	\$1357
RT8R	96 x 36 x 29	140	14.75	\$1503
RT8WR	96 x 48 x 29	150	16.25	\$1648

Please specify edge detail: self edge (**SE**), bullnose (**BN**), T-mold (**TM**) or built-up (**BU**).
Shipped easy to assemble in 2 cartons.



Racetrack Top - Three Tubular Legs*

RT10R	120 x 36 x 29	210	15.75	\$2151
RT10WR	120 x 48 x 29	245	17.5	\$2558
RT12WR	144 x 48 x 29	270	19	\$2748

Please specify edge detail: self edge (**SE**), bullnose (**BN**), T-mold (**TM**) or built-up (**BU**).
Shipped easy to assemble in 2 cartons.

ELLIPTICAL TOPS

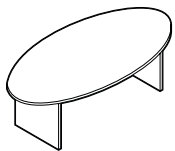

Elliptical Top - Two Slab Bases

EL6X	72 x 36 x 29	114	4.6	\$1811
EL8X	96 x 36 x 29	144	7.3	\$1945
EL8WX	96 x 48 x 29	154	7.3	\$2064

Please specify edge detail: self edge (**SE**), bullnose (**BN**), T-mold (**TM**) or built-up (**BU**).
Shipped easy to assemble in 3 cartons (except EL6X shipped easy to assemble in 2 cartons).

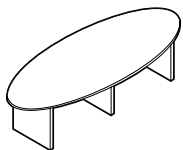

Elliptical Top - Three Slab Bases

EL10X	120 x 36 x 29	216	8.25	\$2968
EL10WX	120 x 48 x 29	251	8.75	\$3330
EL12WX	144 x 48 x 29	276	10.6	\$3499

Please specify edge detail: self edge (**SE**), bullnose (**BN**), T-mold (**TM**) or built-up (**BU**).
Shipped easy to assemble in 2 cartons.

Required specifications

Top finish
Leg finish*
Edge detail

Optional specifications

Grommet
Power block cut-out

Accessories

Power block

ELLIPTICAL TOPS

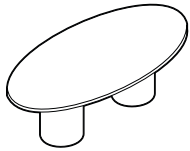

Elliptical Top - Two Drum Bases

MODEL #	DIMENSIONS W x D x H	WT/LB.	CUBIC FT.	LIST PRICE
EL6Z	72 x 36 x 29	164	15.32	\$2064
EL8Z	96 x 36 x 29	194	16.35	\$2193
EL8WZ	96 x 48 x 29	204	17.7	\$2324

Please specify edge detail: self edge (**SE**), bullnose (**BN**), T-mold (**TM**) or built-up (**BU**).
Shipped easy to assemble in 2 cartons.

- All drum bases require approximately 50 lbs. of sand in each base for adequate stability. Sand is not included.

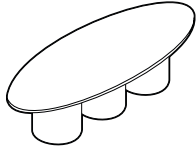

Elliptical Top - Three Drum Bases

EL10Z	120 x 36 x 29	291	23.65	\$3206
EL10WZ	120 x 48 x 29	326	25.3	\$3563
EL12WZ	144 x 48 x 29	351	26.67	\$3734

Please specify edge detail: self edge (**SE**), bullnose (**BN**), T-mold (**TM**) or built-up (**BU**).
Shipped easy to assemble in 2 cartons.

- All drum bases require approximately 50 lbs. of sand in each base for adequate stability. Sand is not included.

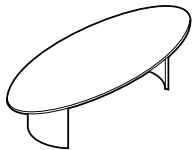

Elliptical Top - Two Arch Bases

EL6A	72 x 36 x 29	114	5.6	\$2064
EL8A	96 x 36 x 29	144	7.1	\$2193
EL8WA	96 x 48 x 29	154	10.15	\$2324
EL10A	120 x 36 x 29	174	9.85	\$3206
EL10WA	120 x 48 x 29	184	11.5	\$3563
EL12WA	144 x 48 x 29	194	13.25	\$3734

Please specify edge detail: self edge (**SE**), bullnose (**BN**), T-mold (**TM**) or built-up (**BU**).
Shipped easy to assemble in 3 cartons (except EL6A shipped easy to assemble in 2 cartons).

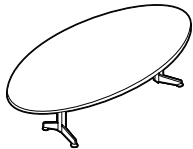

Elliptical Top - Two Legs*

EL6	72 x 36 x 29	110	13.75	\$1202
EL8	96 x 36 x 29	140	14.75	\$1357
EL8W	96 x 48 x 29	150	16.25	\$1490

Please specify edge detail: self edge (**SE**), bullnose (**BN**), T-mold (**TM**) or built-up (**BU**).
Shipped easy to assemble in 2 cartons.

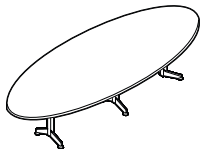

Elliptical Top - Three Legs*

EL10	120 x 36 x 29	210	15.75	\$1921
EL10W	120 x 48 x 29	245	17.5	\$2321
EL12W	144 x 48 x 29	270	19	\$2510

Please specify edge detail: self edge (**SE**), bullnose (**BN**), T-mold (**TM**) or built-up (**BU**).
Shipped easy to assemble in 2 cartons.



Elliptical Top - Two Tubular Legs*

EL6R	72 x 36 x 29	110	13.75	\$1357
EL8R	96 x 36 x 29	140	14.75	\$1503
EL8WR	96 x 48 x 29	150	16.25	\$1648

Please specify edge detail: self edge (**SE**), bullnose (**BN**), T-mold (**TM**) or built-up (**BU**).
Shipped easy to assemble in 2 cartons.

Required specifications

Top finish
Leg finish*
Edge detail

Optional specifications

Grommet
Power block cut-out

Accessories

Power block

B BOARDROOM & CAFETERIA TABLES

ELLIPTICAL TOPS

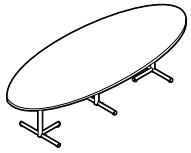

Elliptical Top - Three Tubular Legs*

MODEL #	DIMENSIONS	WT/LB.	CUBIC FT.	LIST PRICE
---------	------------	--------	-----------	------------

W x D x H

EL10R	120 x 36 x 29	210	15.75	\$2151
EL10WR	120 x 48 x 29	245	17.5	\$2558
EL12WR	144 x 48 x 29	270	19	\$2748

Please specify edge detail: self edge (**SE**), bullnose (**BN**), T-mold (**TM**) or built-up (**BU**).
Shipped easy to assemble in 2 cartons.

Required specifications

Top finish
Leg finish*
Edge detail*

Optional specifications

Grommet
Power block cut-out

Accessories

Power block

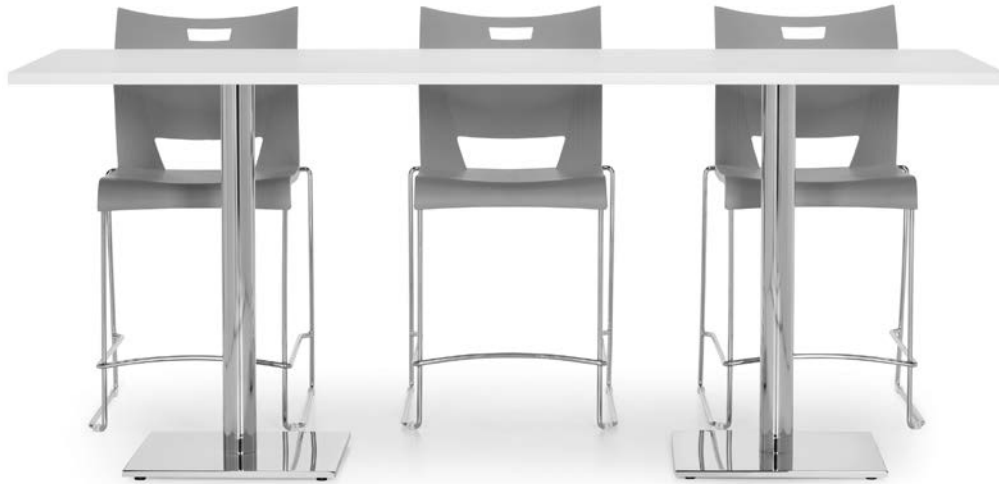

Global's Swap collection is a comprehensive offering including laptop tables, casual meeting tables, café tables, huddle tables and more. Suitable for a variety of applications: break rooms, dedicated/enclosed meeting rooms, casual/open area meeting spaces (lounge, seated, counter and bar height options), and private office (accommodate smaller 3-4 person discussions). Tops and bases are sold separately for ease of specification. Mix and match capabilities to create spaces for multi-purpose use. Choose your top, choose your base. Create the combination you desire for the way you want to work.

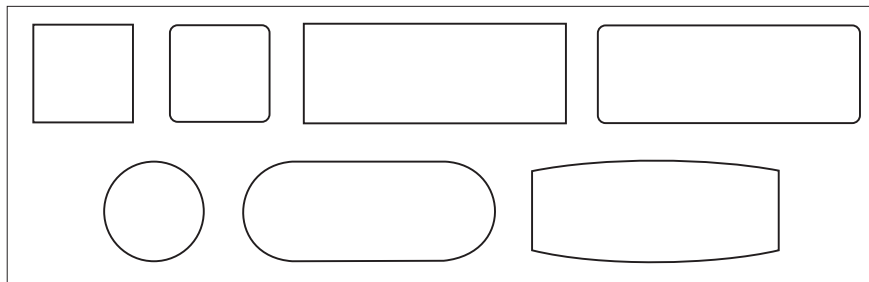

Top shapes

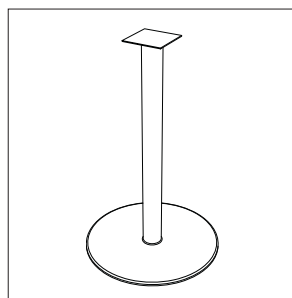

Round base

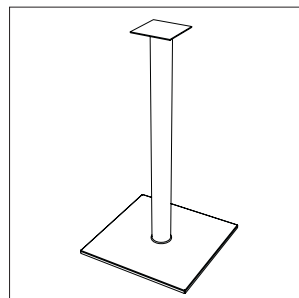

Square base

Features and Benefits

- Tops are available in four materials to help perfect your interior design: thermally fused laminate, high pressure laminate, veneer and solid surface.
- **High performance thermally fused laminate** tops are 1" thick with a 45 lb. density particle board core and feature 2mm thick edgeband.
- **High pressure laminate** tops are 1 1/16" thick with 2mm flat edge or 1 3/16" thick with knife edge profile. Tops with flat edge have a 45 lb. density particle board core; tops with knife edge have a MDF core.
- **Veneer** tops are 1 3/16" thick overall with matching flat edge or knife edge.
- **Solid surface** tops are 1 1/4" thick with a plywood or particle board melamine subtop depending on size, available with flat edge or knife edge.
- Bases are constructed of a solid steel metal plate and cover - round or square.
- Power block cut-outs are available on most tables.
- 6 heights:
Coffee table height at 16"H.
End table height at 22"H.
Lounge height at 27"H.
Seated height at 29"H.
Counter height at 36"H.
Bar height at 41.5"H.

GENERAL INFORMATION

- Swap is a series of tables for use in casual meeting spaces, lounges, café areas and more.
- The right proportions, flawless surfaces and a solid foundation is sure to become your favorite table series to spec.
- Finish palette coordinates with most Global laminate and veneer casegoods series as well as a variety of solid surface options to choose from - tables can stand-alone or blend with other solutions.
- Each component is packed individually. Bases are shipped assembled, 1 per carton. Easy to assemble.
- For environmental certifications, please visit globalfurnituregroup.com.

WORKSURFACES

- Four material choices: high performance thermally fused laminate, high pressure laminate, veneer and solid surface.
- **Thermally fused laminate** tops are 1" thick overall with a 45 lb. density particle board core and feature 2mm thick edgeband. Edgeband finish can be specified to match or contrast the surface finish.
- **High pressure laminate** tops are 1 1/16" thick with 2mm flat edge or 1 3/16" thick with knife edge. 1 1/16" thick tops have a 45 lb. density particle board core and the 2mm flat edge finish can be specified to match or complement the top surface. 1 3/16" thick tops have an MDF core and the knife edge finish will match top surface. Models ending in **(LK)** indicate high pressure laminate with knife edge.
- **Veneer** tops are 1 3/16" thick overall with choice of edge detail - flat edge or knife edge. Edge finish will correspond to surface finish. When flat edge, core material is 45 lb. density particle board; when knife edge, core material is MDF. Models ending in **(V)** indicate veneer.
- **Solid surface** tops are 1 1/4" thick overall with choice of edge detail - flat edge or knife edge. Solid surface material is 0.5" thick with built up edge profile over a particle board or plywood subtop depending on overall top size. Models ending in **(SF)** indicate solid surface with flat edge; models ending in **(SK)** indicate solid surface with knife edge.
- Please see model # for pricing and availability of various material and edge options.
- Refer to page 323 or globalfurnituregroup.com for available finish options.
- While not all sizes are available in all materials:
 - Worksurfaces of 96" or less in length are standard in one piece (1 carton).
 - Worksurfaces 120" to 144" in length are standard in two pieces (2 cartons).
 - Worksurfaces 96", 120" and 144" x 48" include support channels.

BASES

- **Caution:** to meet BIFMA standards for performance and stability, appropriate base size must be specified with corresponding top sizes identified. **Top plates and base plates vary by base size and will only work with table shape sizes as referenced on the following pages.**
- Bases are constructed of a round or square solid steel metal plate for counter balance, covered with a finished steel shroud, affixed with four bolts to a cold rolled steel tube.
- GRB14H25 attaches to tops with a 6" x 6" steel plate, welded to a 1.5" diameter steel tube, bolted to a 0.5" thick solid steel counter balance. Not to be used on tops greater than 22" x 22" in size.
- GSB13H25 and GSOB13H25 attach to tops with a 6" x 6" steel plate, welded to a 1.5" diameter steel tube, bolted to a 0.5" thick solid steel counter balance. Not to be used on tops greater than 22" x 22" in size.
- GRB22H15, GRB22H21, GRB22H26, GRB22, GRB22H35, GRB22H41, GSB19H15, GSB19H21, GSB19H26, GSB19, GSB19H35 and GSB19H41 attach to tops with a 6" x 6" steel plate, welded to a 3" diameter steel tube, bolted to a 0.5" thick solid steel counter balance.
- Top plate and base plate of GRB22 and GSB19 models in all heights, have pass-through cut-outs to accommodate a single port simplex or dual USB module to deliver power or USB charging to the surface. This allows the module to be mounted directly above the base and to pass the unit's cord through the base column resulting in the cord and plug head exiting from the bottom of the base for plugging into a floor or wall mount power source.
- GRB28, GRB34, GSB23 and GSB28 attach to tops with an 11" x 11" steel plate, welded to a 4" diameter steel tube, bolted to a 0.375" thick solid steel counter balance.
- Bases are available PAINTED in "Sandtex" finish for extra durability. Also available in plated finishes (see page 323) at an upcharge and with an extended lead time. Please see model # for pricing.
- All bases come with six height adjustable glides with 0.75" of adjustability.
- Round bases available in 22", 28" and 34" dia.
- Square bases available in 18.5", 22.5" and 28.5".

1. SPECIFY MODEL NUMBER

2. SPECIFY FINISH

Laminate finishes (thermally fused and high pressure laminate):

ACJ Absolute Acajou	FCL First Class
ASN Asian Night	NBL Noce Biondo
AWC Avant Cherry	NGL Noce Grigio
AWH Avant Honey	NEL Noce Leggero
BLK Black	NML Noce Medio
BZD Blizzard	QTM Quartered Mahogany
BRC Brushed Cobalt	SBY Sheer Beauty
CMB Clear Maple	SDT Stonedust
CGY Custom Grey	SOG Storm Grey
DES Dark Espresso	WHE Walnut Heights
DWT Designer White	WHC White Chocolate
FAS Fashionista	WCR Winter Cherry

Veneer finishes (applicable for models ending in **V** only):

AMW Almond Cherry	LTW Latte
ACW Amber Cherry	MHW Mahogany on Walnut
BTW Biscotti	MPW Natural Maple
CAW Cocoa Walnut	MTW Milestone
CRW Coral	NLW Natural Walnut
DCW Dark Cherry	RCW Red Cherry
DWW Dark Walnut	ULW Umber Walnut
EWV Espresso	VNW Vintage Cherry
EVW Evening Oak	WLW Walnut
GRW Grey on Oak	WMW White Maple
HAW Hazelnut	WCW Warm Cherry
JAW Java	

Solid surface (applicable for models ending in **SF** or **SK** only):

Grade 1	Grade 2
SWH Designer White	SBT Beige Tempest
	SBX Black Onyx Mirage
	SFW Frosty White Mirage
	SHS Hot Stone
	SMG Milk Glass Spectra
	SNM Northern Melange

Bases (paint finishes):

TBL Black	TIN Ink
TBZ Buzz Blue	TKA Kalua
TCC Cactus	TLA Latte
TCR Carrot	TMO Mocha
TIV Cloud	TNE Nevada
TDW Designer White	TSN Sand
TDJ Dijon	TSR Scarlet
TEG Eggplant	TSH Shadow
TFO Fog	TOA Toast
TFR Frost	TTU Tungsten

Bases (plated finishes - upcharge applies):

ACO Antique Copper	CHM Chrome
BCH Brushed Chrome	SBR Satin Brass

3. SPECIFY EDGE PROFILE (where applicable)

- Thermally fused laminate and high pressure with flat edge tops:
 - Flat edge (FE) - default profile
 - 3" radiused corners (R3) - optional for square and rectangular tops, upcharge applies
- High pressure laminate tops (models ending in **LK**):
 - Knife edge only
 - 3" radiused corners available by quote request only
- Veneer tops (models ending in **V**):
 - Flat edge (FE) - default profile
 - Knife edge (KS) - optional
 - 3" radiused corners available by quote request only
- Solid surface tops (models ending is **SF**):
 - Flat edge (FE) - default profile
 - 3" radiused corners (R3) - optional for square and rectangular tops, upcharge applies
- Solid surface tops (models ending is **SK**):
 - Knife edge (KS) - default profile
 - Knife edge with 3" radiused corners (KR) - optional for square and rectangular tops, upcharge applies

4. SPECIFY EDGE FINISH

Edge finish only applicable for thermally fused laminate and high pressure tops with flat edge (FE)

AAE Absolute Acajou	CGY Custom Grey	NML Noce Medio
ASE Asian Night	DEE Dark Espresso	QTM Quarter Mahogany
ACE Avant Cherry	DWE Designer White	SAR Scarlet
AHE Avant Honey	DJN Dijon	SHW Shadow
BLK Black	FAS Fashionista	SBY Sheer Beauty
BZD Blizzard	FCL First Class	SDT Stonedust
BRC Brushed Cobalt	FOG Fog	SOG Storm Grey
BZB Buzz Blue	LAB Latte	WHE Walnut Heights
CCT Cactus	NBL Noce Biondo	CBE White Chocolate
CRO Carrot	NGL Noce Grigio	WCE Winter Cherry
CME Clear Maple	NEL Noce Leggero	

5. SPECIFY OPTIONS

POWER BLOCKS AND CUT-OUTS LOCATIONS

- A power block delivers power/data to the table surface.
- Power block modules are ordered separately.
- Not all power block locations are available on all table sizes. Please refer to the top/base chart on the following pages for more information.
- To purchase a power block, you must specify the power block cut-out location when ordering the top and order the power block separately.
- Optional cut-out available in standard worksurface locations (left, center or right) for all table shapes.
Example: Order as **E1, R1, T1**, etc. **Add \$91** for each cut-out.
- Cut-outs may be placed at non-standard locations. Please contact Customer Service.
- Select power block option from Productivity Solutions pages 467-470.
- Custom locations or cut-outs available (drawing required). **Add \$132.**

POWER BLOCK OPTIONS AND CUT-OUT LOCATIONS

(Power modules and blocks can be found in the Productivity Solutions section of the price list)

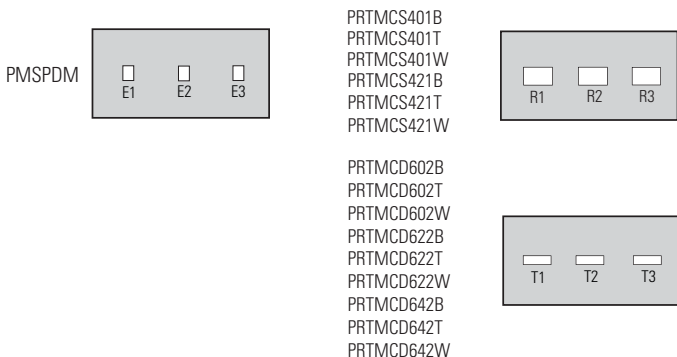

- Match power block desired with cut-out code and location from above grid.
- Example: If power block module # PRTMC401B is required in the center position, specify cut-out option R2 when specifying the top.

SINGLE PORT MODULES

- Single port module with one simplex or one dual USB charging port centered over the base, available for tops supported with single GRB22xx or GSB19xx base in any height
- Specify optional cut-out (**Q2**) to accommodate when specifying tops. **Add \$91** to list.
- Modules are listed on product pages with applicable tops and bases. Modules are ordered separately.

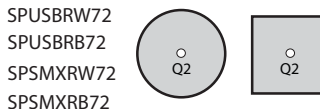

- For White colored modules, specify code ending in (**W72**); for Black colored modules, specify code ending in (**B72**).









SPECIFICATIONS



- Required and optional specifications marked with an * on the pricelist pages with products are applicable to only those products which have the * symbol beside the product name.







TABLE NOTES - ESTIMATED CAPACITY

- Use the following to determine the size of a table and the number of chairs needed for a conference area.
- All estimates are based on an average chair width of 23" with a 4" clearance between chairs. Adjust accordingly for a different chair size.

Top Size	Round	NUMBER OF CHAIRS				Racetrack
		Square	Rectangular	Boat		
24 x 24	2	2	N/A	N/A	N/A	
24 x 30	N/A	N/A	2-3	N/A	N/A	
24 x 36	N/A	N/A	3-4	N/A	N/A	
30 x 30	3	4	N/A	N/A	N/A	
30 x 36	N/A	N/A	4	N/A	N/A	
30 x 42	N/A	N/A	4	N/A	N/A	
36 x 36	4	4	N/A	N/A	N/A	
36 x 42	N/A	N/A	4	N/A	N/A	
42 x 42	4	4	N/A	N/A	N/A	
48 x 48	4	4	N/A	N/A	N/A	
54 x 54	5	6	N/A	N/A	N/A	
60 x 60	5	6	N/A	N/A	N/A	
24 x 60	N/A	N/A	4-6	N/A	4-6	
24 x 66	N/A	N/A	4-6	N/A	4-6	
24 x 72	N/A	N/A	4-6	N/A	4-6	
24 x 84	N/A	N/A	4-6	N/A	4-6	
24 x 96	N/A	N/A	6-8	N/A	6-8	
30 x 60	N/A	N/A	4-6	4-6	4-6	
30 x 66	N/A	N/A	4-6	4-6	4-6	
30 x 72	N/A	N/A	4-6	4-6	4-6	
30 x 84	N/A	N/A	4-6	4-6	4-6	
30 x 96	N/A	N/A	6-8	6-8	6-8	
36 x 60	N/A	N/A	4-6	4-6	4-6	
36 x 66	N/A	N/A	4-6	4-6	4-6	
36 x 72	N/A	N/A	4-6	4-6	4-6	
36 x 84	N/A	N/A	4-6	4-6	4-6	
36 x 96	N/A	N/A	6-8	6-8	6-8	
48 x 84	N/A	N/A	6-8	6-8	6-8	
48 x 96	N/A	N/A	6-8	6-8	6-8	
48 x 120	N/A	N/A	8-10	8-10	8-10	
48 x 144	N/A	N/A	10-12	10-12	10-12	

APPLICABLE BASE OPTIONS FOR CORRESPONDING TOP										POWER MGMT OPTIONS		
Table Shape/Size	Top #	Lounge Height 27"H		Seated Height 28.5"H		Counter Height 36"H		Bar Height 41.5"H		Base Qty.	# top pieces	Grommet and Power Block Cut-outs Available
		Round base 22" 	Square base 18.5" 	Round base 22", 28", 34" 	Square base 18.5", 22.5", 28.5" 	Round base 22" 	Square base 18.5" 	Round base 22" 	Square base 18.5" 			
Round ○ Nominal base plate dimension indicated by 4th and 5th characters in base model numbers												
24" diameter top	GRBTP24_	GRB22H26	GSB19H26	GRB22	GSB19	GRB22H35	GSB19H35	GRB22H41	GSB19H41	1	1	Q2 only
30" diameter top	GRBTP30_	GRB22H26	GSB19H26	GRB22	GSB19	GRB22H35	GSB19H35	GRB22H41	GSB19H41	1	1	Q2 only
36" diameter top	GRBTP36_	GRB22H26	GSB19H26	GRB22	GSB19	GRB22H35	GSB19H35	GRB22H41	GSB19H41	1	1	Q2 only
42" diameter top	GRBTP42_	N/A	N/A	GRB28	GSB23	N/A	N/A	N/A	N/A	1	1	None
48" diameter top	GRBTP48_	N/A	N/A	GRB28	GSB23	N/A	N/A	N/A	N/A	1	1	None
54" diameter top	GRBTP54_	N/A	N/A	GRB34	GSB28	N/A	N/A	N/A	N/A	1	1	None
60" diameter top	GRBTP60_	N/A	N/A	GRB34	GSB28	N/A	N/A	N/A	N/A	1	1	None
Square □												
24" square top	GSBTP24_	GRB22H26	GSB19H26	GRB22	GSB19	GRB22H35	GSB19H35	GRB22H41	GSB19H41	1	1	Q2 only
30" square top	GSBTP30_	GRB22H26	GSB19H26	GRB22	GSB19	GRB22H35	GSB19H35	GRB22H41	GSB19H41	1	1	Q2 only
36" square top	GSBTP36_	GRB22H26	GSB19H26	GRB22	GSB19	GRB22H35	GSB19H35	GRB22H41	GSB19H41	1	1	Q2 only
42" square top	GSBTP42_	N/A	N/A	GRB28	GSB23	N/A	N/A	N/A	N/A	1	1	None
Rectangular ▭												
30x24 Rectangular	GSBTP2430_	GRB22H26	GSB19H26	GRB22	GSB19	GRB22H35	GSB19H35	GRB22H41	GSB19H41	1	1	Q2 only
36x24 Rectangular	GSBTP2436_	GRB22H26	GSB19H26	GRB22	GSB19	GRB22H35	GSB19H35	GRB22H41	GSB19H41	1	1	Q2 only
36x30 Rectangular	GSBTP3036_	GRB22H26	GSB19H26	GRB22	GSB19	GRB22H35	GSB19H35	GRB22H41	GSB19H41	1	1	Q2 only
42x30 Rectangular	GSBTP3042_	N/A	N/A	GRB28	GSB23	N/A	N/A	N/A	N/A	1	1	None
42x36 Rectangular	GSBTP3642_	N/A	N/A	GRB28	GSB23	N/A	N/A	N/A	N/A	1	1	None
60x24 Rectangular	GRT5STP_	GRB22H26	GSB19H26	N/A	N/A	GRB22H35	GSB19H35	GRB22H41	GSB19H41	2	1	Center: E2, R2, T2, FOG2
66x24 Rectangular	GRT5HSTP_	GRB22H26	GSB19H26	N/A	N/A	GRB22H35	GSB19H35	GRB22H41	GSB19H41	2	1	
72x24 Rectangular	GRT6STP_	GRB22H26	GSB19H26	N/A	N/A	GRB22H35	GSB19H35	GRB22H41	GSB19H41	2	1	
84x24 Rectangular	GRT7STP_	GRB22H26	GSB19H26	N/A	N/A	GRB22H35	GSB19H35	GRB22H41	GSB19H41	2	1	3 positions - Left/ Center/Right
96x24 Rectangular	GRT8STP_	GRB22H26	GSB19H26	N/A	N/A	GRB22H35	GSB19H35	GRB22H41	GSB19H41	2	1	
60x30 Rectangular	GRT5NTP_	GRB22H26	GSB19H26	GRB22	GSB19	GRB22H35	GSB19H35	GRB22H41	GSB19H41	2	1	Center: E2, R2, T2, FOG2
60x36 Rectangular	GRT5TP_	GRB22H26	GSB19H26	GRB22	GSB19	GRB22H35	GSB19H35	GRB22H41	GSB19H41	2	1	
66x30 Rectangular	GRT5NHTP_	GRB22H26	GSB19H26	GRB22	GSB19	GRB22H35	GSB19H35	GRB22H41	GSB19H41	2	1	
66x36 Rectangular	GRT5HTP_	GRB22H26	GSB19H26	GRB22	GSB19	GRB22H35	GSB19H35	GRB22H41	GSB19H41	2	1	
72x30 Rectangular	GRT6NTP_	GRB22H26	GSB19H26	GRB22	GSB19	GRB22H35	GSB19H35	GRB22H41	GSB19H41	2	1	
72x36 Rectangular	GRT6TP_	GRB22H26	GSB19H26	GRB22	GSB19	GRB22H35	GSB19H35	GRB22H41	GSB19H41	2	1	
84x30 Rectangular	GRT7NTP_	GRB22H26	GSB19H26	GRB22	GSB19	GRB22H35	GSB19H35	GRB22H41	GSB19H41	2	1	3 positions - Left/ Center/Right: E1/2/3, R1/2/3, T1/2/3, FOG1/2/3
84x36 Rectangular	GRT7TP_	GRB22H26	GSB19H26	GRB22	GSB19	GRB22H35	GSB19H35	GRB22H41	GSB19H41	2	1	
96x30 Rectangular	GRT8NTP_	GRB22H26	GSB19H26	GRB22	GSB19	GRB22H35	GSB19H35	GRB22H41	GSB19H41	2	1	
96x36 Rectangular	GRT8TP_	GRB22H26	GSB19H26	GRB22	GSB19	GRB22H35	GSB19H35	GRB22H41	GSB19H41	2	1	
96x42 Rectangular	GRT8MTP_	N/A	N/A	GRB28	GSB23	N/A	N/A	N/A	N/A	2	1	
96x48 Rectangular	GRT8WTP_	N/A	N/A	GRB28	GSB23	N/A	N/A	N/A	N/A	2	1	
120x48 Rectangular	GRT10WTP_	N/A	N/A	GRB28	GSB23	N/A	N/A	N/A	N/A	3	2	Both ends: E1, E3, R1, R3, T1, T3, FOG1, FOG3
144x48 Rectangular	GRT12WTP_	N/A	N/A	GRB28	GSB23	N/A	N/A	N/A	N/A	3	2	

APPLICABLE BASE OPTIONS FOR CORRESPONDING TOP										POWER MGMT OPTIONS		
Table Shape/Size	Top #	Lounge Height 27"H		Seated Height 28.5"H		Counter Height 36"H		Bar Height 41.5"H		Base Qty.	# top pieces	Grommet and Power Block Cut-outs Available
		Round base 22"	Square base 18.5"	Round base 22", 28", 34"	Square base 18.5", 22.5", 28.5"	Round base 22"	Square base 18.5"	Round base 22"	Square base 18.5"			
Racetrack  Nominal base plate dimension indicated by 4th and 5th characters in base model numbers												
60X24 Racetrack	GRC5STP_	GRB22H26	GSB19H26	N/A	N/A	GRB22H35	GSB19H35	GRB22H41	GSB19H41	2	1	Center: E2, R2, T2, FOG2
66X24 Racetrack	GRC5HSTP_	GRB22H26	GSB19H26	N/A	N/A	GRB22H35	GSB19H35	GRB22H41	GSB19H41	2	1	
72X24 Racetrack	GRC6STP_	GRB22H26	GSB19H26	N/A	N/A	GRB22H35	GSB19H35	GRB22H41	GSB19H41	2	1	3 positions - Left/ Center/Right
84X24 Racetrack	GRC7STP_	GRB22H26	GSB19H26	N/A	N/A	GRB22H35	GSB19H35	GRB22H41	GSB19H41	2	1	
96X24 Racetrack	GRC8STP_	GRB22H26	GSB19H26	N/A	N/A	GRB22H35	GSB19H35	GRB22H41	GSB19H41	2	1	Center: E2, R2, T2, FOG2
60x30 Racetrack	GRC5NTP_	GRB22H26	GSB19H26	GRB22	GSB19	GRB22H35	GSB19H35	GRB22H41	GSB19H41	2	1	
60X36 Racetrack	GRC5TP_	GRB22H26	GSB19H26	GRB22	GSB19	GRB22H35	GSB19H35	GRB22H41	GSB19H41	2	1	
66x30 Racetrack	GRC5NHTP_	GRB22H26	GSB19H26	GRB22	GSB19	GRB22H35	GSB19H35	GRB22H41	GSB19H41	2	1	
66X36 Racetrack	GRC5HTP_	GRB22H26	GSB19H26	GRB22	GSB19	GRB22H35	GSB19H35	GRB22H41	GSB19H41	2	1	
72x30 Racetrack	GRC6NTP_	GRB22H26	GSB19H26	GRB22	GSB19	GRB22H35	GSB19H35	GRB22H41	GSB19H41	2	1	
72x36 Racetrack	GRC6TP_	GRB22H26	GSB19H26	GRB22	GSB19	GRB22H35	GSB19H35	GRB22H41	GSB19H41	2	1	3 positions - Left/ Center/Right: E1/2/3; R1/2/3, T1/2/3, FOG1/2/3
84x30 Racetrack	GRC7NTP_	GRB22H26	GSB19H26	GRB22	GSB19	GRB22H35	GSB19H35	GRB22H41	GSB19H41	2	1	
84x36 Racetrack	GRC7TP_	GRB22H26	GSB19H26	GRB22	GSB19	GRB22H35	GSB19H35	GRB22H41	GSB19H41	2	1	
96x30 Racetrack	GRC8NTP_	GRB22H26	GSB19H26	GRB22	GSB19	GRB22H35	GSB19H35	GRB22H41	GSB19H41	2	1	
96x36 Racetrack	GRC8TP_	GRB22H26	GSB19H26	GRB22	GSB19	GRB22H35	GSB19H35	GRB22H41	GSB19H41	2	1	
96x42 Racetrack	GRC8MTP_	N/A	N/A	GRB28	GSB23	N/A	N/A	N/A	N/A	2	1	
96x48 Racetrack	GRC8WTP_	N/A	N/A	GRB28	GSB23	N/A	N/A	N/A	N/A	2	1	Both ends: E1, E3; R1, R3, T1, T3, FOG1, FOG3
120x48 Racetrack	GRC10WTP_	N/A	N/A	GRB28	GSB23	N/A	N/A	N/A	N/A	3	2	
144x48 Racetrack	GRC12WTP_	N/A	N/A	GRB28	GSB23	N/A	N/A	N/A	N/A	3	2	
Boat Shape 												
60x30 Boat shape	GBT5NTP_	GRB22H26	GSB19H26	GRB22	GSB19	GRB22H35	GSB19H35	GRB22H41	GSB19H41	2	1	Center: E2, R2, T2, FOG2
60X36 Boat shape	GBT5TP_	GRB22H26	GSB19H26	GRB22	GSB19	GRB22H35	GSB19H35	GRB22H41	GSB19H41	2	1	
66x30 Boat shape	GBT5NHTP_	GRB22H26	GSB19H26	GRB22	GSB19	GRB22H35	GSB19H35	GRB22H41	GSB19H41	2	1	
66X36 Boat shape	GBT5HTP_	GRB22H26	GSB19H26	GRB22	GSB19	GRB22H35	GSB19H35	GRB22H41	GSB19H41	2	1	
72x30 Boat shape	GBT6NTP_	GRB22H26	GSB19H26	GRB22	GSB19	GRB22H35	GSB19H35	GRB22H41	GSB19H41	2	1	
72x36 Boat shape	GBT6TP_	GRB22H26	GSB19H26	GRB22	GSB19	GRB22H35	GSB19H35	GRB22H41	GSB19H41	2	1	
84x30 Boat shape	GBT7NTP_	GRB22H26	GSB19H26	GRB22	GSB19	GRB22H35	GSB19H35	GRB22H41	GSB19H41	2	1	3 positions - Left/ Center/Right: E1/2/3; R1/2/3, T1/2/3, FOG1/2/3
84x36 Boat shape	GBT7TP_	GRB22H26	GSB19H26	GRB22	GSB19	GRB22H35	GSB19H35	GRB22H41	GSB19H41	2	1	
96x30 Boat shape	GBT8NTP_	GRB22H26	GSB19H26	GRB22	GSB19	GRB22H35	GSB19H35	GRB22H41	GSB19H41	2	1	
96x36 Boat shape	GBT8TP_	GRB22H26	GSB19H26	GRB22	GSB19	GRB22H35	GSB19H35	GRB22H41	GSB19H41	2	1	
96X42 Boat shape	GBT8MTP_	N/A	N/A	GRB28	GSB23	N/A	N/A	N/A	N/A	2	1	
96x48 Boat shape	GBT8WTP_	N/A	N/A	GRB28	GSB23	N/A	N/A	N/A	N/A	2	1	
120x48 Boat shape	GBT10WTP_	N/A	N/A	GRB28	GSB23	N/A	N/A	N/A	N/A	3	2	Both ends: E1, E3; R1, R2, T1, T2, FOG1, FOG 3
144x48 Boat shape	GBT12WTP_	N/A	N/A	GRB28	GSB23	N/A	N/A	N/A	N/A	3	2	

APPLICABLE BASE OPTIONS FOR CORRESPONDING TOP						POWER MGMT OPTIONS		
Table Shape/Size	Top #	Laptop Height 25.6" H				Base Qty.	# Top pieces	Power Block Cut-outs available
		Round base 14" Centered column	Square base 12.5" Centered column	Round base	Square base 12.5" Offset column			
				N/A				
Round Laptop ○ <i>*Nominal base plate dimension indicated by 4th and 5th characters in base model numbers.</i>								
16.5" dia	GRBTP16_	GRB14H25	GSB13H25	N/A	N/A	1	1	None
20" dia	GRBTP20_	GRB14H25	GSB13H25	N/A	N/A	1	1	None
22" dia	GRBTP22_	GRB14H25	GSB13H25	N/A	N/A	1	1	None
16.5" dia	GRBOTP16_	N/A	N/A	N/A	GSOB13H25	1	1	None
20" dia	GRBOTP20_	N/A	N/A	N/A	GSOB13H25	1	1	None
22" dia	GRBOTP22_	N/A	N/A	N/A	GSOB13H25	1	1	None
Square Laptop □								
16.5"x16.5"	GSBTP16_	GRB14H25	GSB13H25	N/A	N/A	1	1	None
20"x20"	GSBTP20_	GRB14H25	GSB13H25	N/A	N/A	1	1	None
22"x22"	GSBTP22_	GRB14H25	GSB13H25	N/A	N/A	1	1	None
16.5"x16.5"	GSBOTP16_	N/A	N/A	N/A	GSOB13H25	1	1	None
20"x20"	GSBOTP20_	N/A	N/A	N/A	GSOB13H25	1	1	None
22"x22"	GSBOTP22_	N/A	N/A	N/A	GSOB13H25	1	1	None
Rectangular Laptop □								
16"x20"	GSBTP1620_	GRB14H25	GSB13H25	N/A	N/A	1	1	None
16"x22"	GSBTP1622_	GRB14H25	GSB13H25	N/A	N/A	1	1	None
16"x20"	GSBOT1620_	N/A	N/A	N/A	GSOB13H25	1	1	None
16"x22"	GSBOT1622_	N/A	N/A	N/A	GSOB13H25	1	1	None
APPLICABLE BASE OPTIONS FOR CORRESPONDING TOP						POWER MGMT OPTIONS		
Table Shape	Top #	Coffee Table 16" H		End Table 22" H		Base Qty.	# top pieces	Power Block Cut-outs available
		Round base 22"	Square base 18.5"	Round base 22"	Square base 18.5"			
								
Round Coffee/End Tables ○ <i>*Nominal base plate dimension indicated by 4th and 5th characters in base model numbers.</i>								
24" dia	GRBTP24_	GRB22H15	GSB19H15	GRB22H21	GSB19H21	1	1	Q2 only
30" dia	GRBTP30_	GRB22H15	GSB19H15	GRB22H21	GSB19H21	1	1	Q2 only
36" dia	GRBTP36_	GRB22H15	GSB19H15	GRB22H21	GSB19H21	1	1	Q2 only
Square Coffee/End Tables □								
24" square	GSBTP24_	GRB22H15	GSB19H15	GRB22H21	GSB19H21	1	1	Q2 only
30" square	GSBTP30_	GRB22H15	GSB19H15	GRB22H21	GSB19H21	1	1	Q2 only
36" square	GSBTP36_	GRB22H15	GSB19H15	GRB22H21	GSB19H21	1	1	Q2 only

ROUND LAPTOP TABLES FOR CENTER BASE

MODEL # DIMENSIONS WT/LB. CUBIC FT. LIST PRICE HP ADD GRADE 2 R3 ADD KS ADD

W x D x H

Thermally fused laminate, flat edge ⁽¹⁾

GRBTP16	16.5 x - x 1	6	0.3	\$188	\$80	N/A	N/A	N/A
GRBTP20	20 x - x 1	9	0.5	\$206	\$89	N/A	N/A	N/A
GRBTP22	22 x - x 1	9	0.5	\$206	\$89	N/A	N/A	N/A

High pressure laminate, knife edge

GRBTP16LK	16.5 x - x 1.19	7.5	1	\$537	N/A	N/A	N/A	N/A
GRBTP20LK	20 x - x 1.19	11	1.5	\$608	N/A	N/A	N/A	N/A
GRBTP22LK	22 x - x 1.19	11	2	\$660	N/A	N/A	N/A	N/A

Veneer ⁽²⁾

GRBTP16V	16.5 x - x 1.19	7.5	1	\$809	N/A	N/A	N/A	\$77
GRBTP20V	20 x - x 1.19	11	1.5	\$875	N/A	N/A	N/A	\$77
GRBTP22V	22 x - x 1.19	11	2	\$942	N/A	N/A	N/A	\$77

Solid surface, flat edge ⁽³⁾

GRBTP16SF	16.5 x - x 1.25	11	0.6	\$1689	N/A	\$88	N/A	N/A
GRBTP20SF	20 x - x 1.25	16	1	\$1982	N/A	\$118	N/A	N/A
GRBTP22SF	22 x - x 1.25	20	1	\$2077	N/A	\$171	N/A	N/A

Solid surface, knife edge ⁽³⁾

GRBTP16SK	16.5 x - x 1.25	11	0.6	\$1789	N/A	\$100	N/A	N/A
GRBTP20SK	20 x - x 1.25	16	1	\$2088	N/A	\$123	N/A	N/A
GRBTP22SK	22 x - x 1.25	20	1	\$2188	N/A	\$176	N/A	N/A



Round Tops, for Centered Base

Only applicable bases to use with above tops: GRB14H25 round base or GSB13H25 square base with centered column.

Tops feature metal inserts for ease of assembly to base. One base required.

SQUARE LAPTOP TABLES FOR CENTER BASE

Thermally fused laminate, flat edge ⁽¹⁾⁽⁴⁾

GSBTP16	16.5 x 16.5 x 1	7	0.3	\$188	\$80	N/A	\$18.80	N/A
GSBTP20	20 x 20 x 1	11	0.5	\$206	\$89	N/A	\$20.60	N/A
GSBTP22	22 x 22 x 1	13	0.5	\$206	\$89	N/A	\$20.60	N/A

High pressure laminate, knife edge

GSBTP16LK	16.5 x 16.5 x 1.19	8.5	1	\$359	N/A	N/A	N/A	N/A
GSBTP20LK	20 x 20 x 1.19	13	1.5	\$450	N/A	N/A	N/A	N/A
GSBTP22LK	22 x 22 x 1.19	16	2	\$491	N/A	N/A	N/A	N/A

Veneer ⁽²⁾

GSBTP16V	16.5 x 16.5 x 1.19	8.5	1	\$461	N/A	N/A	N/A	\$72
GSBTP20V	20 x 20 x 1.19	13	1.5	\$578	N/A	N/A	N/A	\$87
GSBTP22V	22 x 22 x 1.19	16	2	\$635	N/A	N/A	N/A	\$97

Solid surface, flat edge ⁽³⁾⁽⁴⁾

GSBTP16SF	16.5 x 16.5 x 1.25	14	0.6	\$1447	N/A	\$83	\$206	N/A
GSBTP20SF	20 x 20 x 1.25	21	1	\$1736	N/A	\$123	\$206	N/A
GSBTP22SF	22 x 22 x 1.25	26	1	\$1829	N/A	\$147	\$206	N/A

Solid surface, knife edge ⁽³⁾⁽⁴⁾

GSBTP16SK	16.5 x 16.5 x 1.25	14	0.6	\$1789	N/A	\$100	\$206	N/A
GSBTP20SK	20 x 20 x 1.25	21	1	\$2088	N/A	\$130	\$206	N/A
GSBTP22SK	22 x 22 x 1.25	26	1	\$2188	N/A	\$176	\$206	N/A

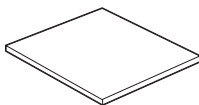

Square Tops, for Centered Base

Only applicable bases to use with above tops: GRB14H25 round base or GSB13H25 square base with centered column.

Tops feature metal inserts for ease of assembly to base. One base required.

Required specifications

Top finish
Edge finish ⁽¹⁾

Optional specifications

HP laminate ⁽¹⁾
Knife edge ⁽²⁾
Grade 2 solid surface ⁽³⁾
3" radiused corners ⁽⁴⁾

Applicable bases

GRB14H25 - round
GSB13H25 - square

S SWAP™ TABLES

RECTANGULAR LAPTOP TABLES FOR CENTER BASE

MODEL # DIMENSIONS WT/LB. CUBIC FT. LIST PRICE HP ADD GRADE 2 R3 ADD KS ADD

W x D x H

Thermally fused laminate, flat edge ⁽¹⁾⁽⁴⁾

GSBTP1620	16 x 20 x 1	9	0.4	\$206	\$89	N/A	\$20.60	N/A
GSBTP1622	16 x 22 x 1	11	0.5	\$206	\$89	N/A	\$20.60	N/A

High pressure laminate, knife edge

GSBTP1620LK	20 x 16 x 1.19	11	1	\$461	N/A	N/A	N/A	N/A
GSBTP1622LK	22 x 16 x 1.19	13	1.5	\$506	N/A	N/A	N/A	N/A

Veneer ⁽²⁾

GSBTP1620V	20 x 16 x 1.19	11	1	\$568	N/A	N/A	N/A	\$87
GSBTP1622V	22 x 16 x 1.19	13	1.5	\$624	N/A	N/A	N/A	\$92

Solid surface, flat edge ⁽³⁾⁽⁴⁾

GSBTP1620SF	16 x 20 x 1.25	17	0.8	\$1606	N/A	\$100	\$206	N/A
GSBTP1622SF	16 x 22 x 1.25	19	0.8	\$1629	N/A	\$106	\$206	N/A

Solid surface, knife edge ⁽³⁾⁽⁴⁾

GSBTP1620SK	16 x 20 x 1.25	17	0.8	\$1929	N/A	\$123	\$206	N/A
GSBTP1622SK	16 x 22 x 1.25	19	0.8	\$1965	N/A	\$141	\$206	N/A

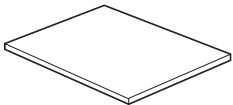

Rectangular Tops, for Centered Base

Only applicable bases to use with above tops: GRB14H25 round base or GSB13H25 square base with centered column. Tops feature metal inserts for ease of assembly to base. One base required.

ROUND LAPTOP TABLES FOR OFFSET BASE

Thermally fused laminate, flat edge ⁽¹⁾

GRBOTP16	16.5 x - x 1	6	0.3	\$188	\$80	N/A	N/A	N/A
GRBOTP20	20 x - x 1	9	0.5	\$206	\$89	N/A	N/A	N/A
GRBOTP22	22 x - x 1	11	0.7	\$206	\$89	N/A	N/A	N/A

High pressure laminate, knife edge

GRBOTP16LK	16.5 x - x 1.19	8	1	\$537	N/A	N/A	N/A	N/A
GRBOTP20LK	20 x - x 1.19	13	1.5	\$608	N/A	N/A	N/A	N/A
GRBOTP22LK	22 x - x 1.19	16	2	\$660	N/A	N/A	N/A	N/A

Veneer ⁽²⁾

GRBOTP16V	16.5 x - x 1.19	8	1	\$809	N/A	N/A	N/A	\$77
GRBOTP20V	20 x - x 1.19	13	1.5	\$875	N/A	N/A	N/A	\$77
GRBOTP22V	22 x - x 1.19	16	2	\$942	N/A	N/A	N/A	\$77

Solid surface, flat edge ⁽³⁾

GRBOTP16SF	16.5 x - x 1.25	11	0.6	\$1689	N/A	\$88	N/A	N/A
GRBOTP20SF	20 x - x 1.25	16	1	\$1982	N/A	\$118	N/A	N/A
GRBOTP22SF	22 x - x 1.25	20	1	\$2077	N/A	\$171	N/A	N/A

Solid surface, knife edge ⁽³⁾

GRBOTP16SK	16.5 x - x 1.25	11	0.6	\$1789	N/A	\$100	N/A	N/A
GRBOTP20SK	20 x - x 1.25	16	1	\$2088	N/A	\$123	N/A	N/A
GRBOTP22SK	22 x - x 1.25	20	1	\$2188	N/A	\$176	N/A	N/A



Round Tops, for Offset Base

Only applicable bases to use with above tops: GSOB13H25 square base with OFFSET column. Tops feature metal inserts for ease of assembly to base. One base required.

Required specifications

Top finish
Edge finish ⁽¹⁾

Optional specifications

HP laminate ⁽¹⁾
Knife edge ⁽²⁾
Grade 2 solid surface ⁽³⁾
3" radiused corners ⁽⁴⁾

Applicable bases

GRB14H25 - round centered
GSB13H25 - square centered
GSOB13H25 - square offset

SQUARE LAPTOP TABLES FOR OFFSET BASE

MODEL #	DIMENSIONS	WT/LB.	CUBIC FT.	LIST PRICE	HP ADD	GRADE 2	R3 ADD	KS ADD
---------	------------	--------	-----------	------------	--------	---------	--------	--------

W x D x H

Thermally fused laminate, flat edge ⁽¹⁾⁽⁴⁾

GSBOTP16	16.5 x 16.5 x 1	7	0.3	\$188	\$80	N/A	\$18.80	N/A
GSBOTP20	20 x 20 x 1	11	0.5	\$206	\$89	N/A	\$20.60	N/A
GSBOTP22	22 x 22 x 1	13	0.7	\$206	\$89	N/A	\$20.60	N/A

High pressure laminate, knife edge

GSBOTP16LK	16.5 x 16.5 x 1.19	8.5	1	\$359	N/A	N/A	N/A	N/A
GSBOTP20LK	20 x 20 x 1.19	13	1.5	\$450	N/A	N/A	N/A	N/A
GSBOTP22LK	22 x 22 x 1.19	16	2	\$491	N/A	N/A	N/A	N/A

Veneer ⁽²⁾

GSBOTP16V	16.5 x 16.5 x 1.19	8.5	1	\$461	N/A	N/A	N/A	\$72
GSBOTP20V	20 x 20 x 1.19	13	1.5	\$578	N/A	N/A	N/A	\$87
GSBOTP22V	22 x 22 x 1.19	16	2	\$635	N/A	N/A	N/A	\$97

Solid surface, flat edge ⁽³⁾⁽⁴⁾

GSBOTP16SF	16.5 x 16.5 x 1.25	14	0.6	\$1447	N/A	\$83	\$206	N/A
GSBOTP20SF	20 x 20 x 1.25	21	1	\$1736	N/A	\$123	\$206	N/A
GSBOTP22SF	22 x 22 x 1.25	26	1	\$1829	N/A	\$147	\$206	N/A

Solid surface, knife edge ⁽³⁾⁽⁴⁾

GSBOTP16SK	16.5 x 16.5 x 1.25	14	0.6	\$1789	N/A	\$100	\$206	N/A
GSBOTP20SK	20 x 20 x 1.25	21	1	\$2088	N/A	\$130	\$206	N/A
GSBOTP22SK	22 x 22 x 1.25	26	1	\$2188	N/A	\$176	\$206	N/A

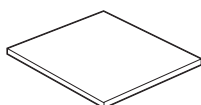

Square Tops, for Offset Base

Only applicable bases to use with above tops: GSOB13H25 square base with OFFSET column.

Tops feature metal inserts for ease of assembly to base. One base required.

RECTANGULAR LAPTOP TABLES FOR OFFSET BASE

Thermally fused laminate, flat edge ⁽¹⁾⁽⁴⁾

GSBOT1620	16 x 20 x 1	9	0.4	\$210	\$91	N/A	\$21	N/A
GSBOT1622	16 x 22 x 1	11	0.5	\$210	\$91	N/A	\$21	N/A

High pressure laminate, knife edge

GSBOT1620LK	20 x 16 x 1.19	11	1.5	\$461	N/A	N/A	N/A	N/A
GSBOT1622LK	22 x 16 x 1.19	13	2	\$506	N/A	N/A	N/A	N/A

Veneer ⁽²⁾

GSBOT1620V	20 x 16 x 1.19	11	1.5	\$568	N/A	N/A	N/A	\$87
GSBOT1622V	22 x 16 x 1.19	13	2	\$624	N/A	N/A	N/A	\$92

Solid surface, flat edge ⁽³⁾⁽⁴⁾

GSBOT1620SF	16 x 20 x 1.25	17	0.8	\$1606	N/A	\$100	\$206	N/A
GSBOT1622SF	16 x 22 x 1.25	19	0.8	\$1629	N/A	\$106	\$206	N/A

Solid surface, knife edge ⁽³⁾⁽⁴⁾

GSBOT1620SK	16 x 20 x 1.25	17	0.8	\$1929	N/A	\$123	\$206	N/A
GSBOT1622SK	16 x 22 x 1.25	19	0.8	\$1965	N/A	\$141	\$206	N/A

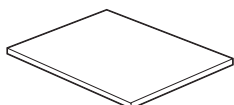

Rectangular Tops, for Offset Base

Only applicable bases to use with above tops: GSOB13H25 square base with OFFSET column.

Tops feature metal inserts for ease of assembly to base. One base required.

Required specifications

Top finish
Edge finish ⁽¹⁾

Optional specifications

HP laminate ⁽¹⁾
Knife edge ⁽²⁾
Grade 2 solid surface ⁽³⁾
3" radiused corners ⁽⁴⁾

Applicable base

GSOB13H25 - square

S SWAP™ TABLES

LAPTOP TABLE BASES	MODEL #	DIMENSIONS	WT/LB.	CUBIC FT.	LIST PRICE	BCH / CHM	ACO / SBR
--------------------	---------	------------	--------	-----------	------------	-----------	-----------

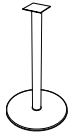

14" Round Centered Base

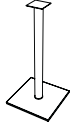

12.5" Square Centered Base



12.5" Square Offset Base

	W x D x H						
GRB14H25	14 x - x 24.6	27	3.26	\$633	\$87	\$172	
GSB13H25	12.5 x 12.5 x 24.6	26	3.26	\$653	\$87	\$186	
GSOB13H25	12.5 x 12.5 x 24.6	26	3.26	\$653	\$87	\$186	

1.5" diameter column. Weighted base for balance includes top plate, 0.5" adjustable glides to level on uneven surfaces. Screws included with base for attaching to appropriate top(s). Available in paint and plated finishes as listed on page 323. Upcharge applies on plated finishes.

Required specifications
Finish

Optional specifications
Plated finish

ROUND TOPS, 24" - 36"W **MODEL #** **DIMENSIONS** **WT/LB.** **CUBIC FT.** **LIST PRICE** **HP ADD** **GRADE 2** **R3 ADD** **KS ADD**

W x D x H

Thermally fused laminate, flat edge ⁽¹⁾

GRBTP24	24 x - x 1	16	1	\$206	\$91	N/A	N/A	N/A
GRBTP30	30 x - x 1	25	1.5	\$239	\$108	N/A	N/A	N/A
GRBTP36	36 x - x 1	36	2	\$303	\$136	N/A	N/A	N/A

High pressure laminate, knife edge

GRBTP24LK	24 x - x 1.19	19	2	\$845	N/A	N/A	N/A	N/A
GRBTP30LK	30 x - x 1.19	30	3	\$1038	N/A	N/A	N/A	N/A
GRBTP36LK	36 x - x 1.19	43	4	\$1228	N/A	N/A	N/A	N/A

Veneer ⁽²⁾

GRBTP24V	24 x - x 1.19	19	2	\$1008	N/A	N/A	N/A	\$77
GRBTP30V	30 x - x 1.19	30	3	\$1202	N/A	N/A	N/A	\$77
GRBTP36V	36 x - x 1.19	43	4	\$1407	N/A	N/A	N/A	\$77

Solid surface, flat edge ⁽³⁾

GRBTP24SF	24 x - x 1.25	24	1.2	\$2130	N/A	\$171	N/A	N/A
GRBTP30SF	29.8 x - x 1.25	37	1.8	\$2323	N/A	\$235	N/A	N/A
GRBTP36SF	36 x - x 1.25	53	2.5	\$2970	N/A	\$353	N/A	N/A

Solid surface, knife edge ⁽³⁾

GRBTP24SK	24 x - x 1.25	24	1.2	\$2188	N/A	\$183	N/A	N/A
GRBTP30SK	29.8 x - x 1.25	37	1.8	\$2411	N/A	\$253	N/A	N/A
GRBTP36SK	36 x - x 1.25	53	2.5	\$3147	N/A	\$376	N/A	N/A



Round Tops

Applicable bases to use with above tops: GRB22Hxx round base or GSB19Hxx square base (15", 21", 26", 28" 35" or 40.5"H). Tops feature metal inserts for ease of assembly to base. One base required.

SQUARE TOPS, 24" - 36"W

Thermally fused laminate, flat edge ⁽¹⁾⁽⁴⁾

GSBTP24	24 x 24 x 1	20	1	\$206	\$91	N/A	\$20.60	N/A
GSBTP30	30 x 30 x 1	30	1.5	\$239	\$108	N/A	\$23.90	N/A
GSBTP36	36 x 36 x 1	44	2	\$303	\$136	N/A	\$30.30	N/A

High pressure laminate, knife edge

GSBTP24LK	24 x 24 x 1.19	24	2	\$768	N/A	N/A	N/A	N/A
GSBTP30LK	30 x 30 x 1.19	36	3	\$834	N/A	N/A	N/A	N/A
GSBTP36LK	36 x 36 x 1.19	53	4	\$895	N/A	N/A	N/A	N/A

Veneer ⁽²⁾

GSBTP24V	24 x 24 x 1.19	24	2	\$1038	N/A	N/A	N/A	\$72
GSBTP30V	30 x 30 x 1.19	36	3	\$1100	N/A	N/A	N/A	\$72
GSBTP36V	36 x 36 x 1.19	53	4	\$1166	N/A	N/A	N/A	\$72

Solid surface, flat edge ⁽³⁾⁽⁴⁾

GSBTP24SF	24 x 24 x 1.25	30	1.2	\$1882	N/A	\$176	\$206	N/A
GSBTP30SF	29.8 x 29.8 x 1.25	47	1.8	\$2323	N/A	\$235	\$206	N/A
GSBTP36SF	36 x 36 x 1.25	68	2.5	\$3024	N/A	\$288	\$206	N/A

Solid surface, knife edge ⁽¹⁾⁽⁴⁾

GSBTP24SK	24 x 24 x 1.25	30	1.2	\$1942	N/A	\$188	\$206	N/A
GSBTP30SK	29.8 x 29.8 x 1.25	47	1.8	\$2912	N/A	\$265	\$206	N/A
GSBTP36SK	36 x 36 x 1.25	68	2.5	\$3606	N/A	\$329	\$206	N/A

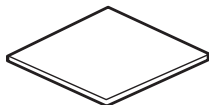

Square Tops

Applicable bases to use with above tops: GRB22Hxx round base or GSB19Hxx square base (15", 21", 26", 28" 35" or 40.5"H). Tops feature metal inserts for ease of assembly to base. One base required.

Required specifications

Top finish
Edge finish ⁽¹⁾

Optional specifications

HP laminate ⁽¹⁾ Knife edge ⁽²⁾
Grade 2 solid surface ⁽³⁾
3" radiused corners ⁽⁴⁾
Q2 cut-out for single port module

Applicable bases

Round bases: GRB22H15, GRB22H21, GRB22H26, GRB22, GRB22H35, GRB22H41
Square bases: GSB19H15, GSB19H21, GSB19H26, GSB19, GSB19H35, GSB19H41

Accessories

Single port modules

RECTANGULAR TOPS, SMALL MODEL # DIMENSIONS WT/LB. CUBIC FT. LIST PRICE HP ADD GRADE 2 R3 ADD KS ADD

W x D x H

Thermally fused laminate, flat edge ⁽¹⁾⁽⁴⁾

GSBTP2430	30 x 24 x 1	20	0.91	\$235	\$103	N/A	\$23.50	N/A
GSBTP2436	36 x 24 x 1	24	1.08	\$271	\$117	N/A	\$27.10	N/A
GSBTP3036	36 x 30 x 1	31	1.34	\$297	\$128	N/A	\$29.70	N/A

High pressure laminate, knife edge

GSBTP2430LK	30 x 24 x 1.19	24	2.5	\$768	N/A	N/A	N/A	N/A
GSBTP2436LK	36 x 24 x 1.19	29	3	\$895	N/A	N/A	N/A	N/A
GSBTP3036LK	36 x 30 x 1.19	37	3.5	\$942	N/A	N/A	N/A	N/A

Veneer ⁽²⁾

GSBTP2430V	30 x 24 x 1.19	24	2.5	\$1038	N/A	N/A	N/A	\$72
GSBTP2436V	36 x 24 x 1.19	29	3	\$1100	N/A	N/A	N/A	\$72
GSBTP3036V	36 x 30 x 1.19	37	3.5	\$1166	N/A	N/A	N/A	\$72

Solid surface, flat edge ⁽³⁾⁽⁴⁾

GSBTP2430SF	24 x 29.8 x 1.25	38	1.8	\$2035	N/A	\$176	\$206	N/A
GSBTP2436SF	24 x 36 x 1.25	45	2.1	\$2295	N/A	\$223	\$206	N/A
GSBTP3036SF	29.8 x 36 x 1.25	57	2.1	\$2606	N/A	\$248	\$206	N/A

Solid surface, knife edge ⁽³⁾⁽⁴⁾

GSBTP2430SK	24 x 29.8 x 1.25	38	1.8	\$2453	N/A	\$218	\$206	N/A
GSBTP2436SK	24 x 36 x 1.25	45	2.1	\$2664	N/A	\$271	\$206	N/A
GSBTP3036SK	29.8 x 36 x 1.25	57	2.1	\$3006	N/A	\$300	\$206	N/A

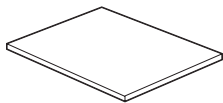

Rectangular Tops

Applicable bases to use with above tops: GRB22Hxx round base or GSB19Hxx square base (15", 21", 26", 28" 35" or 40.5"H). Tops feature metal inserts for ease of assembly to base. One base required.

Required specifications

Top finish
Edge finish ⁽¹⁾

Optional specifications

HP laminate ⁽¹⁾ Knife edge ⁽²⁾
Grade 2 solid surface ⁽³⁾
3" radiused corners ⁽⁴⁾
Q2 cut-out for single port module

Applicable bases

Round bases: GRB22H15, GRB22H21, GRB22H26, GRB22, GRB22H35, GRB22H41
Square bases: GSB19H15, GSB19H21, GSB19H26, GSB19, GSB19H35, GSB19H41

Accessories

Single port modules

BASES FOR TOPS 24" - 36"W MODEL # DIMENSIONS WT/LB. CUBIC FT. LIST PRICE BCH / CHM ACO / SBR

W x D x H

BASE VALID FOR TOPS ON PAGES 333-334:

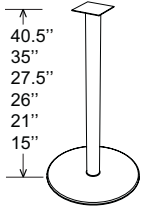

22" Dia Round Bases ⁽¹⁾

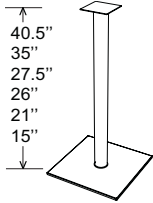

18.5" Square Bases ⁽¹⁾

GRB22H15	22 x - x 15	47.6	4.69	\$793	\$147	\$211
GRB22H21	22 x - x 21	48.6	6.45	\$793	\$147	\$211
GRB22H26	22 x - x 26	55	8.63	\$793	\$147	\$221
GRB22	22 x - x 27.5	55	9.33	\$793	\$147	\$221
GRB22H35	22 x - x 35	57.1	12	\$831	\$164	\$253
GRB22H41	22 x - x 40.5	58.3	14	\$844	\$171	\$259

GRB22H15 - coffee table height **GRB22H26** - lounge height **GRB22H35** - counter height
GRB22H21 - end table height **GRB22** - seated height **GRB22H41** - bar height

GSB19H15	18.5 x 18.5 x 15	43.7	3.52	\$857	\$136	\$204
GSB19H21	18.5 x 18.5 x 21	44.8	4.84	\$857	\$136	\$204
GSB19H26	18.5 x 18.5 x 26	50	5.94	\$857	\$136	\$212
GSB19	18.5 x 18.5 x 27.5	50	6.06	\$857	\$136	\$212
GSB19H35	18.5 x 18.5 x 35	51.8	7.52	\$906	\$151	\$262
GSB19H41	18.5 x 18.5 x 40.5	53.2	8.77	\$937	\$166	\$267

GSB19H15 - coffee table height **GSB19H26** - lounge height **GSB1935** - counter height
GSB19H21 - end table height **GSB19** - seated height **GSB19H41** - bar height

Base comes fully assembled and features 0.5" adjustable glides to level on uneven surfaces. Screws included with base for attaching to appropriate top(s). Base top plate and base plate include pass-through for single port power or USB module (sold separately). Available in paint and plated finishes as listed on page 323. Upcharge applies on plated finishes.

Required specifications
 Finish

Optional specifications
 Plated finish ⁽¹⁾

S SWAP™ TABLES

ROUND TOPS, 42" - 48"W

MODEL # DIMENSIONS WT/LB. CUBIC FT. LIST PRICE HP ADD GRADE 2 R3 ADD KS ADD

W x D x H

Thermally fused laminate, flat edge ⁽¹⁾

GRBTP42	42 x - x 1	44	2.5	\$424	\$174	N/A	N/A	N/A
GRBTP48	48 x - x 1	56	3	\$452	\$188	N/A	N/A	N/A

High pressure laminate, knife edge

GRBTP42LK	42 x - x 1.19	53	5	\$1432	N/A	N/A	N/A	N/A
GRBTP48LK	48 x - x 1.19	67	6.5	\$1637	N/A	N/A	N/A	N/A

Veneer ⁽²⁾

GRBTP42V	42 x - x 1.19	53	5	\$1718	N/A	N/A	N/A	\$72
GRBTP48V	48 x - x 1.19	67	6.5	\$1965	N/A	N/A	N/A	\$81

Solid surface, flat edge ⁽³⁾

GRBTP42SF	42 x - x 1.25	73	3.4	\$4029	N/A	\$453	N/A	N/A
GRBTP48SF	48 x - x 1.25	95	4.3	\$4588	N/A	\$576	N/A	N/A

Solid surface, knife edge ⁽³⁾

GRBTP42SK	42 x - x 1.25	73	3.4	\$4242	N/A	\$506	N/A	N/A
GRBTP48SK	48 x - x 1.25	95	4.3	\$5117	N/A	\$641	N/A	N/A



Round Tops

Applicable bases to use with above tops: GRB28 round base or GSB23 square base (28"H). Tops feature metal inserts for ease of assembly to base. One base required.

SQUARE/RECTANGULAR TOPS, 42"W

Thermally fused laminate, flat edge ⁽¹⁾⁽⁴⁾

GSBTP3042	42 x 30 x 1	36	1.55	\$392	\$169	N/A	\$39.20	N/A
GSBTP3642	42 x 36 x 1	43	1.86	\$421	\$182	N/A	\$42.10	N/A
GSBTP42	42 x 42 x 1	58	2.5	\$424	\$174	N/A	\$42.40	N/A

High pressure laminate, knife edge

GSBTP3042LK	42 x 30 x 1.19	43	4	\$1013	N/A	N/A	N/A	N/A
GSBTP3642LK	42 x 36 x 1.19	52	4.5	\$1075	N/A	N/A	N/A	N/A
GSBTP42LK	42 x 42 x 1.19	70	5	\$1120	N/A	N/A	N/A	N/A

Veneer ⁽²⁾

GSBTP3042V	42 x 30 x 1.19	43	4	\$1274	N/A	N/A	N/A	\$56
GSBTP3642V	42 x 36 x 1.19	52	4.5	\$1330	N/A	N/A	N/A	\$66
GSBTP42V	42 x 42 x 1.19	70	5	\$1560	N/A	N/A	N/A	\$72

Solid surface, flat edge ⁽³⁾⁽⁴⁾

GSBTP3042SF	29.8 x 42 x 1.25	66	2.9	\$2736	N/A	\$300	\$206	N/A
GSBTP3642SF	36 x 42 x 1.25	79	2.9	\$3511	N/A	\$400	\$206	N/A
GSBTP42SF	42 x 42 x 1.25	92	3.4	\$3659	N/A	\$436	\$206	N/A

Solid surface, knife edge ⁽³⁾⁽⁴⁾

GSBTP3042SK	29.8 x 42 x 1.25	66	2.9	\$3205	N/A	\$353	\$206	N/A
GSBTP3642SK	36 x 42 x 1.25	79	2.9	\$4052	N/A	\$476	\$206	N/A
GSBTP42SK	42 x 42 x 1.25	92	3.4	\$4242	N/A	\$529	\$206	N/A

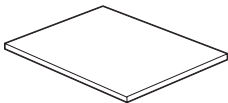

Rectangular Tops

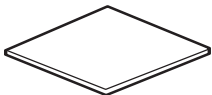

Square Tops

Applicable bases to use with above tops: GRB28 round base or GSB23 square base (28"H). Tops feature metal inserts for ease of assembly to base. One base required.

Required specifications

Top finish
Edge finish ⁽¹⁾

Optional specifications

HP laminate ⁽¹⁾
Knife edge ⁽²⁾
Grade 2 solid surface ⁽³⁾
3" radiused corners ⁽⁴⁾

Applicable bases

GRB28 - round
GSB23 - square

BASES FOR TOPS 42" - 48"W MODEL # DIMENSIONS WT/LB. CUBIC FT. LIST PRICE BCH / CHM ACO / SBR

W x D x H

BASES VALID FOR TOPS ON PAGE 336:

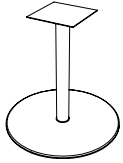

28" Dia Round Base

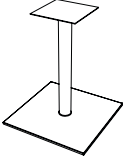

23" Square Base

GRB28	28 x - x 27.5	100	15.63	\$1250	\$147	\$372
seated height						

GSB23	22.5 x 22.5 x 27.5	82	9.33	\$1146	\$136	\$235
seated height						

Base comes fully assembled and features 0.5" adjustable glides to level on uneven surfaces. Screws included with base for attaching to appropriate top(s). Available in paint and plated finishes as listed on page 323. Upcharge applies on plated finishes.

Required Specifications
Finish

Optional Specifications
Plated finish

S SWAP™ TABLES

ROUND TOPS, 54" - 60"W

MODEL #	DIMENSIONS	WT/LB.	CUBIC FT.	LIST PRICE	HP ADD	GRADE 2	R3 ADD	KS ADD
---------	------------	--------	-----------	------------	--------	---------	--------	--------

W x D x H

Thermally fused laminate, flat edge ⁽¹⁾

GRBTP54	54 x - x 1	73	4.5	\$603	\$271	N/A	N/A	N/A
GRBTP60	60 x - x 1	92	5	\$627	\$282	N/A	N/A	N/A

High pressure laminate, knife edge

GRBTP54LK	54 x - x 1.19	88	8	\$1847	N/A	N/A	N/A	N/A
GRBTP60LK	60 x - x 1.19	110	10	\$2276	N/A	N/A	N/A	N/A

Veneer ⁽²⁾

GRBTP54V	54 x - x 1.19	88	8	\$2507	N/A	N/A	N/A	\$97
GRBTP60V	60 x - x 1.19	110	10	\$3094	N/A	N/A	N/A	\$102

Solid surface, flat edge ⁽³⁾

GRBTP54SF	54 x - x 1.25	120	5.4	\$4971	N/A	\$706	N/A	N/A
GRBTP60SF	60 x - x 1.25	148	6.7	\$6530	N/A	\$882	N/A	N/A

Solid surface, knife edge ⁽³⁾

GRBTP54SK	54 x - x 1.25	120	5.4	\$5876	N/A	\$888	N/A	N/A
GRBTP60SK	60 x - x 1.25	148	6.7	\$7189	N/A	\$1077	N/A	N/A



Round Tops

Applicable bases to use with above tops: GRB34 round base or GSB28 square base (28"H). Tops feature metal inserts for ease of assembly to base. One base required.

BASES FOR TOPS 54" - 60"W

MODEL #	DIMENSIONS	WT/LB.	CUBIC FT.	LIST PRICE	BCH / CHM	ACO / SBR
---------	------------	--------	-----------	------------	-----------	-----------

W x D x H

BASES VALID FOR TOPS ABOVE:

Order the quantity of bases as indicated by each top size.

GRB34	34 x - x 27.5	135	20.56	\$1538	\$147	\$449
-------	---------------	-----	-------	---------------	--------------	--------------

seated height

GSB28	28.5 x 28.5 x 27.5	125	15.63	\$1432	\$136	\$242
-------	--------------------	-----	-------	---------------	--------------	--------------

seated height

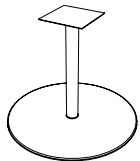

34" Dia Round Base

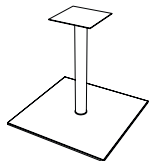

28" Square Base

Base comes fully assembled and features 0.5" adjustable glides to level on uneven surfaces. Screws included with base for attaching to appropriate top(s). Available in paint and plated finishes as listed on page 323. Upcharge applies on plated finishes.

Required specifications

Top finish
Edge finish ⁽¹⁾
Base finish

Optional specifications

HP laminate ⁽¹⁾
Knife edge ⁽²⁾
Grade 2 solid surface ⁽³⁾
Base plated finish

Applicable bases

GRB34 - round
GSB28 - square

RECTANGULAR LOUNGE TOPS, 24" D **MODEL #** **DIMENSIONS** **WT/LB.** **CUBIC FT.** **LIST PRICE** **HP ADD** **GRADE 2** **R3 ADD** **KS ADD**

W x D x H

Thermally fused laminate, flat edge ⁽¹⁾⁽⁴⁾

GRT5STP	60 x 24 x 1	41	1.79	\$406	\$173	N/A	\$40.60	N/A
GRT5HSTP	66 x 24 x 1	46	1.97	\$474	\$173	N/A	\$47.40	N/A
GRT6STP	72 x 24 x 1	49	2.14	\$494	\$184	N/A	\$49.40	N/A
GRT7STP	84 x 24 x 1	57	2.49	\$573	\$219	N/A	\$49.40	N/A
GRT8STP	96 x 24 x 1	66	2.84	\$615	\$240	N/A	\$61.50	N/A

High pressure laminate, knife edge

GRT5STPLK	60 x 24 x 1.19	49	4	\$1100	N/A	N/A	N/A	N/A
GRT5HSTPLK	66 x 24 x 1.19	55	4.5	\$1166	N/A	N/A	N/A	N/A
GRT6STPLK	72 x 24 x 1.19	59	5	\$1228	N/A	N/A	N/A	N/A
GRT7STPLK	84 x 24 x 1.19	68	5.5	\$1356	N/A	N/A	N/A	N/A
GRT8STPLK	96 x 24 x 1.19	79	6.5	\$1535	N/A	N/A	N/A	N/A

Veneer ⁽²⁾

GRT5STPV	60 x 24 x 1.19	49	4	\$1356	N/A	N/A	N/A	\$66
GRT5HSTPV	66 x 24 x 1.19	55	4.5	\$1422	N/A	N/A	N/A	\$66
GRT6STPV	72 x 24 x 1.19	59	5	\$1550	N/A	N/A	N/A	\$66
GRT7STPV	84 x 24 x 1.19	68	5.5	\$1806	N/A	N/A	N/A	\$66
GRT8STPV	96 x 24 x 1.19	79	6.5	\$2061	N/A	N/A	N/A	\$66

Solid surface, flat edge ⁽³⁾⁽⁴⁾

GRT5STPSF	60 x 24 x 1.25	75	2.8	\$3941	N/A	\$441	\$206	N/A
GRT5HSTPSF	66 x 24 x 1.25	83	3.1	\$4117	N/A	\$453	\$206	N/A
GRT6STPSF	71.8 x 24 x 1.25	90	3.3	\$4341	N/A	\$464	\$206	N/A
GRT7STPSF	84 x 24 x 1.25	105	3.9	\$4824	N/A	\$606	\$206	N/A
GRT8STPSF	96 x 24 x 1.25	120	4.4	\$5294	N/A	\$617	\$206	N/A

Solid surface, knife edge ⁽³⁾⁽⁴⁾

GRT5STPSK	60 x 24 x 1.25	75	2.8	\$4441	N/A	\$471	\$206	N/A
GRT5HSTPSK	66 x 24 x 1.25	83	3.1	\$4618	N/A	\$494	\$206	N/A
GRT6STPSK	71.8 x 24 x 1.25	90	3.3	\$4841	N/A	\$518	\$206	N/A
GRT7STPSK	84 x 24 x 1.25	105	3.9	\$5518	N/A	\$671	\$206	N/A
GRT8STPSK	96 x 24 x 1.25	120	4.4	\$6006	N/A	\$694	\$206	N/A

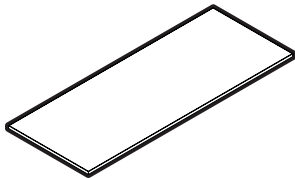

Rectangular Tops

Applicable bases to use with above tops - two bases required: GRB22Hxx round bases or GSB19Hxx square bases (26", 35" or 40.5" H). Tops feature metal inserts for ease of assembly to base. 24"D tops not recommended with 28"H bases.

Required specifications

Top finish
Edge finish ⁽¹⁾

Optional specifications

HP laminate ⁽¹⁾ Knife edge ⁽²⁾
Grade 2 solid surface ⁽³⁾
3" radiused corners ⁽⁴⁾
Grommet position or power block cut-out

Applicable bases (two required)

Round bases:
GRB22H26, GRB22H35, GRB22H41
Square bases:
GSB19H26, GSB19H35, GSB19H41

Accessories

Power block

RACETRACK LOUNGE TOPS, 24"D

MODEL # DIMENSIONS WT/LB. CUBIC FT. LIST PRICE HP ADD KS ADD

W x D x H

Thermally fused laminate, flat edge ⁽¹⁾

GRC5STP	60 x 24 x 1	41	1.79	\$406	\$173	N/A
GRC5HSTP	66 x 24 x 1	46	1.97	\$474	\$173	N/A
GRC6STP	72 x 24 x 1	49	2.14	\$494	\$185	N/A
GRC7STP	84 x 24 x 1	57	2.49	\$573	\$222	N/A
GRC8STP	96 x 24 x 1	66	2.84	\$615	\$244	N/A

High pressure laminate, knife edge

GRC5STPLK	60 x 24 x 1.19	49	4	\$1356	N/A	N/A
GRC5HSTPLK	66 x 24 x 1.19	55	4.5	\$1484	N/A	N/A
GRC6STPLK	72 x 24 x 1.19	59	5	\$1612	N/A	N/A
GRC7STPLK	84 x 24 x 1.19	68	5.5	\$1739	N/A	N/A
GRC8STPLK	96 x 24 x 1.19	79	6.5	\$1868	N/A	N/A

Veneer ⁽²⁾

GRC5STPV	60 x 24 x 1.19	49	4	\$1612	N/A	\$230
GRC5HSTPV	66 x 24 x 1.19	55	4.5	\$1766	N/A	\$256
GRC6STPV	72 x 24 x 1.19	59	5	\$1918	N/A	\$275
GRC7STPV	84 x 24 x 1.19	68	5.5	\$2225	N/A	\$275
GRC8STPV	96 x 24 x 1.19	79	6.5	\$2532	N/A	\$275

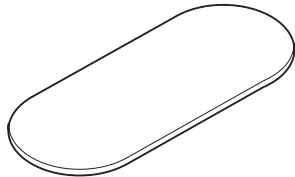

Racetrack Tops

Applicable bases to use with above tops - two bases required: GRB22Hxx round bases or GSB19Hxx square bases (26", 35" or 40.5" H). Tops feature metal inserts for ease of assembly to base. 24"D tops not recommended with 28"H bases.

Required specifications

Top finish
Edge finish ⁽¹⁾

Optional specifications

HP laminate ⁽¹⁾
Knife edge ⁽²⁾
Grommet position or power block cut-out

Applicable bases (two required)

Round bases:
GRB22H26, GRB22H35, GRB22H41
Square bases:
GSB19H26, GSB19H35, GSB19H41

Accessories

Power block

RECTANGULAR TOPS, 60" - 96"W

MODEL #	DIMENSIONS	WT/LB.	CUBIC FT.	LIST PRICE	HP ADD	GRADE 2	R3 ADD	KS ADD
---------	------------	--------	-----------	------------	--------	---------	--------	--------

W x D x H

Thermally fused laminate, flat edge ⁽¹⁾⁽⁴⁾

GRT5NTP	60 x 30 x 1	46	2.5	\$414	\$173	N/A	\$41.40	N/A
GRT5NHTP	66 x 30 x 1	56	2.44	\$443	\$184	N/A	\$44.30	N/A
GRT6NTP	72 x 30 x 1	62	3	\$449	\$194	N/A	\$44.90	N/A
GRT7NTP	84 x 30 x 1	72	7.5	\$536	\$231	N/A	\$53.60	N/A
GRT8NTP	96 x 30 x 1	80	8.5	\$592	\$241	N/A	\$59.20	N/A
GRT5TP	60 x 36 x 1	70	6.6	\$472	\$188	N/A	\$47.20	N/A
GRT5HTP	66 x 36 x 1	79	7.21	\$481	\$195	N/A	\$48.10	N/A
GRT6TP	72 x 36 x 1	72	8	\$481	\$195	N/A	\$48.10	N/A
GRT7TP	84 x 36 x 1	85	8.75	\$591	\$241	N/A	\$59.10	N/A
GRT8TP	96 x 36 x 1	94	9	\$648	\$275	N/A	\$64.80	N/A

High pressure laminate, knife edge

GRT5NTPLK	60 x 30 x 1.19	55	5	\$1218	N/A	N/A	N/A	N/A
GRT5NHTPLK	66 x 30 x 1.19	67	5.5	\$1330	N/A	N/A	N/A	N/A
GRT6NTPLK	72 x 30 x 1.19	74	6	\$1448	N/A	N/A	N/A	N/A
GRT7NTPLK	84 x 30 x 1.19	86	7	\$1668	N/A	N/A	N/A	N/A
GRT8NTPLK	96 x 30 x 1.19	96	8	\$1898	N/A	N/A	N/A	N/A
GRT5TPLK	60 x 36 x 1.19	84	6	\$1448	N/A	N/A	N/A	N/A
GRT5HTPLK	66 x 36 x 1.19	95	6.5	\$1581	N/A	N/A	N/A	N/A
GRT6TPLK	72 x 36 x 1.19	86	7	\$1719	N/A	N/A	N/A	N/A
GRT7TPLK	84 x 36 x 1.19	102	8	\$1990	N/A	N/A	N/A	N/A
GRT8TPLK	96 x 36 x 1.19	113	9	\$2266	N/A	N/A	N/A	N/A

Veneer ⁽²⁾

GRT5NTPV	60 x 30 x 1.19	55	5	\$1663	N/A	N/A	N/A	\$77
GRT5NHTPV	66 x 30 x 1.19	67	5.5	\$1770	N/A	N/A	N/A	\$77
GRT6NTPV	72 x 30 x 1.19	74	6	\$1898	N/A	N/A	N/A	\$97
GRT7NTPV	84 x 30 x 1.19	86	7	\$2204	N/A	N/A	N/A	\$112
GRT8NTPV	96 x 30 x 1.19	96	8	\$2507	N/A	N/A	N/A	\$128
GRT5TPV	60 x 36 x 1.19	84	6	\$1898	N/A	N/A	N/A	\$97
GRT5HTPV	66 x 36 x 1.19	95	6.5	\$2072	N/A	N/A	N/A	\$128
GRT6TPV	72 x 36 x 1.19	86	7	\$2251	N/A	N/A	N/A	\$143
GRT7TPV	84 x 36 x 1.19	102	8	\$2614	N/A	N/A	N/A	\$164
GRT8TPV	96 x 36 x 1.19	113	9	\$2982	N/A	N/A	N/A	\$179

Solid surface, flat edge ⁽³⁾⁽⁴⁾

GRT5NTPSF	60 x 29.8 x 1.25	94	3.4	\$4106	N/A	\$436	\$206	N/A
GRT5NHTPSF	66 x 29.8 x 1.25	104	3.8	\$4406	N/A	\$506	\$206	N/A
GRT6NTPSF	71.8 x 29.8 x 1.25	113	4.1	\$5029	N/A	\$706	\$206	N/A
GRT7NTPSF	84 x 29.8 x 1.25	132	4.8	\$5836	N/A	\$694	\$206	N/A
GRT8NTPSF	96 x 29.8 x 1.25	150	5.4	\$6423	N/A	\$900	\$206	N/A
GRT5TPSF	60 x 36 x 1.25	113	4.1	\$5465	N/A	\$647	\$206	N/A
GRT5HTPSF	66 x 36 x 1.25	124	4.5	\$5641	N/A	\$647	\$206	N/A
GRT6TPSF	71.8 x 36 x 1.25	135	4.9	\$6229	N/A	\$706	\$206	N/A
GRT7TPSF	84 x 36 x 1.25	158	5.7	\$6776	N/A	\$853	\$206	N/A
GRT8TPSF	96 x 36 x 1.25	180	6.5	\$7271	N/A	\$894	\$206	N/A

Solid surface, knife edge ⁽³⁾⁽⁴⁾

GRT5NTPSK	60 x 29.8 x 1.25	94	3.4	\$4494	N/A	\$494	\$206	N/A
GRT5NHTPSK	66 x 29.8 x 1.25	104	3.8	\$4853	N/A	\$576	\$206	N/A
GRT6NTPSK	71.8 x 29.8 x 1.25	113	4.1	\$5470	N/A	\$789	\$206	N/A
GRT7NTPSK	84 x 29.8 x 1.25	132	4.8	\$6277	N/A	\$789	\$206	N/A
GRT8NTPSK	96 x 29.8 x 1.25	150	5.4	\$6971	N/A	\$1005	\$206	N/A
GRT5TPSK	60 x 36 x 1.25	113	4.1	\$6053	N/A	\$729	\$206	N/A
GRT5HTPSK	66 x 36 x 1.25	124	4.5	\$6206	N/A	\$741	\$206	N/A
GRT6TPSK	71.8 x 36 x 1.25	135	4.9	\$6876	N/A	\$812	\$206	N/A
GRT7TPSK	84 x 36 x 1.25	158	5.7	\$7429	N/A	\$970	\$206	N/A
GRT8TPSK	96 x 36 x 1.25	180	6.5	\$7911	N/A	\$1023	\$206	N/A

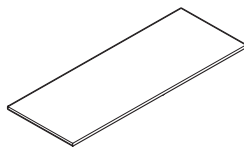

Rectangular Tops

Applicable bases to use with above tops - two bases required: GRB22H26, GRB22, GRB22H35, GRB22H41 round bases or GSB19H26, GSB19, GSB19H35, GSB19H41 square bases. Tops feature metal inserts for ease of assembly to base.

Required specifications

Top finish
Edge finish ⁽¹⁾

Optional specifications

HP laminate ⁽¹⁾ Knife edge ⁽²⁾
Grade 2 solid surface ⁽³⁾
3" radiused corners ⁽⁴⁾
Grommet position or power block cut-out

Applicable bases (two required)

Round bases:
GRB22H26, GRB22, GRB22H35, GRB22H41
Square bases:
GSB19H26, GSB19, GSB19H35, GSB19H41

Accessories

Power block

RACETRACK TOPS, 60" - 96"W

MODEL # DIMENSIONS WT/LB. CUBIC FT. LIST PRICE HP ADD KS ADD

W x D x H

Thermally fused laminate, flat edge ⁽¹⁾

GRC5NTP	60 x 30 x 1	46	2.5	\$422	\$178	N/A
GRC5NHTP	66 x 30 x 1	56	2.44	\$457	\$187	N/A
GRC6NTP	72 x 30 x 1	62	3	\$459	\$195	N/A
GRC7NTP	84 x 30 x 1	72	7.5	\$548	\$233	N/A
GRC8NTP	96 x 30 x 1	80	8.5	\$601	\$244	N/A
GRC5TP	60 x 36 x 1	70	6.6	\$483	\$195	N/A
GRC5HTP	66 x 36 x 1	79	7.21	\$488	\$199	N/A
GRC6TP	72 x 36 x 1	72	7.5	\$488	\$199	N/A
GRC7TP	84 x 36 x 1	85	8.75	\$600	\$244	N/A
GRC8TP	96 x 36 x 1	94	9	\$659	\$275	N/A

High pressure laminate, knife edge

GRC5NTPLK	60 x 30 x 1.19	55	5	\$1673	N/A	N/A
GRC5NHTPLK	66 x 30 x 1.19	67	5.5	\$1826	N/A	N/A
GRC6NTPLK	72 x 30 x 1.19	74	6	\$1990	N/A	N/A
GRC7NTPLK	84 x 30 x 1.19	86	7	\$2133	N/A	N/A
GRC8NTPLK	96 x 30 x 1.19	96	8	\$2287	N/A	N/A
GRC5TPLK	60 x 36 x 1.19	84	6	\$1826	N/A	N/A
GRC5HTPLK	66 x 36 x 1.19	95	6.5	\$1980	N/A	N/A
GRC6TPLK	72 x 36 x 1.19	86	7	\$2144	N/A	N/A
GRC7TPLK	84 x 36 x 1.19	102	8	\$2451	N/A	N/A
GRC8TPLK	96 x 36 x 1.19	113	9	\$2758	N/A	N/A

Veneer ⁽²⁾

GRC5NTPV	60 x 30 x 1.19	55	5	\$1882	N/A	\$271
GRC5NHTPV	66 x 30 x 1.19	67	5.5	\$2026	N/A	\$292
GRC6NTPV	72 x 30 x 1.19	74	6	\$2175	N/A	\$312
GRC7NTPV	84 x 30 x 1.19	86	7	\$2527	N/A	\$363
GRC8NTPV	96 x 30 x 1.19	96	8	\$2870	N/A	\$415
GRC5TPV	60 x 36 x 1.19	84	6	\$2175	N/A	\$312
GRC5HTPV	66 x 36 x 1.19	95	6.5	\$2374	N/A	\$343
GRC6TPV	72 x 36 x 1.19	86	7	\$2578	N/A	\$373
GRC7TPV	84 x 36 x 1.19	102	8	\$2998	N/A	\$435
GRC8TPV	96 x 36 x 1.19	113	9	\$3417	N/A	\$496

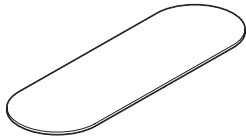

Racetrack Tops

Applicable bases to use with above tops - two bases required: GRB22H26, GRB22, GRB22H35, GRB22H41 round bases or GSB19H26, GSB19, GSB19H35, GSB19H41 square bases. Tops feature metal inserts for ease of assembly to base.

Required specifications

Top finish
Edge finish ⁽¹⁾

Optional specifications

HP laminate ⁽¹⁾
Knife edge ⁽²⁾
Grommet position or power block cut-out

Applicable bases (two required)

Round bases:
GRB22H26, GRB22, GRB22H35, GRB22H41
Square bases:
GSB19H26, GSB19, GSB19H35, GSB19H41

Accessories

Power block

BOAT SHAPE TOPS, 60" - 96"W **MODEL #** **DIMENSIONS** **WT/LB.** **CUBIC FT.** **LIST PRICE** **HP ADD** **KS ADD**

W x D x H

Thermally fused laminate, flat edge ⁽¹⁾

GBT5NTP	60 x 30 x 1	46	2.5	\$422	\$178	N/A
GBT5NHTP	66 x 30 x 1	56	2.44	\$457	\$187	N/A
GBT6NTP	72 x 30 x 1	62	3	\$459	\$195	N/A
GBT7NTP	84 x 30 x 1	72	7.5	\$548	\$233	N/A
GBT8NTP	96 x 30 x 1	80	8.5	\$601	\$244	N/A
GBT5TP	60 x 36 x 1	70	6.6	\$483	\$195	N/A
GBT5HTP	66 x 36 x 1	79	7.21	\$488	\$199	N/A
GBT6TP	72 x 36 x 1	72	7.5	\$488	\$199	N/A
GBT7TP	84 x 36 x 1	85	8.75	\$600	\$244	N/A
GBT8TP	96 x 36 x 1	94	9	\$659	\$275	N/A

High pressure laminate, knife edge

GBT5NTPLK	60 x 30 x 1.19	55	5	\$1673	N/A	N/A
GBT5NHTPLK	66 x 30 x 1.19	67	5.5	\$1826	N/A	N/A
GBT6NTPLK	72 x 30 x 1.19	74	6	\$1990	N/A	N/A
GBT7NTPLK	84 x 30 x 1.19	86	7	\$2133	N/A	N/A
GBT8NTPLK	96 x 30 x 1.19	96	8	\$2287	N/A	N/A
GBT5TPLK	60 x 36 x 1.19	84	6	\$1826	N/A	N/A
GBT5HTPLK	66 x 36 x 1.19	95	6.5	\$1980	N/A	N/A
GBT6TPLK	72 x 36 x 1.19	86	7	\$2144	N/A	N/A
GBT7TPLK	84 x 36 x 1.19	102	8	\$2451	N/A	N/A
GBT8TPLK	96 x 36 x 1.19	113	9	\$2758	N/A	N/A

Veneer ⁽²⁾

GBT5NTPV	60 x 30 x 1.19	55	5	\$1882	N/A	\$271
GBT5NHTPV	66 x 30 x 1.19	67	5.5	\$2026	N/A	\$292
GBT6NTPV	72 x 30 x 1.19	74	6	\$2175	N/A	\$312
GBT7NTPV	84 x 30 x 1.19	86	7	\$2527	N/A	\$363
GBT8NTPV	96 x 30 x 1.19	96	8	\$2870	N/A	\$415
GBT5TPV	60 x 36 x 1.19	84	6	\$2175	N/A	\$312
GBT5HTPV	66 x 36 x 1.19	95	6.5	\$2374	N/A	\$343
GBT6TPV	72 x 36 x 1.19	86	7	\$2578	N/A	\$373
GBT7TPV	84 x 36 x 1.19	102	8	\$2998	N/A	\$435
GBT8TPV	96 x 36 x 1.19	113	9	\$3417	N/A	\$496

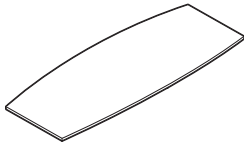

Boat Shape Tops

Applicable bases to use with above tops - two bases required: GRB22H26, GRB22, GRB22H35, GRB22H41 round bases or GSB19H26, GSB19, GSB19H35, GSB19H41 square bases. Tops feature metal inserts for ease of assembly to base.

- GBTxNTP/GBTxNHTP: 30"D across center and 24"D at ends.
- GBTxTP/GBTxHTP: 36"D across center and 28"D at ends.

Required specifications

Top finish
Edge finish ⁽¹⁾

Optional specifications

HP laminate ⁽¹⁾
Knife edge ⁽²⁾
Grommet position or power block cut-out

Applicable bases (two required)

Round bases:
GRB22H26, GRB22, GRB22H35, GRB22H41
Square bases:
GSB19H26, GSB19, GSB19H35, GSB19H41

Accessories

Power block

S SWAP™ TABLES

BASES FOR TOPS 60" - 96"W

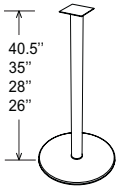

22" Dia Round Bases

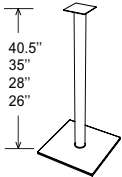

18.5" Square Bases

MODEL #	DIMENSIONS	WT/LB.	CUBIC FT.	LIST PRICE	BCH / CHM	ACO / SBR
---------	------------	--------	-----------	------------	-----------	-----------

W x D x H

Order the quantity of bases as indicated by each top size.

GRB22H26	22 x - x 26	55	8.63	\$793	\$147	\$221
GRB22	22 x - x 27.5	55	9.33	\$793	\$147	\$221
GRB22H35	22 x - x 35	57.1	12	\$831	\$164	\$253
GRB22H41	22 x - x 40.5	58.3	14	\$844	\$171	\$259

GRB22H26 - lounge height **GRB22** - seated height **GRB22H35** - counter height **GRB22H41** - bar height

GSB19H26	18.5 x 18.5 x 26	50	5.94	\$857	\$136	\$212
GSB19	18.5 x 18.5 x 27.5	50	6.06	\$857	\$136	\$212
GSB19H35	18.5 x 18.5 x 35	51.8	7.52	\$906	\$151	\$262
GSB19H41	18.5 x 18.5 x 40.5	53.2	8.77	\$937	\$166	\$267

GSB19H26 - lounge height **GSB19** - seated height **GSB19H35** - counter height **GSB19H41** - bar height

Base comes fully assembled and features 0.5" adjustable glides to level on uneven surfaces. Screws included with base for attaching to appropriate top(s). Available in paint and plated finishes as listed on page 323. Upcharge applies on plated finishes.

Required Specifications

Finish

Optional Specifications

Plated finish

RECTANGULAR TOPS, 96" - 144"W

MODEL #	DIMENSIONS	WT/LB.	CUBIC FT.	LIST PRICE	HP ADD	R3 ADD	KS ADD
W x D x H							
Thermally fused laminate, flat edge (1 piece top - 2 bases required) ⁽¹⁾⁽⁴⁾							
GRT8MTP	96 x 42 x 1	128	11.84	\$1221	\$504	\$122.10	N/A
GRT8WTP	96 x 48 x 1	190	14	\$1221	\$512	\$122.10	N/A
Thermally fused laminate, flat edge (2 piece tops - 3 bases required) ⁽¹⁾⁽⁴⁾							
GRT10WTP	120 x 48 x 1	220	17	\$1537	\$636	\$153.70	N/A
GRT12WTP	144 x 48 x 1	262	21	\$1791	\$739	\$179.10	N/A
High pressure laminate, knife edge (1 piece top - 2 bases required)							
GRT8MTPLK	96 x 42 x 1.19	154	11	\$3069	N/A	N/A	N/A
GRT8WTPLK	96 x 48 x 1.19	228	12	\$3432	N/A	N/A	N/A
High pressure laminate, knife edge (2 piece tops - 3 bases required)							
GRT10WTPLK	120 x 48 x 1.19	264	15	\$4630	N/A	N/A	N/A
GRT12WTPLK	144 x 48 x 1.19	314	18	\$5524	N/A	N/A	N/A
Veneer (1 piece top - 2 bases required) ⁽²⁾							
GRT8MTPV	96 x 42 x 1.19	154	11	\$3903	N/A	N/A	\$378
GRT8WTPV	96 x 48 x 1.19	228	12	\$4389	N/A	N/A	\$430
Veneer (2 piece tops - 3 bases required) ⁽²⁾							
GRT10WTPV	120 x 48 x 1.19	264	15	\$5821	N/A	N/A	\$573
GRT12WTPV	144 x 48 x 1.19	314	18	\$6952	N/A	N/A	\$685

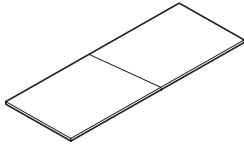

Rectangular Tops

Applicable bases to use with above tops: GRB28 round base or GSB23 square base (28" H).
Two bases required for 96"W tops or three bases required for 120" and 144"W tops.
 Tops feature metal inserts for ease of assembly to base.

RACETRACK TOPS, 96" - 144"W

Thermally fused laminate, flat edge (1 piece top - 2 bases required) ⁽¹⁾							
GRC8MTP	96 x 42 x 1	128	11.84	\$1240	\$504	N/A	N/A
GRC8WTP	96 x 48 x 1	190	14	\$1240	\$512	N/A	N/A
Thermally fused laminate, flat edge (2 piece tops - 3 bases required) ⁽¹⁾							
GRC10WTP	120 x 48 x 1	220	17	\$1560	\$636	N/A	N/A
GRC12WTP	144 x 48 x 1	262	21	\$1818	\$739	N/A	N/A
High pressure laminate, knife edge (1 piece top - 2 bases required)							
GRC8MTPLK	96 x 42 x 1.19	154	11	\$3658	N/A	N/A	N/A
GRC8WTPLK	96 x 48 x 1.19	228	12	\$4169	N/A	N/A	N/A
High pressure laminate, knife edge (2 piece tops - 3 bases required)							
GRC10WTPLK	120 x 48 x 1.19	264	15	\$5192	N/A	N/A	N/A
GRC12WTPLK	144 x 48 x 1.19	314	18	\$6215	N/A	N/A	N/A
Veneer (1 piece top - 2 bases required) ⁽²⁾							
GRC8MTPV	96 x 42 x 1.19	154	11	\$4630	N/A	N/A	\$455
GRC8WTPV	96 x 48 x 1.19	228	12	\$5141	N/A	N/A	\$506
Veneer (2 piece tops - 3 bases required) ⁽²⁾							
GRC10WTPV	120 x 48 x 1.19	264	15	\$6727	N/A	N/A	\$666
GRC12WTPV	144 x 48 x 1.19	314	18	\$7954	N/A	N/A	\$788

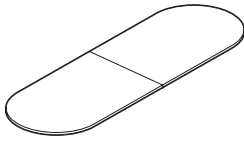

Racetrack Tops

Applicable bases to use with above tops: GRB28 round base or GSB23 square base (28" H).
Two bases required for 96"W tops or three bases required for 120" and 144"W tops.
 Tops feature metal inserts for ease of assembly to base.

Required specifications	Optional specifications	Applicable bases (two or three required)	Accessories
Top finish Edge finish ⁽¹⁾	HP laminate ⁽¹⁾ Knife edge ⁽²⁾ 3" radiused corners ⁽⁴⁾ Grommet position or power block cut-out	GRB28 - round GSB23 - square	Power block

BOAT SHAPE TOPS, 96" - 144"W

MODEL #	DIMENSIONS	WT/LB.	CUBIC FT.	LIST PRICE	HP ADD	KS ADD
---------	------------	--------	-----------	------------	--------	--------

W x D x H

Thermally fused laminate, flat edge (1 piece top - 2 bases required) ⁽¹⁾

GBT8MTP	96 x 42 x 1	128	11.84	\$1240	\$504	N/A
GBT8WTP	96 x 48 x 1	190	14	\$1240	\$512	N/A

Thermally fused laminate, flat edge (2 piece tops - 3 bases required) ⁽¹⁾

GBT10WTP	120 x 48 x 1	220	17	\$1560	\$636	N/A
GBT12WTP	144 x 48 x 1	262	21	\$1818	\$739	N/A

High pressure laminate, knife edge (1 piece top - 2 bases required)

GBT8MTPLK	96 x 42 x 1.19	154	11	\$3658	N/A	N/A
GBT8WTPLK	96 x 48 x 1.19	228	12	\$4169	N/A	N/A

High pressure laminate, knife edge (2 piece tops - 3 bases required)

GBT10WTPLK	120 x 48 x 1.19	264	15	\$5192	N/A	N/A
GBT12WTPLK	144 x 48 x 1.19	314	18	\$6215	N/A	N/A

Veneer (1 piece top - 2 bases required) ⁽²⁾

GBT8MTPV	96 x 42 x 1.19	154	11	\$4630	N/A	\$455
GBT8WTPV	96 x 48 x 1.19	228	12	\$5141	N/A	\$506

Veneer (2 piece tops - 3 bases required) ⁽²⁾

GBT10WTPV	120 x 48 x 1.19	264	15	\$6727	N/A	\$666
GBT12WTPV	144 x 48 x 1.19	314	18	\$7954	N/A	\$788

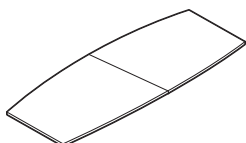

Boat Shape Tops

Applicable bases to use with above tops: GRB28 round base or GSB23 square base (28"H).

Two bases required for 96"W tops or three bases required for 120" and 144"W tops.

Tops feature metal inserts for ease of assembly to base.

- GBTxMTP: 42"D at center and 33"D at ends.
- GBTxxWTP: 48"D at center and 38"D at ends.

BASES FOR TOPS 60" - 96"W

MODEL #	DIMENSIONS	WT/LB.	CUBIC FT.	LIST PRICE	BCH / CHM	ACO / SBR
---------	------------	--------	-----------	------------	-----------	-----------

W x D x H

BASE VALID FOR TOPS ON PAGES 345-346:

Order the quantity of bases as indicated by each top size.

GRB28	28 x - x 27.5	100	15.63	\$1250	\$147	\$372
-------	---------------	-----	-------	---------------	--------------	--------------

seated height

GSB23	22.5 x 22.5 x 27.5	82	9.33	\$1146	\$136	\$235
-------	--------------------	----	------	---------------	--------------	--------------

seated height

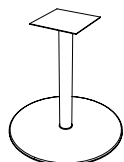

28" Dia Round Base

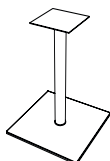

23" Square Base

Base comes fully assembled and features 0.5" adjustable glides to level on uneven surfaces. Screws included with base for attaching to appropriate top(s). Available in paint and plated finishes as listed on page 323. Upcharge applies on plated finishes.

Required specifications

Top finish
Edge finish ⁽¹⁾
Base finish

Optional specifications

HP laminate ⁽¹⁾
Knife edge ⁽²⁾
Grommet position or power block cut-out
Base plated finish

Applicable bases (two or three required)

GRB28 - round
GSB23 - square

Accessories

Power block

RECTANGULAR TOPS FOR DUAL COLUMN BASE

MODEL #	DIMENSIONS	WT/LB.	CUBIC FT.	LIST PRICE	HP ADD	R3 ADD	KS ADD
W x D x H							
Thermally fused laminate, flat edge ⁽¹⁾⁽⁴⁾							
GRTD5TP	60 x 36 x 1	60	6.6	\$472	\$188	\$47.20	N/A
GRTD5HTP	66 x 36 x 1	69	7.21	\$481	\$195	\$48.10	N/A
GRTD6TP	72 x 36 x 1	75	7.82	\$481	\$195	\$48.10	N/A
GRTD5MTP	60 x 42 x 1	73	7.62	\$633	\$273	\$63.30	N/A
GRTD5HMTP	66 x 42 x 1	81	8.32	\$675	\$294	\$67.50	N/A
GRTD6MTP	72 x 42 x 1	89	9.02	\$694	\$300	\$69.40	N/A
High pressure laminate, knife edge							
GRTD5TPLK	60 x 36 x 1.19	72	6	\$1448	N/A	N/A	N/A
GRTD5HTPLK	66 x 36 x 1.19	83	6.5	\$1581	N/A	N/A	N/A
GRTD6TPLK	72 x 36 x 1.19	90	7	\$1719	N/A	N/A	N/A
GRTD5MTPLK	60 x 42 x 1.19	88	7	\$1668	N/A	N/A	N/A
GRTD5HMTPK	66 x 42 x 1.19	97	7.5	\$1832	N/A	N/A	N/A
GRTD6MTPLK	72 x 42 x 1.19	107	8	\$1990	N/A	N/A	N/A
Veneer ⁽²⁾							
GRTD5TPV	60 x 36 x 1.19	72	6	\$1898	N/A	N/A	\$184
GRTD5HTPV	66 x 36 x 1.19	83	6.5	\$2072	N/A	N/A	\$199
GRTD6TPV	72 x 36 x 1.19	90	7	\$2251	N/A	N/A	\$215
GRTD5MTPV	60 x 42 x 1.19	88	7	\$2195	N/A	N/A	\$210
GRTD5HMTPV	66 x 42 x 1.19	97	7.5	\$2405	N/A	N/A	\$230
GRTD6MTPV	72 x 42 x 1.19	107	8	\$2614	N/A	N/A	\$256



Rectangular Tops

Tops feature metal inserts for ease of assembly to base. One dual column base (**GDCB36H28**) required. Limited cut-out options available for power modules, include E2 or FOG2 only. Power modules corresponding to applicable cut-out codes ordered separately.

RACETRACK TOPS FOR DUAL COLUMN BASE

MODEL #	DIMENSIONS	WT/LB.	CUBIC FT.	LIST PRICE	HP ADD	R3 ADD	KS ADD
Thermally fused laminate, flat edge ⁽¹⁾							
GRCD5TP	60 x 36 x 1	60	6.6	\$483	\$195	N/A	N/A
GRCD5HTP	66 x 36 x 1	69	7.21	\$488	\$199	N/A	N/A
GRCD6TP	72 x 36 x 1	75	7.82	\$488	\$199	N/A	N/A
GRCD5MTP	60 x 42 x 1	73	7.62	\$633	\$273	N/A	N/A
GRCD5HMTP	66 x 42 x 1	81	8.32	\$675	\$294	N/A	N/A
GRCD6MTP	72 x 42 x 1	89	9.02	\$694	\$300	N/A	N/A
High pressure laminate, knife edge							
GRCD5TPLK	60 x 36 x 1.19	72	6	\$1995	N/A	N/A	N/A
GRCD5HTPLK	66 x 36 x 1.19	83	6.5	\$2123	N/A	N/A	N/A
GRCD6TPLK	72 x 36 x 1.19	90	7	\$2251	N/A	N/A	N/A
GRCD5MTPLK	60 x 42 x 1.19	88	7	\$2379	N/A	N/A	N/A
GRCD5HMTPK	66 x 42 x 1.19	97	7.5	\$2507	N/A	N/A	N/A
GRCD6MTPLK	72 x 42 x 1.19	107	8	\$2635	N/A	N/A	N/A
Veneer ⁽²⁾							
GRCD5TPV	60 x 36 x 1.19	72	6	\$2379	N/A	N/A	\$230
GRCD5HTPV	66 x 36 x 1.19	83	6.5	\$2507	N/A	N/A	\$241
GRCD6TPV	72 x 36 x 1.19	90	7	\$2635	N/A	N/A	\$256
GRCD5MTPV	60 x 42 x 1.19	88	7	\$2762	N/A	N/A	\$271
GRCD5HMTPV	66 x 42 x 1.19	97	7.5	\$2891	N/A	N/A	\$282
GRCD6MTPV	72 x 42 x 1.19	107	8	\$3018	N/A	N/A	\$292

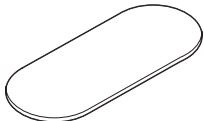

Racetrack Tops

Tops feature metal inserts for ease of assembly to base. One dual column base (**GDCB36H28**) required. Limited cut-out options available for power modules, include E2 or FOG2 only. Power modules corresponding to applicable cut-out codes ordered separately.

Required specifications	Optional specifications	Applicable bases	Accessories
Top finish Edge finish ⁽¹⁾	HP laminate ⁽¹⁾ Knife edge ⁽²⁾ 3" radiused corners ⁽⁴⁾ Grommet position or power block cut-out	GDCB36H28	Power block

BOAT SHAPE TOPS FOR DUAL COLUMN BASE

MODEL #	DIMENSIONS	WT/LB.	CUBIC FT.	LIST PRICE	HP ADD	KS ADD
---------	------------	--------	-----------	------------	--------	--------

W x D x H

Thermally fused laminate, flat edge ⁽¹⁾

GBTD5TP	60 x 36 x 1	60	6.6	\$483	\$195	N/A
GBTD5HTP	66 x 36 x 1	69	7.21	\$488	\$199	N/A
GBTD6TP	72 x 36 x 1	75	7.82	\$488	\$199	N/A
GBTD5MTP	60 x 42 x 1	73	7.62	\$633	\$273	N/A
GBTD5HMTP	66 x 42 x 1	81	8.32	\$675	\$294	N/A
GBTD6MTP	72 x 42 x 1	89	9.02	\$694	\$300	N/A

High pressure laminate, knife edge

GBTD5TPLK	60 x 36 x 1.19	72	6	\$1995	N/A	N/A
GBTD5HTPLK	66 x 36 x 1.19	83	6.5	\$2123	N/A	N/A
GBTD6TPLK	72 x 36 x 1.19	90	7	\$2251	N/A	N/A
GBTD5MTPLK	60 x 42 x 1.19	88	7	\$2379	N/A	N/A
GBTD5HMTPLK	66 x 42 x 1.19	97	7.5	\$2507	N/A	N/A
GBTD6MTPLK	72 x 42 x 1.19	107	8	\$2635	N/A	N/A

Veneer ⁽²⁾

GBTD5TPV	60 x 36 x 1.19	72	6	\$2379	N/A	\$230
GBTD5HTPV	66 x 36 x 1.19	83	6.5	\$2507	N/A	\$241
GBTD6TPV	72 x 36 x 1.19	90	7	\$2635	N/A	\$256
GBTD5MTPV	60 x 42 x 1.19	88	7	\$2762	N/A	\$271
GBTD5HMTPV	66 x 42 x 1.19	97	7.5	\$2891	N/A	\$282
GBTD6MTPV	72 x 42 x 1.19	107	8	\$3018	N/A	\$292

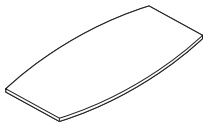

Boat Shape Tops

Tops feature metal inserts for ease of assembly to base. One dual column base (**GDCB36H28**) required.

Limited cut-out options available for power modules, include E2 or FOG2 only. Power modules corresponding to applicable cut-out codes ordered separately.

- GBTDxTP/GBTDxHTP: 36"D at center and 28"D at ends
- GBTDxMTP/GBTDxHMTP: 42"D at center and 33"D at ends.

DUAL COLUMN BASE FOR GxTDxxx TOPS

MODEL #	DIMENSIONS	WT/LB.	CUBIC FT.	LIST PRICE	BCH / CHM	ACO / SBR
---------	------------	--------	-----------	------------	-----------	-----------

W x D x H

BASE VALID FOR TOPS ON PAGES 347-348:

GDCB36H28	19 x 36 x 28	116.23	12.16	\$2103	\$582	\$768
-----------	--------------	--------	-------	---------------	--------------	--------------

seated height

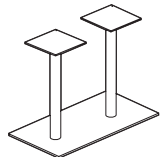

28"H Dual Column Base

Base ships knocked-down; assembly required. Features 0.5" adjustable glides to level on uneven surfaces. Screws included with base for attaching to appropriate top(s). Available in paint and plated finishes as listed on page 323. Upcharge applies on plated finishes.

Required specifications

Top finish
Edge finish ⁽¹⁾
Base finish

Optional specifications

HP laminate ⁽¹⁾
Knife edge ⁽²⁾
Grommet position or power block cut-out
Base plated finish

Applicable bases

GDCB36H28

Accessories

Power block

HUDDLE TABLES OVERVIEW

Bring teams together to huddle, share and collaborate.

Three heights available - seated desk height: 29", counter height: 36", bar height: 41.5" with D top, wedge, rectangular or soft ellipse shaped tops.

Laminate kits (consisting of laminate top and U-base) are sold separately from metal bases for huddle tables. Tops include metal inserts for ease of assembly to metal base. All tops are standard with an edge scoop to help manage cables from wall mounted flat screen monitors and/or edge mounting power module (PS305057/PS305002 as an example). Support channels are included with tops over 60" wide.

Metal bases ship fully assembled and include 0.5" adjustable glides and metal screws for attaching to the top. Be sure to specify bases specific to huddle tables GRHB22Hxx or GSB19Hxx.

D-TOP HUDDLE TABLES

MODEL #	DIMENSIONS	WT/LB.	CUBIC FT.	LIST PRICE	HP ADD
W x D x H					
GDH364829	36 x 48 x 29	77.05	3.94	\$952	\$188
GDH366029	36 x 60 x 29	86.95	4.46	\$1162	\$188
GDH367229	36 x 72 x 29	97	4.99	\$1295	\$195
GDH426029	42 x 60 x 29	99.82	5.18	\$1301	\$273
GDH427229	42 x 72 x 29	111.5	5.79	\$1459	\$300
GDH428429	42 x 84 x 29	123.1	11.98	\$1616	\$477
GDH429629	42 x 96 x 29	134.74	13.31	\$1746	\$504
GDH486029	48 x 60 x 29	112.6	5.89	\$1453	\$374
GDH487229	48 x 72 x 29	126	6.58	\$1626	\$443
GDH488429	48 x 84 x 29	139.24	13.5	\$1738	\$469
GDH489629	48 x 96 x 29	152.56	15	\$1880	\$512

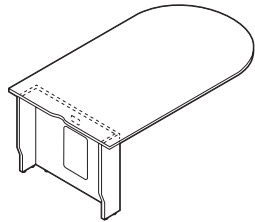

29"H D-Top Huddle

Laminate U-base support is 8"D with 7" inside clearance to wall. Access wall through 14.5"H x 9.5"W hinged door with touch latch in front panel of u-base support. U-base includes 0.5" adjustable glides. U-base side panels are tapered at the bottom to clear most baseboards. **Cut-out locations available in positions 1 or 2 only (except for model GDH364829 - cut-out position available in position 1 only).**

- Metal bases sold separately. Compatible with **GRHB22H28** or **GSHB19H28** only, requires one base.

GDH364836	36 x 48 x 36	85.95	4.31	\$980	\$188
GDH366036	36 x 60 x 36	95.85	4.84	\$1189	\$188
GDH367236	36 x 72 x 36	105.9	5.37	\$1323	\$195
GDH426036	42 x 60 x 36	109.82	5.61	\$1332	\$273
GDH427236	42 x 72 x 36	121.5	6.22	\$1491	\$300
GDH428436	42 x 84 x 36	133.1	12.4	\$1646	\$477
GDH429636	42 x 96 x 36	144.74	13.75	\$1777	\$504
GDH486036	48 x 60 x 36	123.6	6.38	\$1488	\$374
GDH487236	48 x 72 x 36	137	7.08	\$1661	\$443
GDH488436	48 x 84 x 36	150.24	14	\$1773	\$469
GDH489636	48 x 96 x 36	163.56	15.5	\$1916	\$512

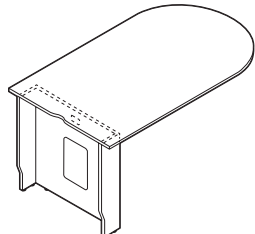

36"H D-Top Huddle

Laminate U-base support is 8"D with 7" inside clearance to wall. Access wall through 14.5"H x 9.5"W hinged door with touch latch in front panel of U-base support. U-base includes 0.5" adjustable glides. U-base side panels are tapered at the bottom to clear most baseboards. **Cut-out locations available in positions 1 or 2 only (except for model GDH364836 - cut-out position available in position 1 only).**

- Metal bases sold separately. Compatible with **GRHB22H35** or **GSHB19H35** only, requires one base.

Required Specifications

Top finish
Base finish

Optional Specifications

HP laminate
Grommet position or power block cut-out

Accessories

Power block

S SWAP™ TABLES

D-TOP HUDDLE TABLES

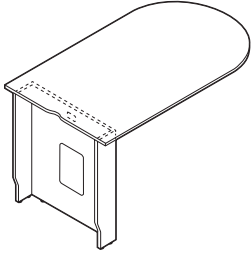

41.5"H D-Top Huddle

MODEL #	DIMENSIONS W x D x H	WT/LB.	CUBIC FT.	LIST PRICE	HP ADD
GDH364841	36 x 48 x 41.5	92.65	4.58	\$1032	\$188
GDH366041	36 x 60 x 41.5	102.55	5.11	\$1241	\$188
GDH367241	36 x 72 x 41.5	112.6	5.63	\$1375	\$195
GDH426041	42 x 60 x 41.5	117.32	5.92	\$1392	\$273
GDH427241	42 x 72 x 41.5	129	6.53	\$1549	\$300
GDH428441	42 x 84 x 41.5	140.6	12.72	\$1706	\$477
GDH429641	42 x 96 x 41.5	152.24	14.06	\$1837	\$504
GDH486041	48 x 60 x 41.5	130.1	6.74	\$1552	\$374
GDH487241	48 x 72 x 41.5	143.5	7.43	\$1726	\$443
GDH488441	48 x 84 x 41.5	156.74	14.53	\$1839	\$469
GDH489641	48 x 96 x 41.5	170.06	15.85	\$1980	\$512

Laminate U-base support is 8"D with 7" inside clearance to wall. Access wall through 14.5"H x 9.5"W hinged door with touch latch in front panel of U-base support. U-base includes 0.5" adjustable glides. U-base side panels are tapered at the bottom to clear most baseboards. **Cut-out locations available in positions 1 or 2 only (except for model GDH364841 - cut-out position available in position 1 only).**

- Metal bases sold separately. Compatible with **GRHB22H41** or **GSHB19H41** only, requires one base.

Required Specifications

Top finish
Base finish

Optional Specifications

HP laminate
Grommet position or power block cut-out

Accessories

Power block

WEDGE HUDDLE TABLES **MODEL #** **DIMENSIONS** **WT/LB.** **CUBIC FT.** **LIST PRICE** **HP ADD**

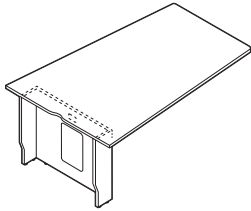

29"H Wedge Huddle

	W x D x H					
GWH486029	48 x 60 x 29	112.6	5.89	\$1448	\$374	
GWH487229	48 x 72 x 29	126	6.58	\$1626	\$443	
GWH488429	48 x 84 x 29	139.24	13.5	\$1738	\$469	
GWH489629	48 x 96 x 29	152.56	15	\$1880	\$512	

Laminate U-base support is 8"D with 7" inside clearance to wall. Access wall through 14.5"H x 9.5"W hinged door with touch latch in front panel of U-base support. U-base includes 0.5" adjustable glides. U-base side panels are tapered at the bottom to clear most baseboards. **Cut-out locations available in positions 1 or 2 only.**

- Metal bases sold separately. Compatible with **GRHB22H28** or **GSHB19H28** only, requires one base.

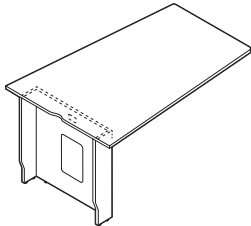

36"H Wedge Huddle

GWH486036	48 x 60 x 36	123.6	6.38	\$1483	\$374	
GWH487236	48 x 72 x 36	137	7.08	\$1661	\$443	
GWH488436	48 x 84 x 36	150.24	14	\$1773	\$469	
GWH489636	48 x 96 x 36	163.56	15.5	\$1916	\$512	

Laminate U-base support is 8"D with 7" inside clearance to wall. Access wall through 14.5"H x 9.5"W hinged door with touch latch in front panel of U-base support. U-base includes 0.5" adjustable glides. U-base side panels are tapered at the bottom to clear most baseboards. **Cut-out locations available in positions 1 or 2 only.**

- Metal bases sold separately. Compatible with **GRHB22H35** or **GSHB19H35** only, requires one base.

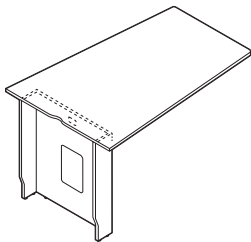

41.5"H Wedge Huddle

GWH486041	48 x 60 x 41.5	130.1	6.74	\$1548	\$374	
GWH487241	48 x 72 x 41.5	143.5	7.43	\$1726	\$443	
GWH488441	48 x 84 x 41.5	156.74	14.35	\$1839	\$469	
GWH489641	48 x 96 x 41.5	170.06	15.85	\$1980	\$512	

Laminate U-base support is 8"D with 7" inside clearance to wall. Access wall through 14.5"H x 9.5"W hinged door with touch latch in front panel of U-base support. U-base includes 0.5" adjustable glides. U-base side panels are tapered at the bottom to clear most baseboards. **Cut-out locations available in positions 1 or 2 only.**

- Metal bases sold separately. Compatible with **GRHB22H41** or **GSHB19H41** only, requires one base.

Required Specifications

Top finish
Base finish

Optional Specifications

HP laminate
Grommet position or power block cut-out

Accessories

Power block

S SWAP™ TABLES

RECTANGULAR HUDDLE TABLES

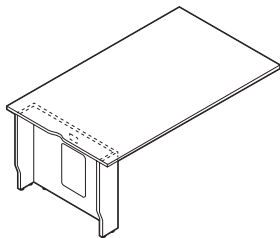

29"H Rectangular Huddle

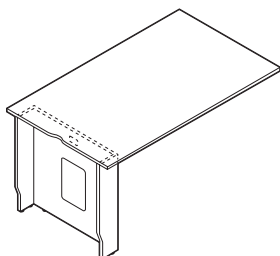

36"H Rectangular Huddle

MODEL #	DIMENSIONS	WT/LB.	CUBIC FT.	LIST PRICE	HP ADD
W x D x H					
GRH364829	36 x 48 x 29	77.05	3.94	\$952	\$188
GRH366029	36 x 60 x 29	86.95	4.46	\$1161	\$188
GRH367229	36 x 72 x 29	97	4.99	\$1295	\$195
GRH426029	42 x 60 x 29	99.82	5.18	\$1301	\$273
GRH427229	42 x 72 x 29	111.5	5.79	\$1459	\$300
GRH428429	42 x 84 x 29	123.1	11.98	\$1616	\$477
GRH429629	42 x 96 x 29	134.74	13.31	\$1746	\$504
GRH486029	48 x 60 x 29	112.6	5.89	\$1453	\$374
GRH487229	48 x 72 x 29	126	6.58	\$1626	\$443
GRH488429	48 x 84 x 29	139.24	13.5	\$1738	\$469
GRH489629	48 x 96 x 29	152.56	15	\$1880	\$512

Laminate u-base support is 8"D with 7" inside clearance to wall. Access wall through 14.5"H x 9.5"W hinged door with touch latch in front panel of u-base support. U-base includes 0.5" adjustable glides. U-base side panels are tapered at the bottom to clear most baseboards. **Cut-out locations available in positions 1 or 2 only (except for model GRH364829 - cut-out position available in position 1 only).**

- Metal bases sold separately. Compatible with **GRHB22H28** or **GSHB19H28** only, requires one base.

GRH364836	36 x 48 x 36	85.95	4.31	\$980	\$188
GRH366036	36 x 60 x 36	95.85	4.84	\$1189	\$188
GRH367236	36 x 72 x 36	105.9	5.37	\$1323	\$195
GRH426036	42 x 60 x 36	109.82	5.61	\$1332	\$273
GRH427236	42 x 72 x 36	121.5	6.22	\$1491	\$300
GRH428436	42 x 84 x 36	133.1	12.41	\$1646	\$477
GRH429636	42 x 96 x 36	144.74	13.75	\$1777	\$504
GRH486036	48 x 60 x 36	123.6	6.38	\$1488	\$374
GRH487236	48 x 72 x 36	137	7.08	\$1661	\$443
GRH488436	48 x 84 x 36	150.24	14	\$1773	\$469
GRH489636	48 x 96 x 36	163.56	15.5	\$1916	\$512

Laminate u-base support is 8"D with 7" inside clearance to wall. Access wall through 14.5"H x 9.5"W hinged door with touch latch in front panel of u-base support. U-base includes 0.5" adjustable glides. U-base side panels are tapered at the bottom to clear most baseboards. **Cut-out locations available in positions 1 or 2 only (except for model GRH364836 - cut-out position available in position 1 only).**

- Metal bases sold separately. Compatible with **GRHB22H35** or **GSHB19H35** only, requires one base.

Required Specifications

Top finish
Base finish

Optional Specifications

HP laminate
Grommet position or power block cut-out

Accessories

Power block

RECTANGULAR HUDDLE TABLES MODEL # DIMENSIONS WT/LB. CUBIC FT. LIST PRICE HP ADD

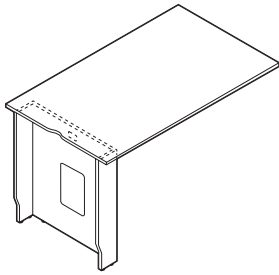

41.5"H Rectangular Huddle

	W x D x H				
GRH364841	36 x 48 x 41.5	92.65	4.58	\$1032	\$188
GRH366041	36 x 60 x 41.5	102.55	5.11	\$1241	\$188
GRH367241	36 x 72 x 41.5	112.6	5.63	\$1375	\$195
GRH426041	42 x 60 x 41.5	117.32	5.92	\$1392	\$374
GRH427241	42 x 72 x 41.5	129	6.53	\$1549	\$300
GRH428441	42 x 84 x 41.5	140.6	12.72	\$1706	\$477
GRH429641	42 x 96 x 41.5	152.24	14.06	\$1837	\$504
GRH486041	48 x 60 x 41.5	130.1	6.74	\$1552	\$374
GRH487241	48 x 72 x 41.5	143.5	7.43	\$1726	\$443
GRH488441	48 x 84 x 41.5	156.74	14.35	\$1839	\$469
GRH489641	48 x 96 x 41.5	170.06	15.85	\$1980	\$512

Laminate U-base support is 8"D with 7" inside clearance to wall. Access wall through 14.5"H x 9.5"W hinged door with touch latch in front panel of U-base support. U-base includes 0.5" adjustable glides. U-base side panels are tapered at the bottom to clear most baseboards. **Cut-out locations available in positions 1 or 2 only (except for model GRH364841 - cut-out position available in position 1 only).**

- Metal bases sold separately. Compatible with **GRHB22H41** or **GSHB19H41** only, requires one base.

Required Specifications

Top finish
Base finish

Optional Specifications

HP laminate
Grommet position or power block cut-out

Accessories

Power block

S SWAP™ TABLES

SOFT ELLIPSE HUDDLE TABLES

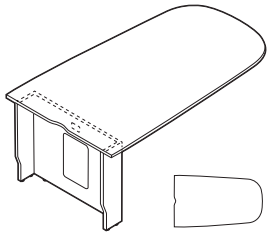

29"H Soft Ellipse Huddle

MODEL #	DIMENSIONS W x D x H	WT/LB.	CUBIC FT.	LIST PRICE	HP ADD
GSEH364829	36 x 48 x 29	77.05	3.94	\$952	\$188
GSEH366029	36 x 60 x 29	86.95	4.46	\$1161	\$188
GSEH367229	36 x 72 x 29	97	4.99	\$1295	\$195
GSEH426029	42 x 60 x 29	99.82	5.18	\$1301	\$273
GSEH427229	42 x 72 x 29	111.5	5.79	\$1459	\$300
GSEH428429	42 x 84 x 29	123.1	11.98	\$1616	\$477
GSEH429629	42 x 96 x 29	134.7	13.31	\$1746	\$504
GSEH486029	48 x 60 x 29	112.6	5.89	\$1453	\$374
GSEH487229	48 x 72 x 29	126	6.58	\$1626	\$443
GSEH488429	48 x 84 x 29	139.2	13.5	\$1738	\$469
GSEH489629	48 x 96 x 29	152.6	15	\$1880	\$512

Laminate u-base support is 8"D with 7" inside clearance to wall. Access wall through 14.5"H x 9.5"W hinged door with touch latch in front panel of u-base support. U-base includes 0.5" adjustable glides. U-base side panels are tapered at the bottom to clear most baseboards. **Cut-out locations available in positions 1 or 2 only (except for model GSEH364829 - cut-out position available in position 1 only).**

- Metal bases sold separately. Compatible with **GRHB22H28** or **GSHB19H28** only, requires one base.

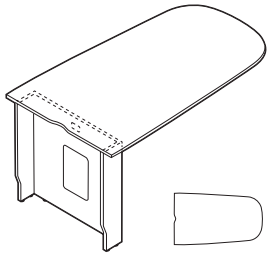

36"H Soft Ellipse Huddle

GSEH364836	36 x 48 x 36	86	4.31	\$980	\$188
GSEH366036	36 x 60 x 36	95.9	4.84	\$1189	\$188
GSEH367236	36 x 72 x 36	105.9	5.37	\$1323	\$195
GSEH426036	42 x 60 x 36	109.8	5.61	\$1332	\$273
GSEH427236	42 x 72 x 36	121.5	6.22	\$1491	\$300
GSEH428436	42 x 84 x 36	133.1	12.41	\$1646	\$477
GSEH429636	42 x 96 x 36	144.74	13.75	\$1777	\$504
GSEH486036	48 x 60 x 36	123.6	6.38	\$1488	\$374
GSEH487236	48 x 72 x 36	137	7.08	\$1661	\$443
GSEH488436	48 x 84 x 36	150.24	14	\$1773	\$469
GSEH489636	48 x 96 x 36	163.56	15.5	\$1916	\$512

Laminate u-base support is 8"D with 7" inside clearance to wall. Access wall through 14.5"H x 9.5"W hinged door with touch latch in front panel of u-base support. U-base includes 0.5" adjustable glides. U-base side panels are tapered at the bottom to clear most baseboards. **Cut-out locations available in positions 1 or 2 only (except for model GSEH364836 - cut-out position available in position 1 only).**

- Metal bases sold separately. Compatible with **GRHB22H35** or **GSHB19H35** only, requires one base.

Required Specifications

Top finish
Base finish

Optional Specifications

HP laminate
Grommet position or power block cut-out

Accessories

Power block

SOFT ELLIPSE HUDDLE TABLES

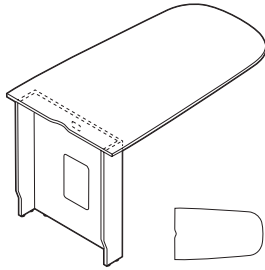

41.5"H Soft Ellipse Huddle

MODEL #	DIMENSIONS	WT/LB.	CUBIC FT.	LIST PRICE	HP ADD
W x D x H					
GSEH364841	36 x 48 x 41.5	92.65	4.58	\$1032	\$188
GSEH366041	36 x 60 x 41.5	102.55	5.11	\$1241	\$188
GSEH367241	36 x 72 x 41.5	112.6	5.63	\$1375	\$195
GSEH426041	42 x 60 x 41.5	117.32	5.92	\$1392	\$273
GSEH427241	42 x 72 x 41.5	129	6.53	\$1549	\$300
GSEH428441	42 x 84 x 41.5	140.6	12.72	\$1706	\$477
GSEH429641	42 x 96 x 41.5	152.24	14.06	\$1837	\$504
GSEH486041	48 x 60 x 41.5	130.1	6.74	\$1552	\$374
GSEH487241	48 x 72 x 41.5	143.5	7.43	\$1726	\$443
GSEH488441	48 x 84 x 41.5	156.74	14.35	\$1839	\$469
GSEH489641	48 x 96 x 41.5	170.06	15.85	\$1980	\$512

Laminate u-base support is 8"D with 7" inside clearance to wall. Access wall through 14.5"H x 9.5"W hinged door with touch latch in front panel of u-base support. U-base includes 0.5" adjustable glides. U-base side panels are tapered at the bottom to clear most baseboards. **Cut-out locations available in positions 1 or 2 only (except for model GSEH364841 - cut-out position available in position 1 only).**

- Metal bases sold separately. Compatible with **GRHB22H41** or **GSHB19H41** only, requires one base.

Required Specifications

Top finish
Base finish

Optional Specifications

HP laminate
Grommet position or power block cut-out

Accessories

Power block

HUDDLE BASES

MODEL # DIMENSIONS WT/LB. CUBIC FT. LIST PRICE HP ADD BCH / CHM ACO / SBR

W x D x H

SELECT BASE COMPATIBLE WITH TOP HEIGHT:

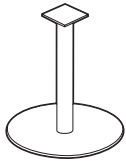

22" Round Huddle Base

GRHB22H28	22 x - x 28	60	10	\$898	N/A	\$147	\$249
GRHB22H35	22 x - x 35	62	12.7	\$933	N/A	\$164	\$268
GRHB22H41	22 x - x 40.5	63	14.2	\$949	N/A	\$171	\$270

GRHB22H35 - counter height

GRHB22H28 - seated height

GRHB22H41 - bar height

Metal base ships fully assembled. Features 0.5" adjustable glides to level on uneven surfaces. Screws included with base for attaching to appropriate huddle table laminate pieces. See page 323 for available finishes.

Be sure to double check huddle table laminate units and metal bases are the same corresponding heights.

- Plated finishes are available at an upcharge.

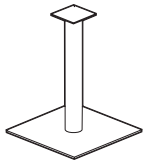

18.5" Square Huddle Base

GSHB19H28	18.5 x 18.5 x 28	55	6.94	\$966	N/A	\$136	\$250
GSHB19H35	18.5 x 18.5 x 35	57	8.8	\$1022	N/A	\$151	\$287
GSHB19H41	18.5 x 18.5 x 40.5	58	9.84	\$1056	N/A	\$166	\$287

GSHB19H35 - counter height

GSHB19H28 - seated height

GSHB19H41 - bar height

Metal base ships fully assembled. Features 0.5" adjustable glides to level on uneven surfaces. Screws included with base for attaching to appropriate huddle table laminate pieces. See page 323 for available finishes.

Be sure to double check huddle table laminate units and metal bases are the same corresponding heights.

- Plated finishes are available at an upcharge.

Required Specifications

Finish

Optional Specifications

tables training



2gether 358



Bungee/Bungee SL 361



ConnectTABLES 396



Duet 411



Edventure 414



Junction 424



Zook 431



2gether tables are multi-purpose flip-top tables that create dynamic spaces for people to easily connect and learn; ideal for collaborative, classroom, training and conference applications.

2gether tables feature an intuitive “easy touch” mechanism (located at both ends of the table) which allows the user to flip the tables up or down with ease.

2gether tables can be joined in rows for seminars, rearranged in groups to exchange ideas or set up in rows for training rooms. When they are no longer needed, they can be easily folded down and rolled away for compact storage.

2gether works great and looks great in any setting, any time.

Features and Benefits

- Flip-top tables.
- Worksurfaces feature 2mm edging in matching color.
- Tops and bases boxed as appropriate.
- Adjustable leveling casters provide smooth mobility.
- Bumpers prevent tables from being damaged while nested.
- Optional modesty panel with integrated wire trough available.
- Optional Black grommets for convenient wire management can be ordered “factory installed”.
- Easy to assemble.
- Available in three sizes: 18”D x 60”W, 24”D x 60”W and 24”D x 72”W
- 2gether table tops are available in a variety of Global laminate finishes.
- Champagne base finish.



Bumpers on legs and undercarriage provide protection while nested.



Offset “Y” leg allows for in line space saving when nested.

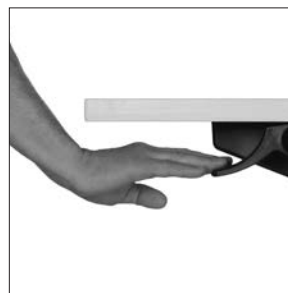

Easy touch lever releases mechanism for effortless movement of table surface.

GENERAL INFORMATION

- 2gether is a series of multi-purpose flip-top tables for collaborative, classroom, training and conference applications.
- Created by the designers of G20 seating.
- Off-set “Y” sculpted legs allow for parallel space saving table nesting, to minimize footprint required for storage.
- Optional modesty panels with integrated wire troughs are available.
- Grommets are available on 24” deep worksurfaces.
- Available in three sizes: 18”D x 60”W, 24”D x 60”W and 24”D x 72”W.
- Shipped easy to assemble. Each component is packaged individually; legs are shipped 1 per carton.
- Deliver power to the table top with individually corded modules or the ModPower daisy chain solution.
- For environmental certifications, please visit globalfurnituregroup.com.

WORKSURFACES

- 1” thick tops constructed of 45 lb. density particle board with high performance thermally fused laminate.

CONSTRUCTION

- “Easy touch” lever located at both sides of the table for flip-top operation from either side.
- 60” and 72” tops include a steel support channel for structural rigidity.
- All finishes feature Global’s preferred edging in matching color (i.e. woodgrain surfaces feature edging with matching printed woodgrain).
- Tops are predrilled with threaded steel inserts.
- 14.25” high optional articulating modesty panel attaches to underside of flip-top.
- Bumpers on legs and under carriage prevent tables from being damaged while nested.
- Champagne base finish.

FINISHES

ACJ Absolute Acajou	FCL First Class
ASN Asian Night	NBL Noce Biondo
AWC Avant Cherry	NGL Noce Grigio
AWH Avant Honey	NEL Noce Leggero
BLK Black	NML Noce Medio
BZD Blizzard	QTM Quartered Mahogany
BRC Brushed Cobalt	SBY Sheer Beauty
CMB Clear Maple	SDT Stonedust
CGY Custom Grey	SOG Storm Grey
DES Dark Espresso	WHE Walnut Heights
DWT Designer White	WHC White Chocolate
FAS Fashionista	WCR Winter Cherry

EDGE DETAIL

- 2mm matching edge is standard.

MODESTY PANEL

- Optional articulating modesty panel available. Champagne finish.

CASTERS

- Adjustable leveling casters and two locking casters (**BLK**) on Champagne finish legs are standard.

WIRE MANAGEMENT

- Standard with integrated trough underneath table.

GANGING CONNECTORS

- Ganging connectors (model **CNGFP**) are available for adjoining tables together, to be ordered separately.
- Tops include predrilled threaded inserts to accept ganging connectors.

SPECIFICATIONS

- Specifications marked with an * are applicable to only those products which have the * symbol beside the product name.

GROMMETS

- Grommets are optional on 24” deep tops only.
- Additional grommets available in standard worksurface locations (left, center or right). Order as: **FOG1, FOG2 or FOG3. Add \$91.**
E1, E2 or E3. Add \$91.
- Grommet hole dimensions are 3.25” wide x 1.875” deep.

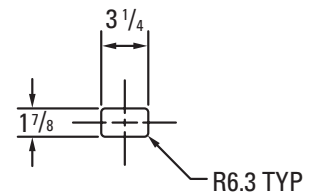

- Actual grommet locations on the worksurface are depicted in the example drawings shown above. Dimensions shown are actual measurements (in inches).

POWER BLOCK

- An individual corded power block (model **PMSPDM**) may be ordered for 24”D worksurfaces.
- A power block is a rectangular worksurface power/data module with one electrical duplex receptacle and two data (RJ45) receptacles. 9’ Black cord included. Power block dimensions are 6.5”W x 3.5”D x 2.75”H. Units cannot be daisy-chained.
- To purchase a power block, you must specify both the power block cut-out location and the power block model #. Order power block as **PMSPDM. Add \$268.** Power blocks are available in standard worksurface locations (left, center or right). Order as **E1, E2 or E3. Add \$91.**



Power block **PMSPDM. Add \$268.**

MODPOWER DAISY CHAIN SOLUTION

- Add flexible power and USB charging to 2gether tables. Connect up to four units with a single corded infeed with NEMA plug.
- ModPower units are sold separately, refer to Productivity Solutions page 473.
- Begin run with a starter unit which includes a corded infeed. Add additional middle or end units as required. Middle and end units are equipped with connecting cables.
- To be used with **rectangular tables IT2460RX and IT2472RX** only.
- On-surface modules clamp on or screw mount to the table tops.
- In-surface modules require table top cut-outs for mounting. Specify cut-out option:
 - **MPS** for a single cut-out to accommodate one ModPower in-surface unit (cut-out will be centered on the approach side). Add **\$91.**
 - **MPD** for two cut-outs in the left and right positions, 15” from ends to center of unit on approach side. Add **\$183.**

2 2GETHER™ TABLES

TABLES AND MODESTY PANELS

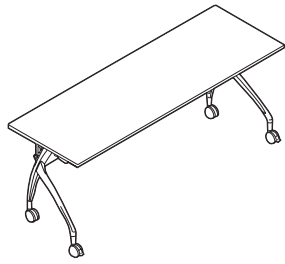

Flip-Top Rectangular Table*

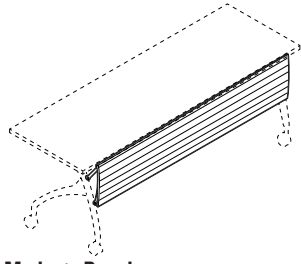

Modesty Panel

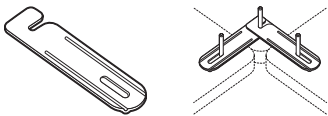

Ganging Connector

MODEL #	DIMENSIONS	WT/LB.	CUBIC FT.	LIST PRICE
---------	------------	--------	-----------	------------

W x D x H

IT1860RX	60 x 18 x 29	63.4	7	\$1552
IT2460RX	60 x 24 x 29	73.6	7.7	\$1584
IT2472RX	72 x 24 x 29	83.4	8.7	\$1766

Flip-top table on four adjustable leveling casters, two locking. Easy-touch lever located at both ends of the table allows for activation on either side of the table; offset Y leg accommodates in line nesting for space saving storage. Champagne finish leg. Black/dark grey casters. Optional articulating modesty panel available. Shipped easy to assemble in 3 cartons.

IT60MP	51 x 2.75 x 14.25	8.4	1.6	\$287
IT72MP	63 x 2.75 x 14.25	9.3	2	\$315

Articulating modesty panel for use with flip-top or fixed top 2gether tables. Champagne finish. Integrated wire management trough. Shipped easy to assemble in 1 carton.

CNGFP	2.5 x 5 x 1.13	0.2	0.1	\$33
-------	----------------	-----	-----	-------------

Black epoxy coated 13 gauge steel with two thumbscrews included. Used to connect table tops together for additional stability or for connecting freestanding tops together. Holes with steel inserts are located in the corner of all tops to accommodate this plate. **Sold individually.**

Required specifications

Top finish*

Optional specifications

Grommet* (24" deep only)
Power block cut-out* (24" deep only)

Accessories

Modesty panel*



Bungee is a series of freestanding tables and accessories designed for classrooms, training rooms, boardrooms and any other multi-functional space that may require frequent configurations. Tables are sold complete with legs and Bungee cords so they may quickly and easily be connected together without searching for tools or worrying about loose parts.

Bungee tables feature optional rounded corners with a unique Bubble molding that is engineered to compress under the tension of the Bungee cords. The compressed molding creates a seal that serves to locate and align interconnected tables while also providing a soft and forgiving edge. Four additional edge options are available.

Choose from a variety of top shapes and laminate finishes to create your individual style. In addition, most tables offer a choice of tapered legs or spider legs in a Black or Tungsten finish with adjustable levelers or optional casters. Optional modesty panels, grommets, wire management and power blocks further enhance your workspace.



Flip-top tables can be nested and easily stored by activating the single hand release mechanism from the left or right side.

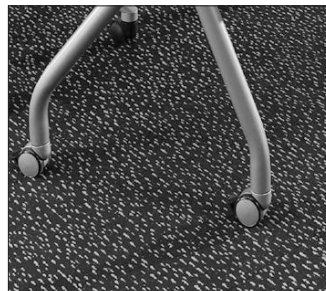

Optional locking casters are available in Black or Tungsten finish (standard on flip-top models).

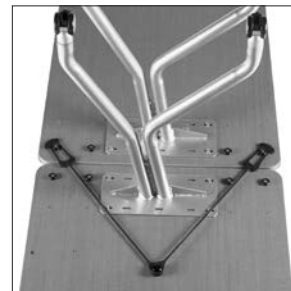

Bungee cords are utilized to quickly and easily reconfigure tables.

Features and Benefits

- Bungee tables are complete with top, legs and Bungee cords.
- Bungee cords provide a fast and easy method of reconfiguring tables without requiring tools.
- Tops are 1" thick and are offered in a variety of shapes and sizes.
- Legs are offered in tapered or spider design in a Black or Tungsten finish.
- Levelers on legs are standard.
- Laminate modesty panels and filler modesty inserts help conceal wires and enhance visual appeal.
- Wire management tracks neatly contain wires, using two separate channels for data and voice wires.
- Optional grommets or power blocks offer technological flexibility.
- Models with handles feature a bow handle in Silver or Black Nickel finish.
- Metal feet are height adjustable and offered in Black or Tungsten finish.
- Boardrooms were never easier to specify - table "sets" and accessories such as AV cabinets and credenza buffets are specified with one model number.

GENERAL INFORMATION

- Bungee is a series of freestanding tables and accessories designed for classrooms, training rooms, boardrooms and any other multifunctional space that requires frequent reconfigurations.
- Bungee tables come complete with a work top, a set of legs and built-in Bungee cord connectors.
- Bungee cords allow the movement and reconfiguration of tables without a risk of damage or losing loose parts.
- High pressure tops are available in all Bungee laminate finishes at an extended lead time - please see model # for pricing.
- Unique “bubble molding” edging is specially engineered to create a secure seal to align interconnected tables. Alternate edge options are also available.
- Bungee products have been tested and comply with all mechanical tests.
- For environmental certifications, please visit globalfurnituregroup.com.

CONSTRUCTION

- Tops are 1" thick. Modesty panels are 11/16" thick.
- All components are made of 45 lb. commercial density particle board, covered on both sides with high performance, thermally fused laminate.
- Tops 54" and over feature a built-in support bar.

BUNGEE CORDS

- Bungee cords are patented elastic devices designed to provide a rapid, no-tool method of attaching tables of the same depth.
- The elastic nature of cords allows two connected tables to be moved around without risk of damage to the table top or connecting hardware.
- Bungee cords are included with all freestanding tables and carry a Lifetime Warranty.

EDGE DETAIL

- Six edge details to choose from.
- Unique “bubble molding” is engineered to compress under the tension of the Bungee cords, creating a seal that serves to locate and align interconnected tables.
- Bubble molding finish matches surface laminate with Silver (**BS**) or Black (**BB**) accent trim.
- Split color flat edge top half matches surfaces laminate with Silver (**AS**) or Black (**AB**) bottom accent trim.
- For matching 2mm flat edge, specify (**A3**).
- For matching bicut edge, specify (**AR**).
- Cabinetry and accessories feature Global's preferred edging in matching color.

LEGS

- Tables feature two styles of legs - tapered leg and spider leg. Available in Black (**TBL**) or Tungsten (**TTU**) finish.
- Levelers are standard. Optional locking casters are available at no upcharge, specify Black (**TBC**) or Tungsten (**TTC**) finish.
(Casters must match base finish.) Adjust 3mm - 10mm in height.



tapered leg



spider leg

HANDLES

- Metal handles are standard on all drawers and doors. Handles are offered in two finishes: Silver (**HS**) or Black Nickel (**HT**), please specify.
- Handle finish will match leg finish.



bow handle, Silver finish
specify (**HS**)



bow handle, Black Nickel finish
specify (**HT**)

FEET

- Metal feet are standard on all cabinets. Feet adjust 0.75" in height.
- Feet are available in Black (**TBL**) or Tungsten (**TTU**) finish, please specify.



TBL - Black



TTU - Tungsten

MODESTY PANELS

- Panels are 13" high, recessed 0.75" from the back and inset 7" from the sides.
- Panels feature a built-in flexible wire pass-through.
- Available in all Bungee laminate finishes.

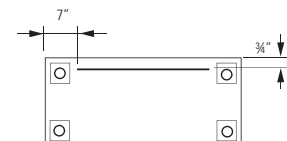
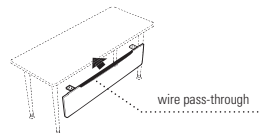

FILLER MODESTY PANELS

- Used to fill the space between two modesty panels when two tables are linked together. Helps conceal wires and enhance visual appeal.
- Available in Silver finish (**SI**) or Black finish (**BK**), please specify.

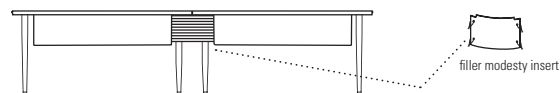

WIRE MANAGEMENT

- Wire management tracks are mounted to the underside of the worksurface. Available in 5" and 22" track lengths.
- 5" track includes one wire clamp; 22" track includes two wire clamps.
- Data and voice wires can be routed separately using two separate channels on each clamp.
- Available in Black only.

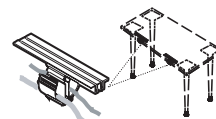

5" wire management track

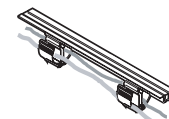

22" wire management track

1. SPECIFY MODEL NUMBER

2. SPECIFY FINISH

Laminate Finishes:

ACJ Absolute Acajou	FCL First Class
ASN Asian Night	NBL Noce Biondo
AWC Avant Cherry	NGL Noce Grigio
AWH Avant Honey	NEL Noce Leggero
BLK Black	NML Noce Medio
BZD Blizzard	QTM Quartered Mahogany
BRC Brushed Cobalt	SBY Sheer Beauty
CMB Clear Maple	SDT Stonedust
CGY Custom Grey	SOG Storm Grey
DES Dark Espresso	WHE Walnut Heights
DWT Designer White	WHC White Chocolate
FAS Fashionista	WCR Winter Cherry

Edge:

BB Bubble edge with Black trim
BS Bubble edge with Silver trim
AB Split color flat edge with Black trim
AS Split color flat edge with Silver trim
A3 Matching 2mm flat edge
AR Matching bicut edge

Legs:

TBL Black
TTU Tungsten

Casters:

TBC Black
TTC Tungsten

Handles:

HS Silver finish
HT Black finish

Modesty Panel Edge:

SI Silver
BK Black Nickel

Feet

TBL Black	TTU Tungsten
------------------	---------------------

3. SPECIFY OPTIONS

GROMMETS

- Optional grommets available in standard worksurface locations (left, center or right) for **rectangular tops** (48" wide and up). Order as: **FOG1, FOG2 or FOG3**. Add \$91.
- Optional grommets are available in **center position only** for **rectangular tops** (36" and 42" wide), **trapezoid tables** and **ALL flip-top and transformer tables**. Order as **FOG2**. Add \$91 per table.
- FOG2** when selected will apply to all 4 or 6 tables in transformer table kits accordingly.
- Grommet hole dimensions are 3.25" wide x 1.875" deep.
- Grommets may be placed at non-standard locations. Order as: **CSG**. Add \$132. A drawing must be supplied with vertical and horizontal dimensions to the center of the cut-out (as in drawing above). Please refer to the **custom grommet location form** in the back reference section.

Grommet hole dimensions

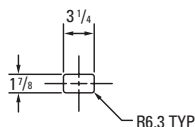

Grommet

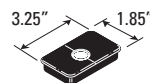

Rectangular Tops

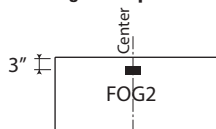

For 36", 42" and 48" wide units

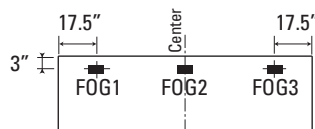

For 60" and 72" wide units

Trapezoid Tables and all Flip-Top Tables

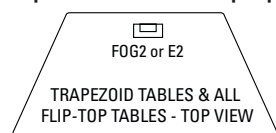

grommet location
FOG2. Add \$91.

Transformer Tables

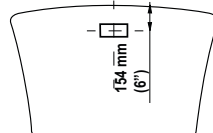

grommet location
FOG2. Add \$91 x number of tables in kit

POWER BLOCK

- An individual corded power block is a rectangular worksurface power/data module with one electrical duplex receptacle and two data (RJ45) receptacles. 9' Black cord included. Power block dimensions are 6.5"W x 3.5"D x 2.75"H. Power blocks are ordered separately. Units cannot be daisy-chained.
- A power block cut-out may be ordered for **rectangular tables** (60" wide and up) in left, center or right position. Order as **E1, E2 or E3**. Add \$91.
- A power block cut-out may be ordered for **rectangular tables** (36", 42" and 48" wide), **all trapezoid tables, flip-top and transformer tables** as an option in center position only, order as **E2**. Add \$91 per table.
- E2** when selected will apply to all 4 or 6 tables in transformer table kit accordingly.
- Power block(s) ordered separately, specify model **PMSPDM**. Add \$268 each.
- See left example for placement.

Rectangular Tops



For 36", 42" and 48" wide units



For 60" and 72" wide units

Transformer Tables

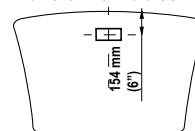

cut-out location



Power block **PMSPDM**. Add \$268.

MODPOWER DAISY-CHAIN SOLUTION

- Add flexible power and USB charging to Bungee **rectangular tables**. Connect up to four units with a single corded infeed with NEMA plug.
- ModPower units are sold separately, refer to Productivity Solutions page 473.
- Begin run with a starter unit which includes a corded infeed. Add additional middle or end units as required. Middle and end units are equipped with connecting cables.
- On-surface modules clamp on or screw mount to the table tops.
- In-surface modules require table top cut-outs for mounting. Specify cut-out option:
 - MPS** for a single cut-out to accommodate one ModPower in-surface unit (cut-out will be centered on the approach side) for **42" to 72" wide fixed top** rectangular tables and **48" to 72" wide flip-top** rectangular tables. Add \$91. Note: MPS not available for 36" wide fixed top tables or 42" wide flip-top tables.
 - MPD** for two cut-outs in the left and right positions, 18.25" from ends to center of unit on approach side for **60", 66" and 72" wide rectangular tables**. Add \$183.

SPECIFICATIONS

- Specifications marked with an * are applicable to only those products which have the * symbol beside the product name.

B BUNGEE™ TABLES - NOTES

CONNECTING CONDITIONS

- Bungee cords allow for fast and easy reconfiguring of tables whenever needed. Due to the elastic nature of the Bungee cord, two tables connected with Bungee cords can be moved around without risk of damage to the table top or the connecting hardware.
- Connecting tables is simple and intuitive. Tools are not required and there are no loose parts that may be misplaced.
- Bungee cords connect tables of the same depth in all directions.
- Rectangular tables 48" and longer connect in both straight and "L" configurations. Rectangular tables 36" and 42" connect in straight configurations only.

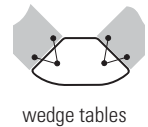
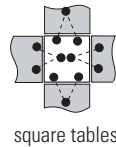
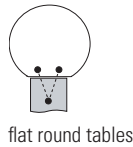
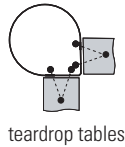
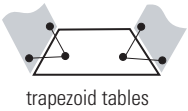
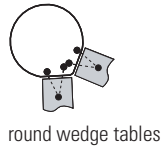
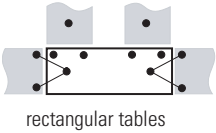
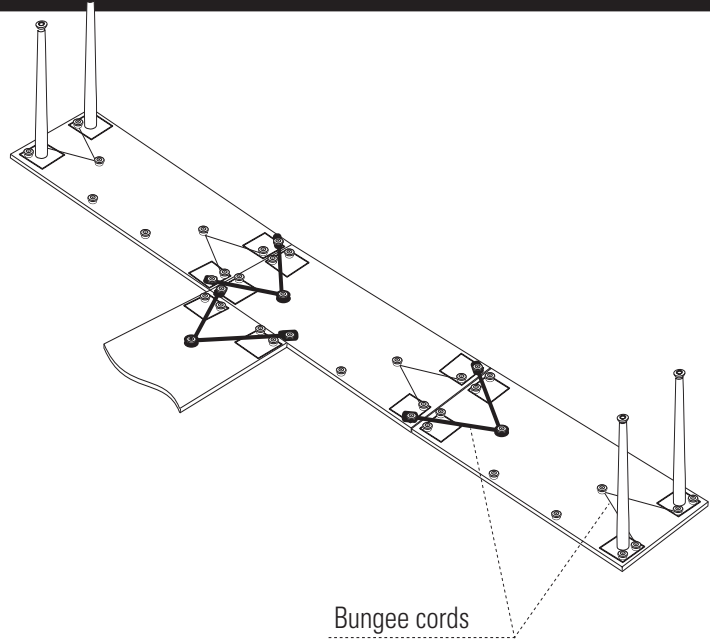

SAMPLE TABLE CONFIGURATIONS

- The following table configurations can be created using Bungee boardroom table sets only. See pages 372-373 for specific models / configurations.

meeting/boardroom table



meeting/boardroom table



training



lecture/
AV presentations

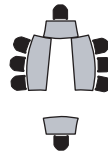

small
teaming stations



large
teaming stations



meeting/boardroom table

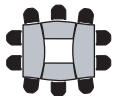

training

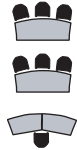

FLIP-TOP TABLE NESTING DIAGRAM

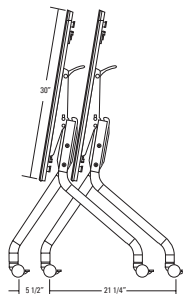
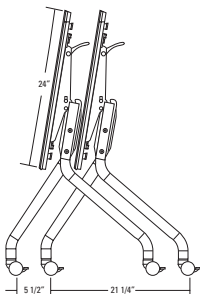

RECTANGULAR TABLES

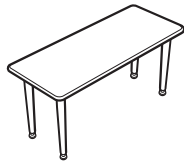
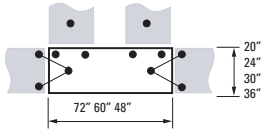
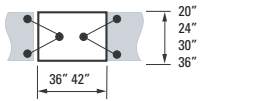

Rectangular Table - Tapered Legs

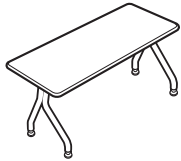
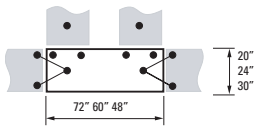
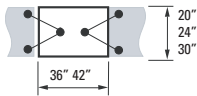

Rectangular Table - Spider Legs

MODEL #	DIMENSIONS	WT/LB.	CUBIC FT.	LIST PRICE	HP ADD
W x D x H					
B2036REF	36 x 20 x 28.7	59	5.25	\$717	\$169
B2042REF	42 x 20 x 28.7	62	5.75	\$740	\$226
B2048REF	48 x 20 x 28.7	67	6	\$773	\$226
B2060REF	60 x 20 x 28.7	74	7	\$881	\$310
B2072REF	72 x 20 x 28.7	81	7.25	\$965	\$352
B2436REF	36 x 24 x 28.7	65	5.75	\$762	\$169
B2442REF	42 x 24 x 28.7	69	6	\$789	\$226
B2448REF	48 x 24 x 28.7	72	6.5	\$813	\$226
B2460REF	60 x 24 x 28.7	82	7.25	\$938	\$339
B2472REF	72 x 24 x 28.7	91	8	\$1020	\$527
B3036REF	36 x 30 x 28.7	70	7.25	\$757	\$317
B3042REF	42 x 30 x 28.7	78	7.5	\$789	\$352
B3048REF	48 x 30 x 28.7	81	7.5	\$813	\$386
B3060REF	60 x 30 x 28.7	92	8.25	\$938	\$386
B3072REF	72 x 30 x 28.7	102	9	\$1033	\$527
B3642REF	42 x 36 x 28.7	83	7.5	\$870	\$339
B3648REF	48 x 36 x 28.7	91	8	\$952	\$352
B3660REF	60 x 36 x 28.7	103	9	\$1033	\$386
B3672REF	72 x 36 x 28.7	116	10	\$1159	\$527

Freestanding table includes four tapered legs with levelers and Bungee cords. When **(BB)** or **(BS)** edge option is specified, surface corners are radiused; when **(AS)**, **(AB)**, **(A3)** or **(AR)** edge option is specified, surface corners are square. Each table can be "Bungee-tied" to other tables of the same depth. Shipped easy to assemble in 2 cartons. Modesty panels available, see page 370.

- Tables 48" and longer connect in both straight and "L" configurations.
- Tables 36" and 42" connect in straight configurations only.
- Available with optional locking casters, specify Black (TBC) or Tungsten (TTC).

B2036RES	36 x 20 x 28.7	57	6.75	\$813	\$169
B2042RES	42 x 20 x 28.7	60	7.25	\$837	\$226
B2048RES	48 x 20 x 28.7	65	7.5	\$870	\$226
B2060RES	60 x 20 x 28.7	72	8.5	\$975	\$310
B2072RES	72 x 20 x 28.7	79	8.75	\$1063	\$352
B2436RES	36 x 24 x 28.7	62	7.25	\$857	\$169
B2442RES	42 x 24 x 28.7	67	7.5	\$881	\$226
B2448RES	48 x 24 x 28.7	71	10	\$912	\$226
B2460RES	60 x 24 x 28.7	80	10.75	\$1033	\$339
B2472RES	72 x 24 x 28.7	89	11.25	\$1119	\$527
B3036RES	36 x 30 x 28.7	72	10.25	\$881	\$317
B3042RES	42 x 30 x 28.7	80	10.5	\$909	\$352
B3048RES	48 x 30 x 28.7	83	10.5	\$938	\$386
B3060RES	60 x 30 x 28.7	94	11.25	\$1063	\$386
B3072RES	72 x 30 x 28.7	104	12	\$1144	\$528

Freestanding table includes two spider legs with levelers and Bungee cords. When **(BB)** or **(BS)** edge option is specified, surface corners are radiused; when **(AS)**, **(AB)**, **(A3)** or **(AR)** edge option is specified, surface corners are square. Each table can be "Bungee-tied" to other tables of the same depth. Shipped easy to assemble in 2 cartons. Modesty panels available, see page 370.

- Tables 48" and longer connect in both straight and "L" configurations.
- Tables 36" and 42" connect in straight configurations only.
- Available with optional locking casters, specify Black (TBC) or Tungsten (TTC).

Required specifications

Top finish
Edge detail
Leg finish

Optional specifications

Casters
Grommet
Power block cut-out
HP laminate

Accessories

Power block

B BUNGEE™ TABLES

TRAPEZOID TABLES

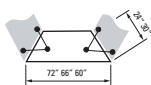

Trapezoid Table - Tapered Legs

MODEL #	DIMENSIONS W x D x H	WT/LB.	CUBIC FT.	LIST PRICE	HP ADD
B2460TRF	60 x 24 x 28.7	71	7.5	\$870	\$339
B2466TRF	66 x 24 x 28.7	74	8	\$881	\$527
B2472TRF	72 x 24 x 28.7	78	8.25	\$952	\$527
B3060TRF	60 x 30 x 28.7	78	8.5	\$926	\$386
B3066TRF	66 x 30 x 28.7	81	9.5	\$965	\$527
B3072TRF	72 x 30 x 28.7	85	9.5	\$1020	\$527

Freestanding table includes four tapered legs with levelers and Bungee cords. Bubble edge options (**BB**) or (**BS**) only apply (edge options (**AS**), (**AB**), (**A3**) and (**AR**) are not applicable on trapezoid tables). Each table can be "Bungee-tied" to other tables of the same depth. Shipped easy to assemble in 2 cartons. Modesty panels available, see pages 370-371.

- Available with optional locking casters, specify Black (**TBC**) or Tungsten (**TTC**).

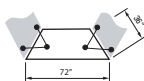
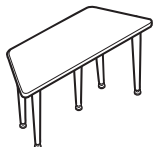

Trapezoid Table - Tapered Legs

B3672TRF	72 x 36 x 28.7	91	10.5	\$1185	N/A
----------	----------------	----	------	---------------	-----

Freestanding table includes five tapered legs with levelers and Bungee cords. Bubble edge options (**BB**) or (**BS**) only apply (edge options (**AS**), (**AB**), (**A3**) and (**AR**) are not applicable on trapezoid tables). Each table can be "Bungee-tied" to other tables of the same depth. Shipped easy to assemble in 2 cartons. Modesty panels available, see pages 370-371.

- Available with optional locking casters, specify Black (**TBC**) or Tungsten (**TTC**).

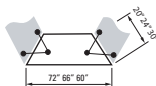

Trapezoid Table - Spider Legs

B2060TRS	60 x 20 x 28.7	67	8.75	\$938	\$310
B2066TRS	66 x 20 x 28.7	68	9	\$965	\$352
B2072TRS	72 x 20 x 28.7	74	9.25	\$1005	\$352
B2460TRS	60 x 24 x 28.7	69	9.25	\$965	\$339
B2466TRS	66 x 24 x 28.7	72	9.75	\$1005	\$527
B2472TRS	72 x 24 x 28.7	76	10	\$1047	\$527
B3060TRS	60 x 30 x 28.7	79	11.5	\$1038	\$386
B3066TRS	66 x 30 x 28.7	83	12.5	\$1078	\$527
B3072TRS	72 x 30 x 28.7	87	12.5	\$1134	\$527

Freestanding table includes two spider legs with levelers and Bungee cords. Bubble edge options (**BB**) or (**BS**) only apply (edge options (**AS**), (**AB**), (**A3**) and (**AR**) are not applicable on trapezoid tables). Each table can be "Bungee-tied" to other tables of the same depth. Shipped easy to assemble in 2 cartons. Modesty panels available, see pages 370-371.

- Available with optional locking casters, specify Black (**TBC**) or Tungsten (**TTC**).

KEYSTONE TABLES

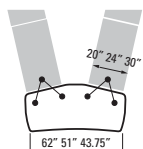
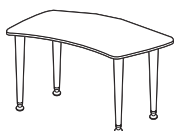

Keystone Table - Tapered Legs

B30KSF	62 x 30 x 28.7	69	7.6	\$998	\$377
B24KSF	51 x 24 x 28.7	60	6.5	\$920	\$251
B20KSF	43.75 x 20 x 28.7	58	6.5	\$909	\$199

Freestanding table includes four tapered legs with levelers and Bungee cords. When (**BB**) or (**BS**) edge option is specified, surface corners are radiused; when (**AS**), (**AB**), (**A3**) or (**AR**) edge option is specified, surface corners are square. Each table can be "Bungee-tied" to other tables of 24" and 30" depth. Shipped easy to assemble in 2 cartons. Modesty panels or filler panels are NOT available.

Required specifications

Top finish
Edge detail
Leg finish

Optional specifications

Grommet (only trapezoid tables)
Casters (only trapezoid tables)
Power block cut-out (only trapezoid tables)
HP laminate

Accessories

Power block (only trapezoid tables)

KEYSTONE TABLES

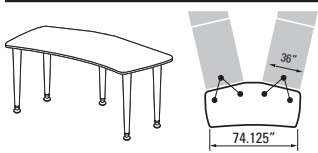

Keystone Table - Tapered Legs

MODEL #	DIMENSIONS W x D x H	WT/LB.	CUBIC FT.	LIST PRICE	HP ADD
B36KSF	74.13 x 36 x 28.7	84	8.4	\$1232	\$527

Freestanding table includes five tapered legs with levelers and Bungee cords. When **(BB)** or **(BS)** edge option is specified, surface corners are radiused; when **(AS)**, **(AB)**, **(A3)** or **(AR)** edge option is specified, surface corners are square. Each table can be "Bungee-tied" to other tables of 36" depth. Shipped easy to assemble in 2 cartons. Modesty panels or filler panels are NOT available.

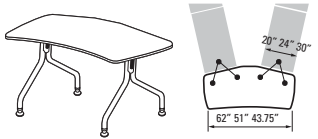

Keystone Table - Spider Legs

B30KSS	62 x 30 x 28.7	77	7.6	\$1164	\$377
B24KSS	51 x 24 x 28.7	66	6.5	\$1059	\$251
B20KSS	43.75 x 20 x 28.7	64	6.5	\$1059	\$199

Freestanding table includes two spider legs with levelers and Bungee cords. When **(BB)** or **(BS)** edge option is specified, surface corners are radiused; when **(AS)**, **(AB)**, **(A3)** or **(AR)** edge option is specified, surface corners are square. Each table can be "Bungee-tied" to other tables of 24" and 30" depth. Shipped easy to assemble in 2 cartons. Modesty panels or filler panels are NOT available.

WEDGE TABLES

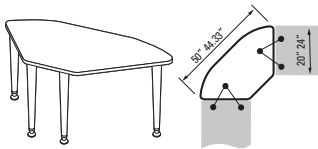

Wedge Table - Tapered Legs

B24WEF	63 x 24 x 28.7	54	6.6	\$957	\$251
B20WEF	57 x 20 x 28.7	46	5.1	\$881	\$199

Freestanding table includes four tapered legs with levelers and Bungee cords. When **(BB)** or **(BS)** edge option is specified, surface corners are radiused; when **(AS)**, **(AB)**, **(A3)** or **(AR)** edge option is specified, surface corners are square. Each table can be "Bungee-tied" to other tables of the same depth. Shipped easy to assemble in 2 cartons. Modesty panels available, see page 370.

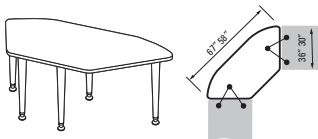

Wedge Table - Tapered Legs

B36WEF	80 x 36 x 28.7	84	9.4	\$1310	\$450
B30WEF	70 x 30 x 28.7	70	7.2	\$1164	\$312

Freestanding table includes five tapered legs with levelers and Bungee cords. When **(BB)** or **(BS)** edge option is specified, surface corners are radiused; when **(AS)**, **(AB)**, **(A3)** or **(AR)** edge option is specified, surface corners are square. Each table can be "Bungee-tied" to other tables of the same depth. Shipped easy to assemble in 2 cartons. Modesty panels available, see page 370.

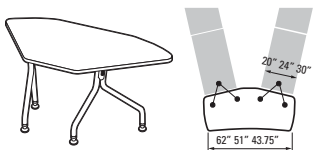

Wedge Table - Spider Legs

B30WES	70 x 30 x 28.7	73	7.2	\$1151	\$312
B24WES	63 x 24 x 28.7	62	6.6	\$1073	\$251
B20WES	57 x 20 x 28.7	52	5.1	\$998	\$199

Freestanding table includes two spider legs with levelers and Bungee cords. When **(BB)** or **(BS)** edge option is specified, surface corners are radiused; when **(AS)**, **(AB)**, **(A3)** or **(AR)** edge option is specified, surface corners are square. Each table can be "Bungee-tied" to other tables of the same depth. Shipped easy to assemble in 2 cartons. Modesty panels available, see page 370.

Required specifications

Top finish
Edge detail
Leg finish

Optional specifications

Casters (only half moon tables)
Grommet (only half moon tables)
HP laminate

Accessories

Power block (only position 2)

B BUNGEE™ TABLES

HALF MOON TABLES

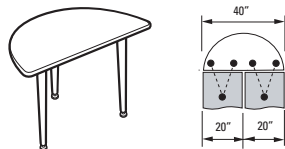

Half Moon Table - Tapered Legs

MODEL #	DIMENSIONS W x D x H	WT/LB.	CUBIC FT.	LIST PRICE	HP ADD
B2040HMF	40 x 20 x 28.7	49	6	\$567	\$226

Freestanding table includes three tapered legs with levelers and Bungee cords. When **(BB)** or **(BS)** edge option is specified, surface corners are radiused; when **(AS)**, **(AB)**, **(A3)** or **(AR)** edge option is specified, surface corners are square. Each table can be "Bungee-tied" to other tables of the same depth. Shipped easy to assemble in 2 cartons. Modesty panels or filler panels are NOT available.

- Available with optional locking casters, specify Black **(TBC)** or Tungsten **(TTC)**.

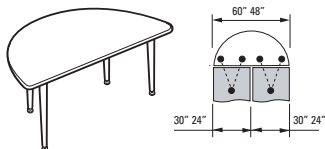

Half Moon Table - Tapered Legs

B2448HMF	48 x 24 x 28.7	110	7.75	\$740	\$226
B3060HMF	60 x 30 x 28.7	81	8.5	\$789	\$386

Freestanding table includes four tapered legs with levelers and Bungee cords. When **(BB)** or **(BS)** edge option is specified, surface corners are radiused; when **(AS)**, **(AB)**, **(A3)** or **(AR)** edge option is specified, surface corners are square. Each table can be "Bungee-tied" to other tables of the same depth. Shipped easy to assemble in 2 cartons. Modesty panels or filler panels are NOT available.

- Available with optional locking casters, specify Black **(TBC)** or Tungsten **(TTC)**.

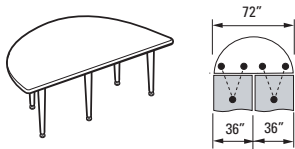

Half Moon Table - Tapered Legs

B3672HMF	72 x 36 x 28.7	110	11.5	\$1114	\$527
----------	----------------	-----	------	---------------	--------------

Freestanding table includes five tapered legs with levelers and Bungee cords. When **(BB)** or **(BS)** edge option is specified, surface corners are radiused; when **(AS)**, **(AB)**, **(A3)** or **(AR)** edge option is specified, surface corners are square. Each table can be "Bungee-tied" to other tables of the same depth. Shipped easy to assemble in 2 cartons. Modesty panels or filler panels are NOT available.

- Available with optional locking casters, specify Black **(TBC)** or Tungsten **(TTC)**.

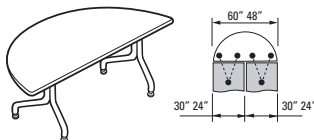

Half Moon Table - Spider Legs*

B2448HMS	48 x 24 x 28.7	67	9.25	\$844	\$226
B3060HMS	60 x 30 x 28.7	83	11.5	\$909	\$386

Freestanding table includes two spider legs with levelers and Bungee cords. When **(BB)** or **(BS)** edge option is specified, surface corners are radiused; when **(AS)**, **(AB)**, **(A3)** or **(AR)** edge option is specified, surface corners are square. Each table can be "Bungee-tied" to other tables of the same depth. Shipped easy to assemble in 2 cartons. Modesty panels or filler panels are NOT available.

- Available with optional locking casters, specify Black **(TBC)** or Tungsten **(TTC)**.

SQUARE TABLES

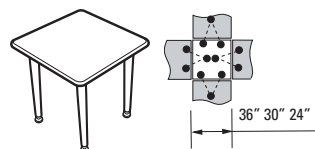

Square Table - Tapered Legs

B2424SQF	24 x 24 x 28.7	55	4.6	\$705	\$141
B3030SQF	30 x 30 x 28.7	65	7.5	\$717	\$209
B3636SQF	36 x 36 x 28.7	78	8	\$824	\$253

Freestanding table includes four tapered legs with levelers and Bungee cords. When **(BB)** or **(BS)** edge option is specified, surface corners are radiused; when **(AS)**, **(AB)**, **(A3)** or **(AR)** edge option is specified, surface corners are square. Each table can be "Bungee-tied" to other tables of the same depth. Shipped easy to assemble in 2 cartons. Note: Square tables will NOT accept laminate modesty panels.

- Available with optional locking casters, specify (Black **(TBC)** or Tungsten **(TTC)**).

Required specifications

Top finish
Edge detail
Leg finish

Optional specifications

Casters
HP laminate
Grommet*

ROUND WEDGE TABLES

MODEL # DIMENSIONS WT/LB. CUBIC FT. LIST PRICE HP ADD

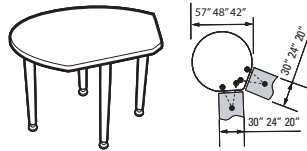

Round Wedge 120° Table

	W x D x H					
B2042RWF	42	20	28.7	76	8.25	\$789 \$494
B2448RWF	48	24	28.7	85	10.75	\$813 \$494
B3057RWF	57	30	28.7	102	12	\$965 \$703

Freestanding table includes four tapered legs with levelers and Bungee cords. Bubble edge options **(BB)** or **(BS)** only apply (edge options **(AS)**, **(AB)**, **(A3)** and **(AR)** are not applicable on round wedge tables). Each table can be "Bungee-tied" to other tables of the same depth. Shipped easy to assemble in 2 cartons. Modesty panels or filler panels are NOT available.

- Available with optional locking casters, specify Black **(TBC)** or Tungsten **(TTC)**.

TEARDROP TABLES

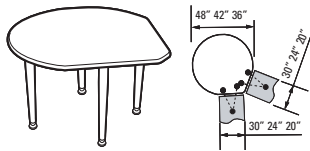

Teardrop 90° Table

B2036TDF	36	20	28.7	71	8	\$740 \$317
B2442TDF	42	24	28.7	81	8.5	\$813 \$494
B3048TDF	48	30	28.7	91	11	\$891 \$459

Freestanding table includes four tapered legs with levelers and Bungee cords. Bubble edge options **(BB)** or **(BS)** only apply (edge options **(AS)**, **(AB)**, **(A3)** and **(AR)** are not applicable on teardrop tables). Each table can be "Bungee-tied" to other tables of the same depth. Shipped easy to assemble in 2 cartons. Filler modesty panels available, see page 371.

- Available with optional locking casters, specify Black **(TBC)** or Tungsten **(TTC)**.

FLAT ROUND TABLES

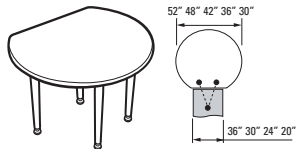

Flat Round Table

B2030FRF	30	20	28.7	56	6	\$717 \$283
B2036FRF	36	20	28.7	66	7.25	\$717 \$317
B2436FRF	36	24	28.7	64	7.25	\$717 \$317
B2442FRF	42	24	28.7	76	8.25	\$857 \$494
B3042FRF	42	30	28.7	74	8	\$857 \$494
B3048FRF	48	30	28.7	88	11	\$857 \$494
B3648FRF	48	36	28.7	85	11	\$952 N/A
B3652FRF	52	36	28.7	93	11	\$952 N/A

Freestanding table includes four tapered legs with levelers and Bungee cords. Bubble edge options **(BB)** or **(BS)** only apply (edge options **(AS)**, **(AB)**, **(A3)** and **(AR)** are not applicable on flat round tables). Each table can be "Bungee-tied" to other tables of the same depth. Shipped easy to assemble in 2 cartons. Modesty panels or filler panels are NOT available.

- Available with optional locking casters, specify Black **(TBC)** or Tungsten **(TTC)**.

Required specifications

op finish
Edge detail
Leg finish

Optional specifications

Casters
HP laminate

B BUNGEE™ TABLES

MODESTY PANELS - SQUARE

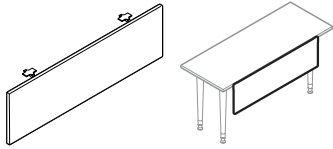

Modesty Panel - Square

MODEL #	DIMENSIONS W x D x H	WT/LB.	CUBIC FT.	LIST PRICE	HP ADD
BX36QMP	21 x 0.69 x 9.6	6	0.9	\$97	N/A
BX42QMP	27 x 0.69 x 9.6	7	1.1	\$101	N/A
BX48QMP	33 x 0.69 x 9.6	9	1.2	\$109	N/A
BX60QMP	45 x 0.69 x 9.6	12	1.6	\$117	N/A
BX66QMP	51 x 0.69 x 9.6	13	1.8	\$123	N/A
BX72QMP	57 x 0.69 x 9.6	14	2	\$127	N/A

For use on **rectangular** tables. Includes hinged mounting bracket.
Available in standard line finishes. Edging only available in Silver (**SI**) or Black (**BK**). Please specify.
• *Modesty panel model number indicates the width of table to be used on.*

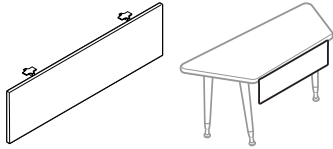

Modesty Panel - Square

BXM60QMP	27 x 0.69 x 9.6	7	1.1	\$101	N/A
BXM66QMP	33 x 0.69 x 9.6	9	1.2	\$109	N/A
BXM72QMP	39 x 0.69 x 9.6	10	1.4	\$113	N/A
BXL60QMP	21 x 0.69 x 9.6	6	0.9	\$98	N/A
BXL66QMP	27 x 0.69 x 9.6	7	1.1	\$101	N/A
BXL72QMP	33 x 0.69 x 9.6	9	1.2	\$109	N/A

For use on **trapezoid** tables. Includes hinged mounting bracket. Intended for use on the short side of the table; may be used on long side but leaves a larger gap.
Available in standard line finishes. Edging only available in Silver (**SI**) or Black (**BK**). Please specify.
• *Modesty panel model number indicates the width of table to be used on.*
• **Specify BXM models for 24" D tables and BXL models for 30" D tables.**

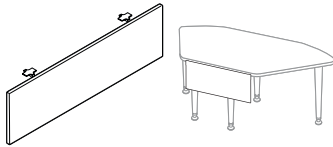

Modesty Panel - Square

BXWQMP	27 x 0.69 x 9.6	7	1.1	\$101	N/A
--------	-----------------	---	-----	--------------	-----

For use on **wedge** tables. Includes hinged mounting bracket. Intended for use on the short side of the table.
Available in standard line finishes. Edging only available in Silver (**SI**) or Black (**BK**). Please specify.

FILLER MODESTY PANELS

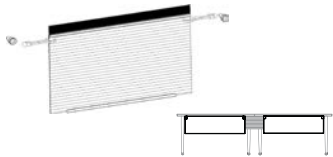

Filler Modesty Panel - Straight

BSFMS	21 x 0.25 x 9	1	0.3	\$98	N/A
-------	---------------	---	-----	-------------	-----

Used to fill the space between two **square** modesty panels where tables are linked in a straight configuration.
Available in Silver (**SI**) or Black (**BK**). Please specify.

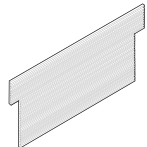

Filler Modesty Panel - Straight to Wedge

BSWFM	19.6 x 9 x 0.25	2	0.1	\$127	N/A
-------	-----------------	---	-----	--------------	-----

Used to fill the space between a straight modesty panel and wedge table.
Use for regular wedge table - tapered legs and flip-top wedge - spider legs.

Required specifications

Finish

FILLER MODESTY PANELS **MODEL #** **DIMENSIONS** **WT/LB.** **CUBIC FT.** **LIST PRICE**

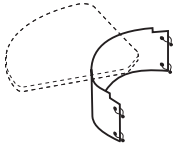

Filler Modesty Panel - Inside Curve

	W x D x H			
B23IFMS	23 x 0.06 x 9	3	1.5	\$127
B29IFMS	29 x 0.06 x 9	3	1.5	\$127
B30IFMS	30 x 0.06 x 9	3	1.5	\$127

Used to fill the space (inside curve) between two modesty panels where tables are linked at an angle or curve. Use for the inside curve of round wedge tables, teardrop tables or trapezoid tables.

- Use model **B23IFMS** for trapezoid tables inside curve only.
 - Use model **B29IFMS** for teardrop tables inside curve only.
 - Use model **B30IFMS** for round wedge tables inside curve only.
- Available in Silver (**SI**) or Black (**BK**). Please specify.

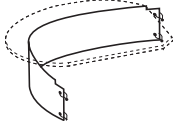

Filler Modesty Panel - Outside Curve

B56S	56 x 0.06 x 9	4	1.5	\$178
B62S	62 x 0.06 x 9	4	1.5	\$194
B71S	71 x 0.06 x 9	4	1.5	\$206

Used to fill the space (outside curve) between two modesty panels where tables are linked at an angle or curve. Use for teardrop tables only (**B2036TDF, B2442TDF and B3048TDF**).

- Use model **B56S** for **B2036TDF** teardrop tables outside curve only.
 - Use model **B62S** for **B2442TDF** teardrop tables outside curve only.
 - Use model **B71S** for **B3048TDF** teardrop tables outside curve only.
- Available in Silver (**SI**) or Black (**BK**). Please specify.

WIRE MANAGEMENT

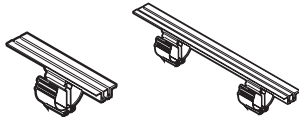

Wire Management - 5" / 22" Track

BWMS5	5 x 2 x 3.5	1	0.1	\$6
BWMD22	22 x 2 x 3.5	1.5	0.1	\$15

Retrofittable track mounts to the underside of worksurface. Includes wire clamp that can route data and voice wires separately. Black only. There are no specifications for Wire Management.

- For a 5" track, order model **BWMS5** - includes one wire clamp.
- For a 22" track, order model **BWMD22** - includes two wire clamps.

Required specifications
Finish (only modesty panels)

B BUNGEE™ TABLES

TRANSFORMER TABLES - 11 FT.

11 Foot Configurations

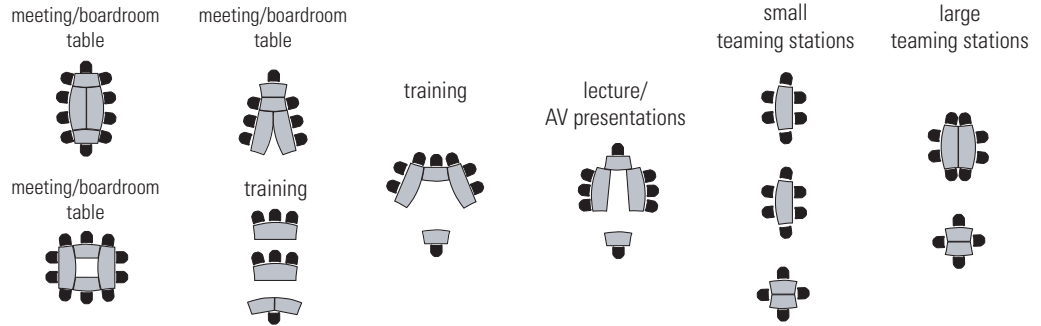

TRANSFORMER TABLES - 11 FT.

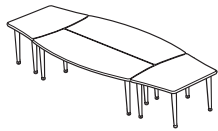

Transformer Table Set - 11 Foot*



Transformer Table Set - 11 Foot*

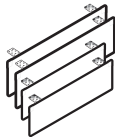

Square Modesty Panel Set For 11 Foot Transformer Table Set**

MODEL #	DIMENSIONS	WT/LB.	CUBIC FT.	LIST PRICE
---------	------------	--------	-----------	------------

W x D x H

BK132F	132 x 60 x 28.7	290	19.25	\$3499
--------	-----------------	-----	-------	---------------

Includes four freestanding tables. Each table includes **four tapered legs** with levelers and Bungee cords to be "Bungee-tied" together. Corners of all tops in the set are radiused for all edge options **(BB)**, **(BS)**, **(AB)**, **(AS)**, **(A3)** and **(AR)** due to geometry of the tables together. Shipped easy to assemble in 6 cartons. Modesty panel set available, order **BXK132QMP**.

- Available with optional locking casters, specify Black **(TBC)** or Tungsten **(TTC)**.

BK132S	132 x 60 x 28.7	290	22.25	\$3936
--------	-----------------	-----	-------	---------------

Includes four freestanding tables. Each table includes **two spider legs** with levelers and Bungee cords to be "Bungee-tied" together. Corners of all tops in the set are radiused for all edge options **(BB)**, **(BS)**, **(AB)**, **(AS)**, **(A3)** and **(AR)** due to geometry of the tables together. Shipped easy to assemble in 6 cartons. Modesty panel set available, order **BXK132QMP**.

- Available with optional locking casters, specify Black **(TBC)** or Tungsten **(TTC)**.

BXK132QMP	45 x 0.69 x 9.6	31	3.2	\$402
-----------	-----------------	----	-----	--------------

For use on **11 Foot Transformer Table Set**. Includes mounting bracket and wire access sweep. Available in standard line finishes. Edging only available in Silver **(SI)** or Black **(BK)**. Please specify.

Required specifications

Top finish*	Edge detail*
Leg finish*	
Modesty panel finish	
Edge finish**	

Optional specifications

Casters*
Grommet*
Power block cut-out*

Accessories

Power block*

TRANSFORMER TABLES - 13 AND 15 FT.

13/15 Foot Configurations

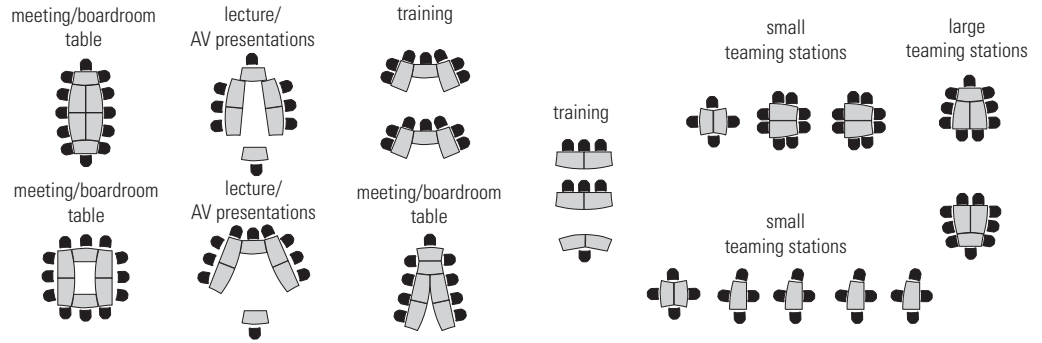

TRANSFORMER TABLES - 13 AND 15 FT.

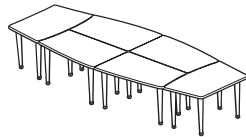

Transformer Table Set - 13 and 15 Foot*

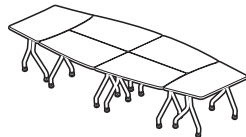

Transformer Table Set - 13 and 15 Foot*

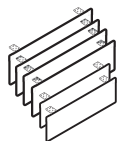

Square Modesty Panel Set for 13 and 15 Foot Transformer Table Sets**

MODEL #	DIMENSIONS W x D x H	WT/LB.	CUBIC FT.	LIST PRICE
BK156F	156 x 60 x 28.7	374	26.25	\$5154
BK180F	180 x 60 x 28.7	420	29.75	\$5622

Includes six freestanding tables. Each table includes **four tapered legs** with levelers and Bungee cords to be "Bungee-tied" together. Corners of all tops in the set are radiused for all edge options **(BB)**, **(BS)**, **(AB)**, **(AS)**, **(A3)** and **(AR)** due to geometry of the tables together. Shipped easy to assemble in 9 cartons.

Modesty panel set available, order **BXK156QMP/BXK180QMP**.

- Available with optional locking casters, specify Black **(TBC)** or Tungsten **(TTC)**.

BK156S	156 x 60 x 28.7	374	28.75	\$5327
BK180S	180 x 60 x 28.7	420	32.5	\$5772

Includes six freestanding tables. Each table includes **two spider legs** with levelers and Bungee cords to be "Bungee-tied" together. Corners of all tops in the set are radiused for all edge options **(BB)**, **(BS)**, **(AB)**, **(AS)**, **(A3)** and **(AR)** due to geometry of the tables together. Shipped easy to assemble in 9 cartons.

Modesty panel set available, order **BXK156QMP/BXK180QMP**.

- Available with optional locking casters, specify Black **(TBC)** or Tungsten **(TTC)**.

BXK156QMP	33 x 0.69 x 9.6	41	3.8	\$680
BXK180QMP	45 x 0.69 x 9.6	51	4.2	\$655

For use on **13 & 15 foot transformer table sets**. Includes mounting bracket and wire access sweep. Available in standard line finishes. Edging only available in Silver **(SI)** or Black **(BK)**. Please specify.

- Use model **BXK156QMP** for **BK156F/S** transformer table set.
- Use model **BXK180QMP** for **BK180F/S** transformer table set.

Required specifications

Top finish* Edge detail*
 Leg finish*
 Modesty panel finish
 Edge finish**

Optional specifications

Grommet*
 Casters*
 Power block cut-out*

Accessories

Power block*

B BUNGEE™ TABLES

SPIDER LEG TABLES - FLIP-TOP

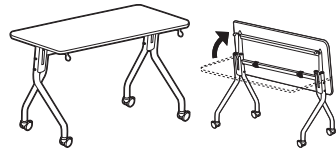
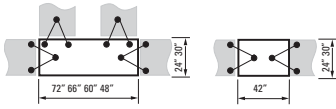

Flip-Top Rectangular Table - Spider Legs*

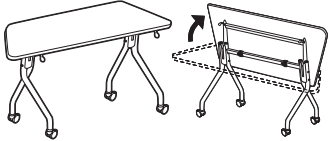
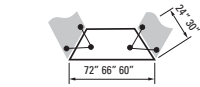

Flip-Top Trapezoid Table - Spider Legs*

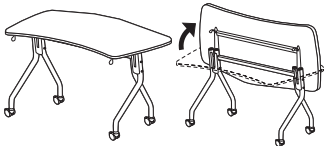

Flip-Top Keystone Table - Spider Legs

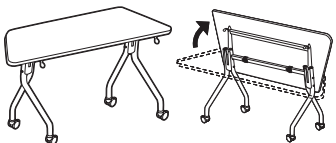

Flip-Top Wedge Table - Spider Legs*

MODEL #	DIMENSIONS W x D x H	WT/LB.	CUBIC FT.	LIST PRICE	HP ADD
BX2442RES	42 x 24 x 29.2	66	20.75	\$1407	\$199
BX2448RES	48 x 24 x 29.2	72	23.5	\$1423	\$199
BX2460RES	60 x 24 x 29.2	84	29	\$1443	\$251
BX2466RES	66 x 24 x 29.2	97	31.75	\$1462	\$299
BX2472RES	72 x 24 x 29.2	102	34.75	\$1497	\$299
BX3042RES	42 x 30 x 29.2	73	25.5	\$1412	\$251
BX3048RES	48 x 30 x 29.2	79	28.75	\$1431	\$251
BX3060RES	60 x 30 x 29.2	94	35.75	\$1462	\$312
BX3066RES	66 x 30 x 29.2	106	39.25	\$1482	\$377
BX3072RES	72 x 30 x 29.2	112	42.5	\$1516	\$377

Table features a flip-top worksurface for ease of storage. When **(BB)** or **(BS)** edge option is specified, surface corners are radiused; when **(AS)**, **(AB)**, **(A3)** or **(AR)** edge option is specified, surface corners are square. Single hand release mechanism can be activated from left or right side of the table. Tables can be nested when folded. Each table can be "Bungee-tied" to other tables of the same depth. Shipped in 1 carton. Folding modesty panels available, see page 375.

- **Tables 48" and longer connect in both straight and "L" configurations.**
- Standard with locking casters, specify Black **(TBC)** or Tungsten **(TTC)**.

BX2460TRS	60 x 24 x 29.2	69	29	\$1343	\$251
BX2466TRS	66 x 24 x 29.2	74	31.75	\$1360	\$299
BX2472TRS	72 x 24 x 29.2	80	34.75	\$1381	\$299
BX3060TRS	60 x 30 x 29.2	72	35.75	\$1356	\$312
BX3066TRS	66 x 30 x 29.2	78	39.25	\$1374	\$377
BX3072TRS	72 x 30 x 29.2	84	42.5	\$1392	\$377

Table features a flip-top worksurface for ease of storage. Bubble edge options **(BB)** or **(BS)** only apply (edge options **(AS)**, **(AB)**, **(A3)** and **(AR)** are not applicable on trapezoid tables). Single hand release mechanism can be activated from left or right side of the table. Tables can be nested when folded. Each table can be "Bungee-tied" to other tables of the same depth. Shipped in 1 carton. Folding modesty panels available, see page 375.

- Standard with locking casters, specify Black **(TBC)** or Tungsten **(TTC)**.

BX24KSS	51 x 24 x 29.2	69	24.75	\$1317	\$251
BX30KSS	62 x 30 x 29.2	79	36.75	\$1370	\$377

Table features a flip-top worksurface for ease of storage. When **(BB)** or **(BS)** edge option is specified, surface corners are radiused; when **(AS)**, **(AB)**, **(A3)** or **(AR)** edge option is specified, surface corners are square. Single hand release mechanism can be activated from left or right side of the table. Tables can be nested when folded. Each table can be "Bungee-tied" to other tables of the same depth. Shipped in 1 carton. Modesty panels or filler panels are NOT available.

- Standard with locking casters, specify Black **(TBC)** or Tungsten **(TTC)**.

BX24WES	63 x 24 x 29.2	76	33	\$1654	\$377
BX30WES	70 x 30 x 29.2	84	33	\$1680	\$377

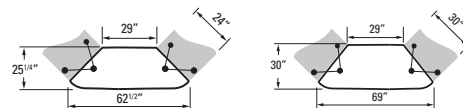

Table features a flip-top worksurface for ease of storage. When **(BB)** or **(BS)** edge option is specified, surface corners are radiused; when **(AS)**, **(AB)**, **(A3)** or **(AR)** edge option is specified, surface corners are square. Single hand release mechanism can be activated from left or right side of the table. Tables can be nested when folded. Each table can be "Bungee-tied" to other tables of the same depth. Shipped in 1 carton. Folding modesty panels available, see page 375.

- Standard with locking casters, specify Black **(TBC)** or Tungsten **(TTC)**.

Required specifications

Top finish*
Edge detail*
Leg finish*

Optional specifications

Grommet*
Power block cut-out*
HP laminate*

Accessories

Power block*

MODESTY PANELS - FLIP-TOP - SQUARE **MODEL #** **DIMENSIONS** **WT/LB.** **CUBIC FT.** **LIST PRICE** **HP ADD**

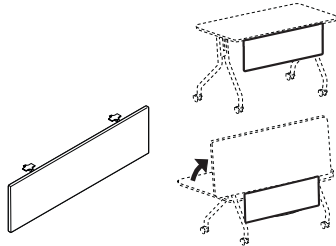

Modesty Panel - Square

	W x D x H				
BX36QMP	21 x 0.69 x 9.6	6	0.9	\$97	
BX42QMP	27 x 0.69 x 9.6	7	1.1	\$101	
BX48QMP	33 x 0.69 x 9.6	9	1.2	\$109	
BX60QMP	45 x 0.69 x 9.6	12	1.6	\$117	
BX66QMP	51 x 0.69 x 9.6	13	1.8	\$123	
BX72QMP	57 x 0.69 x 9.6	14	2	\$127	

For use on **flip-top rectangular tables**. Includes hinged mounting bracket. Available in standard line finishes. Edging only available in Silver (**SI**) or Black (**BK**). Please specify.

- Modesty panel model number indicates the width of table to be used on.

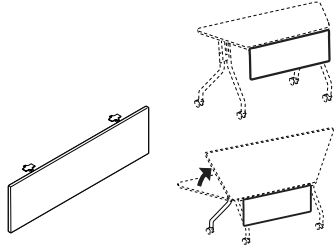

Modesty Panel - Square

BXM60QMP	27 x 0.69 x 9.6	7	1.1	\$101	
BXM66QMP	33 x 0.69 x 9.6	9	1.2	\$109	
BXM72QMP	39 x 0.69 x 9.6	10	1.4	\$113	
BXL60QMP	21 x 0.69 x 9.6	6	0.9	\$98	
BXL66QMP	27 x 0.69 x 9.6	7	1.1	\$101	
BXL72QMP	33 x 0.69 x 9.6	9	1.2	\$109	

For use on **flip-top trapezoid tables**. Includes hinged mounting bracket. Intended for use on the short side of the table; may be used on long side but leaves a larger gap. Available in standard line finishes. Edging only available in Silver (**SI**) or Black (**BK**). Please specify.

- Modesty panel model number indicates the width of table to be used on.

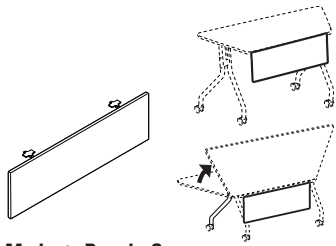

Modesty Panel - Square

BXWQMP	27 x 0.69 x 9.6	7	1.1	\$101	
--------	-----------------	---	-----	--------------	--

For use on **flip-top wedge tables**. Includes hinged mounting bracket. Intended for use on the short side of the table. Available in standard line finishes. Edging only available in Silver (**SI**) or Black (**BK**). Please specify.

- Modesty panel model number indicates the width of table to be used on.

Required specifications

- Modesty panel finish
- Edge finish

B BUNGEE™ TABLES

TRANSFORMER TABLES - FLIP-TOP - 4 PC.

4 pc. Configurations

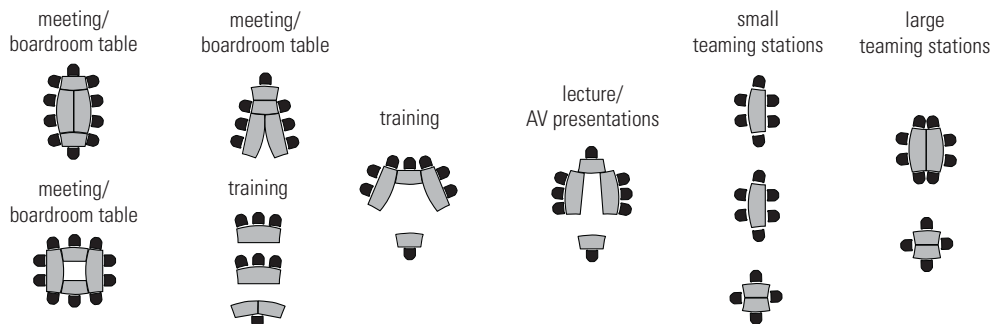

TRANSFORMER TABLES - FLIP-TOP - 4 PC.

MODEL #	DIMENSIONS	WT/LB.	CUBIC FT.	LIST PRICE	HP ADD
---------	------------	--------	-----------	------------	--------

W x D x H

BXK132S	132 x 60 x 29.2	352	151.25	\$5525	\$1442
---------	-----------------	-----	--------	--------	--------



Transformer Table Set - 4pc. Flip-Top

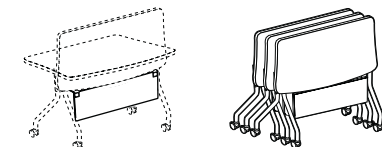

Square Modesty Panel Set for 4 pc. Flip-Top Table*

Includes four freestanding tables with spider legs. All tables feature a flip-top worksurface for ease of storage. Single hand release mechanism can be activated from left or right side of the table. Tables can be nested when folded. Each table can be "Bungee-tied" to other tables. Corners of all tops in the set are radiused for all edge options (**BB**), (**BS**), (**AB**), (**AS**), (**A3**) and (**AR**) due to geometry of the tables together. Shipped in 4 cartons.

Folding modesty panel set available, order **BXK132QMP**.

- Standard with locking casters, specify Black (**TBC**) or Tungsten (**TTC**).

BXK132QMP	45 x 0.69 x 9.6	31	3.2	\$402	N/A
-----------	-----------------	----	-----	-------	-----

For use on **4 pc. flip-top table kits**. Modesty panels flip down for storage. Features Black wire access sweep. Available in standard line finishes. Edging only available in Silver (**SI**) or Black (**BK**). Please specify.

Required specifications

Top finish	Edge detail*
Leg finish	
Modesty panel finish	
Edge finish*	

Optional specifications

HP laminate
Grommet
Casters
Power block cut-out

Accessories

Power block

TRANSFORMER TABLES - FLIP-TOP - 6 PC.

6 pc. Configurations

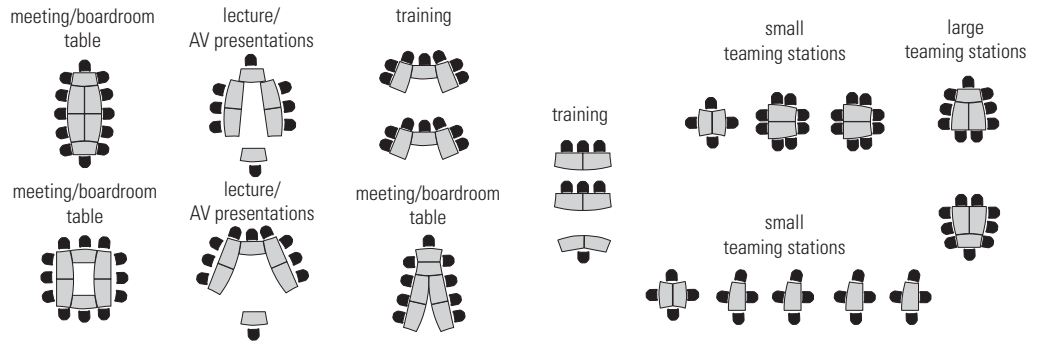

TRANSFORMER TABLES - FLIP-TOP - 6 PC.

MODEL #	DIMENSIONS	WT/LB.	CUBIC FT.	LIST PRICE	HP ADD
---------	------------	--------	-----------	------------	--------

W x D x H

BXK156S	156 x 60 x 29.2	452	181.75	\$8115	\$1659
BXK180S	180 x 60 x 29.2	507	209.5	\$8253	\$1911

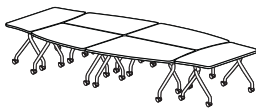

Transformer Table Set - 6 pc. Flip-Top*

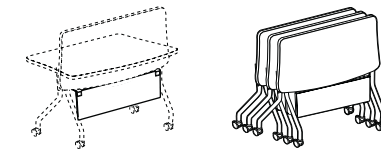

Includes six freestanding tables with spider legs. All tables feature a flip-top worksurface for ease of storage. Single hand release mechanism can be activated from left or right side of the table. Tables can be nested when folded. Each table can be "Bungee-tied" to other tables. Corners of all tops in the set are radiused for all edge options (BB), (BS), (AB), (AS), (A3) and (AR) due to geometry of the tables together. Shipped in 6 cartons.

Folding modesty panel set available, order **BXK156QMP/ BXK180QMP**.

- Standard with locking casters, specify Black (TBC) or Tungsten (TTC).

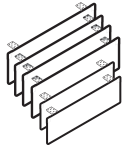

Square Modesty Panel Set for 6 pc. Flip-Top Table**

BXK156QMP	33 x 0.69 x 9.6	41	3.8	\$680	N/A
BXK180QMP	45 x 0.69 x 9.6	51	4.2	\$655	N/A

For use on 6 pc. flip-top table kits. Modesty panels flip down for storage. Features Black wire access sweep. Available in standard line finishes. Edging only available in Silver (SI) or Black (BK). Please specify.

Required specifications

Top finish*	Edge detail*
Leg finish*	
Modesty panel finish	
Edge finish**	

Optional specifications

Grommet*
Casters*
Power block cut-out*
HP laminate*

Accessories

Power block*

B BUNGEE™ TABLES

ACCESSORIES	MODEL #	DIMENSIONS	WT/LB.	CUBIC FT.	LIST PRICE	HP ADD
-------------	---------	------------	--------	-----------	------------	--------

W x D x H

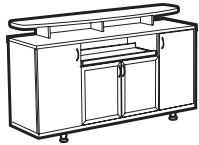

Credenza Buffet**

B2072BUF	72 x 20 x 42	305	37.5	\$3055	\$520
----------	--------------	-----	------	---------------	--------------

Pull-out shelf. Top transaction shelf has optional edge details **(BB)**, **(BS)**, **(AB)**, **(AS)**, **(A3)** or **(AR)**; surface corners are always radiused. Side storage compartments feature a laminate door and one adjustable shelf each. Center storage features frosted aluminum doors with one adjustable shelf. Leveler feet are standard. Some assembly required.

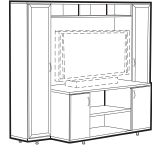

Audio/Visual Cabinet

B249072AV	90 x 24 x 72	530	52.5	\$5042	\$527
-----------	--------------	-----	------	---------------	--------------

Top pigeon holes and center adjustable shelf accommodate electronic equipment, CDs and other media. Bottom storage compartments feature laminate doors and one adjustable shelf. Side storage towers feature frosted aluminum doors with three adjustable shelves each. Accommodates TVs up to 58"W x 34"H x 24"D. Some assembly required.

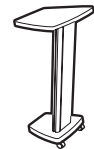

Lectern

B44LEC	22 x 17 x 44	36	12.5	\$801	N/A
--------	--------------	----	------	--------------	-----

Features angled stand with pencil ledge. Optional edge details for angled surface **(BB)**, **(BS)**, **(AB)**, **(AS)**, **(A3)** or **(AR)**; surface corners are always radiused. Locking casters. Specify Black **(TBC)** or Tungsten **(TTC)**. Shipped assembled in 1 carton.

Required specifications

Finish
Fabric*
Handles**

Optional specifications

GENERAL INFORMATION

- Introducing Bungee SL - a product line to complement and coordinate with the top selling Bungee training tables series.
- Bungee SL takes the popular aesthetic of the Bungee series and allows tables to be specified in shared leg and permanent applications - great for benching, training, teaming and academic areas.
- Bungee SL tops and legs are sold separately, increasing the flexibility of the product in the future and allows for space saving in areas where real estate is a premium.
- High pressure tops are available in all Bungee SL laminates at an extended lead time - please refer to model # for pricing.
- For environmental certifications, please visit globalfurnituregroup.com.

CONSTRUCTION

- Tops are 1" thick.
- All laminate components are made of 45 lb. density particle board with high performance thermally fused laminate.
- Tops 60" and over feature a built-in support bar. The support bar is 10" from the **approach** side, and clearance to the bottom of the support bar is 27" from the floor.
- **BUNGEE CORDS ARE NOT INCLUDED AND ARE NOT COMPATIBLE WITH BUNGEE SL TOPS.**

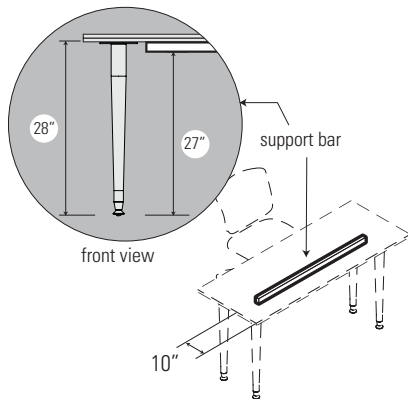

EDGE DETAIL

- Bungee SL comes with a choice of four edge styles (two with two-trim finish options):



A3 - square corner, matching edge



AR - square corner, matching bicut edge

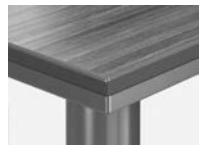

AS - square corner, Silver



AB - square corner, Black

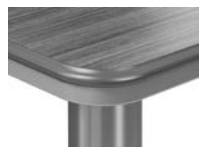

BS - rounded corner, Silver



BB - rounded corner, Black

- **BB/BS** - Bungee bubble edge: Unique "bubble" molding found on original Bungee.
- **AB/AS** - Split color PVC edge: Edge matches split color aesthetic of the bubble edge, but allows for 90 degree corners and a cleaner look.
- **A3** - 2mm preferred matching edge. Coordinates well with Adaptabilities and Zira 1" tops.
- **AR** - Bicut edge. Coordinates well with Adaptabilities and Zira 1" tops.

LEGS

- Two leg styles are available: tapered and spider leg. Available in Black (**TBL**) or Tungsten (**TTU**) finish, please specify. Levelers are standard; casters are not available for Bungee SL legs. Levelers adjust 3mm - 10mm in height.

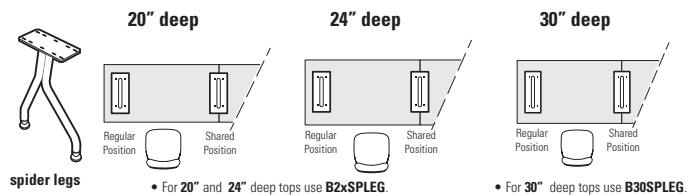

MODESTY PANELS

- See **POWER AND DATA MANAGEMENT TROUGHS**, pages 394-394.
- For modesty panels without power and data management, see **Bungee modesty panels**, pages 370-371.

WIRE MANAGEMENT / POWER OPTIONS

- **TO UTILIZE BUNGEE SL TO THE FULLEST EXTENT, SPECIFY POWER AND DATA MANAGEMENT TROUGHS**, see page 391.
- For basic wire management see details on pages 393-394.

SPECIFICATIONS

- Specifications marked with an * are applicable to only those products which have the * symbol beside the product name.

B BUNGEE SL™ - HOW TO SPECIFY

1. SPECIFY MODEL NUMBER

2. SPECIFY FINISH

ACJ Absolute Acajou	FCL First Class
ASN Asian Night	NBL Noce Biondo
AWC Avant Cherry	NGL Noce Grigio
AWH Avant Honey	NEL Noce Leggero
BLK Black	NML Noce Medio
BZD Blizzard	QTM Quartered Mahogany
BRC Brushed Cobalt	SBY Sheer Beauty
CMB Clear Maple	SDT Stonedust
CGY Custom Grey	SOG Storm Grey
DES Dark Espresso	WHE Walnut Heights
DWT Designer White	WHC White Chocolate
FAS Fashionista	WCR Winter Cherry

Edge:

BB	Bungee bubble edge with Black trim
BS	Bungee bubble edge with Silver trim
AB	Split color edge with Black trim
AS	Split color edge with Silver trim
A3	Matching 2mm flat edge
AR	Matching bicut edge

Legs:

TBL	Black
TTU	Tungsten

3. SPECIFY OPTIONS

GROMMETS

- Optional grommets available in standard worksurface locations (left, center or right) for **rectangular tops 48" and up**. Order as: **FOG1, FOG2** or **FOG3**. **Add \$91**.
- Optional grommet is available in **center position only for rectangular tops (36" and 42")**, **keystone, half moon and wedge tops**. Order as **FOG2**. **Add \$91**.
- Grommet hole dimensions are 3.25" wide x 1.875" deep.
- Grommets may be placed at non-standard locations. Order as: **CSG**. **Add \$132**. A drawing must be supplied with vertical and horizontal dimensions to the center of the cut-out (as in drawing below). Please refer to the **custom grommet location form** in the back reference section.

Grommet hole dimensions

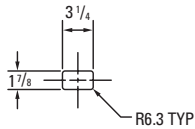

Grommet

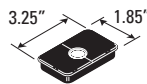

Keystone

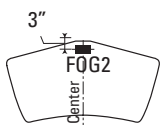

Half Moon

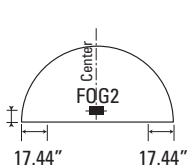

Wedge

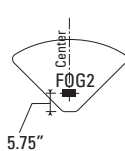

Rectangular Tops

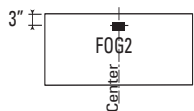

For **36" and 42"** wide units

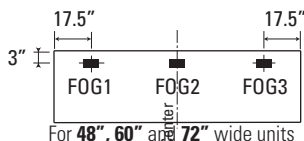

For **48", 60" and 72"** wide units

POWER BLOCK

- An individual corded power block is a rectangular worksurface power/data module with one electrical duplex receptacle and two data (RJ45) receptacles. 9' Black cord included. Power block dimensions are 6.5"W x 3.5"D x 2.75"H. Power block cut-out dimensions are 2.75" deep x 6" wide. Units cannot be daisy-chained.
- A power block cut-out (model **PMSPPDM**) may be ordered for **rectangular tops (60" and up)** in place of standard grommets. Order as **E1, E2** or **E3**. **Add \$91**.
- A power block cut-out (model **PMSPPDM**) may be ordered in the **center position only for rectangular tops (36", 42" and 48")**, **keystone and half moon tops**. Order as **E2**. **Add \$91**.
- To purchase a power block, you must specify both the power block cut-out location and the power block model #. Order power block separately as **PMSPPDM**. **Add \$268**.

Keystone

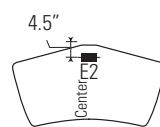

Half moon

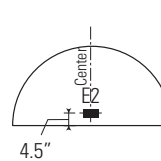

Power block

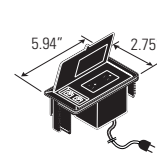

Rectangular tops

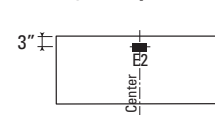

For **36", 42" and 48"** wide units

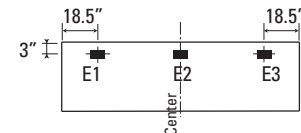

For **60" and 72"** wide units

MODPOWER DAISY-CHAIN SOLUTION

- Add flexible power and USB charging to Bungee SL rectangular tables. Connect up to four units with a single corded infeed with NEMA plug.
- ModPower units are sold separately, refer to Productivity Solutions page 473.
- Begin run with a starter unit which includes a corded infeed. Add additional middle or end units as required. Middle and end units are equipped with connecting cables.
- On-surface modules clamp on or screw mount to the table tops.
- In-surface modules require table top cut-outs for mounting. Specify cut-out option:
 - **MPS** for a single cut-out to accommodate one ModPower in-surface unit (cut-out will be centered on the approach side) for **42" to 72" wide rectangular tables**. **Add \$91**.
 - **MPD** for two cut-outs in the left and right positions, 18.25" from ends to center of unit on approach side for **60" and 72" wide rectangular tables**. **Add \$183**.

Square corner

AB/AS/A3 or AR edge only

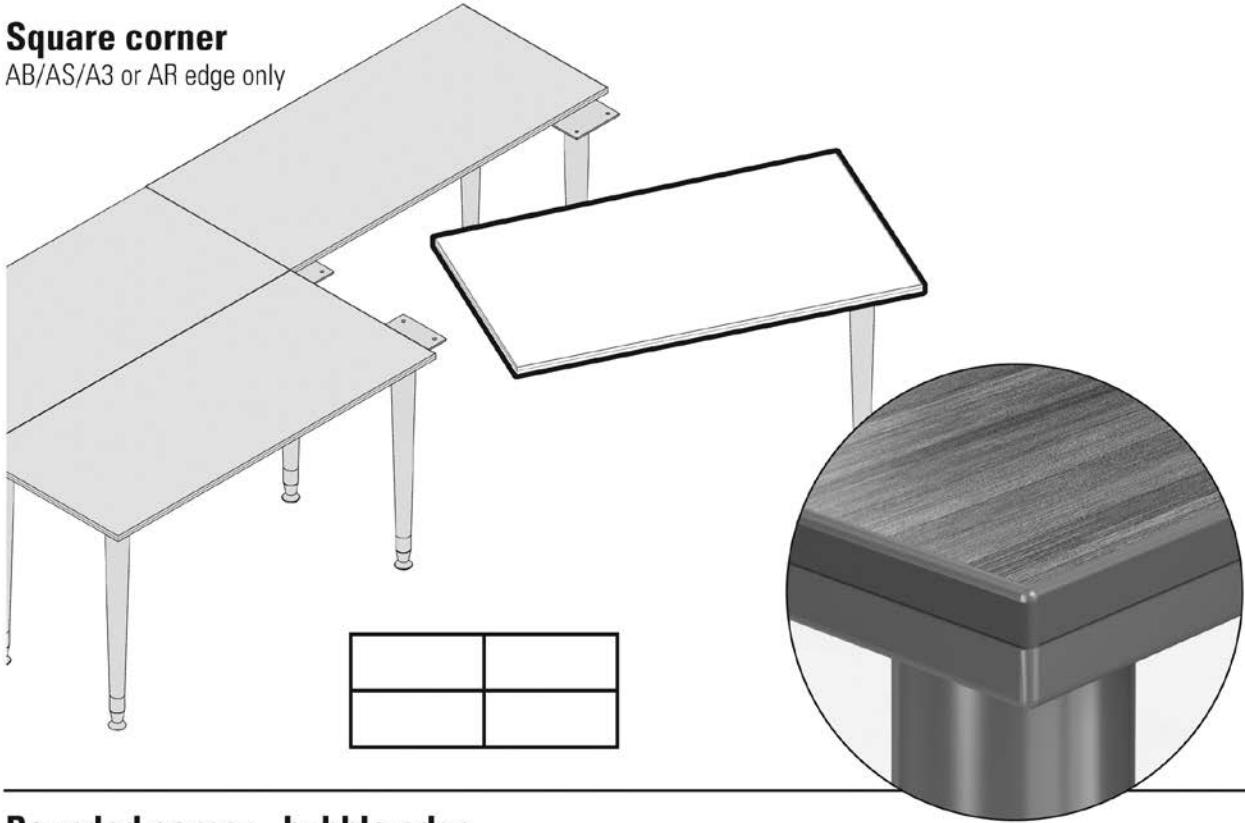
**Rounded corner - bubble edge**

BB/BS edge only

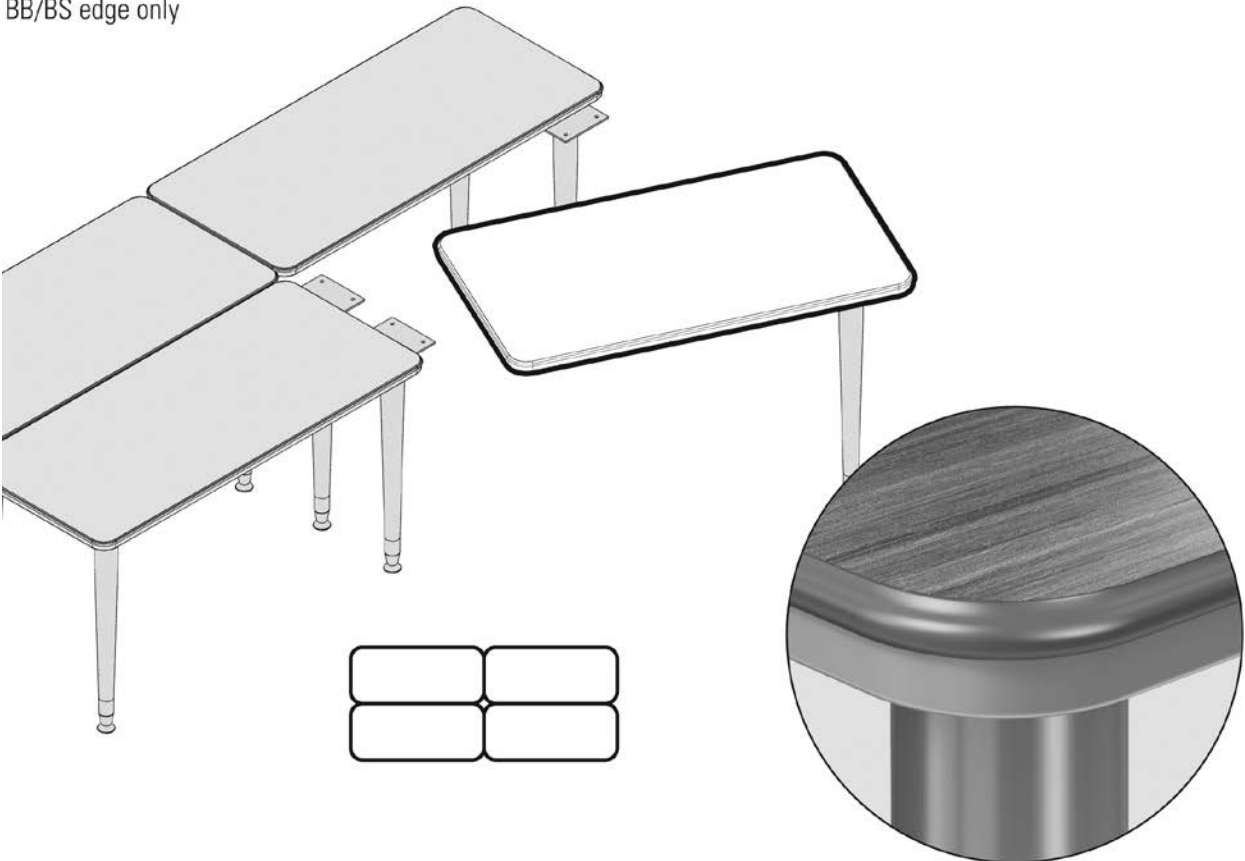

Tops with Legs and Plates Condition

Rectangular Tops

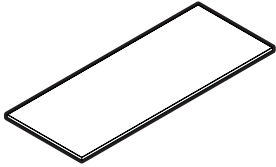

- Legs not included
- Support bar included for units with 60" and 72" width

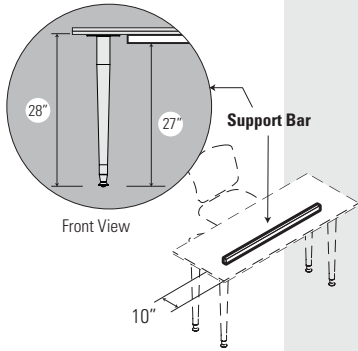

Tapered Legs

Single Straight Running Applications

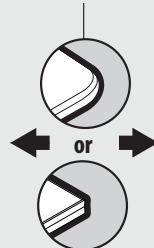
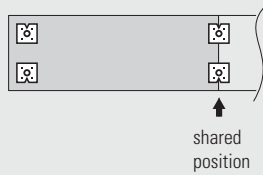

Square or Rounded Corner

Back-to-Back Applications

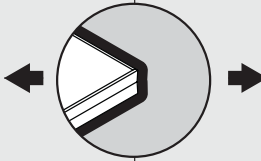
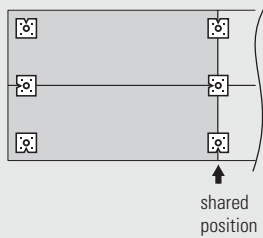

Square Corner

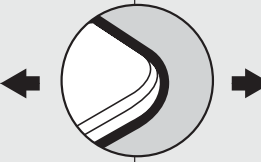
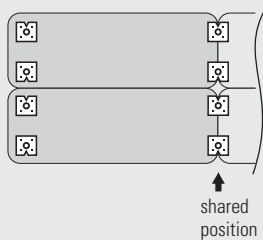

Rounded Corner

Spider Legs

Single Straight Running Applications

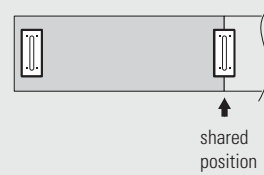

Back-to-Back Applications

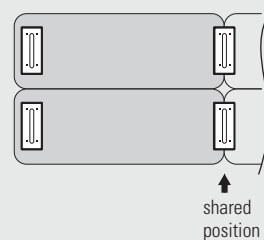
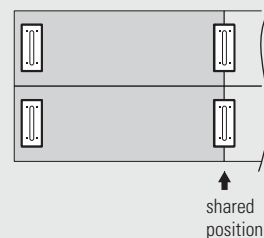

Rectangular Return Tops

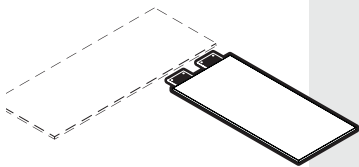

- 2 flat brackets included
- Legs not included
- Maximum width: 54"

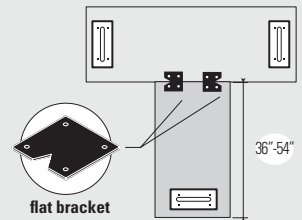
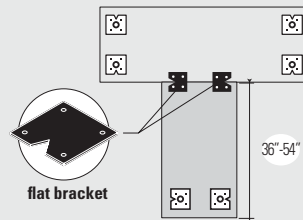
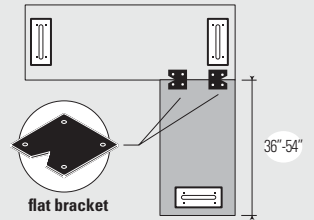
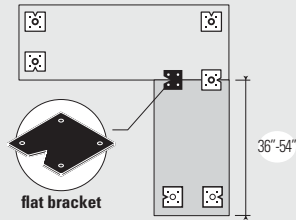

Legend:

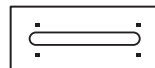

spider leg



tapered leg



flat bracket

Tops with Legs and Plates Condition

Half Moon Tops

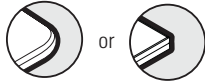
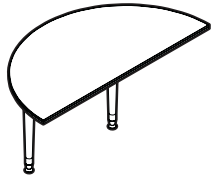

- 2 tapered legs with levelers included
- 1 flat bracket included
- Not available with spider legs
- Does not connect with spider leg tables

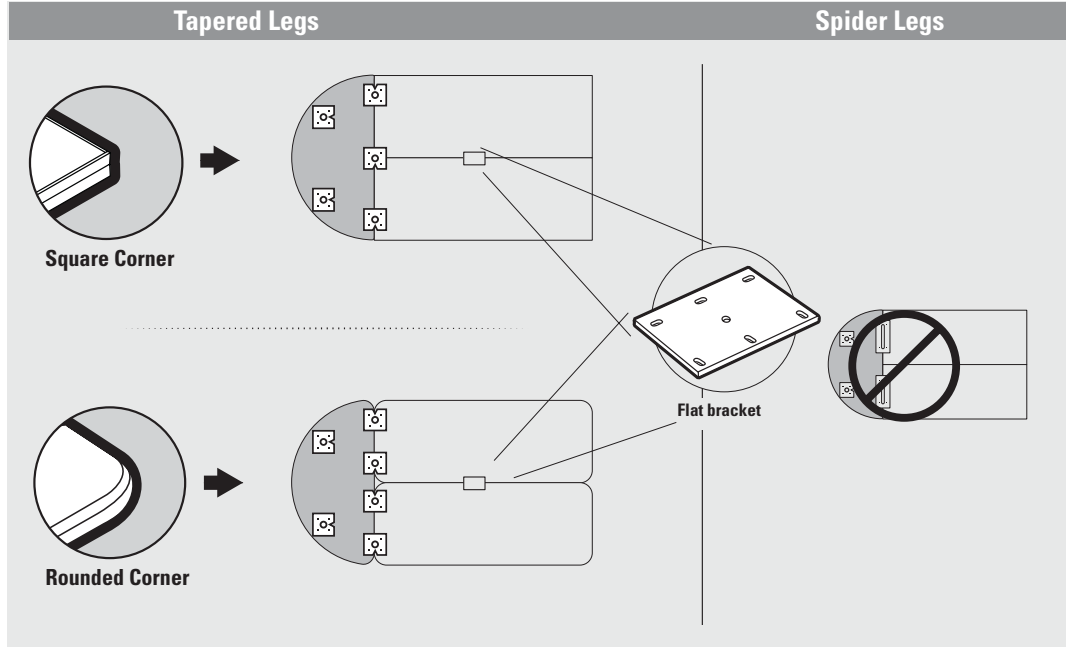

Keystone Tops

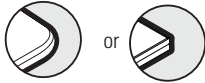
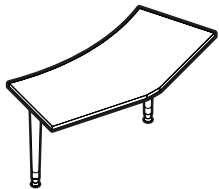

- 2 tapered legs with levelers included
- Not available with spider legs
- Does not connect with spider leg tables

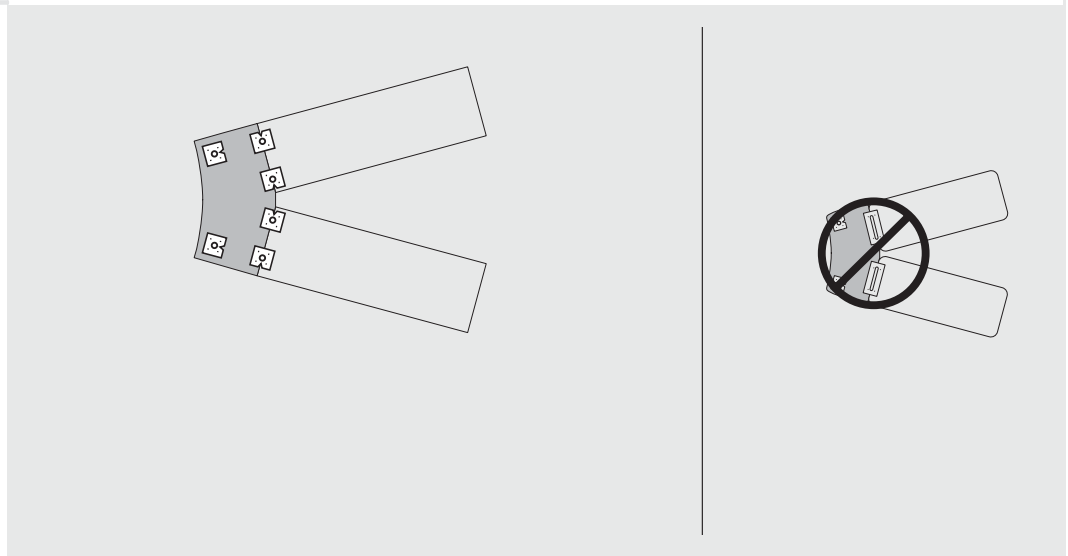

90° Wedge Tops

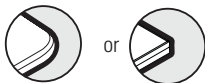

- Legs not included
- Connect to 20" or 24" deep rectangular table

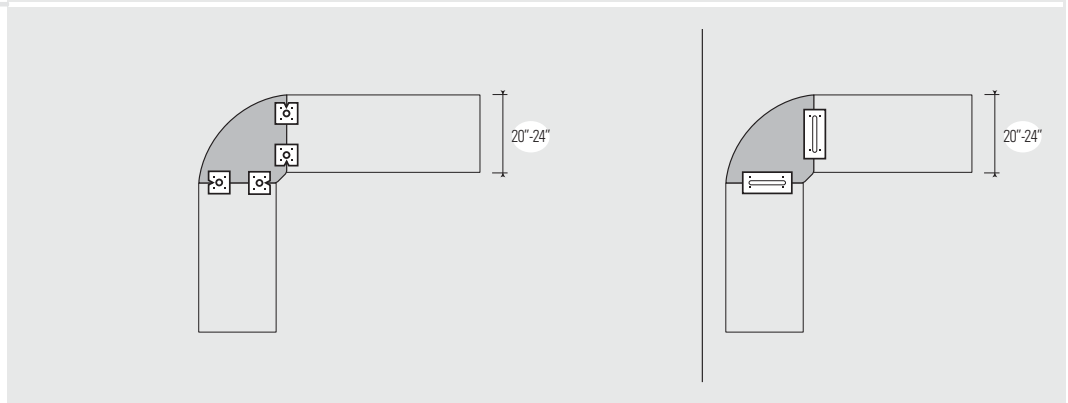

Legend:

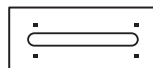

spider leg



tapered leg



plate

TOPS WITH SQUARE CORNERS

MODEL #	DIMENSIONS	WT/LB.	CUBIC FT.	LIST PRICE	HP ADD
---------	------------	--------	-----------	------------	--------

W x D x H

BS3072REC	72 x 30 x 1	60	4	\$499	\$463
BS3060REC	60 x 30 x 1	53	3.4	\$417	\$383
BS3048REC	48 x 30 x 1	46	2.7	\$253	\$309
BS3042REC	42 x 30 x 1	42	2.4	\$249	\$268
BS3036REC	36 x 30 x 1	38	2.1	\$199	\$231
BS2472REC	72 x 24 x 1	51	3.3	\$437	\$371
BS2460REC	60 x 24 x 1	44	2.8	\$380	\$309
BS2448REC	48 x 24 x 1	37	2.3	\$215	\$246
BS2442REC	42 x 24 x 1	33	2	\$206	\$215
BS2436REC	36 x 24 x 1	29	1.8	\$194	\$185
BS2072REC	72 x 20 x 1	43	2.9	\$404	\$309
BS2060REC	60 x 20 x 1	37	2.4	\$342	\$257
BS2048REC	48 x 20 x 1	30	2	\$202	\$215
BS2042REC	42 x 20 x 1	27	1.8	\$186	\$185
BS2036REC	36 x 20 x 1	24	1.5	\$173	\$185

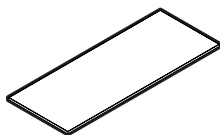

Rectangular Top - Square Corners

Rectangular 1" thick worksurface with **square corners**. Can accept tapered (B29TPLEG) or spider legs (B2XSPLEG / B30SPLEG) in "end of run" or shared leg positions. Tops 60" and up include a built-in support bar. Compatible with **power and data management troughs**, see page 391 or standard modesty panels, see page 370. Shipped easy to assemble in 1 carton.

- Do not use as return top.
- Legs sold separately.

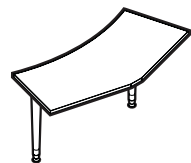

Keystone Table - Square Corners*

BS30KSF	62.75 x 30.5 x 28.7	58	4	\$887	\$463
BS24KSF	52 x 28.75 x 28.7	50	3.7	\$801	\$339
BS20KSF	44 x 27.75 x 28.7	46	3	\$732	\$278

1" thick worksurface with **square corners**. Includes **two** tapered legs. *Not available with spider legs*. Connects to other tops of 20", 24" or 30" depths. Modesty panels or filler panels are NOT available. Shipped easy to assemble in 2 cartons.

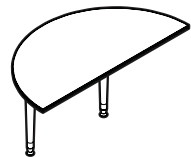

Half Moon Table - Square Corners*

BS3060HMF	59.4 x 29.75 x 28.7	57	4	\$837	\$383
BS2448HMF	48.2 x 24 x 28.7	45	3	\$785	\$246

1" thick worksurface with **square corners**. Includes **two** tapered legs. *Not available with spider legs*. Connects to other tables equaling the same length. Modesty panels or filler panels are NOT available. Shipped easy to assemble in 2 cartons.



90° Wedge Top - Square Corners

BS24WE	26.8 x 26.8 x 1	15	1.5	\$240	\$215
BS20WE	22.8 x 22.8 x 1	10	1.2	\$173	\$185

1" thick worksurface with **square corners**. Can accept tapered (B29TPLEG) or spider legs (B2XSPLEG / B30SPLEG) in shared positions only. Accepts filler modesty panels. Shipped easy to assemble in 1 carton.

- Legs sold separately.

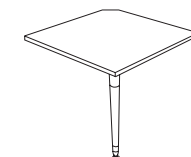

90° Corner Table - Square Corners*

BS30CN	33.2 x 33.2 x 28.7	36	2.5	\$542	\$193
--------	--------------------	----	-----	-------	-------

Connects to 30" deep rectangular tables. Includes **one** tapered leg. *Not available with spider legs*. Shipped easy to assemble in 1 carton.

Required specifications

Top finish
Edge detail
Leg finish*

Optional specifications

HP laminate
Grommet position or power block cut-out

Accessories

Power block
Power/data management troughs
Modesty panel

RECTANGULAR RETURN TOPS **MODEL #** **DIMENSIONS** **WT/LB.** **CUBIC FT.** **LIST PRICE** **HP ADD**

W x D x H

BS3054RRE	54 x 30 x 1	50	3.1	\$271	\$347
BS3048RRE	48 x 30 x 1	46	2.7	\$253	\$309
BS3042RRE	42 x 30 x 1	42	2.4	\$249	\$268
BS3036RRE	36 x 30 x 1	38	2.1	\$199	\$231
BS2454RRE	54 x 24 x 1	40	2.5	\$233	\$278
BS2448RRE	48 x 24 x 1	37	2.3	\$215	\$246
BS2442RRE	42 x 24 x 1	33	2	\$206	\$215
BS2436RRE	36 x 24 x 1	29	1.8	\$194	\$185
BS2054RRE	54 x 20 x 1	33	2.2	\$220	\$231
BS2048RRE	48 x 20 x 1	30	2	\$202	\$207
BS2042RRE	42 x 20 x 1	27	1.8	\$186	\$185
BS2036RRE	36 x 20 x 1	24	1.5	\$173	\$154

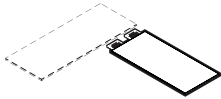

Rectangular Return Tops - Square Corners*

Rectangular 1" thick worksurface with **square corners**. Includes two flat brackets to attach to another worksurface on one end. Can accept tapered (B29TPLEG) or spider legs (B2XSPLEG / B30SPLEG) on the other end. 54" tops include a built-in support bar. Compatible with standard modesty panels, see page 370. Shipped easy to assemble in 1 carton.

- For worksurfaces to be used as a main surface, please see rectangular tops.
- Legs sold separately.

TOPS WITH ROUNDED CORNERS

BB3072REC	72 x 30 x 1	59	4	\$641	\$463
BB3060REC	60 x 30 x 1	52	3.4	\$535	\$383
BB3048REC	48 x 30 x 1	45	2.7	\$326	\$309
BB3042REC	42 x 30 x 1	41	2.4	\$318	\$268
BB3036REC	36 x 30 x 1	37	2.1	\$254	\$231
BB2472REC	72 x 24 x 1	50	3.3	\$562	\$371
BB2460REC	60 x 24 x 1	43	2.8	\$487	\$309
BB2448REC	48 x 24 x 1	36	2.3	\$276	\$246
BB2442REC	42 x 24 x 1	32	2	\$262	\$215
BB2436REC	36 x 24 x 1	28	1.8	\$249	\$185
BB2072REC	72 x 20 x 1	42	2.9	\$518	\$309
BB2060REC	60 x 20 x 1	36	2.4	\$438	\$257
BB2048REC	48 x 20 x 1	29	2	\$260	\$215
BB2042REC	42 x 20 x 1	26	1.8	\$239	\$185
BB2036REC	36 x 20 x 1	23	1.5	\$223	\$185



Rectangular Top - Rounded Corners*

Rectangular 1" thick worksurface with **rounded corners**. Can accept tapered (B29TPLEG) or spider legs (B2XSPLEG / B30SPLEG) in "end of run" or shared leg positions. Tops 60" and up include a built-in support bar. Compatible with **power and data management troughs**, see page 391 or standard modesty panels, see page 370.

Shipped easy to assemble in 1 carton.

- For worksurfaces to be used as a return, please see return tops.
- Legs sold separately.

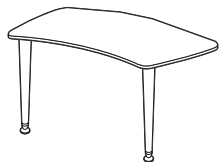

Keystone Table - Rounded Corners

BB30KSF	62.75 x 30.5 x 28.7	57	4	\$1058	\$463
BB24KSF	52 x 28.75 x 28.7	49	3	\$950	\$339
BB20KSF	44 x 27.75 x 28.7	45	3	\$860	\$278

1" thick worksurface with **rounded corners**. Includes **two** tapered legs. *Not available with spider legs*. Connects to other tops of 20", 24" or 30" depths. Modesty panels or filler panels are NOT available. Shipped easy to assemble in 2 cartons.

Required specifications

Top finish
Edge detail
Leg finish (only BBxxKSF)

Optional specifications

HP laminate
Grommet position or power block cut-out*

Accessories

Power block
Modesty panel*
Power/data management troughs*

B BUNGEE SL™

TOPS WITH ROUNDED CORNERS

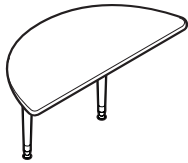

Half Moon Table - Rounded Corners*

MODEL #	DIMENSIONS W x D x H	WT/LB.	CUBIC FT.	LIST PRICE	HP ADD
BB3060HMF	59.4 x 29.75 x 28.7	56	4	\$999	\$383
BB2448HMF	48.2 x 24 x 28.7	44	3.1	\$930	\$246

1" thick worksurface with **rounded corners**. Includes **two** tapered legs. *Not available with spider legs*. Connects to other tables equaling the same length. Modesty panels or filler panels are NOT available. Shipped easy to assemble in 2 cartons.



90° Wedge Top - Rounded Corners

BB24WE	26.8 x 26.8 x 1	14	1.5	\$308	\$215
BB20WE	22.8 x 22.8 x 1	9	1.2	\$223	\$185

1" thick worksurface with **rounded corners**. Can accept tapered (B29TPLEG) or spider legs (B2XSPLEG / B30SPLEG) in shared positions only. Accepts filler modesty panels. Shipped easy to assemble in 1 carton.

- Legs sold separately.

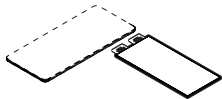

Rectangular Return Tops - Rounded Corners

BB3054RRE	54 x 30 x 1	50	3.1	\$349	\$347
BB3048RRE	48 x 30 x 1	46	2.7	\$326	\$309
BB3042RRE	42 x 30 x 1	42	2.4	\$318	\$268
BB3036RRE	36 x 30 x 1	38	2.1	\$254	\$231
BB2454RRE	54 x 24 x 1	40	2.5	\$299	\$278
BB2448RRE	48 x 24 x 1	37	2.3	\$276	\$246
BB2442RRE	42 x 24 x 1	33	2	\$262	\$215
BB2436RRE	36 x 24 x 1	29	1.8	\$249	\$185
BB2054RRE	54 x 20 x 1	33	2.2	\$286	\$231
BB2048RRE	48 x 20 x 1	30	2	\$260	\$207
BB2042RRE	42 x 20 x 1	27	1.8	\$239	\$185
BB2036RRE	36 x 20 x 1	24	1.5	\$223	\$154

Rectangular 1" thick worksurface with **rounded corners**. Includes two flat brackets to attach to another worksurface on one end. Can accept tapered (B29TPLEG) or spider legs (B2XSPLEG / B30SPLEG) on the other end. 54" tops include a built-in support bar. Compatible with standard modesty panels, see page 370. Shipped easy to assemble in 1 carton.

- For worksurfaces to be used as a main surface, please see rectangular tops.
- Legs sold separately.

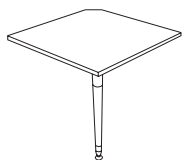

90° Corner Table - Rounded Corners*

BB30CN	33.17 x 33.17 x 28.7	36	2.5	\$578	\$193
--------	----------------------	----	-----	--------------	--------------

Connects to 30" deep rectangular tables. Includes **one** tapered leg. *Not available with spider legs*. Shipped easy to assemble in 1 carton.

Required specifications



Top finish
Edge detail
Leg finish*

Optional specifications

Grommet
HP laminate

Accessories

Power block (rectangular return tops)
Modesty panel (rectangular return tops)

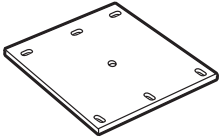
LEGS	MODEL #	DIMENSIONS W x D x H	WT/LB.	CUBIC FT.	LIST PRICE	HP ADD
 <p>Spider Legs for 30" D Tables</p>	B30SPLEG	6 x 25 x 27.7	16	2.9	\$349	N/A
<p>Spider leg with levelers. Shipped 1 per carton. Tops sold separately.</p> <ul style="list-style-type: none"> • Available in Black (TBL) or Tungsten (TTU), please specify. • To be used with 30" deep tops only. 						
 <p>Spider Legs for 20" & 24" D Tables</p>	B2XSPLEG	6 x 20 x 27.7	14	2.2	\$299	N/A
<p>Spider leg with levelers. Shipped 1 per carton. Tops sold separately.</p> <ul style="list-style-type: none"> • Available in Black (TBL) or Tungsten (TTU), please specify. • To be used with 24" & 24" deep tops only. 						
 <p>Tapered Leg</p>	B29TPLEG	6 x 6 x 27.7	11	0.75	\$139	N/A
<p>Tapered leg with levelers for tables of all depths. Shipped 1 per carton. Tops sold separately.</p> <ul style="list-style-type: none"> • Available in Black (TBL) or Tungsten (TTU), please specify. 						
 <p>Flat Bracket</p>	B6PLT	6 x 6 x 0.25	2	0.1	\$45	N/A
<p>To be used as a mending plate for Bungee SL. Black only. Shipped/sold 1 per pack. There are no specifications for Flat Bracket.</p>						

Required specifications
Leg finish

B BUNGEE SL™ POWER/DATA MANAGEMENT TROUGHS - NOTES

GENERAL INFORMATION

- Power and data management troughs for the Bungee SL table series. Add Global's proprietary 4-wire power kits and create cost effective and versatile training, benching, academic and meeting areas.
- Front panels are available in laminate or aluminum. A center spine version allows for inexpensive double-sided applications.
- **POWER AND DATA MANAGEMENT TROUGHS** are sold separately and are meant to be used on **Bungee SL only**.
- **POWER AND DATA MANAGEMENT TROUGHS** accept Global's 4-wire power kit in addition to numerous data, phone and other multimedia wires.
- Filler modesty panels conceal wiring in spaces not covered by troughs.
- For environmental certifications, please visit globalfurnituregroup.com.

FINISHES

Laminate:

ACJ Absolute Acajou	FCL First Class
ASN Asian Night	NBL Noce Biondo
AWC Avant Cherry	NGL Noce Grigio
AWH Avant Honey	NEL Noce Leggero
BLK Black	NML Noce Medio
BZD Blizzard	QTM Quartered Mahogany
BRC Brushed Cobalt	SBY Sheer Beauty
CMB Clear Maple	SDT Stonedust
CGY Custom Grey	SOG Storm Grey
DES Dark Espresso	WHE Walnut Heights
DWT Designer White	WHC White Chocolate
FAS Fashionista	WCR Winter Cherry

Aluminum Face Panel, Trough, Filler Panels and End Caps:

Black (**BLK**) Tungsten (**TUN**)

LAMINATE FACE PANEL (LFP)

- Laminate face panel (LFP) on the approach side is 11/16" thick. LFP height is 13".
- Rear access panel is 0.25" thick laminate. Rear panel height is 7.25".
- LFP and rear panel swing up to allow wire access and feature a flexible sweep at the top.
- All laminate components are made of 45 lb. commercial density particle board, covered on both sides with high performance, thermally fused laminate.
- The trough portion of the unit is made of a heavy duty aluminum extrusion to allow wire systems (including Global's 4-Wire System) to lie within the bottom.
- LFP is available in all standard laminates, aluminum trough available in Black (**BLK**) or Tungsten (**TUN**) finish, please specify (rear access panel is finished in Brushed Cobalt (**BRC**) laminate when TUN is specified, or Black (**BLK**) laminate when BLK is specified).
- End caps (JBEC) sold separately.

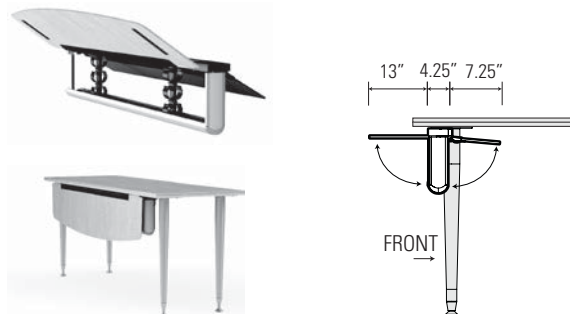

Tops, legs and end caps not included.

ALUMINUM FACE PANEL (AFP)

- Aluminum face panel (AFP) is an aluminum extrusion. AFP height is 8.25".
- AFP swings down to allow wire access and features a flexible sweep at the top.
- Rear access panel is 0.25" thick laminate. Rear panel height is 7.25".
- Rear panel swings up to allow wire access and features a flexible sweep at the top.
- The trough portion of the unit is made of a heavy duty aluminum extrusion to allow wire systems (including Global's 4-Wire System) to lie within the bottom.
- AFP and aluminum trough available in Black (**BLK**) or Tungsten (**TUN**) finish, please specify (rear access panel is finished in Brushed Cobalt (**BRC**) laminate when TUN is specified, or Black (**BLK**) laminate when BLK is specified).
- End caps (JBEC) sold separately.

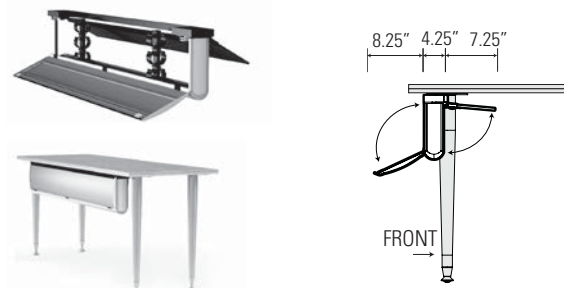

Tops, legs and end caps not included.

CENTER SPINE (CS)

- 0.25" thick laminate panels on both sides of the unit. Panel height is 7.25".
- Both panels swing up to allow wire access and feature a flexible sweep at the top.
- All laminate components are made of 45 lb. commercial density particle board, covered on both sides with high performance, thermally fused laminate.
- The trough portion of the unit is made of a heavy duty aluminum extrusion to allow wire systems (like Global's 4-Wire System) to lie within the bottom.
- Aluminum trough available in Black (**BLK**) or Tungsten (**TUN**) finish, please specify (rear access panel is finished in Brushed Cobalt (**BRC**) laminate when TUN is specified, or both access panels are finished in Black (**BLK**) laminate when BLK is specified).
- End caps (JBEC) sold separately.



Tops, legs and end caps not included.

FILLER MODESTY PANELS

- Used to fill the space between two power and data management troughs and conceal wiring from the approach side.
- Straight filler allows for use in straight configurations between two rectangular tables with power and data management troughs.
- Curved filler allows for use at curve with 90° wedge tables between two rectangular tables with power and data management troughs.
- Available in Silver (**SI**) or Black (**BK**) finish, please specify.

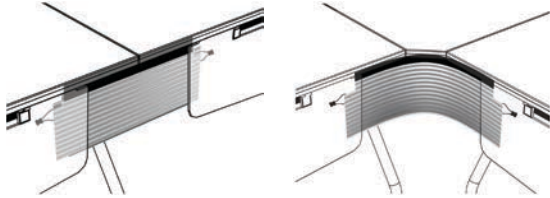

Straight filler modesty panel

Curved filler modesty panel

END CAPS

- Plastic end caps with decorative insert. Required for beginning and end of runs.
- Cap can be notched in field to allow wire infeed pass-through.
- Available in Black (**BLK**) or Tungsten (**TUN**) finish, please specify.



WIRE MANAGEMENT

- Two wire manager clamps are included within all power and data management troughs.
- Attached to the unit, they can slide from side-to-side to accommodate wiring systems.
- Data, voice, multimedia and power can be routed separately using channels on each wire manager.
- Additional wire manager clamps are available to retrofit.
- Available in Black only.

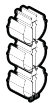

POWER SNAKE

- Attaches to underside of worksurface to organize and manage wires from the power trough to the floor in-feed.
- Black finish only.

GLOBAL 4-WIRE POWER SYSTEM

- Global's proprietary power system comes with everything you need to power your **Bungee SL** layouts. Kits coordinate to the size of the table being used and fit snugly into the bottom of the power and data management trough.
- Single duplex kits come with one duplex - centered on the wiring harness. Duplexes are 6" wide.
- Double duplex kits come with two duplexes - 11" of wiring on each side of the harness allows for flexibility between connections. Duplexes are 6" wide.
- One end of the harness kit features a female connection, while the opposite end features a male connection for a quick and easy connect/disconnect.
- Actual kit length is 1" longer than nominal.
- Must be hardwired using infeeds (specified separately) by a licensed electrician.
- All conduits are enclosed in a Black nylon sleeve to reduce visibility.
- All duplexes and connectors are plastic. Black only.
- **8 DUPLEXES PER CIRCUIT MAXIMUM** - maximums are to national electric code (NEC) - some local codes vary from NEC code - it is the customer's responsibility to follow all applicable local codes and guidelines.

ELECTRICAL SYSTEM

4-2 Wiring Schematic

4-Wire Shared Neutral

Complies with National Electric Code

UL Listed

All circuits rated for 20 AMP

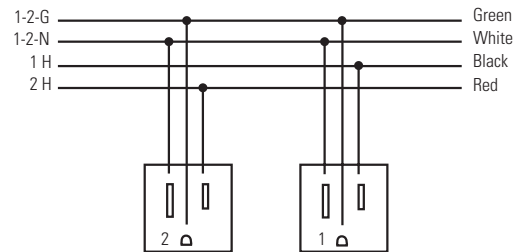

PRODUCT	MAX UNITS PER CIRCUIT
P42S	8 units per circuit
P42D	4 units per circuit

B BUNGEE SL™ POWER/DATA MANAGEMENT TROUGHS - NOTES

POWER/DATA MANAGEMENT TROUGH PLACEMENT

Single Table - AFP or LFP

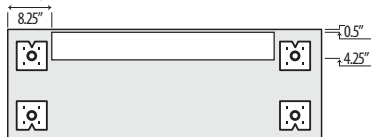

Shared Leg Tables - AFP or LFP

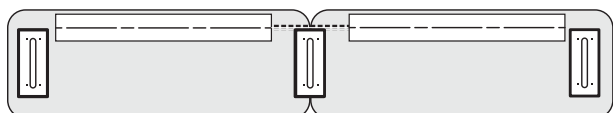
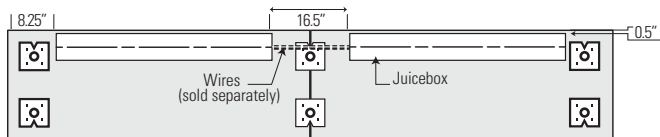

CS

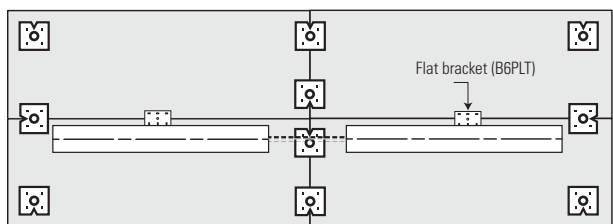

CS

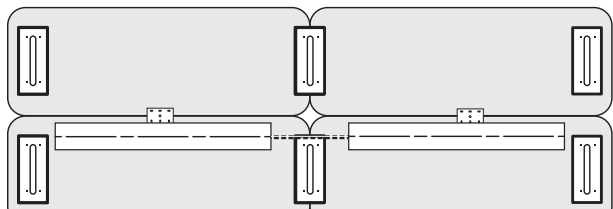

GLOBAL 4-WIRE POWER TO POWER/DATA MANAGEMENT TROUGH:

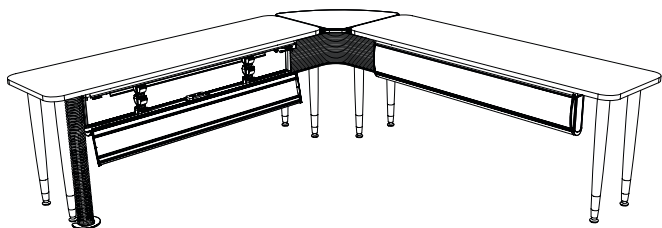

Bungee SL with AFP Power/Data Management Trough - 90° Corner Application

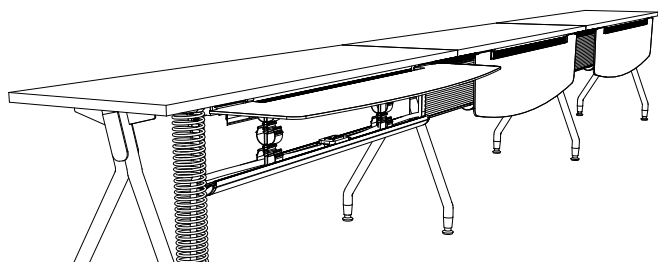

Bungee SL with LFP Power/Data Management Trough - Single Sided Straight Run
(available in Black finish only)

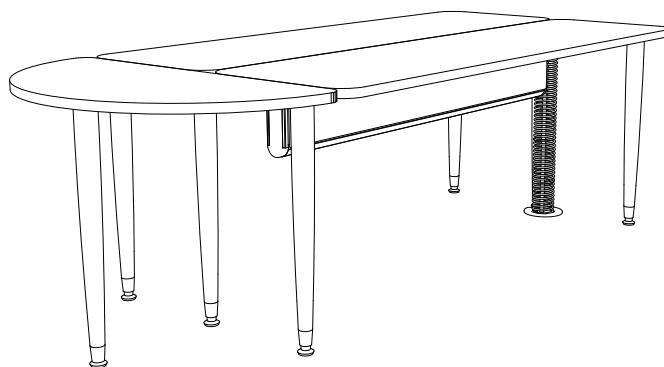

Bungee SL with CS Power/Data Management Trough - Back to Back Application
(shown with power snake)

UTILIZING POWER BLOCKS AND GROMMETS WITH POWER/DATA MANAGEMENT TROUGH

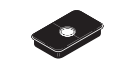
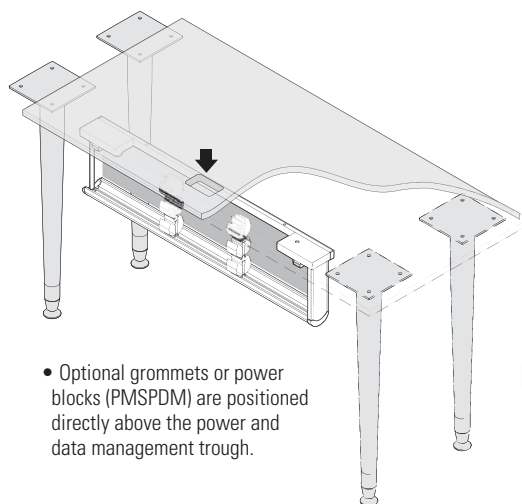

Grommet



Power block

- Optional grommets or power blocks (PMSPDM) are positioned directly above the power and data management trough.

TROUGHS	MODEL #	DIMENSIONS	WT/LB.	CUBIC FT.	LIST PRICE
---------	---------	------------	--------	-----------	------------



Trough w/Laminate Face Panel (LFP)

	W x D x H				
JB72L	55.75 x 4.33 x 13	23	2.9	\$710	
JB60L	43.75 x 4.33 x 13	18	2.3	\$635	
JB48L	31.75 x 4.33 x 13	14	1.7	\$550	
JB42L	25.75 x 4.33 x 13	12	1.5	\$510	
JB36L	19.75 x 4.33 x 13	10	1.2	\$467	

For use on rectangular Bungee SL surfaces only. Out-facing laminate panel swings up to allow wire access and features flexible sweep at the top. In-facing laminate panel swings up to allow wire access and features flexible sweep at the top. **Black finish only.** Black wire management clamps included.

- To fill the gap between two power/data management trough (LFP) modules in a straight run, a single filler modesty panel (JBSFM) is recommended.
- To fill the gap between two power/data management trough (LFP) modules at 90°, a corner filler modesty panel (JBCFM) is recommended.
- Model # corresponds to the size of table the power/data management trough will fit on (i.e. JB72L will fit a 72" wide table).



Trough w/Center Spine (CS)

JB72C	55.75 x 4.33 x 10	19	2.2	\$640	
JB60C	43.75 x 4.33 x 10	15	1.8	\$601	
JB48C	31.75 x 4.33 x 10	12	1.3	\$510	
JB42C	25.75 x 4.33 x 10	10	1.1	\$473	
JB36C	19.75 x 4.33 x 10	8	0.8	\$439	





For use on rectangular Bungee SL surfaces only in back-to-back applications only. Two laminate panels swing up to allow wire access and feature flexible sweep at the top. Black wire management clamps included.

- To fill the gap between two power/data management trough (CS) modules in a straight run, two filler modesty panels (JBSFM) are recommended to conceal wiring from both sides.
- Model # corresponds to the size of table the power/data management trough will fit on (i.e. JB72C will fit a 72" wide table).

Required specifications
 Aluminum face panel finish (AFP)
 Power/data trough finish
 Trough finish, laminate face panel (LFP)

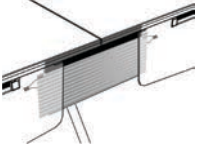
Accessories
 4-wire power system
 End cap
 Power snake

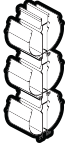
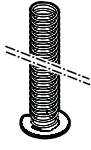
B BUNGEE SL™ POWER/DATA MANAGEMENT TROUGHS

ACCESSORIES	MODEL #	DIMENSIONS W x D x H	WT/LB.	CUBIC FT.	LIST PRICE
 <p>Straight Filler Modesty Panel</p>	JBSFM	22.5 x 0.25 x 9	1.6	0.4	\$153
<p>Straight filler modesty is used to fill the space between two power/data management trough modules where tables are linked in a straight configuration.</p> <ul style="list-style-type: none"> In center spine applications, two straight filler modesty panels should be specified to cover cabling and wires from both sides. 					
 <p>Curved Filler Modesty Panel</p>	JBFCM	28.5 x 0.25 x 9	1.8	0.5	\$183
<p>Curved filler modesty is used to fill the space between two power/data management troughs where tables are linked at a 90° curve.</p> <ul style="list-style-type: none"> For interior curves only. 					
 <p>End Cap</p>	JBEC	8 x 3 x 1	1	0.15	\$35
<p>Plastic end cap to be snapped into place at the end of power/data management troughs. To be specified for the beginning and end of runs for a finished look. Charcoal finish only.</p> <ul style="list-style-type: none"> Plastic cap can be notched in the field to allow infeed or data cable pass-through. 					
 <p>Wire Management Clamp</p>	JBWM2	8.5 x 3 x 2	1	0.1	\$138
<p>Wire management track with double wire clamp - triple height. Can be affixed to the underside of worksurface using double-sided tape (supplied) or retrofit into power/data management trough modules. Black finish only.</p> <ul style="list-style-type: none"> Recommended for use at 90° corners. Retrofitting requires disassembly of power/data management trough modules. 					
 <p>Power Snake</p>	JBPS	4 x 4 x 34	2	0.25	\$151
<p>Attaches to the underside of worksurface with supplied wood screws. Used to organize and channel wires from the power/data management trough down to the floor infeed. Black finish only.</p>					
 <p>Cable Terminator Mount</p>	JBCTM	7 x 6.5 x -	1	0.1	\$69
<p>Secures terminated data or telephone cables. Attaches with two screws to aluminum trough, inside power trough. Designed to hold multiple data solutions. Inserts not included. Black finish only.</p>					

4-WIRE POWER SYSTEM

MODEL # DIMENSIONS WT/LB. CUBIC FT. LIST PRICE

W x D x H

Circuit 1

PP42SO721	72 x - x -	3.2	0.1	\$167
PP42SO661	66 x - x -	3	0.09	\$160
PP42SO601	60 x - x -	2.8	0.09	\$154
PP42SO541	54 x - x -	2.6	0.08	\$148
PP42SO481	48 x - x -	2.4	0.08	\$141
PP42SO421	42 x - x -	2.3	0.07	\$133
PP42SO361	36 x - x -	2.1	0.06	\$127
PP42SO301	30 x - x -	1.9	0.06	\$120
PP42SO241	24 x - x -	1.7	0.05	\$110

Circuit 2

PP42SO722	72 x - x -	3.2	0.1	\$167
PP42SO662	66 x - x -	3	0.09	\$160
PP42SO602	60 x - x -	2.8	0.09	\$154
PP42SO542	54 x - x -	2.6	0.08	\$148
PP42SO482	48 x - x -	2.4	0.08	\$141
PP42SO422	42 x - x -	2.3	0.07	\$133
PP42SO362	36 x - x -	2.1	0.06	\$127
PP42SO302	30 x - x -	1.9	0.06	\$120
PP42SO242	24 x - x -	1.7	0.05	\$110

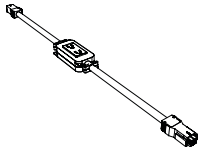

Single Duplex Kit

Single duplex kit includes one Black plastic duplex connected to harnesses. Male connection (IN) on one side with female connection (OUT) on the opposite for easy connect and disconnect. Conduit is wrapped in Black nylon sleeve. Actual length is 1" longer than nominal.

- Please specify Circuit 1 or Circuit 2.
- Model # corresponds to the size of table the power/data management trough will fit on (i.e. PP42SO481 will fit a JB48A, JB48L or JB48C module).
- Infeed required for connection to building power. Sold separately, see page 394.

Circuit 1

PP42DO721	72 x - x -	3	0.1	\$193
PP42DO661	66 x - x -	2.8	0.09	\$187
PP42DO601	60 x - x -	2.6	0.09	\$180
PP42DO541	54 x - x -	2.4	0.08	\$173
PP42DO481	48 x - x -	2.3	0.08	\$166
PP42DO421	42 x - x -	2.1	0.07	\$158
PP42DO361	36 x - x -	1.9	0.06	\$153

Circuit 2

PP42DO722	72 x - x -	3	0.1	\$193
PP42DO662	66 x - x -	2.8	0.09	\$187
PP42DO602	60 x - x -	2.6	0.09	\$180
PP42DO542	54 x - x -	2.4	0.08	\$173
PP42DO482	48 x - x -	2.3	0.08	\$166
PP42DO422	42 x - x -	2.1	0.07	\$158
PP42DO362	36 x - x -	1.9	0.06	\$153

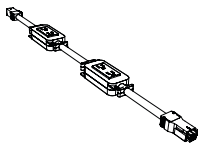

Double Duplex Kit

Double duplex kit includes two Black plastic duplexes connected to harnesses. Male connection (IN) on one side with female connection (OUT) on the opposite for easy connect and disconnect. Conduit is wrapped in Black nylon sleeve. Actual length is 1" longer than nominal.

- Please specify Circuit 1 or Circuit 2. Both duplexes on the kit will be assigned to the same circuit.
- Model # corresponds to the size of table the power/data management trough will fit on (i.e. PP42DO481 will fit a JB48A, JB48L or JB48C module).
- Infeed required for connection to building power. Sold separately, see page 394.

B BUNGEE SL™ POWER/DATA MANAGEMENT TROUGHS

4-WIRE POWER SYSTEM



Power Harness Jumper

MODEL #	DIMENSIONS	WT/LB.	CUBIC FT.	LIST PRICE
	W x D x H			
PP42J72	73 x - x -	3	0.1	\$146
PP42J66	67 x - x -	2.91	0.09	\$141
PP42J60	61 x - x -	2.73	0.09	\$137
PP42J54	55 x - x -	2.54	0.08	\$132
PP42J48	49 x - x -	2.35	0.08	\$127
PP42J42	43 x - x -	2.16	0.07	\$122
PP42J36	37 x - x -	1.98	0.06	\$117
PP42J30	31 x - x -	1.79	0.06	\$113
PP42J24	25 x - x -	1.6	0.05	\$109
PP42J18	19 x - x -	1.41	0.04	\$102

Male connection (IN) on one side with female connection (OUT) on the opposite for easy connect and disconnect. Conduit is wrapped in Black nylon sleeve. Actual length is 1" longer than nominal.

- Use PP42J18 between two power/data management troughs separated by Bungee SL wedge, keystone or half moon tables
- Use all other sizes to jump between power kits on power/data management troughs that are NOT powered (i.e. use a PP42J60 as a pass-through on a 60" wide non-powered table between POWERED power/data management trough modules.

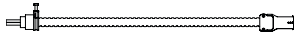

72" Multi-Circuit Hardwire Infeed

PP42HW72	72 x - x -	6.5	0.3	\$165
----------	------------	-----	-----	--------------

72" multi-circuit hardwire infeed (up to 20 AMPS per circuit), two circuits. Provides single power entry from floor or wall located building power supply. Conduit is wrapped in Black nylon sleeve.

- Connects P42S or P42D kits.
- **TO BE HARDWIRED BY LICENSED ELECTRICIAN.** UL listed.
- Where liquid tight conduit is required, specify P42HW-72L.

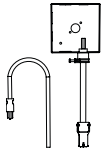

Single-Circuit 3-Prong Infeed

PP42TP120	4 x 8 x 2	6.1	0.3	\$173
PP42TP72	4 x 8 x 4	4.5	0.15	\$155

Hardwire junction box included (to be mounted on underside of table). Provides single power entry from floor or wall located building power supply. Conduit is wrapped in Black nylon sleeve. Allows for quick and easy disconnection from the wall. Available in 72" or 120" overall lengths.

- Connects P42S or P42D kits. **Power Circuit 1 only.**
- **TO BE HARDWIRED BY LICENSED ELECTRICIAN.** UL listed.

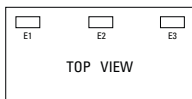
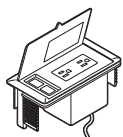

Power/Data Block

PMSPPDM	6.5 x 3.5 x 2.75	2	0.1	\$268
---------	------------------	---	-----	--------------

Worksurface power and data module. Two power receptacles and two data receptacles. 9' Black cord. Specify position and **Add \$91** for cut-out in worksurface. See page 394 for required locations. Black only.



ConnecTABLES provides solutions for a variety of day-to-day work environments. Designed as easy-to-use linking or freestanding tables, ConnecTABLES is limited only by your imagination.

Open Conference

Many ConnecTABLES tops can be assembled to be freestanding. When combined with locking casters and the flip-top T-leg, the result is easy storage and complete portability.

Meeting Rooms

ConnecTABLES modular units provide quick and affordable answers for all sizes and shapes of rooms and applications.

Educational and Training Rooms

ConnecTABLES table tops configure easily into temporary or permanent educational applications.



T-leg with leveling glides.



Modesty panel.

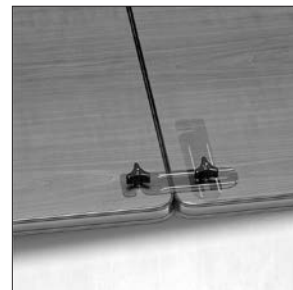

Optional ganging connector.

Features and Benefits

- Optional, easy-to-use thumbscrews allow installation without tools.
- Optional zinc-plated steel ganging hardware connects freestanding tops without moving T-leg position.
- Optional modesty panel wire management unit available.
- Casters will not affect table height when used in conjunction with or in place of glides.
- Optional Black grommets for convenient wire management can be ordered "factory installed".
- Tops are 1" thick and constructed of 45 lb. density particle board.
- Optional casters available with or without manual locks provide mobility.
- ConnecTABLES tops are available in all Global laminate finishes with three leg and two edge color options.

GENERAL INFORMATION

- ConnecTABLES is an affordable and highly flexible system of modular tables. Designed as easy-to-use linking or freestanding tables, ConnecTABLES adapts to every requirement: seminar or training room, meeting room, personal workstations, educational, conferencing and team cluster workgroups.
- ConnecTABLES have eight basic top shapes available in various sizes.
- ConnecTABLES edges **do not match** any other Global product in either color or style.
- For environmental certifications, please visit globalfurnituregroup.com.

WORKSURFACES

- Tops are 1" thick, made of 45 lb. density particle board covered on both sides with high performance thermally fused laminate.
- Laminate finishes are available in high pressure. Contact your Customer Service representative for a quote.
- If other than a Global standard laminate finish is preferred, contact your Customer Service representative. Information needed includes the name of the laminate manufacturer, color name, number and model of table. You will then be given a quote for this special order.
- **ConnecTABLES edges do not match any other Global product in either color or style.**

CONSTRUCTION

- Some components can stand-alone when the "T" base is set in the freestanding position. When the "T" base is in the linking position, all the components can be used in grouping configurations (clusters).
- Optional wire grommets not available on 45° wedge and the 60° triangle.
- Rectangular tops 54" in length and longer are supplied with a 16" gauge steel support channel. Top is predrilled for placement.
- Shipped easy to assemble.
- Special width tops are available. Use next size up.
- Adjustable levelers offer up to 1" adjustability.
- Elliptical column cover, glides, casters, thumbscrews and endcaps available in Black only.
- MUST specify top, edge, and "T" base color with each order.

LEGS

- T-leg is coated with environmentally friendly, recyclable paint electrostatically applied epoxy powder coating for a very durable finish in three colors as specified below. Only the bottom horizontal portion of the painted leg is visible.
- Black plastic leveling glides offer 1" adjustability.
- Two Black plastic elliptical column caps cover each leg column.
- Casters will not affect table height when used in conjunction with or in place of glides.
- Casters can facilitate mobility in installations which need to be moved frequently.
- Legs when used with casters have no adjustability for leveling.

LAMINATE FINISHES

ACJ Absolute Acajou	FCL First Class
ASN Asian Night	NBL Noce Biondo
AWC Avant Cherry	NGL Noce Grigio
AWH Avant Honey	NEL Noce Leggero
BLK Black	NML Noce Medio
BZD Blizzard	QTM Quartered Mahogany
BRC Brushed Cobalt	SBY Sheer Beauty
CMB Clear Maple	SDT Stonedust
CGY Custom Grey	SOG Storm Grey
DES Dark Espresso	WHE Walnut Heights
DWT Designer White	WHC White Chocolate
FAS Fashionista	WCR Winter Cherry

EDGE COLORS

Black (BLK)

LEG COLORS

Black (TBL) Shadow (TSH)
 Chrome (CHM)* Tungsten (TTU)
 *optional on foot only

GROMMETS

- Optional grommets are available in standard worksurface locations (left, center or right) **for rectangular tables**. Order as: **FOG1, FOG2 or FOG3. Add \$91.**
- Grommet hole dimensions are 3.25" wide x 1.875" deep.

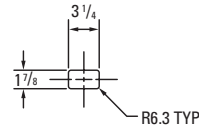

- Grommets may be placed at non-standard locations. Order as: **CSG. Add \$132.** A drawing must be supplied with vertical and horizontal dimensions to the center of the cut-out (as in drawing above). Please refer to the **custom grommet location form** in the back reference section.
- If adding **Cove mini power block** to FOG cut-out, cannot use with modesties.

POWER BLOCK

- An individual corded power block (model **PMSPDM**) may be ordered on all worksurfaces.
- Power block is a configured with one electrical duplex receptacle and two data (RJ45) receptacles. 9' Black cord included. Power block dimensions are 6.5"W x 3.5"D x 2.75"H. Units cannot be daisy-chained and cannot be used with modesties.
- To purchase a power block, you must specify both the power block cut-out location and the power block model #. Order power block as **PMSPDM. Add \$268.** Power blocks are available in standard worksurface locations (left, center or right). Order as **E1, E2 or E3. Add \$91.**

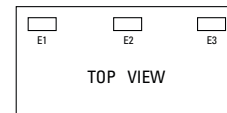
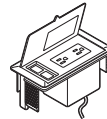

Power block **PMSPDM. Add \$268.** Specify location **E1, E2 or E3. Add \$91.**

EXAMPLES OF POWER BLOCK POSITIONS

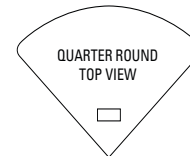
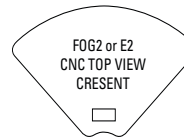
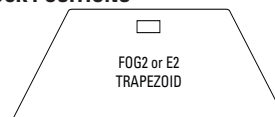
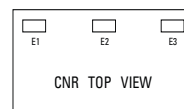

MODPOWER DAISY-CHAIN SOLUTION

- Add flexible power and USB charging to ConnecTables rectangular tables. Connect up to four units with a single corded infeed with NEMA plug.
- ModPower units are sold separately, refer to Productivity Solutions page 473.
- Begin run with a starter unit which includes a corded infeed. Add additional middle or end units as required. Middle and end units are equipped with connecting cables.
- On-surface modules clamp on or screw mount to the table tops.
- In-surface modules require table top cut-outs for mounting (cannot be used with modesties):
 - Specify cut-out option **MPS** for a single cut-out to accommodate one ModPower in-surface unit (cut-out will be centered on the approach side) for **30" to 72" wide rectangular tables. Add \$91.**
 - Specify cut-out option **MPD** for two cut-outs in the left and right positions, 15" from ends to center of unit on approach side for **60", 66" and 72" wide rectangular tables. Add \$183.**

SPECIFICATIONS

- Specifications marked with an * are applicable to only those products which have the * symbol beside the product name.

TOP & EDGE OPTIONS

- ConnectTABLES have nine basic top shapes available in various sizes. All top shapes have a variety of straight or curved edges which are referred to as **Working (W)**, **Connecting (C) or End (E) edges**. Edges can also have a combination of edge types as shown.

*cannot freestand

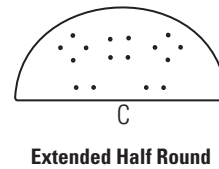
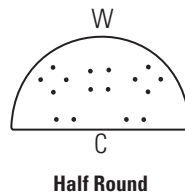
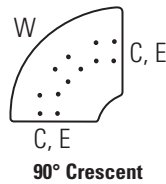
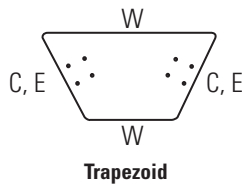
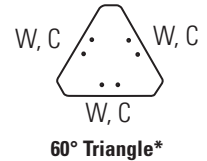
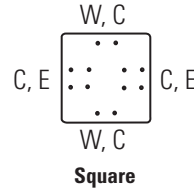
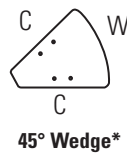
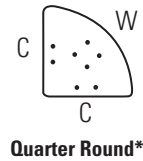
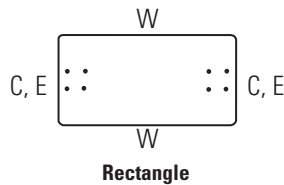

Working edge (1) - Edges designated with the letter "W" indicate that this is a **working** or sitting edge. These edges can be connected with optional ganging hardware in freestanding applications.

Connecting edge (2) - Edges designated with the letter "C" indicate that this is a **connecting** edge. These edges can be connected to any other connecting edge of equal width, regardless of the top shape or size.

End edge (3) - Edges designated with the letter "E" indicate that this is an **end** edge or an edge that can finish a run of tops. If a top has two end edges it can be freestanding. 90° crescent tops can be freestanding if the optional center leg is added.

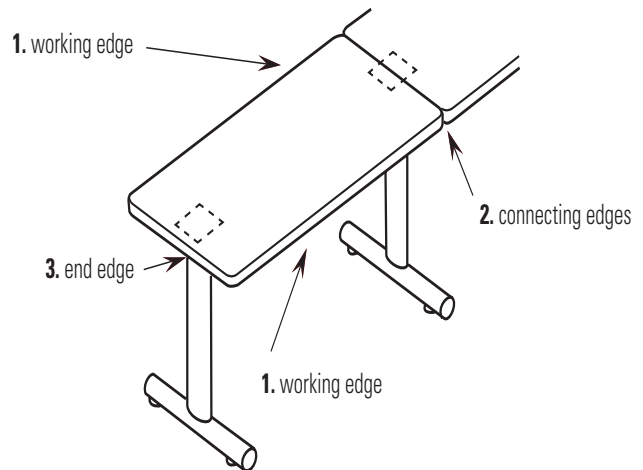

FREESTANDING AND CONNECTING CONDITIONS

Freestanding tables are defined as any one worksurface supported by two or more legs; **connecting tables** are defined as more than one worksurface supported by a single leg at each point of connection. The rule to determine the quantity of legs of an open configuration is the number of worksurfaces plus one (See Figure 1).

On closed configurations, the number of legs is equal to the number of worksurfaces (See Figure 2). There are some exceptions, such as when optional third legs are used on quarter round or 90° crescent shapes.

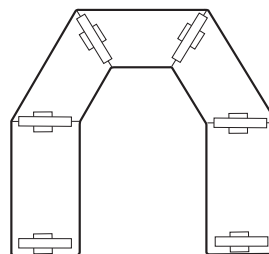

Figure 1.
Open Configuration
Number of surfaces = 5
Number of legs = 6

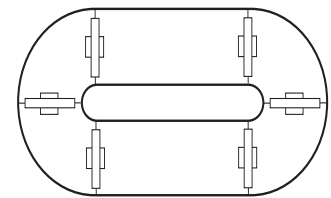

Figure 2.
Closed Configuration
Number of surfaces = 6
Number of legs = 6

C CONNECTABLES® - NOTES

FREESTANDING CONDITIONS

- All square, rectangle and trapezoid shapes are able to act as freestanding tables (**Figure 3**).
- When trapezoid tops are freestanding, legs must be on the outer left and right sides (**Figure 4**).
- 90° crescent worksurfaces have provision for an optional third center leg for additional stability when heavy loads are applied to the outside edge. They can also be used as freestanding tables when a third leg is added (**Figure 5**).
- All freestanding tables can be connected with optional ganging hardware.
- Freestanding tables can be ganged with connected tables in some cases, providing that the number and size of connected tables is easily movable (**Figure 6**).

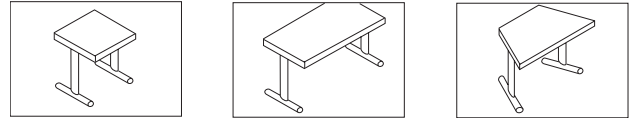
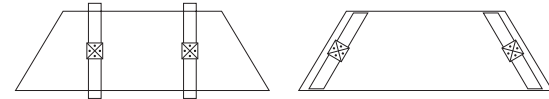

Figure 3 - Freestanding Tables



Incorrect Correct
Figure 4 - Trapezoid Tops

• DO NOT DRAG TABLES WHEN RE-CONFIGURING.

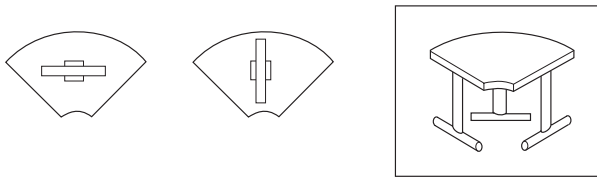

Figure 5 - Adding a Third Leg

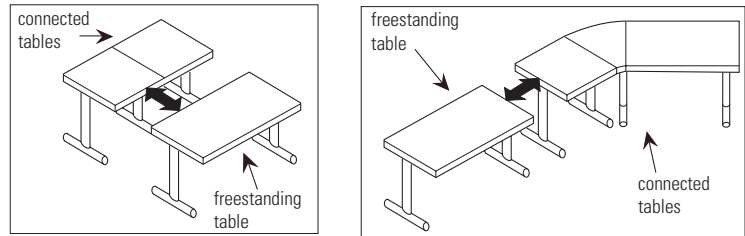

Figure 6 - Ganging with Connected Tables

CONNECTING CONDITIONS

- Any two worksurfaces of equal depth (24"D, 30"D or 36"D) can be connected with one leg, at the connecting or end edges (**Figure 8**).
- Half round worksurfaces can be used in the following ways: They must be of equal width when connected to each other (**Figure 7**) or the connecting shapes must be equal to half the width of the connecting half round (**Figure 8**).
- ConnectABLES is designed with the leg to be fastened parallel to connecting edges, but in some cases you may wish to fasten legs at 90° to connecting edges. This could allow for increased leg or knee clearance, depending on the intended use (**Figure 9**).
- Quarter round and 90° crescent worksurfaces have provision for an optional third leg for additional stability when heavy loads are applied to the outside edge. For quarter round worksurfaces, it is recommended that configuration "A" be used since the outside end of the center leg in configuration "B" is almost flush with the outside edge of the worksurface. If configuration "B" is installed against a wall or where there will be no traffic flow, then configuration "B" can be used.

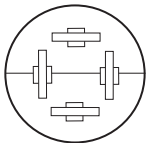

Figure 7

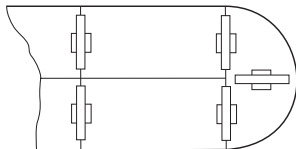

Figure 8

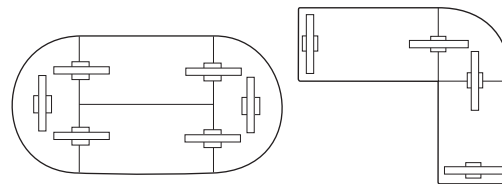
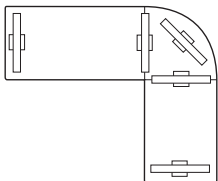
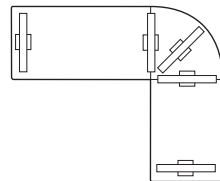

Figure 9 - 90° Leg Connections



Configuration A



Configuration B

Legs are fastened to worksurfaces utilizing a steel-to-steel connection. Each leg comes equipped with four 0.25" x 0.875" screws. machine screws. Screws are inserted through the four oval shaped holes only. **Do not use wood screws.** When fastening legs to worksurfaces, hand thread screws into position to prevent any cross threading. When all screws have been hand threaded, tighten firmly with screwdriver to secure. Optional thumbscrews can be used in place of machine screws. Thumbscrews eliminate the need for a screwdriver, whether assembling or disassembling tables. **Do not use power tools for assembly of legs.**

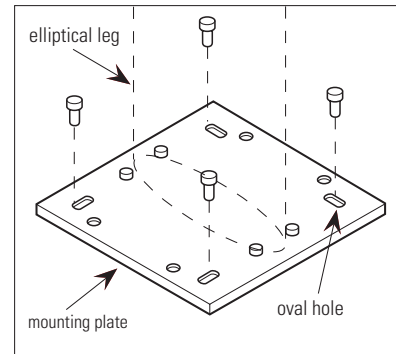

FREESTANDING TABLES

1. Turn worksurface upside-down on clean floor. (You may want to use carton from packaging as a protective assembly surface to protect the top from scratching.)
2. Position leg mounting plate holes over threaded steel inserts in top.
3. Fasten each leg to top with four 0.25" x 0.875" screws.
4. Turn table right-side up.
5. Level table by adjusting glides.

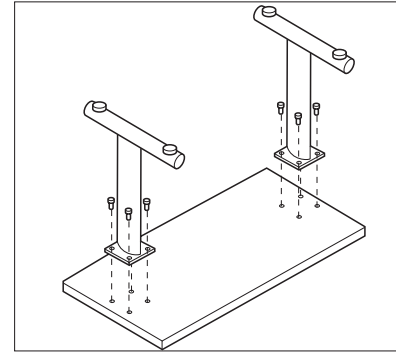

CONNECTING TABLES

1. Determine approximate location of desired configuration in room and turn worksurfaces upside down on floor. (Remember you are working in reverse.)
2. Position leg mounting plate so it is centered over the connecting edge of the first worksurface. Fasten leg with two 0.25" x 0.875" screws.
3. Repeat step 2 and 3 on the opposite edge of the first worksurface.
4. Turn table right side up.
5. Turn table right side up and fasten to the previous top from the underside.
6. To add additional worksurfaces repeat step 5.
7. When all the tops have been connected, level complete configuration by adjusting glides.

Note: Use the same procedures as above when using optional thumb screws.

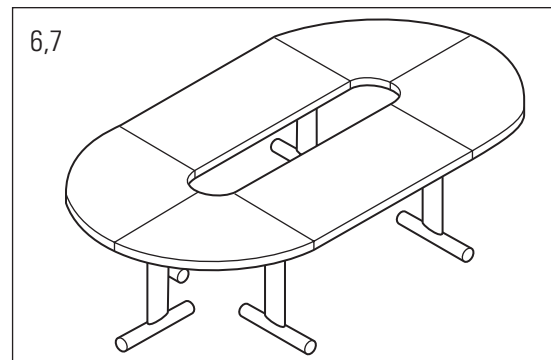
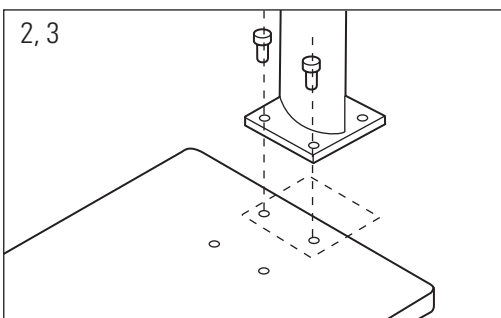
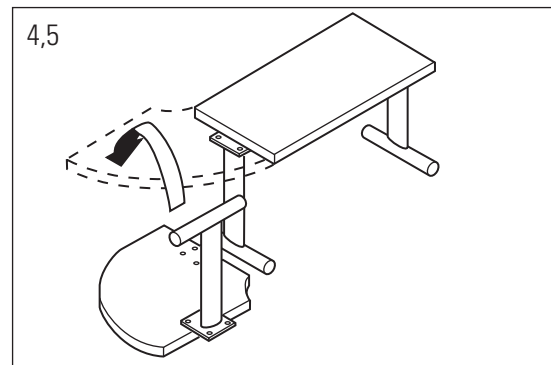
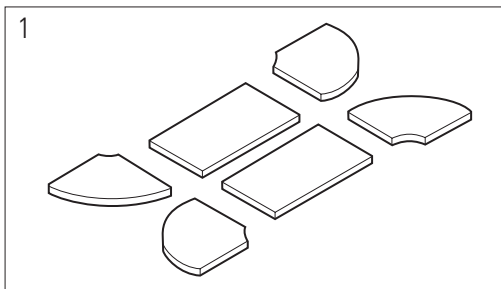

C CONNECTABLES® - PUTTING IT ALL TOGETHER

OPTIONAL CASTERS

1. Turn worksurface upside down on floor.
2. Remove existing glide if previously installed.
3. Fasten caster to T-leg by threading caster stem into base of T-leg and secure by tightening lock nut.
4. If casters are used in combination with glides, level table by adjusting glides.

Note: Casters are available in locking or non-locking styles.

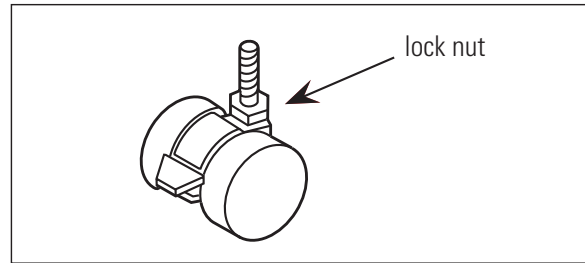

OPTIONAL GANGING HARDWARE

1. Optional ganging hardware should be used when quick and frequent reconfigurations are required.
2. Turn worksurfaces to be ganged upside-down on floor.
3. Remove ganging hardware from package. Holes with steel inserts are located in the corner of tops.
4. Fasten ganging hardware to each worksurface with supplied thumb screws.
5. Projected arm from ganging hardware can pivot out of the way when not in use.

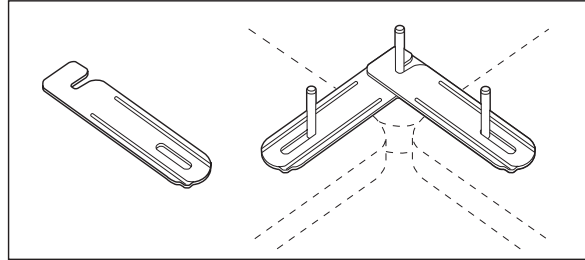

SQUARE TOPS **MODEL #** **DIMENSIONS** **WT/LB.** **CUBIC FT.** **LIST PRICE**

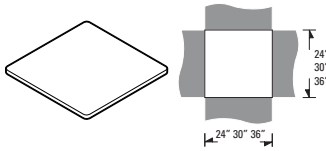

Square Top

	W x D x H			
CNS2424	24 x 24 x 1	18	1	\$266
CNS3030	30 x 30 x 1	27	1.56	\$324
CNS3636	36 x 36 x 1	39	2	\$330

T-mold edging. Predrilled with threaded steel inserts for freestanding and linking installations.

RECTANGULAR TOPS

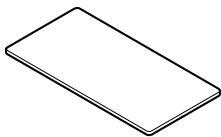
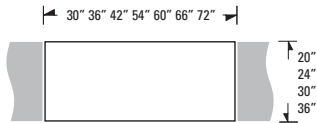

Rectangle Top

CNR2030	30 x 20 x 1	22	1.25	\$183
CNR2036	20 x 36 x 1	22.5	0.46	\$198
CNR2042	42 x 20 x 1	31	1.75	\$224
CNR2048	48 x 20 x 1	35	2	\$244
CNRU2054	54 x 20 x 1	33.75	0.69	\$323
CNRU2060	60 x 20 x 1	37.5	1.4	\$343
CNRU2066	66 x 20 x 1	41.25	0.84	\$376
CNRU2072	72 x 20 x 1	45	1	\$397
CNR2430	30 x 24 x 1	22	1.25	\$193
CNR2436	36 x 24 x 1	26	1.5	\$211
CNR2442	42 x 24 x 1	31	1.75	\$234
CNR2448	48 x 24 x 1	35	2	\$255
CNRU2454	54 x 24 x 1	42	2.34	\$338
CNRU2460	60 x 24 x 1	47	2.5	\$358
CNRU2466	66 x 24 x 1	52	2.8	\$390
CNRU2472	72 x 24 x 1	57	3	\$415
CNR3036	36 x 30 x 1	33	1.88	\$255
CNR3042	42 x 30 x 1	38	2.19	\$279
CNR3048	48 x 30 x 1	44	2.5	\$302
CNRU3054	54 x 30 x 1	52	2.8	\$387
CNRU3060	60 x 30 x 1	59	3.13	\$411
CNRU3066	66 x 30 x 1	64	3.44	\$439
CNRU3072	72 x 30 x 1	70	3.75	\$466
CNR3642	42 x 36 x 1	52.5	1.6	\$354
CNR3648	48 x 36 x 1	60	1.8	\$387
CNRU3654	54 x 36 x 1	70	2	\$495
CNRU3660	60 x 36 x 1	78	2.2	\$538
CNRU3666	66 x 36 x 1	87	2.4	\$592
CNRU3672	72 x 36 x 1	94	2.6	\$647

T-mold edging. Predrilled with threaded steel inserts for freestanding and linking installations. **Tops 54" and longer are standard with a 16 gauge steel support channel.**

TRAPEZOID TOPS

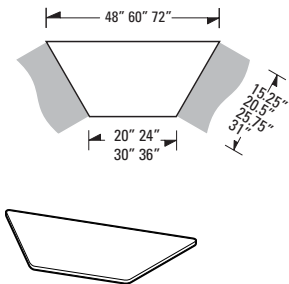

Trapezoid Top

CNT2048	48 x 17.5 x 1	26.25	0.55	\$252
CNT2060	60 x 17.5 x 1	44	1.85	\$307
CNT2448	48 x 20.5 x 1	21	2	\$268
CNT2460	60 x 20.5 x 1	44	1.85	\$324
CNT3060	60 x 25.75 x 1	35	3.13	\$353
CNT3072	72 x 25.75 x 1	66	2.2	\$397
CNT3660	60 x 31 x 1	66	2.2	\$482
CNT3672	72 x 31 x 1	79.2	3.5	\$578

T-mold edging. Predrilled with threaded steel inserts for freestanding and linking installations.

Required specifications

Top finish
Edge finish

Optional specifications

Grommet

Accessories

Power block

C CONNECTABLES®

90° CRESCENT TOPS

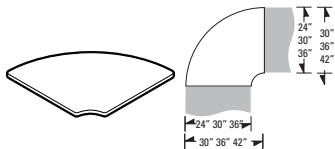

90° Crescent Top*

MODEL #	DIMENSIONS W x D x H	WT/LB.	CUBIC FT.	LIST PRICE
CNC2430	30 x 30 x 1	20	1.56	\$280
CNC3036	36 x 36 x 1	30	2.25	\$403
CNC3642	42 x 42 x 1	50	3.15	\$556

T-mold edging. Predrilled with threaded steel inserts for freestanding and linking installations.

- **CNC2430** for use with 24" deep tops.
- **CNC3036** for use with 30" deep tops.
- **CNC3642** for use with 36" deep tops.
- **CNC2430** does not require a center leg.

QUARTER ROUND TOPS

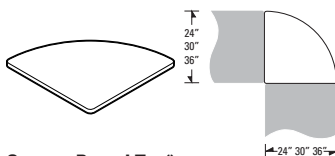

Quarter Round Top*

CNQ2424	24 x 24 x 1	14	1	\$172
CNQ3030	30 x 30 x 1	21	1.56	\$213
CNQ3636	36 x 36 x 1	45	1.3	\$351

T-mold edging. Predrilled with threaded steel inserts for **linking installations only**.

45° WEDGE TOPS

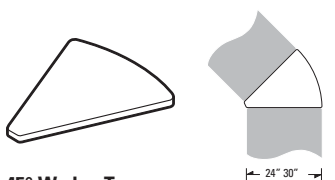

45° Wedge Top

CNW2424	24 x 24 x 1	10	1	\$190
CNW3030	30 x 30 x 1	14	1.56	\$231

T-mold edging. Predrilled with threaded steel inserts for **linking installations only**.

THREE WAY CONNECTOR TOPS

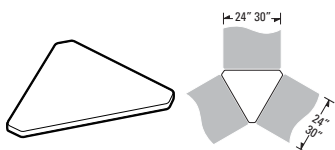

Three Way Connector Top

CNY2424	24 x 24 x 1	13	1	\$172
CNY3030	30 x 30 x 1	18	1.56	\$210

T-mold edging. Predrilled with threaded steel inserts for **linking installations only**.

HALF ROUND TOPS

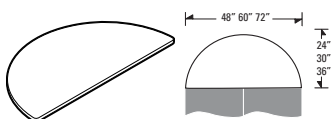

Half Round Top*

CNHFS2448	48 x 24 x 1	36	2	\$274
CNHFS3060	60 x 30 x 1	56	3.13	\$360
CNHFS3672	72 x 36 x 1	81	3.3	\$624

T-mold edging. Predrilled with threaded steel inserts for freestanding and linking installations.

- *Requires three legs for freestanding.*

EXTENDED HALF ROUND TOPS

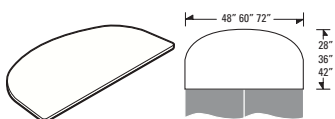

Extended Half Round Top

CNHE24	48 x 28 x 1	50	1.88	\$311
CNHE30	60 x 36 x 1	75	2.87	\$442
CNHE36	72 x 42 x 1	102	3.88	\$706

T-mold edging. Predrilled with threaded steel inserts for **linking installations ONLY**.

Required specifications

Top finish
Edge finish

Optional specifications

Grommet*

Accessories

Power block

MODESTY PANELS **MODEL #** **DIMENSIONS** **WT/LB.** **CUBIC FT.** **LIST PRICE**



Modesty Panel

	W x D x H				
CNCA2430	35 x 2.75 x 11.75	2.8	0.5		\$145
CNCA3036	43 x 2.75 x 11.75	3.3	0.6		\$172
CNCA3642	53 x 2.75 x 11.75	3.9	0.7		\$230

For use with **CNC crescent tops**. 11.75" high, Black plastic, attractive ribbed design. Includes two fold-away installation clips and flexible privacy strips. Connects to predrilled holes in table top.

- *Cannot be used when worksurface tops are attached to flip-top legs.*

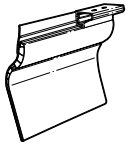

Modesty Panel

CNQA2424	27 x 2.75 x 11.75	2.2	0.4		\$123
CNQA3030	35 x 2.75 x 11.75	2.8	0.5		\$145
CNQA3636	44 x 2.75 x 11.75	3.3	0.6		\$172

For use with **CNQ quarter round tops**. 11.75" high, Black plastic, attractive ribbed design. Includes two fold-away installation clips and flexible privacy strips. Connects to predrilled holes in table top.

- *Cannot be used when worksurface tops are attached to flip-top legs.*

CNRA2030	29.5 x 3 x 10.5	2.5	0.54		\$123
CNRA2036	35.5 x 3 x 10.5	2.65	0.65		\$145
CNRA2042	41.5 x 3 x 10.5	2.9	0.76		\$172
CNRA2048	47.5 x 3 x 10.5	3.1	0.86		\$196
CNRA2054	53.5 x 3 x 10.5	3.25	0.98		\$230
CNRA2060	59.5 x 3 x 10.5	3.4	1.1		\$245
CNRA2066	65.5 x 3 x 10.5	3.6	1.2		\$270
CNRA2072	71.5 x 3 x 10.5	3.8	1.3		\$299

CNRA2430	29 x 2.75 x 11.75	2.8	0.5		\$123
CNRA2436	35 x 2.75 x 11.75	3.3	0.6		\$145
CNRA2442	41 x 2.75 x 11.75	3.9	0.7		\$172
CNRA2448	47 x 2.75 x 11.75	4.4	0.8		\$196
CNRA2454	53 x 2.75 x 11.75	5	0.9		\$230
CNRA2460	59 x 2.75 x 11.75	5.5	1		\$245
CNRA2466	65 x 2.75 x 11.75	6.1	1.1		\$270
CNRA2472	71 x 2.75 x 11.75	6.6	1.2		\$299

CNRA3036	35 x 2.75 x 11.75	3.3	0.6		\$145
CNRA3042	41 x 2.75 x 11.75	3.9	0.7		\$172
CNRA3048	47 x 2.75 x 11.75	4.4	0.8		\$196
CNRA3054	53 x 2.75 x 11.75	5	0.9		\$230
CNRA3060	59 x 2.75 x 11.75	5.5	1		\$245
CNRA3066	65 x 2.75 x 11.75	6.1	1.1		\$270
CNRA3072	71 x 2.75 x 11.75	6.6	1.2		\$299

CNRA3642	41 x 2.75 x 11.75	3.9	0.7		\$172
CNRA3648	47 x 2.75 x 11.75	4.4	0.8		\$196
CNRA3654	53 x 2.75 x 11.75	5	0.9		\$230
CNRA3660	59 x 2.75 x 11.75	5.5	1		\$245
CNRA3666	65 x 2.75 x 11.75	6.1	1.1		\$270
CNRA3672	71 x 2.75 x 11.75	6.6	1.2		\$299

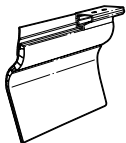

Modesty Panel

For use with **CNR/CNRU rectangular tops**. 11.75" high, Black plastic, attractive ribbed design. Includes two fold-away installation clips and flexible privacy strips. Connects to predrilled holes in table top.

- *Cannot be used when worksurface tops are attached to flip-top legs.*

MODESTY PANELS

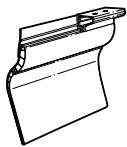

Modesty Panel

MODEL #	DIMENSIONS W x D x H	WT/LB.	CUBIC FT.	LIST PRICE
CNSA2424	23 x 2.75 x 11.75	2.2	0.4	\$96
CNSA3030	29 x 2.75 x 11.75	2.8	0.5	\$123
CNSA3636	35 x 2.75 x 11.75	3.3	0.6	\$145

For use with **long side of CNS square tops**. 11.75" high, Black plastic, attractive ribbed design. Includes two fold-away installation clips and flexible privacy strips. Connects to predrilled holes in table top.

- *Cannot be used when worksurface tops are attached to flip-top legs.*

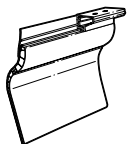

Modesty Panel

CNTA2448L	43 x 2.75 x 11.75	4.4	0.8	\$172
CNTA2460L	55 x 2.75 x 11.75	5.5	1.2	\$230
CNTA3060L	55 x 2.75 x 11.75	5.5	1.2	\$230
CNTA3072L	67 x 2.75 x 11.75	6.6	1.4	\$270
CNTA3660L	55 x 2.75 x 11.75	5.5	1.2	\$230
CNTA3672L	67 x 2.75 x 11.75	6.6	1.4	\$270

For use with **long side of CNT trapezoid tops**. 11.75" high, Black plastic, attractive ribbed design. Includes two fold-away installation clips and flexible privacy strips. Connects to predrilled holes in table top.

- *Cannot be used when worksurface tops are attached to flip-top legs.*

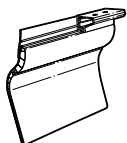

Modesty Panel

CNTA2448S	23 x 2.75 x 11.75	2.2	0.4	\$96
CNTA2460S	35 x 2.75 x 11.75	2.2	0.4	\$145
CNTA3060S	29 x 2.75 x 11.75	2.8	0.5	\$123
CNTA3072S	41 x 2.75 x 11.75	2.8	0.5	\$172
CNTA3660S	23 x 2.75 x 11.75	3.3	0.6	\$96
CNTA3672S	35 x 2.75 x 11.75	3.3	0.6	\$145

For use with **short side of CNT trapezoid tops**. 11.75" high, Black plastic, attractive ribbed design. Includes two fold-away installation clips and flexible privacy strips. Connects to predrilled holes in table top.

- *Cannot be used when worksurface tops are attached to flip-top legs.*

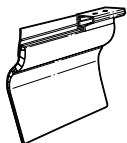

Modesty Panel

CNWA2424	17 x 2.75 x 11.75	2.2	0.4	\$75
CNWA3030	22 x 2.75 x 11.75	2.8	0.5	\$96

For use with **CNW wedge tops**. 11.75" high, Black plastic, attractive ribbed design. Includes two fold-away installation clips and flexible privacy strips. Connects to predrilled holes in table top.

- *Cannot be used when worksurface tops are attached to flip-top legs.*

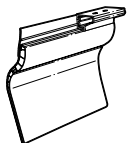

Modesty Panel

CNYA2424	22 x 2.75 x 11.75	2.2	0.4	\$96
CNYA3030	27 x 2.75 x 11.75	2.8	0.5	\$123

For use with **CNY triangle tops**. 11.75" high, Black plastic, attractive ribbed design. Includes two fold-away installation clips and flexible privacy strips. Connects to predrilled holes in table top.

- *Cannot be used when worksurface tops are attached to flip-top legs.*

WIRE MANAGEMENT UNITS

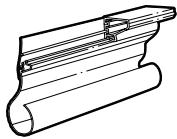

Wire Management Unit

MODEL #	DIMENSIONS	WT/LB.	CUBIC FT.	LIST PRICE
	W x D x H			
CNCB2430	35 x 2.75 x 6	1.5	0.5	\$108
CNCB3036	43 x 2.75 x 6	1.8	0.6	\$120
CNCB3642	53 x 2.75 x 6	2.1	0.7	\$161

For use with **CNC crescent tops**. 6" high, Black plastic, attractive ribbed design. Includes two fold-away installation clips and flexible privacy strips. Connects to predrilled holes in table top. Can be used with or without wire management grommet.

- *Cannot be used when worksurface tops are attached to flip-top legs.*

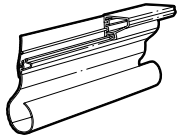

Wire Management Unit

CNOB2424	27 x 2.75 x 6	1.2	0.4	\$88
CNOB3030	35 x 2.75 x 6	1.5	0.5	\$108
CNOB3636	44 x 2.75 x 6	1.8	0.6	\$120

For use with **CNO quarter round tops**. 6" high, Black plastic, attractive ribbed design. Includes two fold-away installation clips and flexible privacy strips. Connects to predrilled holes in table top. Can be used with or without wire management grommet.

- *Cannot be used when worksurface tops are attached to flip-top legs.*

CNRB2430	29 x 2.75 x 6	1.5	0.5	\$88
CNRB2436	35 x 2.75 x 6	1.8	0.6	\$108
CNRB2442	41 x 2.75 x 6	2.1	0.7	\$120
CNRB2448	47 x 2.75 x 6	2.4	0.8	\$142
CNRB2454	53 x 2.75 x 6	2.7	0.9	\$161
CNRB2460	59 x 2.75 x 6	3	1	\$177
CNRB2466	65 x 2.75 x 6	3.3	1.1	\$177
CNRB2472	71 x 2.75 x 6	3.6	1.2	\$245

CNRB3036	35 x 2.75 x 6	1.8	0.6	\$108
CNRB3042	41 x 2.75 x 6	2.1	0.7	\$120
CNRB3048	47 x 2.75 x 6	2.4	0.8	\$142
CNRB3054	53 x 2.75 x 6	2.7	0.9	\$161
CNRB3060	59 x 2.75 x 6	3	1	\$177
CNRB3066	65 x 2.75 x 6	3.3	1.1	\$177
CNRB3072	71 x 2.75 x 6	3.6	1.2	\$245

CNRB3642	41 x 2.75 x 6	2.1	0.7	\$120
CNRB3648	47 x 2.75 x 6	2.4	0.8	\$142
CNRB3654	53 x 2.75 x 6	2.7	0.9	\$161
CNRB3660	59 x 2.75 x 6	3	1	\$177
CNRB3666	65 x 2.75 x 6	3.3	1.1	\$177
CNRB3672	71 x 2.75 x 6	3.6	1.2	\$245

For use with **CNR/CNRU rectangular tops**. 6" high, Black plastic, attractive ribbed design. Includes two fold-away installation clips and flexible privacy strips. Connects to predrilled holes in table top. Can be used with or without wire management grommet.

- *Cannot be used when worksurface tops are attached to flip-top legs.*

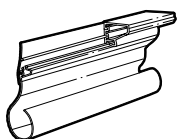

Wire Management Unit

C CONNECTABLES®

WIRE MANAGEMENT UNITS

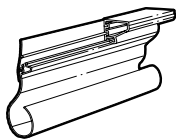

Wire Management Unit

MODEL #	DIMENSIONS W x D x H	WT/LB.	CUBIC FT.	LIST PRICE
CNSB2424	23 x 2.75 x 6	1.8	0.4	\$72
CNSB3030	29 x 2.75 x 6	1.5	0.5	\$88
CNSB3636	35 x 2.75 x 6	1.8	0.6	\$108

For use with **CNS square tops**. 6" high, Black plastic, attractive ribbed design. Includes two fold-away installation clips and flexible privacy strips. Connects to predrilled holes in table top. Can be used with or without wire management grommet.

- *Cannot be used when worksurface tops are attached to flip-top legs.*

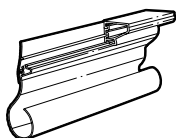

Wire Management Unit

CNTB2448L	43 x 2.75 x 6	2.4	0.8	\$120
CNTB2460L	55 x 2.75 x 6	3	1	\$161
CNTB3060L	55 x 2.75 x 6	3	1	\$161
CNTB3072L	67 x 2.75 x 6	3.6	1.2	\$230
CNTB3660L	55 x 2.75 x 6	3	1	\$161
CNTB3672L	67 x 2.75 x 6	3.6	1.2	\$230

For use with **long side of CNT trapezoid tops**. 6" high, Black plastic, attractive ribbed design. Includes two fold-away installation clips and flexible privacy strips. Connects to predrilled holes in table top. Can be used with or without wire management grommet.

- *Cannot be used when worksurface tops are attached to flip-top legs.*

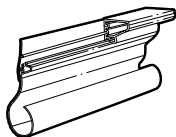

Wire Management Unit

CNTB2448S	23 x 2.75 x 6	1.2	0.4	\$72
CNTB2460S	35 x 2.75 x 6	1.2	0.4	\$108
CNTB3060S	29 x 2.75 x 6	1.5	0.5	\$88
CNTB3072S	41 x 2.75 x 6	1.5	0.5	\$120
CNTB3660S	23 x 2.75 x 6	1.8	0.6	\$72
CNTB3672S	35 x 2.75 x 6	1.8	0.6	\$108

For use with **short side of CNT trapezoid tops**. 6" high, Black plastic, attractive ribbed design. Includes two fold-away installation clips and flexible privacy strips. Connects to predrilled holes in table top. Can be used with or without wire management grommet.

- *Cannot be used when worksurface tops are attached to flip-top legs.*

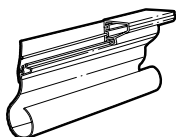

Wire Management Unit

CNWB2424	17 x 2.75 x 6	1.2	0.4	\$57
CNWB3030	22 x 2.75 x 6	1.5	0.5	\$72

For use with **CNW wedge tops**. 6" high, Black plastic, attractive ribbed design. Includes two fold-away installation clips and flexible privacy strips. Connects to predrilled holes in table top. Can be used with or without wire management grommet.

- *Cannot be used when worksurface tops are attached to flip-top legs.*

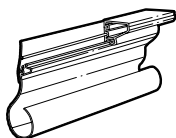

Wire Management Unit

CNYB2424	22 x 2.75 x 6	1.2	0.4	\$72
CNYB3030	27 x 2.75 x 6	1.5	0.5	\$88

For use with **CNY triangle tops**. 6" high, Black plastic, attractive ribbed design. Includes two fold-away installation clips and flexible privacy strips. Connects to predrilled holes in table top. Can be used with or without wire management grommet.

- *Cannot be used when worksurface tops are attached to flip-top legs.*

MODESTY PANELS W/WIRE MANAGEMENT

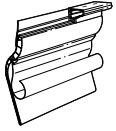

Modesty Panel w/Wire Management

MODEL # DIMENSIONS WT/LB. CUBIC FT. LIST PRICE

W x D x H

CNCC2430	35 x 2.75 x 11.75	4.3	0.5	\$161
CNCC3036	43 x 2.75 x 11.75	5.1	0.6	\$184
CNCC3642	53 x 2.75 x 11.75	6	0.7	\$238

For use with **CNC crescent tops**. 11.75" high, Black plastic, attractive ribbed design. Includes two fold-away installation clips and flexible privacy strips. Connects to predrilled holes in table top. Can be used with or without wire management grommet.

- *Cannot be used when worksurface tops are attached to flip-top legs.*

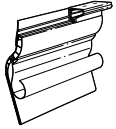

Modesty Panel w/ Wire Management

CNQC2424	27 x 2.75 x 11.75	3.4	0.4	\$133
CNQC3030	35 x 2.75 x 11.75	4.3	0.5	\$161
CNQC3636	44 x 2.75 x 11.75	5.1	0.6	\$184

For use with **CNC quarter round tops**. 11.75" high, Black plastic, attractive ribbed design. Includes two fold-away installation clips and flexible privacy strips. Connects to predrilled holes in table top. Can be used with or without wire management grommet.

- *Cannot be used when worksurface tops are attached to flip-top legs.*

CNRC2030	29.5 x 3 x 10.5	3.75	0.54	\$133
CNRC2036	35.5 x 3 x 10.5	4	0.65	\$161
CNRC2042	41.5 x 3 x 10.5	4.25	0.76	\$184
CNRC2048	47.5 x 3 x 10.5	4.5	0.86	\$213
CNRC2054	53.5 x 3 x 10.5	7.7	0.9	\$238
CNRC2060	59.5 x 3 x 10.5	8.5	1	\$268
CNRC2066	65.5 x 3 x 10.5	5.25	1.2	\$291
CNRC2072	71.5 x 3 x 10.5	5.5	1.3	\$307

CNRC2430	29 x 2.75 x 11.75	4.3	0.5	\$133
CNRC2436	35 x 2.75 x 11.75	5.1	0.6	\$161
CNRC2442	41 x 2.75 x 11.75	6	0.7	\$184
CNRC2448	47 x 2.75 x 11.75	6.8	0.8	\$213
CNRC2454	53 x 2.75 x 11.75	7.7	0.9	\$238
CNRC2460	59 x 2.75 x 11.75	8.5	1	\$268
CNRC2466	65 x 2.75 x 11.75	9.4	1.1	\$291
CNRC2472	71 x 2.75 x 11.75	10.2	1.2	\$307

CNRC3036	35 x 2.75 x 11.75	5.1	0.6	\$161
CNRC3042	41 x 2.75 x 11.75	6	0.7	\$184
CNRC3048	47 x 2.75 x 11.75	6.8	0.8	\$213
CNRC3054	53 x 2.75 x 11.75	7.7	0.9	\$238
CNRC3060	59 x 2.75 x 11.75	8.5	1	\$268
CNRC3066	65 x 2.75 x 11.75	9.4	1.1	\$291
CNRC3072	71 x 2.75 x 11.75	10.2	1.2	\$307

CNRC3642	41 x 2.75 x 11.75	6	0.7	\$184
CNRC3648	47 x 2.75 x 11.75	6.8	0.8	\$213
CNRC3654	53 x 2.75 x 11.75	7.7	0.9	\$238
CNRC3660	59 x 2.75 x 11.75	8.5	1	\$268
CNRC3666	65 x 2.75 x 11.75	9.4	1.1	\$291
CNRC3672	71 x 2.75 x 11.75	10.2	1.2	\$307

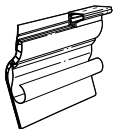

Modesty Panel w/Wire Management

For use with **CNR/CNRU rectangular tops**. 11.75" high, Black plastic, attractive ribbed design. Includes two fold-away installation clips and flexible privacy strips. Connects to predrilled holes in table top. Can be used with or without wire management grommet.

- *Cannot be used when worksurface tops are attached to flip-top legs.*

C CONNECTABLES®

MODESTY PANEL w/WIRE MANAGEMENT

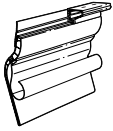

Modesty Panel w/Wire Management

MODEL #	DIMENSIONS W x D x H	WT/LB.	CUBIC FT.	LIST PRICE
CNSC2424	23 x 2.75 x 11.75	3.5	0.4	\$108
CNSC3030	29 x 2.75 x 11.75	4.3	0.5	\$133
CNSC3636	35 x 2.75 x 11.75	5.1	0.6	\$161

For use with **CNC square tops**. 11.75" high, Black plastic, attractive ribbed design. Includes two fold-away installation clips and flexible privacy strips. Connects to predrilled holes in table top. Can be used with or without wire management grommet.

- *Cannot be used when worksurface tops are attached to flip-top legs.*

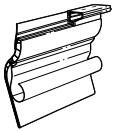

Modesty Panel w/Wire Management

CNTC2048L	43 x 2.75 x 11.75	6.8	0.8	\$184
CNTC2060L	55 x 2.75 x 11.75	8.5	1	\$238
CNTC2448L	43 x 2.75 x 11.75	6.8	0.8	\$184
CNTC2460L	55 x 2.75 x 11.75	8.5	1	\$238
CNTC3060L	55 x 2.75 x 11.75	8.5	1	\$238
CNTC3072L	67 x 2.75 x 11.75	10.2	1.2	\$291
CNTC3660L	55 x 2.75 x 11.75	8.5	1	\$238
CNTC3672L	67 x 2.75 x 11.75	10.2	1.2	\$291

For use with **long side of CNT trapezoid tops**. 11.75" high, Black plastic, attractive ribbed design. Includes two fold-away installation clips and flexible privacy strips. Connects to predrilled holes in table top. Can be used with or without wire management grommet.

- *Cannot be used when worksurface tops are attached to flip-top legs.*

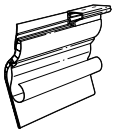

Modesty Panel w/Wire Management

CNTC2048S	23 x 2.75 x 11.75	3.4	0.4	\$108
CNTC2060S	35 x 2.75 x 11.75	3.5	0.5	\$161
CNTC2448S	23 x 2.75 x 11.75	3.4	0.4	\$108
CNTC2460S	35 x 2.75 x 11.75	3.4	0.4	\$161
CNTC3060S	29 x 2.75 x 11.75	4.3	0.5	\$133
CNTC3072S	41 x 2.75 x 11.75	4.3	0.5	\$184
CNTC3660S	23 x 2.75 x 11.75	5.1	0.6	\$108
CNTC3672S	35 x 2.75 x 11.75	5.1	0.6	\$161

For use with **short side of CNT trapezoid tops**. 11.75" high, Black plastic, attractive ribbed design. Includes two fold-away installation clips and flexible privacy strips. Connects to predrilled holes in table top. Can be used with or without wire management grommet.

- *Cannot be used when worksurface tops are attached to flip-top legs.*

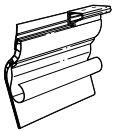

Modesty Panel w/Wire Management

CNWC2424	17 x 2.75 x 11.75	3.4	0.4	\$84
CNWC3030	22 x 2.75 x 11.75	4.3	0.5	\$108

For use with **CNW wedge tops**. 11.75" high, Black plastic, attractive ribbed design. Includes two fold-away installation clips and flexible privacy strips. Connects to predrilled holes in table top. Can be used with or without wire management grommet.

- *Cannot be used when worksurface tops are attached to flip-top legs.*

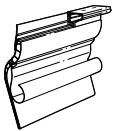

Modesty Panel w/Wire Management

CNYC2424	22 x 2.75 x 11.75	3.4	0.4	\$108
CNYC3030	27 x 2.75 x 11.75	4.3	0.5	\$133

For use with **CNY triangle tops**. 11.75" high, Black plastic, attractive ribbed design. Includes two fold-away installation clips and flexible privacy strips. Connects to predrilled holes in table top. Can be used with or without wire management grommet.

- *Cannot be used when worksurface tops are attached to flip-top legs.*

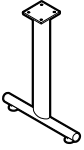
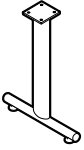
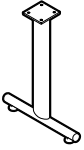
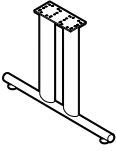
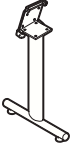
T-LEGS	MODEL #	DIMENSIONS W x D x H	WT/LB.	CUBIC FT.	LIST PRICE
	CNTLEG18	18 x 1.75 x 27.8	9	2.1	\$176
	CNTLEG18P	18 x 1.75 x 27.8	13	2.4	\$354
T-leg	<p>18" long with plastic elliptical column cover, leveling glides and end caps. For assembly with 20" tops.</p> <ul style="list-style-type: none"> • For a single leg, order CNTLEG18. For a pair of legs (set of 2), order CNTLEG18P. • Chrome (CHM) is available (on foot only). Add \$74 list for model CNTLEG18. Add \$148 list for model CNTLEG18P. • Depth dimension reflects the T-leg bottom tube diameter. 				
	CNTLEG24	20 x 1.75 x 27.8	9	2.1	\$176
	CNTLEG24P	20 x 1.75 x 27.8	17	2.4	\$354
T-leg	<p>20" long with plastic elliptical column cover, leveling glides and end caps. For assembly with 24" tops.</p> <ul style="list-style-type: none"> • For a single leg, order CNTLEG24. For a pair of legs (set of 2), order CNTLEG24P. • Chrome (CHM) is available (on foot only). Add \$74 list for model CNTLEG24. Add \$148 list for model CNTLEG24P. • Depth dimension reflects the T-leg bottom tube diameter. 				
	CNTLEG30	26 x 1.75 x 27.8	10	2.6	\$195
	CNTLEG30P	26 x 1.75 x 27.8	19	3	\$388
T-leg	<p>26" long with plastic elliptical column cover, leveling glides and end caps. For assembly with 30" tops.</p> <ul style="list-style-type: none"> • For a single leg, order CNTLEG30. For a pair of legs (set of 2), order CNTLEG30P. • Chrome (CHM) is available (on foot only). Add \$74 list for model CNTLEG30. Add \$148 list for model CNTLEG30P. • Depth dimension reflects the T-leg bottom tube diameter. 				
	CNTLEG36	32 x 1.75 x 27.8	14	3.3	\$376
Dual Post T-leg	<p>32" long with double post plastic elliptical column cover, leveling glides and end caps. For assembly with 36" tops.</p> <ul style="list-style-type: none"> • For a single leg. • Chrome (CHM) is available (on foot only). Add \$74 list. • Depth dimension reflects the T-leg bottom tube diameter. 				
	CNTFLEG24	20 x 1.75 x 28	10	2.4	\$311
	CNTFLG24P	20 x 1.75 x 28	20	2.1	\$621
Flip-Top T-leg*	<p>20" long with plastic elliptical column cover, leveling glides and end caps. For assembly with 24" deep rectangular and square tops only. Hinged plate with locking mechanism to lock in open or closed position. Cannot be installed with thumbscrews.</p> <ul style="list-style-type: none"> • Cannot be used when modesty panels and wire management are attached to worksurface tops. • For a single leg, order CNTFLEG24. For a pair of legs (set of 2), order CNTFLG24P. • Chrome (CHM) is available (on foot only). Add \$74 list for model CNTFLEG24. Add \$148 list for model CNTFLG24P. • Depth dimension reflects the T-leg bottom tube diameter. 				

Required specifications

Leg finish

C CONNECTABLES®

ACCESSORIES	MODEL #	DIMENSIONS	WT/LB.	CUBIC FT.	LIST PRICE
-------------	---------	------------	--------	-----------	------------



Flip-Top T-leg*

	W x D x H			
CNTFLEG30	26 x 1.75 x 28	14	3	\$323
CNTFLG30P	26 x 1.75 x 28	28	6	\$647

26" long with plastic elliptical column cover, leveling glides and end caps. **For assembly with 30" deep rectangular and square tops only.** Hinged plate with locking mechanism to lock in open or closed position. Cannot be installed with thumbscrews.

- Cannot be used when modesty panels and wire management are attached to worksurface tops.
- For a single leg, order **CNTFLEG30**. For a pair of legs (set of 2), order **CNTFLG30P**.
- Chrome (**CHM**) is available (on foot only). **Add \$74** list for model CNTFLEG30. **Add \$148** list for model CNTFLG30P.
- Depth dimension reflects the T-leg bottom tube diameter

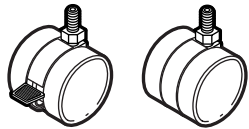

Casters

CNCP	- x - x 1.5	-	-	\$30
------	-------------	---	---	-------------

Set of 2 - 1.5" dual wheel casters, one locking. Suggested for hard floor surfaces and industrial carpeting. Not suitable for hardwood floors. Casters are fully interchangeable with glides. Black only.

- For use with *ConnectTABLES* units only.
- Casters **DO NOT** affect table height.



Thumbscrews

CNTS	1.25 x 1.25 x 1.5	0.04	0.02	\$20
------	-------------------	------	------	-------------

Triangular thumbscrew with 0.75" steel thread. **Set of 4.** Can be used in place of factory supplied screws to allow installation of T-legs to tops without tools. Black only.

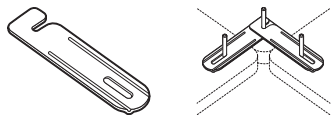

Ganging Connector

CNGFP	2.5 x 5 x 1.13	0.2	0.1	\$33
-------	----------------	-----	-----	-------------

Black epoxy coated 13 gauge steel with two thumbscrews included. Used to connect table tops together for additional stability or for connecting freestanding tops together. Holes with steel inserts are located in the corner of all tops to accommodate this plate. **Sold individually.**

Required specifications

Leg finish*

DUET™ STACKING TABLES



Duet tables are multi-purpose high density stacking tables that offer optimum space utilization and flexibility. Their personality and simple design make them ideal for use in any learning or training environment at post-secondary and adult levels. Temporarily and easily convert auditoriums and other spaces into examination and seminar spaces. They can be partnered with stacking chairs such as Duet or Popcorn in matching or complementary colors (stacking chairs can be found in the Multi-Purpose section of the Seating price list).

The one-piece molded top and modesty are gently contoured providing an eased edge with an elegant waterfall transition from top to modesty.

Tops are available in a wide array of colors in 0.5" thick polypropylene. Polypropylene material offers strength and ease of cleaning with a slightly textured surface to offer scratch resistance.

Features and Benefits

- One-piece molded top and modesty are 0.5" thick polypropylene.
- Tables are rated 250 lbs. capacity.
- Surface includes factory installed metal inserts for solid and secure connection to the sled base.
- 0.5" diameter solid steel rod sled base frame.
- Bumpers on the underside for protection when stacking.
- Model with ADA width compliant base is available.
- Shipped fully assembled.



One-piece top and modesty.



Stacks 5 high on floor or 20 high on dolly.



Ganging base to keep tables evenly aligned.

GENERAL INFORMATION

- Duet tables are high density multi-purpose stacking tables ideal for auditoriums, seminars or any learning or training environment.
- Lightweight and easy to handle whether stacking for storage or setting up a room.
- Made of durable materials to withstand more demanding environments.
- Shipped fully assembled. Packaged 4 per carton.
- For environmental certifications, please visit globalfurnituregroup.com.
- Covered by Global's Lifetime Warranty.

WORKSURFACES

- Top and modesty are a one-piece injection molded design in 0.5" thick polypropylene.
- Available in a wide array of colors (see right column "FINISHES") to complement any space or to define sections by color.
- One-piece molded top and modesty are contoured providing an eased user edge, with an elegant waterfall transition from top to modesty.

26"W x 18"D x 9.75"H

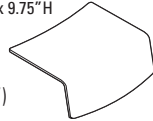

CONSTRUCTION

- Surface includes molded in threaded inserts to provide a secure metal-to-metal connection to the sled base.
- Bumpers are included on the underside of top and inside modesty to protect surfaces when stacking.

BASE

- 0.5" diameter solid steel rod sled base frame.
- Available in a durable Chrome finish.
- Model with ganging frame keeps tables evenly positioned and aligned. No tools or fasteners required for ganging; the bases simply interlock.
- Model with ADA compliant base is also available. The frame is 33" wide and the polypropylene top/modesty remain a constant size.
- Tables are standard without glides and are suitable for carpet, rubber or cork flooring.
- Glide options are available (see right column "GLIDES"). Glides must be chosen to best suit flooring type and site conditions. Upcharges apply.

DOLLY

- For space saving storage and transport.
- Constructed from 1.5" x 0.5" steel tubing with heavy duty casters (two locking) and a removable handle.
- Dolly can stack up to 20 tables.
- Stacking height on dolly is up to 68".

FINISHES

BZB	Buzz Blue	FRO	Frost
CCT	Cactus	INK	Ink
CRO	Carrot	LAB	Latte
IVC	Cloud	BLK	Night
DJN	Dijon	SND	Sand
EGP	Eggplant	SAR	Scarlet
FOG	Fog	SHW	Shadow

GLIDES

CG	Clear polycarbonate (for carpet, rubber or concrete flooring). Height added to table: 0.18". Add \$9/set.
SG	Glides with stainless steel pads (for carpet or rubber flooring). Height added to table: 0.17". Add \$19/set.
FG	Glides with felt pads (for vinyl, cork or laminate flooring). Height added to table: 0.24". Add \$19/set.
RG	Glides with rubber pads (for vinyl, hardwood, laminate, stone or ceramic flooring). Height added to table: 0.16". Add \$19/set.

SPECIFICATIONS

- Specifications marked with an * are applicable to only those products which have the* symbol beside the product name.

EXAMPLE DUET TABLE ORDER CODE:

Duet stacking table, polypropylene surface in Shadow, clear polycarbonate glides

DTS1828P	-SHW	-CG
Model #	Surface finish	Glides

STACKING TABLES **MODEL #** **DIMENSIONS** **WT/LB.** **CUBIC FT.** **LIST PRICE**

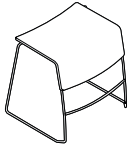

Stacking Table*

	W x D x H			
DTS1828P	29 x 25 x 28	23	23	\$469

One-piece polypropylene top and modesty with Chrome base. Dimensions listed include frame footprint, 26"W x 18"D top and 9.75"H modesty. Shipped fully assembled, 4 per carton.

- Price shown is per table. It is recommended to order in multiples of 4.

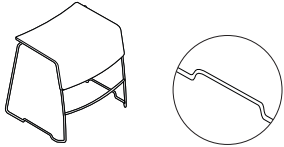

Stacking Table, Ganging Frame*

DTS1828PG	30.75 x 25 x 28	23	23	\$494
-----------	-----------------	----	----	--------------

One-piece polypropylene top and modesty with Chrome ganging base. Dimensions listed include frame footprint, 26"W x 18"D top and 9.75"H modesty. Shipped fully assembled, 4 per carton.

- Price shown is per table. It is recommended to order in multiples of 4.

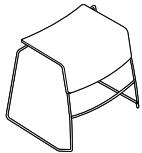

Stacking Table, 32" Wide

DTA1832P	33 x 25 x 28	24	23	\$532
----------	--------------	----	----	--------------

ADA (American with Disabilities Act) compliant. 33" wide. One-piece polypropylene top and modesty with Chrome base. Dimensions listed include frame footprint, 26"W x 18"D top and 9.75"H modesty. Underside clearance is 27.1"H (extra height if glides are selected). Stacks up to 5 high on floor only; dolly does not accommodate. Shipped fully assembled, 4 per carton.

- Price shown is per table. It is recommended to order in multiples of 4.

DOLLY



Dolly

DTD20	29.5 x 63 x 38.5	50	21	\$734
-------	------------------	----	----	--------------

For use with tables DTS1828P and DTS1828PG. Can stack up to 20 tables. Black only. Removable handle for storage. Shipped fully assembled in 1 carton.

Required specifications
Surface finish (not DTD20)

Optional specifications
Glides (not DTD20)

Accessories
Dolly*



Edventure is a value series collection that offers a range of teacher desks, student desks, study carrels and lecterns for more traditional learning environments. Designed to withstand daily rigorous use, traditional style meets modern performance.

Tops are available in a wide array of finishes in 1" thick thermally fused laminate or 1 1/16" high pressure laminate with matching or complementary 2mm PVC edgebanding.

Mobile lecterns and teacher desks offer versatility with storage options for educators on the move.

Single and connecting study carrels create quiet work areas with optional power and data to stay connected.

Features and Benefits

- Tops are 1" thick thermally fused laminate or 1 1/16" high pressure laminate.
- Tops are constructed of 45 lb. density particle board.
- Matching or complementary 2mm PVC edgebanding.
- Surfaces include factory installed metal inserts for solid and secure leg connections.
- H-leg design on teacher and student desks.
- Teacher desk includes modesty panel and is available with or without casters.
- Teacher desk with left or right hand box/box/file pedestal available on casters only.
- Study carrel features curved side panels for seated privacy with a 29"H worksurface.
- Easy to assemble.



H-legs with cross bar.



Mobile teacher desk with modesty panel.

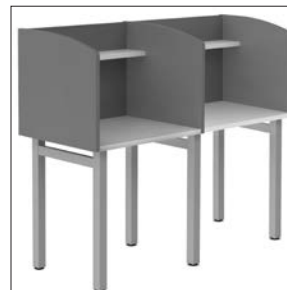

Freestanding and add-on study carrels.

GENERAL INFORMATION

- Edventure series is an affordable collection of teacher desks, student desks, study carrels and lecterns with personal storage options, that bring a traditional element to the classroom.
- Simple and elegant design respects space requirements to accommodate various teaching styles.
- Edventure series is a high achiever, built to withstand the most demanding environments.
- Shipped easy to assemble.
- For environmental certifications, please visit globalfurnituregroup.com.

WORKSURFACES

- Tops are available in 1" thick thermally fused laminate or 1 1/16" thick high pressure laminate.
- Available in an array of finishes (see page 479) in both thermally fused laminate or high pressure laminate. Color palette also includes nine new bold finishes available for high pressure laminate only, a complementary edge finish must be selected.
- Teacher desks are optional with grommets FOG1, FOG2 or FOG3 or cut-outs E1, E2 or E3 for power block PMSDPM ordered separately.
- Teacher desks with box/box/file pedestal are predrilled with pilot holes on the underside for accepting a lectern shelf ENLS182 ordered separately.

CONSTRUCTION

- Top core is made of 45 lb. density particle board.
- Surfaces include factory installed metal inserts for solid and secure leg connections.

EDGE DETAIL

- Global's preferred 2mm PVC edgebanding is standard.
- Edgebanding may be specified in a matching or a complementary finish for tops in standard Global laminates.

LEGS

- H-legs are 28" high and constructed from 2" x 2" square tubing with a 1" x 2" rectangular cross bar and adjustable leveling glides.
- Available in Black (TBL), Buzz Blue (TBZ), Cactus (TCC), Carrot (TCR), Cloud (TIV), Designer White (TDW), Dijon (TDJ), Eggplant (TEG), Fog (TFO), Frost (TFR), Ink (TIN), Kalua (TKA), Latte (TLA), Mocha (TMO), Nevada (TNE), Sand (TSN), Scarlet (TSR), Shadow (TSH), Toast (TOA) or Tungsten (TTU) paint finishes, Sandtex finish applied.

CASTERS

- Teacher desks and lecterns are available with locking casters. See models ending in C.
- Casters are 3 1/2" high overall.

MODESTY PANELS

- 12"H modesty panel is included with teacher desks.
- Available in an array of finishes (see page 477) in thermally fused laminate with matching edge only.

STORAGE LECTERNS

- The steel storage lectern features integrated full pulls and a full welded seamless top for added strength and crisp appearance.
- Drawer and door fronts have welded reinforcements for additional strength.
- Available in three configurations, offering multiple storage options for storing personal items or keeping active files and resource materials close at hand.
- Removable cam locks are standard.
- Storage lecterns are supported by 2" x 2" x 3 1/2"H square tube legs on leveling glides or 3 1/2"H industrial size casters.
- Finished laminate tops to complement desking are available. See model ENMST1824.
- An optional lectern shelf offers a perfect platform for keeping presentation materials organized and at the presenter's fingertips. See model ENLS182.

SPECIFICATIONS

- Specifications marked with an * are applicable to only those products which have the* symbol beside the product name.

STUDY CARRELS

- The study carrel features a 29" high worksurface and curved side panels for privacy.
- Freestanding (starter) and add-on models are available. Legs and privacy panels are shared between adjoining add-on carrels.
- The back panel is inset to hide connecting fasteners from user's view. The inset back also creates a wire drop for the optional LED task light cord.
- Carrels with an optional shelf are available. See models ending in S.
- Optional LED task light is available for carrel with shelf, see page 421
- Optional Cove Daisylink system is available to bring power, USB charging or data to the carrel surface for desktop access, see pages 422-423

COVE DAISYLINK COMPONENTS

- A daisy-chainable power solution with a unique "no particular order" feature, making installation or reconfiguration easy.
- Cove Daisylink modules must be ordered separately and are available for study carrels only.
- You must specify the cut-out for Cove Daisylink modules when ordering the study carrels. Specify (CV). Order the Cove kits (modules and jumpers) and infeed separately.
- 29", 30", 35" and 36" study carrels have **one** optional cut-out. **Add \$91.**
- 59", 60", 71" and 72" study carrels have **two** optional cut-outs. **Add \$185.**
- For Cove Daisylink components, see pages 422-423.
- Maximum of 9 Cove modules per each infeed.

GROMMETS

- Optional grommets are available in standard worksurface locations (left, center or right) **for teacher desks.** Order as: **FOG1, FOG2 or FOG3. Add \$91.**
- Grommet hole dimensions are 3.25" wide x 1.875" deep.



POWER BLOCK

- An individual corded power block is a rectangular worksurface power/data module with one electrical duplex receptacle and two data (RJ45) receptacles. 9' Black cord included. Power block dimensions are 6.5"W x 3.5"D x 2.75"H. Units cannot be daisy-chained.

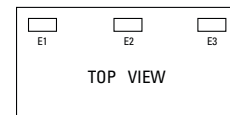

Power block **PMSDPM. Add \$268.** Specify location **E1, E2 or E3. Add \$91.**

MODPOWER DAISY-CHAIN SOLUTION

- Add flexible power and USB charging to Edventure study carrels. Connect up to four units with a single corded infeed with NEMA plug.
- ModPower units are sold separately, refer to Productivity Solutions page 473.
- Begin run with a starter unit which includes a corded infeed. Add additional middle or end units as required. Middle and end units are equipped with connecting cables.
- On-surface modules clamp on or screw mount to the table tops.
- In-surface modules require table top cut-outs for mounting:
 - Specify cut-out option **MPS** for a single cut-out to accommodate one ModPower in-surface unit (cut-out will be centered on the back edge of surface) for **29" to 72" wide study carrels. Add \$91.**
 - Specify cut-out option **MPD** for two cut-outs in the left and right positions, 15" from ends to center of unit on the back edge of surface for **59" to 72" wide study carrels. Add \$183.**

FINISHES

Thermally Fused or High Pressure Laminate Tops

ACJ Absolute Acajou	FCL First Class
ASN Asian Night	NBL Noce Biondo
AWC Avant Cherry	NGL Noce Grigio
AWH Avant Honey	NEL Noce Leggero
BLK Black	NML Noce Medio
BZD Blizzard	QTM Quartered Mahogany
BRC Brushed Cobalt	SBY Sheer Beauty
CMB Clear Maple	SDT Stonedust
CGY Custom Grey	SOG Storm Grey
DES Dark Espresso	WHE Walnut Heights
DWT Designer White	WHC White Chocolate
FAS Fashionista	WCR Winter Cherry

2mm Thick Edgebanding

AAE Absolute Acajou	FCL First Class
ASE Asian Night	FOG Fog
ACE Avant Cherry	LAB Latte
AHE Avant Honey	NBL Noce Biondo
BLK Black	NGL Noce Grigio
BZD Blizzard	NEL Noce Leggero
BRC Brushed Cobalt	NML Noce Medio
BZB Buzz Blue	QTM Quarter Mahogany
CCT Cactus	SAR Scarlet
CRO Carrot	SHW Shadow
CME Clear Maple	SBY Sheer Beauty
CGY Custom Grey	SDT Stonedust
DEE Dark Espresso	SOG Storm Grey
DWE Designer White	WHE Walnut Heights
DJN Dijo	CBE White Chocolate
FAS Fashionista	WCE Winter Cherry

Leg finishes

TBL Black	TIN Ink
TBZ Buzz Blue	TKA Kalua
TCC Cactus	TLA Latte
TCR Carrot	TMO Mocha
TIV Cloud	TNE Nevada
TDW Designer White	TSN Sand
TDJ Dijon	TSR Scarlet
TEG Eggplant	TSH Shadow
TFO Fog	TOA Toast
TFR Frost	TTU Tungsten

Paint Finishes for Metal Storage Lecterns

BLK Black	MET Metro
BKC Black Coffee*	MCH Mocha*
BZD Blizzard*	MOS Moss
BNE Bone	NAV Navy
BGR Business Grey	NEV Nevada
CHR Charcoal	OYS Oyster
CLT Claret	SKY Sky
DCH Dark Chocolate*	SIL Silver
DPT Desert Putty	STN Stone
DWT Designer White	SDT Stonedust*
FOG Fog	SGR Storm Grey
GRY Grey	TSA Tahiti Sand
ICE Ice	TPE Taupe
IVR Ivory	TUN Tungsten (add 10% upcharge)
LGR Light Grey	

*textured finishes

Note: Modesty panel and lectern shelf are available in thermally fused laminate finishes only. Modesty panel and pedestal edging will match thermally fused laminate finish specified.

TO SPECIFY:

1. SPECIFY MODEL NUMBER

2. SPECIFY THE FOLLOWING:

FOR TEACHER AND STUDENT DESKS:

- Top finish
- Optional HP laminate
- Edge finish (top only)
- Modesty finish if applicable
- Pedestal finish if applicable
- Leg finish
- Optional FOG grommet or cut-out for PMSDPM, if applicable
- Optional key alike or select number (#100-120) applicable on teacher desks with pedestal

FOR STORAGE LECTERNS:

- Case paint finish
- Optional key alike

FOR STUDY CARRELS:

- Top surface finish (shelf, if applicable, will be in the same finish)
- Optional HP laminate
- Edge finish
- Leg finish
- Surround finish (side and back panels)
- Optional cut-out(s) for Cove Daisylink components

EXAMPLE EDVENTURE ORDER CODES:

Teacher desk

ENTD7230	-ACJ	-HPL	-AAE	-TTU	-DWT
Model #	Top finish	High pressure laminate	Edge finish	Leg finish	Modesty panel finish

Storage lectern

EL18LPBF	-DWT	-KA
Model #	Case finish	Key alike

Study carrel

ENFC3024	-ACJ	-HPL	-AAE	-TTU	-DWT	-CV
Model #	Top finish	High pressure laminate	Top edge finish	Leg finish	Surround finish	Cut-out for Cove

TEACHER DESKS **MODEL #** **DIMENSIONS** **WT/LB.** **CUBIC FT.** **LIST PRICE** **HP ADD**

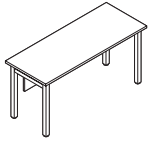

Teacher Desk, 24" Deep*

W x D x H						
ENTD4824	48 x 24 x 29	74	4.6	\$912	\$152	
ENTD5424	54 x 24 x 29	80	4.7	\$922	\$173	
ENTD6024	60 x 24 x 29	86	4.9	\$935	\$186	

12"H modesty panel included. Shipped easy to assemble in 2 cartons.

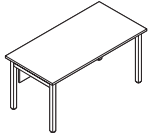

Teacher Desk, 30" Deep*

ENTD6030	60 x 30 x 29	96	6.4	\$993	\$202
ENTD6630	66 x 30 x 29	103	6.6	\$1032	\$249
ENTD7230	72 x 30 x 29	110	6.8	\$1064	\$263

12"H modesty panel included. Shipped easy to assemble in 2 cartons.

MOBILE TEACHER DESKS

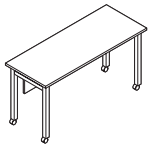

Mobile Teacher Desk, 24" Deep*

ENTD4824C	48 x 24 x 29	75	4.6	\$1059	\$152
ENTD5424C	54 x 24 x 29	81	4.7	\$1069	\$173
ENTD6024C	60 x 24 x 29	87	4.9	\$1082	\$186

12"H modesty panel included. Shipped easy to assemble in 2 cartons.

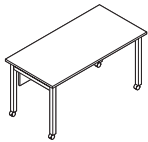

Mobile Teacher Desk, 30" Deep*

ENTD6030C	60 x 30 x 29	98	5.4	\$1142	\$202
-----------	--------------	----	-----	---------------	--------------

12"H modesty panel included. Shipped easy to assemble in 2 cartons.

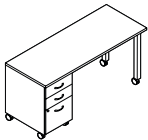

Mobile Teacher Desk w/Single Pedestal, 24" Deep - LEFT*

ET6024BBFLC	60 x 24 x 29	155	12.4	\$1872	\$186
ET6624BBFLC	66 x 24 x 29	161	12.6	\$1909	\$215
ET7224BBFLC	72 x 24 x 29	167	12.8	\$1943	\$244

Flush **left** hand locking box/box/file pedestal (top box drawer is non-locking) and 12"H modesty panel included. Top is predrilled above the pedestal on the underside for the addition of lectern shelf ENLS182 (sold separately). Shipped easy to assemble in 3 cartons (pedestal is fully assembled).

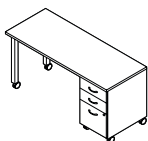

Mobile Teacher Desk w/Single Pedestal, 24" Deep - RIGHT*

ET6024BBFRC	60 x 24 x 29	155	12.4	\$1872	\$186
ET6624BBFRC	66 x 24 x 29	161	12.6	\$1909	\$215
ET7224BBFRC	72 x 24 x 29	167	12.8	\$1943	\$244

Flush **right** hand locking box/box/file pedestal (top box drawer is non-locking) and 12"H modesty panel included. Top is predrilled above the pedestal on the underside for the addition of lectern shelf ENLS182 (sold separately). Shipped easy to assemble in 3 cartons (pedestal is fully assembled).

Required specifications

Top finish Modesty finish
Leg finish Pedestal finish*
Edge finish

Optional specifications

HP laminate
FOG grommet or cut-out for PMSPDM
Key alike/Key #*

Accessories

Lectern shelf*

MOBILE TEACHER DESKS

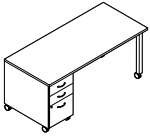

Mobile Teacher Desk w/Single Pedestal, 30" Deep - LEFT*

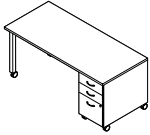

Mobile Teacher Desk w/Single Pedestal, 30" Deep - RIGHT*

MODEL #	DIMENSIONS W x D x H	WT/LB.	CUBIC FT.	LIST PRICE	HP ADD
ET6030BBFLC	60 x 30 x 29	193	14.7	\$1980	\$202
ET6630BBFLC	66 x 30 x 29	201	14.9	\$2017	\$249
ET7230BBFLC	72 x 30 x 29	210	15.1	\$2050	\$263

Flush **left** hand locking box/box/file pedestal (top box drawer is non-locking) and 12"H modesty panel included. Top is predrilled above the pedestal on the underside for the addition of lectern shelf ENLS182 (sold separately). Shipped easy to assemble in 3 cartons (pedestal is fully assembled).

ET6030BBFRC	60 x 30 x 29	193	14.7	\$1980	\$202
ET6630BBFRC	66 x 30 x 29	201	14.9	\$2017	\$249
ET7230BBFRC	72 x 30 x 29	210	15.1	\$2050	\$263

Flush **right** hand locking box/box/file pedestal (top box drawer is non-locking) and 12"H modesty panel included. Top is predrilled above the pedestal on the underside for the addition of lectern shelf ENLS182 (sold separately). Shipped easy to assemble in 3 cartons (pedestal is fully assembled).

STUDENT DESKS

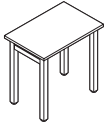

Student Desk**

ENST3020	30 x 20 x 29	49	3.9	\$461	\$106
----------	--------------	----	-----	--------------	--------------

Shipped easy to assemble in 2 cartons.

Required specifications





Top finish Modesty finish*
Leg finish Pedestal finish*

Optional specifications

HP laminate (teacher and student desks)
FOG grommet or cut-out for PMSPDM*
Key alike/Key #*

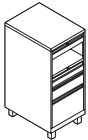
Accessories

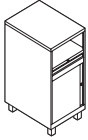
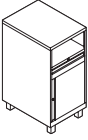
Lectern shelf*
Book box**

STORAGE LECTERNS		MODEL #	DIMENSIONS	WT/LB.	CUBIC FT.	LIST PRICE
 <p>Storage Lectern w/Laptop Drawer*</p>			W x D x H			
		EL18LPBF	18 x 24 x 38	148	11.7	\$3138
		Locking laptop drawer, open shelf, locking personal drawer, box drawer and file drawer. Cord escape on backside for laptop charging. 3 1/2" high metal legs with leveling glides. Shipped assembled in 1 carton.				
 <p>Storage Lectern - Box/File*</p>		EL18PBF	18 x 24 x 38	145	11.7	\$2654
		Open shelf, locking personal drawer, box drawer and file drawer. 3 1/2" high metal legs with leveling glides. Shipped assembled in 1 carton.				
 <p>Storage Lectern*</p>		EL18PHDL	18 x 24 x 38	128	11.7	\$2654
		Open shelf, locking personal drawer and left side hinged locking door with shelf inside. 3 1/2" high metal legs with leveling glides. Shipped assembled in 1 carton.				
 <p>Storage Lectern*</p>		EL18PHDR	18 x 24 x 38	128	11.7	\$2654
		Open shelf, locking personal drawer and right side hinged locking door with shelf inside. 3 1/2" high metal legs with leveling glides. Shipped assembled in 1 carton.				
MOBILE STORAGE LECTERNS						
 <p>Mobile Storage Lectern w/Laptop Drawer</p>		EL18LPBFC	18 x 24 x 38	148	11.7	\$3273
		Mobile, locking laptop drawer, open shelf, locking personal drawer, box drawer, file drawer, on four locking casters. Cord escape on back side for laptop charging. Shipped assembled in 1 carton.				
 <p>Mobile Storage Lectern - Box/File</p>		EL18PBFC	18 x 24 x 38	145	11.7	\$2787
		Mobile, open shelf, locking personal drawer, box drawer, file drawer, on four locking casters. Shipped assembled in 1 carton.				

Required specifications
 Paint finish, case
 Trim finish, feet*

Optional specifications
 Key alike

Accessories
 Laminate top
 Lectern shelf

MOBILE STORAGE LECTERNS

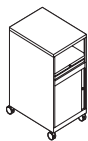

Mobile Storage Lectern*

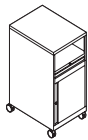

Mobile Storage Lectern*

MODEL #	DIMENSIONS W x D x H	WT/LB.	CUBIC FT.	LIST PRICE	HP ADD
EL18PHDLC	18 x 24 x 38	128	11.7	\$2787	N/A

Mobile, open shelf, locking personal drawer, **left** side hinged locking door with shelf inside, on four locking casters. Shipped assembled in 1 carton.

EL18PHDRC	18 x 24 x 38	128	11.7	\$2787	N/A
-----------	--------------	-----	------	---------------	-----

Mobile, open shelf, locking personal drawer, **right** side hinged locking door with shelf inside, on four locking casters. Shipped assembled in 1 carton.

ACCESSORIES

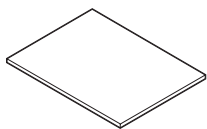

Top for Storage Lectern**

ENMST1824	18 x 24 x 1	10.5	0.27	\$183	\$84
-----------	-------------	------	------	--------------	-------------

Finished laminate top for storage lecterns. Available in an array of thermally fused laminate or high pressure laminate finishes to complement deskings, see page 479. Shipped in 1 carton.

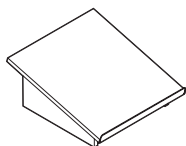

Lectern Shelf**

ENLS182	18 x 21 x 3.25-8.25	19	2.55	\$352	N/A
---------	---------------------	----	------	--------------	-----

Offers the perfect platform for keeping lectern materials at the facilitator's fingertips. May be secured to finished top or left unattached to use elsewhere. Screws provided to secure to finished top from the underside. Shipped assembled in 1 carton.

Required specifications

Painte finish, case*
Laminate finish**
Edge finish (ENMST1824 only)
Trim finish (ENLS182 only)

Optional specifications

Key alike*
HP laminate (ENMST1824 only)

FREESTANDING OR STARTER STUDY CARRELS

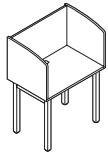

Freestanding/Starter Study Carrel*

MODEL #	DIMENSIONS W x D x H	WT/LB.	CUBIC FT.	LIST PRICE	HP ADD	CUT-OUT ADD
ENFC3024	30 x 24 x 50	89	4.44	\$890	\$107	\$91
ENFC3624	36 x 24 x 50	97.5	4.72	\$942	\$107	\$91
ENFC6024	60 x 24 x 50	115	5.8	\$1097	\$186	\$185
ENFC7224	72 x 24 x 50	123.5	6.34	\$1172	\$213	\$185

Features a 29" high worksurface with curved side privacy panels. Shown with optional cut-out. Bring power and USB charging to the user with Cove Daisylink components, see pages 422-423. Shipped easy to assemble in 2 cartons.

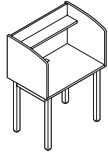

Freestanding/Starter Study Carrel w/Shelf*

ENFC3024S	30 x 24 x 50	93	4.44	\$947	\$107	\$91
ENFC3624S	36 x 24 x 50	102.5	4.72	\$991	\$107	\$91
ENFC6024S	60 x 24 x 50	122	5.8	\$1175	\$186	\$185
ENFC7224S	72 x 24 x 50	131.5	6.34	\$1261	\$186	\$185

Features a 29" high worksurface with curved side privacy panels. Shown with optional cut-out. Shelf is 6" deep and accepts optional LED task light. Bring power and USB charging to the user with Cove Daisylink components, see pages 422-423. Shipped easy to assemble in 2 cartons.

ADD-ON STUDY CARRELS

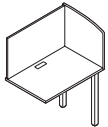

Add-On Study Carrel*

ENAC2924	29 x 24 x 50	63	4.4	\$677	\$107	\$91
ENAC3524	35 x 24 x 50	71.5	4.67	\$704	\$122	\$91
ENAC5924	59 x 24 x 50	89	5.75	\$865	\$186	\$185
ENAC7124	71 x 24 x 50	97.5	6.3	\$939	\$186	\$185

Features a 29" high worksurface with curved side privacy panels. Shown with optional cut-out. Bring power and USB charging to the user with Cove Daisylink components, see pages 422-423. Shipped easy to assemble in 2 cartons.

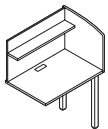

Add-On Study Carrel w/Shelf*

ENAC2924S	29 x 24 x 50	67	4.4	\$710	\$107	\$91
ENAC3524S	35 x 24 x 50	76.5	4.67	\$755	\$107	\$91
ENAC5924S	59 x 24 x 50	96	5.75	\$944	\$186	\$185
ENAC7124S	71 x 24 x 50	105.5	6.3	\$1029	\$186	\$185

Features a 29" high worksurface with curved side privacy panels. Shown with optional cut-out. Shelf is 6" deep and accepts optional LED task light. Bring power and USB charging to the user with Cove Daisylink components, see pages 422-423. Shipped easy to assemble in 2 cartons.

LED TASK LIGHTS

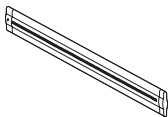

LED Task Light

PLED30	15.5 x 1.5 x 0.5	2	0.5	\$344	N/A	N/A
PLED100	43.5 x 1.5 x 0.5	3	0.5	\$461	N/A	N/A

Energy efficient LED. Ultra slim design. Suitable for mounting on the underside of the shelf of a study carrel. 6' power cord.

Required specifications

- Top finish*
- Edge finish*
- Leg finish*
- Surround finish*

Optional specifications

- HP laminate*
- Cut-out for Cove Daisylink modules*

Accessories

- Cove Daisylink modules*
- LED task lights*

COVE DAISYLINK COMPONENTS

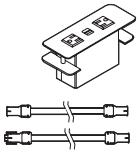

Single Power/USB for 29"/30" Carrels

MODEL #	DIMENSIONS W x D x H	WT/LB.	CUBIC FT.	LIST PRICE
ECV2PU30B	30 x 2 x -	4.5	0.5	\$1010
ECV2PU30S	30 x 2 x -	4.5	0.5	\$1010

Cove single desktop module with two power outlets and two 2.1A USB charging ports. Includes four cable clamps, one 14" female/male connecting cable and one 14" female/female connecting cable. Connecting cables will daisy-chain modules between two 30" wide starter carrels, one 30" wide starter carrel and one 29" wide add-on carrel, or two 29" wide add-on carrels. Available in Black **(B)** or Silver **(S)** - indicated by last letter of the model number. Infeed to be ordered separately.

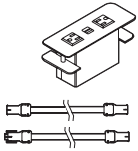

Single Power/USB for 35"/36" Carrels

ECV2PU36B	36 x 2 x -	4.6	0.5	\$1022
ECV2PU36S	36 x 2 x -	4.6	0.5	\$1022

Cove single desktop module includes two power outlets and two 2.1A USB charging ports. Includes four cable clamps, one 17" female/male connecting cable and one 17" female/female connecting cable. Connecting cables will daisy-chain modules between two 36" wide starter carrels, one 36" wide starter carrel and one 35" wide add-on carrel, or two 35" wide add-on carrels. Available in Black **(B)** or Silver **(S)** - indicated by last letter of the model number. Infeed to be ordered separately.

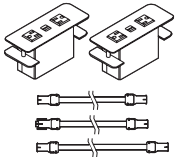

Double Power/USB for 59"/60" Carrels

ECV2PU60B	60 x 2 x -	4.6	0.5	\$1880
ECV2PU60S	60 x 2 x -	4.6	0.5	\$1880

Cove double desktop modules - each module includes two power outlets and two 2.1A USB charging ports. Includes four cable clamps, one 12" female/male connecting cable, one 12" female/female connecting cable and one 26" female/female interconnecting cable. Connecting cables will daisy-chain modules between two 60" wide starter carrels, one 60" wide starter carrel and one 59" wide add-on carrel, or two 59" wide add-on carrels. Available in Black **(B)** or Silver **(S)** - indicated by last letter of the model number.

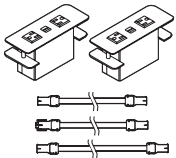

Double Power/USB for 71"/72" Carrels

ECV2PU72B	72 x 2 x -	4.6	0.5	\$1901
ECV2PU72S	72 x 2 x -	4.6	0.5	\$1901

Cove double desktop modules - each module includes two power outlets and two 2.1A USB charging ports. Includes four cable clamps, one 15" female/male connecting cable, one 15" female/female connecting cable and one 31" female/female interconnecting cable. Connecting cables will daisy-chain modules between two 72" wide starter carrels, one 72" wide starter carrel and one 71" wide add-on carrel, or two 71" wide add-on carrels. Available in Black **(B)** or Silver **(S)** - indicated by last letter of the model number.

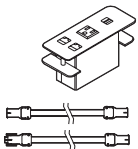

Single Power/Data/USB for 29"/30" Carrels

ECVPUD30B	30 x 2 x -	4.6	0.5	\$955
ECVPUD30S	30 x 2 x -	4.6	0.5	\$955

Cove single desktop module includes one power outlet, two data knockouts and two 2.1A USB charging ports. Includes four cable clamps, one 14" female/male connecting cable and one 14" female/female connecting cable. Data/telecom options to be ordered separately. Connecting cables will daisy-chain modules between two 30" wide starter carrels, one 30" wide starter carrel and one 29" wide add-on carrel, or two 29" wide add-on carrels. Available in Black **(B)** or Silver **(S)** - indicated by last letter of the model number. Infeed to be ordered separately.

COVE DAISYLINK COMPONENTS **MODEL #** **DIMENSIONS** **WT/LB.** **CUBIC FT.** **LIST PRICE**

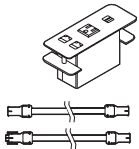

Single Power/Data/USB for 35"/36" Carrels

	W x D x H			
ECVPUD36B	36 x 2 x -	4.6	0.5	\$967
ECVPUD36S	36 x 2 x -	4.6	0.5	\$967

Cove single desktop module includes one power outlet, two data knockouts and two 2.1A USB charging ports. Includes four cable clamps, one 17" female/male connecting cable and one 17" female/female connecting cable. Data/telecom options to be ordered separately. Connecting cables will daisy-chain modules between two 36" wide starter carrels, one 36" wide starter carrel and one 35" wide add-on carrel, or two 35" wide add-on carrels. Available in Black (B) or Silver (S) - indicated by last letter of the model number. Infeed to be ordered separately.

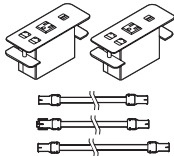

Double Power/Data/USB for 59"/60" Carrels

ECVPUD60B	60 x 2 x -	4.6	0.5	\$1769
ECVPUD60S	60 x 2 x -	4.6	0.5	\$1769

Cove double desktop modules - each module includes one power outlet, two data knockouts and two 2.1A USB charging ports. Includes four cable clamps, one 12" female/male connecting cable, one 12" female/female connecting cable and one 26" female/female interconnecting cable. Data/telecom options to be ordered separately. Connecting cables will daisy-chain modules between two 60" wide starter carrels, one 60" wide starter carrel and one 59" wide add-on carrel, or two 59" wide add-on carrels. Available in Black (B) or Silver (S) - indicated by last letter of the model number. Infeed to be ordered separately.

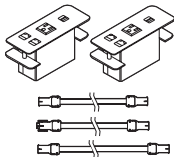

Double Power/Data/USB for 71"/72" Carrels

ECVPUD72B	72 x 2 x -	4.6	0.5	\$1790
ECVPUD72S	72 x 2 x -	4.6	0.5	\$1790

Cove double desktop modules - each module includes one power outlet, two data knockouts and two 2.1A USB charging ports. Includes four cable clamps, one 15" female/male connecting cable, one 15" female/female connecting cable and one 31" female/female interconnecting cable. Data/telecom options to be ordered separately. Connecting cables will daisy-chain modules between two 72" wide starter carrels, one 72" wide starter carrel and one 71" wide add-on carrel, or two 71" wide add-on carrels. Available in Black (B) or Silver (S) - indicated by last letter of the model number. Infeed to be ordered separately.



Single-Circuit Corded Infeed, 72"

ENCOVC1	72"W	3	0.5	\$369
---------	------	---	-----	--------------

72" corded infeed to start a run of Cove Daisylink modules. Maximum of 9 Cove modules per each infeed (Cove double counts as two modules).



Multi-Circuit Power Hardware Infeed, 72"

ENCOVHW1	72"W	2.75	0.5	\$238
----------	------	------	-----	--------------

Hardware infeed to start a run of Cove Daisylink modules. Maximum of 9 Cove modules per each infeed (Cove double counts as two modules). Certified electrician required for installation.

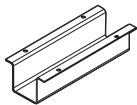

Jumper Guards - Set of 4

ENCVG12	12 x 5 x 3.1	14	1.1	\$143
---------	--------------	----	-----	--------------

Metal channel to protect jumper connection to Cove Daisylink module. Black only. Mounts directly to the underside of surface.



Designed by Zoey Chu, Junction provides an affordable solution for your table applications. Choose from a variety of table top designs: rectangular, half round, trapezoid and keystone to create a unique table for your boardroom, classroom or presentation room application.

A freestanding or shared leg configuration with the unique “Y” leg allows you to either create a permanent table or one that can be reconfigured quickly and easily. A straight leg is available for use with half round and keystone tops.

Shared leg configurations allow more legroom and can also decrease cost because they use fewer components. Freestanding configurations provide more flexibility for changing environments.

Features and Benefits

- Tops are 1” thick and constructed of 45 lb. density particle board.
- 2mm matching edge is standard.
- Optional radius corners (**RM**) available at no upcharge.
- Optional modesty panel with integrated wire trough available.
- Casters available with or without manual locks provide mobility.
- Black grommets for convenient wire management can be ordered factory installed.
- Optional, easy-to-use thumbscrews allow installation without tools.
- Junction tops are available in Global laminate finishes with two leg options.



Y leg design.



Modesty panel.



Shared leg configuration provides more legroom and decreases the overall costs.

GENERAL INFORMATION

- Junction is a series of multi-purpose tables for classroom, training room and boardroom applications.
- Ability for tables to be set up as freestanding or shared leg configuration.
- Unique design by Zooey Chu.
- Half round, trapezoid and keystone tops are available to create a variety of package configurations.
- Rectangular tops are available in 20", 24" and 30" depths.
- Optional modesty panels with integrated wire troughs are available.
- Optional large electrical manager provides a safe environment for equipment wires.
- Special width tops are available. Use next size up.
- Shipped easy to assemble. Each component is packaged individually; legs are shipped 1 per carton.
- For environmental certifications, please visit globalfurnituregroup.com.

WORKSURFACES

- Tops are 1" thick, made of 45 lb. density particle board covered on both sides with high performance thermally fused melamine.
- Laminate finishes are available in high pressure. Contact your Customer Service representative for a quote.
- If other than a Global standard laminate finish is preferred, contact your Customer Service representative. Information needed includes the name of the laminate manufacturer, color name, number and model of table. You will then be given a quote for this special order.

CONSTRUCTION

- Rectangular tops 54" in length and longer include a steel support channel for structural rigidity.
- Tops are predrilled with threaded steel inserts.
- Special width tops are available. Use next size up (add 10% upcharge).
- Adjustable levelers offer up to 1" adjustability.

EDGE DETAIL

- Global's preferred matching edge is standard.
- Optional radius corners (**RM**) are available on rectangular tops at no upcharge.

LEGS

- Unique Y design.
- Straight leg available for assembly with half round tops and keystone tops.
- Heavy duty steel construction.
- Coated with environmentally friendly recycled paint that provides a durable finish.
- Black plastic leveling glides offer $\frac{5}{8}$ " adjustability.
- Available in Black (**TBL**), Cloud (**TIV**), Designer White (**TDW**), Fog (**TFO**), Frost (**TFR**), Kalua (**TKA**), Latte (**TLA**), Mocha (**TMO**), Nevada (**TNE**), Sand (**TSN**), Shadow (**TSH**), Toast (**TOA**) or Tungsten (**TTU**) finish.
- Y legs: 17.5" leg span - 20"D top, 21.5" leg span - 24"D top, 24.5" leg span - 30"D top.

CASTERS

- Optional casters are available.
- 1.5" dual wheel casters with or without manual lock. Full 360° swivel.
- Can be used in any combination with or without standard glides.
- Suggested for carpeted surfaces.
- Available in Black only.
- Sold in packages of two.

GANGING

- Ganging plates are available for ganging workstations together.
- Ganging plates are Black epoxy coated steel plates with two thumbscrews.
- Provides maximum stability and torque reduction.

FLUSH PLATE

- Suggested for top clusters (fixed configurations for additional stability).
- Sold individually and shipped with two thumbscrews for mounting.
- No tools required.
- Flush plate allows for ganging together of two or more tops.

WIRE MANAGEMENT

- Available for managing additional larger wires and power connectors.
- 3.5" high x 4.25" deep Black PVC channel attaches to the underside of top.

SPECIFICATIONS

- Specifications marked with an * are applicable to only those products which have the* symbol beside the product name.

1. SPECIFY MODEL NUMBER

2. SPECIFY FINISH

Laminate Finishes:

ACJ Absolute Acajou	FCL First Class
ASN Asian Night	NBL Noce Biondo
AWC Avant Cherry	NGL Noce Grigio
AWH Avant Honey	NEL Noce Leggero
BLK Black	NML Noce Medio
BZD Blizzard	QTM Quartered Mahogany
BRC Brushed Cobalt	SBY Sheer Beauty
CMB Clear Maple	SDT Stonedust
CGY Custom Grey	SOG Storm Grey
DES Dark Espresso	WHE Walnut Heights
DWT Designer White	WHC White Chocolate
FAS Fashionista	WCR Winter Cherry

Legs:

TBL Black	TMO Mocha
TIV Cloud	TNE Nevada
TDW Designer White	TSN Sand
TFO Fog	TSH Shadow
TFR Frost	TOA Toast
TKA Kalua	TTU Tungsten
TLA Latte	

3. SPECIFY OPTIONS

MODESTY PANELS

- 11.25" high panel attaches to the underside of worksurface top.
- Standard with integrated wire trough.
- Available in Black PVC.

GROMMETS

- Grommets are available in **rectangular and trapezoid** tops (left, center or right). See below for available locations. Order as: **FOG1, FOG2** or **FOG3**. Add \$91. For **keystone** worksurface locations, order as **FOG2**. Add \$91.
- Grommet hole dimensions are 3.25" wide x 1.875" deep.

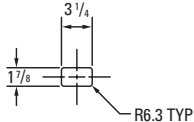

- Grommets may be placed at non-standard locations. Order as: **CSG**. Add \$132. A drawing must be supplied with vertical and horizontal dimensions to the center of the cut-out (as in drawing above). Please refer to the **custom grommet location form** in the back reference section.

POWER BLOCK

- A power block (model **PMSPDM**) may be ordered on all worksurfaces.
- A power block is a rectangular worksurface power/data module with one electrical duplex receptacle and two data (RJ45) receptacles. 9' Black cord included. Power block dimensions are 6.5"W x 3.5"D x 2.75"H.
- To purchase a power block, you must specify both the power block cut-out location and the power block model #. Order power block as **PMSPDM**. Add \$268. Power blocks are available in standard worksurface locations (left, center or right). Order as **E1, E2** or **E3**. Add \$91.

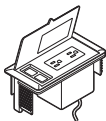

Power block **PMSPDM**. Add \$268.

EXAMPLES OF GROMMET AND POWER BLOCK POSITIONS

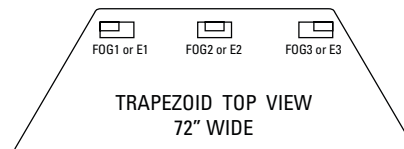
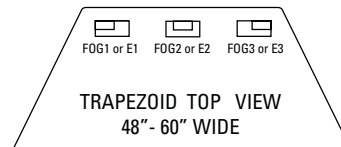
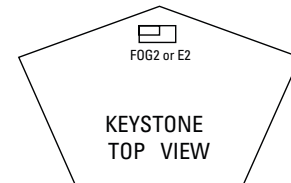
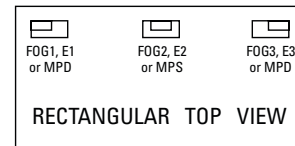

MODPOWER DAISY CHAIN SOLUTION

- Add flexible power and USB charging to Junction **rectangular tables** only. Connect up to four units with a single corded infeed with NEMA plug.
- ModPower units are sold separately, refer to Productivity Solutions page 473.
- Begin run with a starter unit which includes a corded infeed. Add additional middle or end units as required. Middle and end units are equipped with connecting cables.
- On-surface modules clamp on or screw mount to the table tops.
- In-surface modules require table top cut-outs for mounting (cannot be used with modesties). Specify cut-out option:
 - **MPS** for a single cut-out to accommodate one ModPower in-surface unit (cut-out will be centered on the approach side) for **30" to 72" wide rectangular tables**. Add \$91.
 - **MPD** for two cut-outs in the left and right positions, 15" from ends to center of unit on approach side for 60", 66" and 72" wide rectangular tables. Add \$183.

RECTANGULAR TOPS **MODEL #** **DIMENSIONS** **WT/LB.** **CUBIC FT.** **LIST PRICE** **HP ADD**

W x D x H

JNR2042	42 x 20 x 1	26	1.1	\$190	\$95	
JNR2048	48 x 20 x 1	29	1.15	\$199	\$99.50	
JNRU2054	54 x 20 x 1	33	1.3	\$279	\$139.50	
JNRU2060	60 x 20 x 1	37	1.4	\$295	\$147.50	
JNRU2066	66 x 20 x 1	41	1.55	\$320	\$160	
JNRU2072	72 x 20 x 1	45	1.66	\$344	\$172	
JNR2442	42 x 24 x 1	31	1.25	\$210	\$105	
JNR2448	48 x 24 x 1	35	1.4	\$227	\$113.5	
JNRU2454	54 x 24 x 1	42	1.52	\$317	\$158.50	
JNRU2460	60 x 24 x 1	47	1.67	\$337	\$168.50	
JNRU2466	66 x 24 x 1	52	1.82	\$365	\$182.50	
JNRU2472	72 x 24 x 1	57	2	\$390	\$195	
JNR3042	42 x 30 x 1	38	1.51	\$248	\$124	
JNR3048	48 x 30 x 1	44	1.7	\$270	\$135	
JNRU3054	54 x 30 x 1	52	1.9	\$362	\$181	
JNRU3060	60 x 30 x 1	59	2.1	\$386	\$193	
JNRU3066	66 x 30 x 1	64	2.26	\$415	\$207.50	
JNRU3072	72 x 30 x 1	70	2.5	\$442	\$221	

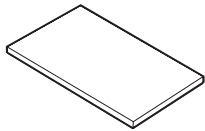

Rectangular Top*

Predrilled with threaded steel inserts for freestanding and linking installations. **Tops 54" and longer are standard with a 16 gauge steel support channel.**

HALF ROUND TOPS

JNHFS2040	40 x 20 x 1	23	1.05	\$227	\$113.50
JNHFS2048	48 x 20 x 1	27.5	1.15	\$236	\$118
JNHFS2448	48 x 24 x 1	34	1.4	\$250	\$125
JNHFS2454	54 x 27 x 1	38.25	1.52	\$315	\$157.50
JNHFS3060	60 x 30 x 1	53	1.67	\$335	\$167.50
JNHFS3066	66 x 33 x 1	58.3	1.82	\$431	\$215.50

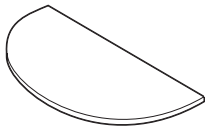

Half Round Top

Predrilled with threaded steel inserts for freestanding and linking installations. Four legs are required for freestanding configurations.

- **JNHFS2040/JNHFS2048** for use with 20" deep joining edge.
- **JNHFS2448/JNHFS2454** for use with 24" deep joining edge.
- **JNHFS3060/JNHFS3066** for use with 30" deep joining edge.

TRAPEZOID TOPS

JNTT2048	48 x 15.25 x 1	27.5	1.15	\$222	\$111
JNTT2060	60 x 15.25 x 1	34	1.4	\$265	\$132.50
JNTT2448	48 x 20.5 x 1	33	1.4	\$239	\$119.50
JNTT2460	60 x 20.5 x 1	41.25	1.67	\$290	\$145
JNTT3060	60 x 25.75 x 1	50.5	2.1	\$314	\$157
JNTT3072	72 x 25.75 x 1	61	2.5	\$358	\$179

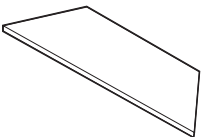

Trapezoid Top

Predrilled with threaded steel inserts for freestanding and linking installations.

- **JNTT2040/JNTT2048** for use with 20" deep joining edge.
- **JNTT2448/JNTT2454** for use with 24" deep joining edge.
- **JNTT3060/JNTT3066** for use with 30" deep joining edge.

Required specifications
Finish

Optional specifications
Grommet*

Accessories
Power block*

KEYSTONE TOPS

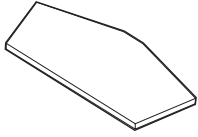

Keystone Tops

MODEL #	DIMENSIONS W x D x H	WT/LB.	CUBIC FT.	LIST PRICE	HD ADD
JN5S2424	42 x 24 x 1	35	1.4	\$270	\$135
JN5S3030	54 x 30 x 1	53	2.1	\$345	\$172.50

Predrilled with threaded steel inserts for freestanding and linking installations. Three legs are required for freestanding configurations.

- **JN5S2424** for use with 24" deep joining edge.
- **JN5S3030** for use with 30" deep joining edge.

MODESTY PANELS

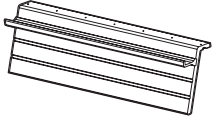

Modesty Panel

JNMP42	29.19 x 6.92 x 11.25	3.7	1.5	\$186	N/A
JNMP48	35.19 x 6.92 x 11.25	4.5	1.75	\$210	N/A
JNMP54	41.19 x 6.92 x 11.25	5	2	\$234	N/A
JNMP60	47.19 x 6.92 x 11.25	5.9	2.25	\$260	N/A
JNMP66	53.19 x 6.92 x 11.25	6.6	2.5	\$274	N/A
JNMP72	59.19 x 6.92 x 11.25	7.4	2.75	\$300	N/A

For use with **JNR rectangular tops**. 11.25" high, Black plastic, attractive ribbed design. Includes integrated wire trough. Connects to predrilled holes in table top.

WIRE MANAGEMENT



Wire Manager

JNEC5S	12.5 x 4.14 x 3.63	1	0.1	\$46	N/A
--------	--------------------	---	-----	-------------	-----

For use with **JN5S keystone**. For managing additional wires and power connectors. 3.5" high Black PVC channel connects to predrilled holes in table top.



Wire Manager

JNEC42	41.75 x 4.14 x 3.63	2.52	0.33	\$117	N/A
JNEC48	47.75 x 4.14 x 3.63	2.88	0.38	\$139	N/A
JNEC54	53.75 x 4.14 x 3.63	3.24	0.43	\$153	N/A
JNEC60	59.75 x 4.14 x 3.63	3.6	0.48	\$172	N/A
JNEC66	65.75 x 4.14 x 3.63	3.96	0.53	\$172	N/A
JNEC72	71.75 x 4.14 x 3.63	4.32	0.58	\$234	N/A

For use with **JNR rectangular tops**. For managing additional wires and power connectors. 3.5" high Black PVC channel connects to predrilled holes in the table top.

Required specifications
Finish (keystone)

Optional specifications
Grommet (keystone)

Accessories
Power block (keystone)

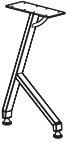
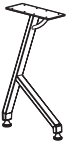
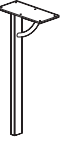
LEGS	MODEL #	DIMENSIONS	WT/LB.	CUBIC FT.	LIST PRICE
 <p>"Y" Leg</p>	JNLEG20	2 x 17.4 x 27.3	8.5	2	\$170
	<p>Leg span is 17.5". Leveling glides are standard. For assembly with 20" deep tops.</p> <ul style="list-style-type: none"> List price is per each leg. See page 426 for available finishes. 				
	JNLEG24	2 x 21.5 x 27.3	10	2.5	\$170
	<p>Leg span is 21.5". Leveling glides are standard. For assembly with 24" deep tops.</p> <ul style="list-style-type: none"> List price is per each leg. See page 426 for available finishes. 				
 <p>"Y" Leg</p>	JNLEG30	2 x 24.5 x 27.3	11	2.85	\$187
	<p>Leg span is 24.5". Leveling glides are standard. For assembly with 30" deep tops.</p> <ul style="list-style-type: none"> List price is per each leg. See page 426 for available finishes. 				
 <p>"Y" Leg</p>	JNLEG	2 x 1 x 27.3	6	1.3	\$155
	<p>Leveling glides are standard. For assembly with half round and keystone tops. Mounting plate is 11" deep by 5" wide.</p> <ul style="list-style-type: none"> List price is per each leg. See page 426 for available finishes. 				
 <p>Straight Leg</p>	<p>Leveling glides are standard. For assembly with half round and keystone tops. Mounting plate is 11" deep by 5" wide.</p> <ul style="list-style-type: none"> List price is per each leg. See page 426 for available finishes. 				
	<p>Leveling glides are standard. For assembly with half round and keystone tops. Mounting plate is 11" deep by 5" wide.</p> <ul style="list-style-type: none"> List price is per each leg. See page 426 for available finishes. 				

Required specifications
Finish (not JNECTxxxx)

J JUNCTION™

CASTERS

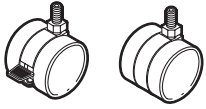

Casters

MODEL #	DIMENSIONS W x D x H	WT/LB.	CUBIC FT.	LIST PRICE
JNCP	- x - x 1.5	-	-	\$30

Set of 2 - 1.5" dual wheel casters, one locking. Suggested for carpeted surfaces. Casters are fully interchangeable with glides. Black only.

- For use with Junction units only.
- Casters DO NOT affect table height.

ACCESSORIES



Thumbscrews

JNTS	1.25 x 1.25 x 1.5	-	-	\$17
------	-------------------	---	---	-------------

Triangular thumbscrew with 0.75" steel thread. Set of 4. Can be used in place of factory supplied screws to allow installation of "Y" legs to tops without tools. Black only.

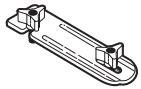

Ganging Flush Plate

JNGFP	2.5 x 5 x 1.13	0.2	0.1	\$28
-------	----------------	-----	-----	-------------

Black epoxy coated steel plates with 2 thumbscrews included. Used to connect table tops together for additional stability or for connecting freestanding tops together. Holes with steel inserts are located in the corner of the tops to accommodate this plate. Sold individually.



Flush Plate

JNFP1	5.25 x 5.25 x 0.37	1.3	0.02	\$5
JNFP4	5.25 x 5.25 x 0.37	5.2	0.2	\$20

Assures alignment on adjoining worksurfaces of the same height. Bolts included. Available in Black only.
JNFP1 - 1 per carton.
JNFP4 - 4 per carton.



Zook was designed for today's dynamic and diverse learning environments. The tables are lightweight and can be reconfigured easily to create interactive environments and support collaboration.

Choose from a variety of organic and geometric shaped table tops to optimize flexibility. They are available in a wide array of sizes and finishes in both thermally fused laminate and high pressure laminate with matching or complementary edgeband and an array of painted finishes for metal legs.

Tops are available in 1" thick thermally fused laminate or 1 1/16" high pressure laminate with 2mm PVC edgebanding or a new optional ergo friendly edge.

Features and Benefits

- Tops are 1" thick thermally fused laminate or 1 1/16" high pressure laminate.
- Tops are constructed of 45 lb. density particle board.
- 2mm PVC edgebanding or optional ergo friendly edge (with some exceptions).
- Tops are available in organic and geometric shapes.
- Surfaces include factory installed metal inserts for solid and secure leg connections.
- Cable tower on group tables is constructed from thermally fused laminate with a removable access panel and inside clearance of 8" x 8.6". Available on group tables ZK44848P, ZK45959P and ZK65990 only.
- Easy to assemble.



Variety of organic and geometric shapes.



Multiple table configurations. Ideal for group study and encouraging collaboration.

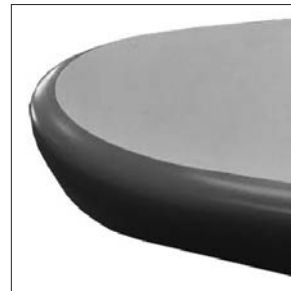

Optional ergo friendly edge.

GENERAL INFORMATION

- Zook is a series of tables designed for classrooms and diverse learning environments.
- Organic shapes and rectangular tops are available to create a variety of configurations that naturally bring people together.
- Choose from Zook group tables for groups of 4 to 6 people, pod tables for individuals, activity tables or flip-top tables.
- Create spaces that encourage discussion and the sharing of ideas.
- Supports multi-use, active learning spaces and a variety of teaching styles.
- Materials and workmanship stand up to the rigorous demands of today's learning environments.
- Shipped easy to assemble. Tops include factory installed metal inserts to accept leg attachment.
- For environmental certification, please visit globalfurnituregroup.com.

ZOOK GROUP TABLES

- Organic shaped tops available in three sizes: 48" x 48", 59" x 59" or 59" x 90".
- Tops supported by 3" diameter fixed height post legs.
- Select models available with cut-out options for power modules; these select models also include a cable tower for managing cables to floor monuments.

ZOOK POD TABLES

- Available in four geometric shapes; three that when used adjacent to one another, can create various pod configurations as well as rectangular tables in a number of sizes.
- ADA compliant heights available for select models.
- 1.5" diameter fixed height post legs.
- Tables may be specified on levelers or with casters for greater mobility and flexibility.

ZOOK ACTIVITY TABLES

- Available in three shapes, all based on a 54" wide footprint.
- Tops are available with two types of mating edges: curved or straight. When planning to mate tables, do not mix mating edge styles.
- 2" diameter tapered legs on levelers or casters.

ZOOK FLIP-TOP TABLES

- Available in three sizes: 30"W x 22"D with concave shaped top; 30"W x 24"D and 60" W x 24"D rectangular top with radiused corners.
- Supported by Y-legs equipped with smooth glide casters (two locking). H-legs are in Tungsten (TTU) finish only.
- 60" wide table tops optional with FOG1, FOG2 or FOG3 grommet. **Add \$91.**
- Modesty panels are available separately in Tungsten (TUN) finish only.

WORKSURFACES

- Tops are available in 1" thick thermally fused laminate or 1 1/16" thick high pressure laminate.
- See page 479 for a list of thermally fused and high pressure laminate finishes available, including nine bold finishes in high pressure laminate only.
- Worksurface cores are 45 lb. density particle board.
- All surfaces include factory installed metal inserts for solid and secure leg connections.

WRITABLE SURFACE OPTION

- Available on group, pod, activity, flip-top and rectangular tables.
- High gloss White, non-magnetic dry-erase surface.
- Complementary or contrasting edge to be specified, darker edge finish recommended.
- Specify (WRW) for top finish. For upcharge, refer to finish option per product.

EDGE DETAIL

- Global's preferred (2mm flat edge) matching edge is standard.
- Optional ergo friendly edge is available at an upcharge (varies by item; see product for details).
- Rectangular tops feature rounded 2.5" radius corners.



Ergo friendly edge



2mm flat edge

LEGS

- **Group tables:** 3" diameter steel post legs and are 28" high with adjustable 3" diameter plastic glides. Each leg includes a 6" x 6" metal top plate and ships with truss head screws to connect to tops. See page 433 for available finishes.
- **Pod tables:** 1.5" diameter tube steel legs are available with adjustable levelers or dual wheel locking casters. Each leg includes top plate and hardware for mounting. See page 433 for available finishes. Optional Chrome (CHM) finish is available, upcharge applies. **Add \$79** for three-legged models or **add \$106** for four-legged models.
- **Activity tables:** 2" diameter tapered legs are available with adjustable levelers or optional locking casters. Each leg includes top plate and hardware for mounting. See page 433 for available finishes. Optional Chrome (CHM) finish is available, upcharge applies. **Add \$147.**

Group tables

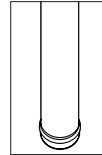

3" leg dia

Pod tables

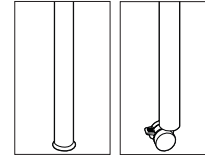

1.5" leg dia

1.5" leg dia
with caster

Activity tables

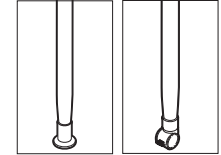

Tapered leg
with leveler

Tapered leg
with caster

CASTERS

- Pod table models ending in C, indicate legs equipped with casters. 1.5" dual wheel locking casters, available in black only.
- Activity table models ending in C, indicate legs equipped with 2" dia locking casters. Casters are black only.

GROUP TABLE with CABLE TOWER

- Constructed from thermally fused laminate with a removable access panel.
- Inside clearance of 8" x 8.6" will conceal most floor monuments but still provide easy access.
- Available on group tables ZK44848P, ZK45959P and ZK65990P only.
- Must specify cut-out option when ordering group tables to accommodate select power module. Power modules sold separately.
- Available in Black (BLK), Brushed Cobalt (BRC) or Designer White (DWT) finish.

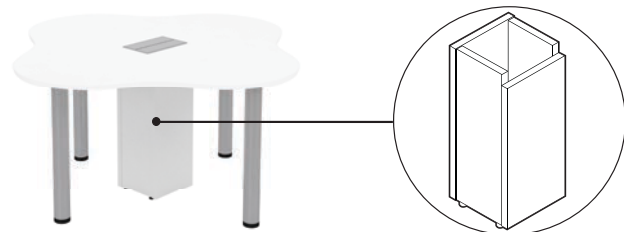

Cable tower

1. SPECIFY MODEL NUMBER

2. SPECIFY TOP FINISH

Thermally Fused and High Pressure Laminate Finishes

ACJ Absolute Acajou	CMB Clear Maple	NGL Noce Grigio	WHE Walnut Heights
ASN Asian Night	CGY Custom Grey	NEL Noce Leggero	WHC White Chocolate
AWC Avant Cherry	DES Dark Espresso	NML Noce Medio	WCR Winter Cherry
AWH Avant Honey	DWT Designer White	OTM Quartered Mahogany	WRW Writable surface*
BLK Black	FAS Fashionista	SBY Sheer Beauty	
BZD Blizzard	FCL First Class	SDT Stonedust	
BRC Brushed Cobalt	NBL Noce Biondo	SOG Storm Grey	

*Upcharge varies by product as noted on the individual product pages.
 **Select edge finish separately from above (see step #3).

Upcharge varies for high pressure laminate by product. Refer to products for details.

3. SPECIFY EDGE FINISH

2mm Thick Edgebanding

AAE Absolute Acajou	CME Clear Maple	NGL Noce Grigio
ASE Asian Night	CGY Custom Grey	NEL Noce Leggero
ACE Avant Cherry	DEE Dark Espresso	NML Noce Medio
AHE Avant Honey	DWE Designer White	OTM Quarter Mahogany
BLK Black	DJN Dijon	SAR Scarlet
BZD Blizzard	FAS Fashionista	SHW Shadow
BRC Brushed Cobalt	FCL First Class	SBY Sheer Beauty
BZB Buzz Blue	FOG Fog	SDT Stonedust
CCT Cactus	LAB Latte	SOG Storm Grey
CRO Carrot	NBL Noce Biondo	WHE Walnut Heights

**Ergo Friendly Edge Finishes
(optional - upcharge applies)**

EBL Black
ECF Latte
ECG Charcoal Grey
EDW Designer White
EGR Grey

4. SPECIFY LEG FINISH

Legs

Table type	TBL	TBZ	TCC	TCR	TIV	TDW	TDJ	TEG	TFO	TFR	TIN	TKA	TLA	TMO	TNE	TSN	TSR	TSH	TOA	TTU	CHM	
Pod	•	•	•	•	•	•	•	•	•	•	•	•	•	•	•	•	•	•	•	•	•	•
Group	•	•	•	•	•	•	•	•	•	•	•	•	•	•	•	•	•	•	•	•	•	N/A
Activity	•	•	•	•	•	•	•	•	•	•	•	•	•	•	•	•	•	•	•	•	•	•
Flip-top	N/A	N/A	N/A	N/A	N/A	N/A	N/A	N/A	N/A	N/A	N/A	N/A	N/A	N/A	N/A	N/A	N/A	N/A	N/A	N/A	•	N/A

Note: Leg finish is not optional on flip-top tables, available in Tungsten (TTU) only.

N/A = not available

5. SPECIFY CABLE TOWER FINISH - ZK44848P, ZK45959P and ZK65990P only

Cable Tower Finishes

BLK Black	BRC Brushed Cobalt	DWT Designer White
------------------	---------------------------	---------------------------

6. SPECIFY CUT-OUT OPTION - remember to order power module separately

POWER BLOCK AND CUT-OUT OPTIONS

- A power block delivers power/data to the table surface.
- Power block modules must be ordered separately and available for models ZK44848P, ZK45959P and ZK65990P only.
- Must specify the power block cut-out option when ordering the table.
- Optional cut-out available in the **center position** only and corresponds to select power modules. Order as **R2** or **T2**, depending on the power module ordered.
- For a custom size cut-out (must be in center position), please contact Customer Service.
- Select power block option on pages 469-470.

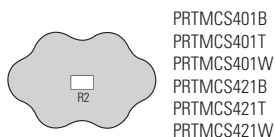

PRTMCS401B
 PRTMCS401T
 PRTMCS401W
 PRTMCS421B
 PRTMCS421T
 PRTMCS421W



PRTMCD602B
 PRTMCD602T
 PRTMCD602W
 PRTMCD622B
 PRTMCD622T
 PRTMCD622W
 PRTMCD642B
 PRTMCD642T
 PRTMCD642W

- Match power block desired with cut-out code and location from above grid.
- Example: For power block module # PRTMCS401B, specify cut-out option R2.

MODPOWER DAISY-CHAIN SOLUTION

- Add flexible power and USB charging to select Zook tables. Connect up to four units with a single corded infeed with NEMA plug.
 - ModPower units are sold separately, refer to Productivity Solutions page 473.
 - Begin run with a starter unit which includes a corded infeed. Add additional middle or end units as required. Middle and end units are equipped with connecting cables.
 - On-surface modules clamp on or screw mount to the table tops.
 - In-surface modules require table top cut-outs for mounting:
 - Specify cut-out option **MPS** for a single cut-out to accommodate one ModPower in-surface unit (cut-out will be centered on the approach side) for **ZKRxxxx(L/C)**, **ZKFR3024*** and **ZKFR6024***. Add **\$91**.
 - Specify cut-out option **MPD** for two cut-outs in the left and right positions, 15" from ends to center of unit on the approach side for **ZKR54xx(L/C)**, **ZKR60xx(L/C)**, **ZKR72xx(L/C)** and **ZKFR6024***. Add **\$183**.
- *Note: not for use with Zook flip-top tables if optional modesty panel is specified.*

4 TO 6-PERSON GROUP TABLES

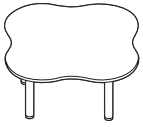

4-Person Table, 20”H

MODEL #	DIMENSIONS	WT/LB.	CUBIC FT.	LIST PRICE	HP ADD	ERGO EDGE ADD	WRW
W x D x H							
ZK4484820	48 x 48 x 20	92	7.1	\$1015	\$285	\$147	\$296
ZK4595920	59 x 59 x 20	123	9	\$1059	\$355	\$181	\$459

4-person table includes top and four steel post legs. Top includes factory installed metal inserts for solid and secure leg connections. Legs are 3” in diameter x 19” high each with an adjustable 3” diameter plastic glide and a 6” x 6” metal top plate. Shipped easy to assemble in 5 cartons.



4-Person Table, 29”H

ZK44848	48 x 48 x 29	215	7.1	\$1053	\$279	\$132	\$312
ZK45959	59 x 59 x 29	220	9.2	\$1079	\$339	\$173	\$471

4-person table includes top and four steel post legs. Top includes factory installed metal inserts for solid and secure leg connections. Legs are 3” in diameter x 28” high each with an adjustable 3” diameter plastic glide and a 6” x 6” metal top plate. Shipped easy to assemble in 5 cartons.

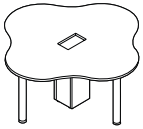

4-Person Table w/Cable Tower, 29”H*

ZK44848P	48 x 48 x 29	265	8.9	\$1437	\$279	\$132	\$312
ZK45959P	59 x 59 x 29	270	11	\$1461	\$339	\$173	\$471

4-person table includes top, four steel post legs and cable tower. Top includes factory installed metal inserts for solid and secure leg connections. Legs are 3” in diameter x 28” high each with an adjustable 3” diameter plastic glide and a 6” x 6” metal top plate. Shipped easy to assemble in 6 cartons. For power block options, see pages 469-470.

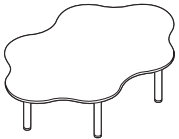

6-Person Table, 20”H

ZK6599020	90 x 59 x 20	247.5	14	\$1630	\$624	\$229	\$741
-----------	--------------	-------	----	---------------	--------------	--------------	--------------

6-person table includes top and seven steel post legs. Top includes factory installed metal inserts for solid and secure leg connections. Legs are 3” in diameter x 19” high each with an adjustable 3” diameter plastic glide and a 6” x 6” metal top plate. Shipped easy to assemble in 8 cartons.

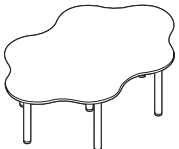

6-Person Table, 29”H

ZK65990	90 x 59 x 29	245	13.5	\$1668	\$595	\$252	\$781
---------	--------------	-----	------	---------------	--------------	--------------	--------------

6-person table includes top and seven steel post legs. Top includes factory installed metal inserts for solid and secure leg connections. Legs are 3” in diameter x 28” high each with an adjustable 3” diameter plastic glide and a 6” x 6” metal top plate. Shipped easy to assemble in 8 cartons.

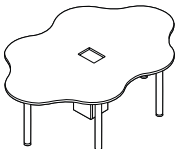

6-Person Table w/Cable Tower, 29”H*

ZK65990P	90 x 59 x 29	295	15.3	\$1976	\$595	\$252	\$781
----------	--------------	-----	------	---------------	--------------	--------------	--------------

6-person table includes top, six steel post legs and cable tower. Top includes factory installed metal inserts for solid and secure leg connections. Legs are 3” in diameter x 28” high with an adjustable 3” diameter plastic glide and a 6” x 6” metal top plate. Shipped easy to assemble in 8 cartons. For power block options, see pages 469-470.

Required specifications

Top finish
Edge finish
Leg finish

Optional specifications

HP laminate
Ergo friendly edge and finish
Power block cut-out*

Accessories

Power block*

POD TABLES

Sample pod table configurations

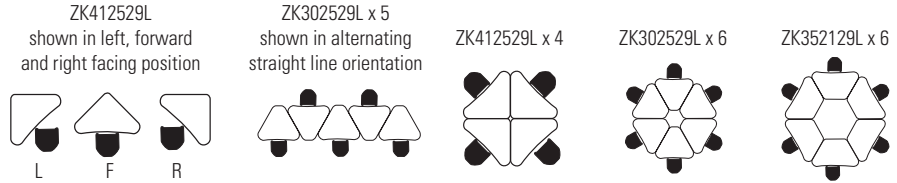

POD TABLES - 29" HIGH



Small Pod Table w/3 Legs

MODEL #	DIMENSIONS W x D x H	WT/LB.	CUBIC FT.	LIST PRICE	HP ADD	ERGO EDGE ADD	WRW
ZK302529L	30 x 24.6 x 29	37	2.01	\$344	\$61	\$62	\$143

Triangular table with three round tube 18 gauge steel legs. Can be used individually, can alternate front-to-back in a straight row, or can be arranged in groups of six to create a round table effect. Top includes factory installed metal inserts for solid and secure leg connections. Legs are 1.5" in diameter x 28" high with adjustable levelers. Shipped easy to assemble in 4 cartons, top separate from legs (legs individually packed).



Medium Pod Table w/4 Legs

ZK352129L	35 x 20.9 x 29	41	2.43	\$433	\$75	\$68	\$142
-----------	----------------	----	------	-------	------	------	-------

Trapezoid table with four round tube 18 gauge steel legs. Can be used individually or can be arranged in groups of six to create a round table effect. Top includes factory installed metal inserts for solid and secure leg connections. Legs are 1.5" in diameter x 28" high with adjustable levelers. Shipped easy to assemble in 5 cartons, top separate from legs (legs individually packed).



Large Pod Table w/3 Legs

ZK412529L	41 x 25.7 x 29	48	2.26	\$444	\$92	\$85	\$164
-----------	----------------	----	------	-------	------	------	-------

Triangular table with three round tube 18 gauge steel legs. Can be used individually or can be arranged in groups of four to create a square table effect. Top includes factory installed metal inserts for solid and secure leg connections. Legs are 1.5" in diameter x 28" high with adjustable levelers. Shipped easy to assemble in 4 cartons, top separate from legs (legs individually packed).

POD TABLES - 32" HIGH



Medium Pod Table w/4 Legs

ZK352132L	35 x 20.9 x 32	41	2.59	\$440	\$75	\$68	\$142
-----------	----------------	----	------	-------	------	------	-------

ADA compliant table with four round tube 18 gauge steel legs. Can be used individually or can be arranged in groups of six to create a round table effect. Top includes factory installed metal inserts for solid and secure leg connections. Legs are 1.5" in diameter x 31" high with adjustable levelers. Shipped easy to assemble in 5 cartons, top separate from legs (legs individually packed).

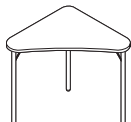

Large Pod Table w/3 Legs

ZK412532L	41 x 25.7 x 32	48	2.38	\$450	\$92	\$85	\$164
-----------	----------------	----	------	-------	------	------	-------

ADA compliant table with three round tube 18 gauge steel legs. Can be used individually or can be arranged in groups of four to create a square table effect. Top includes factory installed metal inserts for solid and secure leg connections. Legs are 1.5" in diameter x 31" high with adjustable levelers. Shipped easy to assemble in 4 cartons, top separate from legs (legs individually packed).

Required specifications

Top finish
Edge finish
Leg finish

Optional specifications

HP laminate
Ergo friendly edge and finish

MOBILE POD TABLES - 29" HIGH

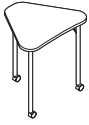

Small Mobile Pod Table w/3 Legs

MODEL #	DIMENSIONS W x D x H	WT/LB.	CUBIC FT.	LIST PRICE	HP ADD	ERGO EDGE ADD	WRW
ZK302529C	30 x 24.6 x 29	37	2.01	\$374	\$61	\$62	\$143

Triangular table with three round tube 18 gauge steel legs. Can be used individually, can alternate front-to-back in a straight row, or can be arranged in groups of six to create a round table effect. Top includes factory installed metal inserts for solid and secure leg connections. Legs are 1.5" in diameter x 28" high with 1.5" dual wheel locking casters. Shipped easy to assemble in 4 cartons, top separate from legs (legs individually packed).



Medium Mobile Pod Table w/4 Legs

ZK352129C	35 x 20.9 x 29	41	2.43	\$470	\$75	\$68	\$142
-----------	----------------	----	------	--------------	-------------	-------------	--------------

Trapezoid table with four round tube 18 gauge steel legs. Can be used individually or can be arranged in groups of six to create a round table effect. Top includes factory installed metal inserts for solid and secure leg connections. Legs are 1.5" in diameter x 28" high with 1.5" dual wheel locking casters. Shipped easy to assemble in 5 cartons, top separate from legs (legs individually packed).



Large Mobile Pod Table w/3 Legs

ZK412529C	41 x 25.7 x 29	48	2.26	\$474	\$92	\$85	\$164
-----------	----------------	----	------	--------------	-------------	-------------	--------------

Triangular table with three round tube 18 gauge steel legs. Can be used individually or can be arranged in groups of four to create a square table effect. Top includes factory installed metal inserts for solid and secure leg connections. Legs are 1.5" in diameter x 28" high with 1.5" dual wheel locking casters. Shipped easy to assemble in 4 cartons, top separate from legs (legs individually packed).

RECTANGULAR TABLES - 29" HIGH

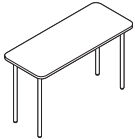

Rectangular Table, 20" Deep

ZKR3020L	30 x 20 x 29	49	2.56	\$419	\$97	\$69	\$131
ZKR3620L	36 x 20 x 29	50	2.68	\$433	\$113	\$77	\$141
ZKR4820L	48 x 20 x 29	57	2.98	\$477	\$153	\$94	\$160
ZKR5420L	54 x 20 x 29	63	3.18	\$557	\$172	\$103	\$168
ZKR6020L	60 x 20 x 29	69	3.28	\$576	\$191	\$110	\$177
ZKR7220L	72 x 20 x 29	84	3.58	\$633	\$230	\$127	\$196

Table with four round tube 18 gauge steel legs. Legs are 1.5" in diameter x 28" high with adjustable levelers. Top features 2.5" radius rounded corners and includes factory installed metal inserts for solid and secure leg connections. Tables 54" and wider include support channel. Shipped easy to assemble in 5 cartons, top separate from legs (legs individually packed).

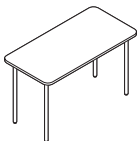

Rectangular Table, 24" Deep

ZKR3024L	30 x 24 x 29	50	2.78	\$424	\$113	\$75	\$141
ZKR3624L	36 x 24 x 29	52	2.88	\$457	\$140	\$83	\$151
ZKR4824L	48 x 24 x 29	58	3.28	\$508	\$184	\$99	\$174
ZKR5424L	54 x 24 x 29	64	3.38	\$591	\$207	\$108	\$185
ZKR6024L	60 x 24 x 29	70	3.58	\$615	\$230	\$116	\$196
ZKR7224L	72 x 24 x 29	85	3.98	\$675	\$275	\$132	\$218

Table with four round tube 18 gauge steel legs. Legs are 1.5" in diameter x 28" high with adjustable levelers. Top features 2.5" radius rounded corners and includes factory installed metal inserts for solid and secure leg connections. Tables 54" and wider include support channel. Shipped easy to assemble in 5 cartons, top separate from legs (legs individually packed).

Required specifications

Top finish
Edge finish
Leg finish

Optional specifications

HP laminate
Ergo friendly edge and finish

MOBILE RECTANGULAR TABLES - 29" HIGH **MODEL #** **DIMENSIONS** **WT/LB.** **CUBIC FT.** **LIST PRICE** **HP ADD** **ERGO EDGE ADD** **WRW**

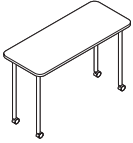

Mobile Rectangular Table, 20" Deep

	W x D x H							
ZKR3020C	30 x 20 x 29	50	2.56	\$458	\$97	\$69	\$131	
ZKR3620C	36 x 20 x 29	51	2.68	\$470	\$113	\$77	\$141	
ZKR4820C	48 x 20 x 29	58	2.98	\$515	\$153	\$94	\$160	
ZKR5420C	54 x 20 x 29	64	3.18	\$594	\$172	\$103	\$168	
ZKR6020C	60 x 20 x 29	70	3.28	\$615	\$191	\$110	\$177	
ZKR7220C	72 x 20 x 29	85	3.58	\$672	\$230	\$127	\$196	

Table with four round tube 18 gauge steel legs. Legs are 1.5" in diameter x 28" high with 1.5" dual wheel locking casters. Top features 2.5" radius rounded corners and includes factory installed metal inserts for solid and secure leg connections. Tables 54" and wider include support channel. Shipped easy to assemble in 5 cartons, top separate from legs (legs individually packed).

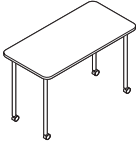

Mobile Rectangular Table, 24" Deep

ZKR3024C	30 x 24 x 29	51	2.78	\$461	\$113	\$75	\$141	
ZKR3624C	36 x 24 x 29	53	2.88	\$492	\$140	\$83	\$151	
ZKR4824C	48 x 24 x 29	59	3.28	\$547	\$184	\$99	\$174	
ZKR5424C	54 x 24 x 29	65	3.38	\$628	\$207	\$108	\$185	
ZKR6024C	60 x 24 x 29	71	3.58	\$653	\$230	\$116	\$196	
ZKR7224C	72 x 24 x 29	86	3.98	\$714	\$275	\$132	\$218	

Table with four round tube 18 gauge steel legs. Legs are 1.5" in diameter x 28" high with 1.5" dual wheel locking casters. Top features 2.5" radius rounded corners and includes factory installed metal inserts for solid and secure leg connections. Tables 54" and wider include support channel. Shipped easy to assemble in 5 cartons, top separate from legs (legs individually packed).

Required specifications

- Top finish
- Edge finish
- Leg finish

Optional specifications

- HP laminate
- Ergo friendly edge and finish

ACTIVITY TABLES

Sample activity table configurations

Straight mating edges

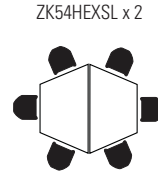
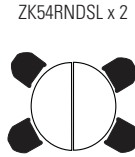
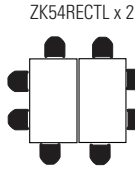

Curved mating edges

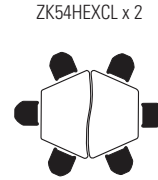
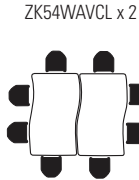

Mixed shapes
Curved mating edges shown.
Can also do the same with straight mating edge tables.

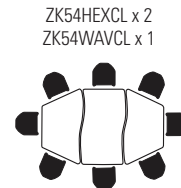
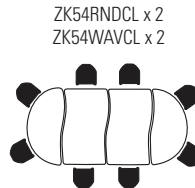

ACTIVITY TABLES - 29" HIGH, CURVED

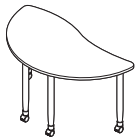

Curved Half Round Table w/Casters

MODEL #	DIMENSIONS W x D x H	WT/LB.	CUBIC FT.	LIST PRICE	HP ADD	ERGO EDGE ADD	WRW
---------	-------------------------	--------	-----------	------------	--------	---------------	-----

ZK54RNDCC	54 x 28.4 x 28.75	67.4	2.8	\$821	\$188	\$114	\$185
-----------	-------------------	------	-----	-------	-------	-------	-------

44.3" inside clearance between legs on curved edge, 22.9" on narrow depth side and 24" on other side. Dual leg position on front interferes with users sitting on ends in a racetrack configuration, oriented to seat two one either side. Top includes factory installed inserts for metal-to-metal leg connection. Shipped easy to assemble in 2 cartons, top separate from legs.

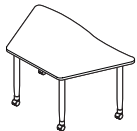

Curved Half Hex Table w/Casters

ZK54HEXCC	54 x 32.4 x 28.75	76.4	2.99	\$887	\$219	\$119	\$185
-----------	-------------------	------	------	-------	-------	-------	-------

42.9" inside clearance between legs on curved edge, 22.3" on narrow depth side and 24" on other side, 22.8" on straight end. Top includes factory installed inserts for metal-to-metal leg connection. Shipped easy to assemble in 2 cartons, top separate from legs.



Wave Table w/Casters

ZK54WAVCC	54 x 33.8 x 28.75	77.4	3.04	\$912	\$232	\$121	\$185
-----------	-------------------	------	------	-------	-------	-------	-------

44.9" inside clearance between legs on curved edges and 21.9" on sides. Top includes factory installed inserts for metal-to-metal leg connection. Shipped easy to assemble in 2 cartons, top separate from leg.

Required specifications

- Top finish
- Edge finish
- Leg finish

Optional specifications

- HP laminate
- Ergo friendly edge and finish

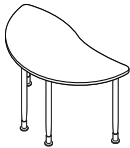
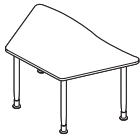
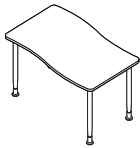
ACTIVITY TABLES - 29" HIGH, CURVED		MODEL #	DIMENSIONS	WT/LB.	CUBIC FT.	LIST PRICE	HP ADD	ERGO EDGE ADD	WRW
			W x D x H						
	Curved Half Round Table w/Levelers	ZK54RNDCL	54 x 28.4 x 28.25	67.4	2.8	\$821	\$188	\$114	\$185
		44.3" inside clearance between legs on curved edge, 22.9" on narrow depth side and 24" on other side. Dual leg position on front interferes with users sitting on ends in a racetrack configuration, oriented to seat two one either side. Top includes factory installed inserts for metal-to-metal leg connection. Shipped easy to assemble in 2 cartons, top separate from leg.							
	Curved Half Hex Table w/Levelers*	ZK54HEXCL	54 x 32.4 x 28.25	76.4	2.99	\$887	\$219	\$119	\$185
		42.9" inside clearance between legs on curved edge, 22.3" on narrow depth side and 24" on other side, 22.8" on straight end. Top includes factory installed inserts for metal-to-metal leg connection. Shipped easy to assemble in 2 cartons, top separate from leg.							
	Wave Table w/Levelers*	ZK54WAVCL	54 x 33.8 x 28.25	77.4	3.04	\$912	\$232	\$121	\$185
		44.9" inside clearance between legs on curved edges and 21.9" on sides. Top includes factory installed inserts for metal-to-metal leg connection. Shipped easy to assemble in 2 cartons, top separate from leg.							

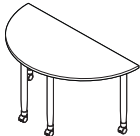
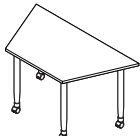
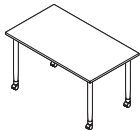
ACTIVITY TABLES - 29" HIGH, STRAIGHT		MODEL #	DIMENSIONS	WT/LB.	CUBIC FT.	LIST PRICE	HP ADD	ERGO EDGE ADD	WRW
	Straight Half Round Table w/Casters	ZK54RNDSC	54 x 28 x 28.75	67.4	2.8	\$777	\$168	N/A	\$185
		44.2" inside clearance between legs on long side, 23.7" on the sides. Dual leg position at front interferes with users sitting on ends in a racetrack configuration, oriented to seat two one on either side. Top includes factory installed inserts for metal-to-metal leg connection. Shipped easy to assemble in 2 cartons, top separate from leg.							
	Straight Half Hex Table w/Casters	ZK54HEXSC	54 x 34 x 28.75	73.4	2.99	\$802	\$178	N/A	\$185
		40.6" inside clearance between legs on long side, 21.4" on sides and 22.3" on short side. Top includes factory installed inserts for metal-to-metal leg connection. Shipped easy to assemble in 2 cartons, top separate from leg.							
	Rectangular Table w/Casters	ZK54RECTC	54 x 34 x 28.75	73.4	3.04	\$847	\$201	N/A	\$185
		45.3" inside clearance between legs on long sides and 22.3" on short sides. Top includes factory installed inserts for metal-to-metal leg connection. Shipped easy to assemble in 2 cartons, top separate from leg.							

Required specifications

Top finish
Edge finish
Leg finish

Optional specifications

HP laminate
Ergo friendly edge and finish*

ACTIVITY TABLES - 29" HIGH, STRAIGHT



Straight Half Round Table w/Levelers

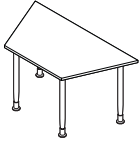

Straight Half Hex Table w/Levelers

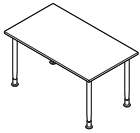

Rectangular Table w/Levelers

MODEL #	DIMENSIONS W x D x H	WT/LB.	CUBIC FT.	LIST PRICE	HP ADD	ERGO EDGE ADD	WRW
ZK54RNDL	54 x 28 x 28.25	67.4	2.8	\$777	\$168	N/A	\$185
44.2" inside clearance between legs on long side, 23.7" on the sides. Dual leg position at front interferes with users sitting on ends in a racetrack configuration, oriented to seat two one on either side. Top includes factory installed inserts for metal-to-metal leg connection. Shipped easy to assemble in 2 cartons, top separate from leg.							
ZK54HEXSL	54 x 34 x 28.25	73.4	2.99	\$802	\$178	N/A	\$185
40.6" inside clearance between legs on long side, 21.4" on sides and 22.3" on short side. Top includes factory installed inserts for metal-to-metal leg connection. Shipped easy to assemble in 2 cartons, top separate from leg.							
ZK54RECTL	54 x 34 x 28.25	73.4	3.04	\$847	\$201	N/A	\$185
45.3" inside clearance between legs on long sides and 22.3" on short sides. Top includes factory installed inserts for metal-to-metal leg connection. Shipped easy to assemble in 2 cartons, top separate from leg.							

Required specifications

Top finish
Edge finish
Leg finish

Optional specifications

HP laminate

FLIP-TOP TABLES - 29.5" HIGH **MODEL #** **DIMENSIONS** **WT/LB.** **CUBIC FT.** **LIST PRICE** **HP ADD** **ERGO EDGE ADD** **WRW**

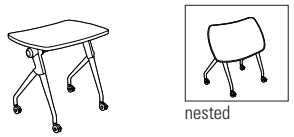

Flip-Top Table, Contoured Top

	W x D x H							
ZKFC3022	30 x 22 x 29.5	47.1	4.07	\$757	\$113	\$72	\$135	

Mobile flip-top table with smooth glide locking casters. Easy to operate twist knob with integrated thumb tab. Top includes factory installed inserts for metal-to-metal leg connection. When nested each additional table adds 5.25" to footprint needed for storage. Optional modesty (ZKFTM30) available separately. Shipped easy to assemble in 2 cartons, top and base shipped separately.

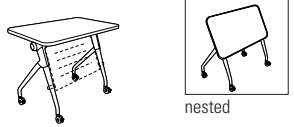

Flip-Top Table, Rectangular Top**

ZKFR3024	30 x 24 x 29.5	48	4.15	\$765	\$125	\$74	\$141	
----------	----------------	----	------	--------------	--------------	-------------	--------------	--

Mobile flip-top table with smooth glide locking casters. Easy to operate twist knob with integrated thumb tab. Top includes factory installed inserts for metal-to-metal leg connection. When nested each additional table adds 5.25" to footprint needed for storage. Optional modesty (ZKFTM30) available separately. Shipped easy to assemble in 2 cartons, top and base shipped separately.

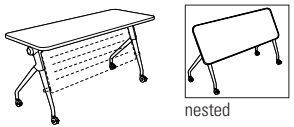

Flip-Top Table, Rectangular Top*

ZKFR6024	60 x 24 x 29.5	73.9	5.28	\$956	\$187	\$116	\$196	
----------	----------------	------	------	--------------	--------------	--------------	--------------	--

Mobile flip-top table with smooth glide locking casters. Easy to operate twist knob with integrated thumb tab. Top includes factory installed inserts for metal-to-metal leg connection. When nested each additional table adds 5.25" to footprint needed for storage. Optional modesty (ZKFTM60) available separately. Shipped easy to assemble in 3 cartons, top and base shipped separately.



Modesty Panel for ZKFC3022 / ZKFC3024

ZKFTM30	17.75 x 0.5 x 13.75	6.6	0.22	\$37	N/A	N/A	N/A	
---------	---------------------	-----	------	-------------	-----	-----	-----	--

Hardware included to attach to ZKFC3022 or ZKFR3024. Tungsten finish only. Shipped in 1 carton.



Modesty Panel for ZKFR6024

ZKFTM60	47.25 x 0.5 x 13.75	14.3	0.57	\$83	N/A	N/A	N/A	
---------	---------------------	------	------	-------------	-----	-----	-----	--

Hardware included to attach to ZKFR6024. Tungsten finish only. Shipped in 1 carton.

Required specifications	Optional specifications
Top finish	HP laminate
Edge finish	Ergo friendly edge and finish
	Grommet* (FOG1, FOG2 or FOG3)
	Grommet** (FOG2 only)

tables

reception and occasional

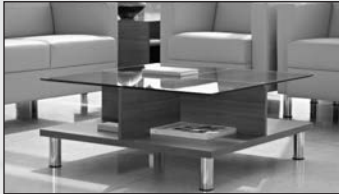

Citi 443

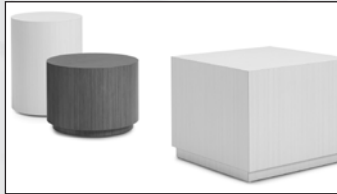

Occasional tables 445



River+ 447



Sirena 449



Wind 450



Work tables 452

CITI TABLES

Notes:

- Citi tables complement the contemporary timeless decor of many offices.
- Legs are **standard** in Tungsten (**TTU**) and also available in Black (**TBL**) finish at no upcharge. A Chrome (**CHM**) finish is available. **Add \$68.**
- Table tops are available in either tempered glass or laminate.
- Citi tables are offered in the following finishes to coordinate with Global casegoods and wood seating:

ACJ Absolute Acajou	FCL First Class
ASN Asian Night	NBL Noce Biondo
AWC Avant Cherry	NGL Noce Grigio
AWH Avant Honey	NEL Noce Leggero
BLK Black	NML Noce Medio
BZD Blizzard	QTM Quartered Mahogany
BRC Brushed Cobalt	SBY Sheer Beauty
CMB Clear Maple	SDT Stonedust
CGY Custom Grey	SOG Storm Grey
DES Dark Espresso	WHE Walnut Heights
DWT Designer White	WHC White Chocolate
FAS Fashionista	WCR Winter Cherry

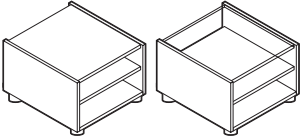
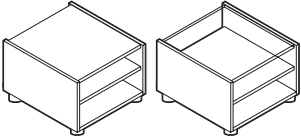
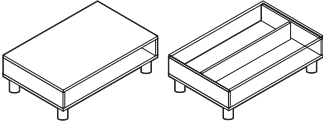
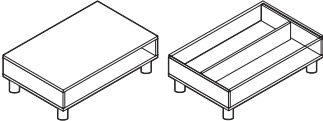
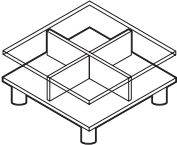
CITI TABLES	MODEL #	DIMENSIONS	WT/LB.	CUBIC FT.	LIST PRICE
W x D x H					
	7885	20 x 24 x 20	45	6	\$715
	(laminate top)				
	7886	20 x 24 x 20	52	6	\$934
	(glass top)				
Metal tubular legs. Laminate or tempered glass tops available. Shipped assembled in 1 carton.					
	7887	40 x 20 x 15	50	6.5	\$747
	(laminate top)				
	7888	40 x 20 x 15	65	6.5	\$1079
	(glass top)				
Metal tubular legs. Laminate or tempered glass tops available. Shipped assembled in 1 carton.					
	7889	33 x 33 x 15	80	8.75	\$1283
	(glass top)				
Metal tubular legs. Tempered glass top. Shipped assembled in 1 carton.					

End Table

Coffee Table - Rectangular

Coffee Table - Square

Required specifications

- Top finish
- Leg finish

C COAT TREES

COAT TREES	MODEL #	DIMENSIONS	WT/LB.	CUBIC FT.	LIST PRICE
------------	---------	------------	--------	-----------	------------



Coat Tree

	W x D x H				
PCOS2	25 x 25 x 60	8	14.21	\$186	
PCOS3	25 x 25 x 60	8	14.21	\$186	

Square tube metal frame. Four Chrome double hooks. Adjustable glides. 60" high. 3 per carton (pricing and specifications are for one coat tree).

Shipped assembled in 1 carton.

- PCOS2 is finished in **Black (BLK)**.
- PCOS3 is finished in **Chrome (CHM)**.



Coat Tree

PCT	25 x 25 x 65	6	3	\$228	
-----	--------------	---	---	--------------	--

Square tube wood frame. Complete with four satin brass double hooks. 65" high. Available in the following finishes: Absolute (AAM), Black (BKM), Cherry (ACM), English Oak (EOM), Espresso Cafe (ECM), Gray (HGM), Honey (AHM), Maple (AVM), Medium Walnut (MWM), Night (ASM), Sandy Beach (SBM), Shaker Cherry (SKM), Tiger Fruitwood (TFM), Tiger Mahogany (TMM), Tiger Walnut (TWM), WC Cream (WTM), White (WHM) and Winter Cherry (WCM).

1 per carton. Shipped assembled in 1 carton.

Required specifications

Finish

CYLINDER AND CUBE OCCASIONAL TABLES

Notes:

- High pressure laminate exterior with adjustable plastic glides.
- Premium cylinder tables have a flexible plywood core construction ideal for institutional and high traffic environments.
- Ideal for reception areas - colors coordinate with all Global desks, conference tables and accessories.
- Shipped assembled in 1 carton.
- WT/LB. are shipping weights.
- Available to either match or coordinate with most Global laminate desk series. Available finishes:

ACJ Absolute Acajou	FCL First Class
ASN Asian Night	NBL Noce Biondo
AWC Avant Cherry	NGL Noce Grigio
AWH Avant Honey	NEL Noce Leggero
BLK Black	NML Noce Medio
BZD Blizzard	QTM Quartered Mahogany
BRC Brushed Cobalt	SBY Sheer Beauty
CMB Clear Maple	SDT Stonedust
CGY Custom Grey	SGG Storm Grey
DES Dark Espresso	WHE Walnut Heights
DWT Designer White	WHC White Chocolate
FAS Fashionista	WCR Winter Cherry

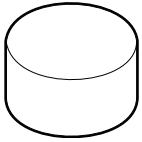
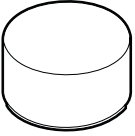
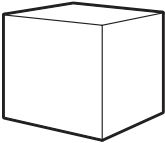
CYLINDER AND CUBE OCCASIONAL TABLES	MODEL #	DIMENSIONS	WT/LB.	CUBIC FT.	LIST PRICE
 <p>Premium Cylinder Tables</p>	W x D x H				
	CPFD1816	18 x - x 16	23	6.5	\$832
	CPFD1821	18 x - x 21	26.5	8	\$856
	CPFD2416	24 x - x 16	32.5	11	\$865
	CPFD2421	24 x - x 21	35	12.5	\$886
	CPFD3016	30 x - x 16	45.5	15.5	\$1024
	CPFD3021	30 x - x 21	48	17	\$1079
¹¹ / ₃₂ " thick flexible plywood covered in high pressure laminate. Adjustable plastic glides. Flush base.					
 <p>Premium Plinth Cylinder Tables</p>	CPPD1816	18 x - x 16	27.5	6.5	\$877
	CPPD1821	18 x - x 21	31	8	\$898
	CPPD2416	24 x - x 16	38.7	11	\$908
	CPPD2421	24 x - x 21	41.2	12.5	\$931
	CPPD3016	30 x - x 16	54.5	15.5	\$1038
	CPPD3021	30 x - x 21	57	17	\$1138
¹¹ / ₃₂ " thick flexible plywood covered in high pressure laminate. Adjustable plastic glides. Recessed base.					
 <p>Cube Table</p>	CU1816	18 x 18 x 16	26	3.3	\$502
	CU1821	18 x 18 x 21	30	4	\$544
	CU2416	24 x 24 x 16	38	6	\$526
	CU2421	24 x 24 x 21	43.5	7	\$569
	CU3016	30 x 30 x 16	50.8	6.5	\$553
	CU3021	30 x 30 x 21	57.5	8	\$595
0.75" thick plywood covered in high pressure laminate. Adjustable plastic glides. Flush base.					

Required specifications

Finish

0 OCCASIONAL TABLES

CYLINDER AND CUBE OCCASIONAL TABLES

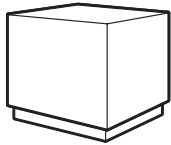

Plinth Cube Table

MODEL #	DIMENSIONS W x D x H	WT/LB.	CUBIC FT.	LIST PRICE
CUP1816	18 x 18 x 16	28	3	\$545
CUP1821	18 x 18 x 21	33.5	4	\$586
CUP2416	24 x 24 x 16	41.5	6	\$573
CUP2421	24 x 24 x 21	48	7	\$615
CUP3016	30 x 30 x 16	53.8	6.5	\$638
CUP3021	30 x 30 x 21	62.3	8	\$695

0.75" thick plywood covered in high pressure laminate. Adjustable plastic glides. **Recessed base.**

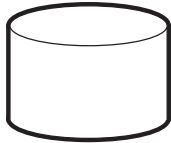

Cylinder Table

CY1816	18 x - x 16	21	3.3	\$465
CY1821	18 x - x 21	27	4.3	\$512
CY2416	24 x - x 16	33	6	\$485
CY2421	24 x - x 21	39	7	\$526
CY3016	30 x - x 16	44.5	8	\$573
CY3021	30 x - x 21	52.7	11	\$616

0.375" thick foundation board covered in high pressure laminate. Adjustable plastic glides. **Flush base.**

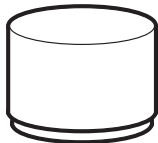

Plinth Cylinder Table

CYP1816	18 x - x 16	26.5	3.3	\$502
CYP1821	18 x - x 21	32	4.3	\$545
CYP2416	24 x - x 16	40	6	\$522
CYP2421	24 x - x 21	46	7	\$564
CYP3016	30 x - x 16	52.3	8	\$614
CYP3021	30 x - x 21	60.5	11	\$654

0.375" thick foundation board covered in high pressure laminate. Adjustable plastic glides. **Recessed base.**

Required specifications

Finish

RIVER+ TABLES

Notes:

River+ tables are made with high pressure laminate and are offered in following finishes to coordinate with Global casegoods and wood seating:

ACJ Absolute Acajou	FCL First Class
ASN Asian Night	NBL Noce Biondo
AWC Avant Cherry	NGL Noce Grigio
AWH Avant Honey	NEL Noce Leggero
BLK Black	NML Noce Medio
BZD Blizzard	QTM Quartered Mahogany
BRC Brushed Cobalt	SBY Sheer Beauty
CMB Clear Maple	SDT Stonedust
CGY Custom Grey	SOG Storm Grey
DES Dark Espresso	WHE Walnut Heights
DWT Designer White	WHC White Chocolate
FAS Fashionista	WCR Winter Cherry

- Custom high pressure laminate finishes will be considered upon request.
- Legs are straight as standard in Chrome (**CHM**) with Black non-marking height adjustable glides.
- Legs are also available in the following finishes: Black (**TBL**), Cloud (**TIV**), Designer White (**TDW**), Fog (**TFO**), Frost (**TFR**), Kalua (**TKA**), Latte (**TLA**), Mocha (**TMO**), Nevada (**TNE**), Sand (**TSN**), Shadow (**TSH**), Toast (**TOA**) and Tungsten (**TTU**). No upcharge. Please specify.
- The unique tapered legs are made of welded steel, with each leg bolted directly to the unit frame. All units have the same standard leg height of 6.5". The leg height makes it easier to clean under the product. Legs are also available in 3" and 8" heights. All heights are available with fixed-to-floor option. Please specify:
 - (S6) Standard height (6.5") w/adjustable glides. No upcharge. (F6) Standard height (6.5"), fixed to floor. **Add \$90.**
 - (S3) Low (3") w/adjustable glides. No upcharge. (F3) Low (3"), fixed to floor. **Add \$90.**
 - (S8) High (8") w/adjustable glides. No upcharge. (F8) High (8"), fixed to floor. **Add \$90.**
- Products can be weighted to reduce the ease of movement. For additional weight options, please specify (**CW**) - see each model for available additional weight and upcharge.
- Tables can be specified with power/USB units, which include one power outlets, one double USB terminals and a Black 120" 3-prong power cord in predetermined locations - **E1**, **E2**, **F3** or **T1** as shown in the electrical illustrations below. Electrical units must be factory installed. **Add \$881** per unit.
- Power/USB units are available with either Jet Black (**J**) face plate with Black power/USB receptacles or with a White (**W**) face plate with White power/USB receptacles.
- Tamperproof fasteners (**TP**) are available. Please specify. **Add \$119.**
- Refer to the Seating price list, under lounge seating for the full range of River+ products available.

ELECTRICAL PLACEMENT

Coffee Tables

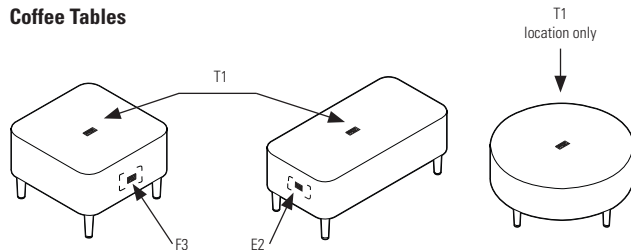

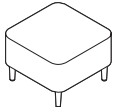
RIVER+ TABLES	MODEL#	DIMENSIONS W x D x H	WT/LB.	CUBIC FT.	LIST PRICE
 <p>24" Square Laminate Coffee Table</p>	R27855	24 x 24 x 17	40	10.7	\$1329
	Freestanding unit only. For additional weight, please specify (CW). Add \$533 for 36 lbs. Power/USB units can be specified in position F3 or T1 only. Add \$881.				

Required specifications

Top finish
Leg finish/height

Optional specifications

Power/USB finish
Power/USB location
Tamperproof

R RIVER+ TABLES

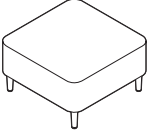
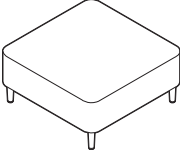
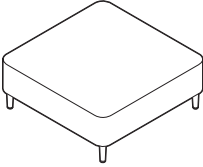
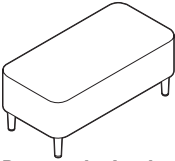
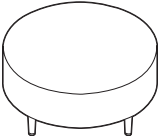
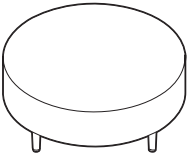
RIVER+ TABLES	MODEL #	DIMENSIONS W x D x H	WT/LB.	CUBIC FT.	LIST PRICE
 <p>30" Square Laminate Coffee Table</p>	R27856	30 x 30 x 17	53	15.3	\$1392
<p>Freestanding unit only. For additional weight, please specify (CW). Add \$400 for 27 lbs. Power/USB units can be specified in position F3 or T1 only. Add \$881.</p>					
 <p>36" Square Laminate Coffee Table</p>	R27857	36 x 36 x 17	75	20.6	\$1541
<p>Freestanding unit only. No additional weight is required. Power/USB units can be specified in position F3 or T1 only. Add \$881.</p>					
 <p>42" Square Laminate Coffee Table</p>	R27858	42 x 42 x 17	115	26.7	\$1706
<p>Freestanding unit only. No additional weight is required. Power/USB units can be specified in position F3 or T1 only. Add \$881.</p>					
 <p>Rectangular Laminate Coffee Table</p>	R27859	40 x 20 x 17	55	14.2	\$1400
<p>Freestanding unit only. For additional weight, please specify (CW). Add \$267 for 18 lbs. Power/USB units can be specified in position E1, E2 or T1 only. Add \$881.</p>					
 <p>36" Dia. Round Laminate Coffee Table</p>	R27860	36 x 36 x 17	63	15.3	\$1729
<p>Freestanding unit only. For additional weight, please specify (CW). Add \$267 for 18 lbs. Power/USB units can be specified in position T1 only. Add \$881.</p>					
 <p>42" Dia. Round Laminate Coffee Table</p>	R27861	42 x 42 x 17	85	20.6	\$1889
<p>Freestanding unit only. No additional weight is required. Power/USB units can be specified in position T1 only. Add \$881.</p>					

Required specifications

Top finish
Leg finish/height

Optional specifications

Power/USB finish
Power/USB location
Tamperproof



SIRENA TABLES

Notes:

- Modern tables for reception areas, meeting rooms, and private office use.
- Sirena tables are offered in the following finishes to coordinate with Global casegoods and wood seating:

ACJ Absolute Acajou	FCL First Class
ASN Asian Night	NBL Noce Biondo
AWC Avant Cherry	NGL Noce Grigio
AWH Avant Honey	NEL Noce Leggero
BLK Black	NML Noce Medio
BZD Blizzard	QTM Quartered Mahogany
CMB Clear Maple	SBY Sheer Beauty
CGY Custom Grey	SDT Stonedust
DES Dark Espresso	WHE Walnut Heights
DWT Designer White	WHC White Chocolate
FAS Fashionista	WCR Winter Cherry

- Laminate tops are 1" thick to coordinate with Global casegoods and wood seating.
- Table legs are available in Black (TBL) or Tungsten (TTU) at no upcharge. Not available in Chrome.
- Legs are 1.5" steel tubing, tapered toward the bottom of the leg to 0.875", equipped with self-leveling pivoting steel glide.

SIRENA TABLES	MODEL#	DIMENSIONS	WT/LB.	CUBIC FT.	LIST PRICE
 <p>Coffee Table</p>  <p>Coffee Table</p>  <p>End Table</p>		W x D x H			
	3400 (laminated top)	48 x 22 x 14.5	44	17.25	\$1214
	Rectangle coffee table.				
	3401 (laminated top)	56 x 22 x 14.5	50	19	\$1346
	Rectangle coffee table.				
	3402 (laminated top)	17 x 22 x 14.5	20	7.75	\$1007
	Rectangle end table.				

Required specifications

- Top finish
- Leg finish

W WIND TABLES





WIND TABLES

Notes:

- Wind tables complement the modern decor of many offices.
- Legs are standard in Chrome (**CHM**). Also available in Black (**TBL**), Shadow (**TSH**) or Tungsten (**TTU**) finish at no upcharge.
- 1" laminate tops are offered in the following finishes to coordinate with Global casegoods and wood seating:

ACJ	Absolute Acajou	FCL	First Class
ASN	Asian Night	NBL	Noce Biondo
AWC	Avant Cherry	NGL	Noce Grigio
AWH	Avant Honey	NEL	Noce Leggero
BLK	Black	NML	Noce Medio
BZD	Blizzard	OTM	Quartered Mahogany
BRC	Brushed Cobalt	SBY	Sheer Beauty
CMB	Clear Maple	SDT	Stonedust
CGY	Custom Grey	SOG	Storm Grey
DES	Dark Espresso	WHE	Walnut Heights
DWT	Designer White	WHC	White Chocolate
FAS	Fashionista	WCR	Winter Cherry

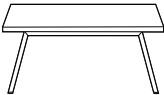
- High pressure laminate (**HPL**) tops are available at a 20% upcharge for models 3366, 3367, 3368, 3870 and 3871. Please specify HPL in addition to the finish. HPL not available for models 3878, 3879 and 3880.

WIND TABLES	MODEL #	DIMENSIONS	WT/LB.	CUBIC FT.	LIST PRICE	
 <p>End Table</p>  <p>Rectangular Coffee Table</p>  <p>Square Coffee Table</p>  <p>Round Table</p>  <p>Round Coffee Table</p>		W x D x H				
	3366 (laminate top)	24 x 24 x 17	24	11.5	\$661	
	Steel tubular base. Tops are available with a laminate finish. Shipped assembled in 1 carton.					
	3367 (laminate top)	48 x 20 x 15	39	16	\$886	
	Steel tubular base. Tops are available with a laminate finish. Shipped assembled in 1 carton.					
3368 (laminate top)	36 x 36 x 15	50	22	\$1214		
Steel tubular base. Tops are available with a laminate finish. Shipped assembled in 1 carton.						
3870 (laminate top)	24 x 24 x 17	30	11.5	\$721		
Steel tubular base. Tops are available with a laminate finish. Shipped assembled in 1 carton.						
3871 (laminate top)	36 x 36 x 15	50	22	\$1115		
Steel tubular base. Tops are available with a laminate finish. Shipped assembled in 1 carton.						

Required specifications
Top finish

Optional specifications
Edge detail
Leg finish

WIND TABLES **MODEL #** **DIMENSIONS** **WT/LB.** **CUBIC FT.** **LIST PRICE**

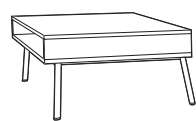

Freestanding Rectangular End Table

W x D x H					
3878	20 x 25 x 16	30	11.5	\$1112	

Steel tubular base. Laminate top is 5" thick with opening on front for storage and visual recess at rear. Shipped assembled in 1 carton.

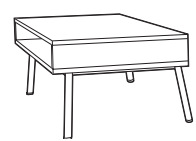

Freestanding Corner Table

3879	25 x 25 x 16	32	11.5	\$1241	
------	--------------	----	------	---------------	--

Steel tubular base. Laminate top is 5" thick with opening on front for storage and visual recess at rear. Shipped assembled in 1 carton.

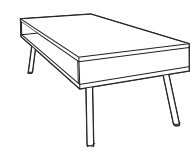

Freestanding Coffee Table

3880	54 x 20 x 15	39	16	\$1393	
------	--------------	----	----	---------------	--

Steel tubular base. Laminate top is 5" thick with opening on front for storage and visual recess at rear. Shipped assembled in 1 carton.

Required specifications

Top finish

Optional specifications

Edge detail

Leg finish

W WORK TABLES

WORK TABLES

Notes:

- Work tables are offered in the following top finishes to coordinate with Global casegoods and wood seating:

ACJ	Absolute Acajou	FCL	First Class
ASN	Asian Night	NBL	Noce Biondo
AWC	Avant Cherry	NGL	Noce Grigio
AWH	Avant Honey	NEL	Noce Leggero
BLK	Black	NML	Noce Medio
BZD	Blizzard	QTM	Quartered Mahogany
BRC	Brushed Cobalt	SBY	Sheer Beauty
CMB	Clear Maple	SDT	Stonedust
CGY	Custom Grey	SOG	Storm Grey
DES	Dark Espresso	WHE	Walnut Heights
DWT	Designer White	WHC	White Chocolate
FAS	Fashionista	WCR	Winter Cherry

- T-mold (**TM**) edging available in Black (**BLK**), please specify. No upcharge.
- Legs are available in Chrome (**CHM**) or Black (**TBL**).

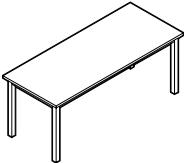
WORK TABLES	MODEL #	DIMENSIONS	WT/LB.	CUBIC FT.	LIST PRICE
		W x D x H			
 <p>Work Tables</p>	AT7236	72 x 36 x 29	110	6	\$784
	AT7230	72 x 30 x 29	100	5	\$616
	AT6030	60 x 30 x 29	90	5	\$540
<p>1" high performance thermally fused laminate with self edge top. Black metal skirt. Rectangle top with metal legs and leveling glides. Self edge is standard. Black legs are optional, no upcharge. Shipped easy to assemble in 1 carton.</p>					

Required specifications

Top finish
Leg finish

Optional specifications

HP laminate