

Desking + Tables

Pricing effective January 1, 2023 - Canada

Revised May 13, 2024



PRICE LIST desking + tables



think global

THE GLOBAL EDGE

ERGONOMICS IN THE OFFICE

- Full range of ergonomically designed workplace, healthcare and office furniture with competitive pricing and built-in value.

STRENGTH AND STABILITY

- Established in 1966.
- One of North America's largest office furniture manufacturers.
- Manufacturing and showrooms worldwide.

QUICK SHIP PROGRAM

- Global's Quick Ship program offers the most comprehensive product offering across Canada.
- While we offer many additional products in a wide array of styles and colors, many items will be available to ship to you in as little as ten days.

STRONG LOCAL REPRESENTATION

- Service and expert advice where you are, when you need it!

MANUFACTURING CAPABILITY

- Vertical integration ensures "start to finish" control.
- Ongoing research and investment in new, innovative production technology.

QUALITY ASSURANCE

- The quality program is registered to ISO 9001.
- On-site furniture testing facility.
- Products and components are tested to meet or exceed ANSI/BIFMA standards.
- Products backed by Global's Limited Lifetime Warranty.

ENVIRONMENTAL COMMITMENT

- Continuous development of "earth friendly" programs.
- One of the first molded foam manufacturers to create ozone-friendly, CFC and HFC-free processes.
- Many seat and back pans are made from recyclable plastics and wood waste, enabling little waste and cost effective products.

TABLE OF CONTENTS

WORKPLACE

LAMINATE DESKS

Adaptabilities.....	9
Consumer education.....	3
Desking comparison chart.....	4
Genoa.....	48
Laminate desk notes.....	8
Princeton.....	60
Zira.....	108
Zira reception desks.....	282

PANELS AND COMPONENTS

Divide.....	290
Fabric panels.....	294
Glazed panels.....	295
Laminate panels.....	298
Raised glazed panels.....	296
Transaction tops.....	301

TABLES - CAFÉ, MEETING & CONFERENCE

Alba.....	306
Boardroom.....	309
Swap.....	321
Zira boardroom tables.....	268

TABLES - TRAINING

2gether.....	358
Bungee.....	361
Bungee SL.....	379
Bungee SL power/data management.....	388
ConnectTABLES.....	396
Duet.....	411
Edventure.....	414
Junction.....	424
Zook.....	431

TABLES - RECEPTION & OCCASIONAL

Citi.....	443
Coat trees.....	444
Cylinder and cube occasional tables.....	445
River+.....	447
Sirena.....	449
Wind.....	450
Work tables.....	452

PRODUCTIVITY SOLUTIONS by Global

Keyboard trays.....	461
Manual height adjustable tables.....	455
Monitor arms.....	458
Office accessories.....	475
Power/data.....	467
Productivity Solutions.....	454

REFERENCE

Custom grommet location form.....	481
Textiles and Finishes.....	477
Terms and Conditions.....	482
Lifetime Warranty.....	485
Index.....	486

OFFICE + WORKSTATIONS

Princeton60

Zira108

BENCHING + PANELS

Divide290

CAFETERIA TABLES

Alba306

Swap321

Work tables452

CLASSROOM + LAB TABLES

2gether358

Bungee361

Bungee SL379

ConnectTABLES396

Duet411

Edventure414

Junction.....424

Zook.....431

LOUNGE TABLES

Citi443

Sirena449

Swap321

Wind.....450

MEETING + COLLABORATIVE TABLES

Alba306

Bungee361

Bungee SL379

Princeton60

Swap321

Work tables452

Zira268

Zook.....431

MOBILE TABLES

2gether358

Bungee361

Bungee SL379

ConnectTABLES396

Edventure414

Junction.....424

STACKING TABLES

Duet.....411

ACCESSORIES

Keyboard mechanisms462



Keyboard trays461

Monitor arms.....458



Office accessories.....475

Power solutions.....467

DESKING COMPARISON CHART

	ADAPTABILITIES	GENOA
		
GENERAL FEATURES	<ul style="list-style-type: none"> • Top over end panel design. • 400 color combinations. • Virtually no loose hardware. • Storage height is 66". • 2 handle options. 	<ul style="list-style-type: none"> • Top over end panel design. • ¾ pedestal standard. • Virtually no loose hardware. • Storage height is 66".
GOOD BETTER BEST	Better	Good
STYLE	Transitional	Transitional
PRICE POINT (36 x 72 double pedestal desk)	\$1662	\$1316
WORKSURFACE THICKNESS	1"	1"
SURFACE TYPE	High performance thermally fused laminate or HPL	High performance thermally fused laminate
EDGE THICKNESS	2mm	Self edge
EDGE OPTIONS	Flat or Bicut	N/A
USDA BIO-PREFERRED EDGE	Yes	Yes
PHTHALATE-FREE EDGE	Yes	Yes
HUTCH CLEARANCE (worksurface to underside of hutch)	17.75" to valance 20" to underside of hutch	20"
GREENGUARD CERTIFIED	Yes	Yes
BIFMA e3 LEVEL CERTIFIED	Level 3	Level 3

DESKING COMPARISON CHART

	PRINCETON	ZIRA
		
GENERAL FEATURES	<ul style="list-style-type: none"> • Freestanding, modular components with overlapping architectural elements. • 14 standard finishes; up to 3 color application on many components is available. • Optional 6mm tempered glass on hutches and desktop storage. • Storage height is 52" and 66". 	<ul style="list-style-type: none"> • Top over end panel design. • 400 color combinations. • Virtually no loose hardware. • Storage height is 42", 54", 66", 72" and 84" (nominal). • 9 handle options. • 4 glazing options for storage doors and modesty panels.
GOOD BETTER BEST	Best	Best
STYLE	Contemporary	Contemporary
PRICE POINT (36 x 72 double pedestal desk)	N/A	\$2333
WORKSURFACE THICKNESS	1"	1" or 1.5"
SURFACE TYPE	High performance thermally fused laminate or HPL	High performance thermally fused laminate or HPL
EDGE THICKNESS	2mm	2mm
EDGE OPTIONS	N/A	Flat, Fluted or Bicut
USDA BIO-PREFERRED EDGE	No	Yes
PHthalate-free EDGE	Yes	Yes
HUTCH CLEARANCE (worksurface to underside of hutch)	15.75"	20.25" (23.5" hutch) 17.75" (36" hutch) 24.25" (42" hutch) 24.25" (54" hutch)
GREENGUARD CERTIFIED	Yes	Yes
BIFMA e3 LEVEL CERTIFIED	Level 3	Level 3

CONSUMER EDUCATION

How do I buy a desk?



Choose a non-reflective surface. Global uses colors that reduce glare to make your work easier to read while reducing eye strain.



Get a desk that lets you look ahead. A modular desk is easy to set up initially and then reorganize or reconfigure later to adapt to future needs.

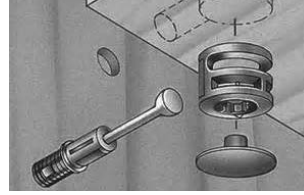

Look for European connectors if you're buying easy to assemble furniture. Global makes assembly easy - all you need is a screwdriver.



Give your business an edge. Each Global desk comes with its own attractive edge design.



Avoid tangles. Make sure your desk has at least one grommet hole to keep computer and telephone wires out of the way.



A hutch should have a sweep that manages computer and telephone wires.



Island workspaces let you meet with more than two people at once with ample leg room for all.

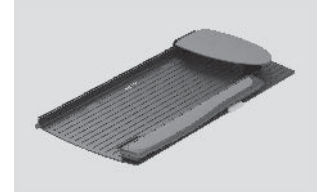

Choose one of Global's height/angle adjustable keyboard trays to go with your desk. Your arms can maintain a comfortable position, reducing shoulder, back and neck strain.

How do I select the right workstation?

When searching for the right workstation it is important to consider its purpose which will be decided by the nature of your tasks. It is best to look for products that have been designed and engineered to help make your workspace more productive.

This can be achieved in a variety of ways. As a guide, observe how your work flows through your office in a typical day. It is likely that you'll uncover a number of distinctive and repetitive task patterns.

Once these patterns have been identified, organize them according to their intended use and frequency of their use. Now you are ready to investigate the pertinent factors that will determine the workspace you eventually select.

Lighting - protect yourself

- If you have to set up near a window make sure your computer sits perpendicular to it, minimize eye-strain inducing glare on sunny days.
- If you have fluorescent lights, try to position your set up between the lights.
- Use "parabolic louvers" to reduce the glare from fluorescent lights.
- Use window blinds to control the light source throughout the day.
- Panels or screens may be used to control glare.
- Protect your eyes from Ultraviolet A (UVA) and Ultraviolet B (UVB) by using an anti-glare screen.

Noise

- Try to set up your office in a separate room if possible and away from the rest of the house.

Chair

- Comfort is personal but should be part of the selection.
- Seat pan design; deep and wide enough.
- Rounded front edge (waterfall).
- Adjustable slope seat.
- Able to adjust your chair, to obtain appropriate height.
- Sit back in your chair, with your thighs parallel to the floor.
- Place feet flat on the floor, a footlocker may be required.

Footlocker

- A footlocker helps to prevent possible discomfort resulting from outstretched feet.
- The rocking motion creates light activity in the legs and feet and will help stimulate muscles to improve overall circulation.

Keyboard

- Has a palm rest.
- Easily adjusts the angle of the keyboard.
- Easily adjusts the keyboard height.

Document holder

- A curved back document holder reduces glare.
- Position document holder in line with the monitor to reduce eyestrain.

Monitor

- There should be a direct line from the center of the monitor to the "J" key on your keyboard which should line up with your belt buckle.
- Position the monitor at arm's length.
- Make sure the top of your monitor screen is slightly below eye level.
- A monitor stand may be used to achieve desired height.

Workstation

- Adequate space beneath the worksurface for your legs.
- Depth of the worksurface depends on the task and equipment used to perform this responsibility.
- Try to place tasks that are performed regularly within arm's reach.
- Avoid unnecessary reaching and bending which leads to fatigue and possible muscle strains and can reduce efficiency.
- Keep in mind other related tasks in your planning.
- Establish your workflow then design the essential elements to meet your requirements.

desking - laminate



Adaptabilities

9



Genoa

48



Princeton

60



Zira

108

The following applies to all series **EXCEPT Princeton**. For information on the **Princeton** series, please refer to page 60.

- Outside and surface panels are made from 1" thick 45 lb. density particle board and covered on both sides with high performance thermally fused laminate. Modesty panels are $\frac{1}{16}$ " thick.
- **FILE DRAWERS** use full extension steel ball bearing slides for smooth action.
BOX DRAWERS use $\frac{3}{4}$ extension steel ball bearing slides for a smooth action.
- **BOX AND FILE PEDESTALS** are standard and are constructed independently of the chassis, with fully closed bottoms. This picture frame construction technique prevents racking, and provides a product that lasts for years.
- **FILE DRAWERS** file legal and letter documents as standard (letter files will file in both directions, as will lateral files).
- Drawers and end panels are **EDGE BANDED** on all four sides to protect clothing and the floor covering.
- Locks are standard on all box and file pedestals, lateral files, storage cabinets and combination storage units.
- All locking components within each series can be keyed alike at no additional charge. Please specify the request at time of order.
- Standard key numbers are 401 through 440.
- Drawers are opened with side pulls and are constructed 22" deep (Genoa 18"D). Woodgrain enameled bottoms are routed into the woodgrain (MDF) sides on three edges.
- Pencil tray included with each desk.
- **LEVELING GLIDES** are standard on all units.
- All units are **shipped fully assembled** (except where noted) on 1" x 3" thick wood furniture skids with pedestal supports inside high quality cartons.
- **ALL "L" SHAPED DESKS** have flush backs on the return (modesty panels).
- Additional options available include (add suffix to item number):
FM = full modesty panel. Available on any desk or credenza. **Add \$62.** (Standard on Adaptabilities & Zira.)
FP = full modesty panel. Available on any desk or credenza. **Add \$62.** (Genoa only.)
- Desks with full to floor pedestals **cannot** have $\frac{3}{4}$ modesty panels.
- Corners must have matching modesty panels (both sides must be either $\frac{3}{4}$ or full modesty panels).
- **Modesty panels** on corners will be 1" above the floor. **Modesty panels** on returns are flush with the floor. It is recommended that corner units are used for corner spaces when configuring workstations so there is no visible difference if a corner is connected to a return.
- Optional grommets are available. **SEE EACH series** for details. **Add \$91.**
- Global will consider custom, specials and product alterations on an individual basis.
- Desk series can only be made in **standard Global laminates**.
- **PLEASE REFER TO SERIES FOR AVAILABLE FINISHES.** The following desk finishes are offered:

WOODGRAINS:	Absolute Acajou (ACJ) Asian Night (ASN) Avant Cherry (AWC) Avant Honey (AWH) Clear Maple (CMB) Dark Espresso (DES)	Fashionista (FAS) First Class (FCL) Noce Biondo (NBL) Noce Grigio (NGL) Noce Leggero (NEL) Noce Medio (NML)	Quartered Mahogany (QTM) Sheer Beauty (SBY) Walnut Heights (WHE) White Chocolate (WHC) Winter Cherry (WCR)
SOLIDS:	Black (BLK) Designer White (DWT)	Blizzard (BZD) Stonedust (SDT)	Custom Grey (CGY) Storm Grey (SOG)
PATTERNS:	Brushed Cobalt (BRC)		

- For additional options, see **Productivity Solutions** page 454.



With over 370 components available in 400 color combinations, Adaptabilities provides the ultimate in flexibility and modularity. Rich laminate colors coordinate easily with any office or home decor. All surfaces are constructed from Global's exclusive premium grade, high performance laminate and finished in preferred matching edges.

Adaptabilities features an extensive range of versatile components which can be configured into multi-user workstations suitable for intensive task functions, or for private executive suites requiring stately elegance and workforce functions. All laminate filing cabinets have a safety mechanism that prevents two drawers from being opened at the same time. File drawers have fully progressive ball bearing suspensions and accommodate letter or legal filing. For heavy duty usage, two, three and four drawer laminate files are available with steel drawer interiors.

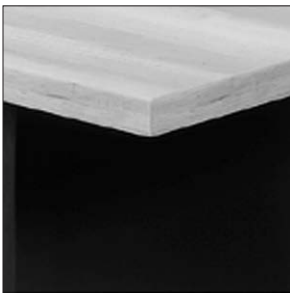

Tops are 1" thick with a top over side, edge panel design.



3/4 modesty panel is available at no extra charge.



For heavy duty usage, two, three and four drawer laminate files are available with steel drawer interiors.

Features and Benefits

- 45 lb. density particle board substructure with high performance thermally fused laminate.
- 1" thick worksurfaces in thermally fused or high pressure laminate.
- Worksurfaces feature 2mm edging in matching color.
- All desks are size (incrementally) accurate.
- 11/16" thick full modesty panel is standard.
- 11/16" thick 3/4 modesty panel is available on most components.
- Pencil tray included in the box drawer.
- File drawers accommodate letter or legal documents.
- Full progressive ball bearing suspension on file drawers.
- All drawer fronts edge banded with side pull opening pedestals and standard with pedestal locks.
- Compatible with **Divide** panel systems for increased privacy and storage requirements.

GENERAL INFORMATION

- Constructed of 45 lb. density particle board with high performance thermally fused laminate.
- Adaptabilities components are compatible with Divide transaction tops and partitioning panels. See page 290 for Divide specifications and prices.
- See page 42 for keyboard drawers and additional accessory options.
- Adaptabilities desk and storage products have been tested and comply with all BIFMA mechanical tests.
- For environmental certification, please visit globalfurnituregroup.com.

WORKSURFACES

- 1" thick high performance thermally fused laminate tops sealed with Global's preferred edging in matching color. Woodgrain surfaces feature edging with matching printed woodgrain.
- High pressure tops are available in all Adaptabilities laminate finishes at an extended lead time. Please see model # for pricing and availability.

EDGE DETAIL

- Two edge options



A3 1" top, standard flat edge



AR 1" top, bicut edge

CONSTRUCTION

- Constructed of 45 lb. density particle board with high performance thermally fused laminate.
- Cabinets and wardrobes are 65" high to match overall height of a worksurface with hutch (worksurface 29" + hutch 36" = 65").
- 65" high end shelves are also available to match overall height.
- Models with monoposts are available with Black (**TBL**) or Tungsten (**TTU**) monoposts, please specify.
- Models with handles are available with Black (**HX**) or Silver (**HS**) handles, please specify.
- All drawer fronts edge banded with side pull opening pedestals and standard pedestal locks.
- Double wall pedestal housing with fully closed bottom.

MODESTY PANELS

- $\frac{1}{16}$ " thick full modesty panel is standard.
- $\frac{1}{16}$ " thick $\frac{3}{4}$ modesty panel available on most components.
- $\frac{3}{4}$ height modesty panels available on most models at no additional charge. Please specify (**34**). (Corners must have both modesty panels as $\frac{3}{4}$ or full.)
- **Note:** Woodgrain modesty panels over 60" wide will have the grain pattern in a horizontal direction. All end panels and modesty panels 60" or less will have the grain pattern in a vertical direction.

STORAGE

- Storage top is optional with worksurface edge option (**A3**) or (**AR**).
- All lateral file drawer fronts feature the woodgrain running in a horizontal direction.
- Pencil tray included in box drawer.
- File drawers can accommodate letter or legal documents.
- Triple progressive ball bearing suspension on file drawers.

LOCKS

- Optional locks available for all straight hutch unit doors. **Add \$119** each lock.
- Front-to-back filing bars for all steel drawer files available separately. Order FBB file bars. See page 42 for pricing.
- Locks are Black with Black (**HX**) and Silver (**HS**) handles.

SPECIAL SIZES

- Special widths are available on most products with open knee space and/or units with open or hinged door storage configurations. To price, take the list price of the next larger standard size up and add **10%**. Quotations are not required, some exceptions may apply.
- For custom widths outside of the range of standard sizes published or any custom depths, submit a SPECIALS / MTM quote request through the Global Dealer Center.
- Orders must indicate the custom quote number and list price.
- Changes to custom quotes are not permitted. Any revisions will necessitate a new quotation.
- Adaptabilities boardroom table tops are now available with bicut edge at no upcharge. Please specify (**CR**).

HUTCHES

- 71" hutches are for use when a hutch is placed across the back of a 42" wide return and across the depth of a 29.63" (30") deep surface top.

SPECIFICATIONS

- Specifications marked with an * are applicable to only those products which have the * symbol beside the product name.

1. SPECIFY MODEL NUMBER

2. SPECIFY FINISH

One Tone Finishes:

ACJ	Absolute Acajou
ASN	Asian Night
AWC	Avant Cherry
AWH	Avant Honey
BLK	Black
BZD	Blizzard
BRC	Brushed Cobalt
CMB	Clear Maple
CGY	Custom Grey
DES	Dark Espresso
DWT	Designer White
FAS	Fashionista
FCL	First Class
NBL	Noce Biondo
NGL	Noce Grigio
NEL	Noce Leggero
NML	Noce Medio
QTM	Quartered Mahogany
SBY	Sheer Beauty
SDT	Stonedust
SOG	Storm Grey
WHE	Walnut Heights
WHC	White Chocolate
WCR	Winter Cherry

Top Finishes:

ACJ	Absolute Acajou
ASN	Asian Night
AWC	Avant Cherry
AWH	Avant Honey
BLK	Black
BZD	Blizzard
BRC	Brushed Cobalt
CMB	Clear Maple
CGY	Custom Grey
DES	Dark Espresso
DWT	Designer White
FAS	Fashionista
FCL	First Class
NBL	Noce Biondo
NGL	Noce Grigio
NEL	Noce Leggero
NML	Noce Medio
QTM	Quartered Mahogany
SBY	Sheer Beauty
SDT	Stonedust
SOG	Storm Grey
WHE	Walnut Heights
WHC	White Chocolate
WCR	Winter Cherry

Body Finishes (including pedestals):

ACJ	Absolute Acajou
ASN	Asian Night
AWC	Avant Cherry
AWH	Avant Honey
BLK	Black
BZD	Blizzard
BRC	Brushed Cobalt
CMB	Clear Maple
CGY	Custom Grey
DES	Dark Espresso
DWT	Designer White
FAS	Fashionista
FCL	First Class
NBL	Noce Biondo
NGL	Noce Grigio
NEL	Noce Leggero
NML	Noce Medio
QTM	Quartered Mahogany
SBY	Sheer Beauty
SDT	Stonedust
SOG	Storm Grey
WHE	Walnut Heights
WHC	White Chocolate
WCR	Winter Cherry

3. SPECIFY OPTIONS

GROMMETS

- Additional grommets available in standard worksurface locations (left, center or right).
- Order as: **FOG1, FOG2 or FOG3. Add \$91.**

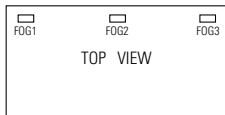

- Grommet hole dimensions are 3.25" wide x 1.875" deep.
- Actual grommet locations on the worksurface are depicted in the example drawings shown below. Dimensions shown are actual measurements (in inches).

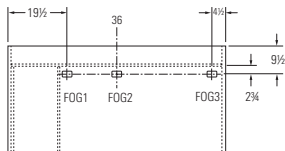

36 x 72 single pedestal left desks (A3672SPL)

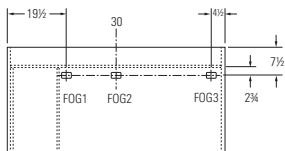

30 x 60 single pedestal left desks (A3060SPL)

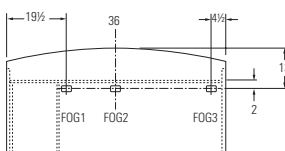

36 x 72 single pedestal left bow top desks (A3672SLB)

- Grommets may be placed at non-standard locations. Order **CSG. Add \$132.** A drawing must be supplied with vertical and horizontal dimensions to the center of the cut-out (as in drawings on the left). Please refer to the **custom grommet location** form in the back reference section.
- Components that come standard with a grommet may be ordered without a grommet order **RSG. Add \$51.**
- Grommets are available on modesty panels of extended corners and 5-sided corners 6.5" in where the two modesty panels meet at a 90° angle. Please specify **FOGMPR** for right grommet placement and **FOGMPL** for left grommet placement (as shown on diagrams below). Cost is **\$132.**
- Modesty panels are 1" off of ground.

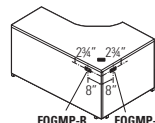

Left extended corner unit

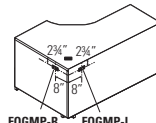

Right extended corner unit

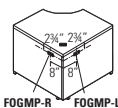

5-sided corner unit

POWER BLOCK

- A power block (model **PMSPDM**) may be ordered on all worksurfaces.
- A power block is a rectangular worksurface power/data module with one electrical duplex receptacle and includes two data (RJ45) receptacles. 9 foot Black cord included. Power block dimensions are 6.5"W x 3.5"D x 2.75"H.
- To purchase a power block, you must specify both the power block cut-out location and the power block model #. Order power block as **PMSPDM. Add \$268.**
- Power blocks are available in standard worksurface locations (left, center or right). Order as **E1, E2 or E3. Add \$91.**

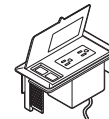

Power block **PMSPDM. Add \$268.**

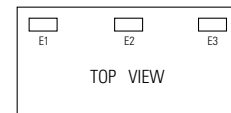

Specify location **E1, E2 or E3. Add \$91.**

A ADAPTABILITIES®

DOUBLE PEDESTAL DESKS

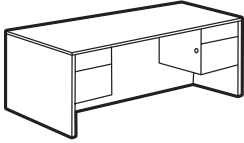

Double Pedestal Desk*

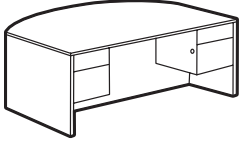

Double Pedestal Bow Top Desk*

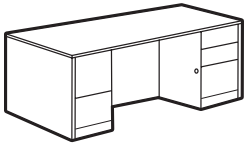

Full to Floor Double Pedestal Desk

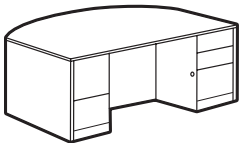

Full to Floor Double Pedestal Bow Top Desk

MODEL #	DIMENSIONS	WT/LB.	CUBIC FT.	LIST PRICE	HP ADD
---------	------------	--------	-----------	------------	--------

W x D x H

A3672DP	72 x 36 x 29.6	296	52.5	\$1662	\$471
A3072DP	72 x 29.69 x 29.6	263	43	\$1775	\$440
A3066DP	66 x 29.69 x 29.6	254	39.75	\$1656	\$404
A3060DP	60 x 29.69 x 29.6	247	36.25	\$1504	\$404

Standard with box/file pedestals on both sides. Pedestals lock. One pencil tray. Shipped assembled in 1 carton.

A3672DPB	72 x 30-36 x 29.6	280	52.5	\$1963	\$471
----------	-------------------	-----	------	---------------	--------------

Standard with box/file pedestals on both sides and bow top. Pedestals lock. One pencil tray. Shipped assembled in 1 carton.

A3672D4	72 x 36 x 29.6	330	52.5	\$2244	\$471
A3072D4	72 x 30 x 29.6	295	43.75	\$2244	\$471
A3066D4	66 x 29.69 x 29.6	285	39.75	\$2150	\$404
A3060D4	60 x 29.69 x 29.6	276	36.25	\$1886	\$404

Standard with full to floor box/box/file on right pedestal and file/file on left pedestal. Pedestals lock. On box/box/file pedestal, lower box drawer and file drawer lock. One pencil tray. Shipped assembled in 1 carton.

A3672DB4	72 x 32-36 x 29.6	311	52.5	\$2473	\$471
----------	-------------------	-----	------	---------------	--------------

Standard with full to floor box/box/file on right pedestal and file/file on left pedestal. Bow top. Pedestals lock. On box/box/file pedestal, lower box drawer and file drawer lock. One pencil tray. Shipped assembled in 1 carton.

SINGLE PEDESTAL DESKS

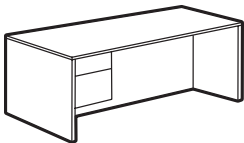

Single Pedestal Desk - LEFT*

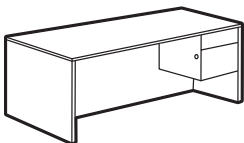

Single Pedestal Desk - RIGHT*

A3672SPL	72 x 36 x 29.6	245	52.5	\$1418	\$471
A3072SPL	72 x 29.69 x 29.6	216	43	\$1378	\$440
A3066SPL	66 x 29.69 x 29.6	207	39.75	\$1311	\$404
A3060SPL	60 x 29.69 x 29.6	197	36.25	\$1227	\$404
A3048SPL	48 x 29.69 x 29.6	177	29.25	\$1138	\$345
A2448SPL	48 x 24 x 29.6	150	24.25	\$1138	\$239

Standard with box/file pedestal on **left**. Pedestal locks. One pencil tray. Shipped assembled in 1 carton.

A3672SPR	72 x 36 x 29.6	245	52.5	\$1418	\$471
A3072SPR	72 x 29.69 x 29.6	216	43	\$1378	\$440
A3066SPR	66 x 29.69 x 29.6	207	39.75	\$1311	\$404
A3060SPR	60 x 29.69 x 29.6	197	36.25	\$1227	\$404
A3048SPR	48 x 29.69 x 29.6	177	29.25	\$1138	\$345
A2448SPR	48 x 24 x 29.6	150	24.25	\$1138	\$239

Standard with box/file pedestal on **right**. Pedestal locks. One pencil tray. Shipped assembled in 1 carton.

Required specifications

Top finish
Base finish
Edge detail

Optional specifications

Key #
Grommet position or power block cut-out
HP laminate
¾ modesty panel*

Accessories

Power block
Keyboard tray
Pencil tray

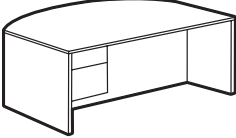
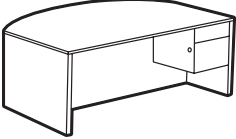
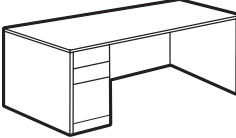
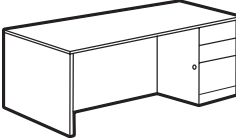
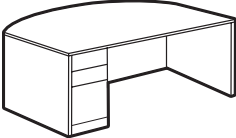
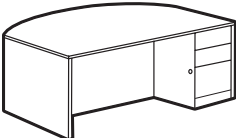
SINGLE PEDESTAL DESKS	MODEL #	DIMENSIONS W x D x H	WT/LB.	CUBIC FT.	LIST PRICE	HP ADD
	A3672SLB	72 x 30-36 x 29.6	233	52.5	\$1572	\$471
Single Pedestal Bow Top Desk - LEFT*	Standard with box/file pedestal on the left and bow top. Pedestal locks. One pencil tray. Shipped assembled in 1 carton.					
	A3672SRB	72 x 30-36 x 29.6	233	52.5	\$1572	\$471
Single Pedestal Bow Top Desk - RIGHT*	Standard with box/file pedestal on the right and bow top. Pedestal locks. One pencil tray. Shipped assembled in 1 carton.					
	A3672S4L	72 x 36 x 29.6	261	52.5	\$1606	\$471
	A3072S4L	72 x 29.69 x 29.6	232	43.75	\$1606	\$471
	A3066S4L	66 x 29.69 x 29.6	221	39.5	\$1484	\$404
	A3060S4L	60 x 29.69 x 29.6	211	36.25	\$1419	\$404
	A3048S4L	48 x 29.69 x 29.6	191	29.5	\$1340	\$345
	A2448S4L	48 x 24 x 29.6	164	24.25	\$1340	\$239
Full to Floor Single Pedestal Desk - LEFT	Standard with full to floor box/box/file pedestal on the left . Lower box drawer and file drawer lock. One pencil tray. Shipped assembled in 1 carton.					
	A3672S4R	72 x 36 x 29.6	261	52.5	\$1606	\$471
	A3072S4R	72 x 29.69 x 29.6	232	43.75	\$1606	\$471
	A3066S4R	66 x 29.69 x 29.6	221	39.75	\$1484	\$404
	A3060S4R	60 x 29.69 x 29.6	211	36.25	\$1419	\$404
	A3048S4R	48 x 29.69 x 29.6	191	29.5	\$1340	\$345
	A2448S4R	48 x 24 x 29.6	164	24.25	\$1340	\$239
Full to Floor Single Pedestal Desk - RIGHT	Standard with full to floor box/box/file pedestal on the right . Lower box drawer and file drawer lock. One pencil tray. Shipped assembled in 1 carton.					
	A3672S4LB	72 x 32-36 x 29.6	247	52.5	\$1835	\$471
Full to Floor Single Pedestal Bow Top Desk - LEFT	Standard with box/box/file pedestal on the left and bow top. Lower box drawer and file drawer lock. One pencil tray. Shipped assembled in 1 carton.					
	A3672S4RB	72 x 32-36 x 29.6	247	52.5	\$1835	\$471
Full to Floor Single Pedestal Bow Top Desk - RIGHT	Standard with box/box/file pedestal on the right and bow top. Lower box drawer and file drawer lock. One pencil tray. Shipped assembled in 1 carton.					

Required specifications

Top finish
Base finish
Edge detail

Optional specifications

Key #
Grommet position or power block cut-out
HP laminate
¾ modesty panel*

Accessories

Power block
Keyboard tray
Pencil tray

A ADAPTABILITIES®

RETURNS

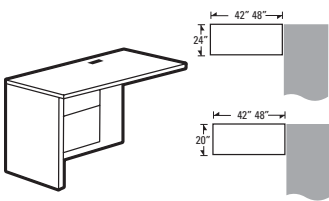

Flush Return - LEFT*

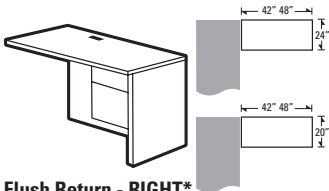

Flush Return - RIGHT*

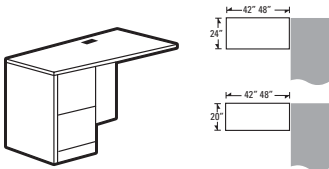

Full to Floor Flush Return - LEFT*

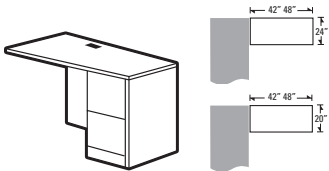

Full to Floor Flush Return - RIGHT*

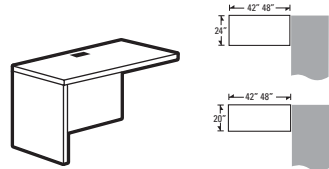

Flush Return - LEFT

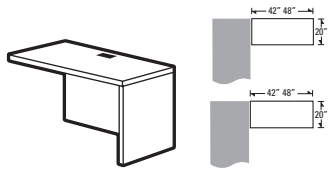

Flush Return - RIGHT

MODEL

DIMENSIONS

WT/LB.

CUBIC FT.

LIST PRICE

HP ADD

W x D x H

A2448FL	48 x 24 x 29.6	141	24	\$1013	\$239
A2442FL	42 x 24 x 29.6	131	21.25	\$1013	\$202
A2048FL	48 x 20 x 29.6	128	20.25	\$957	\$202
A2042FL	42 x 20 x 29.6	119	18	\$957	\$202

Standard with box/file drawer pedestal on the **left**. One pencil tray. Pedestal locks. Grommet in worksurface. Shipped assembled in 1 carton.

A2448FR	48 x 24 x 29.6	141	24	\$1013	\$239
A2442FR	42 x 24 x 29.6	131	21.25	\$1013	\$202
A2048FR	48 x 20 x 29.6	128	20.25	\$957	\$202
A2042FR	42 x 20 x 29.6	119	18	\$957	\$202

Standard with box/file drawer pedestal on the **right**. One pencil tray. Pedestal locks. Grommet in worksurface. Shipped assembled in 1 carton.

A2448L4	48 x 24 x 29.6	156	24.25	\$1279	\$239
A2442L4	42 x 24 x 29.6	146	21.5	\$1279	\$202
A2048L4	48 x 20 x 29.6	142	20.5	\$1202	\$202
A2042L4	42 x 20 x 29.6	133	18	\$1202	\$202

Standard with file/file drawer pedestal on the **left**. One pencil tray. Pedestal locks. Grommet in worksurface. Shipped assembled in 1 carton.

A2448R4	48 x 24 x 29.6	156	24.25	\$1279	\$239
A2442R4	42 x 24 x 29.6	146	21.5	\$1279	\$202
A2048R4	48 x 20 x 29.6	142	20.5	\$1202	\$202
A2042R4	42 x 20 x 29.6	133	18	\$1202	\$202

Standard with file/file drawer pedestal on the **right**. One pencil tray. Pedestal locks. Grommet in worksurface. Shipped assembled in 1 carton.

A2448EL	48 x 24 x 29.6	92	4.3	\$710	\$239
A2442EL	42 x 24 x 29.6	82	3.8	\$710	\$202
A2048EL	48 x 20 x 29.6	84	4.3	\$655	\$202
A2042EL	42 x 20 x 29.6	75	3.8	\$655	\$202

Return has no pedestal. Grommet in worksurface. Shipped easy to assemble in 1 carton.

A2448ER	48 x 24 x 29.6	92	4.3	\$710	\$239
A2442ER	42 x 24 x 29.6	82	3.8	\$710	\$202
A2048ER	48 x 20 x 29.6	84	4.3	\$655	\$202
A2042ER	42 x 20 x 29.6	75	3.8	\$655	\$202

Return has no pedestal. Grommet in worksurface. Shipped easy to assemble in 1 carton.

Required specifications

Top finish
Base finish
Edge detail

Optional specifications

Key #*
Grommet position or power block cut-out
HP laminate

Accessories

Power block
Keyboard tray
Pencil tray

SPACE SAVER RETURNS **MODEL #** **DIMENSIONS** **WT/LB.** **CUBIC FT.** **LIST PRICE** **HP ADD**

W x D x H

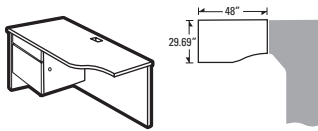

Space Saver Return - LEFT

A3048FSL	48 x 29.69 x 29.6	148	29	\$1095	\$283
----------	-------------------	-----	----	---------------	--------------

Standard with box/file pedestal on the **left**, grommet in worksurface. One pencil tray. Pedestal locks. Connects to 24"D 5-sided corner unit and 2466/2472 NFL or NNL extended corner unit. Shipped assembled in 1 carton.

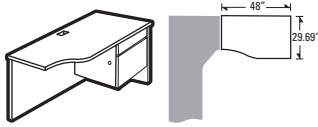

Space Saver Return - RIGHT

A3048FSR	48 x 29.69 x 29.6	148	29	\$1095	\$283
----------	-------------------	-----	----	---------------	--------------

Standard with box/file pedestal on the **right**, grommet in worksurface. One pencil tray. Pedestal locks. Connects to 24"D 5-sided corner unit and 2466/2472 FNR or NNR extended corner unit. Shipped assembled in 1 carton.

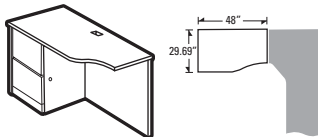

Space Saver Return - LEFT

A3048P4L	48 x 29.69 x 29.6	170	29	\$1407	\$345
----------	-------------------	-----	----	---------------	--------------

Standard with file/file pedestal on the **left**, grommet in worksurface. One pencil tray. Pedestal locks. Connects to 24"D 5-sided corner unit and 2466/2472 NFL or NNL extended corner unit. Shipped assembled in 1 carton.

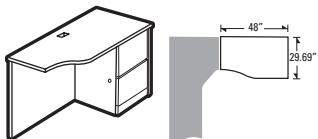

Space Saver Return - RIGHT

A3048P4R	48 x 29.69 x 29.6	170	29	\$1407	\$345
----------	-------------------	-----	----	---------------	--------------

Standard with file/file pedestal on the **right**, grommet in worksurface. One pencil tray. Pedestal locks. Connects to 24"D 5-sided corner unit and 2466/2472 FNR or NNR extended corner unit. Shipped assembled in 1 carton.

FLUSH BRIDGES

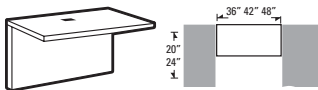

Flush Bridge*

A2448FB	48 x 24 x 29.6	75	4.3	\$629	\$239
A2442FB	42 x 24 x 29.6	65	3.8	\$629	\$202
A2436FB	36 x 24 x 29.6	58	3.3	\$586	\$152
A2048FB	48 x 20 x 29.6	71	4.3	\$484	\$202
A2042FB	42 x 20 x 29.6	65	3.8	\$460	\$202
A2036FB	36 x 20 x 29.6	54	3.3	\$434	\$152

Top surface, back panel and hardware to connect two units. Grommet in worksurface. Shipped easy to assemble in 1 carton.

CREDENZAS



Center Storage Credenza**

A2072C	72 x 20 x 29.6	243	30	\$1811	\$314
--------	----------------	-----	----	---------------	--------------

Standard with box/file pedestals on both sides and self-closing, hinged, center doors covering one adjustable shelf. Pedestals and doors lock. One pencil tray. Shipped assembled in 1 carton.

Required specifications

- Top finish
- Base finish
- Handles**
- Edge detail

Optional specifications

- Key #
- Additional grommet position (not A2072C)
- HP laminate
- Power block cut-out (not A2072C)

Accessories

- Power block
- Keyboard tray*
- Pencil tray*

A ADAPTABILITIES®

CREDENZAS

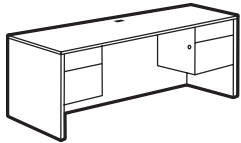

Kneespace Credenza

MODEL #	DIMENSIONS W x D x H	WT/LB.	CUBIC FT.	LIST PRICE	HP ADD
A2472CK	72 x 24 x 29.6	234	35.75	\$1750	\$325
A2466CK	66 x 24 x 29.6	225	32.75	\$1750	\$300
A2072CK	72 x 20 x 29.6	212	30.25	\$1498	\$314
A2066CK	66 x 20 x 29.6	204	27.75	\$1498	\$300
A2060CK	60 x 20 x 29.6	199	25.25	\$1469	\$276

Standard with box/file pedestals on both sides. Center is open. Pedestals lock. One pencil tray. Grommet in worksurface. Shipped assembled in 1 carton.

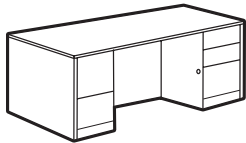

Full to Floor Kneespace Credenza

A2472D4	72 x 24 x 29.6	261	35.5	\$2438	\$325
A2466D4	66 x 24 x 29.6	252	33	\$2438	\$300
A2072D4	72 x 20 x 29.6	236	30	\$2080	\$314
A2066D4	66 x 20 x 29.6	228	27.75	\$2080	\$300
A2060D4	60 x 20 x 29.6	220	25.25	\$2018	\$276

Standard with full to floor box/box/file on right pedestal and file/file on left pedestal. Pedestal locks on box/box/file pedestal, lower box drawer and file drawer lock. One pencil tray. Shipped assembled in 1 carton.

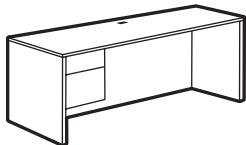

Single Pedestal Credenza - LEFT

A2472CSL	72 x 24 x 29.6	190	35.75	\$1407	\$325
A2466CSL	66 x 24 x 29.6	181	32.75	\$1407	\$300
A2072CSL	72 x 20 x 29.6	172	30.25	\$1194	\$314
A2066CSL	66 x 20 x 29.6	163	27.75	\$1194	\$300
A2060CSL	60 x 20 x 29.6	155	25.25	\$1130	\$276

Standard with box/file pedestal on the **left**. Pedestal locks. One pencil tray. Grommet in worksurface. Shipped assembled in 1 carton.

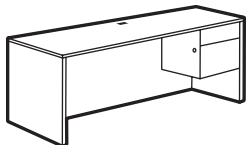

Single Pedestal Credenza - RIGHT

A2472CSR	72 x 24 x 29.6	190	35.75	\$1407	\$325
A2466CSR	66 x 24 x 29.6	181	32.75	\$1407	\$300
A2072CSR	72 x 20 x 29.6	171	30.25	\$1194	\$314
A2066CSR	66 x 20 x 29.6	163	27.75	\$1194	\$300
A2060CSR	60 x 20 x 29.6	155	25.25	\$1130	\$276

Standard with box/file pedestal on the **right**. Pedestal locks. One pencil tray. Grommet in worksurface. Shipped assembled in 1 carton.

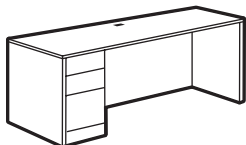

Full to Floor Single Pedestal Credenza - LEFT

A2472S4L	72 x 24 x 29.6	205	35.5	\$1629	\$314
A2466S4L	66 x 24 x 29.6	196	33	\$1629	\$300
A2072S4L	72 x 20 x 29.6	187	30	\$1373	\$314
A2066S4L	66 x 20 x 29.6	177	27.75	\$1373	\$314
A2060S4L	60 x 20 x 29.6	168	25.25	\$1300	\$276

Standard with full to floor box/box/file pedestal on the **left**. Lower box drawer and file drawer lock. Grommet in worksurface. One pencil tray. Shipped assembled in 1 carton.

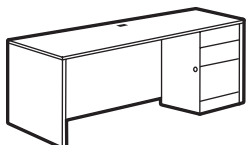

Full to Floor Single Pedestal Credenza - RIGHT

A2472S4R	72 x 24 x 29.6	205	35.5	\$1629	\$314
A2466S4R	66 x 24 x 29.6	196	33	\$1629	\$300
A2072S4R	72 x 20 x 29.6	187	30	\$1373	\$314
A2066S4R	66 x 20 x 29.6	177	27.75	\$1373	\$314
A2060S4R	60 x 20 x 29.6	168	25.25	\$1300	\$276

Standard with full to floor box/box/file pedestal on the **right**. Lower box drawer and file drawer lock. Grommet in worksurface. One pencil tray. Shipped assembled in 1 carton.

Required specifications

Top finish
Base finish
Edge detail

Optional specifications

Key #
Grommet position or power block cut-out
HP laminate

Accessories

Power block
Keyboard tray
Pencil tray

CREDENZAS	MODEL #	DIMENSIONS	WT/LB.	CUBIC FT.	LIST PRICE	HP ADD
-----------	---------	------------	--------	-----------	------------	--------

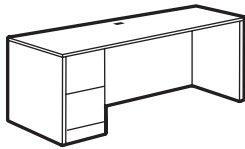

Full to Floor Single Pedestal Credenza - LEFT*

	W x D x H					
A2472S2L	72 x 24 x 29.6	205	35.5	\$1483	\$314	
A2466S2L	66 x 24 x 29.6	196	32.75	\$1483	\$300	
A2072S2L	72 x 20 x 29.6	187	30.25	\$1401	\$314	
A2066S2L	66 x 20 x 29.6	177	27.75	\$1401	\$314	
A2060S2L	60 x 20 x 29.6	168	25.25	\$1341	\$276	

Standard with full to floor file/file pedestal on the **left**. Pedestal Locks. Grommet in worksurface. Shipped assembled in 1 carton.

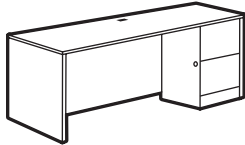

Full to Floor Single Pedestal Credenza - RIGHT*

A2472S2R	72 x 24 x 29.6	205	35.5	\$1483	\$314	
A2466S2R	66 x 24 x 29.6	196	32.75	\$1483	\$300	
A2072S2R	72 x 20 x 29.6	187	30.25	\$1401	\$314	
A2066S2R	66 x 20 x 29.6	177	27.75	\$1401	\$314	
A2060S2R	60 x 20 x 29.6	168	25.25	\$1341	\$276	

Standard with full to floor file/file pedestal on the **right**. Pedestal locks. Grommet in worksurface. Shipped assembled in 1 carton.

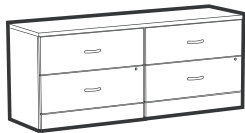

Lateral File Credenza

A2472LF2	72 x 24 x 29.6	322	35.75	\$2703	\$314	
A2072LF2	72 x 20 x 29.6	296	30.25	\$2647	\$314	

Two 2-drawer lateral files side-by-side. Locking drawers, keyed alike. File bars included for side-to-side and front-to-back letter/legal filing capability. Anti-lock tilt suspension. Shipped assembled in 1 carton.

- MUST specify Black (**HX**) or Silver (**HS**) finish for handles.
- *File drawer construction is for accommodating hanging files NOT for stacking materials on the drawer bottom.*

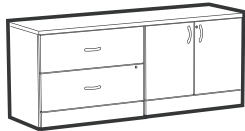

Lateral File/Storage Cabinet Credenza

A2472LS	72 x 24 x 29.6	297	35.75	\$2421	\$314	
A2072LS	72 x 20 x 29.6	267	30.25	\$2364	\$314	

One 2-drawer lateral file on the **left** and one storage cabinet on the **right**. Locking doors/drawers, keyed alike. Storage cabinet includes one adjustable shelf. File bars included for side-to-side and front-to-back letter/legal filing capability. Anti-lock tilt suspension. Shipped assembled in 1 carton.

- MUST specify Black (**HX**) or Silver (**HS**) finish for handles.
- *File drawer construction is for accommodating hanging files NOT for stacking materials on the drawer bottom.*



Kneespace Lateral File Credenza - LEFT*

A2472LKL	72 x 24 x 29.6	239	35.75	\$2126	\$314	
A2072LKL	72 x 20 x 29.6	216	30.25	\$2071	\$314	

One 2-drawer lateral file on the **left**. Locking drawers. File bars included for side-to-side and front-to-back letter/legal filing capability. Anti-lock tilt suspension. Grommet in worksurface. Shipped assembled in 1 carton.

- MUST specify Black (**HX**) or Silver (**HS**) finish for handles.
- *File drawer construction is for accommodating hanging files NOT for stacking materials on the drawer bottom.*

Required specifications

Top finish
Base finish
Handles (not A2xxxS2L/A2xxxS2R)
Edge detail

Optional specifications

Key #
Additional grommet
HP laminate
Power block cut-out*

Accessories

Power block*
Keyboard tray*
Pencil tray*

A ADAPTABILITIES®

CREDENZAS



Kneespace Lateral File Credenza - RIGHT

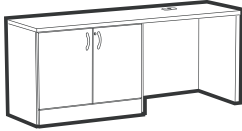

Kneespace Storage Cabinet Credenza - LEFT

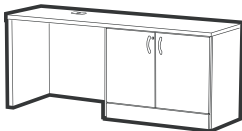

Kneespace Storage Cabinet Credenza - RIGHT

MODEL #	DIMENSIONS	WT/LB.	CUBIC FT.	LIST PRICE	HP ADD
W x D x H					
A2472LKR	72 x 24 x 29.6	239	35.75	\$2126	\$314
A2072LKR	72 x 20 x 29.6	216	30.25	\$2071	\$314

One 2-drawer lateral file on the **right**. Locking drawers. File bars included for side-to-side and front-to-back letter/legal filing capability. Anti-lock tilt suspension. Grommet in worksurface. Shipped assembled in 1 carton.

- MUST specify Black (**HX**) or Silver (**HS**) finish for handles.
- File drawer construction is for accommodating hanging files **NOT** for stacking materials on the drawer bottom.

A2472SKL	72 x 24 x 29.6	218	35.75	\$1674	\$314
A2072SKL	72 x 20 x 29.6	188	30.25	\$1618	\$314

One storage cabinet on the **left**. Locking doors. Storage cabinet has one adjustable shelf. Grommet in worksurface. Shipped assembled in 1 carton.

- MUST specify Black (**HX**) or Silver (**HS**) finish for handles.

A2472SKR	72 x 24 x 29.6	218	35.75	\$1674	\$314
A2072SKR	72 x 20 x 29.6	188	30.25	\$1618	\$314

One storage cabinet on the **right**. Locking doors. Storage cabinet has one adjustable shelf. Grommet in worksurface. Shipped assembled in 1 carton.

- MUST specify Black (**HX**) or Silver (**HS**) finish for handles.

5-SIDED CORNERS

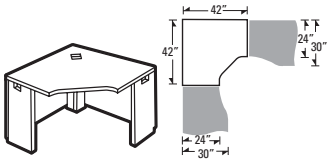

5-Sided Corner*

A42245C	42 x 42 x 29.6	113	5.75	\$1044	\$440
---------	----------------	-----	------	---------------	--------------

Connects to **30" D** space saver connectable surfaces, **24" D** connectables, returns and bridge. Grommet in worksurface. Narrow end panels on left and right. **Not freestanding**. Shipped easy to assemble in 1 carton.

- Modesty panel is 1" off of ground.

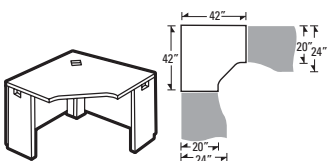

5-Sided Corner*

A42205C	42 x 42 x 29.6	110	5.75	\$1044	\$440
---------	----------------	-----	------	---------------	--------------

Connects to **24" D** space saver connectable surfaces, **20" D** returns, lateral files, storage/lateral file credenzas, credenzas, bridges and end shelves. Grommet in worksurface. Narrow end panels on left and right.

Not freestanding. Shipped easy to assemble in 1 carton.

- Modesty panel is 1" off of ground.

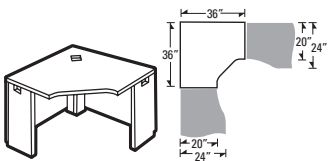

5-Sided Corner*

A36205C	36 x 36 x 29.6	94	4.8	\$891	\$283
---------	----------------	----	-----	--------------	--------------

Connects to **24" D** space saver connectable surfaces, **20" D** returns, lateral files, storage/lateral file credenzas, credenzas, bridges and end shelves. Grommet in worksurface. Narrow end panels on left and right.

Not freestanding. Shipped easy to assemble in 1 carton.

- Modesty panel is 1" off of ground.

Required specifications

Top finish
Base finish
Handles (only credenzas)
Edge detail

Optional specifications

Key #
Additional grommet position
HP laminate
Power block cut-out

Accessories

Power block
Keyboard tray*
Pencil tray

LEFT EXTENDED CORNERS **MODEL #** **DIMENSIONS** **WT/LB.** **CUBIC FT.** **LIST PRICE** **HP ADD**

W x D x H

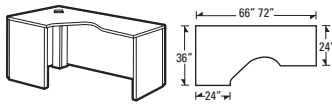

Left Extended Corner - Freestanding

Extended worksurface on right. **Full end panels on left and right. Cannot be connected on left or right due to full end panel.** Corner has one grommet. Shipped easy to assemble in 1 carton.

- **Modesty panel is 1" off of ground.**
- **A2466FFL cannot accept pedestals.**

A2472FFL	72 x 24-36 x 29.6	157	7	\$1269	\$471
A2466FFL	66 x 24-36 x 29.6	151	7	\$1209	\$471

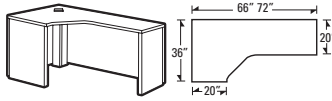

Left Extended Corner

Extended worksurface on right. **Full end panels on left and right. Cannot be connected on left or right due to full end panel.** Corner has one grommet. Shipped easy to assemble in 1 carton.

- **Modesty panel is 1" off of ground.**

A2072FFL	72 x 20-36 x 29.6	147	7	\$1249	\$453
A2066FFL	66 x 20-36 x 29.6	141	7	\$1209	\$453

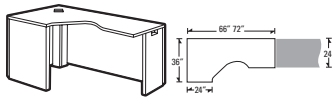

Left Extended Corner

Extended worksurface on right. **Narrow end panel on right. Full end panel on left.** Connects to 30"D space saver connectables, 24"D returns or 24"D connectable tables. **Full end panel cannot be connected.** Corner has one grommet. Shipped easy to assemble in 1 carton.

- **Modesty panel is 1" off of ground.**
- **A2466FNL cannot accept pedestals.**

A2472FNL	72 x 24-36 x 29.6	149	7	\$1249	\$471
A2466FNL	66 x 24-36 x 29.6	142	7	\$1209	\$453

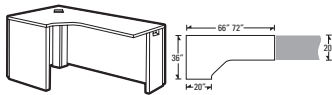

Left Extended Corner

Extended worksurface on right. **Narrow end panel on right. Full end panel on left.** Connects to 24"D space saver connectables, 20"D returns or 20"D connectable tables. **Full end panel cannot be connected.** Corner has one grommet. Shipped easy to assemble in 1 carton.

- **Modesty panel is 1" off of ground.**

A2072FNL	72 x 20-36 x 29.6	141	7	\$1229	\$453
A2066FNL	66 x 20-36 x 29.6	135	7	\$1185	\$453

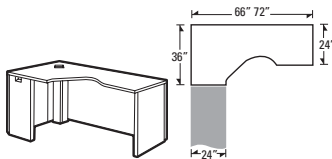

Left Extended Corner

Extended worksurface on right. **Narrow end panel on left. Full end panel on right.** Connects to 30"D space saver connectables, 24"D returns or 24"D connectable tables. **Full end panel cannot be connected.** Corner has one grommet. Shipped easy to assemble in 1 carton.

- **Modesty panel is 1" off of ground.**
- **A2466NFL cannot accept pedestals.**

A2472NFL	72 x 24-36 x 29.6	149	7	\$1249	\$471
A2466NFL	66 x 24-36 x 29.6	142	7	\$1209	\$453

Required specifications

- Top finish
- Base finish
- Edge detail

Optional specifications

- Additional grommet position
- HP laminate
- Power block cut-out

Accessories

- Power block
- Keyboard tray
- Pencil tray

A ADAPTABILITIES®

LEFT EXTENDED CORNERS

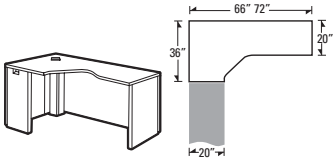

Left Extended Corner

MODEL #	DIMENSIONS W x D x H	WT/LB.	CUBIC FT.	LIST PRICE	HP ADD
A2072NFL	72 x 20-36 x 29.6	141	7	\$1229	\$471
A2066NFL	66 x 20-36 x 29.6	135	7	\$1185	\$453

Extended worksurface on right. **Narrow end panel on left. Full end panel on right.** Connects to 24"D space saver connectables and 20"D returns. **Full end panel can be connected.** Corner has one grommet. Shipped easy to assemble in 1 carton.

- **Modesty panel is 1" off of ground.**

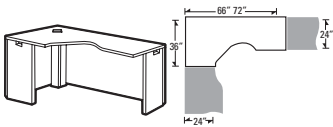

Left Extended Corner

A2472NNL	72 x 24-36 x 29.6	140	7	\$1229	\$471
A2466NNL	66 x 24-36 x 29.6	134	7	\$1185	\$453

Extended worksurface on right. **Narrow end panels on left and right.** Connects to 30"D space saver connectables, 24"D returns and 24"D connectable tables on either end. Corner has one grommet. Shipped easy to assemble in 1 carton.

- **Modesty panel is 1" off of ground.**
- **A2466NNL cannot accept pedestals.**

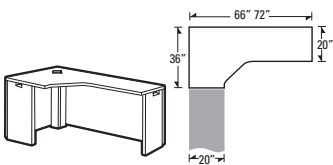

Left Extended Corner

A2072NNL	72 x 20-36 x 29.6	136	7	\$1209	\$471
A2066NNL	66 x 20-36 x 29.6	130	7	\$1166	\$453

Extended worksurface on right. **Narrow end panels on left and right.** Connects to 24"D space saver connectables and 20"D returns or bridge on either end. Corner has one grommet.

- **Modesty panel is 1" off of ground.**

RIGHT EXTENDED CORNERS

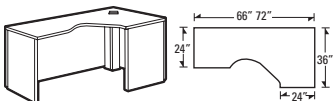

Right Extended Corner - Freestanding

A2472FFR	72 x 24-36 x 29.6	157	7	\$1269	\$471
A2466FFR	66 x 24-36 x 29.6	151	7	\$1209	\$471

Extended worksurface on left. **Full end panels on left and right. Cannot be connected on left or right due to full end panel.** Corner has one grommet. Shipped easy to assemble in 1 carton.

- **Modesty panel is 1" off of ground.**
- **A2466FFR cannot accept pedestals.**

Required specifications

Top finish
Base finish
Edge detail

Optional specifications

Additional grommet position
HP laminate
Power block cut-out

Accessories

Power block
Keyboard tray
Pencil tray

RIGHT EXTENDED CORNERS **MODEL #** **DIMENSIONS** **WT/LB.** **CUBIC FT.** **LIST PRICE** **HP ADD**

W x D x H

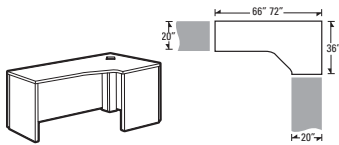

Right Extended Corner

Extended worksurface on left. **Full end panels on left and right. Cannot be connected on left or right due to full end panel.** Corner has one grommet. Shipped easy to assemble in 1 carton.

- Modesty panel is 1" off of ground.

A2072FFR	72 x 20-36 x 29.6	147	7	\$1249	\$453
A2066FFR	66 x 20-36 x 29.6	141	7	\$1209	\$453

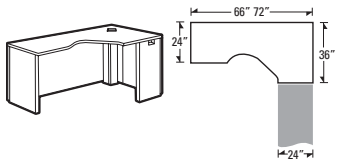

Right Extended Corner

Extended worksurface on left. **Narrow end panel on right. Full end panel on left.** Connects to 30"D space saver connectables, 24"D returns or 24"D connectable tables. **Full end panel cannot be connected.** Corner has one grommet. Shipped easy to assemble in 1 carton.

- Modesty panel is 1" off of ground.
- **A2466FNR** cannot accept pedestals.

A2472FNR	72 x 24-36 x 29.6	149	7	\$1249	\$471
A2466FNR	66 x 24-36 x 29.6	142	7	\$1209	\$453

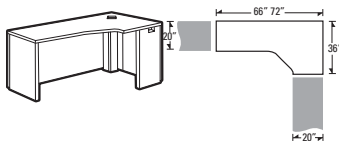

Right Extended Corner

Extended worksurface on left. **Narrow end panel on right. Full end panel on left.** Connects to 24"D space saver connectables, 20"D returns or 20"D connectable tables. **Full end panel cannot be connected.** Corner has one grommet. Shipped easy to assemble in 1 carton.

- Modesty panel is 1" off of ground.

A2072FNR	72 x 20-36 x 29.6	141	7	\$1229	\$471
A2066FNR	66 x 20-36 x 29.6	135	7	\$1185	\$453

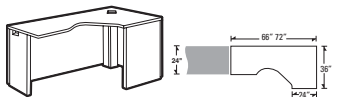

Right Extended Corner

Extended worksurface on left. **Narrow end panel on left. Full end panel on right.** Connects to 30"D space saver connectables, 24"D returns or 24"D connectable tables. **Full end panel cannot be connected.** Corner has one grommet. Shipped easy to assemble in 1 carton.

- Modesty panel is 1" off of ground.
- **A2466NFR** cannot accept pedestals.

A2472NFR	72 x 24-36 x 29.6	149	7	\$1249	\$471
A2466NFR	66 x 24-36 x 29.6	142	7	\$1209	\$453

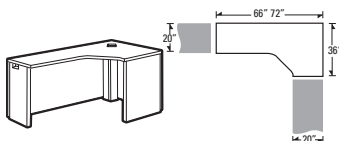

Right Extended Corner

Extended worksurface on left. **Narrow end panel on left. Full end panel on right.** Connects to 24"D space saver connectables, 20"D returns. **Full end panel cannot be connected.** Corner has one grommet. Shipped easy to assemble in 1 carton.

- Modesty panel is 1" off of ground.

A2072NFR	72 x 20-36 x 29.6	141	7	\$1229	\$471
A2066NFR	66 x 20-36 x 29.6	135	7	\$1185	\$453

Required specifications

Top finish
Base finish
Edge detail

Optional specifications

Additional grommet position
HP laminate
Power block cut-out

Accessories

Power block
Keyboard tray
Pencil tray

A ADAPTABILITIES®

RIGHT EXTENDED CORNERS

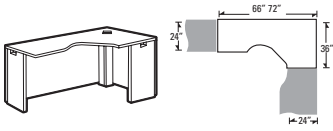

Right Extended Corner

MODEL #	DIMENSIONS W x D x H	WT/LB.	CUBIC FT.	LIST PRICE	HP ADD
A2472NNR	72 x 24-36 x 29.6	140	7	\$1229	\$471
A2466NNR	66 x 24-36 x 29.6	133	7	\$1185	\$453

Extended worksurface on left. **Narrow end panels on left and right.** Connects to 30"D space saver connectables, 24"D returns and 24"D connectable tables on either end. Corner has one grommet. Shipped easy to assemble in 1 carton.

- **Modesty panel is 1" off of ground.**
- **A2466NNR cannot accept pedestals.**

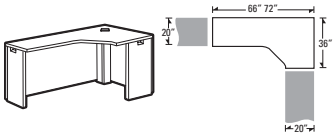

Right Extended Corner

A2072NNR	72 x 20-36 x 29.6	136	7	\$1209	\$471
A2066NNR	66 x 20-36 x 29.6	130	7	\$1166	\$453

Extended worksurface on left. **Narrow end panels on left and right.** Connects to 24"D space saver connectables and 20"D returns or bridge on either end. Corner has one grommet. Shipped easy to assemble in 1 carton.

- **Modesty panel is 1" off of ground.**

FREESTANDING TABLES

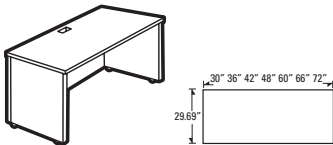

30" Deep Freestanding Table

A3072T	72 x 29.69 x 29.6	148	6	\$939	\$440
A3066T	66 x 29.69 x 29.6	140	6	\$887	\$404
A3060T	60 x 29.69 x 29.6	131	5.25	\$853	\$404
A3048T	48 x 29.69 x 29.6	116	5.25	\$791	\$345
A3042T	42 x 29.69 x 29.6	108	5.25	\$747	\$314
A3036T	36 x 29.69 x 29.6	97	4.3	\$717	\$283
A3030T	30 x 29.69 x 29.6	88	3.6	\$694	\$253

Two full end panels. **Cannot be connected on left or right side of full end panels.** Grommet in worksurface. Shipped easy to assemble in 1 carton.

- **Modesty panel is 1" off of ground.**

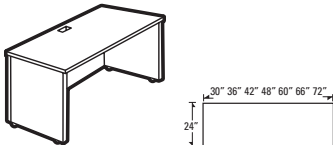

24" Deep Freestanding Table

A2472T	72 x 24 x 29.6	130	6	\$844	\$314
A2466T	66 x 24 x 29.6	123	6	\$801	\$300
A2460T	60 x 24 x 29.6	114	5.25	\$761	\$300
A2448T	48 x 24 x 29.6	99	4.3	\$732	\$239
A2442T	42 x 24 x 29.6	92	4.3	\$673	\$202
A2436T	36 x 24 x 29.6	84	4.2	\$670	\$152
A2430T	30 x 24 x 29.6	76	3.6	\$635	\$152

Two full end panels. **Cannot be connected on left or right side of full end panels.** Grommet in worksurface. Shipped easy to assemble in 1 carton.

- **Modesty panel is 1" off of ground.**

Required specifications

Top finish
Base finish
Edge detail

Optional specifications

Additional grommet position
HP laminate
Power block cut-out

Accessories

Power block
Keyboard tray
Pencil tray

CONNECTABLE TABLES - LEFT

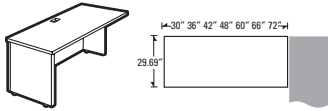

30" Deep Connectable Table - LEFT

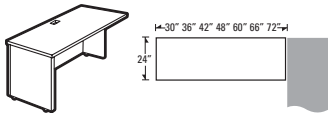

24" Deep Connectable Table - LEFT

MODEL # DIMENSIONS WT/LB. CUBIC FT. LIST PRICE HP ADD

W x D x H

A3072L	72 x 29.69 x 29.6	140	6	\$939	\$440
A3066L	66 x 29.69 x 29.6	132	6	\$887	\$404
A3060L	60 x 29.69 x 29.6	123	5.25	\$853	\$404
A3048L	48 x 29.69 x 29.6	105	4.3	\$791	\$345
A3042L	42 x 29.69 x 29.6	98	4.3	\$747	\$314
A3036L	36 x 29.69 x 29.6	88	4.2	\$714	\$283
A3030L	30 x 29.69 x 29.6	80	3.6	\$701	\$253

Full end panel on **left**. Right narrow end panel connects to 30"D center/right connectable table, or at 90° angle to a freestanding table; and "D" islands or "P" islands with "T" and "H" bases. Grommet in worksurface. Shipped easy to assemble in 1 carton.

• Modesty panel is 1" off of ground.

A2472L	72 x 24 x 29.6	121	6	\$844	\$314
A2466L	66 x 24 x 29.6	115	6	\$801	\$300
A2460L	60 x 24 x 29.6	106	5.25	\$773	\$300
A2448L	48 x 24 x 29.6	90	4.3	\$732	\$239
A2442L	42 x 24 x 29.6	82	3.8	\$673	\$202
A2436L	36 x 24 x 29.6	74	3.3	\$660	\$152
A2430L	30 x 24 x 29.6	68	3.6	\$635	\$152

Full end panel on **left**. Right narrow end panel connects to 24"D center/right connectable table, or at 90° angle to a freestanding table; 24"D extended corners, 42" 5-sided corners or at the end of a straight run; "D" islands or "P" islands with "T" and "H" bases. Grommet in worksurface. Shipped easy to assemble in 1 carton.

• Modesty panel is 1" off of ground.

CONNECTABLE TABLES - RIGHT

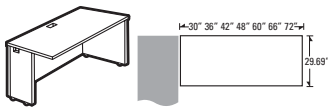

30" Deep Connectable Table - RIGHT

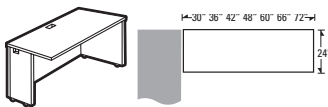

24" Deep Connectable Table - RIGHT

A3072R	72 x 29.69 x 29.6	140	6	\$939	\$440
A3066R	66 x 29.69 x 29.6	132	6	\$887	\$404
A3060R	60 x 29.69 x 29.6	123	5.25	\$853	\$404
A3048R	48 x 29.69 x 29.6	105	4.3	\$791	\$345
A3042R	42 x 29.69 x 29.6	98	4.3	\$747	\$314
A3036R	36 x 29.69 x 29.6	88	4.3	\$714	\$283
A3030R	30 x 29.69 x 29.6	80	3.6	\$701	\$253

Full end panel on **right**. Left narrow end panel connects to 30"D center/left connectable table, or at 90° angle to a freestanding table; "D" islands or "P" islands with "T" and "H" bases. Grommet in worksurface. Shipped easy to assemble in 1 carton.

• Modesty panel is 1" off of ground.

A2472R	72 x 24 x 29.6	121	6	\$844	\$314
A2466R	66 x 24 x 29.6	115	6	\$801	\$300
A2460R	60 x 24 x 29.6	105	5.25	\$773	\$300
A2448R	48 x 24 x 29.6	90	4.3	\$732	\$239
A2442R	42 x 24 x 29.6	82	3.8	\$673	\$202
A2436R	36 x 24 x 29.6	74	3.3	\$660	\$152
A2430R	30 x 24 x 29.6	67	3.6	\$635	\$152

Full end panel on **right**. Left narrow end panel connects to 24"D center/left connectable table, or at 90° angle to a freestanding table; 24"D extended corners, 42" 5-sided corners or at the end of a straight run; "D" islands or "P" islands with "T" and "H" bases. Grommet in worksurface. Shipped easy to assemble in 1 carton.

• Modesty panel is 1" off of ground.

Required specifications

Top finish
Body finish
Edge detail

Optional specifications

Additional grommet position
HP laminate
Power block cut-out

Accessories

Power block
Keyboard tray
Pencil tray

A ADAPTABILITIES®

CONNECTABLE TABLES

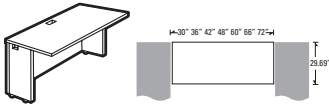

30" Deep Connectable Table

MODEL #	DIMENSIONS W x D x H	WT/LB.	CUBIC FT.	LIST PRICE	HP ADD
A3072N	72 x 29.69 x 29.6	131	6	\$939	\$440
A3066N	66 x 29.69 x 29.6	124	6	\$887	\$404
A3060N	60 x 29.69 x 29.6	114	5.25	\$853	\$404
A3048N	48 x 29.69 x 29.6	97	4.3	\$798	\$345
A3042N	42 x 29.69 x 29.6	89	3.8	\$778	\$314
A3036N	36 x 29.69 x 29.6	80	3.3	\$714	\$283
A3030N	30 x 29.69 x 29.6	71	3.6	\$665	\$253

Narrow end panels on both sides. Connects to 30"D worksurfaces; "D" islands or "P" islands with "T" and "H" bases; or at 90° angle to freestanding table(s). Grommet in worksurface. Shipped easy to assemble in 1 carton.

- **Modesty panel is 1" off of ground.**

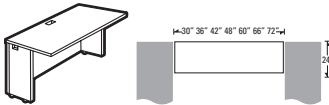

24" Deep Connectable Table

A2472N	72 x 24 x 29.6	113	6	\$844	\$314
A2466N	66 x 24 x 29.6	105	6	\$801	\$300
A2460N	60 x 24 x 29.6	100	4.5	\$781	\$300
A2448N	48 x 24 x 29.6	82	4.3	\$710	\$239
A2442N	42 x 24 x 29.6	73	3.8	\$673	\$202
A2436N	36 x 24 x 29.6	66	3.3	\$635	\$152
A2430N	30 x 24 x 29.6	59	3.6	\$598	\$152

Narrow end panels on both sides. Connects to 24"D worksurfaces; "D" islands or "P" islands with "T" and "H" bases; or at 90° angle to freestanding table(s). Grommet in worksurface. Shipped easy to assemble in 1 carton.

- **Modesty panel is 1" off of ground.**

SPACE SAVER CONNECTABLE TABLES - LEFT

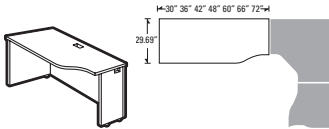

30" Deep Space Saver Connectable Table - LEFT

A3072LK	72 x 29.69 x 29.6	133	6	\$982	\$440
A3066LK	66 x 29.69 x 29.6	126	6	\$939	\$404
A3060LK	60 x 29.69 x 29.6	117	5.25	\$894	\$404
A3048LK	48 x 29.69 x 29.6	100	4.3	\$829	\$345
A3042LK	42 x 29.69 x 29.6	92	3.8	\$779	\$314
A3036LK	36 x 29.69 x 29.6	83	4.3	\$756	\$283
A3030LK	30 x 29.69 x 29.6	74	3.6	\$726	\$253

Full end panel on left. Narrow right end panel connects to 24"D 5-sided corner unit. Grommet in worksurface. Shipped easy to assemble in 1 carton.

- **Modesty panel is 1" off of ground.**
- *Keyboard and pencil trays for use on units 42" and above.*

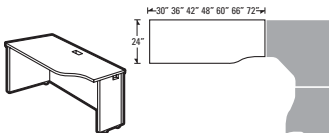

24" Deep Space Saver Connectable Table - LEFT

A2472LK	72 x 24 x 29.6	120	6	\$887	\$314
A2466LK	66 x 24 x 29.6	114	6	\$844	\$300
A2460LK	60 x 24 x 29.6	105	5.25	\$809	\$300
A2448LK	48 x 24 x 29.6	89	4.3	\$759	\$239
A2442LK	42 x 24 x 29.6	81	3.8	\$732	\$202
A2436LK	36 x 24 x 29.6	73	3.3	\$694	\$152
A2430LK	30 x 24 x 29.6	66	3.6	\$660	\$152

Full end panel on left. Narrow right end panel connects to 20"D 5-sided corner unit. Grommet in worksurface. Shipped easy to assemble in 1 carton.

- **Modesty panel is 1" off of ground.**
- *Keyboard and pencil trays for use on units 42" and above.*

Required specifications

Top finish
Base finish
Edge detail

Optional specifications

Additional grommet position
HP laminate
Power block cut-out

Accessories

Power block
Keyboard tray
Pencil tray

SPACE SAVER CONNECTABLE TABLES - RIGHT

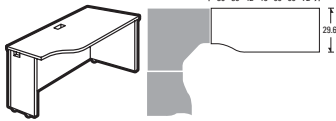

30" Deep Space Saver Connectable Table - RIGHT

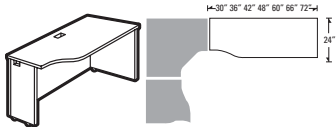

24" Deep Space Saver Connectable Table - RIGHT

MODEL #	DIMENSIONS W x D x H	WT/LB.	CUBIC FT.	LIST PRICE	HP ADD
A3072RK	72 x 29.69 x 29.6	133	6	\$982	\$440
A3066RK	66 x 29.69 x 29.6	126	6	\$939	\$404
A3060RK	60 x 29.69 x 29.6	117	5.25	\$894	\$404
A3048RK	48 x 29.69 x 29.6	100	4.3	\$829	\$345
A3042RK	42 x 29.69 x 29.6	91	3.8	\$779	\$314
A3036RK	36 x 29.69 x 29.6	83	4.3	\$756	\$283
A3030RK	30 x 29.69 x 29.6	74	3.6	\$726	\$253

Full end panel on right. Narrow right end panel connects to 24"D 5-sided corner unit. Grommet in worksurface. Shipped easy to assemble in 1 carton.

- **Modesty panel is 1" off of ground.**
- *Keyboard and pencil trays for use on units 42" and above.*

A2472RK	72 x 24 x 29.6	120	6	\$887	\$314
A2466RK	66 x 24 x 29.6	114	6	\$844	\$300
A2460RK	60 x 24 x 29.6	105	5.25	\$809	\$300
A2448RK	48 x 30 x 29.6	89	4.3	\$759	\$239
A2442RK	42 x 24 x 29.6	81	3.8	\$732	\$202
A2436RK	36 x 24 x 29.6	73	3.3	\$694	\$152
A2430RK	30 x 24 x 29.6	66	3.6	\$660	\$152

Full end panel on right. Narrow right end panel connects to 20"D 5-sided corner unit. Grommet in worksurface. Shipped easy to assemble in 1 carton.

- **Modesty panel is 1" off of ground.**
- *Keyboard and pencil trays for use on units 42" and above.*

SPACE SAVER CONNECTABLE TABLES

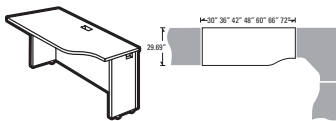

30" Deep Space Saver Connectable Table

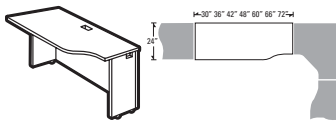

24" Deep Space Saver Connectable Table

A3072LN	72 x 29.69 x 29.6	125	6	\$982	\$440
A3066LN	66 x 29.69 x 29.6	117	6	\$939	\$404
A3060LN	60 x 29.69 x 29.6	108	5.25	\$894	\$404
A3048LN	48 x 29.69 x 29.6	91	4.3	\$828	\$345
A3042LN	42 x 29.69 x 29.6	83	3.8	\$793	\$314
A3036LN	36 x 29.69 x 29.6	74	3.3	\$744	\$283
A3030LN	30 x 29.69 x 29.6	66	3.6	\$694	\$253

Narrow end panels on both sides. Connects the **right end only to 24"D 5-sided corner unit.** Left end allows the continuation of additional connectable center or left connectable worksurface. Grommet in worksurface. Shipped easy to assemble in 1 carton.

- **Modesty panel is 1" off of ground.**
- *Keyboard and pencil trays for use on units 42" and above.*

A2472LN	72 x 24 x 29.6	112	6	\$871	\$314
A2466LN	66 x 24 x 29.6	105	6	\$844	\$300
A2460LN	60 x 24 x 29.6	96	5.25	\$791	\$300
A2448LN	48 x 24 x 29.6	81	4.3	\$732	\$239
A2442LN	42 x 24 x 29.6	73	3.8	\$716	\$202
A2436LN	36 x 24 x 29.6	65	3.3	\$665	\$152
A2430LN	30 x 24 x 29.6	58	3.6	\$635	\$152

Narrow end panels on both sides. Connects the **right end only to 20"D 5-sided corner unit.** Left end allows the continuation of an additional connectable center or left connectable worksurface. Grommet in worksurface. Shipped easy to assemble in 1 carton.

- **Modesty panel is 1" off of ground.**
- *Keyboard and pencil trays for use on units 42" and above.*

Required specifications	Optional specifications	Accessories
Top finish	Additional grommet	Power block
Base finish	HP laminate	Keyboard tray
Edge detail	Power block cut-out	Pencil tray

A ADAPTABILITIES®

SPACE SAVER CONNECTABLE TABLES

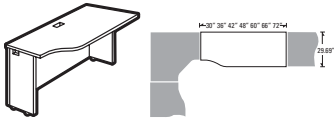

30" Deep Space Saver Connectable Table

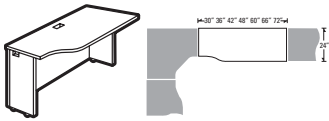

24" Deep Space Saver Connectable Table

MODEL #	DIMENSIONS		WT/LB.	CUBIC FT.	LIST PRICE	HP ADD	
	W x D x H						
A3072RN	72	29.69	29.6	125	6	\$982	\$440
A3066RN	66	29.69	29.6	117	6	\$939	\$404
A3060RN	60	29.69	29.6	108	5.25	\$894	\$404
A3048RN	48	29.69	29.6	91	4.3	\$828	\$345
A3042RN	42	29.69	29.6	83	3.8	\$793	\$314
A3036RN	36	29.69	29.6	74	3.3	\$744	\$283
A3030RN	30	29.69	29.6	66	3.6	\$694	\$253

Narrow end panels on both sides. Connects the **left end only to 24"D 5-sided corner unit.** Right end allows the continuation of additional connectable center or right connectable worksurface. Grommet in worksurface. Shipped easy to assemble in 1 carton.

- **Modesty panel is 1" off of ground.**
- *Keyboard and pencil trays for use on units 42" and above.*

A2472RN	72	24	29.6	112	6	\$871	\$314
A2466RN	66	24	29.6	105	6	\$844	\$300
A2460RN	60	24	29.6	96	5.25	\$791	\$300
A2448RN	48	24	29.6	81	4.3	\$732	\$239
A2442RN	42	24	29.6	72	3.8	\$716	\$202
A2436RN	36	24	29.6	59	3.3	\$665	\$152
A2430RN	30	24	29.6	53	3.6	\$635	\$152

Narrow end panels on both sides. Connects the **left end only to 20"D 5-sided corner unit.** Right end allows the continuation of additional connectable center or right connectable worksurface. Grommet in worksurface. Shipped easy to assemble in 1 carton.

- **Modesty panel is 1" off of ground.**
- *Keyboard and pencil trays for use on units 42" and above.*

"D" ISLANDS

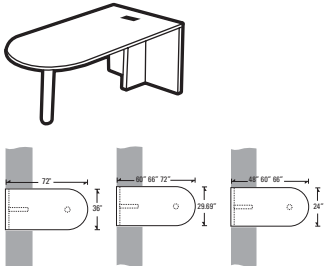

"D" Island - Full End Panel & Post (T-Base)*

A3672FI	72	36	29.6	124	8.5	\$994	\$471
A3072FI	72	29.69	29.6	107	7.5	\$957	\$440
A3066FI	66	29.69	29.6	102	7.5	\$894	\$404
A3060FI	60	29.69	29.6	96	6.76	\$844	\$404
A2466FI	66	24	29.6	90	7.5	\$838	\$300
A2460FI	60	24	29.6	84	6.76	\$794	\$300
A2448FI	48	24	29.6	74	5.76	\$759	\$239

Connects to narrow end panel. Attaching hardware included. **Not freestanding.** Grommet in worksurface. Shipped easy to assemble in 2 cartons.

- Post is shipped in separate carton. MUST specify Black (TBL) or Tungsten (TTU) finish.

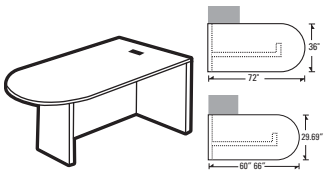

"D" Island - Full Modesty Panel (H-Base) - LEFT

A3672FIL	72	36	29.6	139	7	\$999	\$471
A3066FIL	66	29.69	29.6	116	6	\$921	\$404
A3060FIL	60	29.69	29.6	106	5.25	\$844	\$404

Connects to the left side of a worksurface. Accommodates all 19" pedestals (freestanding, mobile and hanging pedestals). Grommet in worksurface. Shipped easy to assemble in 1 carton.

- **Modesty panel is 1" off of ground.**

Required specifications

Top finish
Base finish
Edge detail
Post finish*

Optional specifications

Additional grommet position
HP laminate
Power block cut-out

Accessories

Power block
Keyboard tray
Pencil tray

"D" ISLANDS **MODEL #** **DIMENSIONS** **WT/LB.** **CUBIC FT.** **LIST PRICE** **HP ADD**

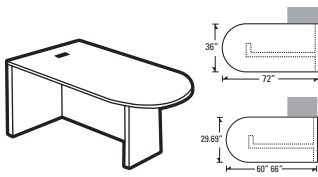

"D" Island - Full Modesty Panel (H-Base) - RIGHT

	W x D x H					
A3672FIR	72 x 36 x 29.6	139	7	\$999	\$471	
A3066FIR	66 x 29.69 x 29.6	116	6	\$921	\$404	
A3060FIR	60 x 29.69 x 29.6	106	5.25	\$844	\$404	

Connects to the right side of a worksurface. Accommodates all 19" pedestals (freestanding, mobile and hanging pedestals). Grommet in worksurface. Shipped easy to assemble in 1 carton.
 • Modesty panel is 1" off of ground.

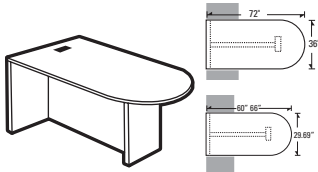

"D" Island - Full Modesty Panel (H-Base) - Center

A3672FIC	72 x 36 x 29.6	139	7	\$999	\$471	
A3066FIC	66 x 29.69 x 29.6	116	6	\$921	\$404	
A3060FIC	60 x 29.69 x 29.6	106	5.25	\$844	\$404	

Connects in between two worksurfaces. Will not accommodate pedestals. Grommet in worksurface. Shipped easy to assemble in 1 carton.
 • Modesty panel is 1" off of ground.

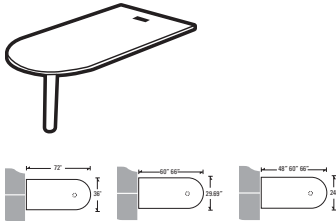

Attachable "D" Island with Post*

A3672I	72 x 36 x 29.6	88	8.5	\$801	\$471	
A3066I	66 x 29.69 x 29.6	71	7.5	\$741	\$404	
A3060I	60 x 29.69 x 29.6	65	6.76	\$716	\$404	
A2466I	66 x 24 x 29.6	63	7.5	\$679	\$300	
A2460I	60 x 24 x 29.6	57	6.76	\$655	\$300	
A2448I	48 x 24 x 29.6	47	5.76	\$625	\$239	

Attaches to edge of worksurfaces. Attaching hardware included. Grommet in worksurface. Shipped easy to assemble in 2 cartons.
 • Post is shipped in separate carton. MUST specify Black (TBL) or Tungten (TTU) finish.

EXTENDED CORNER ISLANDS

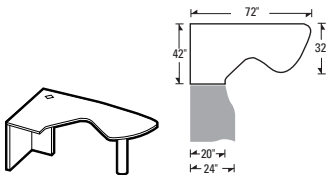

Extended Corner Island - RIGHT*

A4272EIR	72 x 42-32 x 29.6	104	11.5	\$1259	\$629	
----------	-------------------	-----	------	---------------	--------------	--

Extended island worksurface on right. Connects to 20"D returns or 24"D space saver connectables on the left. **Not freestanding.** Grommet in worksurface. Shipped easy to assemble in 2 cartons.
 • Post is shipped in separate carton. MUST specify Black (TBL) or Tungten (TTU) finish.

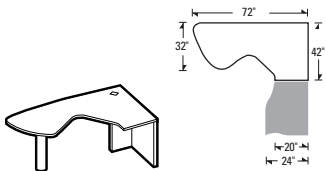

Extended Corner Island - LEFT*

A4272EIL	72 x 42-32 x 29.6	104	11.5	\$1259	\$629	
----------	-------------------	-----	------	---------------	--------------	--

Extended island worksurface on left. Connects to 20"D returns or 24"D space saver connectables on the right. **Not freestanding.** Grommet in worksurface. Shipped easy to assemble in 2 cartons.
 • Post is shipped in separate carton. MUST specify Black (TBL) or Tungten (TTU) finish.

Required specifications

- Top finish
- Base finish (not attachable "d" island w/post)
- Edge detail
- Post finish*

Optional specifications

- Additional grommet position
- HP laminate
- Power block cut-out

Accessories

- Power block
- Keyboard tray
- Pencil tray

A ADAPTABILITIES®

"P" ISLANDS

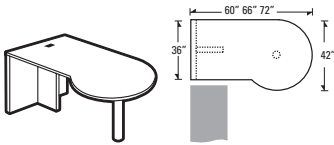

"P" Island - Full End Panel & Post (T-Base) - LEFT*

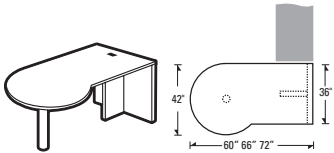

"P" Island - Full End Panel & Post (T-Base) - RIGHT*

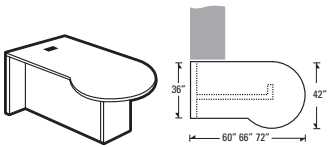

"P" Island - Full Modesty Panel (H-Base) - LEFT

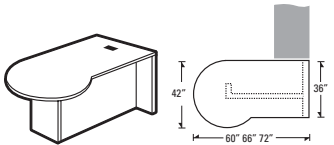

"P" Island - Full Modesty Panel (H-Base) - RIGHT

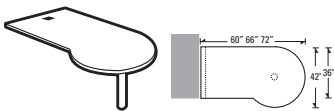

"P" Island with Post - LEFT*

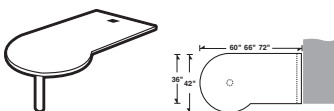

"P" Island with Post - RIGHT*

MODEL #	DIMENSIONS W x D x H	WT/LB.	CUBIC FT.	LIST PRICE	HP ADD
A3672FPL	72 x 36-42 x 29.6	128	9.26	\$1153	\$629
A3666FPL	66 x 36-42 x 29.6	122	8.76	\$1123	\$629
A3660FPL	60 x 36-42 x 29.6	116	8	\$1068	\$533

Connects to left side of worksurface. Attaching hardware included. **Not freestanding.** Grommet in worksurface. Shipped easy to assemble in 2 cartons.

- Post is shipped in separate carton. MUST specify Black (TBL) or Tungsten (TTU) finish.

A3672FPR	72 x 36-42 x 29.6	128	9.26	\$1153	\$629
A3666FPR	66 x 36-42 x 29.6	122	8.76	\$1123	\$629
A3660FPR	60 x 36-42 x 29.6	116	8	\$1068	\$533

Connects to right side of worksurface. Attaching hardware included. **Not freestanding.** Grommet in worksurface. Shipped easy to assemble in 2 cartons.

- Post is shipped in separate carton. MUST specify Black (TBL) or Tungsten (TTU) finish.

A3672PL	72 x 36-42 x 29.6	143	7.75	\$1168	\$629
A3666PL	66 x 36-42 x 29.6	136	7.25	\$1087	\$629
A3660PL	60 x 36-42 x 29.6	126	6.5	\$1024	\$533

Connects to the left side of a worksurface. Accommodates all 19" pedestals (freestanding, mobile and hanging pedestals). Grommet in worksurface. Shipped easy to assemble in 1 carton.

- Modesty panel is 1" off of ground.

A3672PR	72 x 36-42 x 29.6	143	7.75	\$1168	\$629
A3666PR	66 x 36-42 x 29.6	136	7.25	\$1087	\$629
A3660PR	60 x 36-42 x 29.6	126	6.5	\$1024	\$533

Connects to the right side of a worksurface. Accommodates all 19" pedestals (freestanding, mobile and hanging pedestals). Grommet in worksurface. Shipped easy to assemble in 1 carton.

- Modesty panel is 1" off of ground.

A3672IPL	72 x 36-42 x 29.6	92	9.26	\$993	\$629
A3666IPL	66 x 36-42 x 29.6	86	8.76	\$951	\$629
A3660IPL	60 x 36-42 x 29.6	80	8	\$887	\$533

Attaches to edge of worksurfaces. Attaching hardware included. Grommet in worksurface. Shipped easy to assemble in 2 cartons.

- Post is shipped in separate carton. MUST specify Black (TBL) or Tungsten (TTU) finish.

A3672IPR	72 x 36-42 x 29.6	92	9.26	\$993	\$629
A3666IPR	66 x 36-42 x 29.6	86	8.76	\$951	\$629
A3660IPR	60 x 36-42 x 29.6	80	8	\$887	\$533

Attaches to edge of worksurfaces. Attaching hardware included. Grommet in worksurface. Shipped easy to assemble in 2 cartons.

- Post is shipped in separate carton. MUST specify Black (TBL) or Tungsten (TTU) finish.

Required specifications

Top finish
Base finish
Edge detail
Post finish*

Optional specifications

Additional grommet position
HP laminate
Power block cut-out

Accessories

Power block
Keyboard tray
Pencil tray

RADIUS SPANNER ISLANDS **MODEL #** **DIMENSIONS** **WT/LB.** **CUBIC FT.** **LIST PRICE** **HP ADD**

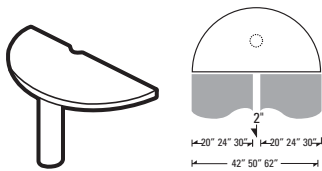

Radius Spanner Island with Panel Cut-Out**

	W x D x H					
A62RS	62 x 31 x 29.6	59	6.76	\$951	\$314	
A50RS	50 x 25 x 29.6	46	5.76	\$816	\$314	
A42RS	42 x 21 x 29.6	41	5.26	\$741	\$253	

Used to connect two back-to-back units of same depth with a panel. Includes monopost. Requires "L" bracket (model **MLB90**) for connection to full end panels. Shipped easy to assemble in 2 cartons.

- MLB90 must be ordered separately - see page 265.
- Post is shipped in separate carton. MUST specify Black (**TBL**) or Tungsten (**TTU**) finish.
- **Cannot accept keyboard trays or pencil tray.**

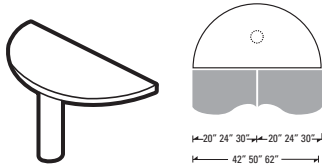

Radius Spanner Island**

A60RS	60 x 29.69 x 29.6	56	5.76	\$951	\$314	
A48RS	48 x 24 x 29.6	43	5.76	\$816	\$253	
A40RS	40 x 20 x 29.6	40	5.26	\$741	\$253	

Used to connect two back-to-back units of same depth. Includes monopost. Requires "L" bracket (model **MLB90**) for connection to full end panels. Shipped easy to assemble in 2 cartons.

- MLB90 must be ordered separately - see page 265.
- Post is shipped in separate carton. MUST specify Black (**TBL**) or Tungsten (**TTU**) finish.
- **Cannot accept keyboard trays or pencil tray.**

RECEPTION DESKS

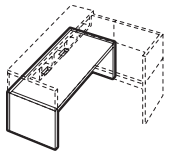

Lower Desk Unit*

A3072RD	72 x 29.69 x 29.6	149	7	\$1019	\$440	
---------	-------------------	-----	---	---------------	--------------	--

No pedestals. Two grommets in worksurface. Shipped easy to assemble in 1 carton.

- Reception desk components are only designed to be used together. Do not specify with standard Adaptabilities components.
- *Cannot be used with Divide.*

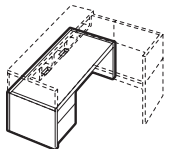

Single Pedestal Lower Desk Unit - LEFT*

A3072RDL	72 x 29.69 x 29.6	222	43.75	\$1494	\$440	
----------	-------------------	-----	-------	---------------	--------------	--

Box/file pedestal on **left** with lock. Two grommets in worksurface. Shipped easy to assemble in 1 carton.

- Reception desk components are only designed to be used together. Do not specify with standard Adaptabilities components.
- *Cannot be used with Divide.*

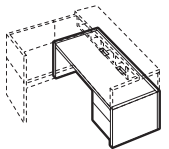

Single Pedestal Lower Desk Unit - RIGHT*

A3072RDR	72 x 29.69 x 29.6	222	43.75	\$1494	\$440	
----------	-------------------	-----	-------	---------------	--------------	--

Box/file pedestal on **right** with lock. Two grommets in worksurface. Shipped easy to assemble in 1 carton.

- Reception desk components are only designed to be used together. Do not specify with standard Adaptabilities components.
- *Cannot be used with Divide.*

Required specifications

- Top finish
- Base finish (not radius spanner islands)
- Post finish**
- Edge detail

Optional specifications

- Additional grommet position*
- HP laminate*
- Power block cut-out*

Accessories

- Power block*
- Keyboard tray*
- Pencil tray*

A ADAPTABILITIES®

RECEPTION RETURNS

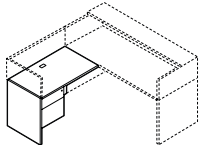

Reception Return - LEFT*

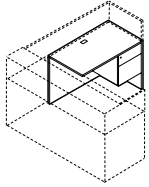

Reception Return - RIGHT*

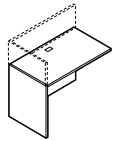

Reception Return - LEFT*

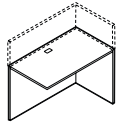

Reception Return - RIGHT*

MODEL #	DIMENSIONS W x D x H	WT/LB.	CUBIC FT.	LIST PRICE	HP ADD
A2442RRL	42 x 24 x 29.6	131	21.25	\$1005	\$202

Box/file pedestal on **left** with lock. Grommet in worksurface. Shipped assembled in 1 carton.

- Reception desk components are only designed to be used together. Do not specify with standard Adaptabilities components.
- *Cannot be used with Divide.*
- **Cannot accept keyboard trays or pencil tray.**

A2442RRR	42 x 24 x 29.6	131	21.25	\$1005	\$202
----------	----------------	-----	-------	---------------	--------------

Box/file pedestal on **right** with lock. Grommet in worksurface. Shipped assembled in 1 carton.

- Reception desk components are only designed to be used together. Do not specify with standard Adaptabilities components.
- *Cannot be used with Divide.*
- **Cannot accept keyboard trays or pencil tray.**

A2442KRL	42 x 24 x 29.6	83	3.8	\$710	\$202
----------	----------------	----	-----	--------------	--------------

No pedestal. Grommet in worksurface. Shipped easy to assemble in 1 carton.

- Reception desk components are only designed to be used together. Do not specify with standard Adaptabilities components.
- *Cannot be used with Divide.*

A2442KRR	42 x 24 x 29.6	83	3.8	\$710	\$202
----------	----------------	----	-----	--------------	--------------

No pedestal. Grommet in worksurface. Shipped easy to assemble in 1 carton.

- Reception desk components are only designed to be used together. Do not specify with standard Adaptabilities components.
- *Cannot be used with Divide.*

TRANSACTION COUNTERS

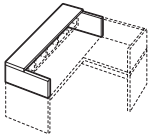

Transaction Counter

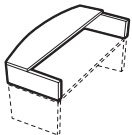

Bow Front Transaction Counter

A3072URD	72 x 29.69 x 13.75	67	4.3	\$636	\$188
----------	--------------------	----	-----	--------------	--------------

For main reception desk. Depth of reception top is 12". Shipped easy to assemble in 1 carton.

- Reception top units are to be used only with lower reception units. Tops have mini-fix fasteners to attach the reception top units.

A3072URB	72 x 29.69-36 x 13.75	72	4.3	\$887	\$253
----------	-----------------------	----	-----	--------------	--------------

For main reception desk. To be used on A3072RD, A3072RDL or A3072RDR. Depth of reception bow top is 12-15". Shipped easy to assemble in 1 carton.

- Reception top units are to be used only with desks listed. Tops have mini-fix fasteners to attach the reception top units.

Required specifications

Top finish
Base finish
Edge detail

Optional specifications

Additional grommet position*
HP laminate*
Power block cut-out*

Accessories

Power block*
Keyboard tray*
Pencil tray*

RETURN SCREEN UNITS

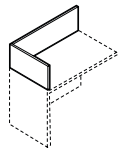

Return Screen Unit - LEFT

MODEL #	DIMENSIONS	WT/LB.	CUBIC FT.	LIST PRICE	HP ADD
W x D x H					
A2442URL	42 x 24 x 12.75	27	2	\$303	N/A

To be used on top of **left** reception return (A2442RRL/KRL). Shipped easy to assemble in 1 carton.
 • Reception top units are to be used only with returns listed. Tops have mini-fix fasteners to attach the reception top units.

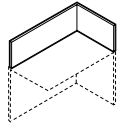

Return Screen Unit - RIGHT

A2442URR	42 x 24 x 12.75	27	2	\$303	N/A
----------	-----------------	----	---	--------------	-----

To be used on top of **right** reception return (A2442RRR/KRR). Shipped easy to assemble in 1 carton.
 • Reception top units are to be used only with returns listed. Tops have mini-fix fasteners to attach the reception top units.

DESK TOP ORGANIZER

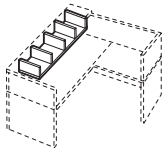

Desk Top Organizer

A1172ORD	52 x 11 x 6	22	2.6	\$174	N/A
----------	-------------	----	-----	--------------	-----

To be used under transaction counter. Black finish only. There are no specifications for Desk Top Organizer. Shipped easy to assemble in 1 carton.

WALL/PANEL MOUNT OVERSTORAGE UNITS

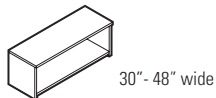
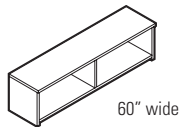

Overstorage Unit*

A00S60	60 x 15 x 16	86	5.25	\$794	N/A
A00S48	48 x 15 x 16	70	4.3	\$649	N/A
A00S42	42 x 15 x 16	62	3.8	\$636	N/A
A00S36	36 x 15 x 16	56	3.3	\$563	N/A
A00S30	30 x 15 x 16	48	3	\$532	N/A

Standard with pre-mounted "J" bracket for wall mount applications. One fixed shelf, closed back. Uses standard Adaptabilities hutch doors. 30" to 48" wide units are without center divider. Shipped easy to assemble in 1 carton.
 • **NOTE:** Care should be taken to mount the units. Units should be mounted to wall studs using correct fasteners. Failure to do so may result in collapse of the unit and subsequent personal injury. **Mounting hardware not included.** Mounting hardware used should be based on wall material. Consult an installation professional for proper wall mounting.

Required specifications

Top finish
 Base finish*
 Edge detail*

Optional specifications

Doors*

A ADAPTABILITIES®

OPEN HUTCHES

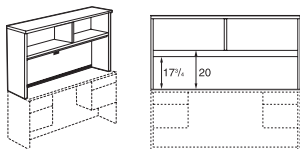

Open Hutch with Closed Back*

MODEL #	DIMENSIONS W x D x H	WT/LB.	CUBIC FT.	LIST PRICE	HP ADD
A72HOCB	72 x 15 x 36	175	28.25	\$1116	N/A
A71HOCB	71.69 x 15 x 36	175	28.25	\$1116	N/A
A66HOCB	66 x 15 x 36	164	26	\$951	N/A
A60HOCB	60 x 15 x 36	151	23.75	\$887	N/A

One fixed shelf and fixed shelf divider. Closed back features a grommet and flexible sweep for wire management. **A71HOCB** for use when spanning 30" x 60/66" SPL/R and 20/24" x 42" FL/FR/L4/R4.

Shipped assembled in 1 carton.

- Clearance from worksurface to valance is 17.75"; clearance from worksurface to hutch doors is 20".
- Woodgrain runs horizontal on both the upper and lower back panels.

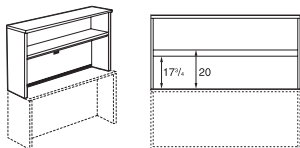

Open Hutch with Closed Back*

A48HOCB	48 x 15 x 36	124	19	\$809	N/A
A42HOCB	42 x 15 x 36	111	16.75	\$729	N/A
A36HOCB	36 x 15 x 36	99	14.5	\$673	N/A
A30HOCB	30 x 15 x 36	88	12.25	\$618	N/A

One fixed shelf. Closed back features a grommet and flexible sweep for wire management. Shipped assembled in 1 carton.

- Clearance from worksurface to valance is 17.75"; clearance from worksurface to hutch doors is 20".
- Woodgrain runs horizontal on both the upper and lower back panels.

PIGEON-HOLE STORAGE

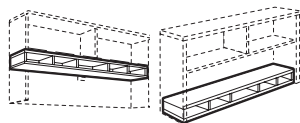

Horizontal Pigeon-Hole Storage

AHS72	70 x 11.25 x 5.62	41	3	\$668	N/A
AHS71	69 x 11.25 x 5.62	41	3	\$698	N/A
AHS66	64 x 11.25 x 5.62	38	2.8	\$668	N/A
AHS60	58 x 11.25 x 5.62	35	2.5	\$550	N/A
AHS48	46 x 11.25 x 5.62	28	2	\$399	N/A
AHS42	40 x 11.25 x 5.62	24	2	\$399	N/A
AHS36	34 x 11.25 x 5.62	22	2	\$327	N/A

For additional storage. Can be **top** or **bottom** mounted. For use inside hutch. Shipped easy to assemble in 1 carton.

- **Cannot be used on A00S and C00S overstorage units.**
- Black finish is standard. Brushed Cobalt (**BRC**) is available at no charge, please specify.

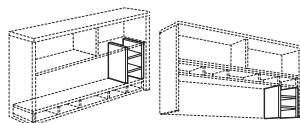

Vertical Pigeon-Hole Storage

AVS14	13.37 x 11.25 x 14.37	13	0.9	\$419	N/A
-------	-----------------------	----	-----	--------------	-----

For use in conjunction with horizontal pigeon-hole storage. Can be used under or over horizontal unit. Shipped easy to assemble in 1 carton.

- Black finish is standard. Brushed Cobalt (**BRC**) is available at no charge, please specify.

CORNER HUTCHES



Corner Hutch with Closed Back*

A42CH	42 x 15 x 36	144	6.25	\$1300	N/A
A36CH	36 x 15 x 36	125	4.8	\$1164	N/A

One fixed shelf. Closed back features a grommet in both back panels and flexible sweep for wire management. Shipped easy to assemble in 1 carton.

- Woodgrain runs horizontal on both the upper and lower back panels.

Required specifications

Top finish*
Base finish*
Edge detail

CORNER HUTCHES **MODEL #** **DIMENSIONS** **WT/LB.** **CUBIC FT.** **LIST PRICE** **HP ADD**

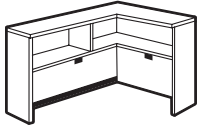

Corner Hutch with Closed Back - RIGHT

	W x D x H					
A3672CHR	36-72 x 15 x 36	186	7	\$1532	N/A	
A3666CHR	36-66 x 15 x 36	177	7	\$1518	N/A	

One fixed shelf and shelf divider on **left** side. Closed back features a grommet in both back panels and flexible sweep for wire management on the left side. Shipped easy to assemble in 1 carton.

- Woodgrain runs horizontal on both the upper and lower back panels.

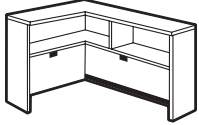

Corner Hutch with Closed Back - LEFT

A3672CHL	36-72 x 15 x 36	186	7.25	\$1532	N/A	
A3666CHL	36-66 x 15 x 36	177	7.25	\$1518	N/A	

One fixed shelf and shelf divider on **right** side. Closed back features a grommet in both back panels and flexible sweep for wire management on the right side. Shipped easy to assemble in 1 carton.

- Woodgrain runs horizontal on both the upper and lower back panels.

HUTCH DOORS

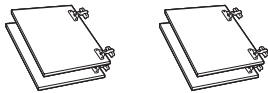

Four-Door Kit

ADOOR72	17.75 x 0.69 x 15	25	1.8	\$454	N/A	
ADOOR71	17.12 x 0.69 x 15	25	1.8	\$454	N/A	
ADOOR66	16.75 x 0.69 x 15	24	1.8	\$454	N/A	
ADOOR60	14.75 x 0.69 x 15	22	1.8	\$454	N/A	

For use on 72", 71", 66" and 60"W straight hutches. Hinges included. Locks available. **Add \$238** for locks. Doors for units 60" wide or more require two locks. Shipped easy to assemble, 1 kit per carton.

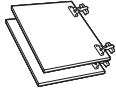

Two-Door Kit

ADOOR48	23.5 x 0.69 x 15	18	1.8	\$272	N/A	
ADOOR42	20.5 x 0.69 x 15	17	1.8	\$272	N/A	
ADOOR36	17.5 x 0.69 x 15	15	1.8	\$272	N/A	
ADOOR30	14.5 x 0.69 x 15	13	1.8	\$272	N/A	

For use on 48", 42", 36" and 30"W straight hutches. Hinges included. Locks available. **Add \$119** for the lock. Doors for units 48" wide or less require one lock. Shipped easy to assemble, 1 kit per carton.

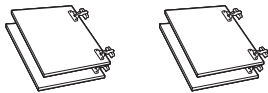

Corner Hutch Four-Door Kit

ADOOR72C	56.5 x 0.69 x 15	27	1.8	\$484	N/A	
ADOOR66C	50.5 x 0.69 x 15	25	1.8	\$484	N/A	

For use on 72" and 66"W corner hutches. Hinges included. Locks not available on corner hutch doors. Shipped easy to assemble, 1 kit per carton.

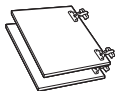

Corner Hutch Two-Door Kit

ADOOR42C	26.5 x 0.69 x 15	20	1.8	\$454	N/A	
ADOOR36C	21.5 x 0.69 x 15	17	1.8	\$290	N/A	

For use on 42" and 36"W corner hutches. Hinges included. Locks not available on corner hutch doors. Shipped easy to assemble, 1 kit per carton.

Required specifications

- Top/door finish
- Base finish (hutches only)
- Edge detail (hutches only)

TACKBOARDS FOR HUTCHES

NOTES: Tackboards can be upholstered in all of the following fabrics:

- Anchorage
- Global seating fabrics*
- Lola
- Merge

For a custom size tackboard that is less than 82"W x 21"H, price = next size up plus 10%.
ie: ATB4921: next size up - ATB5821 plus 10%.

* Contact Customer Service for pricing.

TACKBOARDS FOR HUTCHES

MODEL #	DIMENSIONS	WT/LB.	CUBIC FT.	LIST PRICE
---------	------------	--------	-----------	------------

W x D x H

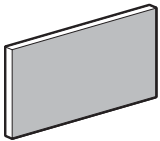

Tackboard

ATB7016	70 x 1 x 15	7	1.3	\$367
---------	-------------	---	-----	--------------

For use on **A72HOCB** straight hutch. Includes mounting screws and covers.

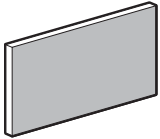

Tackboard

ATB6916	69.5 x 1 x 15	7	1.3	\$367
---------	---------------	---	-----	--------------

For use on **A71HOCB** straight hutch. Includes mounting screws and covers.

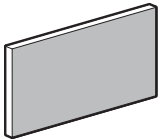

Tackboard

ATB6416	64 x 1 x 15	6.4	1.3	\$356
---------	-------------	-----	-----	--------------

For use on **A66HOCB** straight hutch. Includes mounting screws and covers.

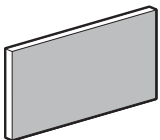

Tackboard

ATB5816	58 x 1 x 15	5.8	1.08	\$347
---------	-------------	-----	------	--------------

For use on **A60HOCB** straight hutch. Includes mounting screws and covers.

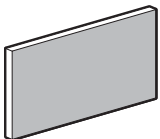

Tackboard

ATB4616	46 x 1 x 15	4.6	0.85	\$338
---------	-------------	-----	------	--------------

For use on **A48HOCB** straight hutch. Includes mounting screws and covers.

Required specifications

Fabric

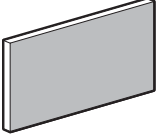
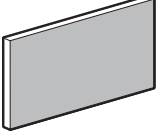
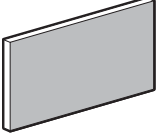
TACKBOARDS FOR HUTCHES	MODEL #	DIMENSIONS W x D x H	WT/LB.	CUBIC FT.	LIST PRICE
 Tackboard	ATB4016	40 x 1 x 15	4	0.85	\$322
For use on A42HOCB straight hutch. Includes mounting screws and covers.					
 Tackboard	ATB3416	34 x 1 x 15	3.4	0.85	\$214
For use on A36HOCB straight hutch. Includes mounting screws and covers.					
 Tackboard	ATB2816	28 x 1 x 15	2.8	0.85	\$200
For use on A30HOCB straight hutch. Includes mounting screws and covers.					

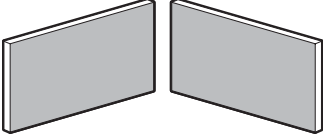
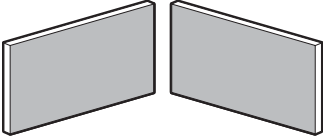
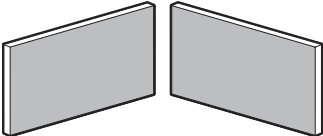
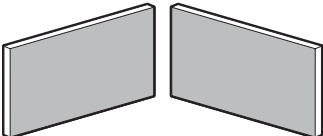
TACKBOARDS FOR CORNER HUTCHES	MODEL #	DIMENSIONS W x D x H	WT/LB.	CUBIC FT.	LIST PRICE
 Tackboard	ATB72CH	33-72 x 1 x 15	9.94	1.3	\$583
For use on A3672CHR/L corner hutch. Includes mounting screws and covers.					
 Tackboard	ATB66CH	33-64 x 1 x 15	9.4	1.3	\$570
For use on A3666CHR/L corner hutch. Includes mounting screws and covers.					
 Tackboard	ATB42CH	39-40 x 1 x 15	7.7	0.85	\$454
For use on A42CH corner hutch. Includes mounting screws and covers.					
 Tackboard	ATB36CH	33-34 x 1 x 15	6.6	0.85	\$428
For use on A36CH corner hutch. Includes mounting screws and covers.					

Required specifications
Fabric

A ADAPTABILITIES®

WALL MOUNTED TACKBOARDS

MODEL # DIMENSIONS WT/LB. CUBIC FT. LIST PRICE

W x D x H

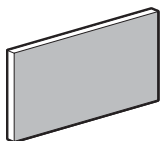

Wall Mounted Tackboard

AWHT3019	30 x 1.25 x 19	6.3	1	\$238
----------	----------------	-----	---	--------------

For use under **A00S30** overstorage unit. Standard with pre-mounted “J” bracket for wall mount applications. There will be a 1.75” clearance between the top of the tackboard and bottom of the overhead, and a .25” clearance between the bottom of the tackboard and the worksurface.

- **NOTE:** Care should be taken to mount the units. Units should be mounted to wall studs using correct fasteners. Failure to do so may result in collapse of the unit and subsequent personal injury. Mounting hardware not included. Mounting hardware used should be based on wall material. Consult an installation professional for proper wall mounting.

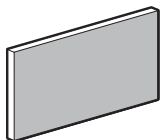

Wall Mounted Tackboard

AWHT3619	36 x 1.25 x 19	7.6	1	\$272
----------	----------------	-----	---	--------------

For use under **A00S36** overstorage unit. Standard with pre-mounted “J” bracket for wall mount applications. There will be a 1.75” clearance between the top of the tackboard and bottom of the overhead, and a .25” clearance between the bottom of the tackboard and the worksurface.

- **NOTE:** Care should be taken to mount the units. Units should be mounted to wall studs using correct fasteners. Failure to do so may result in collapse of the unit and subsequent personal injury. Mounting hardware not included. Mounting hardware used should be based on wall material. Consult an installation professional for proper wall mounting.

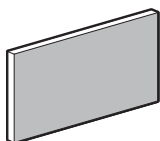

Wall Mounted Tackboard

AWHT4219	42 x 1.25 x 19	8.9	1	\$403
----------	----------------	-----	---	--------------

For use under **A00S42** overstorage unit. Standard with pre-mounted “J” bracket for wall mount applications. There will be a 1.75” clearance between the top of the tackboard and bottom of the overhead, and a .25” clearance between the bottom of the tackboard and the worksurface.

- **NOTE:** Care should be taken to mount the units. Units should be mounted to wall studs using correct fasteners. Failure to do so may result in collapse of the unit and subsequent personal injury. Mounting hardware not included. Mounting hardware used should be based on wall material. Consult an installation professional for proper wall mounting.

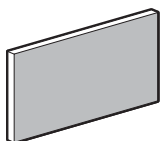

Wall Mounted Tackboard

AWHT4819	48 x 1.25 x 19	10.1	1	\$419
----------	----------------	------	---	--------------

For use under **A00S48** overstorage unit. Standard with pre-mounted “J” bracket for wall mount applications. There will be a 1.75” clearance between the top of the tackboard and bottom of the overhead, and a .25” clearance between the bottom of the tackboard and the worksurface.

- **NOTE:** Care should be taken to mount the units. Units should be mounted to wall studs using correct fasteners. Failure to do so may result in collapse of the unit and subsequent personal injury. Mounting hardware not included. Mounting hardware used should be based on wall material. Consult an installation professional for proper wall mounting.

Required specifications

Fabric

WALL MOUNTED TACKBOARDS **MODEL #** **DIMENSIONS** **WT/LB.** **CUBIC FT.** **LIST PRICE**

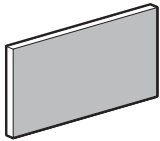

Wall Mounted Tackboard*

W x D x H					
AWHT6019	60 x 1.25 x 19	12.7	1.8		\$434

For use under **A00S60** overstorage unit. Standard with pre-mounted "J" bracket for wall mount applications. There will be a 1.75" clearance between the top of the tackboard and bottom of the overhead, and a .25" clearance between the bottom of the tackboard and the worksurface.

- **NOTE:** Care should be taken to mount the units. Units should be mounted to wall studs using correct fasteners. Failure to do so may result in collapse of the unit and subsequent personal injury. Mounting hardware not included. Mounting hardware used should be based on wall material. Consult an installation professional for proper wall mounting.

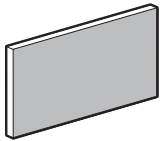

Wall Mounted Tackboard*

AWHT6619	66 x 1.25 x 19	13.9	1.8		\$443
AWHT7219	72 x 1.25 x 19	15.2	1.8		\$458
AWHT7819	78 x 1.25 x 19	16.5	1.8		\$548
AWHT8419	84 x 1.25 x 19	17.7	1.8		\$642

For use under **multiple** Adaptabilities wall mounted overstorage units. Standard with pre-mounted "J" bracket for wall mount applications. There will be a 1.75" clearance between the top of the tackboard and bottom of the overhead, and a .25" clearance between the bottom of the tackboard and the worksurface.

- **NOTE:** Care should be taken to mount the units. Units should be mounted to wall studs using correct fasteners. Failure to do so may result in collapse of the unit and subsequent personal injury. Mounting hardware not included. Mounting hardware used should be based on wall material. Consult an installation professional for proper wall mounting.

ACCESSORY PIECES



Mixed Drawer Cabinet - LEFT**

A2036MDL	36 x 20 x 29.6	162	15.5		\$2140
A2436MDL	36 x 24 x 29.6	176	18.25		\$2169

Two box drawers on **right**, one file drawer on **left** and one lateral file drawer on bottom. File on lateral file drawers locking. 1 pencil tray. Front-to-back filing bars. Shipped assembled in 1 carton.

- MUST specify Black (**HX**) or Silver (**HS**) finish for handles.
- *File drawer construction is for accommodating hanging files NOT for stacking materials on the drawer bottom.*



Mixed Drawer Cabinet - RIGHT**

A2036MDR	36 x 20 x 29.6	162	15.5		\$2140
A2436MDR	36 x 24 x 29.6	176	18.25		\$2169

Two box drawers on **left**, one file drawer on **right** and one lateral file drawer on bottom. File on lateral file drawers locking. 1 pencil tray. Front-to-back filing bars. Shipped assembled in 1 carton.

- MUST specify Black (**HX**) or Silver (**HS**) finish for handles.
- *File drawer construction is for accommodating hanging files NOT for stacking materials on the drawer bottom.*

Required specifications

Fabric*
Top finish**
Handle finish
Base finish

Optional specifications

Edge
Key # (not tackboards)

A ADAPTABILITIES®

ACCESSORY PIECES



Mixed Drawer Cabinet Shell - LEFT



Mixed Drawer Cabinet Shell - RIGHT

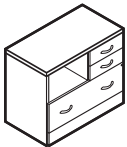

Mixed Storage Cabinet*



2 Drawer Lateral File*

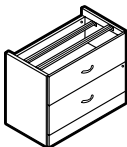

2 Drawer Lateral File Shell

MODEL #	DIMENSIONS W x D x H	WT/LB.	CUBIC FT.	LIST PRICE	HP ADD
A2036MDLS	36 x 19.25 x 28.6	137	15	\$2119	N/A
A2436MDLS	36 x 23.25 x 28.6	150	18	\$2150	N/A

For use **under 29"H limited single pedestal desks, workstations or limited single pedestal credenzas. Unfinished top, no back.** Two box drawers on right, one file drawer on left and one lateral file drawer on bottom. File and lateral file drawers locking. 1 pencil tray. Front-to-back filing bars. Shipped assembled in 1 carton.

- MUST specify Black (**HX**) or Silver (**HS**) finish for handles.
- File drawer construction is for accommodating hanging files **NOT** for stacking materials on the drawer bottom.
- For 24" deep worksurfaces, order **A2436MDLS**. For 20" deep worksurfaces, order **A2036MDLS**.

A2036MDRS	36 x 19.25 x 28.6	137	15	\$2119	N/A
A2436MDRS	36 x 23.25 x 28.6	150	18	\$2150	N/A

For use **under 29"H limited single pedestal desks, workstations or limited single pedestal credenzas. Unfinished top, no back.** Two box drawers on left, one file drawer on right and one lateral file drawer on bottom. File and lateral file drawers locking. 1 pencil tray. Front-to-back filing bars. Shipped assembled in 1 carton.

- MUST specify Black (**HX**) or Silver (**HS**) finish for handles.
- File drawer construction is for accommodating hanging files **NOT** for stacking materials on the drawer bottom.
- For 24" deep worksurfaces, order **A2436MDRS**. For 20" deep worksurfaces, order **A2036MDRS**.

A2436MSC	36 x 24 x 29.6	163	18.25	\$1520	\$152
A2036MSC	36 x 20 x 29.6	147	15.5	\$1500	\$152

Features open storage compartment with access grommet on back. 2 box drawers and 1 lateral file drawer, all locking. 1 pencil tray. Front-to-back filing bars. Shipped assembled in 1 carton.

- MUST specify Black (**HX**) or Silver (**HS**) finish for handles.
- File drawer construction is for accommodating hanging files **NOT** for stacking materials on the drawer bottom.

A2036LF	36 x 20 x 29.6	145	15.5	\$1196	\$152
---------	----------------	-----	------	---------------	--------------

Two full suspension drawers. Front-to-back and side-to-side letter/legal filing capability with lock. Anti-lock tilt suspension. Shipped assembled in 1 carton.

- MUST specify Black (**HX**) or Silver (**HS**) finish for handles.
- File drawer construction is for accommodating hanging files **NOT** for stacking materials on the drawer bottom.

A2436S2	36 x 24 x 28.6	114	18	\$1666	N/A
A2036S2	36 x 20 x 28.5	104	14.75	\$1666	N/A

For use **under 29"H limited single pedestal desks, workstations or limited single pedestal credenzas. No top or back.** Two full suspension locking drawers with **steel drawer interior**. Side-to-side file bars included. Anti-lock tilt suspension. Shipped assembled in 1 carton.



- MUST specify Black (**HX**) or Silver (**HS**) finish for handles.
- For 24" deep worksurfaces, order **A2436S2**. For 20" deep worksurfaces, order **A2036S2**.
- For front-to-back file bars order **FBB**; see page 42.

Required specifications

Top finish (not shells)
Base finish
Handles
Edge detail*

Optional specifications

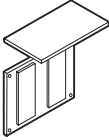
Key #
HP laminate (not shells)

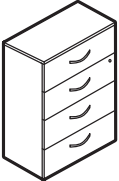
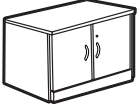
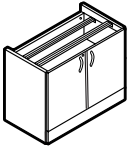
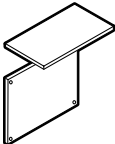
ACCESSORY PIECES	MODEL #	DIMENSIONS	WT/LB.	CUBIC FT.	LIST PRICE	HP ADD
 <p>2 Drawer Lateral File Top and Back</p>		W x D x H				
	ALF24TB	36 x 24 x 29.6	82	3.3	\$569	\$188
	ALF20TB	36 x 20 x 29.6	78	3.3	\$569	\$188
<p>For use with lateral file shell. Counterweights included. Shipped easy to assemble in 1 carton.</p> <ul style="list-style-type: none"> • Use ALF24TB for model A2436S2. Use ALF20TB for model A2036S2. 						
 <p>3 Drawer Lateral File</p>	A2036S3	36 x 20 x 37.75	219	20	\$2396	\$152
	<p>Three full suspension locking drawers with steel drawer interior. Steel drawer construction includes metal sides and masonite bottoms. Side-to-side file bars included. Includes anti-tip interlock feature. Shipped assembled in 1 carton.</p> <ul style="list-style-type: none"> • MUST specify Black (HX) or Silver (HS) finish for handles. • For front-to-back file bars order FBB; see page 42. 					
 <p>4 Drawer Lateral File</p>	A2036S4	36 x 20 x 49.5	267	25.75	\$3017	\$152
	<p>Four full suspension locking drawers with steel drawer interior. Steel drawer construction includes metal sides and masonite bottoms. Side-to-side file bars included. Includes anti-tip interlock feature. Shipped assembled in 1 carton.</p> <ul style="list-style-type: none"> • MUST specify Black (HX) or Silver (HS) finish for handles. • For front-to-back file bars order FBB; see page 42. 					
 <p>Storage Cabinet</p>	A2036SC	36 x 20 x 29.6	121	15.5	\$983	\$152
	<p>Self-closing hinged doors cover one adjustable shelf. Standard with lock. Shipped assembled in 1 carton.</p> <ul style="list-style-type: none"> • MUST specify Black (HX) or Silver (HS) finish for handles. 					
 <p>Storage Cabinet Shell</p>	A2436SCS	36 x 23.25 x 28.6	106	18	\$964	N/A
	A2036SCS	36 x 19.25 x 28.6	91	14.75	\$964	N/A
<p>For use under 29"H limited single pedestal desks, workstations or limited single pedestal credenzas. No top or back. Self-closing hinged doors cover one adjustable shelf. Standard with lock. Shipped assembled in 1 carton.</p> <ul style="list-style-type: none"> • MUST specify Black (HX) or Silver (HS) finish for handles. • For 24" deep worksurfaces, order A2436SCS. For 20" deep worksurfaces, order A2036SCS. 						
 <p>Storage Cabinet Top and Back*</p>	ASC24TB	36 x 24 x 29.6	49	3.3	\$512	\$188
	ASC20TB	36 x 20 x 29.6	45	3.3	\$512	\$188
<p>For use with Storage Cabinet Shell. Shipped easy to assemble in 1 carton.</p> <ul style="list-style-type: none"> • Use ASC24TB for model A2436SCS/MSCS; use ASC20TB for model A2036SCS/MSCS. 						

Required specifications

Top finish (not shells)
 Base finish
 Handles
 Edge (not A2xxxSCS)

Optional specifications

Key #
 HP laminate

A ADAPTABILITIES®

ACCESSORY PIECES

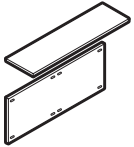

Credenza Top and Back*

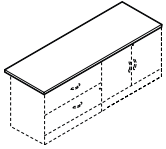

Credenza Top*

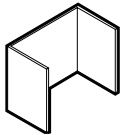

Kneespace Module

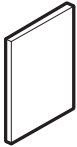

Full Leg



Personal Tower*

MODEL #	DIMENSIONS W x D x H	WT/LB.	CUBIC FT.	LIST PRICE	HP ADD
A2472TB	72 x 24 x 29.6	95	6	\$907	\$314
A2072TB	72 x 20 x 29.6	87	6	\$907	\$314

For use with the following: **two lateral file shells**, or **two storage cabinet shells**, or **two mixed storage cabinet shells**, or any combination. May also be used with **one lateral file shell plus one full leg**, or one **storage cabinet/mixed storage cabinet shell plus one full leg**. Shipped easy to assemble in 1 carton.

- For 24" deep worksurfaces, order **A2472TB**. For 20" deep worksurfaces, order **A2072TB**.

A2472CT	72 x 24 x 1	52	1.9	\$395	\$325
A2072CT	72 x 20 x 1	44	1.9	\$320	\$314

For use with the following: **two lateral file shells**, or **two storage cabinet shells**, or **two mixed storage cabinet shells**, or any combination. May also be used with **one lateral file shell plus one full leg**, or one **storage cabinet/mixed storage cabinet shell plus one full leg**. Shipped easy to assemble in 1 carton.

- For 24" deep worksurfaces, order **A2472CT**. For 20" deep worksurfaces, order **A2072CT**.

A2036KM	36 x 19 x 28.6	54	3.3	\$419	N/A
---------	----------------	----	-----	--------------	-----

For use with lateral file/credenza top and storage cabinet/credenza top combinations. Shipped easy to assemble in 1 carton.

- *Not designed to be used with a flush bridge.*

A24FL	1 x 24 x 28.6	20	1.7	\$309	N/A
A20FL	1 x 20 x 28.6	16	0.6	\$309	N/A

For use at **either end of A24/2072TB credenza top and back** to create a kneespace. Non-handed; can be used left or right. Shipped easy to assemble in 1 carton.

- For 24" deep worksurfaces, order **A24FL**. For 20" deep worksurfaces, order **A20FL**.

A24PTFF	24 x 24 x 65.5	219	27	\$2607	N/A
A20PTFF	24 x 20 x 65.5	198	22.75	\$2607	N/A

Includes 7" wardrobe section with a hanging rod; storage section with one adjustable shelf; and file section with **two file drawers**. Locks are keyed alike. Upper lock secures wardrobe and storage section. Lower lock secures both file drawers. Shipped assembled in 1 carton.

- **MUST** specify Black (**HX**) or Silver (**HS**) finish for handles.

Required specifications

Top finish
Base finish
Handles (only personal towers)
Edge detail*

Optional specifications

Key # (not credenzas or full leg)
HP laminate (tops and backs)

ACCESSORY PIECES **MODEL #** **DIMENSIONS** **WT/LB.** **CUBIC FT.** **LIST PRICE** **HP ADD**



Personal Tower

W x D x H						
A24PTBBF	24 x 24 x 65.5	213	27	\$2607	N/A	
A20PTBBF	24 x 20 x 65.5	193	22.75	\$2607	N/A	

Includes 7" wardrobe section with a hanging rod; storage section with one adjustable shelf; and file section with **box/box/file drawers**. Locks are keyed alike. Upper lock secures wardrobe and storage section. Lower lock secures all drawers. Shipped assembled in 1 carton.

- MUST specify Black (**HX**) or Silver (**HS**) finish for handles.



Vertical Storage/Lateral File Cabinet

A3665VSL	36 x 20 x 65.5	273	33	\$2050	N/A	
----------	----------------	-----	----	---------------	-----	--

Contains storage area with one adjustable shelf behind a self-closing hinged door, plus two full suspension file drawers. Lateral file drawers lock. Shipped assembled in 1 carton.

- *File drawer construction is for accommodating hanging files NOT for stacking materials on the drawer bottom.*
- MUST specify Black (**HX**) or Silver (**HS**) finish for handles.



Storage Wardrobe Cabinet

A2436DI	36 x 24 x 65.5	270	12	\$2359	N/A	
A3665DI	36 x 20 x 65.5	240	12	\$2036	N/A	

Includes 16" hanging rod on one side and four adjustable shelves on the other. Lock. Shipped easy to assemble in 1 carton.

- MUST specify Black (**HX**) or Silver (**HS**) finish for handles.

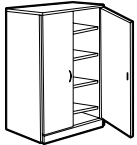

Storage Cabinet

A2436SH	36 x 24 x 65.5	296	12	\$2451	N/A	
A3665SH	36 x 20 x 65.5	261	12	\$2130	N/A	

Includes four adjustable shelves. Lock. Shipped easy to assemble in 1 carton.

- MUST specify Black (**HX**) or Silver (**HS**) finish for handles.



Wardrobe Cabinet

A2436ROD	36 x 24 x 65.5	220	12	\$2308	N/A	
A3665ROD	36 x 20 x 65.5	199	12	\$1988	N/A	

Includes full width hanging rod. Lock. Shipped easy to assemble in 1 carton.

- MUST specify Black (**HX**) or Silver (**HS**) finish for handles.

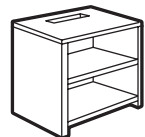

Printer Table

A2430PT	30 x 24 x 29.6	108	4.3	\$747	\$152	
---------	----------------	-----	-----	--------------	--------------	--

Includes two fixed shelves, cut-back top shelf allows paper to fall onto lower shelf. Shipped easy to assemble in 1 carton.

Required specifications

Top finish
Base finish
Handles
Edge detail

Optional specifications

Key #
HP laminate (only printer table)

A ADAPTABILITIES®

ACCESSORY PIECES

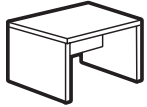

Magazine Table*

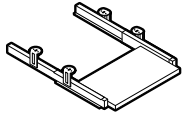

Pull-Out Keyboard

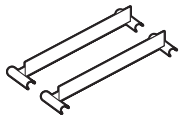

Front-to-Back File Bars

MODEL #	DIMENSIONS W x D x H	WT/LB.	CUBIC FT.	LIST PRICE	HP ADD
A2248MT	48 x 22 x 18.5	61	4.3	\$499	\$213
A2222MT	22 x 22 x 18.5	40	3	\$415	\$113

Shipped easy to assemble in 1 carton.

APOKL28	28 x 17 x 3.5	13	0.9	\$296	N/A
APOKL22	22 x 17 x 3.5	22	0.9	\$270	N/A

Constructed of thermally fused laminate. **APOKL28** will accommodate keyboard and mouse pad. **APOKL28** will only fit on a single pedestal desk, freestanding table, or **A42205C**. Please specify color from available finishes listed on page 11.

- **APOKL28** will not fit extended corners or **A42245C**, **A36205C** 5-sided corners.

FBB	15.5 x - x -	1	0.1	\$24	N/A
-----	--------------	---	-----	-------------	-----

Includes two bars. Standard in **EFC** (environmentally friendly color - similar to Charcoal Grey due to the use of recycled powder). Will fit Adaptabilities wood lateral file drawers. There are no specifications for File Bars.

- Not recommended for "L" opening with receding door and roll-out shelves.

BOOKCASES

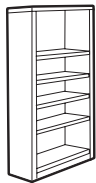

Bookcase - 72.5" High*



Bookcase - 65.5" High*



Bookcase - 48.5" High*

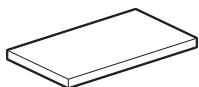

Bookcase Shelf

ABC72	36 x 12 x 72.5	170	23	\$1055	N/A
-------	----------------	-----	----	---------------	-----

One fixed heavy duty shelf and **three adjustable shelves**. Shipped assembled in 1 carton.

ABC65	36 x 12 x 65.5	150	21	\$926	N/A
-------	----------------	-----	----	--------------	-----

One fixed heavy duty shelf and **two adjustable shelves**. Shipped assembled in 1 carton.

ABC48	36 x 12 x 48.5	116	15.75	\$867	N/A
-------	----------------	-----	-------	--------------	-----

Two adjustable shelves. Shipped assembled in 1 carton.

ABCSELF	34 x 11 x 1	14	1.5	\$200	N/A
---------	-------------	----	-----	--------------	-----

Extra shelf for bookcases. 1" thick.

Required specifications

Top finish*
Base finish*
Edge detail*

Optional specifications

HP laminate (only magazine table)

BOOKCASES **MODEL #** **DIMENSIONS** **WT/LB.** **CUBIC FT.** **LIST PRICE** **HP ADD**

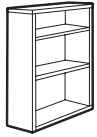
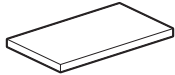

Table Top Bookcase

W x D x H						
A3636TBC	36 x 15 x 36	108	14.75	\$875	N/A	
AD00R3636	36 x 0.69 x 36	26	3	\$540	N/A	

To be placed on top of 36"W lateral file or storage cabinet. Two adjustable shelves. Shipped assembled in 1 carton.
 • For a set of doors, order **AD00R3636**.
 • Locks available on AD00R3636. **Add \$119** each lock.



Bookcase Shelf

ATBC36SH	34 x 13.25 x 1	16	1.7	\$260	N/A	
----------	----------------	----	-----	--------------	-----	--

Extra shelf for table top bookcases. 1" thick.

END SHELVES

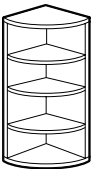

End Shelf - 65.5" High*

A2465ESHL	24 x 24 x 65.5	136	5	\$1152	N/A	
A2065ESHL	20 x 20 x 65.5	113	5	\$957	N/A	
A2465ESHR	24 x 24 x 65.5	136	5	\$1152	N/A	
A2065ESHR	20 x 20 x 65.5	113	5	\$957	N/A	

For use at end of **wardrobe/storage, vertical storage cabinets, and personal towers**. Four fixed shelves. **Specify left or right**. Shipped easy to assemble in 1 carton.
 • For 24" deep cabinet, order **A2465ESH**. For 20" deep cabinet, order **A2065ESH**.

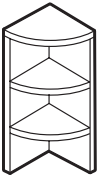

End Shelf - 36" High*

A1536ESHL	15 x 15 x 36	44	3.3	\$458	N/A	
A1536ESHR	15 x 15 x 36	44	3.3	\$458	N/A	

For use at end of **hutches**. Two fixed shelves. To be used on top of **A3029ESHL, A3029ESHR, A2429ESHL, A2429ESHR, A2029ESHL** or **A2029ESHR**. **Specify left or right**. Shipped easy to assemble in 1 carton.

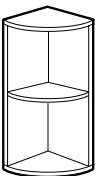

End Shelf - 29.5" High*

A3029ESHL	30 x 30 x 29.6	104	5.25	\$820	\$253
A2429ESHL	24 x 24 x 29.6	77	4.3	\$655	\$126
A2029ESHL	20 x 20 x 29.6	60	3.8	\$558	\$101
A3029ESHR	30 x 30 x 29.6	104	5.25	\$820	\$253
A2429ESHR	24 x 24 x 29.6	77	4.3	\$655	\$126
A2029ESHR	20 x 20 x 29.6	60	3.8	\$558	\$101

For use at end of **worksurfaces**. Two fixed shelves. **Specify left or right**. Shipped easy to assemble in 1 carton.
 • For 30" deep worksurface, order **A3029ESH**. For 24" deep worksurface, order **A2429ESH**.
 For 20" deep worksurface, order **A2029ESH**.

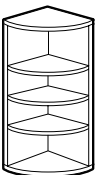

End Shelf - 49.5" High*

A2049ESHL	20 x 20 x 49.5	94	3.8	\$902	N/A	
A2049ESHR	20 x 20 x 49.5	94	3.8	\$902	N/A	

For use at end of **A2036S4 4-high lateral file**. Four fixed shelves. **Specify left or right**. Shipped easy to assemble in 1 carton.

Required specifications

- Top finish
- Base finish
- Edge detail*

A ADAPTABILITIES®

END SHELVES

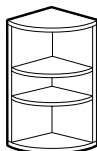

End Shelf - 37.75" High*

MODEL #	DIMENSIONS W x D x H	WT/LB.	CUBIC FT.	LIST PRICE	HP ADD
A2037ESHL	20 x 20 x 38.2	77	5	\$655	N/A
A2037ESHR	20 x 20 x 38.2	77	5	\$655	N/A

For use at end of **A2036S3 3-high lateral file**. Three fixed shelves. **Specify left or right**.
Shipped easy to assemble in 1 carton.

PEDESTALS

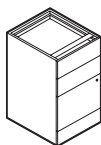

Freestanding Pedestal**

AFPBBF19	16 x 19 x 28.6	68	7.25	\$1013	N/A
AFPBBF22	16 x 22 x 28.6	72	8.25	\$1070	N/A
AFPBBF28	16 x 28 x 28.6	88	10.25	\$1137	N/A

For use under a freestanding worksurface (20", 24" or 30"); attaches to worksurface top. No top and unfinished back. Two box and one file drawer. One pencil tray. File drawer and lower box drawer are locking. Shipped assembled in 1 carton.

- *Cannot be used with **A2466** extended corners.*
- *When used with connectable tables bottom rear of pedestal will show because of the modesty on table units.*

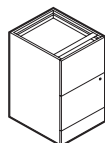

Freestanding Pedestal**

AFPFF19	16 x 19 x 28.6	67	7.25	\$1092	N/A
AFPFF22	16 x 22 x 28.6	75	8.25	\$1150	N/A
AFPFF28	16 x 28 x 28.6	89	10.25	\$1235	N/A

For use under a freestanding worksurface (20", 24" or 30"); attaches to worksurface top. No top and unfinished back. Two file drawers. Locking. Shipped assembled in 1 carton.

- *Cannot be used with **A2466** extended corners.*
- *When used with connectable tables bottom rear of pedestal will show because of the modesty on table units.*

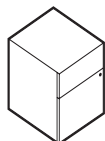

Hanging Pedestal**

AHPBF18	16 x 18 x 18	48	4.5	\$832	N/A
---------	--------------	----	-----	--------------	-----

For use under a freestanding worksurface (20", 24" or 30"); attaches to worksurface top. No top and unfinished back. One box and one file drawer. One pencil tray. Locking. 18" high. Shipped assembled in 1 carton.

- *Cannot be used with **A2466** extended corners.*
- *When used with connectable tables bottom rear of pedestal will show because of the modesty on table units.*



Mobile Pedestal**

AMPBBF19	16 x 19 x 28	96	6.5	\$1112	\$202
AMPBBF22	16 x 23 x 28	92	7.75	\$1173	\$202
AMPBBF28	16 x 29 x 28	105	9.5	\$1240	\$202

Pedestal on casters. Front casters lock. Fits under worksurfaces and is easily moved. Two box and one file drawer. One pencil tray. File drawer and lower box drawer are locking. Includes counterweight to prevent tipping. Shipped assembled in 1 carton.

- *Cannot be used with **A2466** extended corners.*

Required specifications

Top finish (only end shelf and mobile ped)
Base finish (only end shelf and mobile ped)
Edge detail*

Optional specifications

Key #**
HP laminate (mobile pedestal)
Handle**

PEDESTALS **MODEL #** **DIMENSIONS** **WT/LB.** **CUBIC FT.** **LIST PRICE** **HP ADD**



Mobile Pedestal**

	W x D x H					
AMPFF19	16 x 19 x 28	97	6.5	\$1168	\$202	
AMPFF22	16 x 23 x 28	95	7.75	\$1229	\$202	
AMPFF28	16 x 29 x 28	106	9.5	\$1312	\$202	

Pedestal on casters. Front casters lock. Fits under worksurfaces and is easily moved. Two file drawers. Locking. Includes counterweight to prevent tipping. Shipped assembled in 1 carton.

- *Cannot be used with **A2466** extended corners.*



Mobile Pedestal**

AMPBF19	16 x 19 x 22	77	5.25	\$921	\$202	
AMPBF22	16 x 23 x 22	73	6	\$981	\$202	
AMPBF28	16 x 29 x 22	83	7.5	\$1023	\$202	

Pedestal on casters. Front casters lock. Fits under worksurfaces and is easily moved. One box and one file drawer. One pencil tray. Locking. 22" high. Includes counterweight to prevent tipping. Shipped assembled in 1 carton.

BOARDROOM TABLES



Boardroom Table - Round Top*

A48R	48 x 48 x 1.5	83	7.5	\$629	\$440	
A42R	42 x 42 x 1.5	63	5.75	\$572	\$440	
A36R	36 x 36 x 1.5	49	4.9	\$372	\$253	

- *Available with bicut edge (**CR**) at no upcharge, please specify.*
- **A48R** to be used with four monopost legs only (model **A5L**).
- **A42R** to be used with four monoposts (model **A5L**) or cross base (model **A2727XB**).
- **A36R** to be used with four monoposts (model **A5L**), drum base (model **A18Z**) or cross base (model **A2727XB**).



Boardroom Table - Rectangular Top*

A48120RE	120 x 48 x 1.5	274	13	\$1260	\$1054	
A4896RE	96 x 48 x 1.5	237	11.5	\$921	\$877	
A3672RE	72 x 36 x 1.5	116	7	\$610	\$471	

For use with two drum bases, two "V" bases, one panel base OR four monoposts. Predrilled for "V" base and panel base. **Top comes in one piece, except for A48120RE (two pieces).**

- *Available with bicut edge (**CR**) at no upcharge, please specify.*
- **A48120RE** uses three drum bases, three "V" bases, one double panel base OR six monoposts.



Boardroom Table - Boat Shape Top*

A48144B	144 x 48 x 1.5	321	15.25	\$1364	\$1254	
A48120B	120 x 48 x 1.5	274	13	\$1202	\$1001	
A4896B	96 x 48 x 1.5	221	11.5	\$1040	\$877	

For use with three drum bases, three "V" bases, one double panel base OR six monoposts. Predrilled for "V" base and panel base. **Top comes in two pieces, except for A4896B.**

- *Available with bicut edge (**CR**) at no upcharge, please specify.*
- **A4896B** uses two drum bases, two "V" bases, one panel base OR four monoposts.

Required specifications

Top finish
Edge detail*

Optional specifications

Key #**
HP laminate
Handles**

A ADAPTABILITIES®

BOARDROOM TABLES



Boardroom Table - Racetrack Top*

MODEL #	DIMENSIONS W x D x H	WT/LB.	CUBIC FT.	LIST PRICE	HP ADD
A48144RT	144 x 48 x 1.5	324	15.25	\$1364	\$1254
A48120RT	120 x 48 x 1.5	273	13	\$1202	\$1001
A4896RT	96 x 48 x 1.5	217	11.5	\$1040	\$877
A3672RT	72 x 36 x 1.5	104	7	\$747	\$471

For use with three drum bases, three "V" bases, one double panel base OR six monoposts. Predrilled for "V" base and panel base. **Top comes in two pieces except for A4896RT and A3672RT.**

- Available with bicut edge (CR) at no upcharge, please specify.
- **NOTE:** 48" x 120" and 48" x 144" woodgrain finish Adaptabilities tables will not have a perfect match of grain at the center where the two halves meet.
- **A4896RT and A3672RT** use two drum bases, two "V" bases, one panel base OR four monoposts.

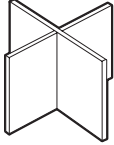

Cross Base

A2727XB	27 x 27 x 29.6	63	3.6	\$495	N/A
---------	----------------	----	-----	--------------	-----

Use as the base for **36" or 42" round tops (model A36R or A42R)**. Shipped easy to assemble in 1 carton.

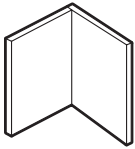

"V" Base

A1616V	16 x 16 x 28.6	39	2	\$320	N/A
A1616V2	16 x 16 x 28.6	74	3.6	\$642	N/A

Use as the base for **rectangular, boat shaped or racetrack tops**. Shipped easy to assemble in 1 carton.

- **A1616V2** is shipped 2 bases (1 pair) per carton.

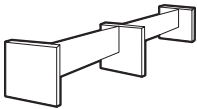

Panel Base

A2488PB	88 x 24 x 29.6	119	6	\$926	N/A
A2445PB	45 x 24 x 28.6	76	4.3	\$588	N/A

Use as the base for **rectangular, boat shaped or racetrack tops**. Shipped easy to assemble in 1 carton.

- Use **A2488PB** for 120 - 144" wide tops.
- Use **A2445PB** for 72 - 96" wide tops.

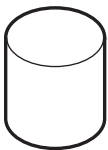

Drum Base

A18Z	18 x 18 x 28.6	29	7.5	\$913	N/A
------	----------------	----	-----	--------------	-----

Use as the base for **36" round tops (model A36R) and 72", 96", 120" or 144" wide tops**. Available in **Black finish only**. There are no specifications for Drum Base.

- All drum bases require approximately 125 lb. of sand in each base for adequate stability. Sand bag not included.



Mono Post

A5L	5 x 5 x 28.6	12	1	\$446	N/A
-----	--------------	----	---	--------------	-----

Use as the base for **48" round tops (model A48R) and 72", 96", 120" or 144" wide tops**.



- Post is shipped in separate carton. MUST specify Black (TBL) or Tungsten (TTU) finish.

Required specifications

Finish
Edge detail*

Optional specifications

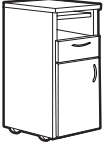
HP laminate*

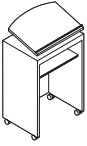
BOARDROOM ACCESSORIES	MODEL #	DIMENSIONS	WT/LB.	CUBIC FT.	LIST PRICE	HP ADD
 <p>Serving Cart*</p>	A2036SK	36 x 20 x 36.5	179	19	\$1869	\$152
	<p>Includes two side opening, self-closing hinged doors, two box drawers, one slide-out tray and storage shelf. On casters. Shipped assembled in 1 carton.</p> <ul style="list-style-type: none"> • Available with bicut edge (CR) at no upcharge, please specify. • MUST specify Black (HX) or Silver (HS) finish for handles. 					
 <p>Serving Cart*</p>	A2020SK	20 x 20 x 36	114	11	\$1082	\$101
	<p>Includes one side opening, self-closing hinged door, one box drawer, one slide-out tray and storage shelf. On casters. Shipped assembled in 1 carton.</p> <ul style="list-style-type: none"> • Available with bicut edge (CR) at no upcharge, please specify. • MUST specify Black (HX) or Silver (HS) finish for handles. 					
 <p>Audio/Visual Cabinet*</p>	A2436AV	36 x 24 x 65.5	272	11.25	\$2345	N/A
	<p>Includes four side opening doors covering two adjustable and two fixed shelves. Wire access through one grommet on back panel. Holds up to 27"H TV monitor. Doors do not lock. Shipped easy to assemble in 1 carton.</p> <ul style="list-style-type: none"> • MUST specify Black (HX) or Silver (HS) finish for handles. 					
 <p>Visual Board</p>	AVB4848	48 x 4 x 48	135	9	\$1329	N/A
	<p>Includes whiteboard and two side opening doors containing cork board on right door and 50-sheet paper writing pad on left door. Marker board can be used for projection.</p> <ul style="list-style-type: none"> • NOTE: Care should be taken to mount the units. Units should be mounted to wall studs using correct fasteners. Failure to do so may result in collapse of the unit and subsequent personal injury. Mounting hardware not included. Mounting hardware used should be based on wall material. Consult an installation professional for proper wall mounting. 					
 <p>Lectern</p>	A1844LC	24 x 18 x 44	92	4.8	\$858	\$101
	<p>Features angled stand, storage shelf and casters. Shipped easy to assemble in 1 carton.</p>					

Required specifications

Top finish
Base finish
Handles*
Edge detail*

Optional specifications

Key #* (not A2436AV)
HP laminate (not A2436AV, AVB4848 or FC)



The Genoa series combines the value of laminate furniture with the contemporary styling of top over end panel design. This versatile offering of components and wide selection of laminate finish options is the perfect complement to any office environment.

For added security of confidential material, all desks and credenzas are equipped with one locking pedestal. Genoa's kneespace credenza easily accommodates a computer, books, binders and files to maximize space.

Genoa features quality construction. Fully progressive ball bearing suspensions ensure years of smooth, trouble-free drawer service.

Genoa's classic styling and simplicity integrate easily with existing furnishings and any interior decor. For new offices or current office expansions, Genoa is clearly the affordable and practical choice.

Features and Benefits

- 45 lb. density particle board substructure with high performance thermally fused laminate.
- Available bow front desk provides extra legroom and work area for visitors.
- ¾ modesty panel is standard.
- Most components shipped fully assembled, 1 per carton.
- Pencil tray included in the box drawer.
- Box drawers mounted on ¾ extension steel ball bearings.
- Drawers open with side pull.
- Compatible with **Divide** panel systems for increased privacy and storage requirements.

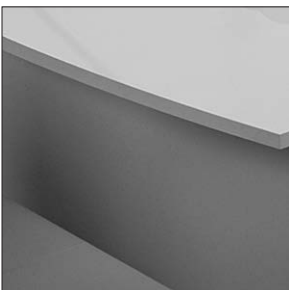

Bow front available on 36" x 72" desks.



Contemporary top-over-end panel design.



Drawer fronts are edge banded on all sides.

GENERAL INFORMATION

- Constructed of 45 lb. density particle board with high performance thermally fused laminate.
- Genoa components are compatible with Divide partitioning panels.
- Large offering of extended corners, full to floor pedestals, islands and storage options.
- Double wall pedestal housing.
- Genoa desk and storage products have been tested and comply with all BIFMA mechanical tests.
- For environmental certification, please visit globalfurnituregroup.com.

CONSTRUCTION

- Constructed of 45 lb. density particle board with high performance thermally fused laminate.
- Double wall pedestal housing.
- Panel end style with top over side panel design.
- 1" adjustable leveling glides standard on all units.
- Standard with locks.

MODESTY PANELS

- Recessed ¾ height modesty panel is standard. Full modesty panel available. **Add \$62.**
- All full to floor units, bridges and returns are standard with a full modesty panel.

STORAGE

- All lateral file drawer fronts feature the woodgrain running in a horizontal direction.
- Pencil tray included in box drawer.

FINISHES

ACJ Absolute Acajou	NBL Noce Biondo
ASN Asian Night	NGL Noce Grigio
AWC Avant Cherry	NEL Noce Leggero
AWH Avant Honey	NML Noce Medio
BLK Black	QTM Quartered Mahogany
CMB Clear Maple	WHE Walnut Heights
DES Dark Espresso	WHC White Chocolate
DWT Designer White	WCR Winter Cherry

MONOPOSTS

- Available in Black (TBL) only.

GROMMETS

- Grommets may be ordered on Genoa hutch back panel.
- Additional grommets available in standard worksurface locations (left, center or right). Order as: **FOG1, FOG2 or FOG3. Add \$91.**
- Grommet hole dimensions are 3.25"W x 1.875"D.



- Actual grommet locations on the worksurface are depicted in the example drawings shown below. Dimensions shown are actual measurements (in inches).

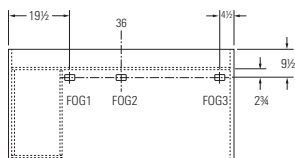

36 x 72 single pedestal left desks (G3672SPL)

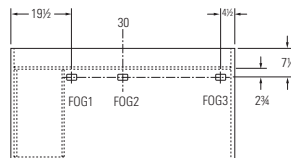

30 x 60 single pedestal left desks (G3060SPL)

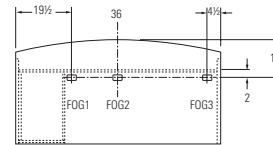

36 x 72 single pedestal left bow top desks (G3672SPLB)

- Grommets may be placed at non-standard locations. Order as: **CSG. Add \$132.** A drawing must be supplied with vertical and horizontal dimensions to the center of the cut-out (as in drawing above). Please refer to the **custom grommet location form** in the back reference section.
- Components that come standard with grommet may be ordered without a grommet, order **RSG. Add \$51**
- Grommets are available on modesty panels of **5-sided corners** 6.5" in where the two modesty panels meet at a 90° angle. Please specify **FOGMPR** for right grommet placement and **FOGMPL** for left grommet (placement shown below). Cost is **\$132.**
- Modesty panels are 1" off of ground.

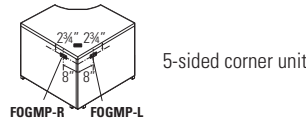

POWER BLOCK

- A power block (model **PMSPDM**) may be ordered on all worksurfaces.
- A power block is a rectangular worksurface power/data module with one electrical duplex receptacle and two data (RJ45) receptacles. 9 foot Black cord included. Power block dimensions are 6.5"W x 3.5"D x 2.75"H.
- To purchase a power block, you must specify both the power block cut-out location and the power block model #. Order power block as **PMSPDM. Add \$268.** Power blocks are available in standard worksurface locations (left, center or right). Order as **E1, E2 or E3. Add \$91.**

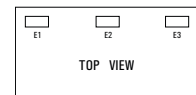

Power block **PMSPDM. Add \$268.**

Specify location **E1, E2 or E3. Add \$91.**

SPECIAL SIZES

- Special widths are available on most products with open knee space and/or units with open or hinged door storage configurations. To price, take the list price of the next larger standard size up and add **15%.** Quotations are not required, some exceptions may apply.
- For custom widths outside of the range of standard sizes published or any custom depths, submit a **SPECIALS / MTM** quote request through the Global Dealer Centre.
- Orders must indicate the custom quote number and list price.
- Changes to custom quotes are not permitted. Any revisions will necessitate a new quotation.

SPECIFICATIONS

- Specifications marked with an * are applicable to only those products which have the * symbol beside the product name.

DOUBLE PEDESTAL DESKS

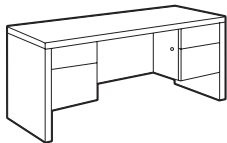

Double Pedestal Desk

MODEL #	DIMENSIONS W x D x H	WT/LB.	CUBIC FT.	LIST PRICE
G3672DP	72 x 36 x 29.4	286	50.5	\$1316
G3066DP	66 x 29.69 x 29.4	235	39.25	\$1231
G3060DP	60 x 29.69 x 29.4	226	35.5	\$1048

Standard with box/file pedestals on both sides. Pedestals lock. One pencil tray. Shipped assembled in 1 carton.

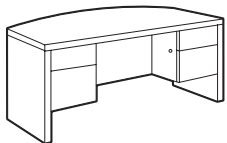

Double Pedestal Bow Top Desk

G3672DPB	72 x 32-36 x 29.4	256	50.5	\$2212
----------	-------------------	-----	------	---------------

Standard with box/file pedestals on both sides and bow top. Pedestals lock. One pencil tray. Shipped assembled in 1 carton.

SINGLE PEDESTAL DESKS

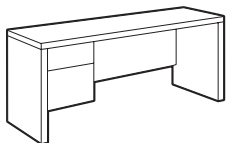

Single Pedestal Desk - LEFT

G3672SPL	72 x 36 x 29.4	235	50.5	\$1165
G3066SPL	66 x 29.69 x 29.4	192	39.25	\$1080
G3060SPL	60 x 29.69 x 29.4	183	35.5	\$915
G3048SPL	48 x 29.69 x 29.4	166	28.75	\$788
G2445SPL	45 x 24 x 29.4	137	23.5	\$624

Standard with box/file pedestal on the **left**. Pedestal locks. One pencil tray. Shipped assembled in 1 carton.

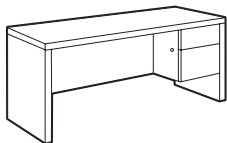

Single Pedestal Desk - RIGHT

G3672SPR	72 x 36 x 29.4	235	50.5	\$1165
G3066SPR	66 x 29.69 x 29.4	192	39.25	\$1080
G3060SPR	60 x 29.69 x 29.4	183	35.5	\$915
G3048SPR	48 x 29.69 x 29.4	166	28.75	\$788
G2445SPR	45 x 24 x 29.4	137	23.5	\$624

Standard with box/file pedestal on the **right**. Pedestal locks. One pencil tray. Shipped assembled in 1 carton.

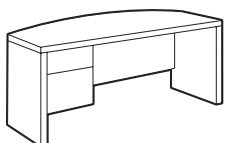

Single Pedestal Bow Top Desk - LEFT

G3672SPLB	72 x 32-36 x 29.4	214	50.5	\$1882
-----------	-------------------	-----	------	---------------

Standard with box/file pedestal on the **left** and bow top. Pedestal locks. One pencil tray. Shipped assembled in 1 carton.

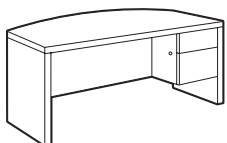

Single Pedestal Bow Top Desk - RIGHT

G3672SPRB	72 x 32-36 x 29.4	214	50.5	\$1882
-----------	-------------------	-----	------	---------------

Standard with box/file pedestal on the **right** and bow top. Pedestal locks. One pencil tray. Shipped assembled in 1 carton.

Required specifications

Finish

Optional specifications

Full modesty
Grommet
Key #

Accessories

Power block
Keyboard tray
Pencil tray

RETURNS MODEL # DIMENSIONS WT/LB. CUBIC FT. LIST PRICE

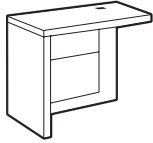

Typing Return - LEFT

	W x D x H			
G2448SDL	48 x 24 x 26	137	23.5	\$761
G2040SDL	40 x 20 x 26	111	17.5	\$648

Standard with box/file pedestal on the **left** and lower **26" height**. Pedestal locks. Grommet in worksurface. Shipped assembled in 1 carton.

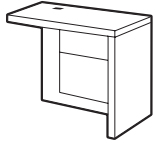

Typing Return - RIGHT

G2448SDR	48 x 24 x 26	137	23.5	\$761
G2040SDR	40 x 20 x 26	111	17.5	\$648

Standard with box/file pedestal on the **right** and lower **26" height**. Pedestal locks. Grommet in worksurface. Shipped assembled in 1 carton.

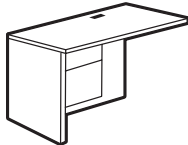

Flush Return - LEFT

G2448FL	48 x 24 x 29.4	142	23.5	\$1024
G2040FL	40 x 20 x 29.4	115	17.5	\$985

Standard with box/file drawer pedestal on the **left**. Pedestal locks. Grommet in worksurface. Shipped assembled in 1 carton.

- For 24" deep worksurfaces, order **G24__FL**. For 20" deep worksurfaces, order **G20__FL**.
- Keyboard and pencil trays for use on units 42" and above.

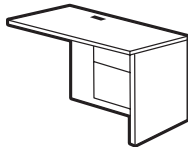

Flush Return - RIGHT

G2448FR	48 x 24 x 29.4	142	23.5	\$1024
G2040FR	40 x 20 x 29.4	115	17.5	\$985

Standard with box/file drawer pedestal on the **right**. Pedestal locks. Grommet in worksurface. Shipped assembled in 1 carton.

- For 24" deep worksurfaces, order **G24__FR**. For 20" deep worksurfaces, order **G20__FR**.
- Keyboard and pencil trays for use on units 42" and above.

Required specifications

Finish

Optional specifications

Key #

Accessories

Power block
Keyboard tray
Pencil tray

FULL TO FLOOR FLUSH RETURNS

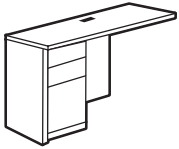

Full to Floor Flush Return - LEFT

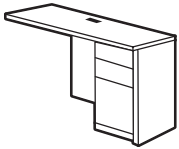

Full to Floor Flush Return - RIGHT

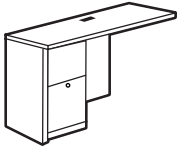

Full to Floor Flush Return - LEFT

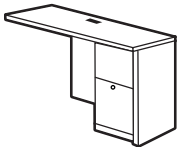

Full to Floor Flush Return - RIGHT

MODEL # DIMENSIONS WT/LB. CUBIC FT. LIST PRICE

W x D x H

G2448BL4	48 x 24 x 29.4	136	25	\$1288
G2442BL4	42 x 24 x 29.4	128	21.5	\$1246
G2436BL4	36 x 24 x 29.4	120	18	\$1223

Standard with box/box/file drawer pedestal on the **left**. Lower box drawer and file drawer lock. Grommet in worksurface. Shipped assembled in 1 carton.

- For 24" deep worksurfaces, order **G24__BL4**. For 20" deep worksurfaces, order **G20__BL4**.
- Keyboard and pencil trays for use on units 42" and above.

G2448BR4	48 x 24 x 29.4	136	25	\$1288
G2442BR4	42 x 24 x 29.4	128	21.5	\$1246
G2436BR4	36 x 24 x 29.4	120	18	\$1223

Standard with box/box/file drawer pedestal on the **right**. Lower box drawer and file drawer lock. Grommet in worksurface. Shipped assembled in 1 carton.

- For 24" deep worksurfaces, order **G24__BR4**. For 20" deep worksurfaces, order **G20__BR4**.
- Keyboard and pencil trays for use on units 42" and above.

G2448L4	48 x 24 x 29.4	132	25	\$1309
G2442L4	42 x 24 x 29.4	124	21.5	\$1267
G2436L4	36 x 24 x 29.4	116	18	\$1246

Standard with file/file drawer pedestal on the **left**. Pedestal locks. Grommet in worksurface. Shipped assembled in 1 carton.

- For 24" deep worksurfaces, order **G24__L4**. For 20" deep worksurfaces, order **G20__L4**.
- Keyboard and pencil trays for use on units 42" and above.

G2448R4	48 x 24 x 29.4	132	25	\$1309
G2442R4	42 x 24 x 29.4	124	21.5	\$1267
G2436R4	36 x 24 x 29.4	116	18	\$1246

Standard with file/file drawer pedestal on the **right**. Pedestal locks. Grommet in worksurface. Shipped assembled in 1 carton.

- For 24" deep worksurfaces, order **G24__R4**. For 20" deep worksurfaces, order **G20__R4**.
- Keyboard and pencil trays for use on units 42" and above.

Required specifications

Finish

Optional specifications

Key #

Additional grommet

Accessories

Power block

Keyboard tray

Pencil tray

FLUSH RETURNS **MODEL #** **DIMENSIONS** **WT/LB.** **CUBIC FT.** **LIST PRICE**

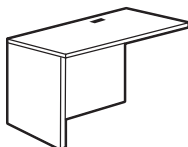

Flush Return - LEFT

W x D x H

G2448FLK	48 x 24 x 29.4	96	4.5	\$574
G2040FLK	40 x 20 x 29.4	78	4.5	\$510

Return has no pedestal. Grommet in worksurface. Shipped easy to assemble in 1 carton.
 • For 24" deep worksurfaces, order **G2448FLK**. For 20" deep worksurfaces, order **G2040FLK**.

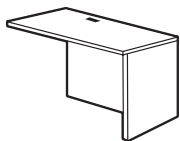

Flush Return - RIGHT

G2448FRK	48 x 24 x 29.4	96	4.5	\$574
G2040FRK	40 x 20 x 29.4	78	4.5	\$510

Return has no pedestal. Grommet in worksurface. Shipped easy to assemble in 1 carton.
 • For 24" deep worksurfaces, order **G2448FRK**. For 20" deep worksurfaces, order **G2040FRK**.

FLUSH BRIDGES

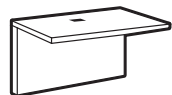

Flush Bridge

G2448FB	48 x 24 x 29.4	78	3.5	\$627
G2436FB	36 x 24 x 29.4	58	3.3	\$627
G2040FB	40 x 20 x 29.4	62	3.1	\$486

Top surface, back panel and hardware to connect two units. Grommet in worksurface. Shipped easy to assemble in 1 carton.
 • **G2448FB** will connect 66" and 72" units plus all D islands.
 • **G2040FB** will connect 60", 66" and 72" units plus all D islands and 5-sided corners.

CREDENZAS

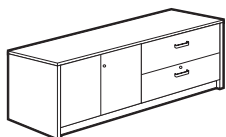

Credenza

G2072LS	72 x 20 x 29.4	222	29.4	\$1632
---------	----------------	-----	------	---------------

Standard with locking lateral file drawers on right and storage cabinet on left. Locking doors/drawers, keyed alike. Self-closing hinged doors covering one adjustable shelf. File bars included. One pencil tray. Shipped assembled in 1 carton.



Center Storage Credenza*

G2072C	72 x 20 x 29.4	213	29.4	\$1316
--------	----------------	-----	------	---------------

Standard with box/file pedestals on both sides and self-closing hinged center doors covering one adjustable shelf. Pedestal locks are inside the storage cabinet. One pencil tray. Shipped assembled in 1 carton.



Kneespace Credenza*

G2072CK	72 x 20 x 29.4	181	29.5	\$1196
G2066CK	66 x 20 x 29.4	174	27	\$1196

Standard with box/file pedestals on both sides. Center is open. Pedestals lock. One pencil tray. Grommet in worksurface. Shipped assembled in 1 carton.

Required specifications
Finish

Optional specifications
Key # (only G2072LS)
Full modesty*
Grommet

Accessories
Power block
Keyboard tray
Pencil tray

CREDENZAS

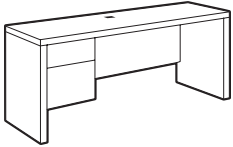

Single Pedestal Credenza - LEFT

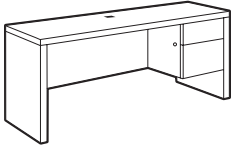

Single Pedestal Credenza - RIGHT

MODEL # DIMENSIONS WT/LB. CUBIC FT. LIST PRICE

W x D x H

G2072CSL	72 x 20 x 29.4	150	29.5	\$1185
----------	----------------	-----	------	---------------

Standard with box/file pedestal on the **left**. Pedestal locks. One pencil tray. Grommet in worksurface. Shipped assembled in 1 carton.

G2072CSR	72 x 20 x 29.4	150	29.5	\$1185
----------	----------------	-----	------	---------------

Standard with box/file pedestal on the **right**. Pedestal locks. One pencil tray. Grommet in worksurface. Shipped assembled in 1 carton.

5-SIDED CORNERS

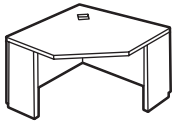

5-Sided Corner

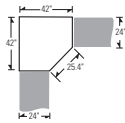

G42245C	42 x 42 x 29.4	114	5	\$1046
---------	----------------	-----	---	---------------

Connects to **24"** returns, bridges and other **24"** units. Grommet in worksurface. Narrow end panels on left and right. Shipped easy to assemble in 1 carton.

- $\frac{3}{4}$ modesty panel is not available.

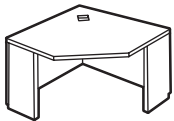

5-Sided Corner

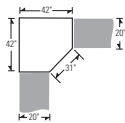

G42205C	42 x 42 x 29.4	108	5	\$1046
G36205C	36 x 36 x 29.4	92	4.75	\$1035

Connects to **20"** returns, bridges and other **20"** units. Grommet in worksurface. Narrow end panels on left and right. Shipped easy to assemble in 1 carton.

- $\frac{3}{4}$ modesty panel is not available.

"D" ISLANDS

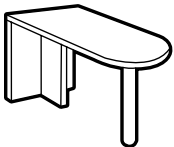

"D" Island - Full End Panel & Post

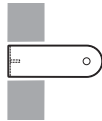

G3072FI	72 x 29.69 x 29.4	101	5	\$1035
G3066FI	66 x 29.69 x 29.4	96	4.6	\$919
G3060FI	60 x 29.69 x 29.4	91	4.2	\$878

Connects to single pedestal credenza with half end panel or bridge to create a "T" grouping. **Not freestanding.** Connecting hardware for flush installation included. Shipped easy to assemble in 1 carton.

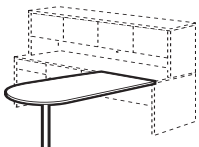

"D" Island - with Post

G3072I	72 x 29.69 x 29.4	72	5	\$813
G3066I	66 x 29.69 x 29.4	67	4.6	\$726
G3060I	60 x 29.69 x 29.4	62	4.2	\$679

Connects to single pedestal credenza with half end panel or bridge to create a "T" or "U" shape grouping. **Not freestanding.** Connecting hardware for flush installation included. Shipped easy to assemble in 1 carton.

Required specifications

Finish

Optional specifications

Key # (credenzas only)
Full modesty (credenzas only)
Grommet

Accessories

Power block
Keyboard tray
Pencil tray

"P" SHAPED ISLANDS **MODEL #** **DIMENSIONS** **WT/LB.** **CUBIC FT.** **LIST PRICE**

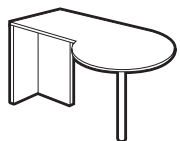

"P" Shaped Island

W x D x H					
G3072FPL	72 x 30-36 x 29.4	121	6		\$1285

Connects to single pedestal credenza with half end panel or bridge to create a "T" or "U" shape grouping. **Not freestanding.** Connecting hardware for flush installation included. Shipped easy to assemble in 1 carton.

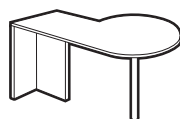

"P" Shaped Island

G3072FPR	72 x 30-36 x 29.4	121	6		\$1285
----------	-------------------	-----	---	--	---------------

Connects to single pedestal credenza with half end panel or bridge to create a "T" or "U" shape grouping. **Not freestanding.** Connecting hardware for flush installation included. Shipped easy to assemble in 1 carton.

OPEN HUTCHES

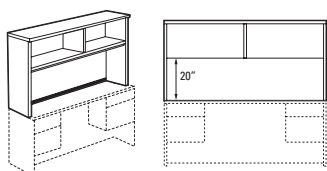

Open Hutch with Closed Back*

G72HOCB	72 x 15 x 36	138	7		\$1078
G66HOCB	66 x 15 x 36	133	7		\$1078
G60HOCB	60 x 15 x 36	123	5.25		\$898

One 1" thick fixed shelf **and one fixed shelf divider**. Closed back features a flexible sweep for wire management. Available in single color only. Shipped easy to assemble in 1 carton.

- **G71HOCB** for use when spanning 30" x 60/66" SPL/R and 20/24" x 42" FL/FR/L4/R4.
- **G69HOCB** for use when spanning 30" x 60/66" SPL/R and 20" x 42" FL/FR/L4/R4.
- Clearance from worksurface to hutch doors is 20".
- Woodgrain runs horizontal on both the upper and lower back panels.

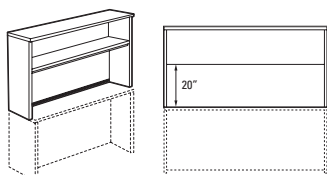

Open Hutch with Closed Back*

G48HOCB	48 x 15 x 36	100	4.2		\$762
G42HOCB	42 x 15 x 36	91	3.8		\$756
G36HOCB	36 x 15 x 36	82	3.3		\$651

One 1" thick fixed shelf. Closed back features a flexible sweep for wire management. Available in single color only. Shipped easy to assemble in 1 carton.

- Clearance from worksurface to hutch doors is 20".
- Woodgrain runs horizontal on both the upper and lower back panels.

CORNER HUTCHES



Corner Hutch with Closed Back*

G4242CH	42 x 15 x 36	137	6.25		\$1185
G3636CH	36 x 15 x 36	119	4.8		\$1185

One 1" thick fixed shelf. Closed back features a flexible sweep for wire management on lower right panel. Available in single color only. Shipped easy to assemble in 1 carton.

- Woodgrain runs horizontal on both the upper and lower back panels.

Required specifications
Finish

Optional specifications
Grommet (p-islands only)

Accessories
Doors*

PIGEON-HOLE STORAGE

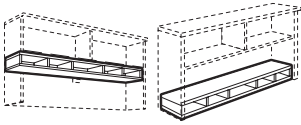

Horizontal Pigeon-Hole Storage

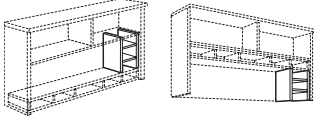

Vertical Pigeon-Hole Storage

MODEL #	DIMENSIONS W x D x H	WT/LB.	CUBIC FT.	LIST PRICE
AHS72	70 x 11.25 x 5.62	41	3	\$668
AHS71	69 x 11.25 x 5.62	41	3	\$698
AHS66	64 x 11.25 x 5.62	38	2.8	\$668
AHS60	58 x 11.25 x 5.62	35	2.5	\$550
AHS48	46 x 11.25 x 5.62	28	2	\$399
AHS42	40 x 11.25 x 5.62	24	2	\$399
AHS36	34 x 11.25 x 5.62	22	2	\$327

For additional storage. Can be **top** or **bottom** mounted. For use inside **straight hutch** (end panels not finished). Self edge facing. Shipped easy to assemble in 1 carton.

- Black finish is standard. Brushed Cobalt (**BRC**) is available at no charge, please specify.
- Cannot be used on A00S and C00S overstorage units.

AVS14	13.37 x 11.25 x 14.37	13	0.9	\$419
-------	-----------------------	----	-----	--------------

For use in conjunction with the horizontal pigeon-hole storage. Can be used **under** or **over** horizontal unit. Facing self edge. Shipped easy to assemble in 1 carton.

- Black finish is standard. Brushed Cobalt (**BRC**) is available at no charge, please specify.

DOORS FOR HUTCHES

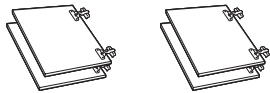

Four-Door Kit

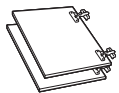

Two-Door Kit

GDOOR72	72 x 0.69 x 15	24	1.75	\$506
GDOOR66	66 x 0.69 x 15	22	1.75	\$506
GDOOR60	60 x 0.69 x 15	20	1.75	\$506

For use on 72", 71", 69", 66" and 60"W straight hutches. Hinges included. Locks available. **Add \$260** for two locks. Doors for units 60" wide or more require two locks. Shipped easy to assemble, 1 kit per carton.

GDOOR48	48 x 0.69 x 15	17	1.75	\$252
GDOOR42	42 x 0.69 x 15	16	1.75	\$252
GDOOR36	36 x 0.69 x 15	14	1.75	\$252

For use on 48", 42" 40" and 36"W straight hutches. Hinges included. Locks available. **Add \$131** for one lock. Doors for units 48" wide or less require one lock. Shipped easy to assemble, 1 kit per carton.

Required specifications
Finish

Optional specifications
Key # (only GDOORxx)

TACKBOARDS FOR HUTCHES

NOTES: Tackboards can be upholstered in all of the following fabrics:

- Anchorage
- Global seating fabrics*
- Lola
- Merge

* Contact Customer Service for pricing.

TACKBOARDS FOR HUTCHES

MODEL # DIMENSIONS WT/LB. CUBIC FT. LIST PRICE

W x D x H

TB7018	70 x 1 x 18	12	2.2	\$367
--------	-------------	----	-----	--------------

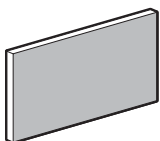

Tackboard

For use on **G72HOCB** straight hutch. Includes mounting screws and covers.

TB6918	69.5 x 1 x 18	12	2.1	\$367
--------	---------------	----	-----	--------------

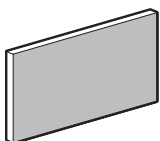

Tackboard

For use on **G71HOCB** straight hutch. Includes mounting screws and covers.

TB6618	66 x 1 x 18	12	2.2	\$347
--------	-------------	----	-----	--------------

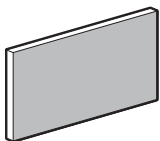

Tackboard

For use on **G68HOCB** straight hutch. Includes mounting screws and covers.

TB6418	64 x 1 x 18	11	2	\$356
--------	-------------	----	---	--------------

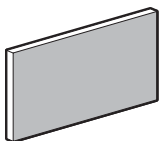

Tackboard

For use on **G66HOCB** straight hutch. Includes mounting screws and covers.

TB5818	58 x 1 x 18	10	1.8	\$347
--------	-------------	----	-----	--------------

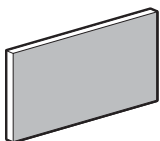

Tackboard

For use on **G60HOCB** straight hutch. Includes mounting screws and covers.

Required specifications

Fabric

TACKBOARDS FOR HUTCHES

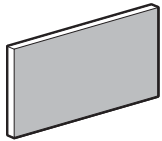

Tackboard

MODEL #	DIMENSIONS W x D x H	WT/LB.	CUBIC FT.	LIST PRICE
TB4618	46 x 1 x 18	9	1.6	\$338

For use on **G48HOCB** straight hutch. Includes mounting screws and covers.

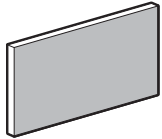

Tackboard

TB4018	40 x 1 x 18	8	1.4	\$322
--------	-------------	---	-----	--------------

For use on **G42HOCB** straight hutch. Includes mounting screws and covers.

ACCESSORIES



2 Drawer Lateral File*

G2036LF	36 x 20 x 29.4	109	15	\$1165
---------	----------------	-----	----	---------------

Two full suspension drawers. Front-to-back and side-to-side letter/legal filing capability with lock. Anti-lock tilt suspension. Shipped assembled in 1 carton.

- Back of file is always Black.
- File drawer construction is for accommodating hanging files NOT for stacking materials on the drawer bottom.

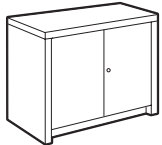

Storage Cabinet*

G2036SC	36 x 20 x 29.4	109	15	\$1014
---------	----------------	-----	----	---------------

Hinged doors cover one adjustable shelf. Standard with lock. Shipped assembled in 1 carton.

- Back of storage cabinet is always Black.

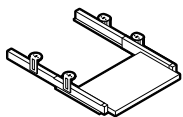

Pull-Out Keyboard

APOKL28	28 x 17 x 3.5	13	0.9	\$296
APOKL22	22 x 17 x 3.5	12	0.9	\$270

Constructed of thermally fused laminate.

- APOKL28 accommodates keyboard and mouse pad.

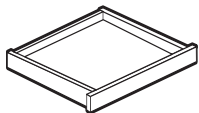

Center Drawer

CD28	28 x 18 x 3	5	1	\$248
------	-------------	---	---	--------------

Can be mounted on double-pedestal desks, credenzas or worksurfaces.

Required specifications

Fabric (only tackboards)
Finish (not tackboards)

Optional specifications

Key #*
Grommet (only G2036LF)

ACCESSORIES MODEL # DIMENSIONS WT/LB. CUBIC FT. LIST PRICE

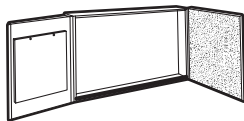

Visual Board

	W x D x H			
GVB4848	48 x 4 x 48	122	9.25	\$1408

Includes whiteboard and two side opening doors containing cork board on right door and 50-sheet paper writing pad on left door. Marker board can be used for projection.

- **NOTE:** Care should be taken to mount the units. Units should be mounted to wall studs using correct fasteners. Failure to do so may result in collapse of the unit and subsequent personal injury. **Mounting hardware not included.** Mounting hardware used should be based on wall material. Consult an installation professional for proper wall mounting..

Required specifications
Finish



The design of Princeton reflects the personality of today's young, dynamic workforce. The freestanding, modular components build out from you and where you work. With over 1000 available components, Princeton offers a flexible footprint that's simple to reconfigure. A variety of storage options allow you to do more with less space.

Princeton delivers contemporary design to the workplace; whether it be in commercial and corporate offices, government offices, small businesses, banking, legal, accounting, hospitality or the professional home office. Every element, from the mix of materials and finishes to open storage pieces, floating modesty panels and overlapping surfaces, has been designed to provide visual appeal and intelligent function. Princeton is a freestanding and fully modular collection offering maximum flexibility; ease of installation and facilitates simple reconfigurations. The overlapping worksurface design also allows the footprint to adapt to smaller spaces by just a few inches.

Features and Benefits

- 1" thick worksurfaces in thermally fused or high pressure laminate.
- Worksurfaces feature Global's preferred edging in matching color.
- Optional tempered glass shelves with acid etched finish on one side.
- Counterweights standard on all mobile pedestals, lateral files and credenzas.
- Handles & pulls in satin anodized finish standard on all credenza, pedestal drawers and cabinet doors.
- Monoposts and hutch supports standard in Tungsten finish.
- Benches double as lateral filing.
- Pull-out equipment shelves on select credenzas.
- Energy efficient LED lighting for overhead storage cabinets.
- Grommets and power blocks to accommodate power/data needs.
- Choose glass or fabric equipment screens.



Bench doubles as lateral filing.



Pull-out equipment shelf (printer not included).



Bookshelf with accessory hook.

GENERAL INFORMATION

- Over 1000 components are available.
- No cubicles or panels needed for configurations.
- Products can be added and reconfigured as needed.
- Princeton desk and storage products have been tested and comply with all BIFMA mechanical tests.
- For environmental certification, please visit globalfurnituregroup.com.

WORKSURFACES

- 1" thick high performance thermally fused laminate tops sealed with Global's preferred edging in matching color.
- High pressure tops are available in all Princeton laminate finishes at an extended lead time. Please see model # for pricing and availability.
- Worksurfaces with metal legs which have a span of 54" and over are standard with metal support hat channel(s); support channels are Black.
- 36" deep - 2 - 2"H support channels.

CONSTRUCTION

- Laminate end panel and metal leg products are **not intended** to be combined for the most visually compatible design. They are, however, interchangeable if required.
- All components, with the exception of worksurfaces, have 1mm thick matching edges.
- Leveling glides are standard on all floor units.
- End panels are 1.5" thick on laminate end panel desks and credenzas. Cabinet end panels are 1 1/16" thick.
- 1" x 2" metal frame legs for desks and returns (closed 'O' style leg). Available finish options: Tungsten (**TTU**), Black (**TBL**) or Designer White (**TDW**).
- 1" x 2.5" metal frame legs for freestanding tables (open 'U' style leg). Available finish options: Tungsten (**TTU**), Black (**TBL**) or Designer White (**TDW**).
- Constructed of 45 lb. density particle board with high performance thermally fused laminate.
- Mobile pedestals and mobile lateral files come standard with front locking casters.
- Counterweights are standard on all pedestals, lateral files, credenzas and cabinets.
- Stool and rolling table come standard with non-locking casters.
- Laminate shelves are 1 1/16" thick and edged on all 4 sides. Tempered glass is 6mm thick with acid etched finish on one side.
- Credenzas come standard with file bars for side-to-side and front-to-back letter/legal capability. File bars are not shipped with cabinets and pedestals.
- Handles and pulls in satin anodized finish are standard on all credenza, pedestal drawers and cabinet doors.
- Pull-out equipment shelves are available on select credenzas.
- Grommets and power blocks are available to accommodate power/data needs.

EDGE DETAILS

- All worksurfaces have 2mm thick matching edge detail on all sides.
- All other components have 1mm thick edge detail on all sides.
- Edging cannot be specified separately. No substitutions.

STORAGE

- Mobile storage greater than 25.5"H may only be used with 29"H Princeton products with laminate end panels or gables. Princeton products with metal legs for support do not accommodate 27"H mobile units.
- Roll-out shelf on credenza holds up to 80 lbs.
- Laminate shelves are standard on storage cabinets. Tempered glass is available at an upcharge (varies by item; see product for details). Specify (**TG**).
- All cabinets with side open shelf area that aligns with 29"H or 27"H credenzas - fixed shelf is 1" thick.
- Recycling/waste drawer accommodates 1 recycling basket and 1 waste basket.

LAMINATE MODESTY PANELS

- Standard on all desks with laminate end panels, returns with laminate end panels and bridges for laminate end panel desks.
- Flush on freestanding returns with laminate end panels.
- Recessed 4" deep on 24"D desks with laminate end panels, 5" deep on 30"D desks with laminate end panels and 6" deep on 36"D desks with laminate end panels.
- Recessed 4" on 24"D, 5" deep on 30"D, and 6" deep on 36"D flush and overlapping returns with laminate end panels.
- Recessed 4" on 24" deep and 5" deep on 30" deep flush and overlapping bridges with laminate end panels.
- Desks and returns feature modesty panel that is flush with end panel.
- Bottom of laminate modesty panel is 18" from floor.

GLASS DESKTOP PANELS

- Glass desktop panel is sold separately, see page 76.
- Available for installation onto desks, returns, bridges and conference tops.
- Made of 6mm tempered glass with acid etched finish on one side.
- On-site installation is required. Installation instructions included with product.

FABRIC DESKTOP/MODESTY PANELS

- Fabric desktop/modesty panels are sold separately, see page 77.
- Products may be upmounted as a desk top privacy screen or down mounted as a modesty panel.
- Available in:
 - Grade 2:** Lola
 - Grade 3:** Anchorage, Merge
- On-site installation is required. Installation instructions included with product.
- Non-tackable.
- Bottom of fabric modesty panel is 15.5" from floor.

PET FELT DESKTOP/MODESTY PANELS

- PET Felt desktop/modesty panel is sold separately, see page 77.
- 9mm thick panels offered in nine finishes: Black (**BLK**), Brick (**BRI**), Denim (**DEN**), Harvest (**HVT**), Graphite (**GPH**), Mist (**MTS**), Pewter (**PWT**), Shamrock (**SHR**) and White (**WHT**).
- Made from 100% PET (polyester) fiber with a high content of post-recycled material (50%), free of added chemicals, binders and adhesives.
- Lightweight panels are tackable, impact and tear resistant, bacteria resistant, moisture resistant, and installation friendly.
- Variation in fiber mix and color are inherent to the character of the product.
- Clamps are included, available in satin anodized finish only.

CREDENZAS

- Available in 29", 27" and 23" heights.
- 29" high connect to flush returns, flush conference tops and flush bridges.
- 27" high connect to overlapping returns, overlapping conference tops and overlapping bridges.
- Fixed drawer widths - see individual models for details.
- Upper adjustable shelf must be removed when products with laminate modesty panels are installed (i.e. PN2448RFR flush return with laminate end panel or PN2436BF flush bridge for laminate end panel desk).
- Connection of flush or overlapping surfaces to credenzas is only possible over full height opening.
- All credenza tops are 1" thick.
- Grommet location is 2.5" from the back edge to the cut-out edge.
- Grommet locations are only available as shown, otherwise a quote is required.

LOCKS

- Standard on all credenzas, storage cabinets, lateral files, pedestals & benches.
- Lock on all credenzas, cabinets and pedestals is always on the bottom drawer.
- All components within a workstation or private office can be keyed alike. For up to 20 key numbers, the lead times are standard.
- To order specified keying, tag each component of each workstation or office with a lock number between 401 and 420.
- For projects larger than 20 offices, 20 additional key numbers are available at no charge, from 421 to 440. Delivery will be extended an additional week.
- Storage cabinets and pedestals with box/box/file drawers - only file drawer and lower box drawer are locking. Credenza file drawer lock secures both drawers.

HUTCHES & OVERHEAD STORAGE

- Available in 60", 66", 72", 78" and 84" widths.
- Hutches with full back feature one small hole in each corner for wire pass-through.
- 15.75" height clearance between worksurface and underside of hutch.
- Overhead storage cabinets have full width lower storage with center divider.
- Hutches feature 1" x 2" steel support frame in Black (**TBL**), Designer White (**TDW**) or Tungsten (**TTU**).
- Laminate and tempered glass sliding doors available.
- Hutches cannot be placed on desks with laminate end panels.
- Wallhung mounting rails are provided; wall fastener hardware is not included.
- Locks are not available.
- Energy efficient LED lighting available, see page 466.

TABLES

- 1" x 2.5" open metal frame leg. Available finish options: Black (**TBL**), Designer White (**TDW**) or Tungsten (**TTU**).
- Standard with 1" thick top and Global's preferred edging in matching color.
- 120" and 144" wide table tops with center leg are shipped in two pieces.
- Tables which have a span of 54" or wider are standard with 2"H metal support hat channel(s); support channels are Black.
- Grommets and power block cut-outs are available for most tables. Due to support channel location(s) for all 29" high tables, a quote request is required. Contact our Specials Department.
- Available standard with levelers or locking casters.

CONNECTION

- Metal flat plates and wood screws are provided for connection between two units.

TACKBOARDS

- Tackboards available for hutches and overhead units.
- Available to fit 60", 66", 72", 78" and 84" widths.
- Available in:
 - Anchorage
 - Lola
 - Merge
- Contact Customer Service for COM selection.

CUSHIONS

- Cushions are sold separately.
- Cushions are available in all Global seating fabrics including bonded leather. Contact Customer Service for COM selection and procedure.
- Cushions are not available in leather, leather/mock leather or mesh.

SPECIAL SIZES

- Special sizes are available, submit a SPECIALS / MTM quote request through the Global Dealer Centre.
- Orders must indicate the custom quote number and list price.
- Changes to custom quotes are not permitted. Any revisions will necessitate a new quotation.

TASK LIGHTS

- Optional, energy efficient LED task lights (ultra slim design) are available for mounting under hutches and overheads.
- Hutches and overhead storage cabinets are predrilled for easy installation.
- Available in 12", 20" and 40" widths.

WIRE MANAGEMENT

- 2"W x 2"H.
- Plastic tray flexes to receive and hold electrical and data wires.
- Quickly attaches with double-sided tape (included).
- Finished Black only.

MONOPOST

- Standard support for conference tops; support for select desks and returns.
- 4" square post with 10" square base.

PLANTERS

- Plastic planter pots provided.
- 8.5" diameter x 8"H.
- Available in Black (**BK**) or White (**WT**). Must specify at time of order.

SHIPPING

- Items are shipped easy to assemble unless otherwise noted.
- Shipped in 1 carton unless otherwise noted.
- Connecting hardware included.

SPECIFICATIONS

- Specifications marked with an * are applicable to only those products which have the * symbol beside the product name.

1. SPECIFY MODEL NUMBER

2. SPECIFY FINISH

Top Finishes:

- ACJ** Absolute Acajou
- ASN** Asian Night
- AWC** Avant Cherry
- AWH** Avant Honey
- BLK** Black
- BZD** Blizzard
- BRC** Brushed Cobalt
- CMB** Clear Maple
- CGY** Custom Grey
- DES** Dark Espresso
- DWT** Designer White
- FAS** Fashionista
- FCL** First Class
- NBL** Noce Biondo
- NGL** Noce Grigio
- NEL** Noce Leggero
- NML** Noce Medio
- QTM** Quartered Mahogany
- SBY** Sheer Beauty
- SDT** Stonedust
- WHE** Walnut Heights
- WHC** White Chocolate
- WCR** Winter Cherry

Base Finishes:

- ACJ** Absolute Acajou
- ASN** Asian Night
- AWC** Avant Cherry
- AWH** Avant Honey
- BLK** Black
- BZD** Blizzard
- BRC** Brushed Cobalt
- CMB** Clear Maple
- CGY** Custom Grey
- DES** Dark Espresso
- DWT** Designer White
- FAS** Fashionista
- FCL** First Class
- NBL** Noce Biondo
- NGL** Noce Grigio
- NEL** Noce Leggero
- NML** Noce Medio
- QTM** Quartered Mahogany
- SBY** Sheer Beauty
- SDT** Stonedust
- WHE** Walnut Heights
- WHC** White Chocolate
- WCR** Winter Cherry

Door, Drawer and Cabinet Front Finishes:

- ACJ** Absolute Acajou
- ASN** Asian Night
- AWC** Avant Cherry
- AWH** Avant Honey
- BLK** Black
- BZD** Blizzard
- BRC** Brushed Cobalt
- CMB** Clear Maple
- CGY** Custom Grey
- DES** Dark Espresso
- DWT** Designer White
- FAS** Fashionista
- FCL** First Class
- NBL** Noce Biondo
- NGL** Noce Grigio
- NEL** Noce Leggero
- NML** Noce Medio
- QTM** Quartered Mahogany
- SBY** Sheer Beauty
- SDT** Stonedust
- WHE** Walnut Heights
- WHC** White Chocolate
- WCR** Winter Cherry

Monopost Finishes

4" square monopost is available in Tungsten (TTU), Black (TBL) or Designer White (TDW) finish.

Planters

Planter pots are standard in White. Available in Black (BK) at no upcharge. Must specify at time of order.

Metal Frame Desk Legs

1" x 2" metal frame legs are available in Tungsten (TTU), Black (TBL) or Designer White (TDW) finish.

Metal Frame Table Legs

1" x 2.5" metal frame legs available in Tungsten (TTU), Black (TBL) or Designer White (TDW) finish.

Metal Hutch Supports

1" x 2" metal supports are available in Tungsten (TTU), Black (TBL) or Designer White (TDW) finish.

3. SPECIFY OPTIONS

GROMMETS

- One grommet in satin anodized finish is standard on many components, as specified.
- Additional grommets may be available in other standard worksurface locations (left, center or right).
- Order as: **Left POG1, Center POG2 or Right POG3. Add \$94.**

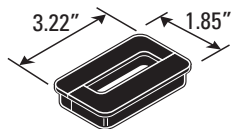

- Worksurface grommet hole dimensions are 3.22"W by 1.85"D.
- Standard grommet position is POG2 in desks, returns, bridges and conference tops.
- Modesty panel pass-through hole dimensions are 3.43"W by 2"H.
- Standard grommets are as per lineart depicted. Grommets may be placed at non-standard locations on select models only as indicated on product pages.
Order as **PCSG. Add \$132.**
A drawing must be supplied with vertical and horizontal dimensions to the center of the cut-out. Any others would require a special quote.
- Components that come standard with grommet may be ordered without a grommet.
Order as **RSG. Add \$52.**
- Grommet only available at POG2 on the following 48"W worksurfaces:
 - Desks: PN2448DK, PN3048DK, PN3648DK
 - Return-freestandings: PN246029R, PN246027R
 - Return-flushes: PN2448RFR, PN3048RFR, PN3648RFR, PN2448RFL, PN3048RFL, PN3648RFL

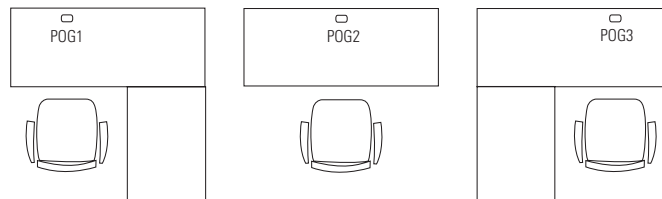

POWER BLOCK

- Power block (model **PGDPS20**) with 1 power outlet and 1 data opening, 12 foot long power cord, available for mounting under worksurfaces or inside of laminate end panels.
- Power block (model **PGDPS21**) with 2 power outlets and 1 data opening, 12 foot long power cord, available for mounting under worksurfaces or inside of laminate end panels.
- Power bar (model **PGDPS41**) with 4 power outlets and 1 data opening, 12 foot long power cord, available for mounting behind credenza pull-out shelf or at back of credenza opening.
- Rectangular shape. Finished in Tungsten (TN).
- Power block dimensions:
 - PGDPS20: 2.5"D x 3.50"W x 2.25"H.
 - PGDPS21: 2.5"D x 6.75"W x 2.25"H.
- Power bar dimensions:
 - PGDPS41: 2.5"D x 10.25"W x 2.22"H.

FREESTANDING DESKS

MODEL # DIMENSIONS WT/LB. CUBIC FT. LIST PRICE HP ADD

W x D x H

PN2484DK	84 x 24 x 29	115	6.5	\$866	\$106
PN2478DK	78 x 24 x 29	110	6	\$842	\$104
PN2472DK	72 x 24 x 29	104	5.5	\$804	\$103
PN2466DK	66 x 24 x 29	98	5	\$793	\$103
PN2460DK	60 x 24 x 29	93	4.75	\$750	\$103
PN2454DK	54 x 24 x 29	88	4.5	\$742	\$101
PN2448DK	48 x 24 x 29	83	4	\$718	\$99
PN3084DK	84 x 30 x 29	139	7.5	\$881	\$109
PN3078DK	78 x 30 x 29	132	7	\$855	\$108
PN3072DK	72 x 30 x 29	126	6.5	\$827	\$106
PN3066DK	66 x 30 x 29	119	6	\$801	\$104
PN3060DK	60 x 30 x 29	112	5.5	\$769	\$103
PN3054DK	54 x 30 x 29	106	5	\$756	\$103
PN3048DK	48 x 30 x 29	98	4.5	\$731	\$103
PN3684DK	84 x 36 x 29	163	8.75	\$932	\$120
PN3678DK	78 x 36 x 29	155	8.25	\$902	\$115
PN3672DK	72 x 36 x 29	147	7.5	\$885	\$113
PN3666DK	66 x 36 x 29	140	7	\$844	\$108
PN3660DK	60 x 36 x 29	132	6.5	\$812	\$104
PN3654DK	54 x 36 x 29	124	5.75	\$787	\$103
PN3648DK	48 x 36 x 29	117	5.25	\$741	\$103

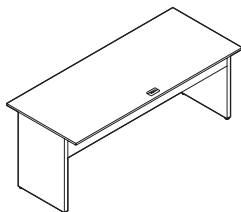

Freestanding Desk

Standard with inset end panel on both ends and 10”H modesty panel with pass-through grommet. Connects to flush return with laminate end panel, bridges for laminate end panel desks, flush return with bookshelf, flush conference tops. Can be placed over 27”H freestanding returns or 23”H/27”H credenzas. Grommet in worksurface. Shipped easy to assemble in 1 carton.

RETURNS - LAMINATE END PANELS

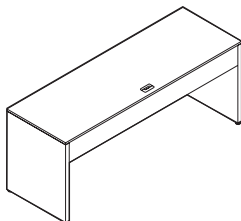

Freestanding Return - 29”H

PN248429R	84 x 24 x 29	133	6.5	\$845	\$119
PN247829R	78 x 24 x 29	127	6	\$818	\$114
PN247229R	72 x 24 x 29	122	5.5	\$794	\$108
PN246629R	66 x 24 x 29	116	5	\$755	\$106
PN246029R	60 x 24 x 29	110	4.75	\$746	\$103

Standard with flush laminate 1.5” thick end panels. 10”H modesty panel without pass-through grommet. Connects to flush return with laminate end panel, bridges for laminate end panel desks, flush return with bookshelf and flush conference tops. Can be placed over 27”H freestanding returns or 23”H/27”H credenzas. Grommet in worksurface. Shipped easy to assemble in 1 carton.

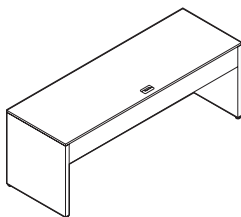

Freestanding Return - 27”H

PN248427R	84 x 24 x 27	129	6.5	\$831	\$115
PN247827R	78 x 24 x 27	124	6	\$808	\$111
PN247227R	72 x 24 x 27	119	5.5	\$784	\$106
PN246627R	66 x 24 x 27	113	5	\$757	\$104
PN246027R	60 x 24 x 27	107	4.75	\$704	\$101

Standard with flush laminate 1.5” thick end panels. 10”H modesty panel without pass-through grommet. Supports overlapping return with laminate end panel, overlapping bridge for laminate end panel desks and overlapping return with bookshelf and overlapping conference top. Can be placed under desk. Grommet in worksurface. Shipped easy to assemble in 1 carton.

Required specifications

Top finish
Base finish

Optional specifications

HP laminate
POG1, POG2
PCSG - custom grommet
RSG - no grommet

Accessories

Power block Wire manager
Keyboard tray Keyboard mechanism
Fabric desktop / M.P.
Glass desktop panel

RETURNS - LAMINATE END PANELS

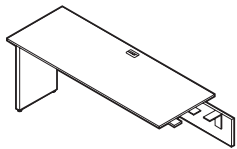

Flush Return - 29" H - LEFT*

MODEL #	DIMENSIONS W x D x H	WT/LB.	CUBIC FT.	LIST PRICE	HP ADD
PN2472RFL	72 x 24 x 29	93	6.5	\$721	\$113
PN2466RFL	66 x 24 x 29	87	6	\$698	\$109
PN2460RFL	60 x 24 x 29	81	5.75	\$656	\$104
PN2454RFL	54 x 24 x 29	75	5.25	\$640	\$103
PN2448RFL	48 x 24 x 29	70	4.75	\$611	\$101

Return has no pedestal. Standard with inset end panel on **left**. 10"H modesty panel with pass-through grommet. Connects to freestanding desk with laminate end panels, 29"H freestanding returns and 29"H credenzas. Grommet in worksurface. Shipped easy to assemble in 2 carton.

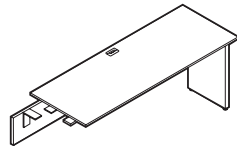

Flush Return - 29" H - RIGHT*

PN2472RFR	72 x 24 x 29	93	6.5	\$721	\$113
PN2466RFR	66 x 24 x 29	87	6	\$698	\$109
PN2460RFR	60 x 24 x 29	81	5.75	\$656	\$104
PN2454RFR	54 x 24 x 29	75	5.25	\$640	\$103
PN2448RFR	48 x 24 x 29	70	4.75	\$611	\$101

Return has no pedestal. Standard with inset end panel on **right**. 10"H modesty panel with pass-through grommet. Connects to freestanding desk with laminate end panels, 29"H freestanding returns and 29"H credenzas. Grommet in worksurface. Shipped easy to assemble in 2 carton.

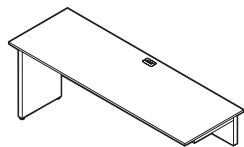

Overlapping Return - 29" H - LEFT*

PN2484ROL	84 x 24 x 29	106	6.5	\$799	\$91
PN2478ROL	78 x 24 x 29	101	6	\$745	\$90
PN2472ROL	72 x 24 x 29	95	5.5	\$721	\$84

Standard with inset laminate end panel on **left** and 10"H modesty panel with pass-through grommet. Overlaps 27"H credenza and 27"H freestanding returns. Grommet in worksurface. 1" spacer included. Shipped easy to assemble in 1 carton.

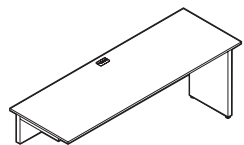

Overlapping Return - 29" H - RIGHT*

PN2484ROR	84 x 24 x 29	106	6.5	\$799	\$91
PN2478ROR	78 x 24 x 29	101	6	\$745	\$90
PN2472ROR	72 x 24 x 29	95	5.5	\$721	\$84

Standard with inset laminate end panel on **right** and 10"H modesty panel with pass-through grommet. Overlaps 27"H credenza and 27"H freestanding Returns. Grommet in worksurface. 1" spacer included. Shipped easy to assemble in 1 carton.

BRIDGES FOR LAMINATE END PANEL DESKS

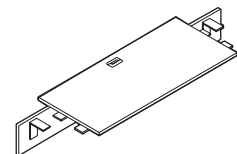

Flush Bridge

PN2454BF	54 x 24 x 11	61	3.5	\$570	\$88
PN2448BF	48 x 24 x 11	57	3.25	\$543	\$81
PN2442BF	42 x 24 x 11	51	3	\$518	\$77
PN2436BF	36 x 24 x 11	49	2.75	\$486	\$74

Standard with 10"H modesty panel with pass-through grommet. Connects between any two: freestanding desk with laminate end panels, 29"H freestanding returns, conference top for U configurations or 29"H credenza opening. Subtop finish is granite with Black edge. Grommet in worksurface. Shipped easy to assemble in 2 carton.

Required specifications

Top finish
Base finish

Optional specifications

HP laminate
POG1, POG3*
PCSG - custom grommet
RSG - no grommet

Accessories

Power block
Keyboard tray
Fabric desktop / M.P.
Glass desktop panel
Wire manager
Keyboard mechanism

BRIDGES FOR LAMINATE END PANEL DESKS

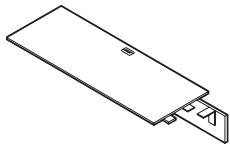

Overlapping Bridge - LEFT

MODEL #	DIMENSIONS W x D x H	WT/LB.	CUBIC FT.	LIST PRICE	HP ADD
PN2478BOL	78 x 24 x 11	89	7	\$682	\$101
PN2472BOL	72 x 24 x 11	83	6.5	\$649	\$91
PN2466BOL	66 x 24 x 11	77	6	\$626	\$85
PN2460BOL	60 x 24 x 11	72	5.75	\$617	\$83

Standard with 10"H modesty panel with pass-through grommet. Connects freestanding desk with laminate end panels, 29"H freestanding returns, conference top for U configurations on one end, and overlaps 27"H credenza or 27"H freestanding return on other end. Subtop finish is granite with Black edge. Grommet in worksurface. Includes 1" spacer, one side only. Shipped easy to assemble in 2 carton.

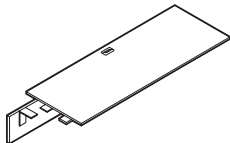

Overlapping Bridge - RIGHT

PN2478BOR	78 x 24 x 11	89	7	\$682	\$101
PN2472BOR	72 x 24 x 11	83	6.5	\$649	\$91
PN2466BOR	66 x 24 x 11	77	6	\$626	\$85
PN2460BOR	60 x 24 x 11	72	5.75	\$617	\$83

Standard with 10"H modesty panel with pass-through grommet. Connects freestanding desk with laminate end panels, 29"H freestanding returns, conference top for U configurations on one end, and overlaps 27"H credenza or 27"H freestanding return on other end. Subtop finish is granite with Black edge. Grommet in worksurface. Includes 1" spacer, one side only. Shipped easy to assemble in 2 carton.

FREESTANDING DESKS WITH METAL LEGS

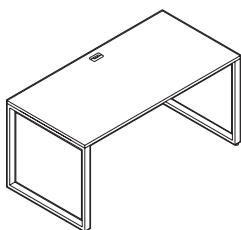

Freestanding Desk with Metal Legs*

PN2484DM	84 x 24 x 29	116	13.25	\$1446	\$219
PN2478DM	78 x 24 x 29	111	13	\$1340	\$204
PN2472DM	72 x 24 x 29	104	12.5	\$1182	\$179
PN2466DM	66 x 24 x 29	100	12	\$1169	\$177
PN2460DM	60 x 24 x 29	95	11.5	\$1148	\$175
PN2454DM	54 x 24 x 29	90	11.25	\$1113	\$169
PN2448DM	48 x 24 x 29	78	9.25	\$993	\$152
PN3084DM	84 x 30 x 29	136	16.25	\$1501	\$229
PN3078DM	78 x 30 x 29	129	15.75	\$1398	\$211
PN3072DM	72 x 30 x 29	124	15.25	\$1258	\$193
PN3066DM	66 x 30 x 29	117	14.75	\$1219	\$184
PN3060DM	60 x 30 x 29	111	14.25	\$1182	\$180
PN3054DM	54 x 30 x 29	105	13.75	\$1159	\$176
PN3048DM	48 x 30 x 29	92	11.25	\$1029	\$156
PN3684DM	84 x 36 x 29	165	19	\$1695	\$258
PN3678DM	78 x 36 x 29	157	18.5	\$1558	\$236
PN3672DM	72 x 36 x 29	149	17.75	\$1518	\$231
PN3666DM	66 x 36 x 29	141	17.25	\$1337	\$204
PN3660DM	60 x 36 x 29	133	16.75	\$1292	\$196
PN3654DM	54 x 36 x 29	125	16.25	\$1224	\$186
PN3648DM	48 x 36 x 29	108	15.25	\$1112	\$169

Standard with two 1" x 2" metal open frame legs with support channel(s). Connects to flush returns with metal leg, bridges for desks and returns with metal leg, flush return with bookshelf and flush conference tops. Grommet in worksurface. Shipped easy to assemble in 3 cartons.

Required specifications

Top finish
Base finish (not PNxxxxDM)
Leg finish*

Optional specifications

HP laminate PCSG - custom grommet
POG1 (only PNxxxxBOR) RSG - no grommet
POG3 (only PNxxxxBOL)
POG1, POG3 (only PNxxxxDM)

Accessories

Power block Wire manager
Keyboard tray Keyboard mechanism
Fabric desktop / M.P. Glass desktop panel

FREESTANDING DESKS W/BOOKSHELF **MODEL #** **DIMENSIONS** **WT/LB.** **CUBIC FT.** **LIST PRICE** **HP ADD**

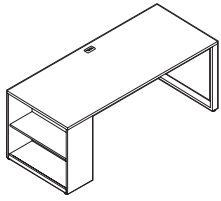

Freestanding Desk with Bookshelf - LEFT

W x D x H

PN3060DBL	60 x 30 x 29	134	15.5	\$1278	\$195	
PN3066DBL	66 x 30 x 29	147	18.25	\$1405	\$214	
PN3072DBL	72 x 30 x 29	153	18.75	\$1447	\$219	
PN3078DBL	78 x 30 x 29	159	19.25	\$1557	\$236	
PN3084DBL	84 x 30 x 29	166	19.75	\$1639	\$250	
PN3672DBL	72 x 36 x 29	182	22.25	\$1499	\$229	
PN3678DBL	78 x 36 x 29	190	22.75	\$1622	\$247	
PN3684DBL	84 x 36 x 29	198	23.25	\$1821	\$276	

12"D bookcase with adjustable shelf on **left**. One 1" x 2" metal open frame leg with support channel(s). Right side connects to flush returns with metal leg, bridges for desks and returns with metal leg, flush return with bookshelf and flush conference tops. Grommet in worksurface. Shipped easy to assemble in 3 cartons.

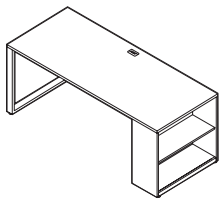

Freestanding Desk with Bookshelf - RIGHT

PN3060DBR	60 x 30 x 29	134	15.5	\$1278	\$195	
PN3066DBR	66 x 30 x 29	147	18.25	\$1405	\$214	
PN3072DBR	72 x 30 x 29	153	18.75	\$1447	\$219	
PN3078DBR	78 x 30 x 29	159	19.25	\$1557	\$236	
PN3084DBR	84 x 30 x 29	166	19.75	\$1639	\$250	
PN3672DBR	72 x 36 x 29	182	22.25	\$1499	\$229	
PN3678DBR	78 x 36 x 29	190	22.75	\$1622	\$247	
PN3684DBR	84 x 36 x 29	198	23.25	\$1821	\$276	

12"D bookcase with adjustable shelf on **right**. One 1" x 2" metal open frame leg with support channel(s). Left side connects to flush returns with metal leg, bridges for desks and returns with metal leg, flush return with bookshelf and flush conference tops. Grommet in worksurface. Shipped easy to assemble in 3 cartons.

RETURNS W/METAL LEG

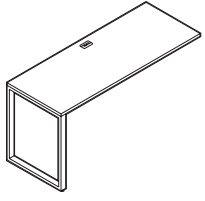

Flush Return with Metal Leg - LEFT

PN2448FML	48 x 24 x 29	59	5.75	\$647	\$98	
PN2454FML	54 x 24 x 29	69	7.75	\$774	\$119	
PN2460FML	60 x 24 x 29	75	8.25	\$813	\$124	
PN2466FML	66 x 24 x 29	80	8.5	\$843	\$128	
PN2472FML	72 x 24 x 29	85	9	\$870	\$133	
PN2478FML	78 x 24 x 29	91	9	\$970	\$145	
PN3048FML	48 x 30 x 29	71	7	\$686	\$104	
PN3054FML	54 x 30 x 29	82	9.25	\$808	\$123	
PN3060FML	60 x 30 x 29	88	9.75	\$844	\$128	
PN3066FML	66 x 30 x 29	94	10.25	\$875	\$133	
PN3072FML	72 x 30 x 29	100	10.75	\$931	\$141	
PN3078FML	78 x 30 x 29	106	10.75	\$1017	\$154	

1" x 2" metal frame leg on **left**. Support channel(s) included for units 72"W and above. Connects to freestanding desk with metal legs, freestanding desk with bookshelf and metal leg or 29"H credenza opening. Grommet in worksurface. Shipped easy to assemble in 2 cartons.

Required specifications	Optional specifications	Accessories
Top finish	HP laminate	Power block Wire manager
Base finish	POG1, POG3 (N/A to 48"W)	Keyboard tray Keyboard mechanism
Leg finish	PCSG - custom grommet	Fabric desktop / M.P. Glass desktop panel
	RSG - no grommet	Keyboard tray mounting kit

RETURNS W/METAL LEG

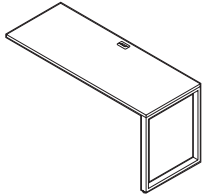

Flush Return with Metal Leg - RIGHT

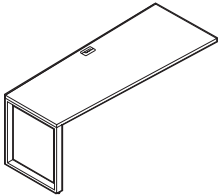

Flush Wedge Return w/Metal Leg - LEFT

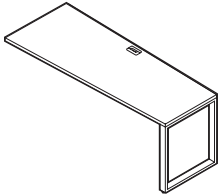

Flush Wedge Return w/Metal Leg - RIGHT

MODEL #	DIMENSIONS W x D x H	WT/LB.	CUBIC FT.	LIST PRICE	HP ADD
PN2448FMR	48 x 24 x 29	59	5.75	\$647	\$98
PN2454FMR	54 x 24 x 29	69	7.75	\$774	\$119
PN2460FMR	60 x 24 x 29	75	8.25	\$813	\$124
PN2466FMR	66 x 24 x 29	80	8.5	\$843	\$128
PN2472FMR	72 x 24 x 29	85	9	\$870	\$133
PN2478FMR	78 x 24 x 29	91	9	\$970	\$148
PN3048FMR	48 x 30 x 29	71	7	\$686	\$104
PN3054FMR	54 x 30 x 29	82	9.25	\$808	\$123
PN3060FMR	60 x 30 x 29	88	9.75	\$844	\$128
PN3066FMR	66 x 30 x 29	94	10.25	\$875	\$133
PN3072FMR	72 x 30 x 29	100	10.75	\$931	\$141
PN3078FMR	78 x 30 x 29	106	10.75	\$1017	\$154

1" x 2" metal frame leg on **right**. Support channel(s) included for units 72"W and above. Connects to freestanding desk with metal legs, freestanding desk with bookshelf and metal leg or 29"H credenza opening. Grommet in worksurface. Shipped easy to assemble in 2 cartons.

PN3048FTL	48 x 30 x 29	62	6	\$674	\$152
PN3054FTL	54 x 30 x 29	75	8.5	\$798	\$122
PN3060FTL	60 x 30 x 29	80	9	\$844	\$128
PN3066FTL	66 x 30 x 29	86	9.5	\$893	\$136
PN3072FTL	72 x 30 x 29	92	10	\$931	\$141

1" x 2" metal frame leg on **left**. Support channel(s) included for 72"W unit only. 30"D has 24" deep leg. 36"D has 30" deep leg. Connects to freestanding desk with metal legs, freestanding desk with bookshelf and metal leg or 29"H credenza opening. Grommet in worksurface. Shipped easy to assemble in 2 cartons.

PN3048FTR	48 x 30 x 29	62	6	\$674	\$152
PN3054FTR	54 x 30 x 29	75	8.5	\$798	\$122
PN3060FTR	60 x 30 x 29	80	9	\$844	\$128
PN3066FTR	66 x 30 x 29	86	9.5	\$893	\$136
PN3072FTR	72 x 30 x 29	92	10	\$931	\$141

1" x 2" metal frame leg on **right**. Support channel(s) included for 72"W unit only. 30"D has 24" deep leg. 36"D has 30" deep leg. Connects to freestanding desk with metal legs, freestanding desk with bookshelf and metal leg or 29"H credenza opening. Grommet in worksurface. Shipped easy to assemble in 2 cartons.

Required specifications

Top finish
Leg finish

Optional specifications

HP laminate
POG1, POG3 (N/A to 48"W)
PCSG - custom grommet
RSG - no grommet

Accessories

Power block
Keyboard tray
Fabric desktop / M.P.
Keyboard tray mounting kit
Wire manager
Keyboard mechanism
Glass desktop panel

OVERLAPPING RETURNS W/METAL LEG **MODEL #** **DIMENSIONS** **WT/LB.** **CUBIC FT.** **LIST PRICE** **HP ADD**

W x D x H

PN2460OML	60 x 24 x 29	74	6.25	\$723	\$110
PN2466OML	66 x 24 x 29	79	6.5	\$744	\$113
PN2472OML	72 x 24 x 29	83	6.75	\$771	\$117
PN2478OML	78 x 24 x 29	88	7	\$918	\$140
PN2484OML	84 x 24 x 29	100	9.75	\$1062	\$162
PN3060OML	60 x 30 x 29	90	7.5	\$756	\$115
PN3066OML	66 x 30 x 29	95	7.75	\$784	\$120
PN3072OML	72 x 30 x 29	100	8	\$829	\$126
PN3078OML	78 x 30 x 29	106	8.5	\$986	\$151
PN3084OML	84 x 30 x 29	120	11.75	\$1101	\$168

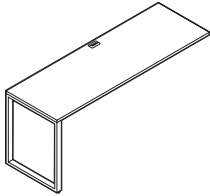

Overlapping Return w/Metal Leg - LEFT*

1" x 2" metal frame leg on **left**. Support channel(s) included for 84"W units only. Overlaps 27"H credenza opening. Grommet in worksurface. Shipped easy to assemble in 2 cartons.

PN2460OMR	60 x 24 x 29	74	6.25	\$723	\$110
PN2466OMR	66 x 24 x 29	79	6.5	\$744	\$113
PN2472OMR	72 x 24 x 29	83	6.75	\$771	\$117
PN2478OMR	78 x 24 x 29	88	7	\$918	\$140
PN2484OMR	84 x 24 x 29	100	9.75	\$1062	\$162
PN3060OMR	60 x 30 x 29	90	7.5	\$756	\$115
PN3066OMR	66 x 30 x 29	95	7.75	\$784	\$120
PN3072OMR	72 x 30 x 29	100	8	\$829	\$126
PN3078OMR	78 x 30 x 29	106	8.5	\$986	\$151
PN3084OMR	84 x 30 x 29	120	11.75	\$1101	\$168

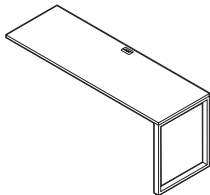

Overlapping Return w/Metal Leg - RIGHT**

1" x 2" metal frame leg on **right**. Support channel(s) included for 84"W units only. Overlaps 27"H credenza opening. Grommet in worksurface. Shipped easy to assemble in 2 cartons.

PN3060OTL	60 x 30 x 29	82	6.75	\$771	\$117
PN3066OTL	66 x 30 x 29	87	7	\$799	\$122
PN3072OTL	72 x 30 x 29	92	7.25	\$837	\$127
PN3078OTL	78 x 30 x 29	97	7.5	\$1002	\$153
PN3084OTL	84 x 30 x 29	111	11	\$1116	\$170

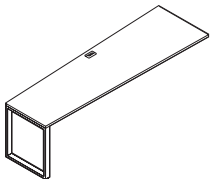

Overlapping Wedge Return w/Metal Leg - LEFT*

1" x 2" metal frame leg on **left**. Support channel(s) included for 84"W unit only. 30"D has 24" deep leg. 36"D has 30" deep leg. Overlaps 27"H credenza opening. Grommet in worksurface. Includes 1" spacer. Shipped easy to assemble in 2 cartons.

PN3060OTR	60 x 30 x 29	82	6.75	\$771	\$117
PN3066OTR	66 x 30 x 29	87	7	\$799	\$122
PN3072OTR	72 x 30 x 29	92	7.25	\$837	\$127
PN3078OTR	78 x 30 x 29	97	7.5	\$1002	\$153
PN3084OTR	84 x 30 x 29	111	11	\$1116	\$170

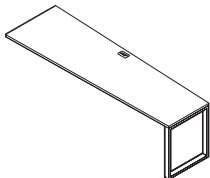

Overlapping Wedge Return w/Metal Leg - RIGHT**

1" x 2" metal frame leg on **right**. Support channel(s) included for 84"W unit only. 30"D has 24" deep leg. 36"D has 30" deep leg. Overlaps 27"H credenza opening. Grommet in worksurface. Includes 1" spacer. Shipped easy to assemble in 2 cartons.

Required specifications

Top finish
Leg finish

Optional specifications

HP laminate RSG - no grommet
POG1*
POG3**
PCSG - custom grommet

Accessories

Power block Wire manager
Keyboard tray Keyboard mechanism
Fabric desktop / M.P. Glass desktop panel
Keyboard tray mounting kit

OVERLAPPING RETURNS W/ METAL LEG

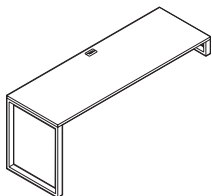

Overlapping Return w/Metal Leg and Spacer for 23”H Credenza - LEFT

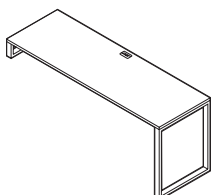

Overlapping Return w/Metal Leg and Spacer for 23”H Credenza - RIGHT

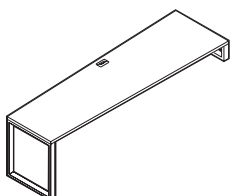

Overlapping Wedge Return w/Metal Leg and Spacer for 23”H Credenza - LEFT

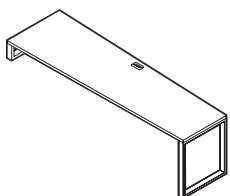

Overlapping Wedge Return w/Metal Leg and Spacer for 23”H Credenza - RIGHT

MODEL #	DIMENSIONS W x D x H	WT/LB.	CUBIC FT.	LIST PRICE	HP ADD
PN2460SOL	60 x 24 x 29	82	16.5	\$1064	\$162
PN2466SOL	66 x 24 x 29	88	17	\$1097	\$168
PN2472SOL	72 x 24 x 29	93	17.25	\$1128	\$173
PN2478SOL	78 x 24 x 29	99	17.25	\$1224	\$186
PN2484SOL	84 x 24 x 29	103	18.25	\$1288	\$196
PN3060SOL	60 x 30 x 29	97	20.25	\$1134	\$173
PN3066SOL	66 x 30 x 29	103	20.75	\$1166	\$177
PN3072SOL	72 x 30 x 29	109	21.25	\$1194	\$181
PN3078SOL	78 x 30 x 29	115	21.75	\$1280	\$195
PN3084SOL	84 x 30 x 29	122	22.25	\$1365	\$208

1” x 2” metal frame leg on **left** and 5” high metal frame spacer on **right**. Support channel(s) included for units 78”W and above. Overlaps 23”H credenza. Grommet in worksurface. Shipped easy to assemble in 3 cartons.

PN2460SOR	60 x 24 x 29	82	16.5	\$1064	\$162
PN2466SOR	66 x 24 x 29	88	17	\$1097	\$168
PN2472SOR	72 x 24 x 29	93	17.25	\$1128	\$173
PN2478SOR	78 x 24 x 29	99	17.25	\$1224	\$186
PN2484SOR	84 x 24 x 29	103	18.25	\$1288	\$196
PN3060SOR	60 x 30 x 29	97	20.25	\$1134	\$173
PN3066SOR	66 x 30 x 29	103	20.75	\$1166	\$177
PN3072SOR	72 x 30 x 29	109	21.25	\$1194	\$181
PN3078SOR	78 x 30 x 29	115	21.75	\$1280	\$195
PN3084SOR	84 x 30 x 29	122	22.25	\$1365	\$208

1” x 2” metal frame leg on **right** and 5” high metal frame spacer on **left**. Support channel(s) included for units 78”W and above. Overlaps 23”H credenza. Grommet in worksurface. Shipped easy to assemble in 3 cartons.

PN3060TSL	60 x 30.25 x 29	95	19.5	\$1111	\$169
PN3066TSL	66 x 30.25 x 29	101	19.75	\$1155	\$176
PN3072TSL	72 x 30.25 x 29	107	20.25	\$1183	\$180
PN3078TSL	78 x 30.25 x 29	112	20.75	\$1269	\$194
PN3084TSL	84 x 30.25 x 29	118	21.25	\$1341	\$204

1” x 2” metal frame leg on **left** and 5” high metal frame spacer on **right**. Support channel(s) included for units 78”W and above. 30”D has 24” deep leg and 30”D spacer. 36”D has 30” deep leg and 36”D spacer. Overlaps 23”H credenza. Grommet in worksurface. Shipped easy to assemble in 3 cartons.

PN3060TSR	60 x 30.25 x 29	95	19.5	\$1111	\$169
PN3066TSR	66 x 30.25 x 29	101	19.75	\$1155	\$176
PN3072TSR	72 x 30.25 x 29	107	20.25	\$1183	\$180
PN3078TSR	78 x 30.25 x 29	112	20.75	\$1269	\$194
PN3084TSR	84 x 30.25 x 29	118	21.25	\$1341	\$204

1” x 2” metal frame leg on **right** and 5” high metal frame spacer on **left**. Support channel(s) included for units 78”W and above. 30”D has 24” deep leg and 30”D spacer. 36”D has 30” deep leg and 36”D spacer. Overlaps 23”H credenza. Grommet in worksurface. Shipped easy to assemble in 3 cartons.

Required specifications

Top finish
Leg finish

Optional specifications

HP laminate
POG1, POG3
PCSG - custom grommet
RSG - no grommet

Accessories

Power block
Keyboard tray
Fabric desktop / M.P.
Keyboard tray mounting kit
Wire manager
Keyboard mechanism
Glass desktop panel

BRIDGES FOR DESKS/RETURNS - METAL LEG **MODEL #** **DIMENSIONS** **WT/LB.** **CUBIC FT.** **LIST PRICE** **HP ADD**

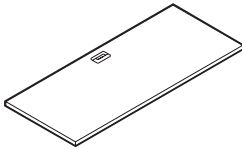

Flush Bridge for Metal Leg Configurations

	W x D x H					
PN2436BFM	36 x 24 x 1	28	1.75	\$327	\$68	
PN2442BFM	42 x 24 x 1	33	2	\$338	\$69	
PN2448BFM	48 x 24 x 1	37	2.25	\$351	\$71	
PN2454BFM	54 x 24 x 1	49	4.25	\$479	\$97	

Connects between any two: freestanding desk with metal legs, freestanding desk with bookshelf and metal leg, conference top for U configurations or 29"H credenza opening. Grommet in worksurface. Shipped easy to assemble in 1 carton.

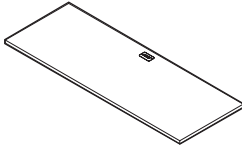

Overlapping Bridge for Metal Leg Configurations - LEFT***

PN2460OBL	60 x 24 x 2	56	4.75	\$422	\$84	
PN2466OBL	66 x 24 x 2	60	5	\$437	\$88	
PN2472OBL	72 x 24 x 2	65	5.5	\$444	\$90	
PN2478OBL	78 x 24 x 2	76	5.5	\$603	\$123	

Connects freestanding desk with metal legs, freestanding desk with bookshelf and metal leg, conference top for U configurations flush on one end, and overlaps 27"H credenza opening on the other end. Includes 1" spacer. Grommet in worksurface. Shipped easy to assemble in 1 carton.

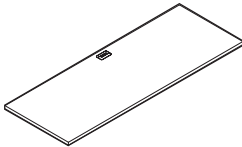

Overlapping Bridge for Metal Leg Configurations - RIGHT**

PN2460OBR	60 x 24 x 2	56	4.75	\$422	\$84	
PN2466OBR	66 x 24 x 2	60	5	\$437	\$88	
PN2472OBR	72 x 24 x 2	65	5.5	\$444	\$90	
PN2478OBR	78 x 24 x 2	76	5.5	\$603	\$123	

Connects freestanding desk with metal legs, freestanding desk with bookshelf and metal leg, conference top for U configurations flush on one end, and overlaps 27"H credenza opening on the other end. Includes 1" spacer. Grommet in worksurface. Shipped easy to assemble in 1 carton.

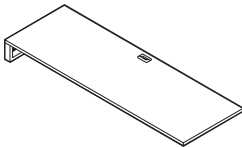

Overlapping Bridge with Metal Spacer for 23"H Credenza - LEFT**

PN2460OSL	60 x 24 x 6	62	5.5	\$756	\$153	
PN2466OSL	66 x 24 x 6	67	6	\$794	\$162	
PN2472OSL	72 x 24 x 6	72	6.5	\$821	\$167	
PN2478OSL	78 x 24 x 6	78	6.5	\$929	\$189	

One 5"H metal frame spacer with support channel(s). Connects flush on **right** side to freestanding desk with metal legs, freestanding desk with bookshelf and metal leg, or conference top for U configurations. Overlaps 23"H credenza opening on the **left**. Grommet in worksurface. Shipped easy to assemble in 2 cartons.

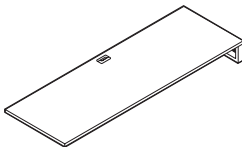

Overlapping Bridge with Metal Spacer for 23"H Credenza - RIGHT**

PN2460OSR	60 x 24 x 6	62	5.5	\$756	\$153	
PN2466OSR	66 x 24 x 6	67	6	\$794	\$162	
PN2472OSR	72 x 24 x 6	72	6.5	\$821	\$167	
PN2478OSR	78 x 24 x 6	78	6.5	\$929	\$189	

One 5"H metal frame spacer with support channel(s). Connects flush on **left** side to freestanding desk with metal legs, freestanding desk with bookshelf and metal leg, or conference top for U configurations. Overlaps 23"H credenza opening on the **right**. Grommet in worksurface. Shipped easy to assemble in 2 cartons.

Required specifications

Top finish
Leg finish (only PN24xxOSL and PN24xxOSR)

Optional specifications

HP laminate PCSG - custom grommet
POG1, POG3* RSG - no grommet
POG1**
POG3***

Accessories

Power block Wire manager
Keyboard tray Keyboard mechanism
Fabric desktop / M.P. Glass desktop panel
Keyboard tray mounting kit

RETURNS WITH BOOKSHELVES

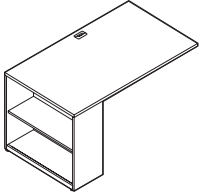

Flush Return with Bookshelf - LEFT

MODEL #	DIMENSIONS W x D x H	WT/LB.	CUBIC FT.	LIST PRICE	HP ADD
PN2460FBL	60 x 24 x 29	93	9.25	\$824	\$126
PN2466FBL	66 x 24 x 29	104	10.25	\$939	\$142
PN2472FBL	72 x 24 x 29	110	13.5	\$967	\$148
PN2478FBL	78 x 24 x 29	116	13.5	\$1028	\$155
PN2484FBL	84 x 24 x 29	120	14.5	\$1085	\$166
PN3060FBL	60 x 30 x 29	111	11.25	\$875	\$133
PN3066FBL	66 x 30 x 29	124	13	\$992	\$152
PN3072FBL	72 x 30 x 29	130	16	\$1025	\$155
PN3078FBL	78 x 30 x 29	136	17.5	\$1098	\$168
PN3084FBL	84 x 30 x 29	142	18	\$1203	\$183

12"D bookcase with adjustable shelf on **left**. With support channel(s). Connects on **right** side to freestanding desk with metal legs or laminate end panels, 29"H freestanding returns or 29"H credenza opening. Laminate shelf is standard. Grommet in worksurface. Shipped easy to assemble in 2 cartons.

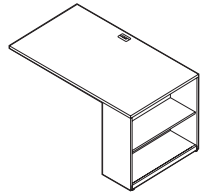

Flush Return with Bookshelf - RIGHT

PN2460FBR	60 x 24 x 29	93	9.25	\$824	\$126
PN2466FBR	66 x 24 x 29	104	10.25	\$939	\$142
PN2472FBR	72 x 24 x 29	110	13.5	\$967	\$148
PN2478FBR	78 x 24 x 29	116	13.5	\$1028	\$155
PN2484FBR	84 x 24 x 29	120	14.5	\$1085	\$166
PN3060FBR	60 x 30 x 29	111	11.25	\$875	\$133
PN3066FBR	66 x 30 x 29	124	13	\$992	\$152
PN3072FBR	72 x 30 x 29	130	16	\$1025	\$155
PN3078FBR	78 x 30 x 29	136	17.5	\$1098	\$168
PN3084FBR	84 x 30 x 29	142	18	\$1203	\$183

12"D bookcase with adjustable shelf on **right**. With support channel(s). Connects on **left** side to freestanding desk with metal legs or laminate end panels, 29"H freestanding returns or 29"H credenza opening. Laminate shelf is standard. Grommet in worksurface. Shipped easy to assemble in 2 cartons.

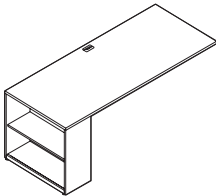

Overlapping Return with Bookshelf - LEFT

PN2484RBL	84 x 24 x 29	118	10.25	\$1069	\$165
PN2490RBL	90 x 24 x 29	131	13.25	\$1188	\$180
PN2496RBL	96 x 24 x 29	136	13.75	\$1251	\$191
PN3084RBL	84 x 30 x 29	145	15.5	\$1112	\$169
PN3090RBL	90 x 30 x 29	156	16	\$1219	\$184
PN3096RBL	96 x 30 x 29	162	16.5	\$1283	\$195

12"D bookcase with adjustable shelf on **left**. With support channel(s). **Right** side overlaps 27"H credenza opening, 27"H freestanding return. Laminate shelf is standard. Grommet in worksurface. Shipped easy to assemble in 2 cartons.

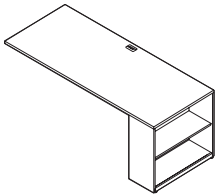

Overlapping Return with Bookshelf - RIGHT

PN2484RBR	84 x 24 x 29	118	10.25	\$1069	\$165
PN2490RBR	90 x 24 x 29	131	13.25	\$1188	\$180
PN2496RBR	96 x 24 x 29	136	13.75	\$1251	\$191
PN3084RBR	84 x 30 x 29	145	15.5	\$1112	\$169
PN3090RBR	90 x 30 x 29	156	16	\$1219	\$184
PN3096RBR	96 x 30 x 29	162	16.5	\$1283	\$195

12"D bookcase with adjustable shelf on **right**. With support channel(s). **Left** side overlaps 27"H credenza opening, 27"H freestanding return. Laminate shelf is standard. Grommet in worksurface. Shipped easy to assemble in 2 cartons.

Required specifications

Top finish
Base finish

Optional specifications

HP laminate
POG1, POG3
PCSG - custom grommet
RSG - no grommet

Accessories

Power block
Keyboard tray
Fabric desktop / M.P.
Keyboard tray mounting kit
Wire manager
Keyboard mechanism
Glass desktop panel

CONFERENCE TOPS - FLUSH **MODEL #** **DIMENSIONS** **WT/LB.** **CUBIC FT.** **LIST PRICE** **HP ADD**

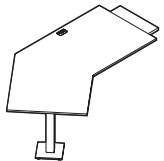

LEFT

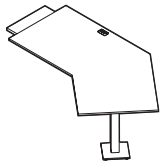

RIGHT

Offset Conference Top, Flush

	W x D x H					
PN3066CFL	66 x 47 x 29	77	7	\$1000	\$138	
PN3072CFL	72 x 47 x 29	83	7.25	\$1012	\$131	

PN3066CFR	66 x 47 x 29	77	7	\$1000	\$138	
PN3072CFR	72 x 47 x 29	83	7.25	\$1012	\$131	

Specify PNxxxxCFL for **left** or PNxxxxCFR for **right**.

Standard with square monopost and base. Connects to freestanding desks with metal legs or laminate end panels, 29"H freestanding returns or 29"H credenza opening. Subtop finish is granite with Black edge. Grommet in worksurface. Shipped easy to assemble in 2 cartons.

Recommended maximum modesty panel size:

PN3066CFR/CFL: 36" wide (PN3613DMF) PN3072CFR/CFL: 42" wide (PN4213DMF)

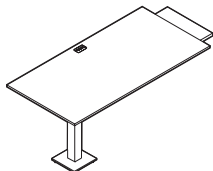

LEFT

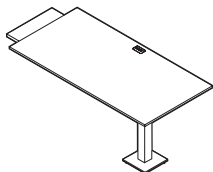

RIGHT

Conference Tops, Flush

PN2448DFL	48 x 24 x 29	51	4	\$712	\$97	
PN3048DFL	48 x 30 x 29	57	4.25	\$759	\$104	
PN3060DFL	60 x 30 x 29	70	5	\$788	\$109	

PN2448DFR	48 x 24 x 29	51	4	\$712	\$97	
PN3048DFR	48 x 30 x 29	57	4.25	\$759	\$104	
PN3060DFR	60 x 30 x 29	70	5	\$788	\$109	

Specify PNxxxxDFL for **left** or PNxxxxDFR for **right**.

Standard with square monopost and base. Connects to freestanding desks with metal legs or laminate end panels, 29"H freestanding returns or 29"H credenza opening. Subtop finish is granite with Black edge. Grommet in worksurface. Shipped easy to assemble in 2 cartons.

Recommended maximum modesty panel size:

PN2448DFR/DFL: 30" wide (PN3013DMF) PN3048DFR/DFL: 30" wide (PN3013DMF)
 PN3060DFR/DFL: 36" wide (PN3613DMF)

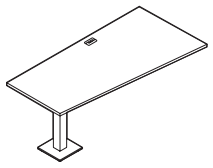

LEFT

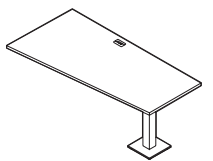

RIGHT

Wedge Shaped Flush Conference Top

PN3048TFL	48 x 30 x 29	56	4.5	\$759	\$104	
PN3060TFL	60 x 30 x 29	66	5	\$788	\$109	

PN3048TFR	48 x 30 x 29	56	4.5	\$759	\$104	
PN3060TFR	60 x 30 x 29	66	5	\$788	\$109	

Specify PNxxxxTFL for **left** or PNxxxxTFR for **right**.

Standard with square monopost and base. 30"D at connecting end, 24"D at monopost end. Connects to freestanding desks with metal legs or laminate end panels, 29"H freestanding returns or 29"H credenza opening. Subtop finish is granite with Black edge. Grommet in worksurface. Shipped easy to assemble in 2 cartons.

Recommended maximum modesty panel size:

PN3048TFR/TFL: 30" wide (PN3013DMF) PN3060TFR/TFL: 36" wide (PN3013DMF)

Required specifications

Top finish
 Leg finish

Optional specifications

HP laminate
 RSG - no grommet
 PCSG - custom grommet

Accessories

Power block Wire manager
 Keyboard tray Keyboard mechanism
 Fabric desktop / M.P. Modesty panel
 Glass desktop panel

CONFERENCE TOPS - OVERLAPPING

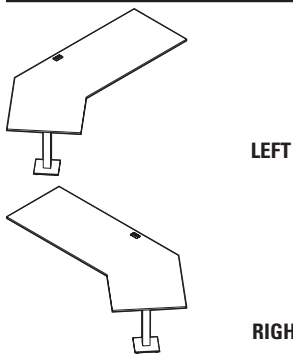

Offset Conference Top, Overlapping

MODEL #	DIMENSIONS W x D x H	WT/LB.	CUBIC FT.	LIST PRICE	HP ADD
PN3090COL	90 x 47 x 29	113	12.75	\$1064	\$128
PN3096COL	96 x 47 x 29	118	13.25	\$1077	\$134
PN3090COR	90 x 47 x 29	113	12.75	\$1064	\$128
PN3096COR	96 x 47 x 29	118	13.25	\$1077	\$134

Specify PNxxxxCOL for **left** or PNxxxxCOR for **right**.

Standard with square monopost and base. Overlaps 27”H credenza opening or 27”H freestanding return. Subtop finish is granite with Black edge. Grommet in worksurface. 1” spacer included. Shipped easy to assemble in 2 cartons.

Recommended maximum modesty panel size:

PN3090COR/COL: 36” wide (PN3613DMF) PN3096COR/COL: 42” wide (PN4213DMF)

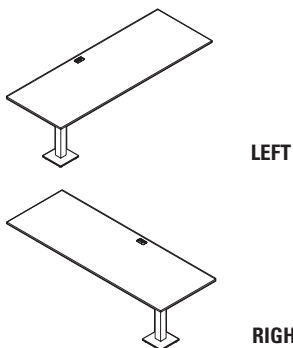

Conference Top, Overlapping

PN3072DOL	72 x 30 x 29	91	5.75	\$916	\$114
PN3078DOL	78 x 30 x 29	97	6	\$935	\$114
PN3084DOL	84 x 30 x 29	102	6.25	\$1002	\$124
PN3072DOR	72 x 30 x 29	91	5.75	\$916	\$114
PN3078DOR	78 x 30 x 29	97	6	\$935	\$114
PN3084DOR	84 x 30 x 29	102	6.25	\$1002	\$124

Specify PNxxxxDOL for **left** or PNxxxxDOR for **right**.

Standard with square monopost and base. Overlaps 27”H credenza opening or 27”H freestanding return. Subtop finish is granite with Black edge. Grommet in worksurface. 1” spacer included. Shipped easy to assemble in 2 cartons.

Recommended maximum modesty panel size:

PN3072DOR/DOL: 30” wide (PN3013DMF) PN3078DOR/DOL: 30” wide (PN3013DMF)
PN3084DOR/DOL: 36” wide (PN3613DMF)

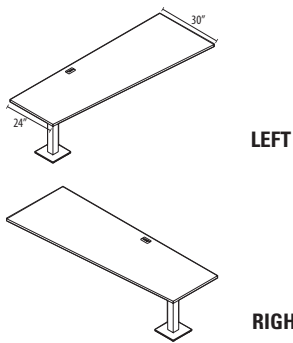

Wedge Shaped Overlapping Conference Top

PN3072TOL	72 x 30 x 29	86	5.75	\$916	\$126
PN3084TOL	84 x 30 x 29	96	6.25	\$1002	\$138
PN3072TOR	72 x 30 x 29	86	5.75	\$916	\$126
PN3084TOR	84 x 30 x 29	96	6.25	\$1002	\$138

Specify PNxxxxDOL for **left** or PNxxxxDOR for **right**.

Standard with square monopost and base. 30”D at overlapping end, 24”D at monopost end. Overlaps 27”H credenza opening or 27”H freestanding return. Grommet in worksurface. 1” spacer included. Shipped easy to assemble in 2 cartons.

Recommended maximum modesty panel size:

PN3072TOR/TOL: 30” wide (PN3013DMF)PN3084TOR/TOL: 36” wide (PN3613DMF)

Required specifications

Top finish
Leg finish

Optional specifications

HP laminate
RSG - no grommet
PCSG - custom grommet

Accessories

Power block
Keyboard tray
Fabric desktop / M.P.
Glass desktop panel
Wire manager
Keyboard mechanism
Modesty panel

CONFERENCE TOPS - OVERLAPPING **MODEL #** **DIMENSIONS** **WT/LB.** **CUBIC FT.** **LIST PRICE** **HP ADD**

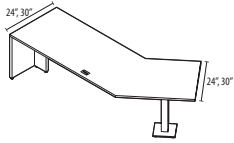

LEFT

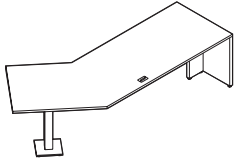

RIGHT

Offset Conference Top for U Configurations

à

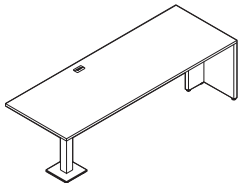

LEFT

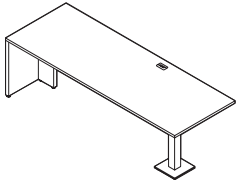

RIGHT

Conference Top for U Configurations

	W x D x H					
PN3090CUL	90 x 47 x 29	148	12.75	\$1267	\$174	
PN3096CUL	96 x 47 x 29	154	13.25	\$1282	\$176	
PN3090CUR	90 x 47 x 29	148	12.75	\$1267	\$174	
PN3096CUR	96 x 47 x 29	154	13.25	\$1282	\$176	

Specify PNxxxxCUL for **left** or PNxxxxCUR for **right**.

Standard with T base with square monopost and base. End panel is 1" thick. 1.5" thick support gable extends 12" for end panel. **Not freestanding, must be connected.** Connects to bridges. Grommet in worksurface. Shipped easy to assemble in 2 cartons.

Recommended maximum modesty panel size:

PN3090CUR/CUL: 60" wide (PN6013DMF) PN3096CUR/CUL: 66" wide (PN6613DMF)

PN3072DUL	72 x 30 x 29	130	8.25	\$1077	\$148	
PN3084DUL	84 x 30 x 29	141	9.25	\$1264	\$174	
PN3072DUR	72 x 30 x 29	130	8.25	\$1077	\$148	
PN3084DUR	84 x 30 x 29	141	9.25	\$1264	\$174	

Specify PNxxxxDUL for **left** or PNxxxxDUR for **right**.

Standard with T base with square monopost and base. End panel is 1" thick. 1.5" thick support gable extends 12" for end panel. **Not freestanding, must be connected.** Connects to bridges. Grommet in worksurface. Shipped easy to assemble in 2 cartons.

Recommended maximum modesty panel size:

PN3072DUR/DUL: 48" wide (PN4813DMF) PN3084DUR/DUL: 60" wide (PN6013DMF)

Required specifications

Top finish
Leg finish

Optional specifications

HP laminate
RSG - no grommet
PCSG - custom grommet

Accessories

Power block Wire manager
Keyboard tray Keyboard mechanism
Fabric desktop / M.P. Modesty panel
Glass desktop panel

DESKTOP AND MODESTY PANELS

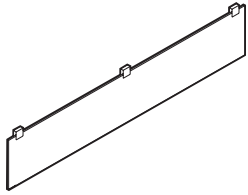

Fabric Desktop/Modesty Panel*

MODEL #	DIMENSIONS W x D x H	WT/LB.	CUBIC FT.	GR. 2	GR. 3
PN3013DMF	30 x 0.37 x 13	3	1	\$440	\$467
PN3613DMF	36 x 0.37 x 13	3.6	1	\$466	\$500
PN4213DMF	42 x 0.37 x 13	4.2	1	\$493	\$527
PN4813DMF	48 x 0.37 x 13	4.8	1.5	\$502	\$543
PN5413DMF	54 x 0.37 x 13	5.4	1.5	\$526	\$573
PN6013DMF	60 x 0.37 x 13	6	1.5	\$561	\$608
PN6613DMF	66 x 0.37 x 13	6.6	1.5	\$665	\$719
PN7213DMF	72 x 0.37 x 13	7.2	1.75	\$709	\$770
PN7813DMF	78 x 0.37 x 13	7.8	1.75	\$715	\$783

Panels up to 54"W have two clamps. Panels 60" and wider have three clamps. **When used as a modesty panel, specify a nominal size 6" shorter than worksurface size.** Non-tackable.

LIST PRICE

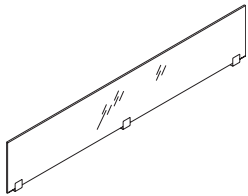

Glass Desktop Panel

PN3013DG	30 x 0.25 x 13	14	0.5	\$360
PN3613DG	36 x 0.25 x 13	16	0.5	\$376
PN4213DG	42 x 0.25 x 13	19	0.75	\$408
PN4813DG	48 x 0.25 x 13	21	0.75	\$424
PN5413DG	54 x 0.25 x 13	24	0.75	\$476
PN6013DG	60 x 0.25 x 13	26	1	\$559
PN6613DG	66 x 0.25 x 13	29	1	\$578
PN7213DG	72 x 0.25 x 13	31	1	\$594

Panels up to 54"W have two clamps. Panels 60" and wider have three clamps. **Cannot be used as a modesty panel.** There are no specifications for Glass Desktop Panel.

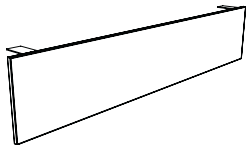

Laminate Desktop/Modesty Panel

PN3013DML	30 x 0.69 x 13	11	0.5	\$346
PN3613DML	36 x 0.69 x 13	13	0.5	\$375
PN4213DML	42 x 0.69 x 13	14	0.5	\$401
PN4813DML	48 x 0.69 x 13	16	0.75	\$419
PN5413DML	54 x 0.69 x 13	18	0.75	\$468
PN6013DML	60 x 0.69 x 13	19	0.75	\$552
PN6613DML	66 x 0.69 x 13	21	1	\$570
PN7213DML	72 x 0.69 x 13	23	1	\$587
PN7813DML	78 x 0.69 x 13	24	1	\$692
PN8413DML	84 x 0.69 x 13	26	1	\$855

Attaches to worksurface with "L" brackets. Panels up to 54"W have two brackets. Panels 60" and wider have three brackets. **When used as a modesty panel, specify a nominal size 6" shorter than worksurface size.** If using modesty with overlapping worksurface or lower storage, contact Customer Service.

Required specifications

Fabric*

PET DESKTOP AND MODESTY PANELS

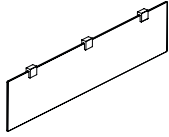

PET Felt Desktop/Modesty Panel, 1 pk.

MODEL #	DIMENSIONS W x D x H	WT/LB.	CUBIC FT.	LIST PRICE
PN3013PT9-1	30 x 0.36 x 12.5	2.48	0.6	\$190
PN3613PT9-1	36 x 0.36 x 12.5	2.74	0.7	\$200
PN4213PT9-1	42 x 0.36 x 12.5	2.99	0.8	\$273
PN4813PT9-1	48 x 0.36 x 12.5	3.85	0.9	\$283
PN5413PT9-1	54 x 0.36 x 12.5	4.11	1	\$346
PN6013PT9-1	60 x 0.36 x 12.5	4.36	1.1	\$356
PN6613PT9-1	66 x 0.36 x 12.5	5.22	1.3	\$427
PN7213PT9-1	72 x 0.36 x 12.5	5.48	1.4	\$437
PN7813PT9-1	78 x 0.36 x 12.5	5.73	1.5	\$445

PET Felt Desktop/Modesty Panel available in three finishes, please specify finish. 2, 3 or 4 clamps are included depending on width. Clamps available in satin anodized finish only. **When used as a modesty panel, specify a nominal size 6" shorter than worksurface size.**

- Up to 42" w - 2 clamps per
- 48"-60" w - 3 clamps per
- 66"-78" w - 4 clamps per

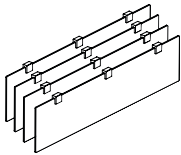

PET Felt Desktop/Modesty Panel, 4 pk.

PN3013PT9-4	30 x 0.36 x 12.5	8.9	0.6	\$732
PN3613PT9-4	36 x 0.36 x 12.5	9.9	0.7	\$769
PN4213PT9-4	42 x 0.36 x 12.5	10.8	0.8	\$1053
PN4813PT9-4	48 x 0.36 x 12.5	13.9	1	\$1090
PN5413PT9-4	54 x 0.36 x 12.5	14.8	1.1	\$1334
PN6013PT9-4	60 x 0.36 x 12.5	15.7	1.2	\$1366
PN6613PT9-4	66 x 0.36 x 12.5	18.8	1.3	\$1649
PN7213PT9-4	72 x 0.36 x 12.5	19.7	1.4	\$1682
PN7813PT9-4	78 x 0.36 x 12.5	20.6	1.5	\$1713

Pack of four PET Felt Desktop/Modesty Panels available in three finishes, please specify finish. 2, 3 or 4 clamps are included depending on width. Clamps available in satin anodized finish only. **When used as a modesty panel, specify a nominal size 6" shorter than worksurface size.**

- Up to 42" w - 2 clamps per
- 48"-60" w - 3 clamps per
- 66"-78" w - 4 clamps per

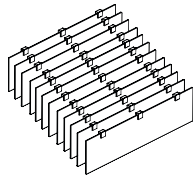

PET Felt Desktop/Modesty Panel, 12 pk.

PN3013PT9-12	30 x 0.36 x 12.5	25.3	1.9	\$2159
PN3613PT9-12	36 x 0.36 x 12.5	27.9	2.3	\$2262
PN4213PT9-12	42 x 0.36 x 12.5	30.5	2.6	\$3102
PN4813PT9-12	48 x 0.36 x 12.5	39.3	3	\$3202
PN5413PT9-12	54 x 0.36 x 12.5	41.9	3.4	\$3930
PN6013PT9-12	60 x 0.36 x 12.5	44.5	3.7	\$4017
PN6613PT9-12	66 x 0.36 x 12.5	53.2	4.2	\$4859
PN7213PT9-12	72 x 0.36 x 12.5	55.9	4.5	\$4947
PN7813PT9-12	78 x 0.36 x 12.5	58.5	4.9	\$5036

Pack of twelve PET Felt Desktop/Modesty Panels available in three finishes, please specify finish. 2, 3 or 4 clamps are included depending on width. Clamps available in satin anodized finish only. **When used as a modesty panel, specify a nominal size 6" shorter than worksurface size.**

- Up to 42" w - 2 clamps per
- 48"-60" w - 3 clamps per
- 66"-78" w - 4 clamps per

Required specifications

Fabric*

29" H CREDENZAS

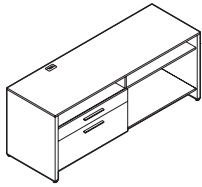

29" H Credenza - LEFT

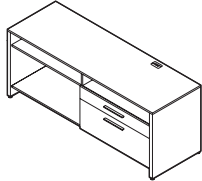

29" H Credenza - RIGHT

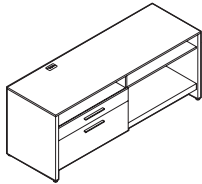

29" H Credenza w/Pull-Out Equipment Tray - LEFT

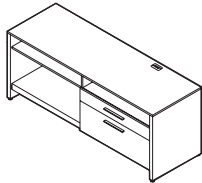

29" H Credenza w/Pull-Out Equipment Tray - RIGHT

MODEL #	DIMENSIONS W x D x H	WT/LB.	CUBIC FT.	LIST PRICE	HP ADD
PN2984CRL	84 x 24 x 29	329	43	\$1794	\$211
PN2978CRL	78 x 24 x 29	313	38.25	\$1751	\$211
PN2972CRL	72 x 24 x 29	298	35.6	\$1703	\$209
PN2966CRL	66 x 24 x 29	285	32.75	\$1682	\$208
PN2960CRL	60 x 24 x 29	269	29.8	\$1655	\$196

Standard with locking 34"W box and lateral file drawer on **left**. File bars included for front-to-back letter/legal filing capability. Lock on file drawer secures both drawers. Adjustable 6 position shelf. Wire management grommet on surface and internal pass-through behind equipment shelf. Connects to flush returns, flush bridges and flush conference tops. Shipped assembled in 1 carton.

PN2984CRR	84 x 24 x 29	329	43	\$1794	\$211
PN2978CRR	78 x 24 x 29	313	38.25	\$1751	\$211
PN2972CRR	72 x 24 x 29	298	35.6	\$1703	\$209
PN2966CRR	66 x 24 x 29	285	32.75	\$1682	\$208
PN2960CRR	60 x 24 x 29	269	29.8	\$1655	\$196

Standard with locking 34"W box and lateral file drawer on **right**. File bars included for front-to-back letter/legal filing capability. Lock on file drawer secures both drawers. Adjustable 6 position shelf. Wire management grommet on surface and internal pass-through behind equipment shelf. Connects to flush returns, flush bridges and flush conference tops. Shipped assembled in 1 carton.

PN2984CPL	84 x 24 x 29	354	43	\$2025	\$226
PN2978CPL	78 x 24 x 29	336	38.25	\$1970	\$224
PN2972CPL	72 x 24 x 29	318	35.6	\$1923	\$223
PN2966CPL	66 x 24 x 29	301	32.75	\$1850	\$218
PN2960CPL	60 x 24 x 29	282	29.8	\$1801	\$205

Standard with locking 34"W box and lateral file drawer on **left**. File bars included for front-to-back letter/legal filing capability. Lock on file drawer secures both drawers. Adjustable 6 position shelf. Pull-out equipment shelf can support up to 80 lbs. Wire management grommet on surface and internal pass-through behind equipment shelf. Connects to flush returns, flush bridges and flush conference tops. Shipped assembled in 1 carton.

PN2984CPR	84 x 24 x 29	354	43	\$2025	\$226
PN2978CPR	78 x 24 x 29	336	38.25	\$1970	\$224
PN2972CPR	72 x 24 x 29	318	35.6	\$1923	\$223
PN2966CPR	66 x 24 x 29	301	32.75	\$1850	\$218
PN2960CPR	60 x 24 x 29	282	29.8	\$1801	\$205

Standard with locking 34"W box and lateral file drawer on **right**. File bars included for front-to-back letter/legal filing capability. Lock on file drawer secures both drawers. Adjustable 6 position shelf. Pull-out equipment shelf can support up to 80 lbs. Wire management grommet on surface and internal pass-through behind equipment shelf. Connects to flush returns, flush bridges and flush conference tops. Shipped assembled in 1 carton.

Required specifications

Top finish
Base finish
Drawer front finish

Optional specifications

RSG - no grommet
HP laminate

29" H CREDENZAS **MODEL #** **DIMENSIONS** **WT/LB.** **CUBIC FT.** **LIST PRICE** **HP ADD**

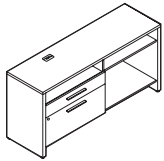

LEFT

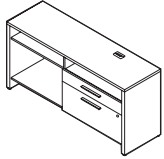

RIGHT

29" H Narrow Credenza*

		W x D x H					
PN2954NCL	54 x 20 x 29	227	22.7	\$1641	\$224		
PN2960NCL	60 x 20 x 29	239	25.5	\$1661	\$229		

PN2954NCR	54 x 20 x 29	227	22.7	\$1641	\$224		
PN2960NCR	60 x 20 x 29	239	25.5	\$1661	\$229		

Specify PNxxxxNCL for **left** or PNxxxxNCR for **right**.

20" deep. Standard with 30"W box and lateral file drawer. Front-to-back letter/legal filing capability. Lock on file drawer secures both drawers. Adjustable 6 position shelf. Wire management grommet on surface and internal pass-through behind lower shelf. Connects to flush returns, flush bridges and flush conference tops. File bars included. Shipped assembled in 1 carton.

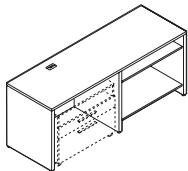

LEFT

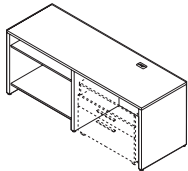

RIGHT

29" H Credenza for Mobile Lateral File

PN2972MCL	72 x 24 x 29	218	35.6	\$1340	\$183		
PN2984MCL	84 x 24 x 29	248	43	\$1447	\$197		

PN2972MCR	72 x 24 x 29	218	35.6	\$1340	\$183		
PN2984MCR	84 x 24 x 29	248	43	\$1447	\$197		

Specify PNxxxxMCL for **left** or PNxxxxMCR for **right**.

Standard with 42"W space for lateral file. Adjustable 6 position shelf. Wire management grommet on surface and internal pass-through behind lower shelf. Connects to flush returns, flush bridges and flush conference tops. Accepts all mobile lateral file units. Shipped assembled in 1 carton.

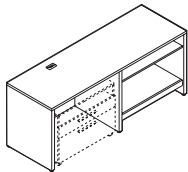

LEFT

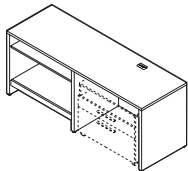

RIGHT

29" H Credenza for Mobile Lateral File w/Pull-Out Equipment Tray

PN2972MPL	72 x 24 x 29	235	35.6	\$1534	\$210		
PN2984MPL	84 x 24 x 29	270	43	\$1634	\$224		

PN2972MPR	72 x 24 x 29	235	35.6	\$1534	\$210		
PN2984MPR	84 x 24 x 29	270	43	\$1634	\$224		

Specify PNxxxxMPL for **left** or PNxxxxMPR for **right**.

Standard with 42"W space for lateral file, adjustable 6 position shelf, and pull-out equipment shelf that can support up to 80 lbs. Grommet in worksurface and internal pass-through behind equipment shelf. Connects to flush returns, flush bridges and flush conference tops. Accepts all mobile lateral file units. Shipped assembled in 1 carton.

Required specifications

- Top finish
- Base finish
- Drawer front finish*

Optional specifications

- HP laminate
- RSG - no grommet

29" H CREDENZAS	MODEL #	DIMENSIONS	WT/LB.	CUBIC FT.	LIST PRICE	HP ADD
-----------------	---------	------------	--------	-----------	------------	--------

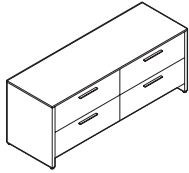

29" H Lateral File Credenza

	W x D x H					
PN2972LF	72 x 24 x 29	315	35.6	\$2023	\$269	

Standard with four lateral file drawers. File bars included for front-to-back letter/legal filing capability. Lock on lower drawer secures both drawers. Anti-tip mechanism. Shipped assembled in 1 carton.

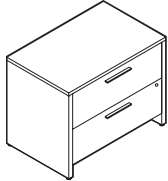

29" H Single Lateral File Credenza

PN2937LFS	37 x 24 x 29	199	19	\$1369	\$189	
-----------	--------------	-----	----	---------------	--------------	--

Standard with two lateral file drawers. File bars included for front-to-back letter/legal filing capability. Lock on lower drawer secures both drawers. Anti-tip mechanism. Shipped assembled in 1 carton.

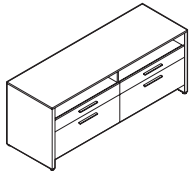

29" H Double Credenza

PN2972CRD	72 x 24 x 29	357	36.5	\$1948	\$244	
-----------	--------------	-----	------	---------------	--------------	--

Standard with 34" W box and lateral file drawer on each side. File bars included for front-to-back letter/legal filing capability. Lock on file drawer secures both drawers. Shipped assembled in 1 carton.

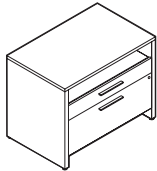

29" H Single Credenza

PN2937CRS	37 x 24 x 29	200	19	\$1370	\$189	
-----------	--------------	-----	----	---------------	--------------	--

Standard with 34" W box and lateral file drawer. File bars included for front-to-back letter/legal filing capability. Lock on file drawer secures both drawers. Shipped assembled in 1 carton.

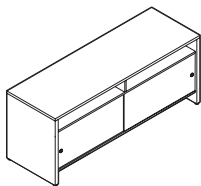

29" H Credenza w/Sliding Laminate Doors

PN2960CLS	60 x 24 x 29	229	29.8	\$1589	\$218	
PN2972CLS	72 x 24 x 29	263	35.6	\$1665	\$229	
PN2984CLS	84 x 24 x 29	297	43	\$1817	\$248	

Standard with sliding laminate doors in upper plastic track. Recessed brushed aluminum finger pulls. No lock. Shipped assembled in 1 carton.

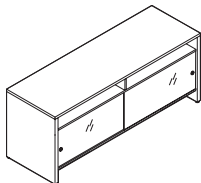

29" H Credenza w/Sliding Glass Doors

PN2960CGS	60 x 24 x 29	235.5	31.2	\$2003	\$274	
PN2972CGS	72 x 24 x 29	270.5	37.3	\$2218	\$303	
PN2984CGS	84 x 24 x 29	306	45	\$2451	\$335	

Standard with sliding glass doors in upper aluminum track. Acid etched 6mm glass. Brushed aluminum finger pulls. No lock. Shipped assembled in 2 cartons (glass doors shipped separately).

Required specifications

- Top finish
- Base finish
- Drawer front finish
- Door finish (only PN29xxCLS)

Optional specifications

- HP laminate

29"H CREDENZAS

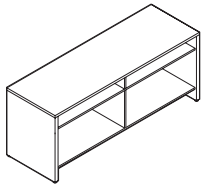

29"H Open Credenza

MODEL #	DIMENSIONS W x D x H	WT/LB.	CUBIC FT.	LIST PRICE	HP ADD
PN2960CO	60 x 24 x 29	210	29.8	\$1334	\$183
PN2972CO	72 x 24 x 29	241	35.6	\$1413	\$194
PN2984CO	84 x 24 x 29	272	43	\$1569	\$215

Open storage with adjustable 6 position upper shelves with pass-throughs at back of lower shelves. Connects to flush returns, flush bridges and flush conference tops. Shipped assembled in 1 carton

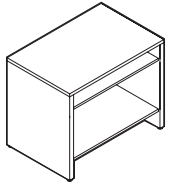

29"H Single Open Credenza

PN2930CO	30 x 24 x 29	126	15	\$857	\$117
PN2936CO	36 x 24 x 29	141	18.5	\$897	\$123

Open storage with adjustable 6 position upper shelf with pass-through at back of lower shelf. Connects to flush returns, flush bridges and flush conference tops. Shipped assembled in 1 carton.

27"H CREDENZAS

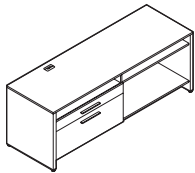

27"H Credenza - LEFT

PN2760CRL	60 x 24 x 27	269	28	\$1642	\$191
PN2766CRL	66 x 24 x 27	285	32.75	\$1667	\$196
PN2772CRL	72 x 24 x 27	298	33.5	\$1682	\$202
PN2778CRL	78 x 24 x 27	313	38.25	\$1733	\$205
PN2784CRL	84 x 24 x 27	322	36	\$1776	\$208

Standard with locking 34"W box and lateral file drawer on **left**. File bars included for front-to-back letter/legal filing capability. Lock on file drawer secures both drawers. Adjustable 6 position shelf. Wire management grommet on surface and internal pass-through behind equipment shelf. Supports overlapping returns, bridges and conference tops that have a 1" spacer (example: PN24600MR). Cannot nest under 29"H products with metal legs. Shipped assembled in 1 carton.

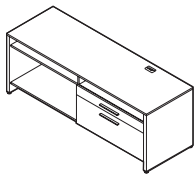

27"H Credenza - RIGHT

PN2760CRR	60 x 24 x 27	269	28	\$1642	\$191
PN2766CRR	66 x 24 x 27	285	32.75	\$1667	\$196
PN2772CRR	72 x 24 x 27	298	33.5	\$1682	\$202
PN2778CRR	78 x 24 x 27	313	38.25	\$1733	\$205
PN2784CRR	84 x 24 x 27	322	36	\$1776	\$208

Standard with locking 34"W box and lateral file drawer on **right**. File bars included for front-to-back letter/legal filing capability. Lock on file drawer secures both drawers. Adjustable 6 position shelf. Wire management grommet on surface and internal pass-through behind equipment shelf. Supports overlapping returns, bridges and conference tops that have a 1" spacer (example: PN24600MR). Cannot nest under 29"H products with metal legs. Shipped assembled in 1 carton.

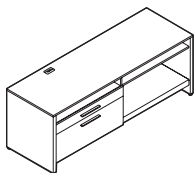

27"H Credenza w/Pull-Out Equipment Tray - LEFT

PN2760CPL	60 x 24 x 27	275	28	\$1788	\$197
PN2766CPL	66 x 24 x 27	295	32.75	\$1834	\$209
PN2772CPL	72 x 24 x 27	311	33.5	\$1907	\$214
PN2778CPL	78 x 24 x 27	328	38.25	\$1955	\$219
PN2784CPL	84 x 24 x 27	347	36	\$2010	\$226

Standard with locking 34"W box and lateral file drawer on **left**. File bars included for front-to-back letter/legal filing capability. Lock on file drawer secures both drawers. Adjustable 6 position shelf. Pull-out equipment tray can support up to 80 lbs. Wire management grommet on surface and internal pass-through behind equipment shelf. Supports overlapping returns, bridges and conference tops that have a 1" spacer (example: PN24600MR). Cannot nest under 29"H products with metal legs. Shipped assembled in 1 carton.

Required specifications

Top finish
Base finish

Optional specifications

HP laminate

27" H CREDENZAS

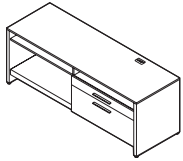

27" H Credenza w/Pull-Out Equipment Tray - RIGHT

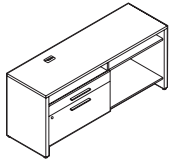

LEFT

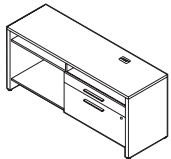

RIGHT

27" H Narrow Credenza*

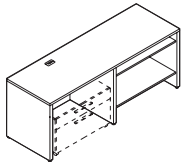

LEFT

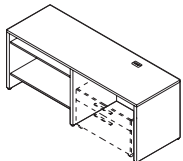

RIGHT

27" H Credenza for Mobile Lateral File

MODEL #	DIMENSIONS W x D x H	WT/LB.	CUBIC FT.	LIST PRICE	HP ADD
PN2760CPR	60 x 24 x 27	275	28	\$1788	\$197
PN2766CPR	66 x 24 x 27	295	32.75	\$1834	\$209
PN2772CPR	72 x 24 x 27	311	33.5	\$1907	\$214
PN2778CPR	78 x 24 x 27	328	38.25	\$1955	\$219
PN2784CPR	84 x 24 x 27	347	36	\$2010	\$226

Standard with locking 34"W box and lateral file drawer on **right**. File bars included for front-to-back letter/legal filing capability. Lock on file drawer secures both drawers. Adjustable 6 position shelf. Pull-out equipment tray can support up to 80 lbs. Wire management grommet on surface and internal pass-through behind equipment shelf. Supports overlapping returns, bridges and conference tops that have a 1" spacer (example: PN2460OMR). Cannot nest under 29"H products with metal legs. Shipped assembled in 1 carton.

PN2754NCL	54 x 20 x 27	218	21.5	\$1596	\$218
PN2760NCL	60 x 20 x 27	232	23.5	\$1617	\$222
PN2754NCR	54 x 20 x 27	218	21.5	\$1596	\$218
PN2760NCR	60 x 20 x 27	232	23.5	\$1617	\$222

Specify PNxxxxNCL for **left** or PNxxxxNCR for **right**.

20" deep. Standard with 30"W box and lateral file drawer. Front-to-back letter/legal filing capability. Lock on file drawer secures both drawers. Adjustable 6 position shelf. Wire management grommet on surface and internal pass-through at back of lower shelf. Supports overlapping returns, bridges and conference tops that have a 1" spacer (example: PN2460OMR). Cannot nest under 29"H products with metal legs. File bars included. Shipped assembled in 1 carton.

PN2772MCL	72 x 24 x 27	210	33.5	\$1325	\$181
PN2784MCL	84 x 24 x 27	228	36	\$1428	\$196
PN2772MCR	72 x 24 x 27	210	33.5	\$1325	\$181
PN2784MCR	84 x 24 x 27	228	36	\$1428	\$196

Specify PNxxxxMCL for **left** or PNxxxxMCR for **right**.

Standard with 42"W space for lateral file. Adjustable 6 position shelf. Wire management grommet on surface and internal pass-through at back of lower shelf. Supports overlapping returns, bridges and conference tops that have a 1" spacer (example: PN2460OMR). Cannot nest under 29"H products with metal legs. Accepts mobile lateral file unit: PN22MLBF with and without cushions, and PN25MLSFBF without cushions. Shipped assembled in 1 carton.

Required specifications

Top finish
Base finish
Drawer front finish*

Optional specifications

HP laminate
RSG - no grommet

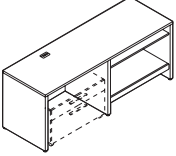
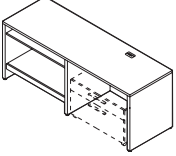
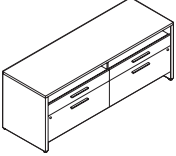
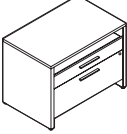
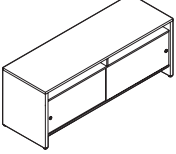
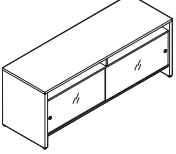
27" H CREDENZAS		MODEL #	DIMENSIONS	WT/LB.	CUBIC FT.	LIST PRICE	HP ADD
		W x D x H					
	LEFT	PN2772MPL	72 x 24 x 27	240	33.5	\$1519	\$208
		PN2784MPL	84 x 24 x 27	263	36	\$1617	\$222
	RIGHT	PN2772MPR	72 x 24 x 27	240	33.5	\$1519	\$208
		PN2784MPR	84 x 24 x 27	263	36	\$1617	\$222
27" H Credenza for Mobile Lateral File w/Pull-Out Equipment Tray		Standard with 42"W space for lateral file, adjustable 6 position shelf, and pull-out equipment shelf that can support up to 80 lbs. Wire management grommet in surface and internal pass-through at back of pull-out equipment shelf. Supports overlapping returns, bridges and conference tops that have a 1" spacer (example: PN2460OMR). Cannot nest under 29"H products with metal legs. Accepts mobile lateral file unit: PN22MLBF with and without cushions, and PN25MLSFB <u>without cushions</u> . Shipped assembled in 1 carton.					
	27" H Double Credenza	PN2772CRD	72 x 24 x 27	351	33.5	\$1911	\$244
		Standard with locking 34"W box and lateral file drawer on each side. File bars included for front-to-back letter/legal filing capability. Lock on file drawer secures both drawers. Shipped assembled in 1 carton.					
	27" H Single Credenza	PN2737CRS	37 x 24 x 27	196	17.75	\$1332	\$181
		Standard with 34"W box and lateral file drawer. Lock on file drawer secures both drawers. File bars included for front-to-back letter/legal filing capability. Shipped assembled in 1 carton.					
	27" H Credenza w/Sliding Laminate Doors	PN2760CLS	60 x 24 x 27	222	28	\$1571	\$215
		PN2772CLS	72 x 24 x 27	256	33.5	\$1649	\$226
		PN2784CLS	84 x 24 x 27	289	36	\$1799	\$247
Standard with sliding laminate doors in upper plastic track. Recessed brushed aluminum finger pulls. No lock. Shipped assembled in 1 carton.							
	27" H Credenza w/Sliding Glass Doors	PN2760CGS	60 x 24 x 27	227.5	29.4	\$1988	\$271
		PN2772CGS	72 x 24 x 27	264	35.2	\$2211	\$303
		PN2784CGS	84 x 24 x 27	298	38	\$2432	\$333
Standard with sliding glass doors in upper aluminum track. Acid etched 6mm glass. Brushed aluminum finger pulls. No lock. Shipped assembled in 2 cartons (glass doors shipped separately).							

Required specifications

- Top finish
- Base finish
- Drawer front finish*
- Door finish**

Optional specifications

- HP laminate
- RSG - no grommet

27"H CRENZAS

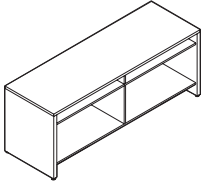

27"H Open Credenza

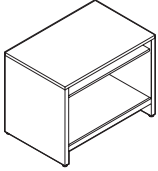

27"H Single Open Credenza

MODEL #	DIMENSIONS W x D x H	WT/LB.	CUBIC FT.	LIST PRICE	HP ADD
PN2760CO	60 x 24 x 27	203	28	\$1334	\$183
PN2772CO	72 x 24 x 27	232	33.5	\$1413	\$194
PN2784CO	84 x 24 x 27	261	36	\$1569	\$215

Open storage with adjustable 6 position upper shelves with pass-throughs at back of lower shelves. Supports overlapping returns, bridges and conference tops that have a 1" spacer (example: PN24600MR). Cannot nest under 29"H products with metal legs. Shipped assembled in 1 carton.

PN2730CO	30 x 24 x 27	121	15.5	\$842	\$115
PN2736CO	36 x 24 x 27	135	17.5	\$881	\$122

Open storage with adjustable 6 position upper shelf with pass-through at back of lower shelf. Supports overlapping returns, bridges and conference tops that have a 1" spacer (example: PN24600MR). Cannot nest under 29"H products with metal legs. Shipped assembled in 1 carton.

23"H CRENZAS

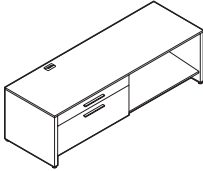

LEFT

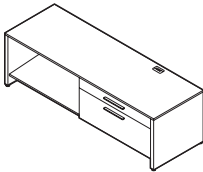

RIGHT

23"H Credenza*

PN2360CRL	60 x 24 x 23	224	24.25	\$1368	\$175
PN2366CRL	66 x 24 x 23	237	26.5	\$1398	\$179
PN2372CRL	72 x 24 x 23	247	28.75	\$1421	\$181
PN2378CRL	78 x 24 x 23	260	31.25	\$1452	\$184
PN2384CRL	84 x 24 x 23	271	34.5	\$1480	\$190

PN2360CRR	60 x 24 x 23	224	24.25	\$1368	\$175
PN2366CRR	66 x 24 x 23	237	26.5	\$1398	\$179
PN2372CRR	72 x 24 x 23	247	28.75	\$1421	\$181
PN2378CRR	78 x 24 x 23	260	31.25	\$1452	\$184
PN2384CRR	84 x 24 x 23	271	34.5	\$1480	\$190

Specify PNxxxxCRL for **left** or PNxxxxCRR for **right**.

Standard with 34"W box and lateral file drawer. File bars included for front-to-back letter/legal filing capability. Lock on file drawer secures both drawers. Wire management grommet as shown on surface and internal pass-through at back of lower shelf. Supports overlapping returns with metal leg and spacer for 23"H credenza, overlapping tapered return with metal leg and spacer for 23"H credenza, and overlapping bridges with metal spacer for 23"H credenza. Shipped assembled in 1 carton.

Required specifications

Top finish
Base finish
Drawer front finish*

Optional specifications

RSG - no grommet*
HP laminate

Accessories

Cushion*

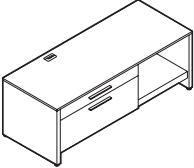
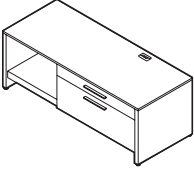
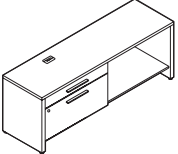
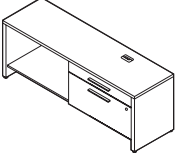
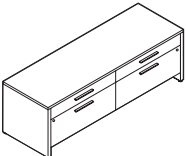
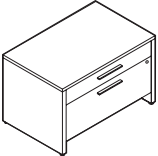
23"H CREDENZAS		MODEL #	DIMENSIONS	WT/LB.	CUBIC FT.	LIST PRICE	HP ADD
		W x D x H					
	LEFT	PN2360CPL	60 x 24 x 23	237	24.25	\$1550	\$184
		PN2366CPL	66 x 24 x 23	253	26.5	\$1600	\$193
		PN2372CPL	72 x 24 x 23	267	28.75	\$1654	\$193
		PN2378CPL	78 x 24 x 23	282	31.25	\$1692	\$196
		PN2384CPL	84 x 24 x 23	296	34.5	\$1724	\$200
	RIGHT	PN2360CPR	60 x 24 x 23	237	24.25	\$1550	\$184
		PN2366CPR	66 x 24 x 23	253	26.5	\$1600	\$193
		PN2372CPR	72 x 24 x 23	267	28.75	\$1654	\$193
		PN2378CPR	78 x 24 x 23	282	31.25	\$1692	\$196
		PN2384CPR	84 x 24 x 23	296	34.5	\$1724	\$200
<p>23"H Credenza w/Pull-Out Equipment Tray - RIGHT*</p>		<p>Specify PNxxxxCRL for left or PNxxxxCRR for right.</p> <p>Standard with 34"W box and lateral file drawer. Pull-out equipment shelf can support up to 80 lbs. Adjustable 6 position shelf. File bars included for front-to-back letter/legal filing capability. Lock on file drawer secures both drawers. Wire management grommet as shown on surface and internal pass-through at back of lower shelf. Supports overlapping return with metal leg and spacer for 23"H credenza, overlapping tapered return with metal leg and spacer for 23"H credenza, and overlapping bridges with metal spacer for 23"H credenza. Shipped assembled in 1 carton.</p>					
	LEFT	PN2354NCL	54 x 20 x 23	187	18.3	\$1338	\$183
		PN2360NCL	60 x 20 x 23	200	20.5	\$1344	\$184
		PN2354NCR	54 x 20 x 23	187	18.3	\$1338	\$183
	RIGHT	PN2360NCR	60 x 20 x 23	200	20.5	\$1344	\$184
		<p>Specify PNxxxxNCL for left or PNxxxxNCR for right.</p> <p>20" deep. Standard with 30"W box and lateral file drawer. File bars included for front-to-back letter/legal filing capability. Lock on file drawer secures both drawers. Wire management grommet as shown on surface and internal pass-through at back of lower shelf. Supports overlapping return with metal leg and spacer for 23"H credenza, overlapping tapered return with metal leg and spacer for 23"H credenza, and overlapping bridges with metal spacer for 23"H credenza. Shipped assembled in 1 carton.</p>					
	<p>23"H Double Credenza</p>	PN2372CRD	72 x 24 x 23	307	28.75	\$1763	\$242
<p>Standard with locking 34"W box and lateral file drawer on each side. File bars included for front-to-back letter/legal filing capability. Lock on file drawer secures both drawers. Shipped assembled in 1 carton.</p>							
	<p>23"H Single Credenza</p>	PN2337CRS	37 x 24 x 23	170	15.25	\$1197	\$166
<p>Standard with 34"W box and lateral file drawer. File bars included for front-to-back letter/legal filing capability. Lock on file drawer secures both drawers. Shipped assembled in 1 carton.</p>							

Required specifications

Top finish
Base finish
Drawer front finish

Optional specifications

HP laminate
RSG - no grommet*

Accessories

Cushion

23" H CRENZAS

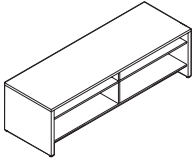

23" H Open Credenza

MODEL # DIMENSIONS WT/LB. CUBIC FT. LIST PRICE HP ADD

	W x D x H				
PN2360CO	60 x 24 x 23	187	24.25	\$1177	\$162
PN2372CO	72 x 24 x 23	216	28.75	\$1279	\$175
PN2384CO	84 x 24 x 23	244	34.5	\$1423	\$195

Open storage with adjustable 6 position upper shelves with pass-throughs at back of lower shelves. Supports overlapping return with metal leg and spacer for 23" H credenza, overlapping tapered return with metal leg and spacer for 23" H credenza, and overlapping bridges with metal spacer for 23" H credenza. Shipped assembled in 1 carton.

Required specifications

Top finish
Base finish

Optional specifications

HP laminate

Accessories

Cushion

CUSHIONS FOR 23" H CREDENZAS

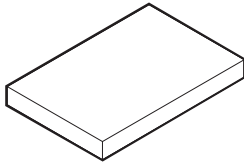

Cushion for 23" H Credenzas

MODEL #	DIMENSIONS	WT/LB.	CUBIC FT.	GRADE	LIST	GRADE	LIST
W x D x H							
PN2430CU	30 x 24 x 2.5	12	2.4	1	\$236	7	\$589
				2	\$284	8	\$650
				3	\$325	9	\$727
				4	\$371	10	\$799
				5	\$448	11	\$896
				6	\$518	12	\$1034
PN2433CU	33 x 24 x 2.5	12	2.4	1	\$262	7	\$732
				2	\$326	8	\$814
				3	\$380	9	\$916
				4	\$442	10	\$1012
				5	\$544	11	\$1142
				6	\$638	12	\$1326
PN2436CU	36 x 24 x 2.25	11	2.6	1	\$269	7	\$798
				2	\$341	8	\$890
				3	\$402	9	\$1005
				4	\$472	10	\$1113
				5	\$586	11	\$1259
				6	\$692	12	\$1466
PN2439CU	39 x 24 x 2.5	13	2.4	1	\$286	7	\$815
				2	\$358	8	\$907
				3	\$419	9	\$1022
				4	\$489	10	\$1130
				5	\$603	11	\$1276
				6	\$709	12	\$1483
PN2442CU	42 x 24 x 2.5	13	2.4	1	\$295	7	\$824
				2	\$367	8	\$916
				3	\$428	9	\$1031
				4	\$498	10	\$1139
				5	\$612	11	\$1285
				6	\$718	12	\$1492

Cushion attaches with Velcro strips. Fits **24" D** credenzas.

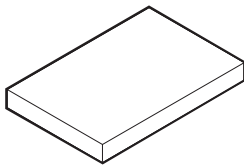

Cushion for 23" H Narrow Credenzas

PN2027CU	27 x 20 x 2.5	11	2.4	1	\$205	7	\$499
				2	\$245	8	\$550
				3	\$279	9	\$614
				4	\$318	10	\$674
				5	\$381	11	\$755
				6	\$440	12	\$870
PN2030CU	30 x 20 x 2.5	11	2.4	1	\$227	7	\$521
				2	\$267	8	\$572
				3	\$301	9	\$636
				4	\$340	10	\$696
				5	\$403	11	\$777
				6	\$462	12	\$892

Cushion attaches with Velcro strips. Fits **20" D** credenzas.

Required specifications

Fabric

CUSHION FOR 23" HIGH CREDENZAS

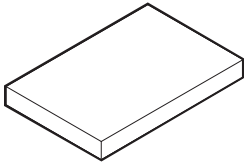

Cushion for 23" H Single Credenza

MODEL #	DIMENSIONS W x D x H	WT/LB.	CUBIC FT.	GRADE	LIST	GRADE	LIST
PN2437CU	37 x 24 x 2.5	13	2.4	1	\$284	7	\$813
				2	\$356	8	\$905
				3	\$417	9	\$1020
				4	\$487	10	\$1128
				5	\$601	11	\$1274
				6	\$707	12	\$1481

Cushion attaches with Velcro strips. Fits **PN2337CRS** credenza.

52" H STORAGE CABINETS

LIST PRICE

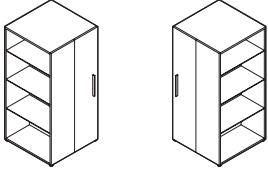

LEFT

RIGHT

52" H Tower Wardrobe w/Full Height Bookcase

PN52TWBL	24 x 24 x 51.5	147	21.5	\$1306
PN52TWBR	24 x 24 x 51.5	147	21.5	\$1306

Specify PN52TWBL for **left** or PN52TWBR for **right**.

Locking wardrobe with full height bookcase. Three adjustable laminate shelves with fixed bottom laminate shelf. Coat rail. Shipped assembled in 1 carton.

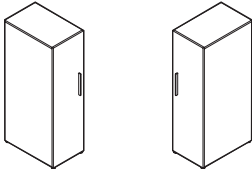

LEFT

RIGHT

52" H Wardrobe

PN1652WDL	16 x 24 x 51.5	105	15.25	\$774
PN1652WDR	16 x 24 x 51.5	105	15.25	\$774

Specify PN1652WDL for **left** or PN1652WDR for **right**.

Locking wardrobe with coat rail. Shipped assembled in 1 carton.

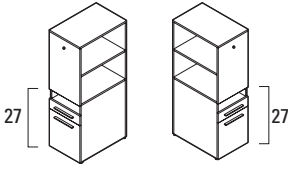

LEFT

RIGHT

52" H Storage Cabinet w/Bookshelf at 27" H

PN57CSBFL	16 x 24 x 51.5	131	15.25	\$1116
PN57CSBFR	16 x 24 x 51.5	131	15.25	\$1116

Specify PN57CSBFL for **left** or PN57CSBFR for **right**.

Open shelf/box/file drawer. Lock on file drawer secures both drawers. One adjustable laminate shelf. Fixed bottom shelf aligns with **27" H** surfaces. Outside accessory hook. Shipped assembled in 1 carton.

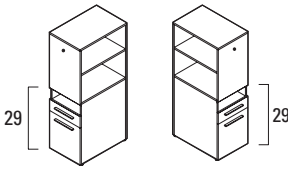

LEFT

RIGHT

52" H Storage Cabinet w/Bookshelf at 29" H

PN59CSBFL	16 x 24 x 51.5	131	15.25	\$1135
PN59CSBFR	16 x 24 x 51.5	131	15.25	\$1135

Specify PN59CSBFL for **left** or PN59CSBFR for **right**.

Open shelf/box/file drawer. Lock on file drawer secures both drawers. One adjustable laminate shelf. Fixed bottom shelf aligns with **29" H** surfaces. Outside accessory hook. Shipped assembled in 1 carton.

Required specifications

- Top finish
- Base finish
- Fabric (only cushion)
- Door finish

Optional specifications

- No lock

52" H STORAGE CABINETS **MODEL #** **DIMENSIONS** **WT/LB.** **CUBIC FT.** **LIST PRICE**

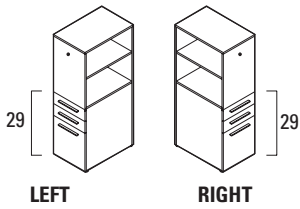

	W x D x H			
PN59CBBFL	16 x 24 x 51.5	132	15.25	\$1198
PN59CBBFR	16 x 24 x 51.5	132	15.25	\$1198

Specify PN59CBBFL for **left** or PN59CBBFR for **right**.

52" H Storage Cabinet w/Bookshelf at 29" H

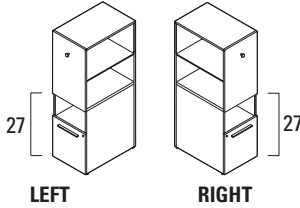

Box/box/file drawer. Lock on file drawer secures both drawers. One adjustable laminate shelf. Fixed bottom shelf aligns with **29" H** surfaces. Outside accessory hook. Shipped assembled in 1 carton.

PN57RCSL	16 x 24 x 51.5	131	15.25	\$1153
PN57RCSR	16 x 24 x 51.5	131	15.25	\$1153

Specify PN57RCSL for **left** or PN57RCSR for **right**.

52" H Recycling Cabinet w/Bookshelf at 27" H

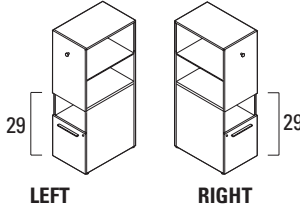

Drawer with one waste bin, one recycling bin and an open shelf above. One adjustable laminate shelf. Fixed bottom shelf aligns with **27" H** surfaces. Outside accessory hook. Shipped assembled in 1 carton.

PN59RCSL	16 x 24 x 51.5	131	15.25	\$1165
PN59RCSR	16 x 24 x 51.5	131	15.25	\$1165

Specify PN59RCSL for **left** or PN59RCSR for **right**.

52" H Recycling Cabinet w/Bookshelf at 29" H

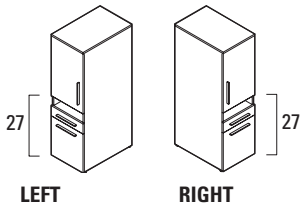

Drawer with one waste bin, one recycling bin and an open shelf above. One adjustable laminate shelf. Fixed bottom shelf aligns with **29" H** surfaces. Outside accessory hook. Shipped assembled in 1 carton.

PN57DSBFL	16 x 24 x 51.5	137	15.25	\$1245
PN57DSBFR	16 x 24 x 51.5	137	15.25	\$1245

Specify PN57DSBFL for **left** or PN57DSBFR for **right**.

52" H Storage Cabinet w/Door at 27" H

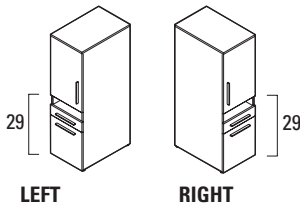

Open shelf/box/file drawer. Lock on file drawer secures both drawers. Upper storage cabinet with locking door and one adjustable laminate shelf inside. Door aligns with **27" H** surfaces. Shipped assembled in 1 carton.

PN59DSBFL	16 x 24 x 51.5	137	15.25	\$1245
PN59DSBFR	16 x 24 x 51.5	137	15.25	\$1245

Specify PN59DSBFL for **left** or PN59DSBFR for **right**.

52" H Storage Cabinet w/Door at 29" H

Open shelf/box/file drawer. Lock on file drawer secures both drawers. Upper storage cabinet with locking door and one adjustable laminate shelf inside. Door aligns with **29" H** surfaces. Shipped assembled in 1 carton.

Required specifications

- Top finish
- Base finish
- Drawer/panel finish
- Door/drawer finish

Optional specifications

- No lock (where applicable)

52"H STORAGE CABINETS

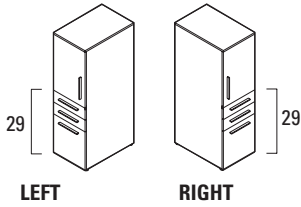

MODEL # DIMENSIONS WT/LB. CUBIC FT. LIST PRICE

W x D x H

PN59DBBFL	16 x 24 x 51.5	139	15.25	\$1347
PN59DBBFR	16 x 24 x 51.5	139	15.25	\$1347

Specify PN59DBBFL for **left** or PN59DBBFR for **right**.

52"H Storage Cabinet w/Door at 29"H

Box/box/file drawer. Lock on file drawer secures file and lower box drawers. Upper storage cabinet with locking door and one adjustable laminate shelf inside. Door aligns with **29"H** surfaces. Shipped assembled in 1 carton.

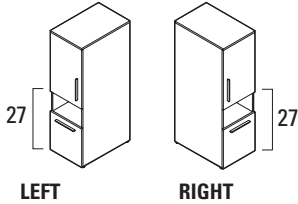

PN57DRCSL	16 x 24 x 51.5	138	15.25	\$1139
PN57DRCSR	16 x 24 x 51.5	138	15.25	\$1139

Specify PN57DRCSL for **left** or PN57DRCSR for **right**.

52"H Recycling Cabinet w/Door at 27"H

Upper storage cabinet with locking door. Drawer with one waste bin, one recycling bin, and an open shelf above. One adjustable laminate shelf inside locking cabinet door. Door aligns with **27"H** surfaces. Shipped assembled in 1 carton.

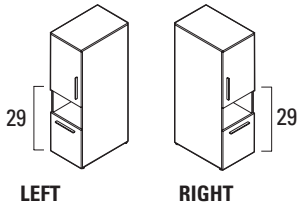

PN59DRCSL	16 x 24 x 51.5	137	15.25	\$1157
PN59DRCSR	16 x 24 x 51.5	137	15.25	\$1157

Specify PN59DRCSL for **left** or PN59DRCSR for **right**.

52"H Recycling Cabinet w/Door at 29"H

Upper storage cabinet with locking door. Drawer with one waste bin, one recycling bin, and an open shelf above. One adjustable laminate shelf inside locking cabinet door. Door aligns with **29"H** surfaces. Shipped assembled in 1 carton.

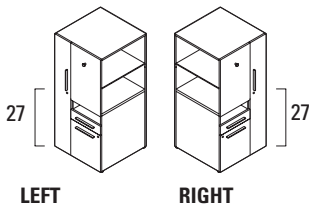

PN57TSBFL	24 x 24 x 51.5	180	21.5	\$1611
PN57TSBFR	24 x 24 x 51.5	180	21.5	\$1611

Specify PN57TSBFL for **left** or PN57TSBFR for **right**.

52"H Storage Tower w/Wardrobe, Shelf and Bookshelf at 27"H

Open shelf/box/file drawer. Lock on file drawer secures both drawers. One adjustable laminate shelf. Fixed bottom shelf aligns with 27"H surfaces. Outside accessory hook and locking wardrobe with coat rail. Shipped assembled in 1 carton.

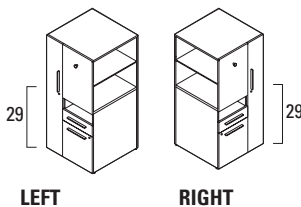

PN59TSBFL	24 x 24 x 51.5	180	21.5	\$1364
PN59TSBFR	24 x 24 x 51.5	180	21.5	\$1364

Specify PN59TSBFL for **left** or PN59TSBFR for **right**.

52"H Storage Tower w/Wardrobe, Shelf and Bookshelf at 29"H

Open shelf/box/file drawer. Lock on file drawer secures both drawers. One adjustable laminate shelf. Fixed bottom shelf aligns with **29"H** surfaces. Outside accessory hook and locking wardrobe with coat rail. Shipped assembled in 1 carton.

Required specifications

Top finish _____ Panel finish* _____
 Base finish _____
 Drawer finish _____
 Door finish _____

Optional specifications

No lock (not PN57DRCSx) _____

52" H STORAGE CABINETS

MODEL # DIMENSIONS WT/LB. CUBIC FT. LIST PRICE

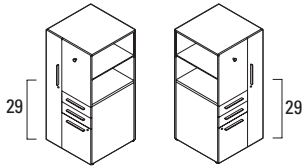

LEFT RIGHT

52" H Storage Tower w/Wardrobe, and Bookshelf at 29" H

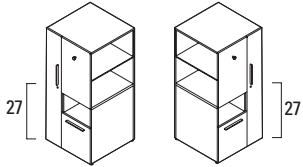

LEFT RIGHT

52" H Storage Tower w/Wardrobe, Shelf, Recycling and Bookshelf at 27" H

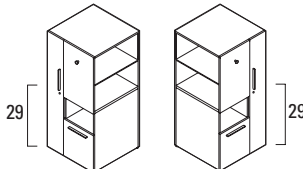

LEFT RIGHT

52" H Storage Tower w/Wardrobe, Shelf, Recycling and Bookshelf at 29" H

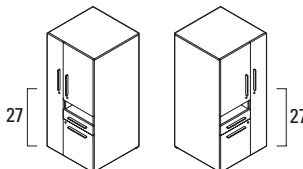

LEFT RIGHT

52" H Storage Tower w/Wardrobe, Shelf/Box/File and Door at 27" H

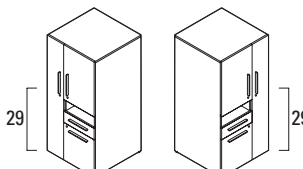

LEFT RIGHT

52" H Storage Tower w/Wardrobe, Shelf/Box/File and Door at 29" H

W x D x H

PN59TBBFL	24 x 24 x 51.5	183	21.5	\$1863
PN59TBBFR	24 x 24 x 51.5	183	21.5	\$1863

Specify PN59TBBFL for **left** or PN59TBBFR for **right**.

Box/box/file drawer. Lock on file drawer secures file and lower box drawer. One adjustable laminate shelf. Fixed bottom shelf aligns with **29" H** surfaces. Outside accessory hook and locking wardrobe with coat rail. Shipped assembled in 1 carton.

PN57RTSL	24 x 24 x 51.5	181	21.5	\$1729
PN57RTSR	24 x 24 x 51.5	181	21.5	\$1729

Specify PN57RTSL for **left** or PN57RTSR for **right**.

Drawer with one waste and one recycling bin. Open shelf above. One adjustable laminate shelf. Fixed bottom shelf aligns with 27" H surfaces. Outside accessory hook. Locking wardrobe with coat rail. Shipped assembled in 1 carton.

PN59RTSL	24 x 24 x 51.5	181	21.5	\$1729
PN59RTSR	24 x 24 x 51.5	181	21.5	\$1729

Specify PN59RTSL for **left** or PN59RTSR for **right**.

Drawer with one waste and one recycling bin. Open shelf above. One adjustable laminate shelf. Fixed bottom shelf aligns with **29" H** surfaces. Outside accessory hook. Locking wardrobe with coat rail. Shipped assembled in 1 carton.

PN57SBFTL	24 x 24 x 51.5	187	21.5	\$1811
PN57SBFTR	24 x 24 x 51.5	187	21.5	\$1811

Specify PN57SBFTL for **left** or PN57SBFTR for **right**.

Open shelf/box/file drawer. Lock on file drawer secures both drawers. Upper storage cabinet with locking door and one adjustable laminate shelf inside. Door aligns with **27" H** surfaces. Locking wardrobe with coat rail. Shipped assembled in 1 carton.

PN59SBFTL	24 x 24 x 51.5	186	21.5	\$1811
PN59SBFTR	24 x 24 x 51.5	186	21.5	\$1811

Specify PN59SBFTL for **left** or PN59SBFTR for **right**.

Open shelf/box/file drawer. Lock on file drawer secures both drawers. Upper storage cabinet with locking door and one adjustable laminate shelf inside. Door aligns with **29" H** surfaces. Locking wardrobe with coat rail. Shipped assembled in 1 carton.

Required specifications

- Top finish
- Base finish
- Drawer/panel finish
- Door finish

Optional specifications

- No lock

52"H STORAGE CABINETS

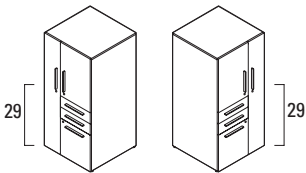

LEFT

RIGHT

52"H Storage Tower w/Wardrobe, Shelf, Box/Box/File and Door at 29"H*

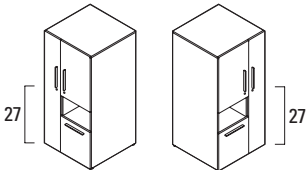

LEFT

RIGHT

52"H Storage Tower w/Wardrobe, Shelf, Recycling and Door at 29"H*

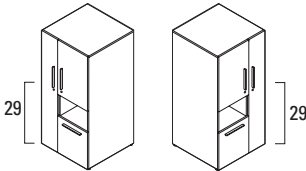

LEFT

RIGHT

52"H Storage Tower w/Wardrobe, Shelf, Recycling and Door at 29"H*

MODEL # DIMENSIONS WT/LB. CUBIC FT. LIST PRICE

W x D x H

PN59BBFTL	24 x 24 x 51.5	189	21.5	\$1911
PN59BBFTR	24 x 24 x 51.5	189	21.5	\$1911

Specify PN59BBFTL for **left** or PN59BBFTR for **right**.

Box/box/file drawer. Lock on file drawer secures file and lower box drawers. Upper storage cabinet with locking door and one adjustable laminate shelf inside. Door aligns with **29"H** surfaces. Locking wardrobe with coat rail. Shipped assembled in 1 carton.

PN57DRTSL	24 x 24 x 51.5	188	21.5	\$1845
PN57DRTSR	24 x 24 x 51.5	188	21.5	\$1845

Specify PN57DRTSL for **left** or PN57DRTSR for **right**.

Drawer with one waste and one recycling bin. Open shelf above. Upper storage cabinet with locking door and one adjustable laminate shelf inside. Door aligns with **27"H** surfaces. Locking wardrobe with coat rail. Shipped assembled in 1 carton.

PN59DRTSL	24 x 24 x 51.5	187	21.5	\$1845
PN59DRTSR	24 x 24 x 51.5	187	21.5	\$1845

Specify PN59DRTSL for **left** or PN59DRTSR for **right**.

Drawer with one waste and one recycling bin. Open shelf above. Upper storage cabinet with locking door and one adjustable laminate shelf inside. Door aligns with **29"H** surfaces. Locking wardrobe with coat rail. Shipped assembled in 1 carton.

66"H STORAGE CABINETS

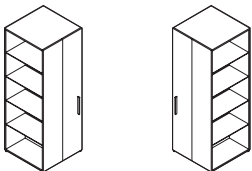

LEFT

RIGHT

66"H Tower Wardrobe w/Full Height Bookcase

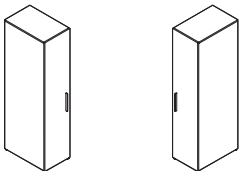

LEFT

RIGHT

66"H Wardrobe**

PN66TWBL	24 x 24 x 65.5	184	27	\$1518
PN66TWBR	24 x 24 x 65.5	184	27	\$1518

Specify PN66TWBL for **left** or PN66TWBR for **right**.

Locking wardrobe and full height bookcase. Four adjustable laminate shelves with fixed bottom laminate shelf. Coat rail. Shipped assembled in 1 carton.

PN1666WDL	16 x 24 x 65.5	133	19	\$927
PN1666WDR	16 x 24 x 65.5	133	19	\$927

Specify PN1666WDL for **left** or PN1666WDR for **right**.

Locking wardrobe with coat rail and fixed shelf above. Shipped assembled in 1 carton.

Required specifications

- Top finish
- Base finish
- Drawer finish*
- Door finish**

Optional specifications

- No lock

66" H STORAGE CABINETS **MODEL #** **DIMENSIONS** **WT/LB.** **CUBIC FT.** **LIST PRICE**

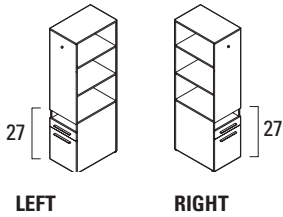

66" H Storage Cabinet w/Bookshelf at 27" H

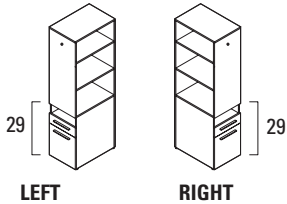

66" H Storage Cabinet w/Bookshelf at 29" H

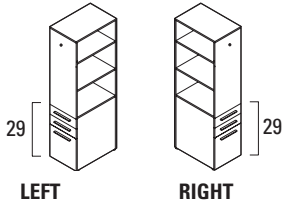

66" H Storage Cabinet w/Bookshelf at 29" H

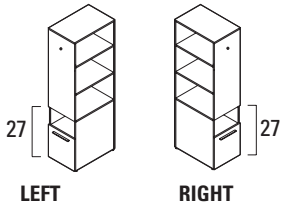

66" H Recycling Cabinet w/Bookshelf at 27" H

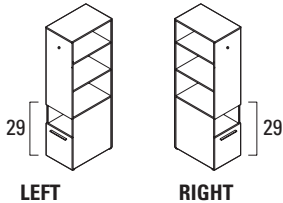

66" H Recycling Cabinet w/Bookshelf at 29" H

W x D x H

PN67CSBFL	16 x 24 x 65.5	153	19	\$1323
PN67CSBFR	16 x 24 x 65.5	153	19	\$1323

Specify PN67CSBFL for **left** or PN67CSBFR for **right**.

Open shelf/box/file drawer. Lock on file drawer secures both drawers. Two adjustable laminate shelves. Fixed bottom shelf aligns with **27" H** surfaces. Outside accessory hook. Shipped assembled in 1 carton.

PN69CSBFL	16 x 24 x 65.5	154	19	\$1323
PN69CSBFR	16 x 24 x 65.5	154	19	\$1323

Specify PN69CSBFL for **left** or PN69CSBFR for **right**.

Open shelf/box/file drawer. Lock on file drawer secures both drawers. Two adjustable laminate shelves. Fixed bottom shelf aligns with **29" H** surfaces. Outside accessory hook. Shipped assembled in 1 carton.

PN69CBBFL	16 x 24 x 65.5	155	19	\$1413
PN69CBBFR	16 x 24 x 65.5	155	19	\$1413

Specify PN69CBBFL for **left** or PN69CBBFR for **right**.

Box/box/file drawer. Lock on file drawer secures file and lower box drawer. Two adjustable laminate shelves. Fixed bottom shelf aligns with **29" H** surfaces. Outside accessory hook. Shipped assembled in 1 carton.

PN67RCSL	16 x 24 x 65.5	154	19	\$1384
PN67RCR	16 x 24 x 65.5	154	19	\$1384

Specify PN67RCSL for **left** or PN67RCR for **right**.

Drawer with one waste bin and one recycling bin. Open shelf above. Two adjustable laminate shelves. Fixed bottom shelf aligns with **27" H** surfaces. Outside accessory hook. Shipped assembled in 1 carton.

PN69RCSL	16 x 24 x 65.5	154	19	\$1384
PN69RCR	16 x 24 x 65.5	154	19	\$1384

Specify PN69RCSL for **left** or PN69RCR for **right**.

Drawer with one waste bin and one recycling bin. Open shelf above. Two adjustable laminate shelves. Fixed bottom shelf aligns with **29" H** surfaces. Outside accessory hook. Shipped assembled in 1 carton.

Required specifications

- Top finish
- Base finish
- Drawer/panel finish

Optional specifications

- No lock

66"H STORAGE CABINETS

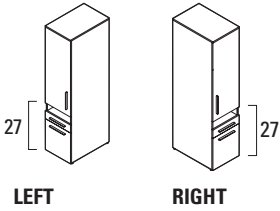

66"H Storage Cabinet w/Door at 27"H**

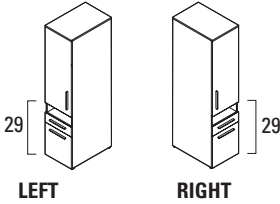

66"H Storage Cabinet w/Door at 29"H

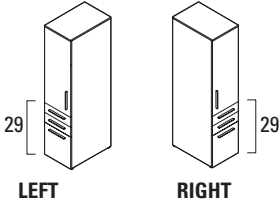

66"H Storage Cabinet w/Door at 29"H

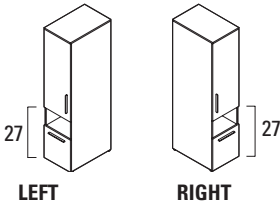

66"H Recycling Cabinet w/Door at 27"H

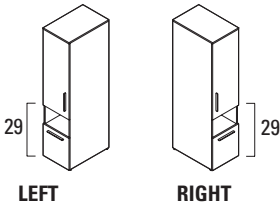

66"H Recycling Cabinet w/Door at 29"H

MODEL # DIMENSIONS WT/LB. CUBIC FT. LIST PRICE

W x D x H

PN67DSBFL	16 x 24 x 65.5	166	19	\$1332
PN67DSBFR	16 x 24 x 65.5	166	19	\$1332

Specify PN67DSBFL for **left** or PN67DSBFR for **right**.

Open shelf/box/file drawer. Lock on file drawer secures both drawers. Upper storage cabinet with locking door and two adjustable laminate shelves inside. Door aligns with **27"H** surfaces. Shipped assembled in 1 carton.

PN69DSBFL	16 x 24 x 65.5	166	19	\$1332
PN69DSBFR	16 x 24 x 65.5	166	19	\$1332

Specify PN69DSBFL for **left** or PN69DSBFR for **right**.

Open shelf/box/file drawer. Lock on file drawer secures both drawers. Upper storage cabinet with locking door and two adjustable laminate shelves inside. Door aligns with **29"H** surfaces. Shipped assembled in 1 carton.

PN69DBBFL	16 x 24 x 65.5	168	19	\$1535
PN69DBBFR	16 x 24 x 65.5	168	19	\$1535

Specify PN69DBBFL for **left** or PN69DBBFR for **right**.

Box/box/file drawer. Lock on file drawer secures file and lower box drawer. Upper storage cabinet with locking door and two adjustable laminate shelves inside. Door aligns with **29"H** surfaces. Shipped assembled in 1 carton.

PN67DRCSL	16 x 24 x 65.5	167	19	\$1343
PN67DRCSR	16 x 24 x 65.5	167	19	\$1343

Specify PN67DRCSL for **left** or PN67DRCSR for **right**.

Upper storage cabinet with locking door and two adjustable laminate shelves inside. Drawer with one waste bin, one recycling bin, and an open shelf above. Door aligns with **27"H** surfaces. Shipped assembled in 1 carton.

PN69DRCSL	16 x 24 x 65.5	167	19	\$1343
PN69DRCSR	16 x 24 x 65.5	167	19	\$1343

Specify PN69DRCSL for **left** or PN69DRCSR for **right**.

Upper storage cabinet with locking door and two adjustable laminate shelves inside. Drawer with one waste bin, one recycling bin, and an open shelf above. Door aligns with **29"H** surfaces. Shipped assembled in 1 carton.

Required specifications

- Top finish
- Base finish
- Drawer/door finish

Optional specifications

- No lock

66" H STORAGE CABINETS **MODEL #** **DIMENSIONS** **WT/LB.** **CUBIC FT.** **LIST PRICE**

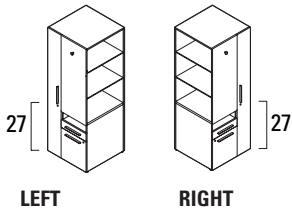

66" H Storage Tower w/Wardrobe, Shelf, Box/File and Bookshelf at 27" H

	W x D x H			
PN67TSBFL	24 x 24 x 65.5	216	27	\$1888
PN67TSBFR	24 x 24 x 65.5	216	27	\$1888

Specify PN67TSBFL for **left** or PN67TSBFR for **right**.

Open shelf/box/file drawer. Lock on file drawer secures both drawers. Two adjustable laminate shelves. Fixed bottom shelf aligns with **27" H** surfaces. Outside accessory hook and locking wardrobe with coat rail. Shipped assembled in 1 carton.

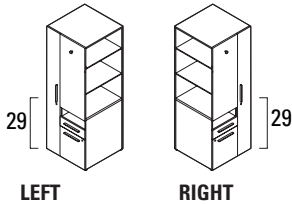

66" H Storage Tower w/Wardrobe, Shelf, Box/File and Bookshelf at 29" H

PN69TSBFL	24 x 24 x 65.5	216	27	\$1888
PN69TSBFR	24 x 24 x 65.5	216	27	\$1888

Specify PN69TSBFL for **left** or PN69TSBFR for **right**.

Open shelf/box/file drawer. Lock on file drawer secures both drawers. Two adjustable laminate shelves. Fixed bottom shelf aligns with **29" H** surfaces. Outside accessory hook and locking wardrobe with coat rail. Shipped assembled in 1 carton.

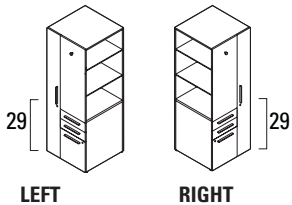

66" H Storage Tower w/Wardrobe, Shelf, Box/Box/File and Bookshelf at 29" H

PN69TBBFL	24 x 24 x 65.5	219	27	\$1990
PN69TBBFR	24 x 24 x 65.5	219	27	\$1990

Specify PN69TBBFL for **left** or PN69TBBFR for **right**.

Box/box/file drawer. Lock on file and lower box drawer. Two adjustable laminate shelves. Fixed bottom shelf aligns with **29" H** surfaces. Outside accessory hook and locking wardrobe with coat rail. Shipped assembled in 1 carton.

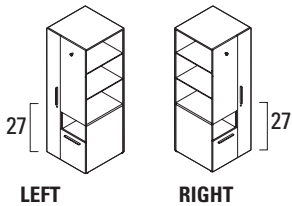

66" H Storage Tower w/Wardrobe, Shelf, Recycling and Bookshelf at 27" H

PN67RTSL	24 x 24 x 65.5	217	27	\$1896
PN67RTSR	24 x 24 x 65.5	217	27	\$1896

Specify PN67RTSL for **left** or PN67RTSR for **right**.

Drawer with one waste and one recycling bin. Open shelf above. Two adjustable laminate shelves. Fixed bottom shelf aligns with **27" H** surfaces. Outside accessory hook. Locking wardrobe with coat rail. Shipped assembled in 1 carton.

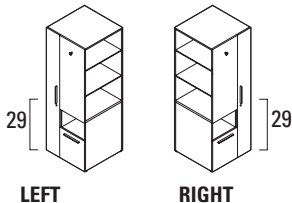

66" H Storage Tower w/Wardrobe, Shelf, Recycling and Bookshelf at 29" H

PN69RTSL	24 x 24 x 65.5	217	27	\$1896
PN69RTSR	24 x 24 x 65.5	217	27	\$1896

Specify PN69RTSL for **left** or PN69RTSR for **right**.

Drawer with one waste and one recycling bin. Open shelf above. Two adjustable laminate shelves. Fixed bottom shelf aligns with **29" H** surfaces. Outside accessory hook. Locking wardrobe with coat rail. Shipped assembled in 1 carton.

Required specifications

- Top finish
- Base finish
- Drawer/door finish
- Panel finish

Optional specifications

- No lock

66" H STORAGE CABINETS

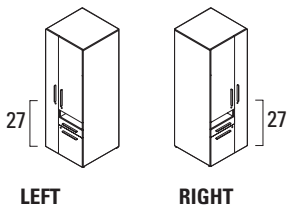

66" H Storage Tower w/Wardrobe, Shelf, Box/File and Door at 27" H

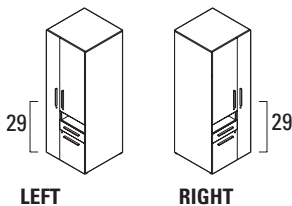

66" H Storage Tower w/Wardrobe, Shelf, Box/File and Door at 29" H

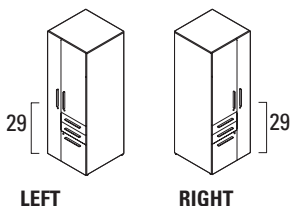

66" H Storage Tower w/Wardrobe, Box/Box/File and Door at 29" H

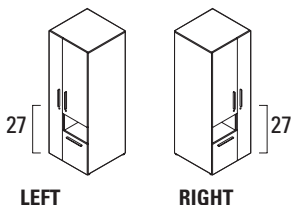

66" H Storage Tower w/Wardrobe, Large Shelf, Recycling and Door at 27" H

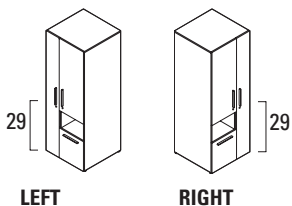

66" H Storage Tower w/Wardrobe, Large Shelf, Recycling and Door at 29" H

MODEL # DIMENSIONS WT/LB. CUBIC FT. LIST PRICE

W x D x H

PN67SBFTL	24 x 24 x 65.5	229	27	\$1960
PN67SBFTR	24 x 24 x 65.5	229	27	\$1960

Specify PN67SBFTL for **left** or PN67SBFTR for **right**.

Open shelf/box/file drawer. Lock on file drawer secures both drawers. Upper storage cabinet with locking door and two adjustable laminate shelves inside. Door aligns with **27" H** surfaces. Outside accessory hook. Locking wardrobe with coat rail. Shipped assembled in 1 carton.

PN69SBFTL	24 x 24 x 65.5	229	27	\$1960
PN69SBFTR	24 x 24 x 65.5	229	27	\$1960

Specify PN69SBFTL for **left** or PN69SBFTR for **right**.

Open shelf/box/file drawer. Lock on file drawer secures both drawers. Upper storage cabinet with locking door and two adjustable laminate shelves inside. Door aligns with **29" H** surfaces. Locking wardrobe with coat rail. Shipped assembled in 1 carton.

PN69BBFTL	24 x 24 x 65.5	230	27	\$2059
PN69BBFTR	24 x 24 x 65.5	230	27	\$2059

Specify PN69BBFTL for **left** or PN69BBFTR for **right**.

Box/box/file drawer. Lock on file drawer secures file and lower box drawer. Upper storage cabinet with locking door and two adjustable laminate shelves inside. Door aligns with **29" H** surfaces. Locking wardrobe with coat rail. Shipped assembled in 1 carton.

PN67DRTSL	24 x 24 x 65.5	229	27	\$2007
PN67DRTSR	24 x 24 x 65.5	229	27	\$2007

Specify PN67DRTSL for **left** or PN67DRTSR for **right**.

Drawer with one waste and one recycling bin. Open shelf above. Upper storage cabinet with locking door and two adjustable laminate shelves inside. Door aligns with **27" H** surfaces. Locking wardrobe with coat rail. Shipped assembled in 1 carton.

PN69DRTSL	24 x 24 x 65.5	229	27	\$2007
PN69DRTSR	24 x 24 x 65.5	229	27	\$2007

Specify PN69DRTSL for **left** or PN69DRTSR for **right**.





Drawer with one waste and one recycling bin. Open shelf above. Upper storage cabinet with locking door and two adjustable laminate shelves inside. Door aligns with **29" H** surfaces. Locking wardrobe with coat rail. Shipped assembled in 1 carton.

Required specifications

Top finish
Base finish
Drawer/door finish

Optional specifications

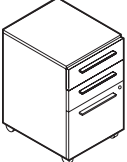
No lock

MOBILE PEDESTALS	MODEL #	DIMENSIONS W x D x H	WT/LB.	CUBIC FT.	LIST PRICE	HP ADD
	PN22MBF	16 x 22 x 20.9	69	6.05	\$840	\$88
20.9"H Mobile Pedestal*	Box/file drawer. Lock on box drawer secures both drawers. Front casters are locking. Shipped assembled in 1 carton.					
	PN25MSBF	16 x 22 x 25.4	80	7.25	\$888	\$95
25.4"H Mobile Pedestal*	Open shelf/box/file drawer. Lock on file drawer secures both drawers. 29"H units with hat channels have an underside clearance of only 25.9"H. Front casters are locking. Shipped assembled in 1 carton.					
	PN25MBBF	16 x 22 x 25.4	88	7.25	\$938	\$113
25.4"H Mobile Pedestal	Box/box/file drawer. Lock on file drawer secures file and lower box drawer. 29"H units with hat channels have an underside clearance of only 25.9"H. Front casters are locking. Shipped assembled in 1 carton.					
	PN27MFF	16 x 22 x 26.8	108	7.5	\$917	\$104
26.8"H Mobile Pedestal	File/file. 26.8"H mobile storage can only be used with 29"H Princeton products that have laminate end panels/gables; 29"H units with hat channels have an underside clearance of only 25.9"H. Lock on lower file drawer secures both drawers. Front casters are locking. Shipped assembled in 1 carton.					

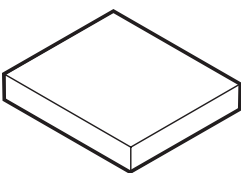
PEDESTAL CUSHIONS	MODEL #	DIMENSIONS W x D x H	WT/LB.	CUBIC FT.	GRADE	LIST	GRADE	LIST
	PN1622CU	16 x 21.5 x 2.5	3	0.9	1	\$122	7	\$357
					2	\$154	8	\$398
					3	\$181	9	\$449
					4	\$212	10	\$497
					5	\$263	11	\$562
					6	\$310	12	\$654
Pedestal Cushion	For PN22MBF mobile pedestal.							

Required specifications

Top finish
Base finish
Drawer finish
Fabric (only cushion)

Optional specifications

No lock
HP laminate

Accessories

Cushion*

MOBILE LATERAL FILES **MODEL #** **DIMENSIONS** **WT/LB.** **CUBIC FT.** **LIST PRICE** **HP ADD**

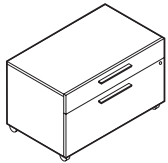

20.5”H Mobile Lateral File*

	W x D x H					
PN22MLBF	35.5 x 22 x 21	120	12.5	\$1326	\$181	

Box/file drawer. Lock on file drawer secures both drawers. File bars included for front-to-back letter/legal filing capability. Front casters are locking. Can fit under 29” and 27” high credenzas for mobile lateral file with or without a cushion. Can fit under 23” high credenzas without cushion only. Shipped assembled in 1 carton.

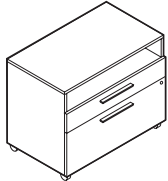

25.5”H Mobile Lateral File

PN25MLSBF	35.5 x 22 x 25	141	15	\$1385	\$191	
-----------	----------------	-----	----	---------------	--------------	--

Open shelf/box/file drawer. Lock on file drawer secures both drawers. File bars included for front-to-back letter/legal filing capability. Front casters are locking. Can fit under 29” high credenzas for mobile lateral file without cushion only. Shipped assembled in 1 carton.

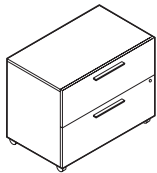

27”H Mobile Lateral File

PN27MLFF	35.5 x 22 x 27	161	15.5	\$1447	\$197	
----------	----------------	-----	------	---------------	--------------	--

File/file drawer. 27”H mobile storage can only be used with 29”H Princeton products that have laminate end panels/gables; Princeton products with metal legs will not accommodate 27”H mobile units. Lock on bottom file drawer secures both drawers. File bars included for front-to-back letter/legal filing capability. Front casters are locking. Can fit under 29” high credenzas for mobile lateral file without cushion only. Shipped assembled in 1 carton.

MOBILE LATERAL FILE CUSHIONS **MODEL #** **DIMENSIONS** **WT/LB.** **CUBIC FT.** **GRADE** **LIST** **GRADE** **LIST**

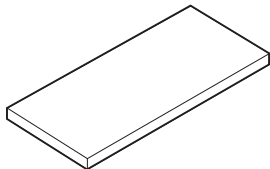

Mobile Lateral File Cushion

PN3622CU	22 x 36 x 2.5	13	2.4	1	\$302	7	\$772
				2	\$366	8	\$854
				3	\$420	9	\$956
				4	\$482	10	\$1052
				5	\$584	11	\$1182
				6	\$678	12	\$1366

For **PN22MLBF** mobile lateral file.

MOBILE STOOL **LIST PRICE**

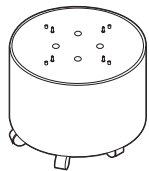

Round Mobile Stool

PN1920ST	19 x 19 x 14.68	25	5.25	\$675	
----------	-----------------	----	------	--------------	--

Laminate base for use with cushion. **CANNOT BE USED WITHOUT CUSHION. Cushion sold separately.** Six casters. Shipped assembled in 1 carton.

• **NOTE: Maximum weight capacity is 200 lbs**

Required specifications

Top finish
Base finish
Drawer finish
Fabric (only cushion)

Optional specifications

No lock
HP laminate

Accessories

Cushion*

CUSHION FOR MOBILE STOOL **MODEL #** **DIMENSIONS** **WT/LB.** **CUBIC FT.** **GRADE** **LIST** **LIST**

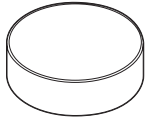

Cushion for Round Mobile Stool*

		W x D x H						
SEAT-PN1920ST	19 x 19 x 5	6	5.25	1	\$176	7	\$352	
				2	\$200	8	\$383	
				3	\$220	9	\$421	
				4	\$244	10	\$457	
				5	\$282	11	\$506	
				6	\$317	12	\$575	

To be used with mobile stool PN1920ST. Shipped in 1 carton.

POT PLANTERS **MODEL #** **DIMENSIONS** **WT/LB.** **CUBIC FT.** **LIST PRICE**

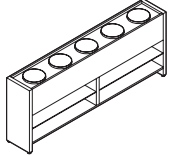

Five Pot Planter**

PN7229PL	72 x 12 x 29	156	20.25	\$1225
----------	--------------	-----	-------	---------------

Five plastic pots - specify Black (**BK**) or White (**WT**). Adjustable 3 position laminate shelf. Shipped assembled in 1 carton.

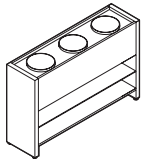

Three Pot Planter**

PN4229PL	42 x 12 x 29	99	12.25	\$931
----------	--------------	----	-------	--------------

Three plastic pots - specify Black (**BK**) or White (**WT**). Adjustable 3 position laminate shelf. Shipped assembled in 1 carton.

DIVIDER SHELVES

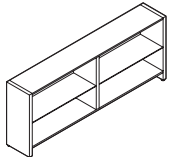

72"W Divider Shelf

PN7229BGS	72 x 12 x 29	126	20.25	\$1012
-----------	--------------	-----	-------	---------------

Adjustable 3 position laminate shelves. Shipped assembled in 1 carton.

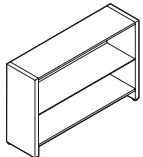

42"W Divider Shelf

PN4229BGS	42 x 12 x 29	80	12.25	\$816
-----------	--------------	----	-------	--------------

Adjustable 3 position laminate shelf. Shipped assembled in 1 carton.

Required specifications

- Top finish
- Base finish
- Fabric*
- Pot finish**

BOOKSHELVES

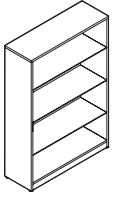

Bookshelf w/Laminate Shelves*

MODEL #	DIMENSIONS W x D x H	WT/LB.	CUBIC FT.	LIST PRICE	HP ADD
PN2429BLS	24 x 12 x 29	50	6.5	\$622	\$96
PN2452BLS	24 x 12 x 52	82	11.5	\$788	N/A
PN2466BLS	24 x 12 x 66	101	14.5	\$865	N/A
PN3029BLS	30 x 12 x 29	57	8	\$699	\$108
PN3052BLS	30 x 12 x 52	95	14	\$817	N/A
PN3066BLS	30 x 12 x 66	116	17.25	\$903	N/A
PN3629BLS	36 x 12 x 29	66	9.5	\$750	\$114
PN3652BLS	36 x 12 x 52	109	16.75	\$861	N/A
PN3666BLS	36 x 12 x 66	133	21	\$945	N/A

66"H models have four adjustable shelves. 52"H models have 3 adjustable shelves. 29"H models have 1 adjustable shelf. HP laminate is only available on 29"H models. Shipped assembled in 1 carton.

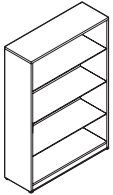

Bookshelf w/Glass Shelves*

PN2429BGS	24 x 12 x 29	54	7.1	\$647	\$98
PN2452BGS	24 x 12 x 52	98	13.3	\$962	N/A
PN2466BGS	24 x 12 x 66	121	16.9	\$1142	N/A
PN3029BGS	30 x 12 x 29	63	8.73	\$747	\$114
PN3052BGS	30 x 12 x 52	112	16.2	\$1032	N/A
PN3066BGS	30 x 12 x 66	140	20.2	\$1192	N/A
PN3629BGS	36 x 12 x 29	72	10.5	\$746	\$114
PN3652BGS	36 x 12 x 52	128	16.75	\$1127	N/A
PN3666BGS	36 x 12 x 66	156	24.4	\$1321	N/A

66"H models have four adjustable shelves. 52"H models have 3 adjustable shelves. 29"H models have 1 adjustable shelf. HP laminate is only available on 29"H models. Shipped assembled in 2 carton.

DESKTOP AND OVERHEAD STORAGE

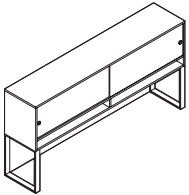

Hutch w/Laminate Doors**

PN3560LCH	60 x 16 x 35	215	24.5	\$1592	N/A
PN3572LCH	72 x 16 x 35	242	29.5	\$1646	N/A
PN3584LCH	84 x 16 x 35	266	34	\$1766	N/A

Sliding laminate doors in upper plastic track. Recessed brushed aluminum finger pulls. No lock. Laminate back board. 15.75" clearance between worksurface and underside. Shipped partially assembled in 1 carton.

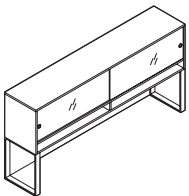

Hutch w/Glass Doors**

PN3560CH	60 x 16 x 35	223	25.8	\$2312	N/A
PN3572CH	72 x 16 x 35	249	31	\$2485	N/A
PN3584CH	84 x 16 x 35	271	35.7	\$2729	N/A

Sliding glass doors in upper aluminum track. Acid etched 6mm glass. Brushed aluminum finger pulls. No lock. Laminate back board. 15.75" clearance between worksurface and underside. Shipped partially assembled in 2 cartons (glass doors shipped separately).

Required specifications

Top finish
Base finish
Door finish (PN35xxLCH and PN11xxLDS only)
Hutch support**

Optional specifications

HP laminate (29"H only)*

DESKTOP AND OVERHEAD STORAGE **MODEL #** **DIMENSIONS** **WT/LB.** **CUBIC FT.** **LIST PRICE**

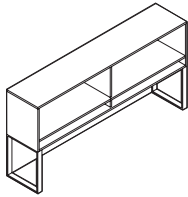

Open Hutch**

	W x D x H			
PN3560CHO	60 x 16 x 35	201	24.5	\$1390
PN3572CHO	72 x 16 x 35	224	29.5	\$1431
PN3584CHO	84 x 16 x 35	246	34	\$1543

Laminate back board. 15.75" clearance between worksurface and underside. Shipped partially assembled in 1 carton.

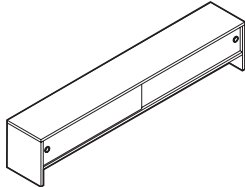

Desktop Storage w/Laminate Doors

PN1160LDS	60 x 11 x 12	58	7	\$831
PN1172LDS	72 x 11 x 12	68	8.5	\$898

Sliding laminate doors in upper plastic track. Recessed brushed aluminum finger pulls. No lock. Shipped assembled in 1 carton.

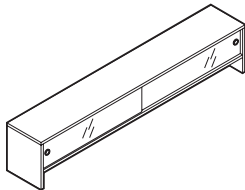

Desktop Storage w/Glass Doors

PN1160DS	60 x 11 x 12	62.5	7.8	\$1340
PN1172DS	72 x 11 x 12	74	9.4	\$1512

Sliding glass doors in upper aluminum track. Acid etched 6mm glass. Recessed aluminum finger pulls. No lock. Shipped assembled in 2 cartons (glass doors shipped separately).

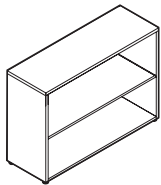

Desktop Shelf - Two High w/Laminate Shelf

PN2423LDB	24 x 12 x 23	43	5.5	\$394
PN3023LDB	30 x 12 x 23	51	6.75	\$429
PN3623LDB	36 x 12 x 23	58	8	\$434
PN2425LDB	24 x 12 x 25	45	6	\$394
PN3025LDB	30 x 12 x 25	53	7.25	\$429
PN3625LDB	36 x 12 x 25	60	8.75	\$434

One multiple-position adjustable **laminate** shelf. Shipped assembled in 1 carton.

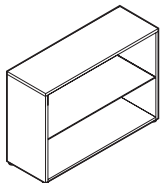

Desktop Shelf - Two High w/Glass Shelf

PN2423GDB	24 x 12 x 23	48	6.25	\$452
PN3023GDB	30 x 12 x 23	56	7.5	\$496
PN3623GDB	36 x 12 x 23	64	9	\$526
PN2425GDB	24 x 12 x 25	50	6.75	\$452
PN3025GDB	30 x 12 x 25	58	8.25	\$496
PN3625GDB	36 x 12 x 25	67	9.75	\$526

One multiple-position adjustable **glass** shelf. Shipped assembled in 2 cartons.

Required specifications

Top finish
Base finish

DESKTOP AND OVERHEAD STORAGE

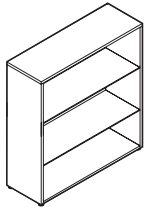

Desktop Shelf - Three High w/Laminate Shelves

MODEL #	DIMENSIONS W x D x H	WT/LB.	CUBIC FT.	LIST PRICE
PN2437LDB	24 x 12 x 37	62	8.5	\$491
PN3037LDB	30 x 12 x 37	72	10.5	\$522
PN3637LDB	36 x 12 x 37	83	12.25	\$543
PN2439LDB	24 x 12 x 39	64	9	\$515
PN3039LDB	30 x 12 x 39	75	11	\$545
PN3639LDB	36 x 12 x 39	85	13	\$569

Two multiple-position adjustable **laminate** shelves. Shipped assembled in 1 carton.

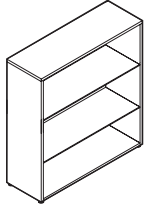

Desktop Shelf - Three High w/Glass Shelves

PN2437GDB	24 x 12 x 37	72	9.75	\$633
PN3037GDB	30 x 12 x 37	83	12	\$703
PN3637GDB	36 x 12 x 37	95	14	\$731
PN2439GDB	24 x 12 x 39	74	10.25	\$633
PN3039GDB	30 x 12 x 39	85	12.5	\$703
PN3639GDB	36 x 12 x 39	98	14.75	\$731

Two multiple-position adjustable **glass** shelves. Shipped assembled in 3 carton.

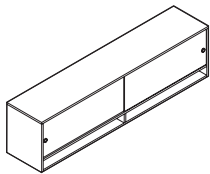

Large Overhead Storage w/Laminate Doors, Wall-Mounted*

PN1960LWH	60 x 16 x 19	121	14	\$1173
PN1972LWH	72 x 16 x 19	141	16.5	\$1227
PN1984LWH	84 x 16 x 19	160	19	\$1347

Sliding laminate doors in upper plastic track. Recessed brushed aluminum finger pulls. No lock. Shipped assembled in 1 carton.

• **NOTE:** Care should be taken to mount the units. Units should be mounted to wall studs using correct fasteners. Failure to do so may result in collapse of the unit and subsequent personal injury. **Mounting hardware not included.** Mounting hardware used should be based on wall material. Consult an installation professional for proper wall mounting.

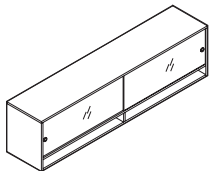

Large Overhead Storage w/Glass Doors Wall-Mounted

PN1960WH	60 x 16 x 19	127.5	15.3	\$1829
PN1972WH	72 x 16 x 19	148	18	\$2054
PN1984WH	84 x 16 x 19	168	20.7	\$2250

Sliding glass doors in upper aluminum track. Acid etched 6mm glass. Brushed aluminum finger pulls. No lock. Shipped assembled in 2 cartons (glass doors shipped separately).

• **NOTE:** Care should be taken to mount the units. Units should be mounted to wall studs using correct fasteners. Failure to do so may result in collapse of the unit and subsequent personal injury. **Mounting hardware not included.** Mounting hardware used should be based on wall material. Consult an installation professional for proper wall mounting.

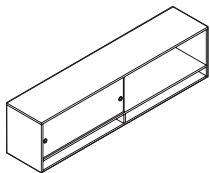

Large Overhead Storage w/Single Laminate Door, Wall-Mounted*

PN1960LS	60 x 16 x 19	115	14	\$1089
PN1972LS	72 x 16 x 19	132	16.5	\$1146
PN1984LS	84 x 16 x 19	150	19	\$1259

Sliding laminate door in upper plastic track. Recessed brushed aluminum finger pulls. No lock. Shipped assembled in 1 carton.

• **NOTE:** Care should be taken to mount the units. Units should be mounted to wall studs using correct fasteners. Failure to do so may result in collapse of the unit and subsequent personal injury. **Mounting hardware not included.** Mounting hardware used should be based on wall material. Consult an installation professional for proper wall mounting.

Required specifications

- Top finish
- Base finish
- Door finish*

DESKTOP AND OVERHEAD STORAGE **MODEL #** **DIMENSIONS** **WT/LB.** **CUBIC FT.** **LIST PRICE**

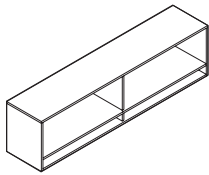

Large Overhead Storage, Wall-Mounted

	W x D x H			
PN1960WHO	60 x 16 x 19	107	14	\$987
PN1972WHO	72 x 16 x 19	123	16.5	\$1028
PN1984WHO	84 x 16 x 19	140	19	\$1140

Open storage with center divider. Shipped assembled in 1 carton.

• **NOTE:** Care should be taken to mount the units. Units should be mounted to wall studs using correct fasteners. Failure to do so may result in collapse of the unit and subsequent personal injury. **Mounting hardware not included.** Mounting hardware used should be based on wall material. Consult an installation professional for proper wall mounting.

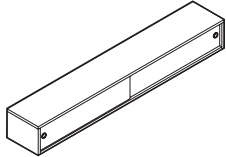

Small Overhead Storage w/Laminate Doors, Wall-Mounted*

PN1260LWH	60 x 12 x 8	59	5.25	\$861
PN1272LWH	72 x 12 x 8	69	6	\$932
PN1284LWH	84 x 12 x 8	79	7	\$979

Sliding laminate doors in upper plastic track. Recessed brushed aluminum finger pulls. No lock. Shipped assembled in 1 carton.

• **NOTE:** Care should be taken to mount the units. Units should be mounted to wall studs using correct fasteners. Failure to do so may result in collapse of the unit and subsequent personal injury. **Mounting hardware not included.** Mounting hardware used should be based on wall material. Consult an installation professional for proper wall mounting.

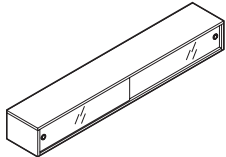

Small Overhead Storage w/Glass Doors, Wall-Mounted

PN1260WH	60 x 12 x 8	63.5	6.1	\$1683
PN1272WH	72 x 12 x 8	74	6.9	\$1898
PN1284WH	84 x 12 x 8	85	8	\$2005

Sliding glass doors in upper aluminum track. Acid etched 6mm glass. Brushed aluminum finger pulls. No lock. Shipped assembled in 2 cartons (glass doors shipped separately).

• **NOTE:** Care should be taken to mount the units. Units should be mounted to wall studs using correct fasteners. Failure to do so may result in collapse of the unit and subsequent personal injury. **Mounting hardware not included.** Mounting hardware used should be based on wall material. Consult an installation professional for proper wall mounting.

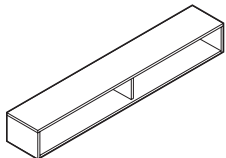

Small Overhead Storage, Wall-Mounted*

PN1260WHO	60 x 12 x 8	52	5.25	\$658
PN1272WHO	72 x 12 x 8	61	6	\$740
PN1284WHO	84 x 12 x 8	70	7	\$804

Open storage shelf with center divider. Shipped assembled in 1 carton.

• **NOTE:** Care should be taken to mount the units. Units should be mounted to wall studs using correct fasteners. Failure to do so may result in collapse of the unit and subsequent personal injury. **Mounting hardware not included.** Mounting hardware used should be based on wall material. Consult an installation professional for proper wall mounting.

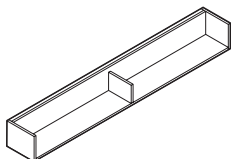

Wall-Mounted Shelf**

PN1260WHS	60 x 12 x 8	40	5.25	\$487
PN1272WHS	72 x 12 x 8	46	6	\$529
PN1284WHS	84 x 12 x 8	53	7	\$570

Open storage shelf with center divider. Shipped assembled in 1 carton.

• **NOTE:** Care should be taken to mount the units. Units should be mounted to wall studs using correct fasteners. Failure to do so may result in collapse of the unit and subsequent personal injury. **Mounting hardware not included.** Mounting hardware used should be based on wall material. Consult an installation professional for proper wall mounting.

Required specifications

- Top finish
- Base finish
- Door finish*

TACKBOARDS FOR HUTCHES

NOTES: Tackboards can be upholstered in all of the following fabrics:

- Anchorage
- Global seating fabrics*
- Lola
- Merge

* Contact Customer Service for pricing.

TACKBOARDS FOR HUTCHES

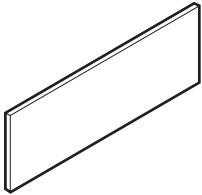

Tackboard for Hutches*

MODEL #	DIMENSIONS W x D x H	WT/LB.	CUBIC FT.	LIST PRICE
PN1556TBH	56 x 1 x 14.5	8.2	1	\$403
PN1562TBH	62 x 1 x 14.5	7.75	1	\$409
PN1568TBH	68 x 1 x 14.5	11	1	\$416
PN1574TBH	74 x 1 x 14.5	9	1.5	\$532
PN1580TBH	80 x 1 x 14.5	10	1.5	\$561

Attaches to hutch backboard with Velcro.

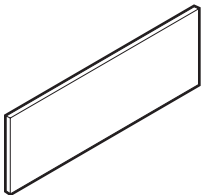

Tackboard for Wall Mounted Overhead storage*

PN1560TBW	60 x 1 x 14.5	10	1	\$434
PN1566TBW	66 x 1 x 14.5	12	1	\$459
PN1572TBW	72 x 1 x 14.5	12.5	1	\$483
PN1578TBW	78 x 1 x 14.5	14	1.5	\$583
PN1584TBW	84 x 1 x 14.5	15	1.5	\$638

Attaches with adhesive backed Velcro.

ELECTRICAL / DATA

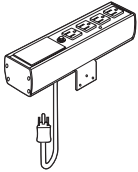

4 Outlet, 1 Telecom Blank Plate

PGDPS41	10.25 x 2.5 x 2.22	2.9	0.7	\$304
---------	--------------------	-----	-----	--------------

4 power receptacles and 1 telecom blank plate. Available for mounting behind pull-out shelf or open space credenza. Tungsten (TN) finish. 12 foot Black cord.

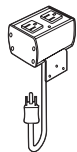

2 Outlet Power Block

PGDPS20	3.58 x 2.5 x 2.22	2.5	0.7	\$217
---------	-------------------	-----	-----	--------------

2 power receptacles. Available for side mounted installation. Tungsten (TN) finish. 12 foot Black cord.

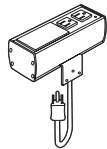

2 Outlet, 1 Telecom Blank Plate

PGDPS21	6.75 x 2.5 x 2.22	2.7	0.7	\$280
---------	-------------------	-----	-----	--------------

2 power receptacles and 1 telecom blank plate. Available for side mounted installation. Tungsten (TN) finish. 12 foot Black cord.

Required specifications

Textile*

ACCESSORIES **MODEL #** **DIMENSIONS** **WT/LB.** **CUBIC FT.** **LIST PRICE**

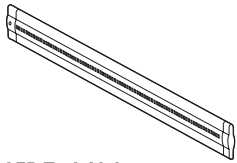

LED Task Light

	W x D x H				
PLED30	15.5 x 1.5	x 0.5	2	0.5	\$344
PLED50	23.5 x 1.5	x 0.5	2	0.5	\$396
PLED100	43.5 x 1.5	x 0.5	3	0.5	\$461

Energy efficient LED. Ultra slim design. Suitable for hanging under hutch or wallhung units.

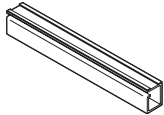

Wire Manager

PEWM5.5	66 x 2	x 2	0.6	0.1	\$136
PEWM5	60 x 2	x 2	0.6	0.1	\$114
PEWM4.5	54 x 2	x 2	0.5	0.1	\$103
PEWM4	48 x 2	x 2	0.5	0.1	\$89
PEWM3.5	42 x 2	x 2	0.4	0.1	\$80
PEWM3	36 x 2	x 2	0.4	0.1	\$70
PEWM2.5	30 x 2	x 2	0.3	0.1	\$55
PEWM2	24 x 2	x 2	0.3	0.1	\$46
PEWM1.5	18 x 2	x 2	0.2	0.1	\$34
PEWM1	12 x 2	x 2	0.2	0.1	\$25

Plastic tray flexes to receive and hold electrical and data wires. Quickly attaches with two strips of double-sided tape. Black only.

29" H TABLES

MODEL #	DIMENSIONS	WT/LB.	CUBIC FT.	LIST PRICE	HP ADD
	W x D x H				
PN242429	24 x 24 x 29	60	4.75	\$817	\$124
PN482429	48 x 24 x 29	77	5.75	\$871	\$133
PN542429	54 x 24 x 29	89	7.75	\$1035	\$156
PN602429	60 x 24 x 29	94	8.25	\$1055	\$160
PN662429	66 x 24 x 29	99	8.5	\$1077	\$165
PN722429	72 x 24 x 29	104	9	\$1083	\$166
PN782429	78 x 24 x 29	111	9.5	\$1188	\$180
PN842429	84 x 24 x 29	115	9.75	\$1284	\$195
PN902429	90 x 24 x 29	121	10.25	\$1347	\$205
PN962429	96 x 24 x 29	126	10.75	\$1398	\$211
PN303029	30 x 30 x 29	73	6	\$902	\$138
PN483029	48 x 30 x 29	89	7	\$959	\$147
PN543029	54 x 30 x 29	102	9.25	\$1129	\$173
PN603029	60 x 30 x 29	108	9.75	\$1137	\$174
PN663029	66 x 30 x 29	114	10.25	\$1169	\$177
PN723029	72 x 30 x 29	121	10.75	\$1188	\$180
PN783029	78 x 30 x 29	127	11.25	\$1299	\$197
PN843029	84 x 30 x 29	133	11.75	\$1394	\$211
PN903029	90 x 30 x 29	140	12.25	\$1457	\$223
PN963029	96 x 30 x 29	146	12.75	\$1493	\$228
PN363629	36 x 36 x 29	88	7.5	\$957	\$147
PN603629	60 x 36 x 29	128	11.5	\$1305	\$200
PN663629	66 x 36 x 29	136	12.25	\$1347	\$205
PN723629	72 x 36 x 29	144	12.75	\$1369	\$208
PN783629	78 x 36 x 29	152	13.25	\$1350	\$205
PN843629	84 x 36 x 29	160	13.75	\$1446	\$219
PN903629	90 x 36 x 29	168	14.5	\$1553	\$234
PN963629	96 x 36 x 29	176	15	\$1567	\$238
PN424229	42 x 42 x 29	107	11	\$1106	\$168
PN604229	60 x 42 x 29	142	13.25	\$1365	\$208
PN664229	66 x 42 x 29	151	14	\$1407	\$214
PN724229	72 x 42 x 29	160	14.5	\$1436	\$218
PN784229	78 x 42 x 29	169	14.75	\$1597	\$243
PN844229	84 x 42 x 29	178	15.5	\$1740	\$265
PN904229	90 x 42 x 29	235	22.5	\$1867	\$285
PN964229	96 x 42 x 29	239	23.5	\$1902	\$289
PN484829	48 x 48 x 29	124	10.75	\$1139	\$174
PN604829	60 x 48 x 29	156	15	\$1414	\$215
PN664829	66 x 48 x 29	164	15.75	\$1462	\$223
PN724829	72 x 48 x 29	176	16.5	\$1484	\$226
PN784829	78 x 48 x 29	186	17.25	\$1677	\$256
PN844829	84 x 48 x 29	196	17.75	\$1821	\$276
PN904829	90 x 48 x 29	257	25.25	\$1946	\$296
PN964829	96 x 48 x 29	202	26.5	\$1975	\$300

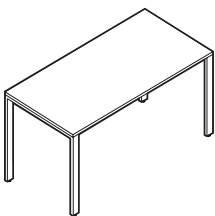

29" H Table

Freestanding. 1" x 2.5" open metal frame legs with levelers. Metal support hat channel(s) provided on tables exceeding 54" in width. Shipped easy to assemble in 2 cartons.

Required specifications

Top finish
Leg finish

Optional specifications

HP laminate

29" H TABLES WITH CENTER LEGS

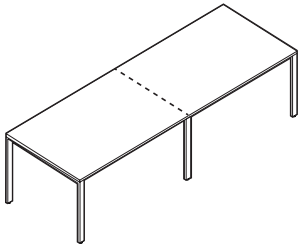

29" H Table with Center Leg

MODEL #	DIMENSIONS	WT/LB.	CUBIC FT.	LIST PRICE	HP ADD
---------	------------	--------	-----------	------------	--------

W x D x H

PN1203629	120 x 36 x 29	234	27	\$2390	\$366
PN1443629	144 x 36 x 29	265	29.25	\$2532	\$385
PN1204229	120 x 42 x 29	260	31	\$2485	\$379
PN1444229	144 x 42 x 29	296	33.75	\$2621	\$399
PN1204829	120 x 48 x 29	286	35.25	\$2633	\$400
PN1444829	144 x 48 x 29	326	38	\$2768	\$423

Freestanding. 1" x 2.5" open metal frame legs with levelers. 120" and 144" wide with 2 piece top. Metal support hat channel(s) provided on tables exceeding 54" in width. Shipped easy to assemble in 4 cartons.

29" H TABLES WITH CASTERS

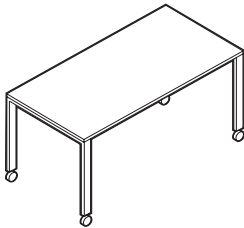

29" H Table with Casters

PN242429C	24 x 24 x 29	58	4.75	\$844	\$128
PN482429C	48 x 24 x 29	76	5.75	\$897	\$136
PN542429C	54 x 24 x 29	88	7.75	\$1073	\$165
PN602429C	60 x 24 x 29	93	8.25	\$1093	\$167
PN662429C	66 x 24 x 29	98	8.5	\$1112	\$169
PN722429C	72 x 24 x 29	104	9	\$1133	\$173
PN303029C	30 x 30 x 29	71	6	\$929	\$141
PN483029C	48 x 30 x 29	88	7	\$983	\$151
PN543029C	54 x 30 x 29	101	9.25	\$1167	\$177
PN603029C	60 x 30 x 29	107	9.75	\$1177	\$179
PN663029C	66 x 30 x 29	113	10.25	\$1202	\$183
PN723029C	72 x 30 x 29	119	10.75	\$1243	\$190
PN363629C	36 x 36 x 29	86	7.5	\$977	\$149
PN603629C	60 x 36 x 29	127	11.5	\$1233	\$189
PN663629C	66 x 36 x 29	135	12.25	\$1262	\$193
PN723629C	72 x 36 x 29	143	12.75	\$1446	\$219
PN424229C	42 x 42 x 29	105	11	\$1130	\$173
PN484829C	48 x 48 x 29	123	10.75	\$1169	\$177

Freestanding. 1" x 2.5" open metal frame legs with casters. All casters are locking. Metal support hat channel(s) provided on tables exceeding 54" in width. Shipped easy to assemble in 2 cartons.

Required specifications

Top finish
Leg finish

Optional specifications

HP laminate



Zira is a contemporary desking solution with extensive options to personalize your workspace. Components can be freestanding for single workstation configurations, or joined together to form multiple work groups. Create a work environment that meets your worksurface needs and storage requirements - then go ahead and personalize it!

Select from the following: hundreds of components for any office size or shape, storage components that can tower to 84.5" high, 21 laminate finishes, 5 edge options, 9 handle options in Silver, Black, Nickel or Brass finishes, 2 glazing options with 2 frame finishes on doors and modesty panels, and lastly, worksurface grommets and power blocks for your electrical needs.

Zira is your most functional solution to work environment efficiency and organization.



Tops are available in a choice of 1" or 1.5" thick with a variety of edge details and a top over side, edge panel design.

* Shown with 1.5" thick top and bicut edge (CR).



Optional frosted or ribbed glazing on doors and modesty panels. Available with Silver or Black frames.



Collator option is available for the convenient storage of day-to-day documents. Available in Black (BK) or Brushed Cobalt (BC) finish.

Features and Benefits

- 45 lb. density particle board substructure with high performance thermally fused laminate.
- Top over side panel design.
- Worksurfaces feature 2mm edging in matching color.
- Available in 1" or 1.5" thick top with a variety of edge details.
- 11/16" thick full modesty panel is standard.
- 11/16" thick 3/4 modesty panel available on most components.
- Pencil tray included in the box drawer.
- Lateral file drawers can accommodate letter or legal documents.
- Premium full extension progressive ball bearing slides on file drawers and box drawers.
- All drawer fronts edge banded with side pull opening pedestals and standard pedestal locks.
- Compatible with **Divide** partitioning systems for increased privacy and storage requirements.

GENERAL INFORMATION

- Modular collection with over 5000 different standard components available.
- Collection includes elements and options that can deliver a custom millwork feel to any space.
- Handles, lock finish and trim color (if applicable) must match.
- Specification information begins on page 125.
- Dimensionally compatible with the Adaptabilities and Divide series.
- For environmental certification, please visit globalfurnituregroup.com.

WORKSURFACES

- Available in 1" or 1.5" thick thermally fused laminate tops with a variety of edge details.
- Tops are sealed with Global's preferred edge in matching color. Woodgrain surfaces feature edging with matching printed woodgrain.
- High pressure (**HP**) tops are available in all Zira laminate finishes at an extended lead time. Please see model # for pricing and availability.
- Products specified with the HP option are finished on the underside of the surface with a kraft paper backing.

CONSTRUCTION

- Constructed of 45 lb. density particle board with high performance thermally fused laminate.
- All desks are size (incrementally) accurate.
- All desk drawers/storage feature built-in pulls; optional applied pulls are available in 9 different styles.
- Models with monopost are standard with 4" square monopost. Optional 5" round and 4" round monoposts are available at no upcharge. Available in Black (**TBL**) or Tungsten (**TTU**) finish, please specify.
- Leveling glides are standard on all floor units.
- Premium full extension progressive ball bearing slides on file drawers & box drawers.
- All drawer fronts are edge banded with side pull opening pedestals and standard pedestal locks.

HEIGHT ADJUSTABLE DESKS

- Zira height adjustable desks include a laminate chassis. **Height adjustable base mechanism to be ordered separately.**
- Use **FTZ52SFNL** with all **ZHxx60Fxx**, **ZHxx66Fxx**, **ZHxx72Fxx** and **ZHxx60NP** models.
- Use **FTZ52LFNL** with all **ZHxx84Fxx**, **ZHxx66NP**, **ZHxx72NP** and **ZHxx84NP** models.
- Use **FTZ539FSLNL** with all **ZH60xx24L/R** models.
- Steel constructed Kick & Click™ top frame with soft start/stop technology.
- Table frame designed with 50mm x 80mm rectangular outer leg with the larger tube attaching to a bracket within the pedestal.
- Control box ensures optimal parallel drive and low noise level (<55dB(a) in typical applications)
- Powder coat finish for base is available in Black (**BLK**) or Tungsten (**TUN**), specify finish.
- Wire management channels available in Black (**BK**) or Silver (**SI**). Silver (**SI**) complements Tungsten.
- Zira height adjustable desks have 2 stages and feature an adjustment range of 29.5"/30" - 49.2"/49.7".
- Lift capacity of 300 lbs.
- Operates at 1.5" per second.
- Power rate 18V Max.10.0A.
- Each lifting column is equipped with a motor and parallel/memory drive.

HANDSET

- Standard up/down handset (**SH**) with two memory positions. No digital readout. Diode stand reminder. Bluetooth compatible with FreeFit's Desk Control™ App. Black only.
- Handset with digital readout and four programmable settings is optional, Bluetooth compatible, stand reminder light bar, specify Digital readout handset (**DH**). **Add \$66.** Silver only.



Standard handset (**SH**)



Digital readout handset (**DH**)

MODESTY PANELS

- Laminate full modesty panel is standard. Laminate ¾ modesty panel is available on select models at no additional charge. Please specify (**34**).
- Glazing options are available on both the full modesty panel and ¾ modesty panel, please specify. See next page for options and codes.
- 11/16" thick full modesty panel is standard.
- 11/16" thick ¾ modesty panel available on most components.
- **Note:** Woodgrain modesty panels over 60" wide will have the grain pattern in the horizontal direction. All end panels and modesty panels 60" or less will have the grain pattern in the vertical direction.

STORAGE

- All lateral files feature a foolproof interlock device.
- Pencil tray included in box drawer.
- Lateral file drawers can accommodate letter or legal documents.
- All drawers are locking unless otherwise noted.
- Front-to-back filing bars for all steel drawer files available separately. Order FBB bars. See Metal Filing + Storage price list page 14 for pricing.
- All desks, returns and credenzas with fixed storage are shipped standard with box/box/file, file/file or box/file 16" wide pedestals.
- Storage modules, wardrobe cabinets, personal towers, hutches and table top bookcases have $\frac{11}{16}$ " thick shelves.
- End shelves, bookcases and table top end shelves have 1" thick shelves.
- **All shelves are 3 position fixed/height adjustable.**
- Storage cabinets less than **30" wide are not intended to be freestanding** and should be ganged or anchored. Specific units indicating counterweight included do not require ganging. Ganging hardware and instructions are provided. Interior of all cabinets are pre-drilled for ganging connections; drill through on site is required.
- Adjustable shelves can be positioned to accept **binder** storage as follows:
For **29" to 53"H** units where applicable:
 - with one shelf - cannot accommodate binder row
 - with two shelves - can accommodate one row of binders
 - with three shelves - can accommodate two rows of binders
 - with four shelves - can accommodate three rows of bindersFor **65.5" to 84.5"H** units where applicable:
 - with one shelf - can accommodate one row of binders
 - with two shelves - 65.5" and 72" H can accommodate one row of binders
84" H can accommodate two rows of binders
 - with three shelves - can accommodate two rows of binders
 - with four shelves - can accommodate three rows of binders
 - with five shelves - can accommodate four rows of binders
 - with six shelves - can accommodate five rows of binders

LOCKS

- Locks are standard on all storage modules. Finish will coordinate with handles and/or aluminum doors. For desk, return or table components where no handles is default, please specify lock finish: Black (**BK**) or Silver (**SI**).
- Optional key alike or specific key number for all products with locks.
- Reserved for new orders greater than \$20,000 list, all Zira units with locks can be ordered with a cap option (**CA**) under the lock option and specific lock cores/keys can be ordered separately for field installation rather than specifying duplicate product lines with different key numbers.
- When **CA** option is specified, units will ship with a cap over the empty lock housing.
- Order the appropriate number of cores with keys separately: use product code **SIL-CORE-H-SHOE** for Silver core/key sets, **BLK-CORE-H-SHOE** for Black core/key sets. Specify quantity and lock number required (one order per line per key number required). Key number range: 401 to 440. Must be ordered at the same time the product is ordered with a lock cap option (**CA**) specified.
- Also require one core removal key, recommend one core removal per every 25 cores ordered, order product code **REMOVE-K-H-SHOE**.
- No charge applies for separate lock cores or core removal keys only when ordered with the product. If replacement lock core and key required, contact Customer Service for applicable product code and pricing.

SHIPPING

- Shipped assembled, 1 per carton, unless otherwise noted. Other components are easy to assemble.

SPECIAL SIZES

- Special widths are available on most products with open knee space. To price, take the list price of the next larger standard size up and add **5%**. Quotations are not required, some exceptions may apply.
- For custom widths outside of the range of standard sizes published or any custom depths, submit a SPECIALS / MTM quote request through the Global Dealer Centre.
- Orders must indicate the custom quote number and list price.
- Changes to custom quotes are not permitted. Any revisions will necessitate a new quotation.

HUTCHES

- 71" wide hutches (actual width 71.69") are for use when a hutch is placed across the back of a 42" wide return and across the depth of a 30" deep surface top (actual depth 29.69").

SPECIFICATIONS

- Specifications marked with an * are applicable to only those products which have the * symbol beside the product name.

1. SPECIFY MODEL NUMBER

2. SPECIFY FINISH AND TOP THICKNESS/EDGE DETAIL

- All units available in solid color (top and chassis matching) or two-tone combination except for the following units:
 - Shells: one tone in all standard finishes.
 - Collators: one tone in Black (BK) or Brushed Cobalt (BC).
 - Horizontal pigeon holes: one tone in all standard finishes.
 - Vertical and transitional pigeon holes: two-tone - chassis/shell in all standard finishes, collator shelves in Black (BK) or Brushed Cobalt (BC).

Finishes:

ACJ Absolute Acajou	FCL First Class
ASN Asian Night	NBL Noce Biondo
AWC Avant Cherry	NGL Noce Grigio
AWH Avant Honey	NEL Noce Leggero
BLK Black	NML Noce Medio
BZD Blizzard	QTM Quartered Mahogany
BRC Brushed Cobalt	SBY Sheer Beauty
CMB Clear Maple	SDT Stonedust
CGY Custom Grey	SOG Storm Grey
DES Dark Espresso	WHE Walnut Heights
DWT Designer White	WHC White Chocolate
FAS Fashionista	WCR Winter Cherry

Top Thickness / Edge Detail:

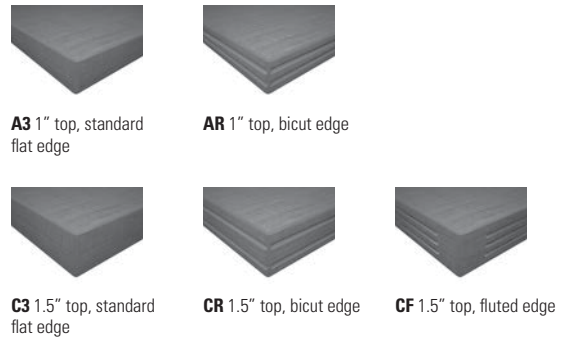

3. SPECIFY OPTIONS

BOX DRAWERS (no upcharge)

- Specify B_ (drawer position 1-4 must be specified)

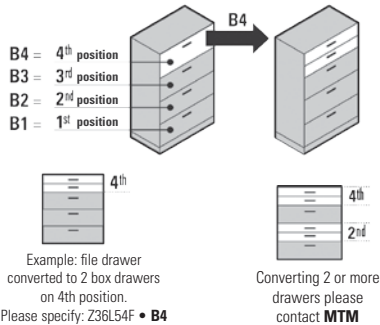

- Not available on drawers with steel interiors

MONOPOST

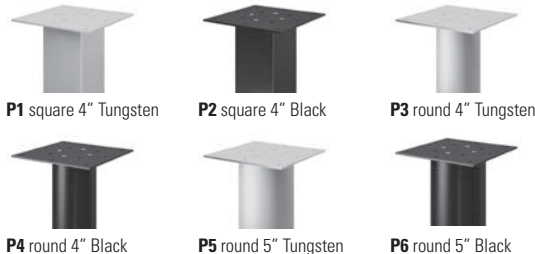

O-LEG DETAIL

- Available in Black (TBL) or Tungsten (TTU).



HANDLES

- Handles are standard on all lateral drawers and doors, and are included in the published list price. When ordering, please select handle from the list of options below.
- Integrated vertical fingers pulls are the standard default for mobile pedestals, hanging pedestals, and where BBF or FF pedestals are part of a desk, return, credenza or corner desk. Handles are optional on these units with a **list price upcharge of \$62**. If a handle is not desired, please specify lock finish: Black (BK) or Silver (SI).
- General guideline: when handles are shown in the individual product lineart within the price list, handles are included. When not shown in the individual product lineart, a **list price upcharge of \$62** applies if a handle option is selected.
- To order handles, please specify corresponding code to image as shown below.



GROMMETS

- Additional grommets available in standard worksurface locations (left, center or right).
- Order as: **FOG1, FOG2** or **FOG3**. **Add \$91**.

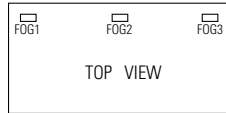
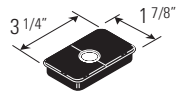

- Grommet hole dimensions are 3.25" wide x 1.875" deep.
- Actual grommet locations on the worksurface are depicted in the example drawings shown below. Dimensions shown are actual measurements (in inches).

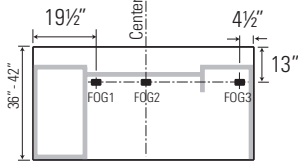

Straight Front

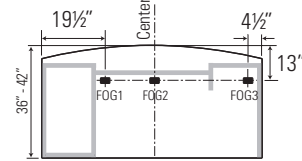

Bow Front

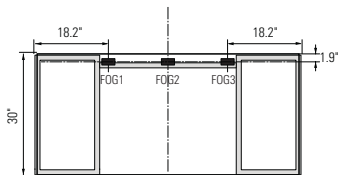

HA Double Ped

Primary top is oversized **0.5" (12.5mm)** in width on both sides to allow for gap to mitigate pinch points.

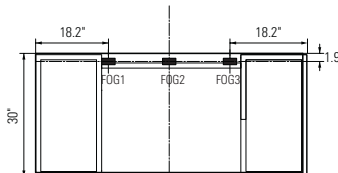
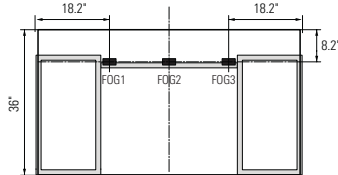

HA Single Ped

Primary top is oversized **1" (25mm)** in width with gap on left or right side depending on hand to allow for gap to mitigate pinch points.

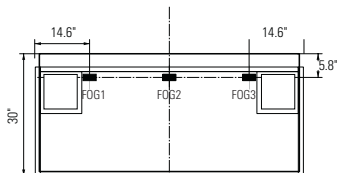
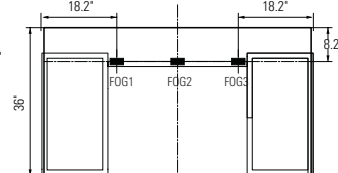

Freestanding HA

Primary top is oversized **1" (25mm)** in width on both sides to allow for gap to mitigate pinch points.

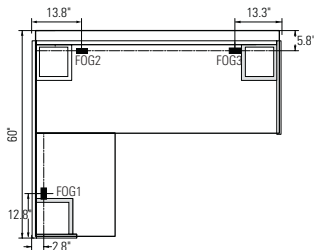

L HA desk

Primary top is oversized **0.9" (24.8mm)** in width on return side and **0.5" (12.5mm)** on ends to allow for gap to mitigate pinch points.

GROMMETS (cont'd)

- Grommets may be placed at non-standard locations (some products excluded). Order as: **CSG**. **Add \$132**. A drawing must be supplied with vertical and horizontal dimensions to the center of the cut-out (as in drawing above). Please refer to the **custom grommet location form** in the back reference section.
- Alternative grommet positions for "D", "P" and rectangular islands not shown in price list line art will require a SPECIALS / MTM quote request.
- Components that come standard with grommet, as stated within the product descriptions or shown in the corresponding price list lineart, may be ordered without a grommet.
- Option to remove standard grommet when required, specify **RSG**. Upcharge applies, **add \$51**.
- Option to remove standard grommet and add one in another position, specify **RSG** + applicable **FOG** position or **CSG**. Upcharge applies:
 - For **RSG + FOGx** combination, **add \$142**.
 - For **RSG + CSG** combination, **add \$183**.
- Option to add an additional grommet in a standard position, specify **FOGx**. Upcharge applies, **Add \$91**. For a customer specified location, specify **CSG**. **Add \$132**.
- Grommets are available on modesty panels of **extended corners** and **5-sided corners** 8" in where the two modesty panels meet at a 90° angle. Please specify **FOGMP-R** for right grommet placement and **FOGMP-L** for left grommet (placement is as shown on diagrams below). Cost is **\$132**.
- Modesty panels are 1" off of ground.

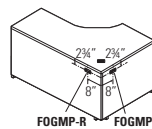

Left extended corner unit

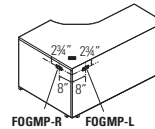

Right extended corner unit

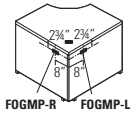

5-sided corner unit

POWER BLOCK

- A power block (model **PMSPPDM**) may be ordered on all worksurfaces.
- A power block is a rectangular worksurface power/data module with one electrical duplex receptacle and two data (RJ45) receptacles. 9 foot Black cord included. Power block dimensions are 6.5"W x 3.5"D x 2.75"H.
- To purchase a power block, you must specify both the power block cut-out location and the power block model #. Order power block as **PMSPPDM**. **Add \$268**. Power blocks are available in standard worksurface locations (left, center or right). Order as **E1, E2** or **E3**. **Add \$91**.

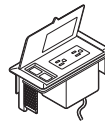

Power block **PMSPPDM**. **Add \$268**.

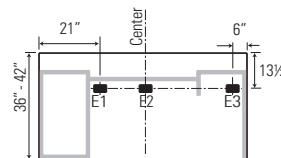

Straight Front

Specify location **E1, E2** or **E3**. **Add \$91**

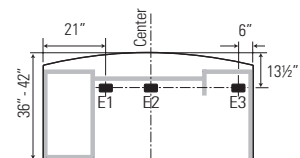

Bow Front

Glazing (Doors and Modesty Panels)



Z1 frosted glazing, Tungsten (TUN) frame



Z2 frosted glazing, Black (BLK) frame



Z3 ribbed glazing, Tungsten (TUN) frame



Z4 ribbed glazing, Black (BLK) frame



Full modesty panel - **Z1** frosted glazing, Tungsten (TUN) frame
 $\frac{3}{4}$ modesty (shown) - **Z1 + 34**



Full modesty panel - **Z2** frosted glazing, Black (BLK) frame
 $\frac{3}{4}$ modesty (shown) - **Z2 + 34**



Full modesty panel - **Z3** ribbed glazing, Tungsten (TUN) frame
 $\frac{3}{4}$ modesty (shown) - **Z3 + 34**



Full modesty panel - **Z4** ribbed glazing, Black (BLK) frame
 $\frac{3}{4}$ modesty (shown) - **Z4 + 34**

Executive Height Adjustable Desks

Available widths: 60", 66", 72", 84"

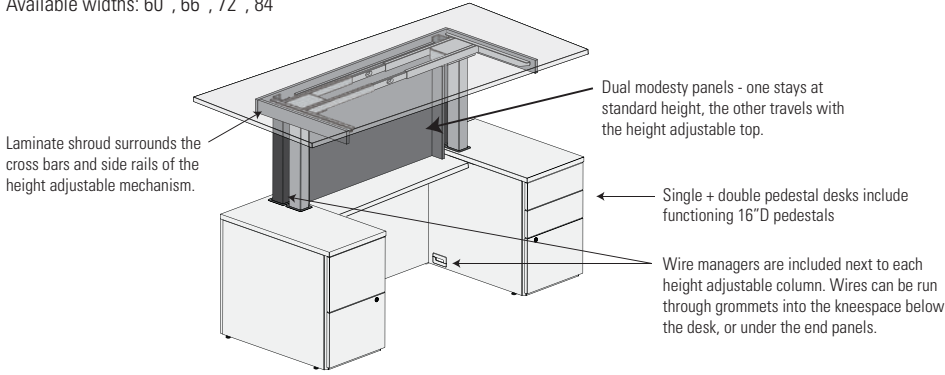

Returns

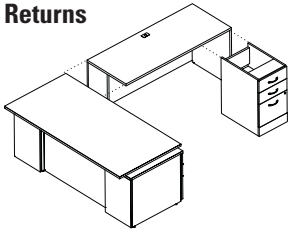

For "L" Shape Layouts

- Pre-configured
- With custom shell storage

Bridges

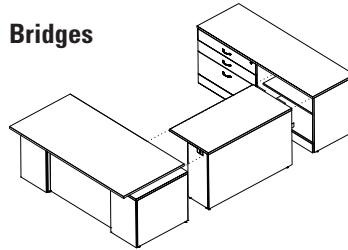

For "U" shape Layouts

Top Conditions for Height Adjustable Desks

Top recesses are to minimize potential pinch points when adjacent to fixed surfaces

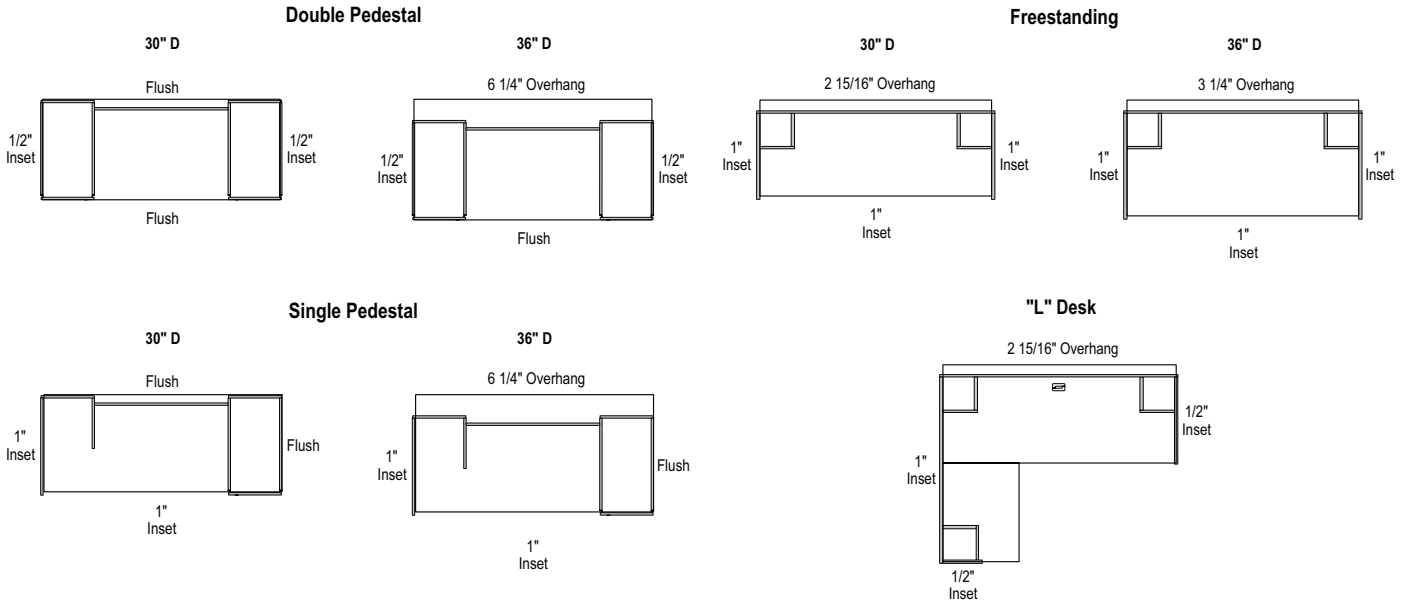

Wall Panels

Grommet locations for wall panels

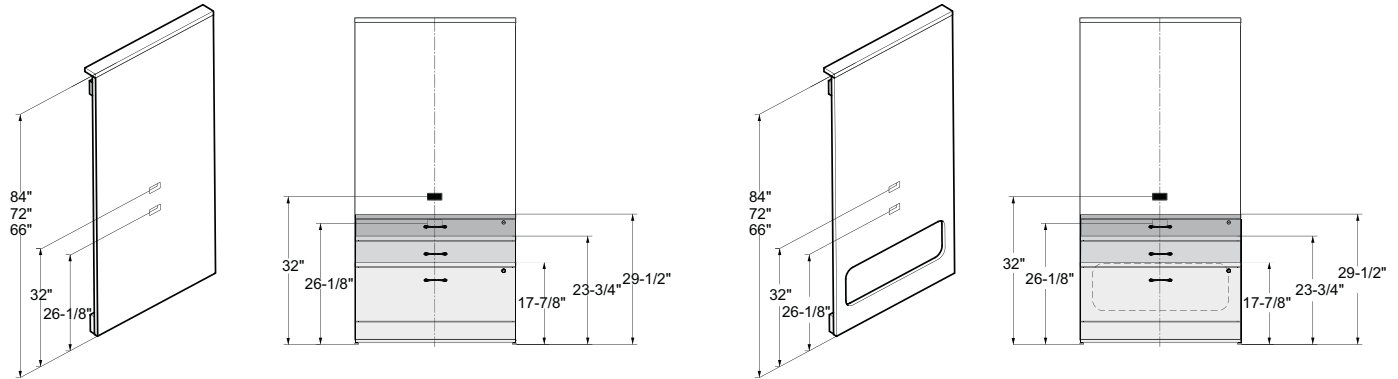

- FOG1 grommet sits at 26 1/8" above the floor, just about 1-1/2 high storage, but below standard 29 1/2" storage
- FOG2 grommet sits at 32" above the floor, above 29 1/2" storage
- When the wall with wire management access is specified, the wire management access opening will sit below all storage heights.

Weight capacities for wall panels

- When mounting customer supplied flat screen or other to a wall panel, total weight including mounting hardware **should not exceed 140 lbs.** in total. Not approved for use with articulating or extendable mounting arms.
- Wall panels with floating shelves: (Note: weight should be evenly distributed over surface)
24"W units up to 50 lbs.; **30"W units** up to 65 lbs.; **36"W units** up to 75 lbs.; **42"W units** up to 90 lbs. per floating shelf.
- Wall panels with overhead cabinet storage: (Note: weight should be evenly distributed over surface)
66"H - 24"W units 30 lbs. top/55 lbs. inside bottom; **30"W units** 40 lbs. top/70 lbs. inside bottom; **36"W units** 45 lbs. top/85 lbs. inside bottom;
42"W units 55 lbs. top/95 lbs. inside bottom.
72"H - 24"W units 30 lbs. top/65 lbs. inside bottom; **30"W units** 40 lbs. top/80 lbs. inside bottom; **36"W units** 50 lbs. top/95 lbs. inside bottom;
42"W units 60 lbs. top/100 lbs. inside bottom.
84"H - 24"W units 30 lbs. top/65 lbs. shelf and inside bottom; **30"W units** 40 lbs. top/80 lbs. shelf and inside bottom; **36"W units** 50 lbs. top/95 lbs. shelf and inside bottom;
42"W units 60 lbs. top/100 lbs. shelf and inside bottom.

Desks / Extended Corner Desks - available width: 60", 66", 72" 84"

Modesty treatments

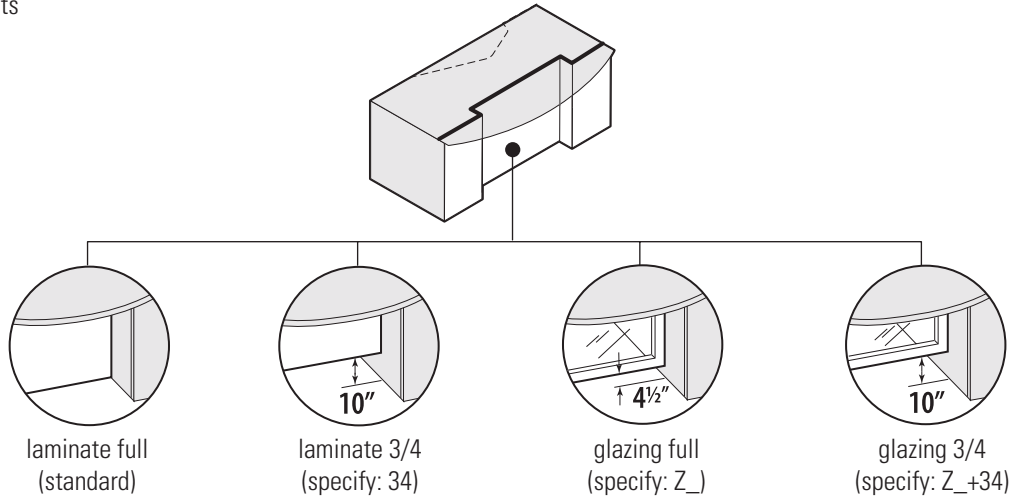

Overhang dimensions

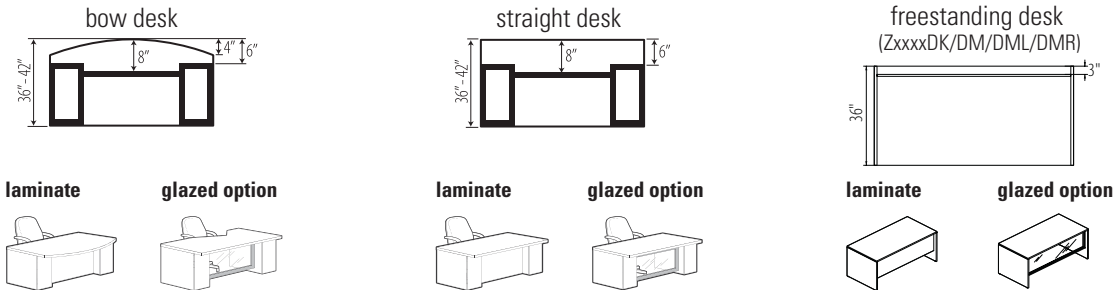

Returns - available width: 36", 42", 48", 54", 60", 66", 72"

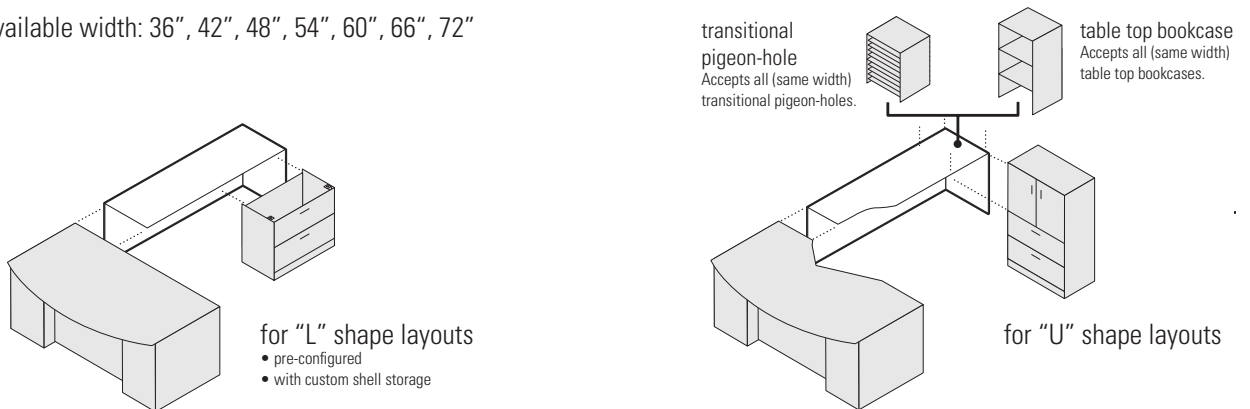

Bridges - available width: 42", 48"

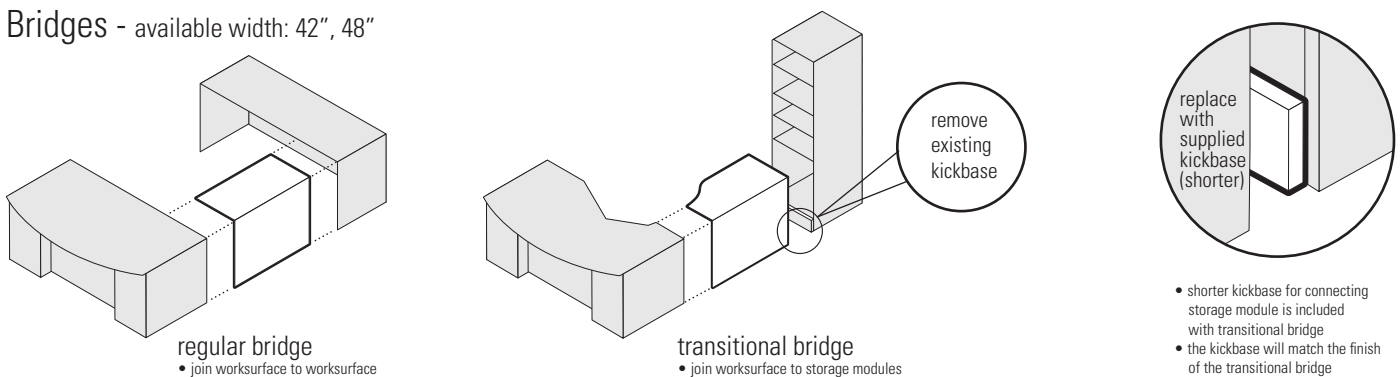

Extended Corners - available widths: 60", 66", 72", 84"

Modesty treatments

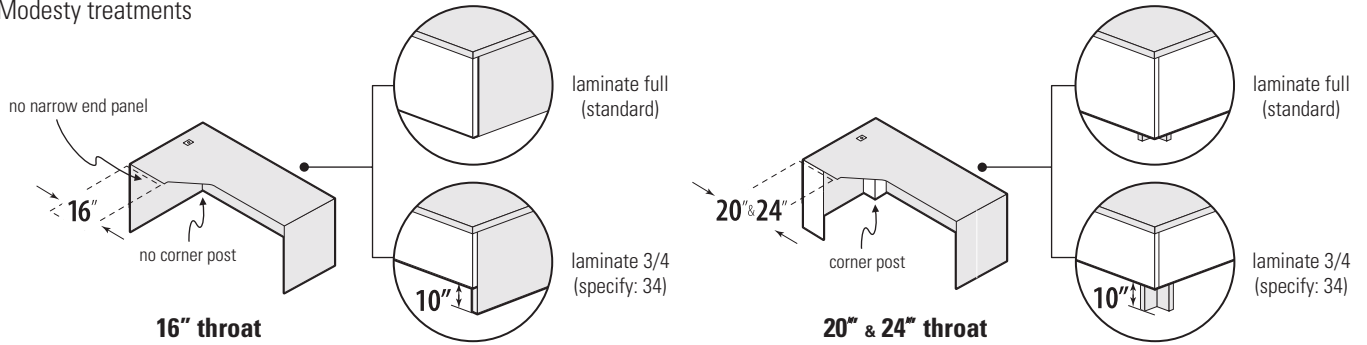

Extended Corner Islands - available width: 60", 66", 72", 84"

Modesty treatments

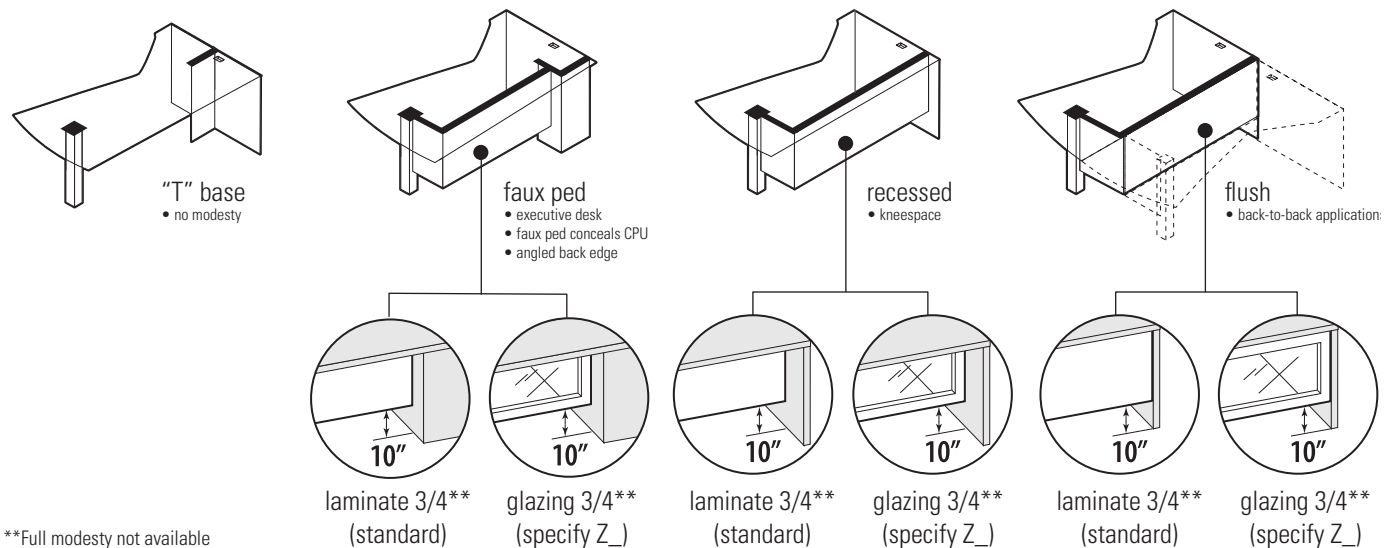

**Full modesty not available

Overhang dimensions



Shells - available width: 12", 15", 16", 18", 21", 30", 36"

For Extended Corners, Space Saver Returns, Space Saver Connectables and Space Saver Bridges

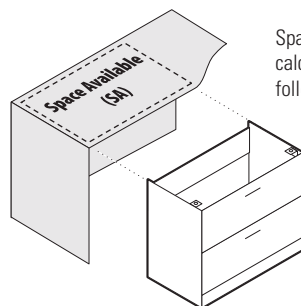

Space available can be calculated with the following formulas:

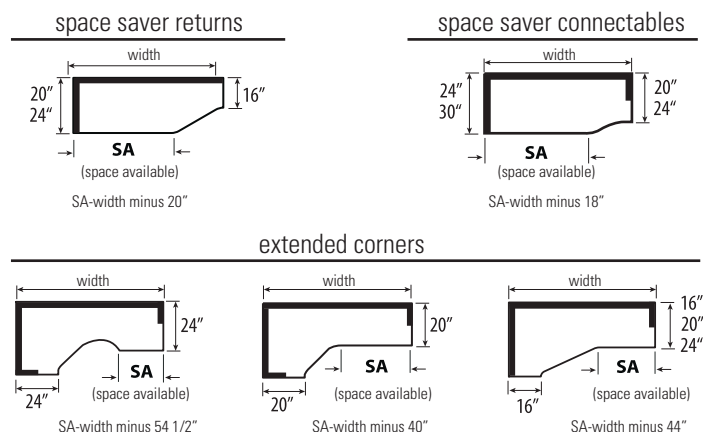

Storage

Closed

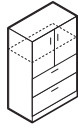

Cavity

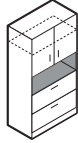

Open

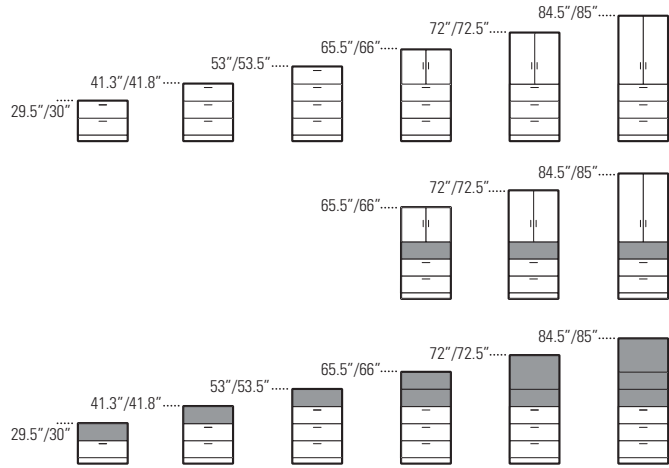
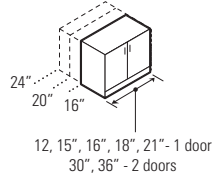
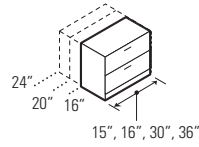
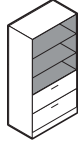

Wardrobe & Personal Towers

Closed

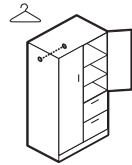

Cavity

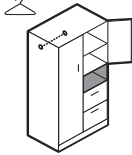

Open

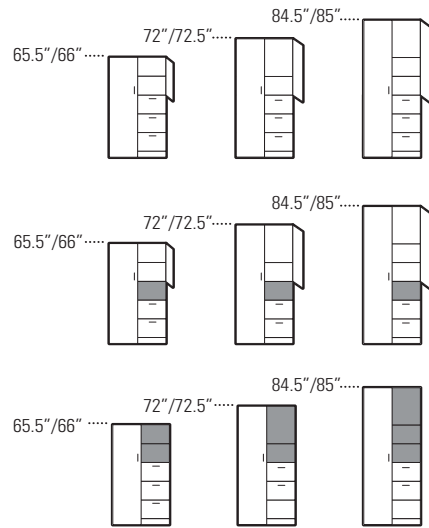
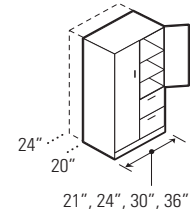
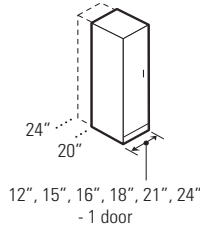
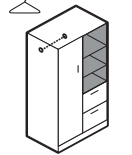

PC Support

PC support

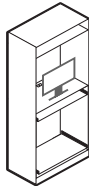

PC support with vertical drawer

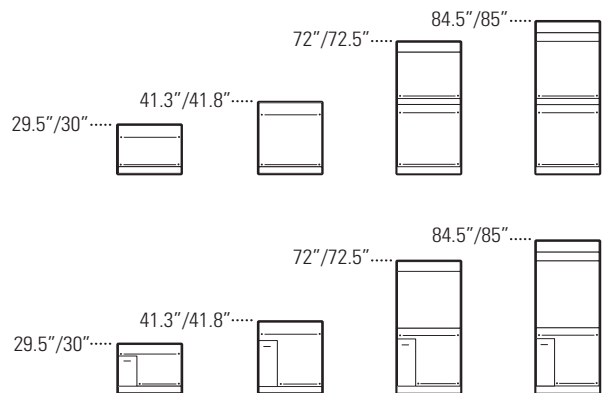
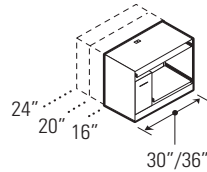
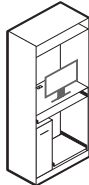

Vertical Utility Drawer

Closed

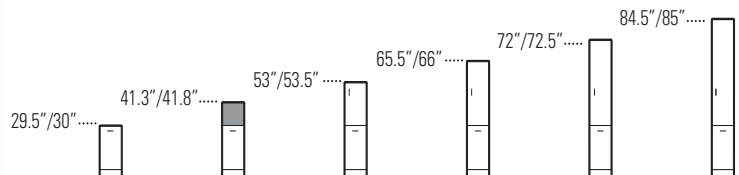
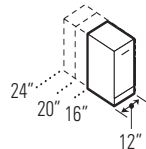
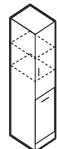

Drawer & Cavity Positions

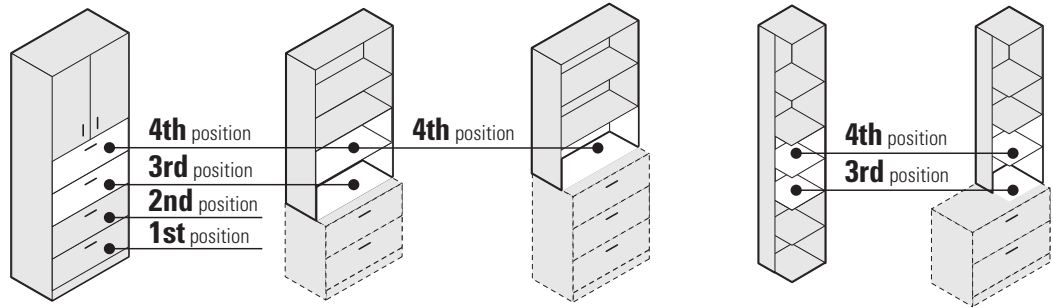

Box Drawer Option

File drawers can be converted to box/box drawers in any of the four standard positions.

- B1 = 2 box drawers on 1st position
- B2 = 2 box drawers on 2nd position
- B3 = 2 box drawers on 3rd position
- B4 = 2 box drawers on 4th position

Not available on drawers with steel interiors.
Not available on credenzas with lateral files.

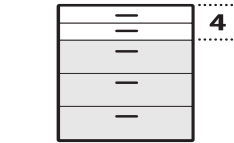
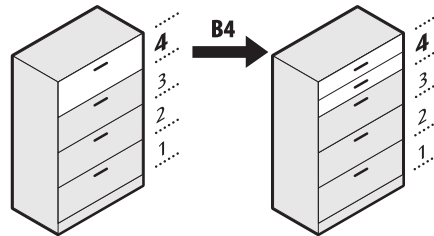

Example:
File drawer converted to 2 box drawers on 4th position.

specify: Z36L54F - B4



Converting 2 or more drawers to box drawers, please contact the Specials Department.

Collator Positions

All storage units can be specified with an optional collator on 2nd, 3rd and/or 4th position

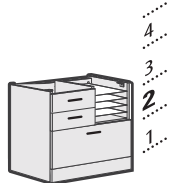

Collator on 2nd position
specify: **2K - Black** or
2T - Brushed Cobalt

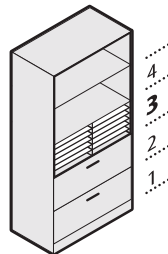

Collator on 3rd position
specify: **3K - Black** or
3T - Brushed Cobalt

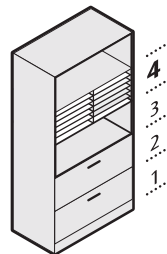

Collator on 4th position
specify: **4K - Black** or
4T - Brushed Cobalt

For 2K / 2T, 3K / 3T or 4K / 4T - add \$200.

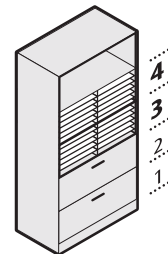

Collator on 3rd & 4th positions
specify: **7K - Black** or
7T - Brushed Cobalt

For 7K / 7T - add \$398.

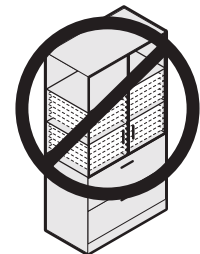

Collators do not fit behind doors

Glazing

Glazing is available in the following options:

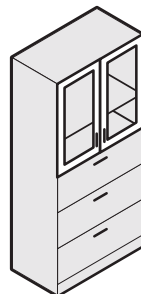

Silver frame
frosted glazing
Z1

specify:
Z36L73F - Z1

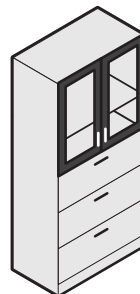

Black frame
frosted glazing
Z2

specify:
Z36L73F - Z2

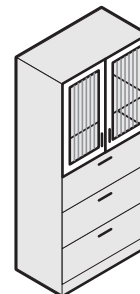

Silver frame
ribbed glazing
Z3

specify:
Z36L73F - Z3

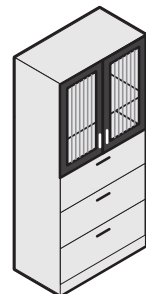

Black frame
ribbed glazing
Z4

specify:
Z36L73F - Z4

Filing Options - For Filing Components

On 16"D files, drawer interiors are only 13"D. On 20"D and 24"D files, drawer interiors are 16"D.
 Full to floor BBF, FF and BF pedestals are 16"W with all pedestal desks, returns with pedestals and credenzas with pedestals.
 Full to floor BBF and FF storage shells 15"W x 28.5"H are required under 36"W space saver return with 16"D connection top (Zxx3616Rx).

Side-to-Side

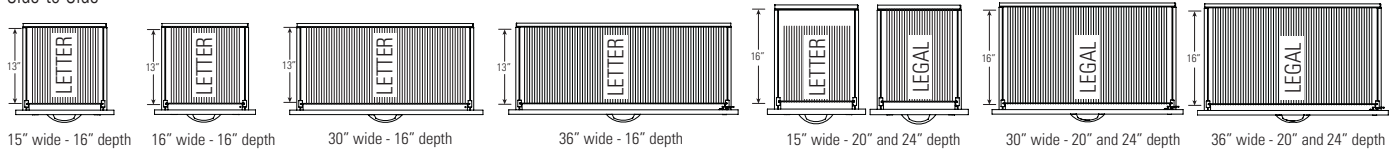

Front-to-Back

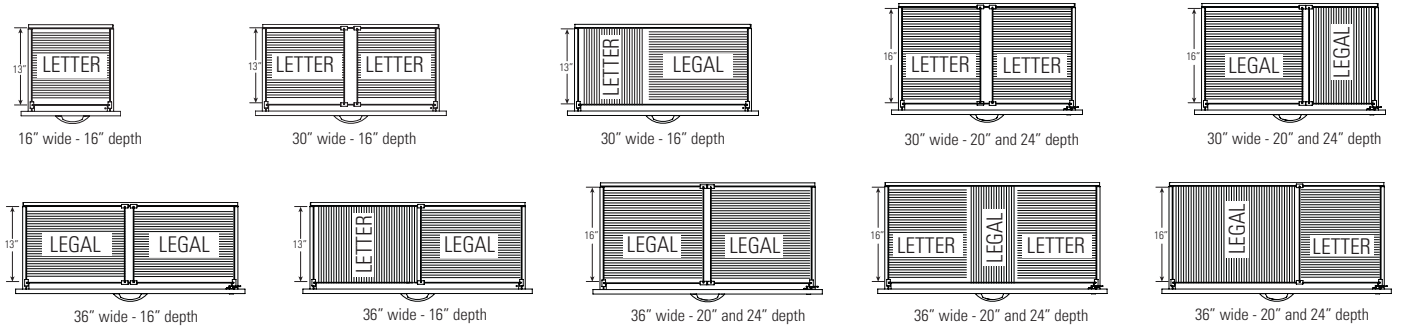

Height Map

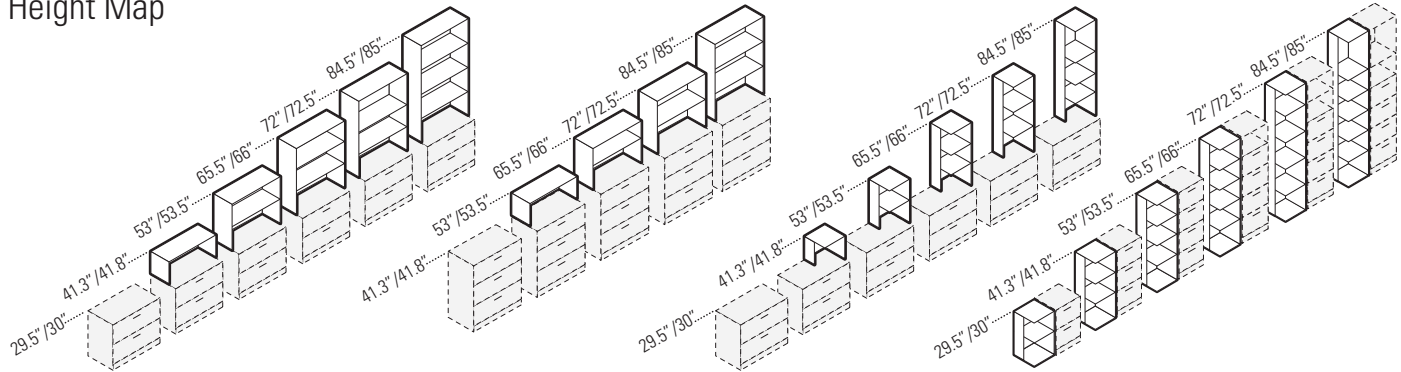

Drawer & Cavity Positions

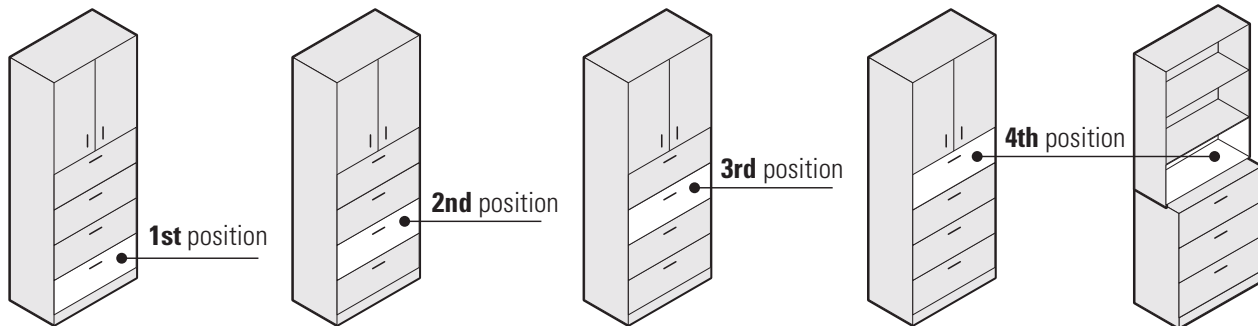

Collator Positions

For 12"W to 21"W units

**if no collator is desired, must specify when placing order.

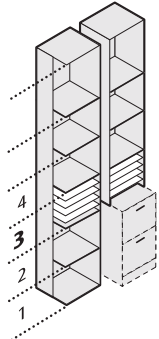

Collator on 3rd position
specify: **3K - Black** or
3T - Brushed Cobalt

For 3K / 3T or 4K / 4T - add \$220.

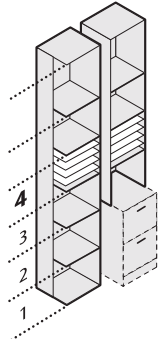

Collator on 4th position
specify: **4K - Black** or
4T - Brushed Cobalt

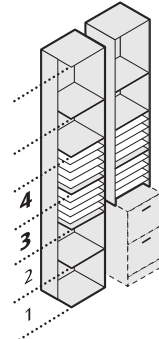

Collator on 3rd & 4th position
specify: **7K - Black** or
7T - Brushed Cobalt

For 7K / 7T - add \$438.

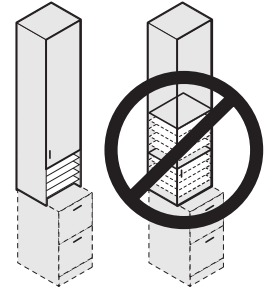

Collators do not fit behind doors

Table Top Bookcase

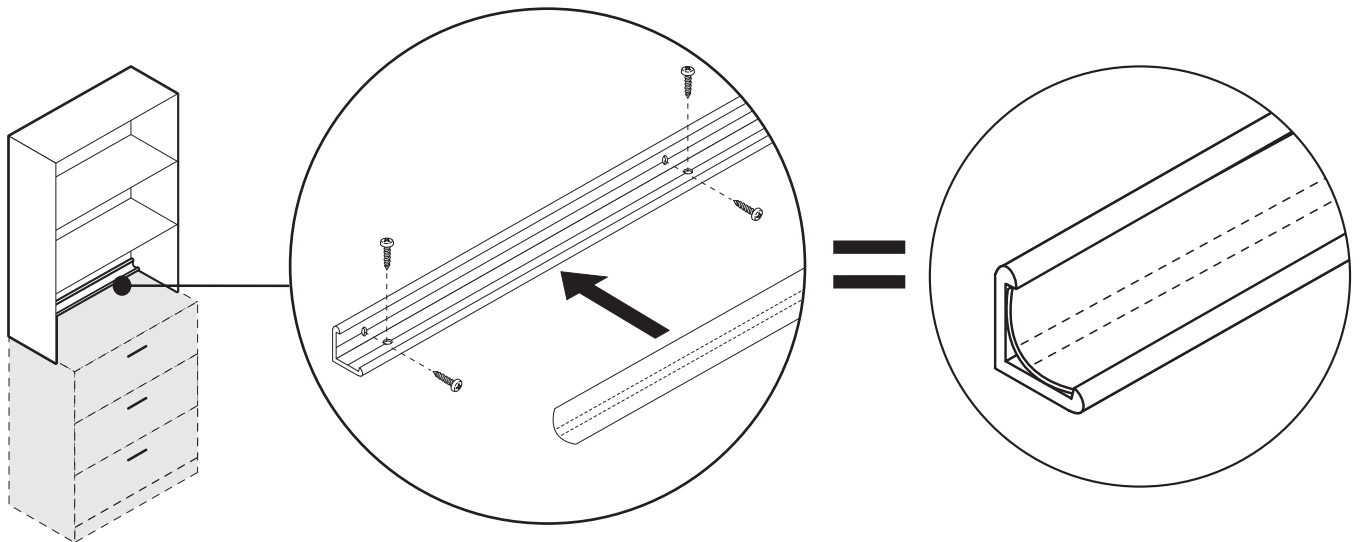

Hutches

Monitor clearance dimensions

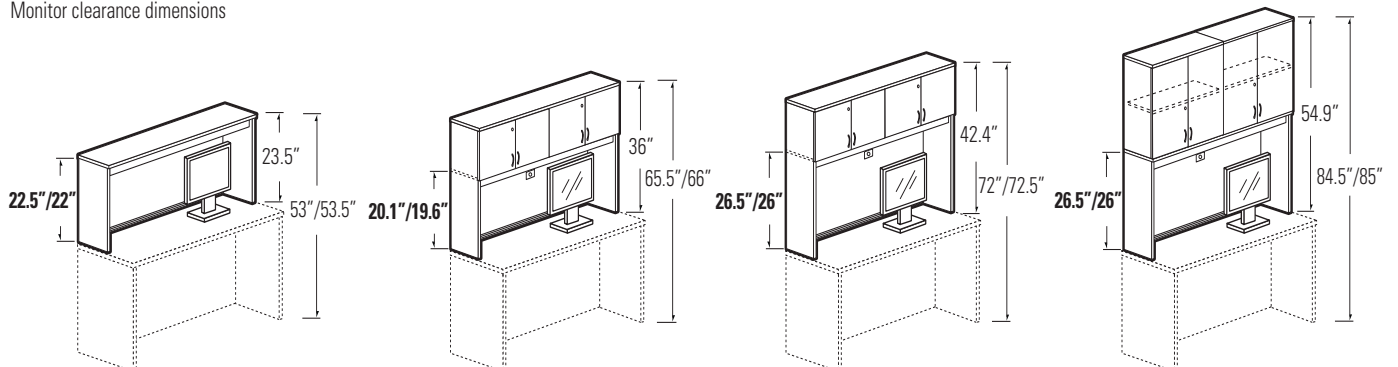

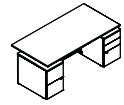

HEIGHT ADJUSTABLE DESKS 125

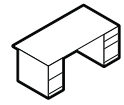

DESKS 130

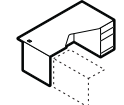

EXTENDED CORNER DESKS 150

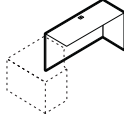

RETURNS 136

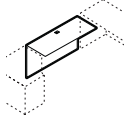

BRIDGES 140

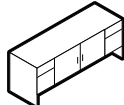

CREDENZAS 143

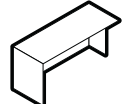

TABLES & CONNECTABLES 157

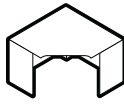

FIVE-SIDED CORNERS 149

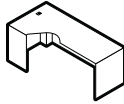

EXTENDED CORNERS 152



ISLANDS 164

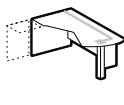

EXTENDED CORNER ISLANDS 161

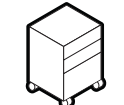

PEDESTALS 168

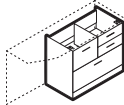

SHELLS 169

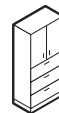

STORAGE MODULES

17.87"/18.37"H 177
 23.75"/24.25"H 178
 29.5"/30"H 179
 41.3"/41.8"H 183
 53"/53.5"H 186
 65.5"/66"H 189
 72"/72.5"H 197
 84.5"/85"H 205

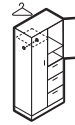

WARDROBES & PERSONAL TOWERS

65.5"/66"H 191
 72"/72.5"H 197
 84.5"/85"H 205

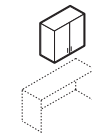

OVERHEAD STORAGE 213

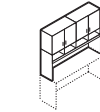

HUTCHES 221
TACKBOARDS FOR HUTCHES 237
PIGEON-HOLE STORAGE 227



FLOATING SHELVES 229
WALLS WITH OVERHEADS 250
WALLS WITH FLOATING SHELVES 231
WALL PANELS 234



BOOKCASES 250

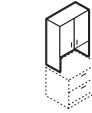
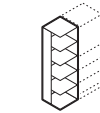

TABLE TOP BOOKCASES 251



END SHELVES 261

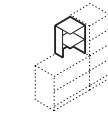
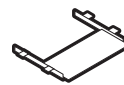

TABLE TOP END SHELVES 263



KEYBOARDS & ACCESSORIES 265



EXECUTIVE



MANAGEMENT



TEAMING AREAS



MULTI-PERSON

HEIGHT ADJUSTABLE DESKS

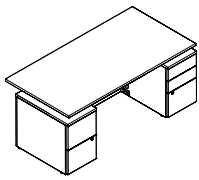

Double Pedestal Desk for Height Adj. Base

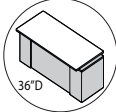
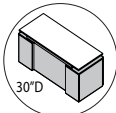

Front view

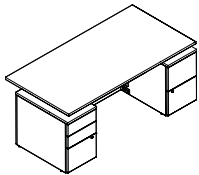

Double Pedestal Desk for Height Adj. Base

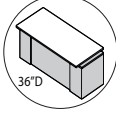
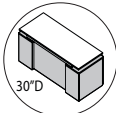

Front view

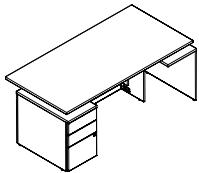

Single Pedestal Desk for Height Adj. Base

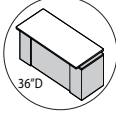
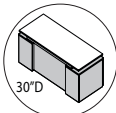

Front view

MODEL #	DIMENSIONS	WT/LB.	CUBIC FT.	1" TOP	1.5" TOP	GLAZE ADD	HP ADD
W x D x H (1.5" TOP)							
ZH3684F23	84 x 36 x 29.5-49.2	362	26.75	\$4622	\$4783	\$746	\$794
ZH3672F23	72 x 36 x 29.5-49.2	335	25.75	\$4521	\$4718	\$641	\$680
ZH3666F23	66 x 36 x 29.5-49.2	321	25.25	\$4417	\$4578	\$610	\$623
ZH3660F23	60 x 36 x 29.5-49.2	307	24.75	\$4212	\$4425	\$571	\$567
ZH3084F23	84 x 30 x 29.5-49.2	347	25.75	\$4521	\$4718	\$746	\$658
ZH3072F23	72 x 30 x 29.5-49.2	321	24.75	\$4404	\$4609	\$641	\$567
ZH3066F23	66 x 30 x 29.5-49.2	309	24.25	\$4286	\$4469	\$610	\$523
ZH3060F23	60 x 30 x 29.5-49.2	296	23.75	\$4168	\$4329	\$571	\$475

Standard with file/file (FF) pedestal on **left** and box/box/file (BBF) pedestal on **right**. BBF - file drawer and lower box drawer lock. FF - drawers lock. Height adjustable base sold separately: for 60"-72" wide desks, specify with height adjustable base FTZ52SFNL (small frame); for 84" wide desks, specify with FTZ52LFNL (large frame). Shipped easy to assemble in 3 cartons.
30"D - Top is recessed 1/2" on either sides over chassis; flush on user and guest sides.
36"D - Top is recessed 1/2" on either sides over chassis; flush on user side and 6.25" overhang on guest side.

ZH3684F32	84 x 36 x 29.5-49.2	362	26.75	\$4622	\$4783	\$746	\$794
ZH3672F32	72 x 36 x 29.5-49.2	335	25.75	\$4521	\$4718	\$641	\$680
ZH3666F32	66 x 36 x 29.5-49.2	321	25.25	\$4417	\$4578	\$610	\$623
ZH3660F32	60 x 36 x 29.5-49.2	307	24.75	\$4212	\$4425	\$571	\$567
ZH3084F32	84 x 30 x 29.5-49.2	347	25.75	\$4521	\$4718	\$746	\$658
ZH3072F32	72 x 30 x 29.5-49.2	321	24.75	\$4404	\$4609	\$641	\$567
ZH3066F32	66 x 30 x 29.5-49.2	309	24.25	\$4286	\$4469	\$610	\$523
ZH3060F32	60 x 30 x 29.5-49.2	296	23.75	\$4168	\$4329	\$571	\$475

Standard with box/box/file (BBF) pedestal on **left** and file/file (FF) pedestal on **right**. BBF - file drawer and lower box drawer lock. FF - drawers lock. Height adjustable base sold separately: for 60"-72" wide desks, specify with height adjustable base FTZ52SFNL (small frame); for 84" wide desks, specify with (large frame). Shipped easy to assemble in 3 cartons.
30"D - Top is recessed 1/2" on either sides over chassis; flush on user and guest sides.
36"D - Top is recessed 1/2" on either sides over chassis; flush on user side and 6.25" overhang on guest side.

ZH3684F3S	84 x 36 x 29.5-49.2	325	26.75	\$4199	\$4425	\$746	\$794
ZH3672F3S	72 x 36 x 29.5-49.2	298	25.75	\$4094	\$4373	\$641	\$680
ZH3666F3S	66 x 36 x 29.5-49.2	284	25.25	\$3937	\$4151	\$610	\$623
ZH3660F3S	60 x 36 x 29.5-49.2	271	24.75	\$3789	\$3985	\$571	\$567
ZH3084F3S	84 x 30 x 29.5-49.2	310	25.75	\$4094	\$4373	\$746	\$658
ZH3072F3S	72 x 30 x 29.5-49.2	285	24.75	\$3981	\$4177	\$641	\$567
ZH3066F3S	66 x 30 x 29.5-49.2	272	24.25	\$3854	\$4042	\$610	\$523
ZH3060F3S	60 x 30 x 29.5-49.2	260	23.75	\$3737	\$3902	\$571	\$475

Standard with box/box/file pedestal on **left**. File drawer and lower box drawer lock. Height adjustable base sold separately: for 60"-72" wide desks, specify with height adjustable base FTZ52SFNL (small frame); for 84" wide desks, specify with FTZ52LFNL (large frame). Shipped easy to assemble in 3 cartons.
30"D - Top is recessed 1" on non-pedestal side and user side over chassis; flush on pedestal side and guest side.
36"D - Top is recessed 1" on non-pedestal side and user side over chassis; flush on pedestal side and 6.25" overhang on guest side.

Required specifications

Top finish Top/edge detail
 Base finish
 Wire management finish
 Default no handle, specify lock finish

Optional specifications

HP laminate Handles
 Key # Modesty finish glazed
 Modesty type
 Grommet position or power block cut-out

Accessories

Must specify height adjustable base separately
 Pencil drawer
 Power block

HEIGHT ADJUSTABLE DESKS

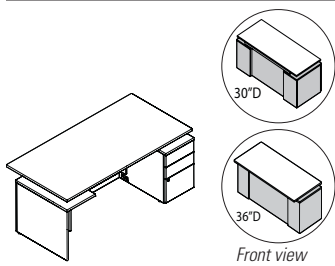

Single Pedestal Desk for Height Adj. Base*

MODEL #	DIMENSIONS	WT/LB.	CUBIC FT.	1" TOP	1.5" TOP	GLAZE ADD	HP ADD
W x D x H (1.5" TOP)							
ZH3684FS3	84 x 36 x 29.5-49.2	325	26.75	\$4199	\$4425	\$746	\$794
ZH3672FS3	72 x 36 x 29.5-49.2	298	25.75	\$4094	\$4373	\$641	\$680
ZH3666FS3	66 x 36 x 29.5-49.2	284	25.25	\$3937	\$4151	\$610	\$623
ZH3660FS3	60 x 36 x 29.5-49.2	271	24.75	\$3789	\$3985	\$571	\$567
ZH3084FS3	84 x 30 x 29.5-49.2	310	25.75	\$4094	\$4373	\$746	\$658
ZH3072FS3	72 x 30 x 29.5-49.2	285	24.75	\$3981	\$4177	\$641	\$567
ZH3066FS3	66 x 30 x 29.5-49.2	272	24.25	\$3854	\$4042	\$610	\$523
ZH3060FS3	60 x 30 x 29.5-49.2	260	23.75	\$3737	\$3902	\$571	\$475

Standard with box/box/file pedestal on **right**. File drawer and lower box drawer lock. Height adjustable base sold separately; for 60"-72" wide desks, specify with height adjustable base FTZ52SFNL (small frame); for 84" wide desks, specify with FTZ52LFNL (large frame). Shipped easy to assemble in 3 cartons.

30"D - Top is recessed 1" on non-pedestal side and user side over chassis; flush on pedestal side and guest side.

36"D - Top is recessed 1" on non-pedestal side and user side over chassis; flush on pedestal side and 6.25" overhang on guest side.

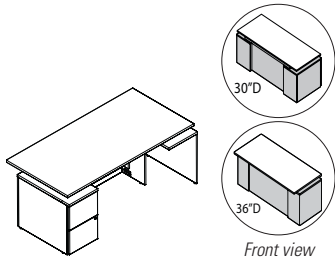

Single Pedestal Desk for Height Adj. Base*

ZH3684F2S	84 x 36 x 29.5-49.2	323	26.75	\$4142	\$4369	\$746	\$794
ZH3672F2S	72 x 36 x 29.5-49.2	296	25.75	\$4059	\$4343	\$641	\$680
ZH3666F2S	66 x 36 x 29.5-49.2	282	25.25	\$3872	\$4085	\$610	\$623
ZH3660F2S	60 x 36 x 29.5-49.2	268	24.75	\$3732	\$3928	\$571	\$567
ZH3084F2S	84 x 30 x 29.5-49.2	308	25.75	\$4059	\$4343	\$746	\$658
ZH3072F2S	72 x 30 x 29.5-49.2	283	24.75	\$3924	\$4120	\$641	\$567
ZH3066F2S	66 x 30 x 29.5-49.2	270	24.25	\$3798	\$3985	\$610	\$523
ZH3060F2S	60 x 30 x 29.5-49.2	258	23.75	\$3680	\$3846	\$571	\$475

Standard with file/file pedestal on **left**. Pedestal locks. Height adjustable base sold separately; for 60"-72" wide desks, specify with height adjustable base FTZ52SFNL (small frame); for 84" wide desks, specify with FTZ52LFNL (large frame). Shipped easy to assemble in 3 cartons.

30"D - Top is recessed 1" on non-pedestal side and user side over chassis; flush on pedestal side and guest side.

36"D - Top is recessed 1" on non-pedestal side and user side over chassis; flush on pedestal side and 6.25" overhang on guest side.

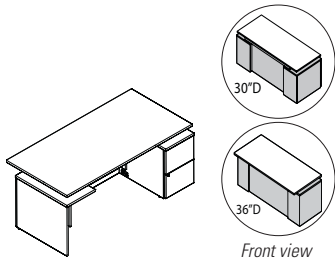

Single Pedestal Desk for Height Adj. Base*

ZH3684FS2	84 x 36 x 29.5-49.2	323	26.75	\$4142	\$4369	\$746	\$794
ZH3672FS2	72 x 36 x 29.5-49.2	296	25.75	\$4059	\$4343	\$641	\$680
ZH3666FS2	66 x 36 x 29.5-49.2	282	25.25	\$3872	\$4085	\$610	\$623
ZH3660FS2	60 x 36 x 29.5-49.2	268	24.75	\$3732	\$3928	\$571	\$567
ZH3084FS2	84 x 30 x 29.5-49.2	308	25.75	\$4059	\$4343	\$746	\$658
ZH3072FS2	72 x 30 x 29.5-49.2	283	24.75	\$3924	\$4120	\$641	\$567
ZH3066FS2	66 x 30 x 29.5-49.2	270	24.25	\$3798	\$3985	\$610	\$523
ZH3060FS2	60 x 30 x 29.5-49.2	258	23.75	\$3680	\$3846	\$571	\$475

Standard with file/file pedestal on **right**. Pedestal locks. Height adjustable base sold separately; for 60"-72" wide desks, specify with height adjustable base FTZ52SFNL (small frame); for 84" wide desks, specify with FTZ52LFNL (large frame). Shipped easy to assemble in 3 cartons.

30"D - Top is recessed 1" on non-pedestal side and user side over chassis; flush on pedestal side and guest side.

36"D - Top is recessed 1" on non-pedestal side and user side over chassis; flush on pedestal side and 6.25" overhang on guest side.

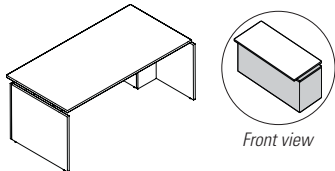

Desk Shell for Height Adj. Base

ZH3684NP	84 x 36 x 29.5-49.2	231	10.5	\$2808	\$3074	N/A	\$794
ZH3672NP	72 x 36 x 29.5-49.2	209	9.25	\$2760	\$2991	N/A	\$680
ZH3666NP	66 x 36 x 29.5-49.2	198	8.5	\$2677	\$2891	N/A	\$623
ZH3660NP	60 x 36 x 29.5-49.2	187	7.75	\$2616	\$2808	N/A	\$567
ZH3072NP	72 x 30 x 29.5-49.2	188	8.75	\$2625	\$2830	N/A	\$567
ZH3066NP	66 x 30 x 29.5-49.2	178	8	\$2542	\$2729	N/A	\$523
ZH3060NP	60 x 30 x 29.5-49.2	168	7.5	\$2503	\$2664	N/A	\$475

Height adjustable base sold separately; for 60" wide desks, specify with height adjustable base FTZ52SFNL (small frame); for 66"-84" wide desks, specify with FTZ52LFNL (large frame). Shipped easy to assemble in 3 cartons.

30"D - Top is recessed 1" on user and both sides over chassis; 2 15/16" overhang on guest side.

36"D - Top is recessed 1" on user and both sides over chassis; 3.25" overhang on guest side.

Required specifications

Top finish Top/edge detail
 Base finish
 Wire management finish
 Default no handle, specify lock finish*

Optional specifications

HP laminate Handles*
 Key #* Modesty finish glazed
 Modesty type
 Grommet position or power block cut-out

Accessories

Desk and height adjustable base to be ordered separately
 Pencil drawer
 Power block

HEIGHT ADJUSTABLE DESKS **MODEL #** **DIMENSIONS** **WT/LB.** **CUBIC FT.** **1" TOP** **1.5" TOP** **GLAZE ADD** **HP ADD**



Height Adjustable Base

W x D x H (1.5" TOP)

Small frame								
FTZ52SFNL	60 x 30 x 29.5-49.2	43	2.2	\$1830	N/A	N/A	N/A	
Large frame								
FTZ52LFNL	66 x 30 x 29.5-49.2	43	2.2	\$1835	N/A	N/A	N/A	

For use with Zira height adjustable desks 60"-84" wide. Lifts 300 lbs. Available in Black (**BLK**) or Tungsten (**TUN**).

- For 60-72" wide models ending in F23/F32/F3S/FS3/F2S/FS2, specify FTZ52SFNL; for 84" wide models specify FTZ52LFNL
- For 60" wide models ending in NP, specify FTZ52SFNL; for 66-84" wide NP models, specify FTZ52LFNL.
- **Recommended torque range for installing all fasteners is 3 to 5 foot-pounds and should not be exceeded. In addition, no impact drivers or high-torque equipment are to be used for any fasteners included in the base assembly kits, as this creates a high risk for damage that is not covered under warranty. The use of hand tools is highly recommended.**

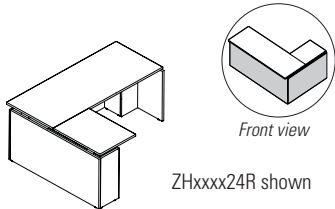

L Desk Shell for Height Adj. Base*

ZH608424L	84 x 60 x 29.5-49.2	294	14.5	\$3675	\$3959	N/A	\$1003
ZH607224L	72 x 60 x 29.5-49.2	273	13.25	\$3510	\$3767	N/A	\$894
ZH608424R	84 x 60 x 29.5-49.2	294	14.5	\$3675	\$3959	N/A	\$1003
ZH607224R	72 x 60 x 29.5-49.2	273	13.25	\$3510	\$3767	N/A	\$894

Specify ZH60xx24L for **LEFT** with return on the right side or ZH60xx24R for **RIGHT** with return on left side. Tops on long return side are recessed 1" over chassis; 1/2" recessed on primary top (non return side) and 2 15/16" overhang on guest side. Height adjustable base FTZ539FSLNL sold separately. Shipped easy to assemble in 4 cartons.

- Only accepts FTZ539FSLNL 2-stage, 3-leg height adjustable base.

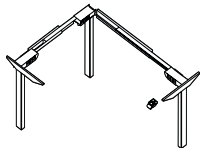

Height Adjustable Base

FTZ539FSLNL	60 x 24 x 29.5-49.2	86	4.5	\$3144	N/A	N/A	N/A
-------------	---------------------	----	-----	---------------	-----	-----	-----

For use with Zira height adjustable L desks. Lifts 300 lbs. Available in Black (**BLK**) or Tungsten (**TUN**).

- **Recommended torque range for installing all fasteners is 3 to 5 foot-pounds and should not be exceeded. In addition, no impact drivers or high-torque equipment are to be used for any fasteners included in the base assembly kits, as this creates a high risk for damage that is not covered under warranty. The use of hand tools is highly recommended.**

MODESTY PANEL KITS

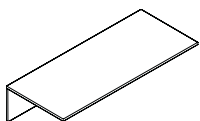

Top and Modesty Panel Kit

ZH3084TB	84 x 30 x 16	99	6.75	\$1256	\$1587	\$746	\$658
ZH3072TB	72 x 30 x 16	85	6	\$1107	\$1391	\$641	\$567
ZH3066TB	66 x 30 x 16	79	5.5	\$1033	\$1299	\$610	\$523
ZH3060TB	60 x 30 x 16	71	5	\$920	\$1164	\$571	\$475
ZH3054TB	54 x 30 x 16	64	4.5	\$850	\$1068	\$536	\$432
ZH3048TB	48 x 30 x 16	57	4	\$780	\$972	\$506	\$379
ZH3042TB	42 x 30 x 16	50	3.75	\$702	\$872	\$475	\$331
ZH2484TB	84 x 24 x 16	86	5.5	\$1121	\$1391	\$746	\$532
ZH2472TB	72 x 24 x 16	74	5	\$994	\$1225	\$641	\$453
ZH2466TB	66 x 24 x 16	68	4.5	\$920	\$1142	\$610	\$419
ZH2460TB	60 x 24 x 16	61	4.25	\$820	\$1025	\$571	\$379
ZH2454TB	54 x 24 x 16	55	3.75	\$759	\$937	\$536	\$344
ZH2448TB	48 x 24 x 16	49	3.5	\$698	\$859	\$506	\$301
ZH2442TB	42 x 24 x 16	43	3	\$619	\$776	\$475	\$266

Top and 15"H modesty **for use with Foli height adjustable base PH3T6601**. Height adjustable frame not included. Shipped easy to assemble in 1 carton.

- Cannot be used with FTZ52SFNL, FTZ52LFNL or FTZ539FSLNL.

Required specifications	Optional specifications	Accessories
Top finish	HP laminate	Desk and height adjustable base to be ordered separately*
Top thickness/edge detail	Grommet position or power block cut-out	Pencil drawer*
Base finish		Power block
Wire management finish		

RETURNS COMPATIBLE W/HEIGHT ADJ. DESKS MODEL # DIMENSIONS WT/LB. CUBIC FT. 1" TOP 1.5" TOP GLAZE ADD HP ADD

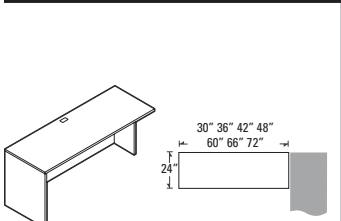

24" Deep Connectable Table - LEFT

	W x D x H (1.5" TOP)							
Z2472L	72 x 24 x 30	164	6	\$902	\$1069	N/A	\$345	
Z2466L	66 x 24 x 30	152	6	\$857	\$1012	N/A	\$330	
Z2460L	60 x 24 x 30	139	5.25	\$827	\$952	N/A	\$330	
Z2448L	48 x 24 x 30	115	4.3	\$783	\$894	N/A	\$263	
Z2442L	42 x 24 x 30	103	3.8	\$719	\$818	N/A	\$222	
Z2436L	36 x 24 x 30	92	3.3	\$705	\$770	N/A	\$167	
Z2430L	30 x 24 x 30	80	3.6	\$677	\$719	N/A	\$167	

Full end panel on left. Right narrow end panel connects to 24"D center/right connectable table, or at 90° angle to a freestanding table; 24"D extended corners or at the end of a straight run; "D" islands or "P" islands with "T" and "H" bases. Grommet in worksurface. Shipped easy to assemble in 1 carton.

- Modesty panel is 1" off of ground.

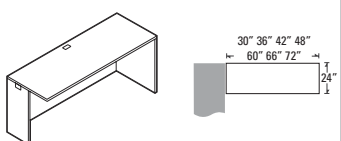

24" Deep Connectable Table - RIGHT

Z2472R	72 x 24 x 30	164	6	\$902	\$1069	N/A	\$345	
Z2466R	66 x 24 x 30	152	6	\$857	\$1012	N/A	\$330	
Z2460R	60 x 24 x 30	139	5.25	\$827	\$952	N/A	\$330	
Z2448R	48 x 24 x 30	115	4.3	\$783	\$894	N/A	\$263	
Z2442R	42 x 24 x 30	103	3.8	\$719	\$818	N/A	\$222	
Z2436R	36 x 24 x 30	92	3.3	\$705	\$770	N/A	\$167	
Z2430R	30 x 24 x 30	80	3.6	\$677	\$719	N/A	\$167	

Full end panel on right. Left narrow end panel connects to 24"D center/right connectable table, or at 90° angle to a freestanding table; 24"D extended corners or at the end of a straight run; "D" islands or "P" islands with "T" and "H" bases. Grommet in worksurface. Shipped easy to assemble in 1 carton.

- Modesty panel is 1" off of ground.

BRIDGES FOR CREDENZAS ZxxxxBB0L/R & ZxxxxBLFL/R

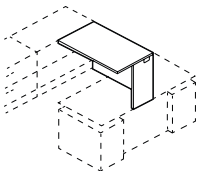

Bridge w/Full Laminate Modest - LEFT*

ZA2448RL	48 x 24 x 30	78	4.3	\$935	\$1095	N/A	\$316	
ZA2442RL	42 x 24 x 30	66	3.8	\$815	\$955	N/A	\$276	
ZA2436RL	36 x 24 x 30	59	3.3	\$758	\$879	N/A	\$237	
ZA2048RL	48 x 20 x 30	72	4.3	\$892	\$1028	N/A	\$263	
ZA2042RL	42 x 20 x 30	62	3.8	\$777	\$896	N/A	\$231	
ZA2036RL	36 x 20 x 30	56	3.3	\$724	\$827	N/A	\$198	

For use with height adjustable desks - single pedestal. Connects to credenza on right. Shipped easy to assemble in 1 carton.

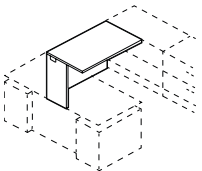

Bridge w/Full Laminate Modesty - RIGHT*

ZA2448RR	48 x 24 x 30	78	4.3	\$935	\$1095	N/A	\$316	
ZA2442RR	42 x 24 x 30	66	3.8	\$815	\$955	N/A	\$276	
ZA2436RR	36 x 24 x 30	59	3.3	\$758	\$879	N/A	\$237	
ZA2048RR	48 x 20 x 30	72	4.3	\$892	\$1028	N/A	\$263	
ZA2042RR	42 x 20 x 30	62	3.8	\$777	\$896	N/A	\$231	
ZA2036RR	36 x 20 x 30	56	3.3	\$724	\$827	N/A	\$198	

For use with height adjustable desks - single pedestal. Connects to credenza on left. Shipped easy to assemble in 1 carton.

Required specifications

- Top finish
- Top/edge detail
- Base finish
- Wire management finish

Optional specifications

- HP laminate
- Modesty panel type*
- Grommet position or power block cut-out

Accessories

- Power block

CRENZAS COMPATIBLE W/HEIGHT ADJ. BRIDGES **MODEL #** **DIMENSIONS** **WT/LB.** **CUBIC FT.** **1" TOP** **1.5" TOP** **GLAZE ADD** **HP ADD**

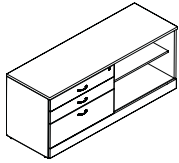

Credenza

W x D x H (1.5" TOP)

Z2472BBOL	72 x 24 x 30	261	35.75	\$2784	\$2935	N/A	\$473
Z2460BBOL	60 x 24 x 30	231	30	\$2497	\$2621	N/A	\$395
Z2072BBOL	72 x 20 x 30	234	30.25	\$2659	\$2783	N/A	\$395
Z2060BBOL	60 x 20 x 30	207	25.25	\$2413	\$2518	N/A	\$329

Compatible with height adjustable bridges. Box/box/lateral file on **left** with open storage on the **right**. Connects to bridge on **right**. Adjustable shelf. Shipped assembled in 1 carton.

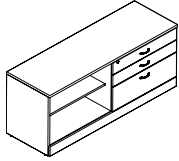

Credenza

Z2472BBOR	72 x 24 x 30	261	35.75	\$2784	\$2935	N/A	\$473
Z2460BBOR	60 x 24 x 30	231	30	\$2497	\$2621	N/A	\$395
Z2072BBOR	72 x 20 x 30	234	30.25	\$2659	\$2783	N/A	\$395
Z2060BBOR	60 x 20 x 30	207	25.25	\$2413	\$2518	N/A	\$329

Compatible with height adjustable bridges. Box/box/lateral file on **right** with open storage on the **left**. Connects to bridge on **left**. Adjustable shelf. Shipped assembled in 1 carton.

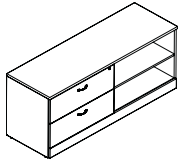

Credenza

Z2472BLFL	72 x 24 x 30	265	35.75	\$2742	\$2892	N/A	\$473
Z2460BLFL	60 x 24 x 30	235	30	\$2472	\$2596	N/A	\$395
Z2072BLFL	72 x 20 x 30	239	30.25	\$2617	\$2740	N/A	\$395
Z2060BLFL	60 x 20 x 30	212	25.25	\$2382	\$2487	N/A	\$329

Compatible with height adjustable bridges. Two drawer lateral file on **left** with open storage on the **right**. Connects to bridge on **right**. Adjustable shelf. Shipped assembled in 1 carton.

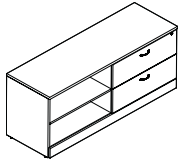

Credenza

Z2472BLFR	72 x 24 x 30	265	35.75	\$2742	\$2892	N/A	\$473
Z2460BLFR	60 x 24 x 30	235	30	\$2472	\$2596	N/A	\$395
Z2072BLFR	72 x 20 x 30	239	30.25	\$2617	\$2740	N/A	\$395
Z2060BLFR	60 x 20 x 30	212	25.25	\$2382	\$2487	N/A	\$329

Compatible with height adjustable bridges. Two drawer lateral file on **right** with open storage on the **left**. Connects to bridge on **left**. Adjustable shelf. Shipped assembled in 1 carton.

Required specifications

- Top finish
- Top/edge detail
- Base finish

Optional specifications

- HP laminate
- Key #
- Handles

DOUBLE PEDESTAL DESKS

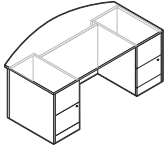

Double Pedestal Bow Top Desk*

MODEL #	DIMENSIONS W x D x H (1.5" TOP)	WT/LB.	CUBIC FT.	1" TOP	1.5" TOP	GLAZE ADD	HP ADD
Z4284FB22	84 x 42 x 30	381	34.25	\$2694	\$2998	\$873	\$919
Z4272FB22	72 x 42 x 30	377	59	\$2586	\$2851	\$721	\$690
Z3672FB22	72 x 36 x 30	317	50.75	\$2413	\$2645	\$721	\$516
Z3666FB22	66 x 36 x 30	306	46.75	\$2365	\$2580	\$645	\$516
Z3660FB22	60 x 36 x 30	295	42.5	\$2298	\$2497	\$570	\$431

Standard with **freestanding** file/file pedestals on **left** and **right**. Pedestals lock. Bow top overhangs 2.25" at ends and 8.125" on center. Shipped assembled in 1 carton.

- 84" wide desks are shipped easy to assemble in 3 cartons.

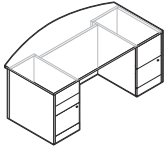

Double Pedestal Bow Top Desk*

Z4284FB32	84 x 42 x 30	379	34.25	\$2726	\$3030	\$873	\$919
Z4272FB32	72 x 42 x 30	375	59	\$2621	\$2886	\$721	\$690
Z3672FB32	72 x 36 x 30	315	50.75	\$2446	\$2678	\$721	\$516
Z3666FB32	66 x 36 x 30	303	46.75	\$2401	\$2616	\$645	\$516
Z3660FB32	60 x 36 x 30	293	42.5	\$2331	\$2530	\$570	\$431

Standard with **freestanding** file/file pedestal on **right** and box/file pedestal on **left**. File drawer and lower box drawer locking. Bow top overhangs 2.25" at ends and 8.125" on center. Shipped assembled in 1 carton.

- 84" wide desks are shipped easy to assemble in 3 cartons.

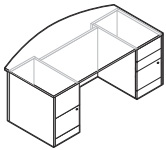

Double Pedestal Bow Top Desk

Z4284FB23	84 x 42 x 30	379	34.25	\$2726	\$3030	\$873	\$919
Z4272FB23	72 x 42 x 30	375	59	\$2621	\$2886	\$721	\$690
Z3672FB23	72 x 36 x 30	315	50.75	\$2446	\$2678	\$721	\$516
Z3666FB23	66 x 36 x 30	303	46.75	\$2401	\$2616	\$645	\$516
Z3660FB23	60 x 36 x 30	293	42.5	\$2331	\$2530	\$570	\$431

Standard with **freestanding** file/file pedestal on **left** and box/file pedestal on **right**. File drawer and lower box drawer locking. Bow top overhangs 2.25" at ends and 8.125" on center. Shipped assembled in 1 carton.

- 84" wide desks are shipped easy to assemble in 3 cartons.

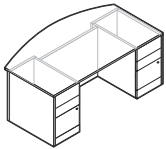

Double Pedestal Bow Top Desk

Z4284FB33	84 x 42 x 30	381	34.25	\$2761	\$3065	\$873	\$919
Z4272FB33	72 x 42 x 30	378	59	\$2654	\$2919	\$721	\$690
Z3672FB33	72 x 42 x 30	317	50.75	\$2483	\$2715	\$721	\$516
Z3666FB33	66 x 36 x 30	306	46.75	\$2434	\$2649	\$645	\$516
Z3660FB33	60 x 36 x 30	295	42.5	\$2369	\$2581	\$570	\$431

Standard with **freestanding** box/file pedestals on **left** and **right**. File drawer and lower box drawer locking. Bow top overhangs 2.25" at ends and 8.125" on center. Shipped assembled in 1 carton.

- 84" wide desks are shipped easy to assemble in 3 cartons.

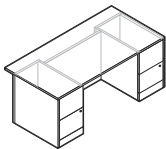

Double Pedestal Desk

Z4284F22	84 x 42 x 30	385	34.25	\$2597	\$2852	\$873	\$919
Z4272F22	72 x 42 x 30	373	59	\$2499	\$2721	\$721	\$690
Z3684F22	84 x 36 x 30	366	59	\$2444	\$2667	\$873	\$690
Z3672F22	72 x 36 x 30	326	50.75	\$2333	\$2527	\$721	\$516
Z3666F22	66 x 36 x 30	315	46.75	\$2287	\$2462	\$645	\$516
Z3660F22	60 x 36 x 30	295	42.5	\$2244	\$2407	\$570	\$431
Z3072F22	72 x 29.7 x 30	293	44	\$2333	\$2527	\$721	\$516
Z3066F22	66 x 29.7 x 30	315	40.25	\$2287	\$2462	\$645	\$516
Z3060F22	60 x 29.7 x 30	268	36.25	\$2244	\$2407	\$570	\$431

Standard with **freestanding** file/file pedestals on **left** and **right**. Pedestals lock. Shipped assembled in 1 carton.

- 84" wide desks are shipped easy to assemble in 3 cartons.

Required specifications

Top finish
Top thickness/edge detail
Base finish
Lock finish

Optional specifications

HP laminate
Key #
Modesty type
Grommet position or power block cut-out

Accessories

Pencil drawer
Power block

DOUBLE PEDESTAL DESKS

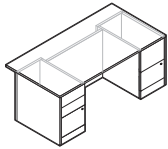

Double Pedestal Desk

MODEL #	DIMENSIONS	WT/LB.	CUBIC FT.	1" TOP	1.5" TOP	GLAZE ADD	HP ADD
W x D x H (1.5" TOP)							
Z4284F32	84 x 42 x 30	383	34.25	\$2631	\$2886	\$873	\$919
Z4272F32	72 x 42 x 30	371	59	\$2536	\$2758	\$721	\$690
Z3684F32	84 x 36 x 30	365	59	\$2478	\$2701	\$873	\$690
Z3672F32	72 x 36 x 30	324	50.75	\$2366	\$2560	\$721	\$516
Z3666F32	66 x 36 x 30	313	46.75	\$2323	\$2498	\$645	\$516
Z3660F32	60 x 36 x 30	267	42.5	\$2278	\$2441	\$570	\$431
Z3072F32	72 x 29.7 x 30	324	44	\$2366	\$2560	\$721	\$516
Z3066F32	66 x 29.7 x 30	281	40.25	\$2323	\$2498	\$645	\$516
Z3060F32	60 x 29.7 x 30	266	36.25	\$2278	\$2441	\$570	\$431

Standard with **freestanding** box/box/file pedestal on **left** and file/file pedestal on **right**. File drawer and lower box drawer locking. Shipped assembled in 1 carton.

- 84" wide desks are shipped easy to assemble in 3 cartons.

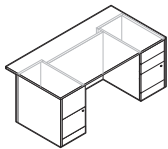

Double Pedestal Desk

Z4284F23	84 x 42 x 30	383	34.25	\$2631	\$2886	\$873	\$919
Z4272F23	72 x 42 x 30	371	59	\$2536	\$2758	\$721	\$690
Z3684F23	84 x 36 x 30	365	59	\$2478	\$2701	\$873	\$690
Z3672F23	72 x 36 x 30	324	50.75	\$2366	\$2560	\$721	\$516
Z3666F23	66 x 36 x 30	313	46.75	\$2323	\$2498	\$645	\$516
Z3660F23	60 x 36 x 30	267	42.5	\$2278	\$2441	\$570	\$431
Z3072F23	72 x 29.7 x 30	292	44	\$2366	\$2560	\$721	\$516
Z3066F23	66 x 29.7 x 30	281	40.25	\$2323	\$2498	\$645	\$516
Z3060F23	60 x 29.7 x 30	266	36.25	\$2278	\$2441	\$570	\$431

Standard with **freestanding** file/file pedestal on **left** and box/box/file pedestal on **right**. File drawer and lower box drawer locking. Shipped assembled in 1 carton.

- 84" wide desks are shipped easy to assemble in 3 cartons.

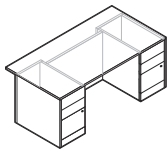

Double Pedestal Desk

Z4284F33	84 x 42 x 30	381	34.25	\$2664	\$2919	\$873	\$919
Z4272F33	72 x 42 x 30	370	59	\$2571	\$2793	\$721	\$690
Z3684F33	84 x 36 x 30	341	59	\$2511	\$2734	\$873	\$690
Z3672F33	72 x 36 x 30	316	50.75	\$2402	\$2596	\$721	\$516
Z3666F33	66 x 36 x 30	305	46.75	\$2357	\$2532	\$645	\$516
Z3660F33	60 x 36 x 30	261	42.5	\$2313	\$2476	\$570	\$431
Z3072F33	72 x 29.7 x 30	291	44	\$2402	\$2596	\$721	\$516
Z3066F33	66 x 29.7 x 30	280	40.25	\$2357	\$2532	\$645	\$516
Z3060F33	60 x 29.7 x 30	261	36.25	\$2313	\$2476	\$570	\$431

Standard with **freestanding** box/box/file pedestals on **left** and **right**. File drawer and lower box drawer locking. Shipped assembled in 1 carton.

- 84" wide desks are shipped easy to assemble in 3 cartons.

SINGLE PEDESTAL DESKS

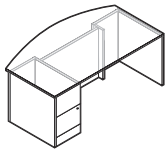

Single Pedestal Bow Top Desk - LEFT

W x D x H (1.5" TOP)							
Z4284FB2L	84 x 42 x 30	322	21.75	\$2056	\$2360	\$873	\$919
Z4272FB2L	72 x 42 x 30	315	59	\$1954	\$2219	\$721	\$690
Z3672FB2L	72 x 36 x 30	281	50.75	\$1811	\$2043	\$721	\$516
Z3666FB2L	66 x 36 x 30	275	46.75	\$1761	\$1976	\$645	\$516
Z3660FB2L	60 x 36 x 30	260	42.5	\$1691	\$1890	\$570	\$431

Standard with **freestanding** file/file pedestal on **left** and faux pedestal on **right**. Pedestal locks. Bow top overhangs 2.25" at ends and 8.125" on center. Shipped assembled in 1 carton.

- 84" wide desks are shipped easy to assemble in 2 cartons.

Required specifications

- Top finish
- Top thickness/edge detail
- Base finish
- Lock finish

Optional specifications

- HP laminate
- Handles
- Key #
- Modesty finish glazed
- Modesty type
- Grommet position or power block cut-out

Accessories

- Pencil drawer
- Power block

SINGLE PEDESTAL DESKS

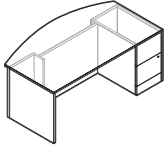

Single Pedestal Bow Top Desk - RIGHT

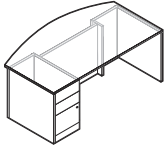

Single Pedestal Bow Top Desk - LEFT

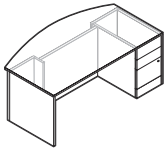

Single Pedestal Bow Top Desk - RIGHT

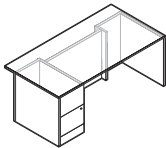

Single Pedestal Desk - LEFT

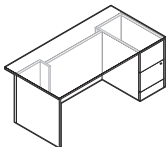

Single Pedestal Desk - RIGHT

MODEL #	DIMENSIONS W x D x H (1.5" TOP)	WT/LB.	CUBIC FT.	1" TOP	1.5" TOP	GLAZE ADD	HP ADD
Z4284FB2R	84 x 42 x 30	322	21.75	\$2056	\$2360	\$873	\$919
Z4272FB2R	72 x 42 x 30	315	59	\$1954	\$2219	\$721	\$690
Z3672FB2R	72 x 36 x 30	281	50.75	\$1811	\$2043	\$721	\$516
Z3666FB2R	66 x 36 x 30	275	46.75	\$1761	\$1976	\$645	\$516
Z3660FB2R	60 x 36 x 30	260	42.5	\$1691	\$1890	\$570	\$431

Standard with **freestanding** faux pedestal on **left** and file/file pedestal on **right**. Pedestal locks. Bow top overhangs 2.25" at ends and 8.125" on center. Shipped assembled in 1 carton.

- 84" wide desks are shipped easy to assemble in 2 cartons.

Z4284FB3L	84 x 42 x 30	320	21.75	\$2093	\$2397	\$873	\$919
Z4272FB3L	72 x 42 x 30	313	59	\$1986	\$2251	\$721	\$690
Z3672FB3L	72 x 36 x 30	280	50.75	\$1844	\$2076	\$721	\$516
Z3666FB3L	66 x 36 x 30	273	46.75	\$1797	\$2012	\$645	\$516
Z3660FB3L	60 x 36 x 30	258	42.5	\$1745	\$1944	\$570	\$431

Standard with **freestanding** box/box/file pedestal on **left** and faux pedestal on **right**. File drawer and lower box drawer locking. Bow top overhangs 2.25" at ends and 8.125" on center. Shipped assembled in 1 carton.

- 84" wide desks are shipped easy to assemble in 2 cartons.

Z4284FB3R	84 x 42 x 30	320	21.75	\$2093	\$2397	\$873	\$919
Z4272FB3R	72 x 42 x 30	313	59	\$1986	\$2251	\$721	\$690
Z3672FB3R	72 x 36 x 30	280	50.75	\$1844	\$2076	\$721	\$516
Z3666FB3R	66 x 36 x 30	273	46.75	\$1797	\$2012	\$645	\$516
Z3660FB3R	60 x 36 x 30	258	42.5	\$1745	\$1944	\$570	\$431

Standard with **freestanding** faux pedestal on **left** and box/box/file pedestal on **right**. File drawer and lower box drawer locking. Bow top overhangs 2.25" at ends and 8.125" on center. Shipped assembled in 1 carton.

- 84" wide desks are shipped easy to assemble in 2 cartons.

Z4284F2L	84 x 42 x 30	327	21.75	\$1964	\$2219	\$873	\$919
Z4272F2L	72 x 42 x 30	327	59	\$1866	\$2088	\$721	\$690
Z3684F2L	84 x 36 x 30	291	59	\$1841	\$2064	\$873	\$690
Z3672F2L	72 x 36 x 30	266	50.75	\$1728	\$1922	\$721	\$516
Z3666F2L	66 x 36 x 30	254	46.75	\$1686	\$1861	\$645	\$516
Z3660F2L	60 x 36 x 30	244	42.5	\$1642	\$1808	\$570	\$431
Z3072F2L	72 x 29.7 x 30	266	44	\$1728	\$1922	\$721	\$516
Z3066F2L	66 x 29.7 x 30	266	40.25	\$1686	\$1861	\$645	\$516
Z3060F2L	60 x 29.7 x 30	227	36.25	\$1642	\$1808	\$570	\$431

Standard with **freestanding** file/file pedestal on **left** and faux pedestal on **right**. Pedestal locks. Shipped assembled in 1 carton.

- 84" wide desks are shipped easy to assemble in 2 cartons.

Z4284F2R	84 x 42 x 30	327	21.75	\$1964	\$2219	\$873	\$919
Z4272F2R	72 x 42 x 30	327	59	\$1866	\$2088	\$721	\$690
Z3684F2R	84 x 36 x 30	291	59	\$1841	\$2064	\$873	\$690
Z3672F2R	72 x 36 x 30	266	50.75	\$1728	\$1922	\$721	\$516
Z3666F2R	66 x 36 x 30	254	46.75	\$1686	\$1861	\$645	\$516
Z3660F2R	60 x 36 x 30	244	42.5	\$1642	\$1808	\$570	\$431
Z3072F2R	72 x 29.7 x 30	266	44	\$1728	\$1922	\$721	\$516
Z3066F2R	66 x 29.7 x 30	240	40.25	\$1686	\$1861	\$645	\$516
Z3060F2R	60 x 29.7 x 30	227	36.25	\$1642	\$1808	\$570	\$431

Standard with **freestanding** faux pedestal on **left** and file/file pedestal on **right**. Pedestal locks. Shipped assembled in 1 carton.

- 84" wide desks are shipped easy to assemble in 2 cartons.

Required specifications

Top finish
Top thickness/edge detail
Base finish
Lock finish

Optional specifications

HP laminate Handles
Key # Modesty finish glazed
Modesty type
Grommet position or power block cut-out

Accessories

Pencil drawer
Power block

SINGLE PEDESTAL DESKS

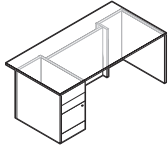

Single Pedestal Desk - LEFT*

MODEL #	DIMENSIONS	WT/LB.	CUBIC FT.	1" TOP	1.5" TOP	GLAZE ADD	HP ADD
W x D x H (1.5" TOP)							
Z4284F3L	84 x 42 x 30	324	21.75	\$1995	\$2250	\$873	\$919
Z4272F3L	72 x 42 x 30	324	59	\$1901	\$2123	\$721	\$690
Z3684F3L	84 x 36 x 30	289	59	\$1841	\$2064	\$873	\$690
Z3672F3L	72 x 36 x 30	264	50.75	\$1764	\$1958	\$721	\$516
Z3666F3L	66 x 36 x 30	252	46.75	\$1718	\$1893	\$645	\$516
Z3660F3L	60 x 36 x 30	242	42.5	\$1653	\$1816	\$570	\$431
Z3072F3L	72 x 29.7 x 30	251	44	\$1764	\$1958	\$721	\$516
Z3066F3L	66 x 29.7 x 30	239	40.25	\$1718	\$1893	\$645	\$516
Z3060F3L	60 x 29.7 x 30	226	36.25	\$1653	\$1816	\$570	\$431

Standard with **freestanding** box/box/file pedestal on **left** and faux pedestal on **right**. File drawer and lower box drawer locking. Shipped assembled in 1 carton.

- 84" wide desks are shipped easy to assemble in 2 cartons.

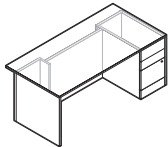

Single Pedestal Desk - RIGHT*

Z4284F3R	84 x 42 x 30	324	21.75	\$1995	\$2250	\$873	\$919
Z4272F3R	72 x 42 x 30	324	59	\$1901	\$2123	\$721	\$690
Z3684F3R	84 x 36 x 30	289	59	\$1841	\$2064	\$873	\$690
Z3672F3R	72 x 36 x 30	264	50.75	\$1764	\$1958	\$721	\$516
Z3666F3R	66 x 36 x 30	252	46.75	\$1718	\$1893	\$645	\$516
Z3660F3R	60 x 36 x 30	242	42.5	\$1653	\$1816	\$570	\$431
Z3072F3R	72 x 29.7 x 30	251	44	\$1764	\$1968	\$721	\$543
Z3066F3R	66 x 29.7 x 30	239	40.25	\$1718	\$1893	\$645	\$516
Z3060F3R	60 x 29.7 x 30	226	36.25	\$1653	\$1816	\$570	\$431

Standard with **freestanding** faux pedestal on **left** and box/box/file pedestal on **right**. File drawer and lower box drawer locking. Shipped assembled in 1 carton.

- 84" wide desks are shipped easy to assemble in 2 cartons.

NON-HANDED DESKS

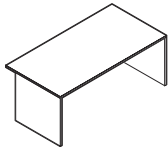

Non-Handed Desk

MODEL #	DIMENSIONS	WT/LB.	CUBIC FT.	1" TOP	1.5" TOP	GLAZE ADD	HP ADD
W x D x H (1.5" TOP)							
Z4284NHD	84 x 42 x 30	207	9.53	\$1899	\$2271	N/A	\$955
Z3684NHD	84 x 36 x 30	182	8.37	\$1721	\$2032	N/A	\$828
Z3672NHD	72 x 36 x 30	162	7.25	\$1555	\$1821	N/A	\$711
Z3666NHD	66 x 36 x 30	153	6.7	\$1466	\$1716	N/A	\$651
Z3660NHD	60 x 36 x 30	143	6.14	\$1382	\$1616	N/A	\$591
Z3072NHD	72 x 30 x 30	141	6.19	\$1416	\$1638	N/A	\$592
Z3066NHD	66 x 30 x 30	133	5.71	\$1310	\$1527	N/A	\$545
Z3060NHD	60 x 30 x 30	124	5.24	\$1238	\$1421	N/A	\$494

Two laminate end panels with full modesty panel (laminated only). Recessed modesty. Accepts all standard Zira storage shells. Shipped assembled in 1 carton.

Required specifications

Top finish
Top thickness/edge detail
Base finish
Lock finish*

Optional specifications

HP laminate Handles
Key # Modesty type*
Modesty finish glazed (not returns)
Grommet position or power block cut-out

Accessories

Pencil drawer
Power block

FREESTANDING DESKS

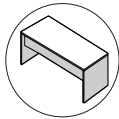
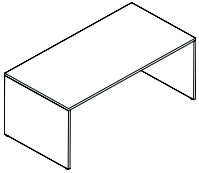

Front view

Freestanding Desk

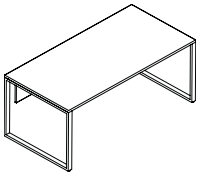

Freestanding Desk - Metal Legs*

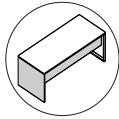
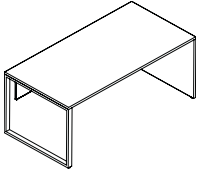

Front view

Freestanding Desk - Metal Legs*

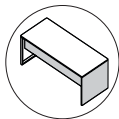
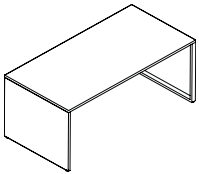

Front view

Freestanding Desk - Metal Legs*

MODEL #	DIMENSIONS	WT/LB.	CUBIC FT.	1" TOP	1.5" TOP	GLAZE ADD	HP ADD
W x D x H (1.5" TOP)							
Z3684DK	84 x 36 x 30	168	8.25	\$1395	\$1684	\$1113	\$828
Z3672DK	72 x 36 x 30	152	7.25	\$1279	\$1532	\$992	\$711
Z3666DK	66 x 36 x 30	144	6.75	\$1222	\$1454	\$908	\$651
Z3660DK	60 x 36 x 30	137	6	\$1166	\$1376	\$847	\$592
Z3072DK	72 x 30 x 30	130	6.25	\$1139	\$1351	\$992	\$592
Z3066DK	66 x 30 x 30	123	5.75	\$1082	\$1292	\$908	\$545
Z3060DK	60 x 30 x 30	117	5.25	\$1029	\$1239	\$847	\$494

Two full laminate end panels. 12"H laminate modesty panel. Shipped easy to assemble in 1 carton.

Z3684DM	84 x 36 x 30	167	18.5	\$2987	\$3283	\$850	\$828
Z3672DM	72 x 36 x 30	151	17.5	\$2875	\$3129	\$733	\$711
Z3666DM	66 x 36 x 30	143	17	\$2820	\$3052	\$645	\$651
Z3660DM	60 x 36 x 30	135	16.5	\$2763	\$2973	\$585	\$592
Z3072DM	72 x 30 x 30	133	14.75	\$2737	\$2949	\$733	\$592
Z3066DM	66 x 30 x 30	126	14.25	\$2680	\$2892	\$645	\$545
Z3060DM	60 x 30 x 30	120	14	\$2625	\$2837	\$585	\$494

Double metal legs. 12"H laminate modesty panel. Shipped easy to assemble in 3 cartons.

Z3684DML	84 x 36 x 30	167	13.5	\$2195	\$2483	\$977	\$828
Z3672DML	72 x 36 x 30	151	12.25	\$2083	\$2329	\$858	\$711
Z3666DML	66 x 36 x 30	144	11.75	\$2027	\$2259	\$772	\$651
Z3660DML	60 x 36 x 30	135	11.25	\$1973	\$2183	\$712	\$592
Z3072DML	72 x 30 x 30	131	10.5	\$1944	\$2154	\$858	\$592
Z3066DML	66 x 30 x 30	125	10	\$1890	\$2100	\$772	\$545
Z3060DML	60 x 30 x 30	118	9.5	\$1834	\$2044	\$712	\$494

Single metal leg on **left** and laminate end panel on **right**. 12"H laminate modesty panel. Shipped easy to assemble in 2 cartons.

Z3684DMR	84 x 36 x 30	167	13.5	\$2195	\$2483	\$977	\$828
Z3672DMR	72 x 36 x 30	151	12.25	\$2083	\$2329	\$858	\$711
Z3666DMR	66 x 36 x 30	144	11.75	\$2027	\$2259	\$772	\$651
Z3660DMR	60 x 36 x 30	135	11.25	\$1973	\$2183	\$712	\$592
Z3072DMR	72 x 30 x 30	131	10.5	\$1944	\$2154	\$858	\$592
Z3066DMR	66 x 30 x 30	125	10	\$1890	\$2100	\$772	\$545
Z3060DMR	60 x 30 x 30	118	9.5	\$1834	\$2044	\$712	\$494

Single metal leg on **right** and laminate end panel on **left**. 12"H laminate modesty panel. Shipped easy to assemble in 2 cartons.

Required specifications

Top finish
Top/edge detail
Base finish
Leg finish*

Optional specifications

HP laminate
Modesty finish glazed
Modesty type
Grommet position or power block cut-out

Accessories

Pencil drawer
Keyboard
Power block

TRANSITIONAL TABLES **MODEL #** **DIMENSIONS** **WT/LB.** **CUBIC FT.** **1" TOP** **1.5" TOP** **GLAZE ADD** **HP ADD**

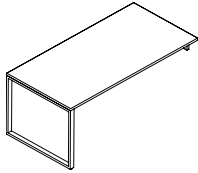

Overlapping Table - LEFT

W x D x H (1.5" TOP)

Z3684OML	84 x 36 x 30	132	13.5	\$2008	\$2296	N/A	\$828
Z3672OML	72 x 36 x 30	120	12.25	\$1917	\$2205	N/A	\$711
Z3666OML	66 x 36 x 30	112	11.75	\$1876	\$2165	N/A	\$651
Z3660OML	60 x 36 x 30	105	11.25	\$1839	\$2122	N/A	\$592
Z3072OML	72 x 30 x 30	104	10.5	\$1813	\$2088	N/A	\$592
Z3066OML	66 x 30 x 30	97	10	\$1771	\$2053	N/A	\$545
Z3060OML	60 x 30 x 30	90	9.5	\$1736	\$2018	N/A	\$494

Metal open frame leg with support channels on **left**. To be placed on top of 23.75"/24.25" high units. Not freestanding. Shipped easy to assemble in 2 cartons.

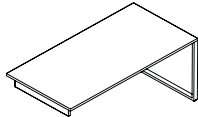

Overlapping Table - RIGHT

Z3684OMR	84 x 36 x 30	132	13.5	\$2008	\$2296	N/A	\$828
Z3672OMR	72 x 36 x 30	120	12.25	\$1917	\$2205	N/A	\$711
Z3666OMR	66 x 36 x 30	112	11.75	\$1876	\$2165	N/A	\$651
Z3660OMR	60 x 36 x 30	105	11.25	\$1839	\$2122	N/A	\$592
Z3072OMR	72 x 30 x 30	104	10.5	\$1813	\$2088	N/A	\$592
Z3066OMR	66 x 30 x 30	97	10	\$1771	\$2053	N/A	\$545
Z3060OMR	60 x 30 x 30	90	9.5	\$1736	\$2018	N/A	\$494

Metal open frame leg with support channels on **right**. To be placed on top of 23.75"/24.25" high units. Not freestanding. Shipped easy to assemble in 2 cartons.

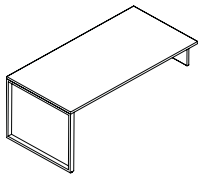

Overlapping Table - LEFT

Z3684SOL	84 x 36 x 30	139	13.5	\$2027	\$2315	N/A	\$828
Z3672SOL	72 x 36 x 30	126	12.25	\$1938	\$2226	N/A	\$711
Z3666SOL	66 x 36 x 30	118	11.75	\$1895	\$2184	N/A	\$651
Z3660SOL	60 x 36 x 30	110	11.25	\$1861	\$2143	N/A	\$592
Z3072SOL	72 x 30 x 30	108	10.5	\$1834	\$2109	N/A	\$592
Z3066SOL	66 x 30 x 30	100	10	\$1792	\$2074	N/A	\$545
Z3060SOL	60 x 30 x 30	96	9.5	\$1757	\$2039	N/A	\$494

Metal open frame leg with support channels on **left**. To be placed on top of 17.87"/18.37" high units. Not freestanding. Shipped easy to assemble in 2 cartons.

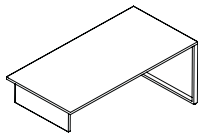

Overlapping Table - RIGHT

Z3684SOR	84 x 36 x 30	139	13.5	\$2027	\$2315	N/A	\$828
Z3672SOR	72 x 36 x 30	126	12.25	\$1938	\$2226	N/A	\$711
Z3666SOR	66 x 36 x 30	118	11.75	\$1895	\$2184	N/A	\$651
Z3660SOR	60 x 36 x 30	110	11.25	\$1861	\$2143	N/A	\$592
Z3072SOR	72 x 30 x 30	108	10.5	\$1834	\$2109	N/A	\$592
Z3066SOR	66 x 30 x 30	100	10	\$1792	\$2074	N/A	\$545
Z3060SOR	60 x 30 x 30	96	9.5	\$1757	\$2039	N/A	\$494

Metal open frame leg with support channels on **right**. To be placed on top of 17.87"/18.37" high units. Not freestanding. Shipped easy to assemble in 2 cartons.

Required specifications

- Top finish
- Top/edge detail
- Base finish
- Leg finish

Optional specifications

- HP laminate
- Grommet position or power block cut-out

Accessories

- Pencil drawer
- Keyboard
- Power block

FLUSH RETURNS

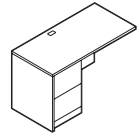

Flush Return - LEFT

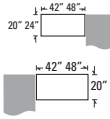

MODEL #	DIMENSIONS	WT/LB.	CUBIC FT.	1" TOP	1.5" TOP	GLAZE ADD	HP ADD
W x D x H (1.5" TOP)							
Z2448L4	48 x 24 x 30	179	24.25	\$1365	\$1474	N/A	\$263
Z2442L4	42 x 24 x 30	167	21.5	\$1365	\$1464	N/A	\$222
Z2048L4	48 x 20 x 30	162	20.5	\$1285	\$1382	N/A	\$222
Z2042L4	42 x 20 x 30	151	18	\$1285	\$1382	N/A	\$222

Standard with **file/file** drawer pedestal on the **left**. Pedestal locks. Grommet in worksurface. For use with right handed single pedestal desks, 20"/24" deep extended corners with narrow end panel or 20"/24" deep five-sided corners with narrow end panel. Shipped assembled in 1 carton.

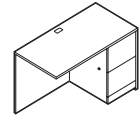

Flush Return - RIGHT

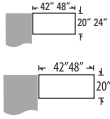

Z2448R4	48 x 24 x 30	179	24.25	\$1365	\$1474	N/A	\$263
Z2442R4	42 x 24 x 30	167	21.5	\$1365	\$1464	N/A	\$222
Z2048R4	48 x 20 x 30	162	20.5	\$1285	\$1382	N/A	\$222
Z2042R4	42 x 20 x 30	151	18	\$1285	\$1382	N/A	\$222

Standard with **file/file** drawer pedestal on the **right**. Pedestal locks. Grommet in worksurface. For use with left handed single pedestal desks, 20"/24" deep extended corners with narrow end panel or 20"/24" deep five-sided corners with narrow end panel. Shipped assembled in 1 carton.

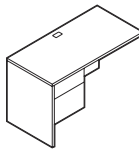

Flush Return - LEFT*

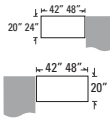

Z2448FL	48 x 24 x 30	163	24	\$1082	\$1191	N/A	\$263
Z2442FL	42 x 24 x 30	151	21.25	\$1082	\$1191	N/A	\$222
Z2048FL	48 x 20 x 30	147	20.25	\$1022	\$1119	N/A	\$222
Z2042FL	42 x 20 x 30	136	18	\$1022	\$1119	N/A	\$222

Standard with **box/file** drawer pedestal on the **left**. One pencil tray. Pedestal locks. Grommet in worksurface. For use with right handed single pedestal desks, 20"/24" deep extended corners with narrow end panel or 20"/24" deep five-sided corners with narrow end panel. Shipped assembled in 1 carton.

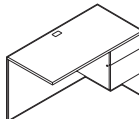

Flush Return - RIGHT*

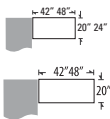

Z2448FR	48 x 24 x 30	163	24	\$1082	\$1191	N/A	\$263
Z2442FR	42 x 24 x 30	151	21.25	\$1082	\$1191	N/A	\$222
Z2048FR	48 x 20 x 30	147	20.25	\$1022	\$1119	N/A	\$222
Z2042FR	42 x 20 x 30	136	18	\$1022	\$1119	N/A	\$222

Standard with **box/file** drawer pedestal on the **right**. One pencil tray. Pedestal locks. Grommet in worksurface. For use with left handed single pedestal desks, 20"/24" deep extended corners with narrow end panel or 20"/24" deep five-sided corners with narrow end panel. Shipped assembled in 1 carton.

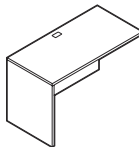

Flush Return - LEFT

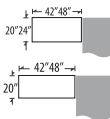

Z2448EL	48 x 24 x 30	117	4.3	\$759	\$870	N/A	\$263
Z2442EL	42 x 24 x 30	104	3.8	\$759	\$870	N/A	\$222
Z2048EL	48 x 20 x 30	106	4.3	\$701	\$798	N/A	\$222
Z2042EL	42 x 20 x 30	94	3.8	\$701	\$798	N/A	\$222

Return has **no pedestal**. Grommet in worksurface. For use with right handed single pedestal desks, 20"/24" deep extended corners with narrow end panel or 20"/24" deep five-sided corners with narrow end panel. Shipped assembled in 1 carton.

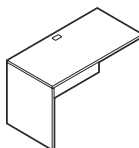

Flush Return - LEFT

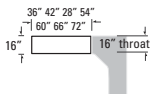

Z1672RL	72 x 15.8 x 30	109	6	\$674	\$788	N/A	\$257
Z1666RL	66 x 15.8 x 30	102	5.75	\$646	\$754	N/A	\$257
Z1660RL	60 x 15.8 x 30	95	5.25	\$606	\$705	N/A	\$215
Z1654RL	54 x 15.8 x 30	87	5.25	\$573	\$663	N/A	\$215
Z1648RL	48 x 15.8 x 30	80	4.25	\$529	\$613	N/A	\$171
Z1642RL	42 x 15.8 x 30	70	4	\$474	\$549	N/A	\$171
Z1636RL	36 x 15.8 x 30	62	3.5	\$422	\$486	N/A	\$128

16" throat. Return has **no pedestal**. Grommet in worksurface. For use with extended corners, desks and islands with 16" throat. Shipped easy to assemble in 1 carton.

Required specifications

- Top finish
- Top thickness/edge detail
- Base finish
- Lock finish*

Optional specifications

- HP laminate
- Key #*
- Modesty type
- Grommet position or power block cut-out
- Handles*

Accessories

- Pencil drawer
- Power block

FLUSH RETURNS **MODEL #** **DIMENSIONS** **WT/LB.** **CUBIC FT.** **1" TOP** **1.5" TOP** **GLAZE ADD** **HP ADD**



Flush Return - RIGHT

W x D x H (1.5" TOP)

Z2448ER	48 x 24 x 30	117	4.3	\$759	\$870	N/A	\$263
Z2442ER	42 x 24 x 30	104	3.8	\$759	\$870	N/A	\$222
Z2048ER	48 x 20 x 30	106	4.3	\$701	\$798	N/A	\$222
Z2042ER	42 x 20 x 30	94	3.8	\$701	\$798	N/A	\$222

Return has **no pedestal**. Grommet in worksurface. For use with left handed single pedestal desks, 20"/24" deep extended corners with narrow end panel or 20"/24" deep five-sided corners with narrow end panel. Shipped easy to assemble in 1 carton.

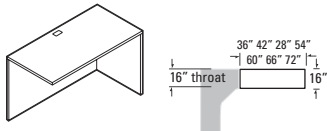

Flush Return - RIGHT

Z1672RR	72 x 15.8 x 30	109	6	\$674	\$788	N/A	\$257
Z1666RR	66 x 15.8 x 30	102	5.75	\$646	\$754	N/A	\$257
Z1660RR	60 x 15.8 x 30	95	5.25	\$606	\$705	N/A	\$215
Z1654RR	54 x 15.8 x 30	87	5.25	\$573	\$663	N/A	\$215
Z1648RR	48 x 15.8 x 30	80	4.25	\$529	\$613	N/A	\$171
Z1642RR	42 x 15.8 x 30	70	4	\$474	\$549	N/A	\$171
Z1636RR	36 x 15.8 x 30	62	3.5	\$422	\$486	N/A	\$128

16" throat. Return has **no pedestal**. Grommet in worksurface. For use with extended corners, desks and islands with 16" throat. Shipped easy to assemble in 1 carton.

NON-HANDED RETURNS

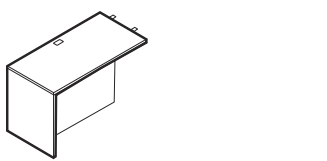

Non-Handed Return

W x D x H (1.5" TOP)

Z2448NHR	48 x 24 x 30	83.6	4.78	\$888	\$1022	N/A	\$311
Z2442NHR	42 x 24 x 30	75.4	3.83	\$772	\$910	N/A	\$278
Z2048NHR	48 x 20 x 30	75.56	4.3	\$805	\$933	N/A	\$261
Z2042NHR	42 x 20 x 30	67.96	3.83	\$738	\$833	N/A	\$233

Non-handed (reversible) return. 24"D returns accept all standard 23.4" storage shells. 20"D returns accept all standard 19.3" storage shells. Full modesty panel (laminated only). Shipped ready to assemble in 1 carton.

SPACE SAVER RETURNS

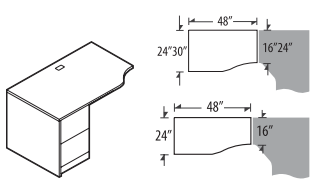

Space Saver Return - LEFT*

W x D x H (1.5" TOP)

Z3048P4L	48 x 29.69 x 30	222	29	\$1503	\$1639	N/A	\$380
Z2448P4L	48 x 24 x 30	170	24.25	\$1205	\$1318	N/A	\$230

Standard with **file/file** drawer pedestal on the **left**. Grommet in worksurface. Pedestal locks. Connects to 24" or 16" component. Shipped assembled in 1 carton.

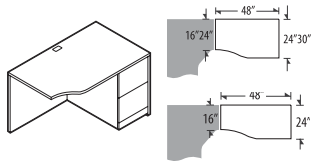

Space Saver Return - RIGHT*

Z3048P4R	48 x 29.69 x 30	222	29	\$1503	\$1639	N/A	\$380
Z2448P4R	48 x 24 x 30	170	24.25	\$1205	\$1318	N/A	\$230

Standard with **file/file** drawer pedestal on the **right**. Grommet in worksurface. Pedestal locks. Connects to 24" or 16" component. Shipped assembled in 1 carton.

Required specifications	Optional specifications	Accessories
Top finish	HP laminate	Pencil drawer (only Z2xxx6RL)
Top thickness/edge detail	Handles*	Power block
Base finish	Key #*	
Lock finish*	Modesty type (not ZxxxxP4R/ ZxxxxP4L)	
	Grommet position or power block cut-out	

SPACE SAVER RETURNS

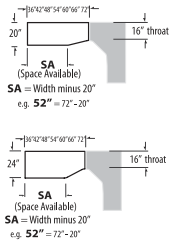
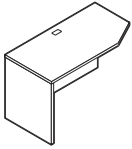

Space Saver Return - LEFT

MODEL #	DIMENSIONS	WT/LB.	CUBIC FT.	1" TOP	1.5" TOP	GLAZE ADD	HP ADD
W x D x H (1.5" TOP)							
Z247216RL	72 x 24 x 30	135	6	\$802	\$973	N/A	\$344
Z246616RL	66 x 24 x 30	127	5.75	\$763	\$923	N/A	\$344
Z246016RL	60 x 24 x 30	118	5.25	\$716	\$862	N/A	\$286
Z245416RL	54 x 24 x 30	108	5.25	\$675	\$807	N/A	\$286
Z244816RL	48 x 24 x 30	100	4.25	\$619	\$739	N/A	\$230
Z244216RL	42 x 24 x 30	88	4	\$557	\$665	N/A	\$230
Z243616RL	36 x 24 x 30	78	3.5	\$503	\$595	N/A	\$171
Z207216RL	72 x 20 x 30	123	6	\$732	\$876	N/A	\$344
Z206616RL	66 x 20 x 30	114	5.75	\$700	\$831	N/A	\$344
Z206016RL	60 x 20 x 30	106	5.25	\$655	\$776	N/A	\$286
Z205416RL	54 x 20 x 30	98	5.25	\$616	\$727	N/A	\$286
Z204816RL	48 x 20 x 30	90	4.25	\$565	\$668	N/A	\$230
Z204216RL	42 x 20 x 30	80	4	\$507	\$596	N/A	\$230
Z203616RL	36 x 20 x 30	70	3.5	\$457	\$535	N/A	\$171

16" throat. Return has **no pedestal**. Grommet in worksurface. For use with extended corners, desks and islands with 16" throat. Accepts same depth storage shells under worksurface, see pages 169-175. Shipped easy to assemble in 1 carton.

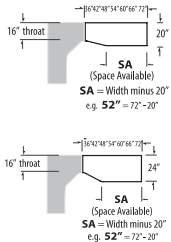
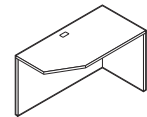

Space Saver Return - RIGHT

Z247216RR	72 x 24 x 30	135	6	\$802	\$973	N/A	\$344
Z246616RR	66 x 24 x 30	127	5.75	\$763	\$923	N/A	\$344
Z246016RR	60 x 24 x 30	118	5.25	\$716	\$862	N/A	\$286
Z245416RR	54 x 24 x 30	108	5.25	\$675	\$807	N/A	\$286
Z244816RR	48 x 24 x 30	100	4.25	\$619	\$739	N/A	\$230
Z244216RR	42 x 24 x 30	88	4	\$557	\$665	N/A	\$230
Z243616RR	36 x 24 x 30	78	3.5	\$503	\$595	N/A	\$171
Z207216RR	72 x 20 x 30	123	6	\$732	\$876	N/A	\$344
Z206616RR	66 x 20 x 30	114	5.75	\$700	\$831	N/A	\$344
Z206016RR	60 x 20 x 30	106	5.25	\$655	\$776	N/A	\$286
Z205416RR	54 x 20 x 30	98	5.25	\$616	\$727	N/A	\$286
Z204816RR	48 x 20 x 30	90	4.25	\$565	\$668	N/A	\$230
Z204216RR	42 x 20 x 30	80	4	\$507	\$596	N/A	\$230
Z203616RR	36 x 20 x 30	70	3.5	\$457	\$535	N/A	\$171

16" throat. Return has **no pedestal**. Grommet in worksurface. For use with extended corners, desks and islands with 16" throat. Accepts same depth storage shells under worksurface, see pages 169-175. Shipped easy to assemble in 1 carton.

Required specifications

Top finish
Top thickness/edge detail
Base finish

Optional specifications

Additional grommets
HP laminate

Accessories

Power block

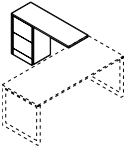
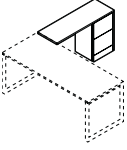
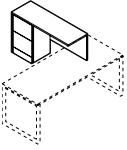
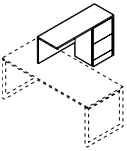
FULL TO FLOOR RETURNS	MODEL #	DIMENSIONS	WT/LB.	CUBIC FT.	1" TOP	1.5" TOP	GLAZE ADD	HP ADD
		W x D x H (1.5" TOP)						
	Z2448NRL	48 x 24 x 30	127	24.25	\$1318	\$1437	N/A	\$316
	Z2442NRL	42 x 24 x 30	123	21.25	\$1305	\$1410	N/A	\$276
	Z2048NRL	48 x 20 x 30	114	20.5	\$1241	\$1340	N/A	\$263
	Z2042NRL	42 x 20 x 30	111	18	\$1211	\$1299	N/A	\$231
Full to Floor Return, No Modesty - LEFT	Full to the floor, locking file/file pedestal and no modesty. File/file pedestal on left . Shipped easy to assemble in 1 carton.							
	Z2448NRR	48 x 24 x 30	127	24.25	\$1318	\$1437	N/A	\$316
	Z2442NRR	42 x 24 x 30	123	21.25	\$1305	\$1410	N/A	\$276
	Z2048NRR	48 x 20 x 30	114	20.5	\$1241	\$1340	N/A	\$263
	Z2042NRR	42 x 20 x 30	111	18	\$1211	\$1299	N/A	\$231
Full to Floor Return, No Modesty - RIGHT	Full to the floor, locking file/file pedestal and no modesty. File/file pedestal on right . Shipped easy to assemble in 1 carton.							
	Z2448SRL	48 x 24 x 30	135	24.25	\$1434	\$1551	N/A	\$316
	Z2442SRL	42 x 24 x 30	130	21.25	\$1410	\$1515	N/A	\$276
	Z2048SRL	48 x 20 x 30	123	20.5	\$1357	\$1455	N/A	\$263
	Z2042SRL	42 x 20 x 30	119	18	\$1316	\$1404	N/A	\$231
Full to Floor Return - LEFT	Full to the floor, locking file/file on left . 12"H modesty panel. Shipped easy to assemble in 1 carton.							
	Z2448SRR	48 x 24 x 30	135	24.25	\$1434	\$1551	N/A	\$316
	Z2442SRR	42 x 24 x 30	130	21.25	\$1410	\$1515	N/A	\$276
	Z2048SRR	48 x 20 x 30	123	20.5	\$1357	\$1455	N/A	\$263
	Z2042SRR	42 x 20 x 30	119	18	\$1316	\$1404	N/A	\$231
Full to Floor Return - RIGHT	Full to the floor, locking file/file on right . 12"H modesty panel. Shipped easy to assemble in 1 carton.							

Required specifications

- Top finish
- Top/edge detail
- Base finish
- Lock finish

Optional specifications

- HP laminate
- Key #*
- Grommet position or power block cut-out
- Handles

Accessories

- Pencil drawer
- Keyboard
- Power block

FULL TO FLOOR FLUSH RETURNS

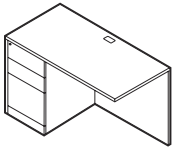

Full to Floor Flush Return - LEFT*

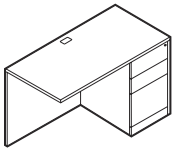

Full to Floor Flush Return - RIGHT*

MODEL #	DIMENSIONS	WT/LB.	CUBIC FT.	1" TOP	1.5" TOP	GLAZE ADD	HP ADD
W x D x H (1.5" TOP)							
Z24723L	72 x 24 x 30	215	35.75	\$1653	\$1789	N/A	\$345
Z24663L	66 x 24 x 30	202	32.75	\$1626	\$1762	N/A	\$330
Z24603L	60 x 24 x 30	188	30	\$1531	\$1667	N/A	\$330
Z24543L	54 x 24 x 30	179	29.75	\$1478	\$1614	N/A	\$330
Z24483L	48 x 24 x 30	167	24.25	\$1396	\$1532	N/A	\$263
Z20723L	72 x 20 x 30	183	30.25	\$1520	\$1656	N/A	\$345
Z20663L	66 x 20 x 30	173	27.75	\$1472	\$1608	N/A	\$330
Z20603L	60 x 20 x 30	162	25.25	\$1443	\$1579	N/A	\$330
Z20543L	54 x 20 x 30	154	23	\$1393	\$1529	N/A	\$330
Z20483L	48 x 20 x 30	144	20.5	\$1360	\$1496	N/A	\$263

Standard with box/box/file pedestal on **left**. Grommet in worksurface. One pencil tray. File drawer and lower box drawer locking. Shipped assembled in 1 carton.

Z24723R	72 x 24 x 30	215	35.75	\$1653	\$1789	N/A	\$345
Z24663R	66 x 24 x 30	202	32.75	\$1626	\$1762	N/A	\$330
Z24603R	60 x 24 x 30	188	30	\$1531	\$1667	N/A	\$330
Z24543R	54 x 24 x 30	179	29.75	\$1478	\$1614	N/A	\$330
Z24483R	48 x 24 x 30	167	24.25	\$1396	\$1532	N/A	\$263
Z20723R	72 x 20 x 30	183	30.25	\$1520	\$1656	N/A	\$345
Z20663R	66 x 20 x 30	173	27.75	\$1472	\$1608	N/A	\$330
Z20603R	60 x 20 x 30	162	25.25	\$1443	\$1579	N/A	\$330
Z20543R	54 x 20 x 30	154	23	\$1393	\$1529	N/A	\$330
Z20483R	48 x 20 x 30	144	20.5	\$1360	\$1496	N/A	\$263

Standard with box/box/file pedestal on **right**. Grommet in worksurface. One pencil tray. File drawer and lower box drawer locking. Shipped assembled in 1 carton.

FLUSH BRIDGES

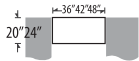
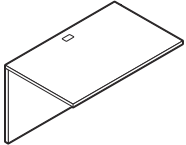

Flush Bridge

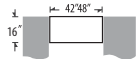
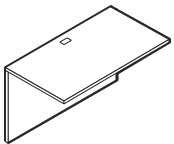

Flush Bridge

W x D x H (1.5" TOP)							
Z2448FB	48 x 24 x 30	100	4.3	\$673	\$784	N/A	\$263
Z2442FB	42 x 24 x 30	86	3.8	\$673	\$772	N/A	\$222
Z2436FB	36 x 24 x 30	69	3.3	\$626	\$738	N/A	\$167
Z2048FB	48 x 20 x 30	92	4.3	\$515	\$607	N/A	\$222
Z2042FB	42 x 20 x 30	80	3.8	\$490	\$609	N/A	\$222
Z2036FB	36 x 20 x 30	63	3.3	\$464	\$563	N/A	\$167

Top surface, back panel and hardware to create a "U" shape by connecting two units with full end panels. Grommet in worksurface. Shipped assembled in 1 carton.

Z1648B	48 x 15.8 x 30	66	4.25	\$448	\$532	N/A	\$171
Z1642B	42 x 15.8 x 30	60	3.75	\$389	\$465	N/A	\$171

16" throat. Top surface, back panel and hardware to create a "U" shape by connecting two units with a 16" throat and full end panels. Grommet in worksurface. Shipped easy to assemble in 1 carton.

Required specifications

Top finish
Top thickness/edge detail
Base finish

Optional specifications

HP laminate
Grommet position or power block cut-out

Accessories

Pencil drawer
Power block

SPACE SAVER BRIDGES

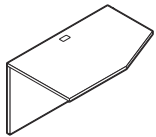

Space Saver Bridge - LEFT

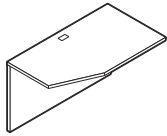
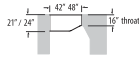

Space Saver Bridge - RIGHT

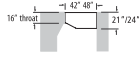

MODEL #	DIMENSIONS	WT/LB.	CUBIC FT.	1" TOP	1.5" TOP	GLAZE ADD	HP ADD
W x D x H (1.5" TOP)							
Z244816BL	48 x 24 x 30	82	4.25	\$520	\$640	N/A	\$230
Z244216BL	42 x 24 x 30	71	3.75	\$458	\$566	N/A	\$230
Z214816BL	48 x 21 x 30	76	4.25	\$483	\$586	N/A	\$230
Z214216BL	42 x 21 x 30	65	3.75	\$419	\$508	N/A	\$230

16" throat. Top surface, back panel and hardware to connect extended corners, desks and islands with a 16" throat. Grommet in worksurface. Shipped easy to assemble in 1 carton.

Z244816BR	48 x 24 x 30	82	4.25	\$520	\$640	N/A	\$230
Z244216BR	42 x 24 x 30	71	3.75	\$458	\$566	N/A	\$230
Z214816BR	48 x 21 x 30	76	4.25	\$483	\$586	N/A	\$230
Z214216BR	42 x 21 x 30	65	3.75	\$419	\$508	N/A	\$230

16" throat. Top surface, back panel and hardware to connect extended corners, desks and islands with a 16" throat. Grommet in worksurface. Shipped easy to assemble in 1 carton.

TRANSITIONAL BRIDGES

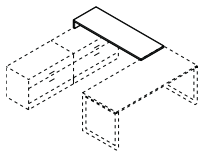

Overlapping Bridge - LEFT*

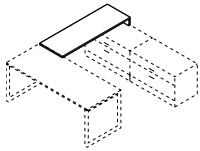

Overlapping Bridge - RIGHT*

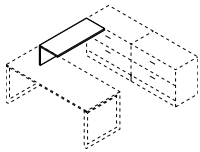

Flush Bridge

MODEL #	DIMENSIONS	WT/LB.	CUBIC FT.	1" TOP	1.5" TOP	GLAZE ADD	HP ADD
W x D x H (1.5" TOP)							
Z2468TRL	68 x 24 x 5.9	64	5.25	\$662	\$835	N/A	\$448
Z2462TRL	62 x 24 x 5.9	59	4.7	\$617	\$774	N/A	\$408
Z2472TRL	72 x 24 x 5.9	64	5.25	\$674	\$848	N/A	\$473
Z2466TRL	66 x 24 x 5.9	62	4.7	\$634	\$791	N/A	\$436

For 20"/24"D, 23.75"/24.25"H storage with no modesty. Overlaps storage on **right**. Shipped easy to assemble in 1 carton.

- Use Z2462TRR and Z2468TRR for 20"D storage.
- Use Z2466TRR and Z2472TRR for 24"D storage.

Z2468TRR	68 x 24 x 5.9	64	5.25	\$662	\$835	N/A	\$448
Z2462TRR	62 x 24 x 5.9	59	4.7	\$617	\$774	N/A	\$408
Z2472TRR	72 x 24 x 5.9	64	5.25	\$674	\$848	N/A	\$473
Z2466TRR	66 x 24 x 5.9	62	4.7	\$634	\$791	N/A	\$436

For 20"/24"D, 23.75"/24.25"H storage with no modesty. Overlaps storage on **left**. Shipped easy to assemble in 1 carton.

- Use Z2462TRR and Z2468TRR for 20"D storage.
- Use Z2466TRR and Z2472TRR for 24"D storage.

Z24483BR	48 x 24 x 13.5	55	3.5	\$745	\$901	N/A	\$316
Z24423BR	42 x 24 x 13.5	48	3.1	\$684	\$825	N/A	\$276
Z24363BR	36 x 24 x 13.5	43	2.7	\$626	\$747	N/A	\$237
Z20483BR	48 x 20 x 13.5	48	3	\$691	\$825	N/A	\$263
Z20423BR	42 x 20 x 13.5	43	2.7	\$637	\$756	N/A	\$231
Z20363BR	36 x 20 x 13.5	38	2.4	\$583	\$686	N/A	\$198

For use with storage models ZxxxxBBOL/R and ZxxxxBLFL/R. 12"H modesty panel. Shipped easy to assemble in 1 carton.

Required specifications

Top finish
Top/edge detail
Base finish

Optional specifications

HP laminate
Grommet position or power block cut-out

Accessories

Power block
Pencil drawer*

TRANSITIONAL BRIDGES **MODEL #** **DIMENSIONS** **WT/LB.** **CUBIC FT.** **1" TOP** **1.5" TOP** **GLAZE ADD** **HP ADD**

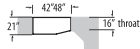
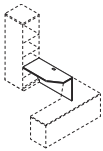

Transitional Bridge - LEFT

For 21" wide storage module. Top surface, back panel, shorter kickbase and hardware included to connect 21" wide storage module with 16" throat. Grommet in worksurface. Shipped easy to assemble in 1 carton.

		W x D x H (1.5" TOP)						
Z2148TRBL	48 x 21 x 30	76	4.25	\$506	\$609	N/A	\$230	
Z2142TRBL	42 x 21 x 30	65	3.75	\$438	\$527	N/A	\$230	

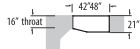
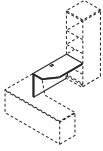

Transitional Bridge - RIGHT

For 21" wide storage module. Top surface, back panel, shorter kickbase and hardware included to connect 21" wide storage module with 16" throat. Grommet in worksurface. Shipped easy to assemble in 1 carton.

Z2148TRBR	48 x 21 x 30	76	4.25	\$506	\$609	N/A	\$230	
Z2142TRBR	42 x 21 x 30	65	3.75	\$438	\$527	N/A	\$230	

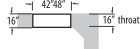
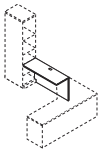

Transitional Bridge - LEFT

For 16" wide storage module. Top surface, back panel and hardware to connect 16" wide storage module with 16" throat. Grommet in worksurface. Shipped easy to assemble in 1 carton.

Z1648TRBL	48 x 16 x 30	69	4.25	\$466	\$550	N/A	\$171	
Z1642TRBL	42 x 16 x 30	59	3.75	\$409	\$485	N/A	\$171	

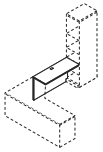

Transitional Bridge - RIGHT

For 16" wide storage module. Top surface, back panel and hardware to connect 16" wide storage module with 16" throat. Grommet in worksurface. Shipped easy to assemble in 1 carton.

Z1648TRBR	48 x 16 x 30	69	4.25	\$466	\$550	N/A	\$171	
Z1642TRBR	42 x 16 x 30	59	3.75	\$409	\$485	N/A	\$171	

Required specifications

- Top finish
- Top thickness/edge detail
- Base finish

Optional specifications

- HP laminate
- Grommet position or power block cut-out

Accessories

- Power block

18"H CREDENZAS **MODEL #** **DIMENSIONS** **WT/LB.** **CUBIC FT.** **1" TOP** **1.5" TOP** **GLAZE ADD** **HP ADD**

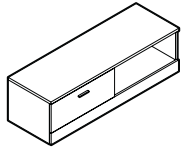

Lateral File Credenza - LEFT

W x D x H (1.5" TOP)

Z2472LOFL	72 x 24 x 18.37	181	22.75	\$1834	\$1984	N/A	\$473
Z2460LOFL	60 x 24 x 18.37	160	19.25	\$1628	\$1752	N/A	\$395
Z2072LOFL	72 x 20 x 18.37	164	19.25	\$1707	\$1830	N/A	\$395
Z2060LOFL	60 x 20 x 18.37	143	16.25	\$1505	\$1610	N/A	\$329

1 high lateral file on the **left**, open storage on the **right**. Shipped assembled in 1 carton.

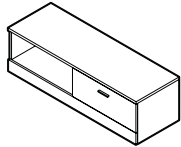

Lateral File Credenza - RIGHT

Z2472LOFR	72 x 24 x 18.37	181	22.75	\$1834	\$1984	N/A	\$473
Z2460LOFR	60 x 24 x 18.37	160	19.25	\$1628	\$1752	N/A	\$395
Z2072LOFR	72 x 20 x 18.37	164	19.25	\$1707	\$1830	N/A	\$395
Z2060LOFR	60 x 20 x 18.37	143	16.25	\$1505	\$1610	N/A	\$329

1 high lateral file on the **right**, open storage on the **left**. Shipped assembled in 1 carton.

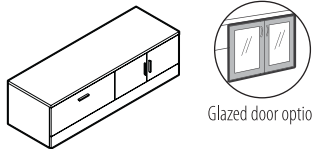

Glazed door option

Lateral File Credenza - LEFT*

Z2472LSFL	72 x 24 x 18.37	197	22.75	\$2135	\$2285	\$469	\$473
Z2460LSFL	60 x 24 x 18.37	174	19.25	\$1925	\$2049	\$417	\$395
Z2072LSFL	72 x 20 x 18.37	178	19.25	\$2002	\$2126	\$469	\$395
Z2060LSFL	60 x 20 x 18.37	155	16.25	\$1795	\$1900	\$417	\$329

1 high lateral file on the **left**, closed hinged door storage on the **right**. Shipped assembled in 1 carton.

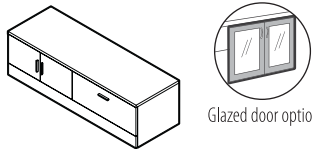

Glazed door option

Lateral File Credenza - RIGHT*

Z2472LSFR	72 x 24 x 18.37	197	22.75	\$2135	\$2285	\$469	\$473
Z2460LSFR	60 x 24 x 18.37	174	19.25	\$1925	\$2049	\$417	\$395
Z2072LSFR	72 x 20 x 18.37	178	19.25	\$2002	\$2126	\$469	\$395
Z2060LSFR	60 x 20 x 18.37	155	16.25	\$1795	\$1900	\$469	\$329

1 high lateral file on the **right**, closed hinged door storage on the **left**. Shipped assembled in 1 carton.

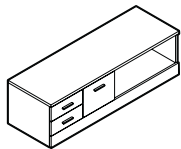

Mixed Storage Credenza - LEFT

Z2472LMOL	72 x 24 x 18.37	197	22.75	\$2111	\$2261	N/A	\$473
Z2460LMOL	60 x 24 x 18.37	176	19.25	\$1926	\$2050	N/A	\$395
Z2072LMOL	72 x 20 x 18.37	178	19.25	\$1978	\$2101	N/A	\$395
Z2060LMOL	60 x 20 x 18.37	157	16.25	\$1797	\$1902	N/A	\$329

1 high mixed drawers on the **left**, open storage on the **right**. Shipped assembled in 1 carton.

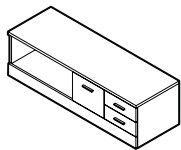

Mixed Storage Credenza - RIGHT

Z2472LMOR	72 x 24 x 18.37	197	22.75	\$2111	\$2261	N/A	\$473
Z2460LMOR	60 x 24 x 18.37	176	19.25	\$1928	\$2050	N/A	\$395
Z2072LMOR	72 x 20 x 18.37	178	19.25	\$1978	\$2101	N/A	\$395
Z2060LMOR	60 x 20 x 18.37	157	16.25	\$1797	\$1902	N/A	\$329

1 high mixed drawers on the **right**, open storage on the **left**. Shipped assembled in 1 carton.

Required specifications

- Top finish
- Top/edge detail
- Base finish
- Handles

Optional specifications

- HP laminate
- Key #
- Glazed hinged doors*
- Box drawer - no upcharge

24" H CREDENZAS

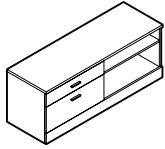

Lateral File Credenza - LEFT

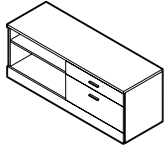

Lateral File Credenza - RIGHT

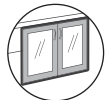
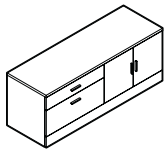

Glazed door option

Lateral File Credenza - LEFT*

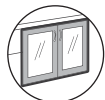
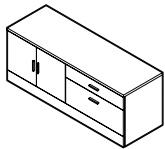

Glazed door option

Lateral File Credenza - RIGHT*

MODEL #	DIMENSIONS W x D x H (1.5" TOP)	WT/LB.	CUBIC FT.	1" TOP	1.5" TOP	GLAZE ADD	HP ADD
Z2472HBFL	72 x 24 x 24.25	229	29.25	\$2298	\$2448	N/A	\$473
Z2460HBFL	60 x 24 x 24.25	201	24.5	\$2035	\$2159	N/A	\$395
Z2072HBFL	72 x 20 x 24.25	207	24.75	\$2160	\$2284	N/A	\$395
Z2060HBFL	60 x 20 x 24.25	180	20.75	\$1905	\$2010	N/A	\$329

1.5 high box/lateral file on the **left**, open storage on the **right**. Shipped assembled in 1 carton.

Z2472HBFR	72 x 24 x 24.25	229	29.25	\$2298	\$2448	N/A	\$473
Z2460HBFR	60 x 24 x 24.25	201	24.5	\$2035	\$2159	N/A	\$395
Z2072HBFR	72 x 20 x 24.25	207	24.75	\$2160	\$2284	N/A	\$395
Z2060HBFR	60 x 20 x 24.25	180	20.75	\$1905	\$2010	N/A	\$329

1.5 high box/lateral file on the **right**, open storage on the **left**. Shipped assembled in 1 carton.

Z2472HFSL	72 x 24 x 24.25	251	29.25	\$2688	\$2838	\$645	\$473
Z2460HFSL	60 x 24 x 24.25	221	24.5	\$2399	\$2523	\$558	\$395
Z2072HFSL	72 x 20 x 24.25	227	24.75	\$2526	\$2650	\$645	\$395
Z2060HFSL	60 x 20 x 24.25	198	20.75	\$2255	\$2360	\$558	\$329

1.5 high box/lateral file on the **left**, closed hinged door storage on the **right**. Shipped assembled in 1 carton.

Z2472HFSL	72 x 24 x 24.25	251	29.25	\$2688	\$2838	\$645	\$473
Z2460HFSL	60 x 24 x 24.25	221	24.5	\$2399	\$2523	\$558	\$395
Z2072HFSL	72 x 20 x 24.25	227	24.75	\$2526	\$2650	\$645	\$395
Z2060HFSL	60 x 20 x 24.25	198	20.75	\$2255	\$2360	\$558	\$329

1.5 high box/lateral file on the **right**, closed hinged door storage on the **left**. Shipped assembled in 1 carton.

Required specifications

Top finish
Top/edge detail
Base finish
Handles

Optional specifications

HP laminate
Key #
Glazed hinged doors*
Box drawer - no upcharge

CRENZAS	MODEL #	DIMENSIONS	WT/LB.	CUBIC FT.	1" TOP	1.5" TOP	GLAZE ADD	HP ADD
---------	---------	------------	--------	-----------	--------	----------	-----------	--------

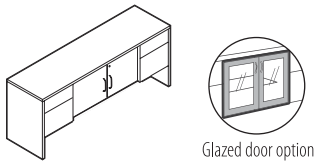

Center Storage Credenza**

	W x D x H (1.5" TOP)							
Z2072C	72 x 20 x 30	261	30	\$1936	\$2482	\$641	\$345	

Standard with box/file pedestals on both sides and self-closing hinged center doors covering one adjustable shelf. Pedestals and doors lock, keyed alike. Two pencil trays. Modesty panel 1" from floor for wire cord escape. Shipped assembled in 1 carton.

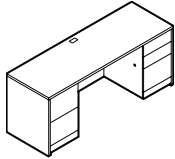

Full to Floor Kneespace Credenza

Z2472D4	72 x 24 x 30	282	35.5	\$2305	\$2512	N/A	\$358
Z2466D4	66 x 24 x 30	272.48	33	\$2305	\$2446	N/A	\$330
Z2072D4	72 x 20 x 30	258	30	\$2224	\$2399	N/A	\$345
Z2066D4	66 x 20 x 30	248	27.75	\$2224	\$2360	N/A	\$330
Z2060D4	60 x 20 x 30	238	25.25	\$2153	\$2265	N/A	\$304

Standard with box/box/file pedestal on the right and file/file pedestal on the left. Center is open. File drawer and lower box drawer locking, keyed alike. One pencil tray. Grommet in worksurface. Modesty panel 1" from floor for wire cord escape. Shipped assembled in 1 carton.

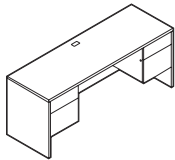

Kneespace Credenza*

Z2472CK	72 x 24 x 30	262	35.5	\$1867	\$2139	N/A	\$358
Z2466CK	66 x 24 x 30	250	33	\$1867	\$2072	N/A	\$330
Z2072CK	72 x 20 x 30	228	30	\$1599	\$1752	N/A	\$345
Z2066CK	66 x 20 x 30	218	27.75	\$1599	\$1712	N/A	\$330
Z2060CK	60 x 20 x 30	209	25.25	\$1566	\$1651	N/A	\$304

Standard with box/file pedestals on both sides. Center is open. Pedestals lock, keyed alike. Two pencil trays. Grommet in worksurface. Modesty panel 1" from floor for wire cord escape. Shipped assembled in 1 carton.

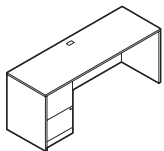

Full to Floor Single Pedestal Credenza - LEFT

Z2472S2L	72 x 24 x 30	228	35.5	\$1586	\$1864	N/A	\$345
Z2466S2L	66 x 24 x 30	217	33	\$1586	\$1788	N/A	\$330
Z2072S2L	72 x 20 x 30	203	30	\$1498	\$1689	N/A	\$345
Z2066S2L	66 x 20 x 30	194	27.75	\$1498	\$1650	N/A	\$345
Z2060S2L	60 x 20 x 30	184	25.25	\$1432	\$1544	N/A	\$304

Standard with full to floor file/file pedestal on the **left**. Pedestal locks. Grommet in worksurface. Modesty panel 1" from floor for wire cord escape. Shipped assembled in 1 carton.

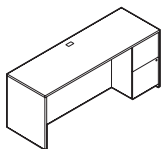

Full to Floor Single Pedestal Credenza - RIGHT

Z2472S2R	72 x 24 x 30	228	35.5	\$1586	\$1864	N/A	\$345
Z2466S2R	66 x 24 x 30	217	33	\$1586	\$1788	N/A	\$330
Z2072S2R	72 x 20 x 30	203	30	\$1498	\$1689	N/A	\$345
Z2066S2R	66 x 20 x 30	194	27.75	\$1498	\$1650	N/A	\$345

Standard with full to floor file/file pedestal on the **right**. Pedestal locks. Grommet in worksurface. Modesty panel 1" from floor for wire cord escape. Shipped assembled in 1 carton.

Required specifications

Top finish
 Top thickness/edge detail
 Base finish
 Lock finish

Optional specifications

HP laminate
 Key #
 Modesty type*
 Grommet position or power block cut-out

Accessories

Pencil drawer (Z2472S2L/R only)
 Power block (not Z2072C)

CREDENZAS	MODEL #	DIMENSIONS	WT/LB.	CUBIC FT.	1" TOP	1.5" TOP	GLAZE ADD	HP ADD
-----------	---------	------------	--------	-----------	--------	----------	-----------	--------

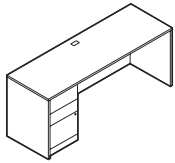

Full to Floor Single Pedestal Credenza - LEFT*

	W x D x H (1.5" TOP)							
Z2472S4L	72 x 24 x 30	225	35.5	\$1738	\$1807	N/A	\$345	
Z2466S4L	66 x 24 x 30	215	33	\$1582	\$1737	N/A	\$330	
Z2072S4L	72 x 20 x 30	205	30	\$1467	\$1640	N/A	\$345	
Z2066S4L	66 x 20 x 30	195	27.75	\$1467	\$1599	N/A	\$345	
Z2060S4L	60 x 20 x 30	185	25.25	\$1389	\$1501	N/A	\$304	

Standard with full to floor box/box/file pedestal on the **left**. File drawer and lower box drawer locking. One pencil tray. Grommet in worksurface. Modesty panel 1" from floor for wire cord escape. Shipped assembled in 1 carton.

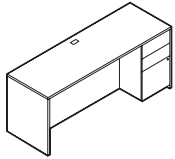

Full to Floor Single Pedestal Credenza - RIGHT*

Z2472S4R	72 x 24 x 30	225	35.5	\$1738	\$1807	N/A	\$345	
Z2466S4R	66 x 24 x 30	215	33	\$1582	\$1737	N/A	\$330	
Z2072S4R	72 x 20 x 30	205	30	\$1467	\$1640	N/A	\$345	
Z2066S4R	66 x 20 x 30	195	27.75	\$1467	\$1599	N/A	\$345	
Z2060S4R	60 x 20 x 30	185	25.25	\$1389	\$1501	N/A	\$304	

Standard with full to floor box/box/file pedestal on the **right**. File drawer and lower box drawer locking. One pencil tray. Grommet in worksurface. Modesty panel 1" from floor for wire cord escape. Shipped assembled in 1 carton.

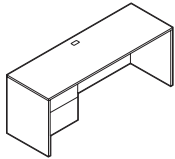

Single Pedestal Credenza - LEFT*

Z2472CSL	72 x 24 x 30	210	35.75	\$1503	\$1631	N/A	\$358	
Z2466CSL	66 x 24 x 30	199	32.75	\$1503	\$1561	N/A	\$330	
Z2072CSL	72 x 20 x 30	190	30.25	\$1275	\$1428	N/A	\$345	
Z2066CSL	66 x 20 x 30	180	27.75	\$1275	\$1387	N/A	\$330	
Z2060CSL	60 x 20 x 30	171	25.25	\$1205	\$1296	N/A	\$304	

Standard with box/file pedestal on the **left**. Pedestal locks. One pencil tray. Grommet in worksurface. Modesty panel 1" from floor for wire cord escape. Shipped assembled in 1 carton.

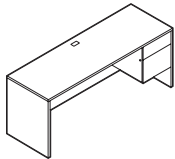

Single Pedestal Credenza - RIGHT*

Z2472CSR	72 x 24 x 30	210	35.75	\$1503	\$1631	N/A	\$358	
Z2466CSR	66 x 24 x 30	199	32.75	\$1503	\$1561	N/A	\$330	
Z2072CSR	72 x 20 x 30	190	30	\$1275	\$1428	N/A	\$345	
Z2066CSR	66 x 20 x 30	180	27.75	\$1275	\$1387	N/A	\$330	
Z2060CSR	60 x 20 x 30	171	25.25	\$1205	\$1296	N/A	\$304	

Standard with box/file pedestal on the **right**. Pedestal locks. One pencil tray. Grommet in worksurface. Modesty panel 1" from floor for wire cord escape. Shipped assembled in 1 carton.

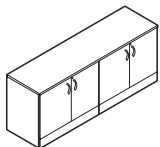

Glazed door option

Storage Cabinet Credenza**

Z2472SCSC	72 x 24 x 30	290	35.75	\$2196	\$2342	\$799	\$345	
Z2072SCSC	72 x 20 x 30	263	30.25	\$1992	\$2123	\$799	\$345	

Two storage cabinets side-by-side. Hinged doors cover one adjustable shelf. Locking doors keyed alike. Shipped assembled in 1 carton.

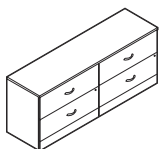

Storage Cabinet Credenza

Z2472LF2	72 x 24 x 30	345	35.75	\$2885	\$3148	N/A	\$345	
Z2072LF2	72 x 20 x 30	315	30.25	\$2826	\$3089	N/A	\$345	

Two 2-drawer lateral files side-by-side. Locking drawers, keyed alike. File bars included for side-to-side and front-to-back letter/legal filing capability. Anti-lock tilt suspension. Shipped assembled in 1 carton.

Required specifications

Top finish
Top thickness/edge detail
Base finish
Lock finish*

Optional specifications

HP laminate
Key # (not Z2x72SCSC)
Grommet position or power block cut-out (not Z2x72LF2)

Handles
Glazed doors**

Accessories

Pencil drawer**
Power block*

CREENZAS	MODEL #	DIMENSIONS	WT/LB.	CUBIC FT.	1" TOP	1.5" TOP	GLAZE ADD	HP ADD
----------	---------	------------	--------	-----------	--------	----------	-----------	--------

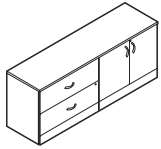

Glazed door option

Lateral File/Storage Cabinet Credenza*

One 2-drawer lateral file and one storage cabinet. Locking door/drawers, keyed alike. Storage cabinet includes one adjustable shelf. File bars included for side-to-side and front-to-back letter/legal filing capability. Anti-lock tilt suspension. Shipped assembled in 1 carton.

- File drawer construction is for accommodating hanging files NOT for stacking materials on the drawer bottom.

	W x D x H (1.5" TOP)							
Z2472LS	72 x 24 x 30	309	35.75	\$2584	\$2847	\$721		\$345
Z2072LS	72 x 20 x 30	279	30.25	\$2527	\$2793	\$721		\$345

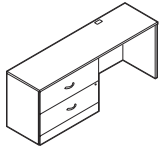

Kneespace Lateral File Credenza - LEFT

One 2-drawer lateral file on the **left**. Locking drawers. File bars included for side-to-side and front-to-back letter/legal filing capability. Anti-lock tilt suspension. Grommet in worksurface. Modesty panel 1" from floor for wire cord escape. Shipped assembled in 1 carton.

- File drawer construction is for accommodating hanging files NOT for stacking materials on the drawer bottom.

Z2472LKL	72 x 24 x 30	262	35.75	\$2273	\$2536	N/A		\$345
Z2072LKL	72 x 20 x 30	235	30.25	\$2213	\$2476	N/A		\$345

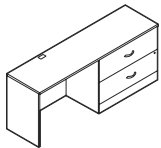

Kneespace Lateral File Credenza - RIGHT

One 2-drawer lateral file on the **right**. Locking drawers. File bars included for side-to-side and front-to-back letter/legal filing capability. Anti-lock tilt suspension. Grommet in worksurface. Modesty panel 1" from floor for wire cord escape. Shipped assembled in 1 carton.

- File drawer construction is for accommodating hanging files NOT for stacking materials on the drawer bottom.

Z2472LKR	72 x 24 x 30	262	35.75	\$2273	\$2536	N/A		\$345
Z2072LKR	72 x 20 x 30	235	30.25	\$2213	\$2476	N/A		\$345

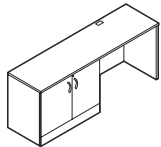

Glazed door option

Kneespace Storage Cabinet Credenza - LEFT*

One storage cabinet on the **left**. Locking doors. Storage cabinet has one adjustable shelf. Grommet in worksurface. Modesty panel 1" from floor for wire cord escape. Shipped assembled in 1 carton.

Z2472SKL	72 x 24 x 30	241	35.75	\$1788	\$2051	\$721		\$345
Z2072SKL	72 x 20 x 30	207	30.25	\$1728	\$1990	\$721		\$345

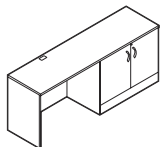

Glazed door option

Kneespace Storage Cabinet Credenza - RIGHT*

One storage cabinet on the **right**. Locking doors. Storage cabinet has one adjustable shelf. Grommet in worksurface. Modesty panel 1" from floor for wire cord escape. Shipped assembled in 1 carton.

Z2472SKR	72 x 24 x 30	241	35.75	\$1788	\$2051	\$721		\$345
Z2072SKR	72 x 20 x 30	207	30.25	\$1728	\$1990	\$721		\$345

Required specifications

Top finish
Top thickness/edge detail
Base finish
Handles

Optional specifications

HP laminate
Key #
Grommet position or power block cut-out
Modesty finish glazed (only Z2x72LS)

Accessories

Power block (not Z2x72LS)

CREDENZAS	MODEL #	DIMENSIONS	WT/LB.	CUBIC FT.	1" TOP	1.5" TOP	GLAZE ADD	HP ADD
-----------	---------	------------	--------	-----------	--------	----------	-----------	--------

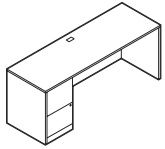

Full to Floor Single Pedestal Credenza - LEFT

	W x D x H (1.5" TOP)							
Z2472CS2L	72 x 24 x 30	288	35.5	\$1586	\$1864	N/A	\$345	
Z2466CS2L	66 x 24 x 30	271	33	\$1586	\$1788	N/A	\$330	
Z2072CS2L	72 x 20 x 30	193	30	\$1498	\$1689	N/A	\$345	
Z2066CS2L	66 x 20 x 30	183	27.75	\$1498	\$1650	N/A	\$330	

Standard with file/file pedestal on the **left**. Pedestal locks. Grommet in worksurface. Shipped assembled in 1 carton.

- File drawer construction is for accommodating hanging files **NOT** for stacking materials on the drawer bottom.

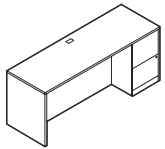

Full to Floor Single Pedestal Credenza - RIGHT

Z2472CS2R	72 x 24 x 30	288	35.5	\$1586	\$1864	N/A	\$345
Z2466CS2R	66 x 24 x 30	271	33	\$1586	\$1788	N/A	\$330
Z2072CS2R	72 x 20 x 30	193	30	\$1498	\$1689	N/A	\$345
Z2066CS2R	66 x 20 x 30	184	27.75	\$1498	\$1650	N/A	\$330

Standard with file/file pedestal on the **right**. Pedestal locks. Grommet in worksurface. Shipped assembled in 1 carton.

- File drawer construction is for accommodating hanging files **NOT** for stacking materials on the drawer bottom.

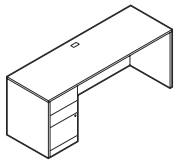

Full to Floor Single Pedestal Credenza - LEFT

Z2472CS4L	72 x 24 x 30	289	35.5	\$1738	\$1807	N/A	\$345
Z2466CS4L	66 x 24 x 30	272	33	\$1582	\$1737	N/A	\$330
Z2072CS4L	72 x 20 x 30	194	30	\$1467	\$1640	N/A	\$345
Z2066CS4L	66 x 20 x 30	185	27.75	\$1467	\$1599	N/A	\$330

Standard with box/box/file pedestal on the **left**. File drawer and lower box drawer locking. One pencil tray. Grommet in worksurface. Shipped assembled in 1 carton.

- File drawer construction is for accommodating hanging files **NOT** for stacking materials on the drawer bottom.

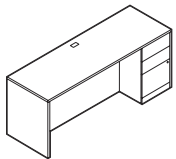

Full to Floor Single Pedestal Credenza - RIGHT

Z2472CS4R	72 x 24 x 30	289	35.5	\$1738	\$1807	N/A	\$345
Z2466CS4R	66 x 24 x 30	272	33	\$1582	\$1737	N/A	\$330
Z2072CS4R	72 x 20 x 30	194	30	\$1467	\$1640	N/A	\$345
Z2066CS4R	66 x 20 x 30	185	27.75	\$1467	\$1599	N/A	\$330

Standard with box/box/file pedestal on the **right**. File drawer and lower box drawer locking. One pencil tray. Grommet in worksurface. Shipped assembled in 1 carton.

- File drawer construction is for accommodating hanging files **NOT** for stacking materials on the drawer bottom.

Required specifications

Top finish
Top thickness/edge detail
Base finish
Lock finish

Optional specifications

HP laminate
Handles
Key #
Grommet position or power block cut-out

Accessories

Pencil drawer
Power block

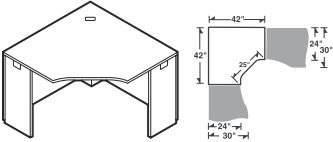
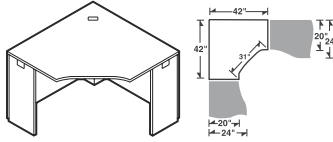
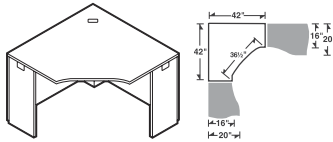
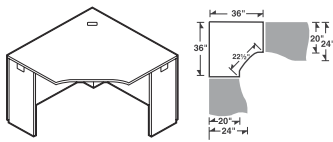
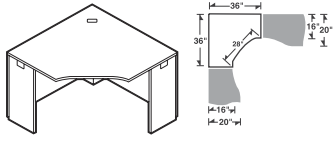
5-SIDED CORNERS	MODEL #	DIMENSIONS W x D x H (1.5" TOP)	WT/LB.	CUBIC FT.	1" TOP	1.5" TOP	GLAZE ADD	HP ADD
 <p>5-Sided Corner, 24" Throat</p>	Z42245C	42 x 42 x 30	132	5.75	\$1117	\$1301	N/A	\$484
<p>Connects to 30"D space saver connectable surfaces, 24"D connectables, returns and bridge. Grommet in worksurface. Narrow end panels on left and right. Not freestanding. Shipped easy to assemble in 1 carton.</p> <ul style="list-style-type: none"> • Modesty panel is 1" off of ground. 								
 <p>5-Sided Corner, 20" Throat</p>	Z42205C	42 x 42 x 30	128	5.75	\$1117	\$1301	N/A	\$484
<p>Connects to 24"D space saver connectable surfaces, 20"D returns, lateral files, storage/lateral file credenzas, credenzas, and bridges. Grommet in worksurface. Narrow end panels on left and right. Not freestanding. Shipped easy to assemble in 1 carton.</p> <ul style="list-style-type: none"> • Modesty panel is 1" off of ground. 								
 <p>5-Sided Corner, 16" Throat</p>	Z42165C	42 x 42 x 30	124	5.75	\$950	\$1093	N/A	\$460
<p>Connects to 20"D space saver connectable surfaces, 16"D returns, lateral files, storage/lateral file credenzas, credenzas, and bridges. Grommet in worksurface. Narrow end panels on left and right. Not freestanding. Shipped easy to assemble in 1 carton.</p> <ul style="list-style-type: none"> • Modesty panel is 1" off of ground. 								
 <p>5-Sided Corner, 20" Throat</p>	Z36205C	36 x 36 x 30	109	4.8	\$954	\$1045	N/A	\$311
<p>Connects to 24"D space saver connectable surfaces, 20"D returns, lateral files, storage/lateral file credenzas, credenzas, and bridges. Grommet in worksurface. Narrow end panels on left and right. Not freestanding. Shipped easy to assemble in 1 carton.</p> <ul style="list-style-type: none"> • Modesty panel is 1" off of ground. 								
 <p>5-Sided Corner, 16" Throat</p>	Z36165C	36 x 36 x 30	105	4.8	\$829	\$938	N/A	\$257
<p>Connects to 20"D space saver connectable surfaces, 16"D returns, lateral files, storage/lateral file credenzas, credenzas, and bridges. Grommet in worksurface. Narrow end panels on left and right. Not freestanding. Shipped easy to assemble in 1 carton.</p> <ul style="list-style-type: none"> • Modesty panel is 1" off of ground. 								

Required specifications

Top finish
Top thickness/edge detail
Base finish

Optional specifications

HP laminate
Modesty type
Grommet position or power block cut-out

Accessories

Power block
Keyboard

LEFT EXT CORNER DESKS

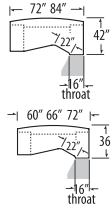
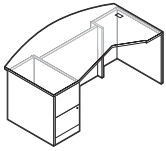

Single Pedestal Bow Top
Extended Corner Desk - LEFT

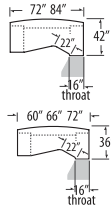
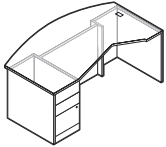

Single Pedestal Bow Top
Extended Corner Desk - LEFT

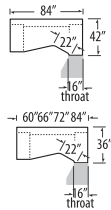
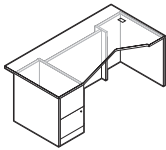

Single Pedestal Extended
Corner Desk - LEFT

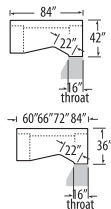
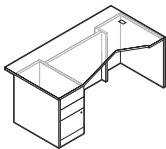

Single Pedestal Extended
Corner Desk - LEFT

MODEL # DIMENSIONS WT/LB. CUBIC FT. 1" TOP 1.5" TOP GLAZE ADD HP ADD

	W x D x H (1.5" TOP)							
Z4284EB2L	84 x 42 x 30		316	20.5	\$2059	\$2331	\$873	\$919
Z4272EB2L	72 x 42 x 30		331	59	\$1945	\$2177	\$721	\$690
Z3672EB2L	72 x 36 x 30		273	50.75	\$1770	\$1977	\$721	\$516
Z3666EB2L	66 x 36 x 30		260	46.75	\$1739	\$1927	\$645	\$516
Z3660EB2L	60 x 36 x 30		257	42.5	\$1691	\$1860	\$570	\$431

Extended worksurface on left. Standard with **freestanding** full to floor file/file pedestal on **left** and faux pedestal on **right**. Pedestal locks. Connects to returns or bridges with a 16" throat. Corner has one grommet. Bow top overhangs 2.25" at ends and 6" on center. Shipped assembled in 1 carton.

- 84" wide desks are shipped easy to assemble in 2 cartons.

Z4284EB3L	84 x 42 x 30		315	20.5	\$2082	\$2354	\$873	\$919
Z4272EB3L	72 x 42 x 30		329	59	\$1969	\$2201	\$721	\$690
Z3672EB3L	72 x 36 x 30		271	50.75	\$1806	\$2013	\$721	\$516
Z3666EB3L	66 x 36 x 30		259	46.75	\$1757	\$1945	\$645	\$516
Z3660EB3L	60 x 36 x 30		255	42.5	\$1727	\$1896	\$570	\$431

Extended worksurface on left. Standard with **freestanding** full to floor box/box/file pedestal on **left** and faux pedestal on **right**. File drawer and lower box drawer locking. Connects to returns or bridges with a 16" throat. Corner has one grommet. Bow top overhangs 2.25" at ends and 6" on center. Shipped assembled in 1 carton.

- 84" wide desks are shipped easy to assemble in 2 cartons.

Z4284E2L	84 x 42 x 30		321	20.5	\$2053	\$2313	\$873	\$919
Z3684E2L	84 x 36 x 30		312	59	\$1968	\$2228	\$873	\$690
Z3672E2L	72 x 36 x 30		278	50.75	\$1766	\$1961	\$721	\$516
Z3666E2L	66 x 36 x 30		266	46.75	\$1716	\$1894	\$645	\$516
Z3660E2L	60 x 36 x 30		259	42.5	\$1687	\$1850	\$570	\$431

Extended worksurface on left. Standard with **freestanding** full to floor file/file pedestal on **left** and faux pedestal on **right**. Pedestal locks. Connects to returns or bridges with a 16" throat. Corner has one grommet. Top overhangs 2.25". Shipped assembled in 1 carton.

- 84" wide desks are shipped easy to assemble in 2 cartons.

Z4284E3L	84 x 42 x 30		318	20.5	\$2077	\$2337	\$873	\$919
Z3684E3L	84 x 36 x 30		310	59	\$2002	\$2262	\$873	\$690
Z3672E3L	72 x 36 x 30		275	50.75	\$1800	\$1995	\$721	\$516
Z3666E3L	66 x 36 x 30		264	46.75	\$1755	\$1933	\$645	\$516
Z3660E3L	60 x 36 x 30		257	42.5	\$1724	\$1887	\$570	\$431

Extended worksurface on left. Standard with **freestanding** full to floor box/box/file pedestal on **left** and faux pedestal on **right**. File drawer and lower box drawer locking. Connects to returns or bridges with a 16" throat. Corner has one grommet. Top overhangs 2.25". Shipped assembled in 1 carton.

- 84" wide desks are shipped easy to assemble in 2 cartons.

Required specifications

Top finish
Top thickness/edge detail
Base finish
Handles

Optional specifications

HP laminate
Key #
Modesty type
Grommet position or power block cut-out

Accessories

Power block
Keyboard

RIGHT EXT CORNER DESKS **MODEL #** **DIMENSIONS** **WT/LB.** **CUBIC FT.** **1" TOP** **1.5" TOP** **GLAZE ADD** **HP ADD**

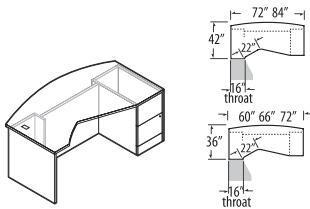

Single Pedestal Bow Top Extended Corner Desk - RIGHT

	W x D x H (1.5" TOP)								
Z4284EB2R	84	42	30	316	41	\$2059	\$2331	\$873	\$919
Z4272EB2R	72	42	30	331	59	\$1945	\$2177	\$721	\$690
Z3672EB2R	72	36	30	273	50.75	\$1770	\$1977	\$721	\$516
Z3666EB2R	66	36	30	260	46.75	\$1739	\$1927	\$645	\$516
Z3660EB2R	60	36	30	257	42.5	\$1691	\$1860	\$570	\$431

Extended worksurface on right. Standard with faux pedestal on **left** and **freestanding** full to floor file/file pedestal on **right**. Pedestal locks. Connects to returns or bridges with a 16" throat. Corner has one grommet. Bow top overhangs 2.25" at ends and 6" on center. Shipped assembled in 1 carton.

- 84" wide desks are shipped easy to assemble in 2 cartons.

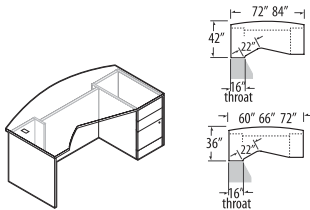

Single Pedestal Bow Top Extended Corner Desk - RIGHT

Z4284EB3R	84	42	30	315	41	\$2082	\$2354	\$873	\$919
Z4272EB3R	72	42	30	329	59	\$1969	\$2201	\$721	\$690
Z3672EB3R	72	36	30	271	50.75	\$1806	\$2013	\$721	\$516
Z3666EB3R	66	36	30	259	46.75	\$1757	\$1945	\$645	\$516
Z3660EB3R	60	36	30	255	42.5	\$1727	\$1896	\$570	\$431

Extended worksurface on right. Standard with faux pedestal on **left** and **freestanding** full to floor box/box/file pedestal on **right**. File drawer and lower box drawer locking. Connects to returns or bridges with a 16" throat. Corner has one grommet. Bow top overhangs 2.25" at ends and 6" on center. Shipped assembled in 1 carton.

- 84" wide desks are shipped easy to assemble in 2 cartons.

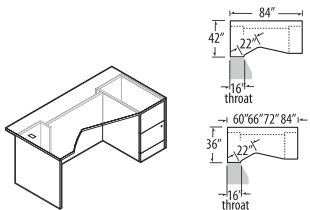

Single Pedestal Extended Corner Desk - RIGHT

Z4284E2R	84	42	30	321	41	\$2053	\$2313	\$873	\$919
Z3684E2R	84	36	30	312	59	\$1968	\$2228	\$873	\$690
Z3672E2R	72	36	30	278	50.75	\$1766	\$1961	\$721	\$516
Z3666E2R	66	36	30	266	46.75	\$1716	\$1894	\$645	\$516
Z3660E2R	60	36	30	259	42.5	\$1687	\$1850	\$570	\$431

Extended worksurface on right. Standard with **freestanding** full to floor file/file pedestal on **right** and faux pedestal on **left**. Pedestal locks. Connects to returns or bridges with a 16" throat. Corner has one grommet. Top overhangs 2.25". Shipped assembled in 1 carton.

- 84" wide desks are shipped easy to assemble in 2 cartons.

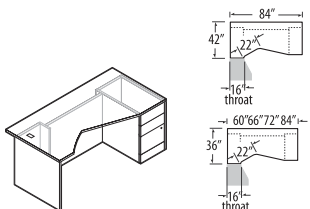

Single Pedestal Extended Corner Desk - RIGHT

Z4284E3R	84	42	30	318	41	\$2077	\$2337	\$873	\$919
Z3684E3R	84	36	30	310	59	\$2002	\$2262	\$873	\$690
Z3672E3R	72	36	30	275	50.75	\$1800	\$1995	\$721	\$516
Z3666E3R	66	36	30	264	46.75	\$1755	\$1933	\$645	\$516
Z3660E3R	60	36	30	257	42.5	\$1724	\$1887	\$570	\$431

Extended worksurface on right. Standard with **freestanding** full to floor box/box/file pedestal on **right** and faux pedestal on **left**. File drawer and lower box drawer locking. Connects to returns or bridges with a 16" throat. Corner has one grommet. Top overhangs 2.25". Shipped assembled in 1 carton.

- 84" wide desks are shipped easy to assemble in 2 cartons.

Required specifications

- Top finish
- Top thickness/edge detail
- Base finish
- Lock finish

Optional specifications

- HP laminate
- Handles
- Key #
- Modesty type
- Grommet position or power block cut-out

Accessories

- Power block
- Keyboard

LEFT EXT CORNERS (DOES NOT CONNECT)

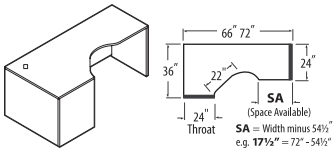

Extended Corner, 24" Throat
Freestanding - LEFT

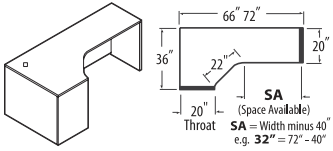

Extended Corner, 20" Throat - LEFT

MODEL # DIMENSIONS WT/LB. CUBIC FT. 1" TOP 1.5" TOP GLAZE ADD HP ADD

	W x D x H (1.5" TOP)						
Z2472FFL	72 x 36 x 30	180	7	\$1356	\$1540	N/A	\$518
Z2466FFL	66 x 36 x 30	172	7	\$1290	\$1454	N/A	\$518

Extended worksurface on right. **Full end panels on left and right. Cannot be connected on left or right, due to full end panel.** Corner has one grommet. Shipped easy to assemble in 1 carton.

- Modesty panel is 1" off of ground.
- Z2466FFL cannot accept pedestals.

Z2072FFL	72 x 36 x 30	168	7	\$1333	\$1538	N/A	\$498
Z2066FFL	66 x 36 x 30	161	7	\$1290	\$1454	N/A	\$498

Extended worksurface on right. **Full end panels on left and right. Can be placed next to** lateral files, storage cabinets, wardrobe units, credenzas and end-shelves. Corner has one grommet. Shipped easy to assemble in 1 carton.

- Modesty panel is 1" off of ground.

LEFT EXT CORNERS (CONNECTS ON EXTENDED SIDE)

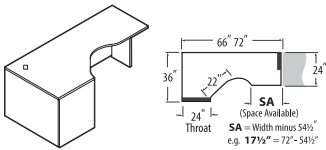

Extended Corner, 24" Throat - LEFT

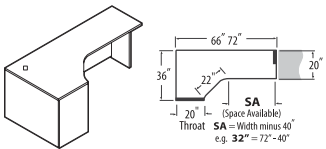

Extended Corner, 20" Throat - LEFT

W x D x H (1.5" TOP)

Z2472FNL	72 x 36 x 30	172	7	\$1333	\$1517	N/A	\$518
Z2466FNL	66 x 36 x 30	164	7	\$1290	\$1431	N/A	\$518

Extended worksurface on right. **Narrow end panel on right. Full end panel on left.** Connects to 30"D space saver connectables, 24"D returns, 24"D connectable tables or "D" and "P" islands with "T" or "H" bases. **Full end panel can be placed next to** lateral files, storage cabinets, wardrobe units, credenzas and end-shelves. Corner has one grommet.

- Shipped easy to assemble in 1 carton.
- Modesty panel is 1" off of ground.
 - Z2466FNL cannot accept pedestals.

Z2072FNL	72 x 36 x 30	163	7	\$1311	\$1516	N/A	\$498
Z2066FNL	66 x 36 x 30	157	7	\$1265	\$1429	N/A	\$498

Extended worksurface on right. **Narrow end panel on right. Full end panel on left.** Connects to 24"D space saver connectables, 20"D returns, 20"D connectable tables or "D" and "P" islands with "T" or "H" bases. **Full end panel can be placed next to** lateral files, storage cabinets, wardrobe units, credenzas and end-shelves. Corner has one grommet.

- Shipped easy to assemble in 1 carton.
- Modesty panel is 1" off of ground.
 - FNL end panels can be switched to make NFL.

Required specifications

Top finish
Top thickness/edge detail
Base finish

Optional specifications

HP laminate
Modesty type
Grommet position or power block cut-out

Accessories

Pencil drawer
Power block
Keyboard

LEFT EXT CORNERS (CONNECTS ON THROAT SIDE)

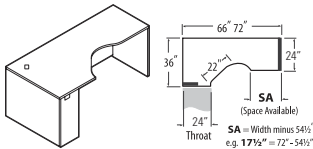

Extended Corner, 24" Throat - LEFT

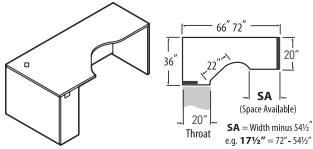

Extended Corner, 20" Throat - LEFT

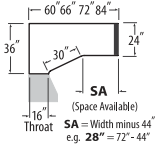

Extended Corner, 16" Throat - LEFT

MODEL #	DIMENSIONS W x D x H (1.5" TOP)	WT/LB.	CUBIC FT.	1" TOP	1.5" TOP	GLAZE ADD	HP ADD
Z2472NFL	72 x 36 x 30	172	7	\$1333	\$1517	N/A	\$518
Z2466NFL	66 x 36 x 30	164	7	\$1290	\$1431	N/A	\$498

Extended worksurface on right. **Narrow end panel on left. Full end panel on right.** Connects to 30"D space saver connectables, 30"D space saver returns, 24"D returns or 24"D connectable tables. **Full end panel can be placed next to** lateral files, storage cabinets, wardrobe units, credenzas and end-shelves. Corner has one grommet.

- Shipped easy to assemble in 1 carton.
- **Modesty panel is 1" off of ground.**
- **Z2466NFL cannot accept pedestals.**

Z2072NFL	72 x 36 x 30	163	7	\$1311	\$1516	N/A	\$518
Z2066NFL	66 x 36 x 30	157	7	\$1265	\$1429	N/A	\$498

Extended worksurface on right. **Narrow end panel on left. Full end panel on right.** Connects to 24"D space saver connectables and 20"D returns. **Full end panel can be placed next to** lateral files, storage cabinets, wardrobe units, credenzas and end-shelves. Corner has one grommet. Shipped easy to assemble in 1 carton.

- **Modesty panel is 1" off of ground.**
- *NFL end panels can be switched to make FNL.*

Z2484ECFL	84 x 36 x 30	196	8	\$1147	\$1418	N/A	\$690
Z2472ECFL	72 x 36 x 30	176	7.5	\$1025	\$1262	N/A	\$516
Z2466ECFL	66 x 36 x 30	168	7.5	\$976	\$1196	N/A	\$516
Z2460ECFL	60 x 36 x 30	159	6	\$928	\$1130	N/A	\$431
Z2084ECFL	84 x 36 x 30	185	8	\$1144	\$1416	N/A	\$690
Z2072ECFL	72 x 36 x 30	168	7.5	\$1022	\$1259	N/A	\$516
Z2066ECFL	66 x 36 x 30	160	7.5	\$972	\$1194	N/A	\$516
Z2060ECFL	60 x 36 x 30	151	6	\$912	\$1110	N/A	\$431
Z1684ECFL	84 x 36 x 30	175	8	\$1140	\$1412	N/A	\$690
Z1672ECFL	72 x 36 x 30	160	7.5	\$1018	\$1256	N/A	\$516
Z1666ECFL	66 x 36 x 30	153	7.5	\$969	\$1191	N/A	\$516
Z1660ECFL	60 x 36 x 30	147	6	\$902	\$1100	N/A	\$431

Extended worksurface on right. **No narrow end panel on left. Full end panel on right.** Connects to returns and bridges with 16" throat on the left. **Full end panel can be placed next to** lateral files, storage cabinets, wardrobe units, credenzas and end-shelves. Corner has one grommet. **Does not accept pencil drawers.** Shipped easy to assemble in 1 carton.

Required specifications

- Top finish
- Top thickness/edge detail
- Base finish

Optional specifications

- HP laminate
- Modesty type
- Grommet position or power block cut-out

Accessories

- Pencil drawer
- Power block
- Keyboard

LEFT EXT CORNERS (CONNECTS ON BOTH SIDES)

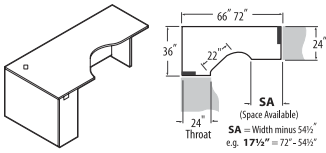

Extended Corner, 24" Throat - LEFT

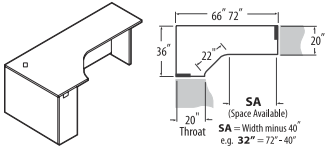

Extended Corner, 20" Throat - LEFT

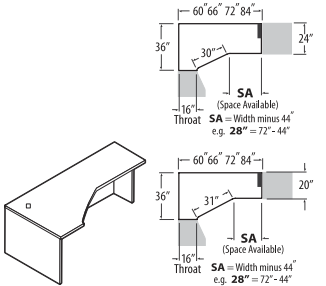

Extended Corner, 16" Throat - LEFT

MODEL # DIMENSIONS WT/LB. CUBIC FT. 1" TOP 1.5" TOP GLAZE ADD HP ADD

	W x D x H (1.5" TOP)						
Z2472NNL	72 x 36 x 30	164	7	\$1311	\$1494	N/A	\$518
Z2466NNL	66 x 36 x 30	156	7	\$1265	\$1408	N/A	\$498

Extended worksurface on right. **Narrow end panels on left and right.** Connects to 30"D space saver connectables, 30"D space saver returns, 24"D returns or 24"D connectable tables or "D" and "P" islands with "T" or "H" bases on either end. **Full end panel can be placed next to** lateral files, storage cabinets, wardrobe units, credenzas and end-shelves. Corner has one grommet. Shipped easy to assemble in 1 carton.

- Modesty panel is 1" off of ground.
- **Z2466NNL cannot accept pedestals.**

Z2072NNL	72 x 36 x 30	157	7	\$1290	\$1491	N/A	\$518
Z2066NNL	66 x 36 x 30	150	7	\$1247	\$1410	N/A	\$498

Extended worksurface on right. **Narrow end panels on left and right.** Connects to 24"D space saver connectables and 20"D returns, bridges or "D" and "P" islands with "T" or "H" bases one either end. **Full end panel can be placed next to** lateral files, storage cabinets, wardrobe units, credenzas and end-shelves. Corner has one grommet. Shipped easy to assemble in 1 carton.

- Modesty panel is 1" off of ground.

Z2484ECNL	84 x 36 x 30	187	8	\$1113	\$1385	N/A	\$690
Z2472ECNL	72 x 36 x 30	168	7.5	\$993	\$1231	N/A	\$516
Z2466ECNL	66 x 36 x 30	159	7.5	\$942	\$1162	N/A	\$516
Z2460ECNL	60 x 36 x 30	150	6	\$881	\$1079	N/A	\$431
Z2084ECNL	84 x 36 x 30	179	8	\$1111	\$1383	N/A	\$690
Z2072ECNL	72 x 36 x 30	162	7.5	\$988	\$1225	N/A	\$516
Z2066ECNL	66 x 36 x 30	153	7.5	\$937	\$1159	N/A	\$516
Z2060ECNL	60 x 36 x 30	146	6	\$877	\$1075	N/A	\$431

Extended worksurface on right. **No narrow end panel on left. Narrow end panel on right.** Connects to returns and bridges with 16" throat on the left. **Full end panel can be placed next to** lateral files, storage cabinets, wardrobe units, credenzas and end-shelves. Corner has one grommet. **Does not accept pencil drawers.** Shipped easy to assemble in 1 carton.

RIGHT EXT CORNERS (DOES NOT CONNECT)

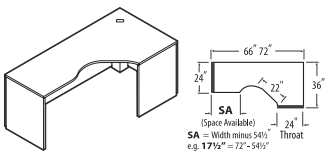

Extended Corner, 24" Throat - RIGHT Freestanding

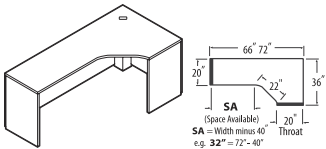

Extended Corner, 20" Throat - RIGHT

W x D x H (1.5" TOP)

Z2472FFR	72 x 36 x 30	180	7	\$1356	\$1540	N/A	\$518
Z2466FFR	66 x 36 x 30	172	7	\$1290	\$1454	N/A	\$518

Extended worksurface on left. **Full end panels on left and right. Cannot be connected on left or right, due to full end panel.** Corner has one grommet. Shipped easy to assemble in 1 carton.

- Modesty panel is 1" off of ground.
- **Z2466FFR cannot accept pedestals.**

Z2072FFR	72 x 36 x 30	168	7	\$1333	\$1538	N/A	\$498
Z2066FFR	66 x 36 x 30	161	7	\$1290	\$1454	N/A	\$498

Extended worksurface on left. **Full end panels on left and right. Can be placed next to** lateral files, storage cabinets, wardrobe units, credenzas and end-shelves. Corner has one grommet. Shipped easy to assemble in 1 carton.

- Modesty panel is 1" off of ground.

Required specifications

Top finish
Top thickness/edge detail
Base finish

Optional specifications

HP laminate
Modesty type
Grommet position or power block cut-out

Accessories

Pencil drawer
Power block
Keyboard

RIGHT EXT CORNERS (CONNECTS ON THROAT SIDE)

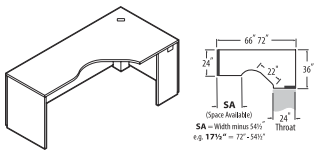

Extended Corner, 24" Throat - RIGHT

MODEL #	DIMENSIONS W x D x H (1.5" TOP)	WT/LB.	CUBIC FT.	1" TOP	1.5" TOP	GLAZE ADD	HP ADD
Z2472FNR	72 x 36 x 30	172	7	\$1333	\$1517	N/A	\$518
Z2466FNR	66 x 36 x 30	164	7	\$1290	\$1431	N/A	\$518

Extended worksurface on left. **Narrow end panel on right. Full end panel on left.** Connects to 30"D space saver connectables, 24"D returns, 24"D connectable tables or "D" and "P" islands with "T" or "H" bases. **Full end panel can be placed next to** lateral files, storage cabinets, wardrobe units, credenzas and end-shelves. Corner has one grommet. Shipped easy to assemble in 1 carton.

- **Modesty panel is 1" off of ground.**
- **Z2466FNR cannot accept pedestals.**

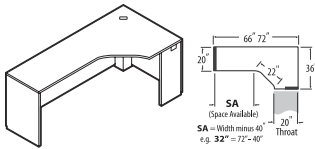

Extended Corner, 20" Throat - RIGHT

Z2072FNR	72 x 36 x 30	163	7	\$1311	\$1516	N/A	\$518
Z2066FNR	66 x 36 x 30	157	7	\$1265	\$1429	N/A	\$498

Extended worksurface on left. **Narrow end panel on right. Full end panel on left.** Connects to 24"D space saver connectables, 20"D returns, 20"D connectable tables or "D" and "P" islands with "T" or "H" bases. **Full end panel can be placed next to** lateral files, storage cabinets, wardrobe units, credenzas and end-shelves. Corner has one grommet. Shipped easy to assemble in 1 carton.

- **Modesty panel is 1" off of ground.**
- **FNR end panels can be switched to make NFR.**

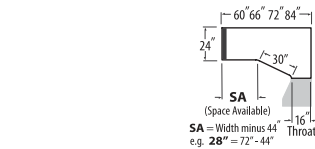

Extended Corner, 16" Throat - RIGHT

Z2484ECFR	84 x 36 x 30	196	8	\$1147	\$1418	N/A	\$690
Z2472ECFR	72 x 36 x 30	176	7.5	\$1025	\$1262	N/A	\$516
Z2466ECFR	66 x 36 x 30	168	7.5	\$976	\$1196	N/A	\$516
Z2460ECFR	60 x 36 x 30	159	6	\$928	\$1130	N/A	\$431

Z2084ECFR	84 x 36 x 30	185	8	\$1144	\$1416	N/A	\$690
Z2072ECFR	72 x 36 x 30	168	7.5	\$1022	\$1259	N/A	\$516
Z2066ECFR	66 x 36 x 30	160	7.5	\$972	\$1194	N/A	\$516
Z2060ECFR	60 x 36 x 30	151	6	\$912	\$1110	N/A	\$431

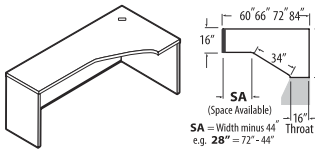

Extended Corner, 16" Throat - RIGHT

Z1684ECFR	84 x 36 x 30	175	8	\$1140	\$1412	N/A	\$690
Z1672ECFR	72 x 36 x 30	160	7.5	\$1018	\$1256	N/A	\$516
Z1666ECFR	66 x 36 x 30	153	7.5	\$969	\$1191	N/A	\$516
Z1660ECFR	60 x 36 x 30	147	6	\$902	\$1100	N/A	\$431

Extended worksurface on left. **No narrow end panel on right. Full end panel on left.** Connects to returns and bridges with 16" throat on the right. **Full end panel can be placed next to** lateral files, storage cabinets, wardrobe units, credenzas and end-shelves. Corner has one grommet. **Does not accept pencil drawers.** Shipped easy to assemble in 1 carton.

RIGHT EXT CORNERS (CONNECTS ON EXTENDED SIDE)

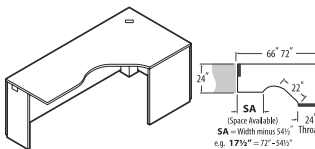

Extended Corner, 24" Throat - RIGHT

MODEL #	DIMENSIONS W x D x H (1.5" TOP)	WT/LB.	CUBIC FT.	1" TOP	1.5" TOP	GLAZE ADD	HP ADD
Z2472NFR	72 x 36 x 30	172	7	\$1333	\$1517	N/A	\$518
Z2466NFR	66 x 36 x 30	164	7	\$1290	\$1431	N/A	\$498

Extended worksurface on left. **Narrow end panel on left. Full end panel on right.** Connects to 30"D space saver connectables, 24"D returns, 24"D connectable tables, or "D" and "P" islands with "T" or "H" bases. **Full end panel can be placed next to** lateral files, storage cabinets, wardrobe units, credenzas and end-shelves. Corner has one grommet. Shipped easy to assemble in 1 carton.

- **Modesty panel is 1" off of ground.**
- **Z2466NFR cannot accept pedestals.**

Required specifications	Optional specifications	Accessories
Top finish	HP laminate	Pencil drawer
Top thickness/edge detail	Modesty type	Power block
Base finish	Grommet position or power block cut-out	Keyboard

RIGHT EXTENDED CORNERS (CONNECTS ON EXTENDED SIDE)

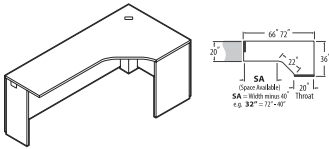

Right Extended Corner, 20" Throat

MODEL #	DIMENSIONS	WT/LB.	CUBIC FT.	1" TOP	1.5" TOP	GLAZE ADD	HP ADD
W x D x H (1.5" TOP)							
Z2072NFR	72 x 36 x 30	163	7	\$1311	\$1516	N/A	\$518
Z2066NFR	66 x 36 x 30	157	7	\$1265	\$1429	N/A	\$498

Extended worksurface on left. **Narrow end panel on left. Full end panel on right.** Connects to 24"D space saver connectables, 20"D returns or "D" and "P" islands with "T" or "H" bases. **Full end panel can be placed next to** lateral files, storage cabinets, wardrobe units, credenzas and end-shelves. Corner has one grommet. Shipped easy to assemble in 1 carton.

- **Modesty panel is 1" off of ground.**
- *NFR end panels can be switched to make FNR.*

RIGHT EXTENDED CORNERS (CONNECTS ON BOTH SIDES)

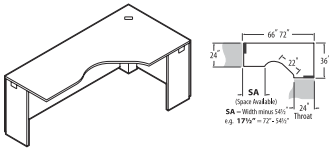

Right Extended Corner, 24" Throat

MODEL #	DIMENSIONS	WT/LB.	CUBIC FT.	1" TOP	1.5" TOP	GLAZE ADD	HP ADD
W x D x H (1.5" TOP)							
Z2472NNR	72 x 36 x 30	164	7	\$1311	\$1494	N/A	\$518
Z2466NNR	66 x 36 x 30	156	7	\$1265	\$1408	N/A	\$498

Extended worksurface on left. **Narrow end panels on left and right.** Connects to 30"D space saver connectables, 30"D space saver returns, 24"D returns, 24"D connectable tables or "D" and "P" islands with "T" or "H" bases on either end. Corner has one grommet. Shipped easy to assemble in 1 carton.

- **Modesty panel is 1" off of ground.**
- *Z2466NNR cannot accept pedestals.*

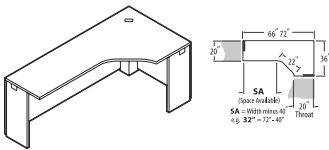

Right Extended Corner, 20" Throat

Z2072NNR	72 x 36 x 30	157	7	\$1290	\$1491	N/A	\$518
Z2066NNR	66 x 36 x 30	150	7	\$1247	\$1410	N/A	\$498

Extended worksurface on left. **Narrow end panels on left and right.** Connects to 24"D space saver connectables and 20"D returns, bridges or "D" and "P" islands with "T" or "H" bases one either end. **Full end panel can be placed next to** lateral files, storage cabinets, wardrobe units, credenzas and end-shelves. Corner has one grommet. Shipped easy to assemble in 1 carton.

- **Modesty panel is 1" off of ground.**

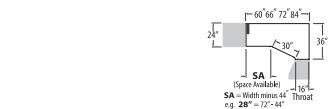

Right Extended Corner, 16" Throat

Z2484ECNR	84 x 36 x 30	187	8	\$1113	\$1385	N/A	\$690
Z2472ECNR	72 x 36 x 30	168	7.5	\$993	\$1231	N/A	\$516
Z2466ECNR	66 x 36 x 30	159	7.5	\$942	\$1162	N/A	\$516
Z2460ECNR	60 x 36 x 30	150	6	\$881	\$1079	N/A	\$431
Z2084ECNR	84 x 36 x 30	179	8	\$1111	\$1383	N/A	\$690
Z2072ECNR	72 x 36 x 30	162	7.5	\$988	\$1225	N/A	\$516
Z2066ECNR	66 x 36 x 30	153	7.5	\$937	\$1159	N/A	\$516
Z2060ECNR	60 x 36 x 30	146	6	\$877	\$1075	N/A	\$431

Extended worksurface on left. **No narrow end panel on right. Narrow end panel on left.** Connects to returns and bridges with 16" throat on the right. **Full end panel can be placed next to** lateral files, storage cabinets, wardrobe units, credenzas and end-shelves. Corner has one grommet. **Does not accept pencil drawers.** Shipped easy to assemble in 1 carton.

Required specifications

Top finish
Top thickness/edge detail
Base finish

Optional specifications

HP laminate
Modesty type
Grommet position or power block cut-out

Accessories

Pencil drawer
Power block
Keyboard

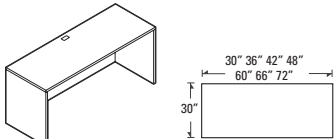
FREESTANDING TABLES	MODEL #	DIMENSIONS	WT/LB.	CUBIC FT.	1" TOP	1.5" TOP	GLAZE ADD	HP ADD
	Z3072T	72 x 29.7 x 30	197	6	\$1003	\$1172	N/A	\$484
	Z3066T	66 x 29.7 x 30	183	6	\$949	\$1118	N/A	\$444
	Z3060T	60 x 29.7 x 30	169	5.25	\$911	\$1065	N/A	\$444
	Z3048T	48 x 29.7 x 30	142	5.25	\$845	\$979	N/A	\$380
	Z3042T	42 x 29.7 x 30	129	5.25	\$799	\$921	N/A	\$345
	Z3036T	36 x 29.7 x 30	116	4.3	\$766	\$871	N/A	\$311
	Z3030T	30 x 29.7 x 30	104	3.6	\$740	\$817	N/A	\$278

30" Deep Freestanding Table*

Two full end panels. Cannot be connected on left or right side. Grommet in worksurface.

Shipped easy to assemble in 1 carton.

- Modesty panel is 1" off of ground.

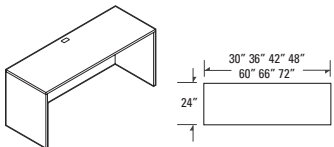

24" Deep Freestanding Table*

Z2472T	72 x 24 x 30	173	6	\$902	\$1069	N/A	\$345
Z2466T	66 x 24 x 30	160	6	\$857	\$1012	N/A	\$330
Z2460T	60 x 24 x 30	147	5.25	\$814	\$953	N/A	\$330
Z2448T	48 x 24 x 30	123	4.3	\$783	\$894	N/A	\$263
Z2442T	42 x 24 x 30	112	4.3	\$719	\$818	N/A	\$222
Z2436T	36 x 24 x 30	100	4.2	\$715	\$772	N/A	\$167
Z2430T	30 x 24 x 30	89	3.6	\$677	\$719	N/A	\$167

Two full end panels. Cannot be connected on left or right side. Grommet in worksurface.

Shipped easy to assemble in 1 carton.

- Modesty panel is 1" off of ground.

CONNECTABLE TABLES - LEFT

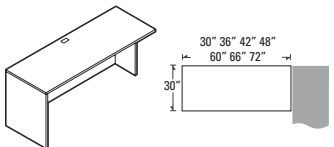

30" Deep Connectable Table - LEFT

	W x D x H (1.5" TOP)						
Z3072L	72 x 29.7 x 30	189	6	\$1003	\$1172	N/A	\$484
Z3066L	66 x 29.7 x 30	175	6	\$949	\$1118	N/A	\$444
Z3060L	60 x 29.7 x 30	161	5.25	\$911	\$1065	N/A	\$444
Z3048L	48 x 29.7 x 30	134	4.3	\$845	\$979	N/A	\$380
Z3042L	42 x 29.7 x 30	121	4.3	\$799	\$921	N/A	\$345
Z3036L	36 x 29.7 x 30	108	4.2	\$762	\$870	N/A	\$311
Z3030L	30 x 29.7 x 30	96	3.6	\$750	\$818	N/A	\$278

Full end panel on left. Right narrow end panel connects to 30"D center/right connectable table, or at 90° angle to a freestanding table; and "D" islands or "P" islands with "T" and "H" bases. Grommet in worksurface.

Shipped easy to assemble in 1 carton.

- Modesty panel is 1" off of ground.

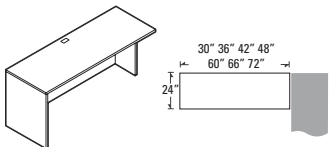

24" Deep Connectable Table - LEFT

Z2472L	72 x 24 x 30	164	6	\$902	\$1069	N/A	\$345
Z2466L	66 x 24 x 30	152	6	\$857	\$1012	N/A	\$330
Z2460L	60 x 24 x 30	139	5.25	\$827	\$952	N/A	\$330
Z2448L	48 x 24 x 30	115	4.3	\$783	\$894	N/A	\$263
Z2442L	42 x 24 x 30	103	3.8	\$719	\$818	N/A	\$222
Z2436L	36 x 24 x 30	92	3.3	\$705	\$770	N/A	\$167
Z2430L	30 x 24 x 30	80	3.6	\$677	\$719	N/A	\$167

Full end panel on left. Right narrow end panel connects to 24"D center/right connectable table, or at 90° angle to a freestanding table; 24"D extended corners or at the end of a straight run; "D" islands or "P" islands with "T" and "H" bases. Grommet in worksurface. Shipped easy to assemble in 1 carton.

- Modesty panel is 1" off of ground.

Required specifications

- Top finish
- Top thickness/edge detail
- Base finish

Optional specifications

- HP laminate
- Modesty type
- Grommet position or power block cut-out

Accessories

- Pencil drawer
- Power block
- Keyboard*

CONNECTABLE TABLES - RIGHT

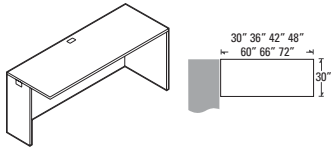

30" Deep Connectable Table - RIGHT

MODEL #	DIMENSIONS	WT/LB.	CUBIC FT.	1" TOP	1.5" TOP	GLAZE ADD	HP ADD
W x D x H (1.5" TOP)							
Z3072R	72 x 29.7 x 30	189	6	\$1003	\$1172	N/A	\$484
Z3066R	66 x 29.7 x 30	175	6	\$949	\$1118	N/A	\$444
Z3060R	60 x 29.7 x 30	161	5.25	\$911	\$1065	N/A	\$444
Z3048R	48 x 29.7 x 30	134	4.3	\$845	\$979	N/A	\$380
Z3042R	42 x 29.7 x 30	121	4.3	\$799	\$921	N/A	\$345
Z3036R	36 x 29.7 x 30	108	4.2	\$762	\$870	N/A	\$311
Z3030R	30 x 29.7 x 30	96	3.6	\$750	\$818	N/A	\$278

Full end panel on right. Left narrow end panel connects to **30"D** center/right connectable table, or at 90° angle to a freestanding table; and "D" islands or "P" islands with "T" and "H" bases. Grommet in worksurface. Shipped easy to assemble in 1 carton.

- Modesty panel is 1" off of ground.

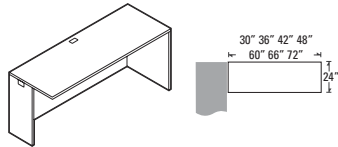

24" Deep Connectable Table - RIGHT

Z2472R	72 x 24 x 30	164	6	\$902	\$1069	N/A	\$345
Z2466R	66 x 24 x 30	152	6	\$857	\$1012	N/A	\$330
Z2460R	60 x 24 x 30	139	5.25	\$827	\$952	N/A	\$330
Z2448R	48 x 24 x 30	115	4.3	\$783	\$894	N/A	\$263
Z2442R	42 x 24 x 30	103	3.8	\$719	\$818	N/A	\$222
Z2436R	36 x 24 x 30	92	3.3	\$705	\$770	N/A	\$167
Z2430R	30 x 24 x 30	80	3.6	\$677	\$719	N/A	\$167

Full end panel on right. Left narrow end panel connects to **24"D** center/right connectable table, or at 90° angle to a freestanding table; 24"D extended corners or at the end of a straight run; "D" islands or "P" islands with "T" and "H" bases. Grommet in worksurface. Shipped easy to assemble in 1 carton.

- Modesty panel is 1" off of ground.

CONNECTABLE TABLES

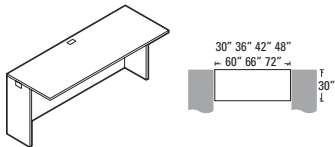

30" Deep Connectable Table

W x D x H (1.5" TOP)							
Z3072N	72 x 29.7 x 30	181	6	\$1003	\$1172	N/A	\$484
Z3066N	66 x 29.7 x 30	167	6	\$949	\$1118	N/A	\$444
Z3060N	60 x 29.7 x 30	153	5.25	\$911	\$1065	N/A	\$444
Z3048N	48 x 29.7 x 30	126	4.3	\$851	\$959	N/A	\$380
Z3042N	42 x 29.7 x 30	113	3.8	\$829	\$921	N/A	\$345
Z3036N	36 x 29.7 x 30	100	3.3	\$762	\$850	N/A	\$311
Z3030N	30 x 29.7 x 30	88	3.6	\$711	\$799	N/A	\$278

Narrow end panels on both sides connect to **30"D** worksurfaces, "D" islands or "P" islands with "T" and "H" bases; or at 90° angle to freestanding table(s). Grommet in worksurface. Shipped easy to assemble in 1 carton.

- Modesty panel is 1" off of ground.

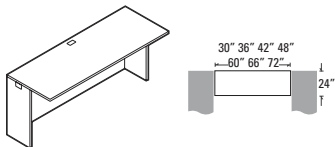

24" Deep Connectable Table

Z2472N	72 x 24 x 30	156	6	\$902	\$1057	N/A	\$345
Z2466N	66 x 24 x 30	143	6	\$857	\$1003	N/A	\$330
Z2460N	60 x 24 x 30	131	4.5	\$833	\$952	N/A	\$330
Z2448N	48 x 24 x 30	106	4.3	\$759	\$870	N/A	\$263
Z2442N	42 x 24 x 30	95	3.8	\$719	\$818	N/A	\$222
Z2436N	36 x 24 x 30	83	3.3	\$677	\$739	N/A	\$167
Z2430N	30 x 24 x 30	72	3.6	\$639	\$687	N/A	\$167

Narrow end panels on both sides connect to **24"D** worksurfaces, "D" islands or "P" islands with "T" and "H" bases; or at 90° angle to freestanding table(s). Grommet in worksurface. Shipped easy to assemble in 1 carton.

- Modesty panel is 1" off of ground.

Required specifications

Top finish
Top thickness/edge detail
Base finish

Optional specifications

HP laminate
Modesty type
Grommet position or power block cut-out

Accessories

Pencil drawer
Power block
Keyboard

SPACE SAVER CONNECTABLE TABLES **MODEL #** **DIMENSIONS** **WT/LB.** **CUBIC FT.** **1" TOP** **1.5" TOP** **GLAZE ADD** **HP ADD**

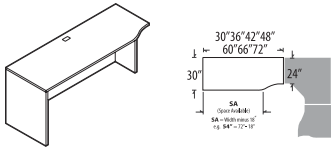

30" Deep Space Saver Connectable Table - LEFT

	W x D x H (1.5" TOP)							
Z3072LK	72 x 29.7 x 30	185	6	\$1049	\$1223	N/A	\$484	
Z3066LK	66 x 29.7 x 30	171	6	\$1003	\$1167	N/A	\$444	
Z3060LK	60 x 29.7 x 30	157	5.25	\$955	\$1111	N/A	\$444	
Z3048LK	48 x 29.7 x 30	130	4.3	\$887	\$1021	N/A	\$380	
Z3042LK	42 x 29.7 x 30	117	3.8	\$831	\$952	N/A	\$345	
Z3036LK	36 x 29.7 x 30	104	4.3	\$809	\$915	N/A	\$311	
Z3030LK	30 x 29.7 x 30	91	3.6	\$774	\$840	N/A	\$278	

Full end panel on left. Narrow right end panel connects to any corner unit with a 24" throat. Grommet in worksurface.
Shipped easy to assemble in 1 carton.
• Modesty panel is 1" off of ground.

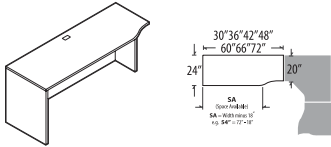

24" Deep Space Saver Connectable Table - LEFT

Z2472LK	72 x 24 x 30	164	6	\$949	\$1158	N/A	\$345	
Z2466LK	66 x 24 x 30	152	6	\$902	\$1057	N/A	\$330	
Z2460LK	60 x 24 x 30	139	5.25	\$864	\$992	N/A	\$330	
Z2448LK	48 x 24 x 30	115	4.3	\$810	\$938	N/A	\$263	
Z2442LK	42 x 24 x 30	103	3.8	\$783	\$882	N/A	\$222	
Z2436LK	36 x 24 x 30	92	3.3	\$740	\$801	N/A	\$167	
Z2430LK	30 x 24 x 30	80	3.6	\$705	\$742	N/A	\$167	

Full end panel on left. Narrow right end panel connects to any corner unit with a 20" throat. Grommet in worksurface.
Shipped easy to assemble in 1 carton.
• Modesty panel is 1" off of ground.

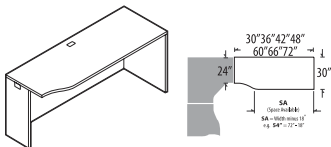

30" Deep Space Saver Connectable Table - RIGHT

Z3072RK	72 x 29.7 x 30	185	6	\$1049	\$1223	N/A	\$484	
Z3066RK	66 x 29.7 x 30	171	6	\$1003	\$1167	N/A	\$444	
Z3060RK	60 x 29.7 x 30	157	5.25	\$955	\$1111	N/A	\$444	
Z3048RK	48 x 29.7 x 30	130	4.3	\$887	\$1021	N/A	\$380	
Z3042RK	42 x 29.7 x 30	117	3.8	\$831	\$952	N/A	\$345	
Z3036RK	36 x 29.7 x 30	104	4.3	\$809	\$915	N/A	\$311	
Z3030RK	30 x 29.7 x 30	91	3.6	\$774	\$840	N/A	\$278	

Full end panel on right. Narrow left end panel connects to any corner unit with a 24" throat. Grommet in worksurface.
Shipped easy to assemble in 1 carton.
• Modesty panel is 1" off of ground.

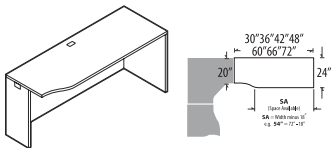

24" Deep Space Saver Connectable Table - RIGHT

Z2472RK	72 x 24 x 30	164	6	\$949	\$1158	N/A	\$345	
Z2466RK	66 x 24 x 30	152	6	\$902	\$1057	N/A	\$330	
Z2460RK	60 x 24 x 30	139	5.25	\$864	\$992	N/A	\$330	
Z2448RK	48 x 24 x 30	115	4.3	\$810	\$938	N/A	\$263	
Z2442RK	42 x 24 x 30	103	3.8	\$783	\$882	N/A	\$222	
Z2436RK	36 x 24 x 30	92	3.3	\$740	\$801	N/A	\$167	
Z2430RK	30 x 24 x 30	80	3.6	\$705	\$742	N/A	\$167	

Full end panel on right. Narrow left end panel connects to any corner unit with a 20" throat. Grommet in worksurface.
Shipped easy to assemble in 1 carton.
• Modesty panel is 1" off of ground.

Required specifications

- Top finish
- Top thickness/edge detail
- Base finish

Optional specifications

- HP laminate
- Modesty type
- Grommet position or power block cut-out

Accessories

- Pencil drawer
- Power block
- Keyboard

SPACE SAVER CONNECTABLE TABLES

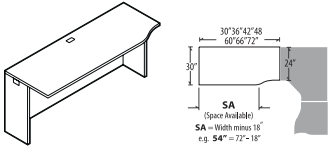

30" Deep Space Saver Connectable Table

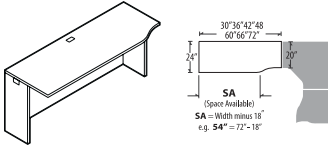

24" Deep Space Saver Connectable Table

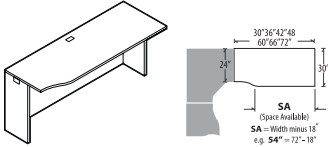

30" Deep Space Saver Connectable Table

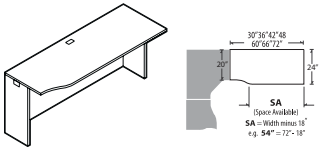

24" Deep Space Saver Connectable Table

MODEL #	DIMENSIONS	WT/LB.	CUBIC FT.	1" TOP	1.5" TOP	GLAZE ADD	HP ADD
W x D x H (1.5" TOP)							
Z3072LN	72 x 29.7 x 30	177	6	\$1049	\$1223	N/A	\$484
Z3066LN	66 x 29.7 x 30	163	6	\$1003	\$1167	N/A	\$444
Z3060LN	60 x 29.7 x 30	148	5.25	\$955	\$1111	N/A	\$444
Z3048LN	48 x 29.7 x 30	122	4.3	\$884	\$989	N/A	\$380
Z3042LN	42 x 29.7 x 30	109	3.8	\$847	\$938	N/A	\$345
Z3036LN	36 x 29.7 x 30	96	3.3	\$795	\$883	N/A	\$311
Z3030LN	30 x 29.7 x 30	83	3.6	\$740	\$827	N/A	\$278

Narrow end panels on both sides. Connects the **right end only** to any corner unit with a 24" throat. Left end allows the continuation of additional 30" connectable center or left connectable worksurface. Grommet in worksurface.

Shipped easy to assemble in 1 carton.

- Modesty panel is 1" off of ground.

Z2472LN	72 x 24 x 30	156	6	\$931	\$1097	N/A	\$345
Z2466LN	66 x 24 x 30	143	6	\$902	\$1046	N/A	\$330
Z2460LN	60 x 24 x 30	131	5.25	\$845	\$972	N/A	\$330
Z2448LN	48 x 24 x 30	106	4.3	\$783	\$894	N/A	\$263
Z2442LN	42 x 24 x 30	95	3.8	\$765	\$862	N/A	\$222
Z2436LN	36 x 24 x 30	83	3.3	\$711	\$777	N/A	\$167
Z2430LN	30 x 24 x 30	72	3.6	\$677	\$719	N/A	\$167

Narrow end panels on both sides. Connects the **right end only** to any corner unit with a 24" throat. Left end allows the continuation of additional 24" connectable center or left connectable worksurface. Grommet in worksurface.

Shipped easy to assemble in 1 carton.

- Modesty panel is 1" off of ground.

Z3072RN	72 x 29.7 x 30	177	6	\$1049	\$1223	N/A	\$484
Z3066RN	66 x 29.7 x 30	163	6	\$1003	\$1167	N/A	\$444
Z3060RN	60 x 29.7 x 30	148	5.25	\$955	\$1111	N/A	\$444
Z3048RN	48 x 29.7 x 30	122	4.3	\$884	\$989	N/A	\$380
Z3042RN	42 x 29.7 x 30	109	3.8	\$847	\$938	N/A	\$345
Z3036RN	36 x 29.7 x 30	96	3.3	\$795	\$883	N/A	\$311
Z3030RN	30 x 29.7 x 30	83	3.6	\$740	\$827	N/A	\$278

Narrow end panels on both sides. Connects the **left end only** to any corner unit with a 24" throat. Right end allows the continuation of additional 30" connectable center or right connectable worksurface. Grommet in worksurface.

Shipped easy to assemble in 1 carton.

- Modesty panel is 1" off of ground.

Z2472RN	72 x 24 x 30	156	6	\$931	\$1097	N/A	\$345
Z2466RN	66 x 24 x 30	143	6	\$902	\$1046	N/A	\$330
Z2460RN	60 x 24 x 30	131	5.25	\$845	\$972	N/A	\$330
Z2448RN	48 x 24 x 30	106	4.3	\$783	\$894	N/A	\$263
Z2442RN	42 x 24 x 30	95	3.8	\$765	\$862	N/A	\$222
Z2436RN	36 x 24 x 30	83	3.3	\$711	\$777	N/A	\$167
Z2430RN	30 x 24 x 30	72	3.6	\$677	\$719	N/A	\$167

Narrow end panels on both sides. Connects the **left end only** to any corner unit with a 20" throat. Right end allows the continuation of additional 30" connectable center or right connectable worksurface. Grommet in worksurface.

Shipped easy to assemble in 1 carton.

- Modesty panel is 1" off of ground.

Required specifications

- Top finish
- Top thickness/edge detail
- Base finish

Optional specifications

- HP laminate
- Modesty type
- Grommet position or power block cut-out

Accessories

- Pencil drawer
- Power block
- Keyboard

EXT CORNER ISLANDS	MODEL #	DIMENSIONS	WT/LB.	CUBIC FT.	1" TOP	1.5" TOP	GLAZE ADD	HP ADD
--------------------	---------	------------	--------	-----------	--------	----------	-----------	--------

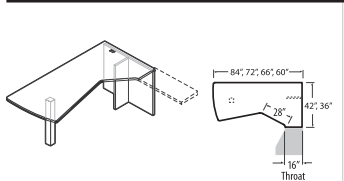

Extended Corner Island Full End Panel & Post (T-Base) - LEFT

	W x D x H (1.5" TOP)							
Z4284EDTL	84 x 42 x 30	181	10.75	\$1159	\$1462	N/A	\$919	
Z4272EDTL	72 x 42 x 30	165	9.5	\$1088	\$1358	N/A	\$690	
Z3672EDTL	72 x 36 x 30	140	8.75	\$993	\$1178	N/A	\$516	
Z3666EDTL	66 x 36 x 30	133	8.75	\$952	\$1136	N/A	\$516	
Z3660EDTL	60 x 36 x 30	127	6.5	\$904	\$1089	N/A	\$431	

Extended island worksurface on **left**. Connects to returns or bridges with a 16" throat on the right. **Not freestanding.** Grommet in worksurface. Shipped easy to assemble in 2 cartons.
 • Post is shipped in separate carton.

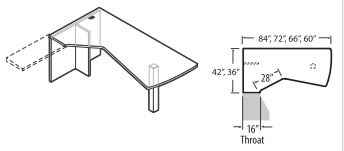

Extended Corner Island Full End Panel & Post (T-Base) - RIGHT

Z4284EDTR	84 x 42 x 30	181	10.75	\$1159	\$1462	N/A	\$919	
Z4272EDTR	72 x 42 x 30	165	9.5	\$1088	\$1358	N/A	\$690	
Z3672EDTR	72 x 36 x 30	140	8.75	\$993	\$1178	N/A	\$516	
Z3666EDTR	66 x 36 x 30	133	8.75	\$952	\$1136	N/A	\$516	
Z3660EDTR	60 x 36 x 30	127	6.5	\$904	\$1089	N/A	\$431	

Extended island worksurface on **right**. Connects to returns or bridges with a 16" throat on the left. **Not freestanding.** Grommet in worksurface. Shipped easy to assemble in 2 cartons.
 • Post is shipped in separate carton.

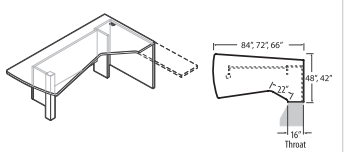

Extended Corner Island Faux Pedestal and Post - LEFT*

Z4884EDFL	84 x 48 x 30	214	12	\$1449	\$1788	\$656	\$919	
Z4872EDFL	72 x 48 x 30	192	10.5	\$1344	\$1637	\$542	\$690	
Z4284EDFL	84 x 42 x 30	187	10.75	\$1362	\$1666	\$656	\$919	
Z4272EDFL	72 x 42 x 30	168	8.75	\$1263	\$1526	\$542	\$690	
Z4266EDFL	66 x 42 x 30	159	8.75	\$1216	\$1462	\$484	\$690	

Extended island worksurface on **left**. Connects to returns or bridges with a 16" throat on the right. **Not freestanding.** Faux pedestal on the **right** is ideal for concealing a CPU. ¾ modesty panel is standard. Grommet in worksurface. Shipped easy to assemble in 2 cartons.

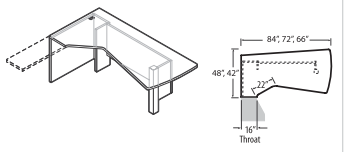

Extended Corner Island Faux Pedestal and Post - RIGHT*

Z4884EDFR	84 x 48 x 30	214	12	\$1449	\$1788	\$656	\$919	
Z4872EDFR	72 x 48 x 30	192	10.5	\$1344	\$1637	\$542	\$690	
Z4284EDFR	84 x 42 x 30	187	10.75	\$1362	\$1666	\$656	\$919	
Z4272EDFR	72 x 42 x 30	168	8.75	\$1263	\$1526	\$542	\$690	
Z4266EDFR	66 x 42 x 30	159	8.75	\$1216	\$1462	\$484	\$690	

Extended island worksurface on **right**. Connects to returns or bridges with a 16" throat on the left. **Not freestanding.** Faux pedestal on the **left** is ideal for concealing a CPU. ¾ modesty panel is standard. Grommet in worksurface. Shipped easy to assemble in 2 cartons.

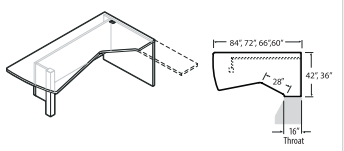

Extended Corner Island Recessed Modesty and Post - LEFT*

Z4284EDRL	84 x 42 x 30	199	10.75	\$1286	\$1590	\$768	\$919	
Z4272EDRL	72 x 42 x 30	180	9.5	\$1208	\$1474	\$702	\$690	
Z3672EDRL	72 x 36 x 30	154	8.75	\$1068	\$1294	\$702	\$516	
Z3666EDRL	66 x 36 x 30	144	8.75	\$1029	\$1239	\$645	\$516	
Z3660EDRL	60 x 36 x 30	136	6.5	\$988	\$1183	\$589	\$431	

Extended island worksurface on **left**. Connects to returns or bridges with a 16" throat on the right. **Not freestanding.** Grommet in worksurface. ¾ **recessed** modesty panel is standard. Shipped easy to assemble in 2 cartons.



Required specifications	Optional specifications	Accessories
Top finish	HP laminate	Pencil drawer
Top thickness/edge detail	Grommet position or power block cut-out	Power block
Base finish	Modesty finish glazed*	Keyboard
Monopost style/finish		

EXT CORNER ISLANDS

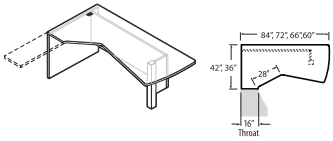

Extended Corner Island
Recessed Modesty and Post - RIGHT*

MODEL #	DIMENSIONS	WT/LB.	CUBIC FT.	1" TOP	1.5" TOP	GLAZE ADD	HP ADD
W x D x H (1.5" TOP)							
Z4284EDRR	84 x 42 x 30	199	10.75	\$1286	\$1590	\$768	\$919
Z4272EDRR	72 x 42 x 30	180	9.5	\$1208	\$1474	\$702	\$690
Z3672EDRR	72 x 36 x 30	154	8.75	\$1068	\$1294	\$702	\$516
Z3666EDRR	66 x 36 x 30	144	8.75	\$1029	\$1239	\$645	\$516
Z3660EDRR	60 x 36 x 30	136	6.5	\$988	\$1183	\$589	\$431

Extended island worksurface on **right**. Connects to returns or bridges with a 16" throat on the left. **Not freestanding.** Grommet in worksurface. $\frac{3}{4}$ **recessed** modesty panel is standard. Shipped easy to assemble in 2 cartons.

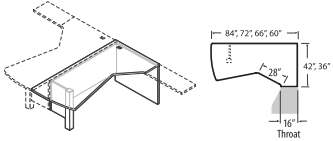

Extended Corner Island
Flush Modesty and Post - LEFT*

Z4284EDML	84 x 42 x 30	209	10.75	\$1302	\$1606	\$768	\$919
Z4272EDML	72 x 42 x 30	184	9.5	\$1220	\$1486	\$702	\$690
Z3672EDML	72 x 36 x 30	159	8.75	\$1080	\$1304	\$702	\$516
Z3666EDML	66 x 36 x 30	150	8.75	\$1035	\$1269	\$645	\$516
Z3660EDML	60 x 36 x 30	142	6.5	\$1007	\$1190	\$589	\$431

Extended island worksurface on **left**. Connects to returns or bridges with a 16" throat on the right. **Not freestanding.** Grommet in worksurface. $\frac{3}{4}$ **flush** modesty panel is standard. Shipped easy to assemble in 2 cartons.

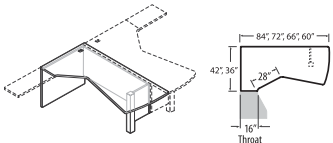

Extended Corner Island
Flush Modesty and Post - RIGHT*

Z4284EDMR	84 x 42 x 30	209	10.75	\$1302	\$1606	\$768	\$919
Z4272EDMR	72 x 42 x 30	184	9.5	\$1220	\$1486	\$702	\$690
Z3672EDMR	72 x 36 x 30	159	8.75	\$1080	\$1304	\$702	\$516
Z3666EDMR	66 x 36 x 30	150	8.75	\$1035	\$1269	\$645	\$516
Z3660EDMR	60 x 36 x 30	142	6.5	\$1007	\$1190	\$589	\$431

Extended island worksurface on **right**. Connects to returns or bridges with a 16" throat on the left. **Not freestanding.** Grommet in worksurface. $\frac{3}{4}$ **flush** modesty panel is standard. Shipped easy to assemble in 2 cartons.



EXT CORNER "P" ISLANDS

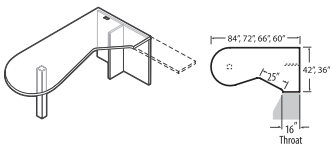

Extended Corner "P" Island
Full End Panel & Post (T-Base) - LEFT

W x D x H (1.5" TOP)							
Z4284EPTL	84 x 42 x 30	179	10.75	\$1151	\$1454	N/A	\$919
Z3684EPTL	84 x 36 x 30	153	9.5	\$1059	\$1327	N/A	\$690
Z3672EPTL	72 x 36 x 30	145	8.75	\$976	\$1175	N/A	\$516
Z3666EPTL	66 x 36 x 30	139	8.75	\$936	\$1149	N/A	\$516
Z3660EPTL	60 x 36 x 30	129	6.5	\$902	\$1100	N/A	\$431

Extended island worksurface on **left**. Connects to returns or bridges with a 16" throat on the right. **Not freestanding.** Grommet in worksurface. Shipped easy to assemble in 2 cartons.

- Post is shipped in separate carton.

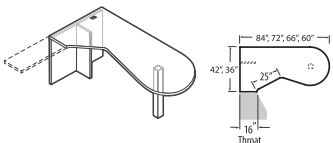

Extended Corner "P" Island
Full End Panel & Post (T-Base) - RIGHT

Z4284EPTR	84 x 42 x 30	179	10.75	\$1151	\$1454	N/A	\$919
Z3684EPTR	84 x 36 x 30	153	9.5	\$1059	\$1327	N/A	\$690
Z3672EPTR	72 x 36 x 30	145	8.75	\$976	\$1175	N/A	\$516
Z3666EPTR	66 x 36 x 30	139	8.75	\$936	\$1149	N/A	\$516
Z3660EPTR	60 x 36 x 30	129	6.5	\$902	\$1100	N/A	\$431

Extended island worksurface on **right**. Connects to returns or bridges with a 16" throat on the left. **Not freestanding.** Grommet in worksurface. Shipped easy to assemble in 2 cartons.

- Post is shipped in separate carton.

Required specifications

Top finish
Top thickness/edge detail
Base finish
Monopost style/finish

Optional specifications

HP laminate
Grommet position or power block cut-out
Modesty finish glazed*

Accessories

Power block
Keyboard

EXT CORNER "P" ISLANDS

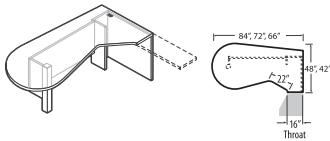

Extended Corner "P" Island
Faux Pedestal and Post - LEFT

MODEL #	DIMENSIONS	WT/LB.	CUBIC FT.	1" TOP	1.5" TOP	GLAZE ADD	HP ADD
W x D x H (1.5" TOP)							
Z4884EPFL	84 x 48 x 30	217	12	\$1449	\$1787	\$656	\$919
Z4872EPFL	72 x 48 x 30	194	10.5	\$1343	\$1635	\$542	\$690
Z4284EPFL	84 x 42 x 30	191	10.75	\$1362	\$1665	\$656	\$919
Z4272EPFL	72 x 42 x 30	172	8.75	\$1261	\$1524	\$542	\$690
Z4266EPFL	66 x 42 x 30	160	8.75	\$1212	\$1452	\$484	\$690

Extended island worksurface on **left**. Connects to returns or bridges with a 16" throat on the right. **Not freestanding.** Faux pedestal on the **right** is ideal for concealing a CPU. ¾ modesty panel is standard. Grommet in worksurface. Shipped easy to assemble in 2 cartons.

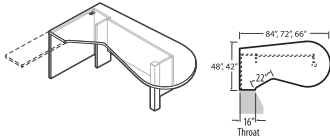

Extended Corner "P" Island
Faux Pedestal and Post - RIGHT

Z4884EPFR	84 x 48 x 30	217	12	\$1449	\$1787	\$656	\$919
Z4872EPFR	72 x 48 x 30	194	10.5	\$1343	\$1635	\$542	\$690
Z4284EPFR	84 x 42 x 30	191	10.75	\$1362	\$1665	\$656	\$919
Z4272EPFR	72 x 42 x 30	172	8.75	\$1261	\$1524	\$542	\$690
Z4266EPFR	66 x 42 x 30	160	8.75	\$1212	\$1452	\$484	\$690

Extended island worksurface on **right**. Connects to returns or bridges with a 16" throat on the left. **Not freestanding.** Faux pedestal on the **left** is ideal for concealing a CPU. ¾ modesty panel is standard. Grommet in worksurface. Shipped easy to assemble in 2 cartons.

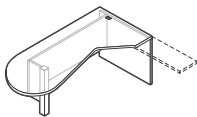

Extended Corner "P" Island
Recessed Modesty and Post - LEFT

Z4284EPRL	84 x 42 x 30	200	10.75	\$1283	\$1586	\$768	\$919
Z3684EPRL	84 x 36 x 30	173	9.5	\$1162	\$1455	\$768	\$690
Z3672EPRL	72 x 36 x 30	156	8.75	\$1068	\$1294	\$702	\$516
Z3666EPRL	66 x 36 x 30	149	8.75	\$1040	\$1253	\$645	\$516
Z3660EPRL	60 x 36 x 30	141	6.5	\$997	\$1195	\$589	\$431

Extended island worksurface on **left**. Connects to returns or bridges with a 16" throat on the right. **Not freestanding.** Grommet in worksurface. ¾ **recessed** modesty panel is standard. Shipped easy to assemble in 2 cartons.

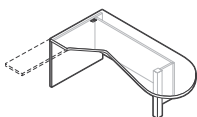
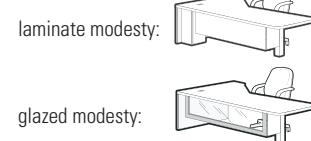
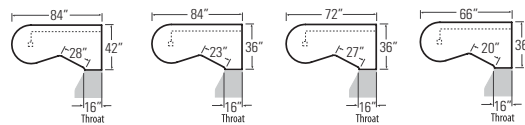

Extended Corner "P" Island
Recessed Modesty and Post - RIGHT

Z4284EPRR	84 x 42 x 30	200	10.75	\$1283	\$1586	\$768	\$919
Z3684EPRR	84 x 36 x 30	173	9.5	\$1162	\$1455	\$768	\$690
Z3672EPRR	72 x 36 x 30	156	8.75	\$1068	\$1294	\$702	\$516
Z3666EPRR	66 x 36 x 30	149	8.75	\$1040	\$1253	\$645	\$516
Z3660EPRR	60 x 36 x 30	141	6.5	\$997	\$1195	\$589	\$431

Extended island worksurface on **right**. Connects to returns or bridges with a 16" throat on the left. **Not freestanding.** Grommet in worksurface. ¾ **recessed** modesty panel is standard. Shipped easy to assemble in 2 cartons.

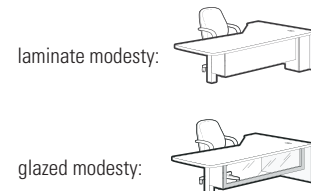
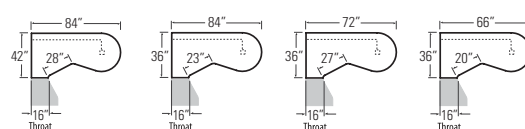

Required specifications

- Top finish
- Top thickness/edge detail
- Base finish
- Monopost style/finish

Optional specifications

- HP laminate
- Grommet position or power block cut-out
- Modesty finish glazed

Accessories

- Power block
- Keyboard

EXT CORNER "P" ISLANDS

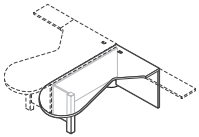

Extended Corner "P" Island
Flush Modesty and Post - LEFT*

MODEL #	DIMENSIONS	WT/LB.	CUBIC FT.	1" TOP	1.5" TOP	GLAZE ADD	HP ADD
W x D x H (1.5" TOP)							
Z4284EPML	84 x 42 x 30	200	10.75	\$1299	\$1602	\$768	\$919
Z3684EPML	84 x 36 x 30	172	9.5	\$1173	\$1441	\$768	\$690
Z3672EPML	72 x 36 x 30	156	8.75	\$1079	\$1305	\$702	\$516
Z3666EPML	66 x 36 x 30	150	8.75	\$1035	\$1221	\$645	\$516
Z3660EPML	60 x 36 x 30	141	6.5	\$1003	\$1201	\$589	\$431

Extended island worksurface on **left**. Connects to returns or bridges with a 16" throat on the right. **Not freestanding.** Grommet in worksurface. $\frac{3}{4}$ flush modesty panel is standard. Shipped easy to assemble in 2 cartons.

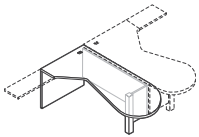
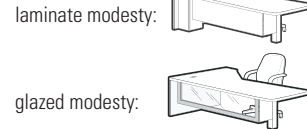
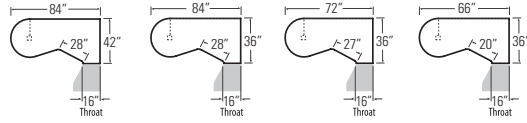

Extended Corner "P" Island
Flush Modesty and Post - RIGHT*

Z4284EPMR	84 x 42 x 30	200	10.75	\$1299	\$1602	\$768	\$919
Z3684EPMR	84 x 36 x 30	172	9.5	\$1173	\$1441	\$768	\$690
Z3672EPMR	72 x 36 x 30	156	8.75	\$1079	\$1305	\$702	\$516
Z3666EPMR	66 x 36 x 30	150	8.75	\$1035	\$1221	\$645	\$516
Z3660EPMR	60 x 36 x 30	141	6.5	\$1003	\$1201	\$589	\$431

Extended island worksurface on **right**. Connects to returns or bridges with a 16" throat on the left. **Not freestanding.** Grommet in worksurface. $\frac{3}{4}$ flush modesty panel is standard. Shipped easy to assemble in 2 cartons.

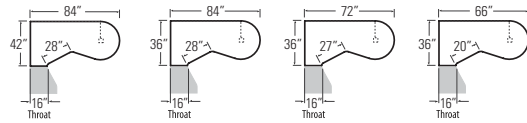

"D" ISLANDS

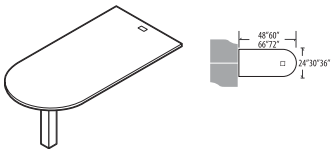

"D" Island with Monopost

W x D x H (1.5" TOP)							
Z3672I	72 x 36 x 30	144	8.5	\$857	\$1070	N/A	\$518
Z3066I	66 x 29.7 x 30	115	7.5	\$790	\$958	N/A	\$444
Z3060I	60 x 29.7 x 30	104	6.76	\$765	\$921	N/A	\$444
Z2466I	66 x 24 x 30	101	7.5	\$724	\$868	N/A	\$330
Z2460I	60 x 24 x 30	92	6.76	\$701	\$828	N/A	\$330
Z2448I	48 x 24 x 30	74	5.76	\$669	\$780	N/A	\$263

Attaches to edge of worksurfaces. Attaching hardware included. Includes grommet as shown. Shipped easy to assemble in 2 cartons.

- Post is shipped in separate carton.

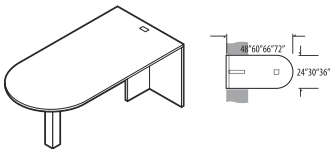

"D" Island - Full End Panel and
Monopost (T-Base)

Z3672FI	72 x 36 x 30	123	8.5	\$1062	\$1271	N/A	\$518
Z3072FI	72 x 29.7 x 30	106	7.5	\$1022	\$1195	N/A	\$484
Z3066FI	66 x 29.7 x 30	101	7.5	\$955	\$1123	N/A	\$444
Z3060FI	60 x 29.7 x 30	94	6.76	\$902	\$1057	N/A	\$444
Z2466FI	66 x 24 x 30	90	7.5	\$894	\$1039	N/A	\$330
Z2460FI	60 x 24 x 30	84	6.76	\$848	\$959	N/A	\$330
Z2448FI	48 x 24 x 30	74	5.76	\$810	\$922	N/A	\$263

Attaches to edge of worksurfaces. Attaching hardware included. Includes grommet as shown. **Not freestanding.** Shipped easy to assemble in 2 cartons.

- Post is shipped in separate carton.

Required specifications

Top finish
Top thickness/edge detail
Base finish
Monopost style/finish*

Optional specifications

HP laminate
Remove standard grommet (RSG)
Modesty finish glazed*

Accessories

Power block
Keyboard*

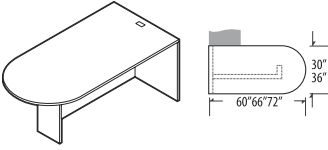
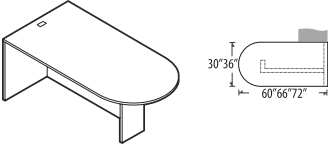
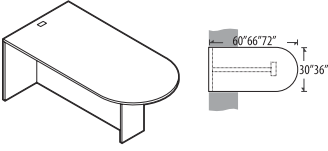
"D" ISLANDS	MODEL #	DIMENSIONS	WT/LB.	CUBIC FT.	1" TOP	1.5" TOP	GLAZE ADD	HP ADD
 <p>"D" Island LEFT - Full Modesty Panel (H-Base)</p>	Z3672FIL	72 x 36 x 30	194	7	\$1064	\$1277	N/A	\$518
	Z3066FIL	66 x 29.7 x 30	158	6	\$983	\$1151	N/A	\$444
	Z3060FIL	60 x 29.7 x 30	144	5.25	\$902	\$1057	N/A	\$444
 <p>"D" Island RIGHT - Full Modesty Panel (H-Base)</p>	Z3672FIR	72 x 36 x 30	194	7	\$1064	\$1277	N/A	\$518
	Z3066FIR	66 x 29.7 x 30	158	6	\$983	\$1151	N/A	\$444
	Z3060FIR	60 x 29.7 x 30	144	5.25	\$902	\$1057	N/A	\$444
 <p>"D" Island Center - Full Modesty Panel (H-Base)</p>	Z3672FIC	72 x 36 x 30	194	7	\$1064	\$1277	N/A	\$518
	Z3066FIC	66 x 29.7 x 30	158	6	\$983	\$1151	N/A	\$444
	Z3060FIC	60 x 29.7 x 30	144	5.25	\$902	\$1057	N/A	\$444

Connects to the left side of a worksurface. Attaching hardware included. Accommodates all 19" pedestals (mobile and hanging pedestals and 19.3" deep storage shells). Includes grommet as shown. Shipped easy to assemble in 1 carton.

Connects to the right side of a worksurface. Attaching hardware included. Accommodates all 19" pedestals (mobile and hanging pedestals and 19.3" deep storage shells). Includes grommet as shown. Shipped easy to assemble in 1 carton.

Connects in between two worksurfaces. Attaching hardware included. **Will not accommodate pedestals.** Includes grommet as shown. Shipped easy to assemble in 1 carton.

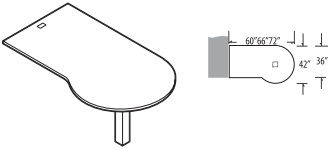
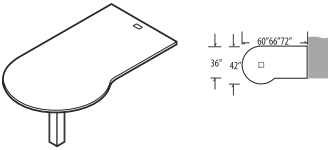
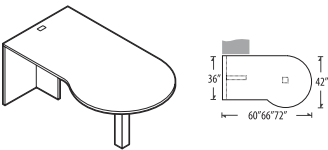
"P" ISLANDS	MODEL #	DIMENSIONS	WT/LB.	CUBIC FT.	1" TOP	1.5" TOP	GLAZE ADD	HP ADD
 <p>"P" Island with Post - LEFT*</p>	Z3672IPL	72 x 42 x 30	152	9.26	\$1060	\$1270	N/A	\$692
	Z3666IPL	66 x 42 x 30	137	8.76	\$1014	\$1183	N/A	\$692
	Z3660IPL	60 x 42 x 30	125	8	\$949	\$1118	N/A	\$586
 <p>"P" Island with Post - RIGHT*</p>	Z3672IPR	72 x 42 x 30	152	9.26	\$1060	\$1270	N/A	\$692
	Z3666IPR	66 x 42 x 30	137	8.76	\$1014	\$1183	N/A	\$692
	Z3660IPR	60 x 42 x 30	125	8	\$949	\$1118	N/A	\$586
 <p>"P" Island - Full End Panel and Post (T-Base) - LEFT*</p>	Z3672FPL	72 x 42 x 30	186	9.26	\$1231	\$1446	N/A	\$692
	Z3666FPL	66 x 42 x 30	173	8.76	\$1198	\$1366	N/A	\$692
	Z3660FPL	60 x 42 x 30	161	8	\$1142	\$1309	N/A	\$586

Attaches to edge of worksurfaces. Attaching hardware included. Includes grommet as shown. Shipped easy to assemble in 2 cartons.

- Post is shipped in separate carton.

Attaches to edge of worksurfaces. Attaching hardware included. Includes grommet as shown. Shipped easy to assemble in 2 cartons.

- Post is shipped in separate carton.

Connects to left side of worksurface. Attaching hardware included. **Not freestanding.** Includes grommet as shown. Shipped easy to assemble in 2 cartons.

- Post is shipped in separate carton.

Required specifications

- Top finish
- Top thickness/edge detail
- Base finish (not Z36xxlPL/R)
- Monopost style/finish*

Optional specifications

- HP laminate
- Remove standard grommet (RSG)

Accessories

- Power block

"P" ISLANDS

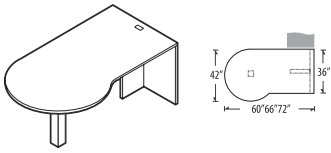

"P" Island - Full End Panel and Post (T-Base) - RIGHT*

MODEL #	DIMENSIONS	WT/LB.	CUBIC FT.	1" TOP	1.5" TOP	GLAZE ADD	HP ADD
W x D x H (1.5" TOP)							
Z3672FPR	72 x 42 x 30	186	9.26	\$1231	\$1446	N/A	\$692
Z3666FPR	66 x 42 x 30	173	8.76	\$1198	\$1366	N/A	\$692
Z3660FPR	60 x 42 x 30	161	8	\$1142	\$1309	N/A	\$586

Connects to right side of worksurface. Attaching hardware included. **Not freestanding.** Includes grommet as shown. Shipped easy to assemble in 2 cartons.

- Post is shipped in separate carton.

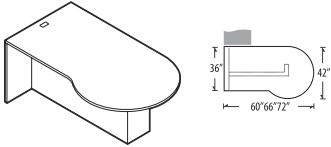

"P" Island LEFT - Full Modesty Panel (H-Base)*

Z3672PL	72 x 42 x 30	201	7.75	\$1249	\$1462	N/A	\$692
Z3666PL	66 x 42 x 30	185	7.25	\$1162	\$1330	N/A	\$692
Z3660PL	60 x 42 x 30	170	6.5	\$1092	\$1261	N/A	\$586

Connects to the left side of a worksurface. Attaching hardware included. Accommodates all 19" pedestals (freestanding, mobile and hanging pedestals). Includes grommet as shown. Shipped easy to assemble in 1 carton.

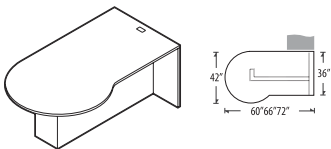

"P" Island RIGHT - Full Modesty Panel (H-Base)*

Z3672PR	72 x 42 x 30	201	7.75	\$1249	\$1462	N/A	\$692
Z3666PR	66 x 42 x 30	185	7.25	\$1162	\$1330	N/A	\$692
Z3660PR	60 x 42 x 30	170	6.5	\$1092	\$1261	N/A	\$586

Connects to the right side of a worksurface. Attaching hardware included. Accommodates all 19" pedestals (freestanding, mobile and hanging pedestals). Includes grommet as shown. Shipped easy to assemble in 1 carton.

RECTANGULAR ISLANDS

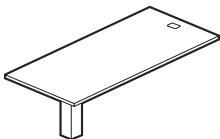

Rectangular Island w/Monopost**

W x D x H (1.5" TOP)							
Z3672RI	72 x 36 x 30	125	7.25	\$936	\$1170	N/A	\$490
Z3066RI	66 x 29.7 x 30	99	6.25	\$861	\$1045	N/A	\$428
Z3060RI	60 x 29.7 x 30	89	5.25	\$833	\$1005	N/A	\$428
Z2466RI	66 x 24 x 30	84	7.5	\$794	\$949	N/A	\$317
Z2460RI	60 x 24 x 30	76	6.5	\$766	\$906	N/A	\$317
Z2448RI	48 x 24 x 30	63	5.75	\$726	\$848	N/A	\$251

Attaches to edge of worksurfaces. Attaching hardware included. Includes grommet as shown. **Not freestanding.** Shipped easy to assemble in 2 cartons.

- Post is shipped in separate carton.

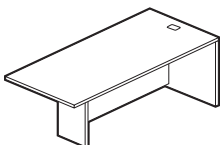

Rectangular Island LEFT - Full Modesty Panel (H-Base)**

Z3672RFIL	72 x 36 x 30	180	7.25	\$1168	\$1397	N/A	\$490
Z3084RFIL	84 x 29.7 x 30	180	7.25	\$1163	\$1386	N/A	\$490
Z3066RFIL	66 x 29.7 x 30	147	6.25	\$1073	\$1257	N/A	\$428
Z3060RFIL	60 x 29.7 x 30	134	5.25	\$987	\$1154	N/A	\$428
Z2472RFIL	72 x 24 x 30	139	6.25	\$920	\$1130	N/A	\$345
Z2466RFIL	66 x 24 x 30	130	5.75	\$879	\$1084	N/A	\$317
Z2460RFIL	60 x 24 x 30	119	5.25	\$822	\$998	N/A	\$317
Z2448RFIL	48 x 24 x 30	101	4.2	\$783	\$918	N/A	\$251

Connects to the **left** side of a worksurface. Attaching hardware included. 36" and 30"D accommodates all 19" pedestals (freestanding, mobile and hanging pedestals). Includes grommet as shown. **Not freestanding.** Shipped easy to assemble in 1 carton.

Required specifications

Top finish
 Top thickness/edge detail
 Base finish*
 Monopost style/finish (not Z36xxPL/R/RFIL)

Optional specifications

HP laminate
 Remove standard grommet (RSG)

Accessories

Pencil drawer*
 Power block**
 Keyboard**

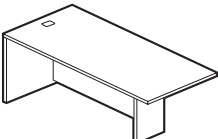
RECTANGULAR ISLANDS	MODEL #	DIMENSIONS	WT/LB.	CUBIC FT.	1" TOP	1.5" TOP	GLAZE ADD	HP ADD
		W x D x H (1.5" TOP)						
	Z3672RFIR	72 x 36 x 30	180	7.25	\$1168	\$1397	N/A	\$490
	Z3084RFIR	84 x 29.7 x 30	180	7.25	\$1163	\$1386	N/A	\$490
	Z3066RFIR	66 x 29.7 x 30	147	6.25	\$1073	\$1257	N/A	\$428
	Z3060RFIR	60 x 29.7 x 30	134	5.25	\$987	\$1154	N/A	\$428
	Z2472RFIR	72 x 24 x 30	139	6.25	\$920	\$1130	N/A	\$345
	Z2466RFIR	66 x 24 x 30	130	5.75	\$879	\$1084	N/A	\$317
	Z2460RFIR	60 x 24 x 30	119	5.25	\$822	\$998	N/A	\$317
	Z2448RFIR	48 x 24 x 30	101	4.2	\$783	\$918	N/A	\$251

Rectangular Island RIGHT - Full Modesty Panel (H-Base)*

Connects to the **right** side of a worksurface. Attaching hardware included. 36" and 30"D accommodates all 19" pedestals (freestanding, mobile and hanging pedestals). Includes grommet as shown. **Not freestanding.**
Shipped easy to assemble in 1 carton.

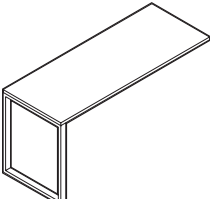
RETURNS W/METAL LEG								
		W x D x H (1.5" TOP)						
	Z3672MRL	72 x 36 x 30	116	11.75	\$1275	\$1505	N/A	\$691
	Z3072MRL	72 x 30 x 30	100	10	\$1169	\$1364	N/A	\$579
	Z3066MRL	66 x 30 x 30	94	9.75	\$1122	\$1300	N/A	\$531
	Z3060MRL	60 x 30 x 30	88	9.25	\$1073	\$1237	N/A	\$485
	Z2472MRL	72 x 24 x 30	85	8.25	\$1073	\$1230	N/A	\$461
	Z2466MRL	66 x 24 x 30	80	8	\$1031	\$1177	N/A	\$425
	Z2460MRL	60 x 24 x 30	75	7.75	\$985	\$1127	N/A	\$383
	Z2448MRL	48 x 24 x 30	56	8	\$849	\$1177	N/A	\$308

Return w/Metal Leg - LEFT**

Flush return attaches to edge of worksurfaces. Attaching hardware included. **Not freestanding.**
Shipped easy to assemble in 2 cartons (leg is shipped in separate carton).

- Note: Glides need to be slightly extended to accommodate the standard 29.5" height of Zira products.

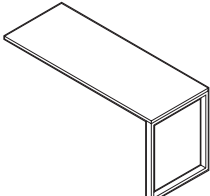
	Z3672MRR	72 x 36 x 30	116	11.75	\$1275	\$1505	N/A	\$691
	Z3072MRR	72 x 30 x 30	100	10	\$1169	\$1364	N/A	\$579
	Z3066MRR	66 x 30 x 30	94	9.75	\$1122	\$1300	N/A	\$531
	Z3060MRR	60 x 30 x 30	88	9.25	\$1073	\$1237	N/A	\$485
	Z2472MRR	72 x 24 x 30	85	8.25	\$1073	\$1230	N/A	\$461
	Z2466MRR	66 x 24 x 30	80	8	\$1031	\$1177	N/A	\$425
	Z2460MRR	60 x 24 x 30	75	7.75	\$985	\$1127	N/A	\$383
	Z2448MRR	48 x 24 x 30	56	5.75	\$849	\$957	N/A	\$308

Return w/Metal Leg - RIGHT**

Flush return attaches to edge of worksurfaces. Attaching hardware included. **Not freestanding.**
Shipped easy to assemble in 2 cartons (leg is shipped in separate carton).

- Note: Glides need to be slightly extended to accommodate the standard 29.5" height of Zira products.

MODESTY PANELS					LIST PRICE
	Z72LMP	66 x 18.1 x 0.69	28	1.25	\$338
	Z66LMP	60 x 18.1 x 0.69	26	1	\$319
	Z60LMP	54 x 18.1 x 0.69	23	1	\$297
	Z48LMP	42 x 18.1 x 0.69	19	0.75	\$251

Laminate Modesty Panel

For returns with metal leg. Modular laminate modesty panel. Specify model number corresponding to worksurface length.

Required specifications

- Top finish
- Top thickness/edge detail (not ZxxLMP)
- Base finish*
- Leg finish**

Optional specifications

- HP laminate (not ZxxLMP)
- Remove standard grommet (RSG)*
- Grommet position or power block cut-out**

Accessories

- Keyboard*
- Pencil drawer*

MOBILE PEDESTALS



Mobile Pedestal with Overhang**

MODEL #	DIMENSIONS W x D x H	WT/LB.	CUBIC FT.	1" TOP	1.5" TOP	GLAZE ADD	HP ADD
ZMPFF28	16 x 29 x 28	106	10.25	\$1400	N/A	N/A	\$222
ZMPFF22	16 x 23 x 28	95	8.25	\$1311	N/A	N/A	\$222

File/file drawers on fully progressive ball bearing slides, accommodate letter/legal size hanging files. Pedestal top features 1" overhang with built-in grip for ease of mobility. Includes counterweight to prevent tipping. Drawers are locking. Only front casters are locking. Shipped assembled in 1 carton.

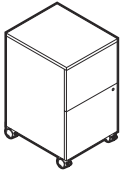

Mobile Pedestal**

ZMPFF19	16 x 19 x 28	97	7.25	\$1249	N/A	N/A	\$222
---------	--------------	----	------	---------------	-----	-----	--------------

File/file drawers on fully progressive ball bearing slides, accommodate letter/legal size hanging files. Drawers are locking. Only front casters are locking. Includes counterweight to prevent tipping. Shipped assembled in 1 carton.



Mobile Pedestal with Overhang**

ZMPBBF28	16 x 29 x 28	105	10.25	\$1326	N/A	N/A	\$222
ZMPBBF22	16 x 23 x 28	92	8.25	\$1252	N/A	N/A	\$222

Box/box/file drawers on fully progressive ball bearing slides, accommodate letter/legal size hanging files. Pedestal top features 1" overhang with built-in grip for ease of mobility. Includes counterweight to prevent tipping. File drawer and lower box drawer are locking. Only front casters are locking. Shipped assembled in 1 carton.



Mobile Pedestal**

ZMPBBF19	16 x 19 x 28	96	7.25	\$1189	N/A	N/A	\$222
----------	--------------	----	------	---------------	-----	-----	--------------

Box/box/file drawers on fully progressive ball bearing slides, accommodate letter/legal size hanging files. File drawer and lower box drawer are locking. Only front casters are locking. Includes counterweight to prevent tipping. Shipped assembled in 1 carton.

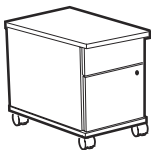

Mobile Pedestal with Overhang**

ZMPBF28	16 x 29 x 22	83	8.25	\$1091	N/A	N/A	\$222
ZMPBF22	16 x 23 x 22	73	6.75	\$1048	N/A	N/A	\$222

Box/file drawers on fully progressive ball bearing slides, accommodate letter/legal size hanging files. Pedestal top features 1" overhang with built-in grip for ease of mobility. Includes counterweight to prevent tipping. Drawers are locking. Only front casters are locking. Shipped assembled in 1 carton.

Required specifications

- Top finish
- Top thickness/edge detail (not pedestals)
- Monopost style/finish*
- Base finish**
- Lock finish**

Optional specifications

- HP laminate
- Key #**
- Handles**

MOBILE PEDESTALS **MODEL #** **DIMENSIONS** **WT/LB.** **CUBIC FT.** **1" TOP** **1.5" TOP** **GLAZE ADD** **HP ADD**



Mobile Pedestal**

	W x D x H							
ZMPBF19	16 x 19 x 22	77	6.25	\$983	N/A	N/A	\$222	

Box/file drawers on fully progressive ball bearing slides, accommodate letter/legal size hanging files. Drawers are locking. Only front casters are locking. Includes counterweight to prevent tipping. Shipped assembled in 1 carton.

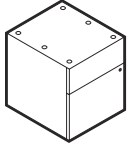

Hanging Pedestal**

ZHPBF18	16 x 19 x 18	48	4.5	\$890	N/A	N/A	N/A	
---------	--------------	----	-----	--------------	-----	-----	-----	--

Box/file drawers on fully progressive ball bearing slides, accommodate letter/legal size hanging files. Drawers are locking. Shipped assembled in 1 carton.

STORAGE SHELLS - 16.87" HIGH

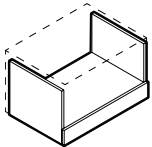

Open Storage Shell

Z36L21SNS	36 x 24 x 16.87	62	11.25	\$718	N/A	N/A	N/A	
Z30L21SNS	30 x 24 x 16.87	55	9.5	\$645	N/A	N/A	N/A	
Z36M21SNS	36 x 20 x 16.87	56	9.5	\$660	N/A	N/A	N/A	
Z30M21SNS	30 x 20 x 16.87	49	8	\$592	N/A	N/A	N/A	

For use **under Zxxxx1TB 17.37"H** top and back kit. **No top or back.** Shipped assembled in 1 carton.

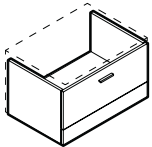

Lateral File Shell*

Z36L21ES	36 x 24 x 16.87	82	11.25	\$1052	N/A	N/A	N/A	
Z30L21ES	30 x 24 x 16.87	77	9.5	\$919	N/A	N/A	N/A	
Z36M21ES	36 x 20 x 16.87	78	9.5	\$1014	N/A	N/A	N/A	
Z30M21ES	30 x 20 x 16.87	73	8	\$879	N/A	N/A	N/A	

For use **under Zxxxx1TB 17.37"H** top and back kit. **No top or back.** 36" and 30" wide models have front-to-back and side-to-side letter/legal filing capability. Side-to-side file bars included. Shipped assembled in 1 carton.

- Lateral file drawer construction is for accommodating hanging files NOT for stacking materials on the drawer bottom.

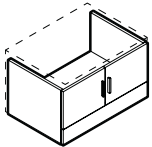

Closed Storage Shell**



Glazed door option

Z36L21SHS	36 x 24 x 16.87	71	11.25	\$955	N/A	\$471	N/A	
Z30L21SHS	30 x 24 x 16.87	62	9.5	\$864	N/A	\$421	N/A	
Z36M21SHS	36 x 20 x 16.87	65	9.5	\$900	N/A	\$471	N/A	
Z30M21SHS	30 x 20 x 16.87	57	8	\$813	N/A	\$421	N/A	

For use **under Zxxxx1TB 17.37"/17.87"H** top and back kit. **No top or back.** Laminate doors are standard. Standard with lock. Shipped assembled in 1 carton.

Required specifications

- Top finish** (not ZHPBF18)
- Base finish
- Lock finish (only pedestals)
- Handles*

Optional specifications

- HP laminate** (not ZHPBF18)
- Key #
- Handles (only pedestals)

STORAGE SHELLS - 16.87" HIGH

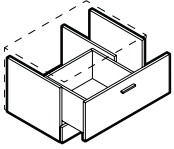

Split Drawer Storage Shell - LEFT**

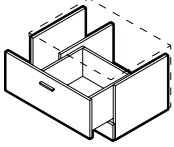

Split Drawer Storage Shell - RIGHT**

MODEL #	DIMENSIONS W x D x H	WT/LB.	CUBIC FT.	1" TOP	1.5" TOP	GLAZE ADD	HP ADD
Z36L21XSL	36 x 24 x 16.87	81	11.25	\$974	N/A	N/A	N/A
Z30L21XSL	30 x 24 x 16.87	72	9.5	\$890	N/A	N/A	N/A
Z36M21XSL	36 x 20 x 16.87	78	9.5	\$936	N/A	N/A	N/A
Z30M21XSL	30 x 20 x 16.87	69	8	\$851	N/A	N/A	N/A

For use under **Zxxxx1TB 17.37"/17.87"H** top and back kit. **No top or back.** Pull out drawer includes filing space on **left** and storage on **right**. Front-to-back letter capability.

- File drawer construction is for accommodating hanging files **NOT** for stacking materials on the drawer bottom.

Shipped assembled in 1 carton.

Z36L21XSR	36 x 24 x 16.87	81	11.25	\$974	N/A	N/A	N/A
Z30L21XSR	30 x 24 x 16.87	72	9.5	\$890	N/A	N/A	N/A
Z36M21XSR	36 x 20 x 16.87	78	9.5	\$936	N/A	N/A	N/A
Z30M21XSR	30 x 20 x 16.87	69	8	\$851	N/A	N/A	N/A

For use under **Zxxxx1TB 17.37"/17.87"H** top and back kit. **No top or back.** Pull out drawer includes filing space on **right** and storage on **left**. Front-to-back letter capability. Shipped assembled in 1 carton.

- File drawer construction is for accommodating hanging files **NOT** for stacking materials on the drawer bottom.

TOP AND BACK KITS FOR 16.87" H STORAGE SHELLS

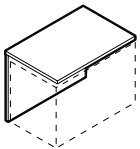

Credenza Top and Back Kit*

	W x D x H (1.5 TOP)						
Z24961TB	96 x 24 x 17.87	104	6.75	\$903	\$1102	N/A	\$631
Z24901TB	90 x 24 x 17.87	97	6.25	\$858	\$1045	N/A	\$592
Z24841TB	84 x 24 x 17.87	91	6	\$805	\$979	N/A	\$552
Z24781TB	78 x 24 x 17.87	86	5.5	\$756	\$916	N/A	\$514
Z24721TB	72 x 24 x 17.87	78	5.25	\$701	\$851	N/A	\$473
Z24661TB	66 x 24 x 17.87	72	4.75	\$648	\$787	N/A	\$436
Z24601TB	60 x 24 x 17.87	66	4.5	\$595	\$719	N/A	\$395
Z24541TB	54 x 24 x 17.87	59	4	\$539	\$651	N/A	\$355
Z24481TB	48 x 24 x 17.87	55	3.75	\$494	\$593	N/A	\$316
Z24421TB	42 x 24 x 17.87	47	3.25	\$437	\$525	N/A	\$276
Z24361TB	36 x 24 x 17.87	40	3	\$378	\$454	N/A	\$237
Z24301TB	30 x 24 x 17.87	34	2.5	\$328	\$391	N/A	\$198
Z20961TB	96 x 20 x 17.87	93	6	\$831	\$997	N/A	\$527
Z20901TB	90 x 20 x 17.87	86	5.5	\$780	\$934	N/A	\$494
Z20841TB	84 x 20 x 17.87	80	5.25	\$734	\$878	N/A	\$461
Z20781TB	78 x 20 x 17.87	76	4.75	\$693	\$827	N/A	\$428
Z20721TB	72 x 20 x 17.87	69	4.5	\$639	\$763	N/A	\$395
Z20661TB	66 x 20 x 17.87	64	4.25	\$592	\$705	N/A	\$361
Z20601TB	60 x 20 x 17.87	58	3.75	\$545	\$650	N/A	\$329
Z20541TB	54 x 20 x 17.87	53	3.5	\$497	\$589	N/A	\$296
Z20481TB	48 x 20 x 17.87	50	3.25	\$455	\$539	N/A	\$263
Z20421TB	42 x 20 x 17.87	42	2.75	\$402	\$474	N/A	\$231
Z20361TB	36 x 20 x 17.87	35	2.5	\$344	\$407	N/A	\$198
Z20301TB	30 x 20 x 17.87	28	2.25	\$298	\$349	N/A	\$166

For use with 16.87" high storage shells. Shipped ready to assemble in 1 carton.

Required specifications

- Top finish*
- Top/edge detail*
- Base finish
- Handles**

Optional specifications

- HP laminate*
- Key #**
- Glazed doors (only Z3xx21SHS)

STORAGE SHELLS - 22.75" HIGH **MODEL #** **DIMENSIONS** **WT/LB.** **CUBIC FT.** **1" TOP** **1.5" TOP** **GLAZE ADD** **HP ADD**

W x D x H

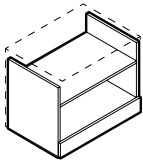

1.5H Open Storage Shell

Z36L2HSHNS	36 x 24 x 22.75	83	14.5	\$891	N/A	N/A	N/A
Z30L2HSHNS	30 x 24 x 22.75	75	12.25	\$805	N/A	N/A	N/A
Z24L2HSHNS	24 x 24 x 22.75	66	10	\$715	N/A	N/A	N/A
Z36M2HSHNS	36 x 20 x 22.75	73	12.25	\$813	N/A	N/A	N/A
Z30M2HSHNS	30 x 20 x 22.75	64	10.5	\$724	N/A	N/A	N/A
Z24M2HSHNS	24 x 20 x 22.75	55	8.5	\$648	N/A	N/A	N/A

For use **under ZxxxxHTB 23.25"/23.75"H** top and back kit. **No top or back.** Shipped assembled in 1 carton.

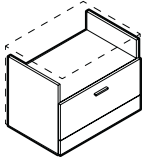

1.5H Open/Lateral File Shell*

Z36L2HFS	36 x 24 x 22.75	102	14.5	\$1224	N/A	N/A	N/A
Z30L2HFS	30 x 24 x 22.75	97	12.25	\$1078	N/A	N/A	N/A
Z36M2HFS	36 x 20 x 22.75	95	12.25	\$1164	N/A	N/A	N/A
Z30M2HFS	30 x 20 x 22.75	88	10.5	\$1013	N/A	N/A	N/A

For use **under ZxxxxHTB 23.25"/23.75"H** top and back kit. **No top or back.** Open shelf and lateral file storage. 36" and 30" wide models have front-to-back and side-to-side letter/legal filing capability. Side-to-side file bars included. Shipped assembled in 1 carton.

- Lateral file drawer construction is for accommodating hanging files NOT for stacking materials on the drawer bottom.

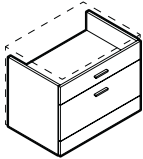

1.5H Box/Lateral File Shell*

Z36L2HES	36 x 24 x 22.75	103	14.5	\$1288	N/A	N/A	N/A
Z30L2HES	30 x 24 x 22.75	99	12.25	\$1142	N/A	N/A	N/A
Z36M2HES	36 x 20 x 22.75	98	12.25	\$1246	N/A	N/A	N/A
Z30M2HES	30 x 20 x 22.75	92	10.5	\$1091	N/A	N/A	N/A

For use **under ZxxxxHTB 23.25"/23.75"H** top and back kit. **No top or back.** Box drawer and lateral file storage. 36" and 30" wide models have front-to-back and side-to-side letter/legal filing capability. Side-to-side file bars included. Shipped assembled in 1 carton.

- Lateral file drawer construction is for accommodating hanging files NOT for stacking materials on the drawer bottom.

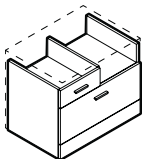

1.5H Mixed Storage Shell - LEFT*

Z36L2HXSL	36 x 24 x 22.75	110	14.5	\$1389	N/A	N/A	N/A
Z30L2HXSL	30 x 24 x 22.75	105	12.25	\$1244	N/A	N/A	N/A
Z36M2HXSL	36 x 20 x 22.75	104	12.25	\$1310	N/A	N/A	N/A
Z30M2HXSL	30 x 20 x 22.75	97	10.5	\$1161	N/A	N/A	N/A

For use **under ZxxxxHTB 23.25"/23.75"H** top and back kit. **No top or back.** Open shelf on **right**, box drawer on **left** and lateral file storage below. 36" and 30" wide models have front-to-back and side-to-side letter/legal filing capability. Side-to-side file bars included. Shipped assembled in 1 carton.

- Lateral file drawer construction is for accommodating hanging files NOT for stacking materials on the drawer bottom.

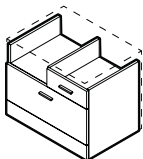

1.5H Mixed Storage Shell - RIGHT*

Z36L2HXSR	36 x 24 x 22.75	110	14.5	\$1389	N/A	N/A	N/A
Z30L2HXSR	30 x 24 x 22.75	105	12.25	\$1244	N/A	N/A	N/A
Z36M2HXSR	36 x 20 x 22.75	104	12.25	\$1310	N/A	N/A	N/A
Z30M2HXSR	30 x 20 x 22.75	97	10.5	\$1161	N/A	N/A	N/A

For use **under ZxxxxHTB 23.25"/23.75"H** top and back kit. **No top or back.** Open shelf on **left**, box drawer on **right** and lateral file storage below. 36" and 30" wide models have front-to-back and side-to-side letter/legal filing capability. Side-to-side file bars included. Shipped assembled in 1 carton.

- Lateral file drawer construction is for accommodating hanging files NOT for stacking materials on the drawer bottom.

Required specifications

Base finish
Handles*

Optional specifications

Key #*

STORAGE SHELLS - 22.75" HIGH

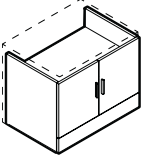

Glazed door option

1.5H Closed Storage Shell**

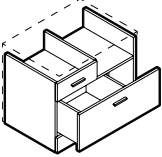

1.5H Split Drawer Storage Shell - LEFT**

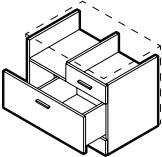

1.5H Split Drawer Storage Shell - RIGHT**

MODEL #	DIMENSIONS W x D x H	WT/LB.	CUBIC FT.	1" TOP	1.5" TOP	GLAZE ADD	HP ADD
Z36L2HSHS	36 x 24 x 22.75	96	14.5	\$1175	N/A	\$589	N/A
Z30L2HSHS	30 x 24 x 22.75	86	12.25	\$1063	N/A	\$521	N/A
Z36M2HSHS	36 x 20 x 22.75	86	12.25	\$1098	N/A	\$589	N/A
Z30M2HSHS	30 x 20 x 22.75	75	10.5	\$982	N/A	\$521	N/A

For use under **ZxxxxHTB 23.25"/23.75"H** top and back kit. **No top or back.** Laminate doors are standard. Standard with lock. Shipped assembled in 1 carton.

Z36L2HCSL	36 x 24 x 22.75	110	14.5	\$1323	N/A	N/A	N/A
Z30L2HCSL	30 x 24 x 22.75	101	12.25	\$1232	N/A	N/A	N/A
Z36M2HCSL	36 x 20 x 22.75	104	12.25	\$1244	N/A	N/A	N/A
Z30M2HCSL	30 x 20 x 22.75	92	10.5	\$1147	N/A	N/A	N/A

For use under **ZxxxxHTB 23.25"/23.75"H** top and back kit. **No top or back.** Open shelf on **right**, box drawer on **left**. Pull out drawer includes filing space on **left** and storage on **right**. Front-to-back letter capability. Shipped assembled in 1 carton.
 • File drawer construction is for accommodating hanging files NOT for stacking materials on the drawer bottom.

Z36L2HCSR	36 x 24 x 22.75	110	14.5	\$1323	N/A	N/A	N/A
Z30L2HCSR	30 x 24 x 22.75	101	12.25	\$1232	N/A	N/A	N/A
Z36M2HCSR	36 x 20 x 22.75	104	12.25	\$1244	N/A	N/A	N/A
Z30M2HCSR	30 x 20 x 22.75	92	10.5	\$1147	N/A	N/A	N/A

For use under **ZxxxxHTB 23.25"/23.75"H** top and back kit. **No top or back.** Open shelf on **left**, box drawer on **right**. Pull out drawer includes filing space on **right** and storage on **left**. Front-to-back letter capability. Shipped assembled in 1 carton.
 • File drawer construction is for accommodating hanging files NOT for stacking materials on the drawer bottom.

TOP AND BACK KITS FOR 22.75"H STORAGE SHELLS

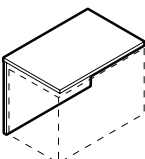

Credenza Top and Back Kit for 22.75"H Storage Shells*

	W x D x H (1.5 TOP)						
Z2496HTB	96 x 24 x 23.75	114	6.75	\$954	\$1153	N/A	\$631
Z2490HTB	90 x 24 x 23.75	107	6.25	\$906	\$1092	N/A	\$592
Z2484HTB	84 x 24 x 23.75	100	6	\$851	\$1025	N/A	\$552
Z2478HTB	78 x 24 x 23.75	94	5.5	\$799	\$961	N/A	\$514
Z2472HTB	72 x 24 x 23.75	87	5.25	\$740	\$890	N/A	\$473
Z2466HTB	66 x 24 x 23.75	80	4.75	\$684	\$823	N/A	\$436
Z2460HTB	60 x 24 x 23.75	72	4.5	\$629	\$753	N/A	\$395
Z2454HTB	54 x 24 x 23.75	65	4	\$569	\$680	N/A	\$355
Z2448HTB	48 x 24 x 23.75	55	3.75	\$519	\$618	N/A	\$316
Z2442HTB	42 x 24 x 23.75	51	3.25	\$461	\$549	N/A	\$276
Z2436HTB	36 x 24 x 23.75	44	3	\$400	\$476	N/A	\$237
Z2430HTB	30 x 24 x 23.75	37	2.5	\$345	\$407	N/A	\$198
Z2096HTB	96 x 20 x 23.75	103	6.25	\$893	\$1060	N/A	\$527
Z2090HTB	90 x 20 x 23.75	97	6	\$844	\$999	N/A	\$494
Z2084HTB	84 x 20 x 23.75	91	5.75	\$793	\$937	N/A	\$461
Z2078HTB	78 x 20 x 23.75	86	5.25	\$741	\$875	N/A	\$428
Z2072HTB	72 x 20 x 23.75	78	5	\$692	\$815	N/A	\$395
Z2066HTB	66 x 20 x 23.75	71	4.5	\$634	\$746	N/A	\$361
Z2060HTB	60 x 20 x 23.75	65	4.25	\$584	\$687	N/A	\$329
Z2054HTB	54 x 20 x 23.75	59	3.75	\$531	\$623	N/A	\$296
Z2048HTB	48 x 20 x 23.75	55	3.5	\$486	\$569	N/A	\$263
Z2042HTB	42 x 20 x 23.75	47	3	\$429	\$504	N/A	\$231
Z2036HTB	36 x 20 x 23.75	40	2.75	\$372	\$434	N/A	\$198
Z2030HTB	30 x 20 x 23.75	33	2.25	\$319	\$370	N/A	\$166

For use with 22.75" high storage shells. Shipped ready to assemble in 1 carton.

Required specifications

- Top finish*
- Top/edge detail*
- Base finish
- Handles**

Optional specifications

- HP laminate*
- Key #***
- Glazed doors (only Z3xx2HSHS)

STORAGE SHELLS - 28.5" HIGH

MODEL #	DIMENSIONS	WT/LB.	CUBIC FT.	1" TOP	1.5" TOP	GLAZE ADD	HP ADD
---------	------------	--------	-----------	--------	----------	-----------	--------

W x D x H

Z36L2SHS	36 x 23.4 x 28.5	100	18.5	\$922	N/A	\$723	N/A
Z30L2SHS	30 x 23.4 x 28.5	88	15.5	\$820	N/A	\$666	N/A
Z36M2SHS	36 x 19.3 x 28.5	89	15.5	\$807	N/A	\$723	N/A
Z30M2SHS	30 x 19.3 x 28.5	78	13.25	\$732	N/A	\$666	N/A

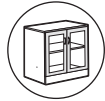
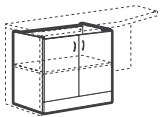

Glazed door option

Storage Shell*

For use **under 29.5/30" H** returns, extended corners, freestanding and connectable tables of the same depth. **No top or back. One adjustable shelf.** Standard with lock. Shipped assembled in 1 carton.

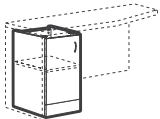

Glazed door option

Storage Shell - LEFT*

Z21L2SHSL	21 x 23.4 x 28.5	70	11	\$636	N/A	\$408	N/A
Z18L2SHSL	18 x 23.4 x 28.5	64	9.75	\$607	N/A	\$373	N/A
Z16L2SHSL	16 x 23.4 x 28.5	60	9	\$570	N/A	\$365	N/A
Z15L2SHSL	15 x 23.4 x 28.5	59	8.25	\$551	N/A	\$326	N/A
Z12L2SHSL	12 x 23.4 x 28.5	53	6.75	\$514	N/A	\$295	N/A
Z21M2SHSL	21 x 19.3 x 28.5	61	9.5	\$542	N/A	\$408	N/A
Z18M2SHSL	18 x 19.3 x 28.5	56	8.25	\$516	N/A	\$373	N/A
Z16M2SHSL	16 x 19.3 x 28.5	52	7	\$488	N/A	\$365	N/A
Z15M2SHSL	15 x 19.3 x 28.5	52	6.75	\$464	N/A	\$326	N/A
Z12M2SHSL	12 x 19.3 x 28.5	47	5.75	\$436	N/A	\$295	N/A

For use **under 29.5/30" H** returns, extended corners, freestanding and connectable tables of the same depth. **No top or back. One adjustable shelf.** Standard with lock. Shipped assembled in 1 carton.

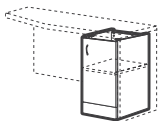

Glazed door option

Storage Shell - RIGHT*

Z21L2SHSR	21 x 23.4 x 28.5	70	11	\$636	N/A	\$408	N/A
Z18L2SHSR	18 x 23.4 x 28.5	64	9.75	\$607	N/A	\$373	N/A
Z16L2SHSR	16 x 23.4 x 28.5	60	9	\$570	N/A	\$365	N/A
Z15L2SHSR	15 x 23.4 x 28.5	59	8.25	\$551	N/A	\$326	N/A
Z12L2SHSR	12 x 23.4 x 28.5	53	6.75	\$514	N/A	\$295	N/A
Z21M2SHSR	21 x 19.3 x 28.5	61	9.5	\$542	N/A	\$408	N/A
Z18M2SHSR	18 x 19.3 x 28.5	56	8.25	\$516	N/A	\$373	N/A
Z16M2SHSR	16 x 19.3 x 28.5	52	7	\$488	N/A	\$365	N/A
Z15M2SHSR	15 x 19.3 x 28.5	52	6.75	\$464	N/A	\$326	N/A
Z12M2SHSR	12 x 19.3 x 28.5	47	5.75	\$436	N/A	\$295	N/A

For use **under 29.5/30" H** returns, extended corners, freestanding and connectable tables of the same depth. **No top or back. One adjustable shelf.** Standard with lock. Shipped assembled in 1 carton.

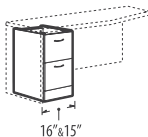
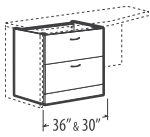

File/File Shell**

Z36L2ES	36 x 23.4 x 28.5	121	18.5	\$1389	N/A	N/A	N/A
Z30L2ES	30 x 23.4 x 28.5	110	15.5	\$1274	N/A	N/A	N/A
Z16L2ES	16 x 23.4 x 28.5	75	9	\$763	N/A	N/A	N/A
Z15L2ES	15 x 23.4 x 28.5	75	8.25	\$747	N/A	N/A	N/A
Z36M2ES	36 x 19.3 x 28.5	114	15.5	\$1279	N/A	N/A	N/A
Z30M2ES	30 x 19.3 x 28.5	102	13.25	\$1195	N/A	N/A	N/A
Z16M2ES	16 x 19.3 x 28.5	69	7	\$700	N/A	N/A	N/A
Z15M2ES	15 x 19.3 x 28.5	68	6.75	\$679	N/A	N/A	N/A

For use **under 29.5/30" H** returns, extended corners, freestanding and connectable tables of the same depth. **No top or back. Two file drawers.** Lock secures all drawers. 36" and 30" wide models have front-to-back and side-to-side letter/legal filing capability. Side-to-side file bars included. Shipped assembled in 1 carton.

- 15" wide models have only side-to-side filing capability.
- Lateral file drawer construction is for accommodating hanging files NOT for stacking materials on the drawer bottom.

Required specifications

Base finish
Handles

Optional specifications

Key #
Box drawer - no upcharge**
Glazed door*

STORAGE SHELLS - 28.5" HIGH

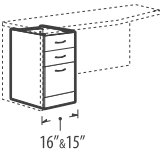

Box/Box/File Shell**

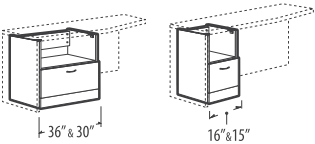

File Shell with Open Shelf*

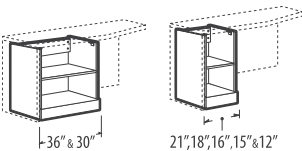

Open Shelving Shell

MODEL #	DIMENSIONS W x D x H	WT/LB.	CUBIC FT.	1" TOP	1.5" TOP	GLAZE ADD	HP ADD
Z16L2BFS	16 x 23.4 x 28.5	77	9	\$881	N/A	N/A	N/A
Z15L2BFS	15 x 23.4 x 28.5	77	8.25	\$864	N/A	N/A	N/A
Z16M2BFS	16 x 19.3 x 28.5	71	7	\$798	N/A	N/A	N/A
Z15M2BFS	15 x 19.3 x 28.5	71	6.75	\$781	N/A	N/A	N/A

For use under 29.5/30"H returns, extended corners, freestanding and connectable tables of the same depth. **No top or back. Two box and one file drawer.** One pencil tray. Lock secures all drawers. Shipped assembled in 1 carton.

- 15" wide models have only side-to-side filing capability.

Z36L2FS	36 x 23.4 x 28.5	109	18.5	\$1080	N/A	N/A	N/A
Z30L2FS	30 x 23.4 x 28.5	98	15.5	\$970	N/A	N/A	N/A
Z16L2FS	16 x 23.4 x 28.5	68	9	\$645	N/A	N/A	N/A
Z15L2FS	15 x 23.4 x 28.5	67	8.25	\$636	N/A	N/A	N/A
Z36M2FS	36 x 19.3 x 28.5	99	15.5	\$958	N/A	N/A	N/A
Z30M2FS	30 x 19.3 x 28.5	89	13.25	\$884	N/A	N/A	N/A
Z16M2FS	16 x 19.3 x 28.5	59	7	\$542	N/A	N/A	N/A
Z15M2FS	15 x 19.3 x 28.5	57	6.75	\$532	N/A	N/A	N/A

For use under 29.5/30"H returns, extended corners, freestanding and connectable tables of the same depth. **No top or back. One file drawer.** Lock secures file drawer. 36" and 30" wide models have front-to-back and side-to-side letter/legal filing capability. Side-to-side file bars included. Shipped assembled in 1 carton.

- 15" wide models have only side-to-side filing capability.
- Lateral file drawer construction is for accommodating hanging files NOT for stacking materials on the drawer bottom.

Z36L2SHSN	36 x 23.4 x 28.5	84	18.5	\$658	N/A	N/A	N/A
Z30L2SHSN	30 x 23.4 x 28.5	75	15.5	\$582	N/A	N/A	N/A
Z21L2SHSN	21 x 23.4 x 28.5	61	11	\$487	N/A	N/A	N/A
Z18L2SHSN	18 x 23.4 x 28.5	56	9.75	\$474	N/A	N/A	N/A
Z16L2SHSN	16 x 23.4 x 28.5	53	9	\$437	N/A	N/A	N/A
Z15L2SHSN	15 x 23.4 x 28.5	52	8.25	\$428	N/A	N/A	N/A
Z12L2SHSN	12 x 23.4 x 28.5	48	6.75	\$398	N/A	N/A	N/A
Z36M2SHSN	36 x 19.3 x 28.5	73	15.5	\$546	N/A	N/A	N/A
Z30M2SHSN	30 x 19.3 x 28.5	65	13.25	\$491	N/A	N/A	N/A
Z21M2SHSN	21 x 19.3 x 28.5	52	9.5	\$395	N/A	N/A	N/A
Z18M2SHSN	18 x 19.3 x 28.5	48	8.25	\$382	N/A	N/A	N/A
Z16M2SHSN	16 x 19.3 x 28.5	45	7	\$354	N/A	N/A	N/A
Z15M2SHSN	15 x 19.3 x 28.5	45	6.75	\$343	N/A	N/A	N/A
Z12M2SHSN	12 x 19.3 x 28.5	42	5.75	\$320	N/A	N/A	N/A

For use under 29.5/30"H returns, extended corners, freestanding and connectable tables of the same depth. **No top or back. One adjustable shelf.** Shipped assembled in 1 carton.

Required specifications

Base finish
Handles

Optional specifications

Key #
Box drawer - no upcharge**

MIXED STORAGE SHELLS - 29.5" HIGH

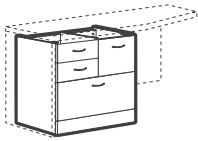

Mixed Storage Shell - LEFT

MODEL #	DIMENSIONS W x D x H	WT/LB.	CUBIC FT.	1" TOP	1.5" TOP	GLAZE ADD	HP ADD
Z36L2XSL	36 x 23.4 x 28.5	152	18.5	\$1674	N/A	N/A	N/A
Z30L2XSL	30 x 23.4 x 28.5	136	15.5	\$1533	N/A	N/A	N/A
Z36M2XSL	36 x 19.3 x 28.5	139	15.5	\$1576	N/A	N/A	N/A
Z30M2XSL	30 x 19.3 x 28.5	124	13.25	\$1467	N/A	N/A	N/A

For use **under 29.5/30"H** returns, extended corners, freestanding and connectable tables of the same depth. **No top or back.** Two box drawers on **left**, one file drawer on **right** accommodates letter filing side-to-side and one lateral file drawer on bottom (see filing orientation on page 120). Right lock secures two box and one file drawer, the left lock secures the lateral file. One pencil tray. Front-to-back and side-to-side letter/legal filing capability in lateral drawer, file bars included. Shipped assembled in 1 carton.

- Lateral file drawer construction is for accommodating hanging files **NOT** for stacking materials on the drawer bottom.
- Top file drawer supports hanging folders only, does **NOT** accept hanging folders with plastic tabs.

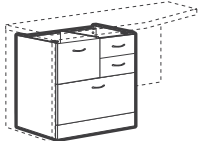

Mixed Storage Shell - RIGHT

Z36L2XSR	36 x 23.4 x 28.5	152	18.5	\$1674	N/A	N/A	N/A
Z30L2XSR	30 x 23.4 x 28.5	136	15.5	\$1533	N/A	N/A	N/A
Z36M2XSR	36 x 19.3 x 28.5	139	15.5	\$1576	N/A	N/A	N/A
Z30M2XSR	30 x 19.3 x 28.5	124	13.25	\$1467	N/A	N/A	N/A

For use **under 29.5/30"H** returns, extended corners, freestanding and connectable tables of the same depth. **No top or back.** Two box drawers on **right**, one file drawer on **left** accommodates letter filing side-to-side and one lateral file drawer on bottom (see filing orientation on page 120). Right lock secures two box and one file drawer, the left lock secures the lateral file. One pencil tray. Front-to-back and side-to-side letter/legal filing capability in lateral drawer, file bars included. Shipped assembled in 1 carton.

- Lateral file drawer construction is for accommodating hanging files **NOT** for stacking materials on the drawer bottom.
- Top file drawer supports hanging folders only, does **NOT** accept hanging folders with plastic tabs.

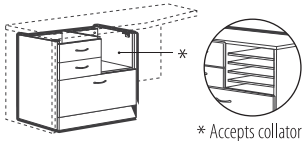

Mixed Storage Shell with Open Shelf - LEFT*

Z36L2XNSL	36 x 23.4 x 28.5	133	18.5	\$1415	N/A	N/A	N/A
Z30L2XNSL	30 x 23.4 x 28.5	121	15.5	\$1286	N/A	N/A	N/A
Z36M2XNSL	36 x 19.3 x 28.5	121	15.5	\$1316	N/A	N/A	N/A
Z30M2XNSL	30 x 19.3 x 28.5	109	13.25	\$1223	N/A	N/A	N/A

For use **under 29.5/30"H** returns, extended corners, freestanding and connectable tables of the same depth. **No top or back.** Two box drawers on **left**, one open shelf on **right** and one lateral file drawer on bottom. Lock secures all drawers. One pencil tray. Front-to-back and side-to-side letter/legal filing capability. Side-to-side file bars included. Shipped assembled in 1 carton.

- Lateral file drawer construction is for accommodating hanging files **NOT** for stacking materials on the drawer bottom.

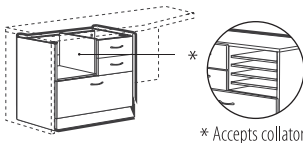

Mixed Storage Shell with Open Shelf - RIGHT*

Z36L2XNSR	36 x 23.4 x 28.5	133	18.5	\$1415	N/A	N/A	N/A
Z30L2XNSR	30 x 23.4 x 28.5	121	15.5	\$1286	N/A	N/A	N/A
Z36M2XNSR	36 x 19.3 x 28.5	121	15.5	\$1316	N/A	N/A	N/A
Z30M2XNSR	30 x 19.3 x 28.5	109	13.25	\$1223	N/A	N/A	N/A

For use **under 29.5/30"H** returns, extended corners, freestanding and connectable tables of the same depth. **No top or back.** Two box drawers on **right**, one open shelf on **left** and one lateral file drawer on bottom. Lock secures all drawers. One pencil tray. Front-to-back and side-to-side letter/legal filing capability. Side-to-side file bars included. Shipped assembled in 1 carton.

- Lateral file drawer construction is for accommodating hanging files **NOT** for stacking materials on the drawer bottom.

Required specifications

Base finish
Handles

Optional specifications

Key #
Box drawer - no upcharge
Collator - position & finish*

TOP AND BACK KITS FOR 28.5"H STORAGE SHELLS

MODEL #	DIMENSIONS	WT/LB.	CUBIC FT.	1" TOP	1.5" TOP	GLAZE ADD	HP ADD
W x D x H (1.5" TOP)							
Z2496TB	96 x 24 x 29.5	126	7.75	\$1048	\$1247	N/A	\$631
Z2490TB	90 x 24 x 29.5	118	7.25	\$989	\$1175	N/A	\$592
Z2484TB	84 x 24 x 29.5	111	6.75	\$930	\$1104	N/A	\$552
Z2478TB	78 x 24 x 29.5	104	6.25	\$866	\$1029	N/A	\$514
Z2472TB	72 x 24 x 29.5	159	6.25	\$822	\$996	N/A	\$388
Z2466TB	66 x 24 x 29.5	112	5.75	\$822	\$996	N/A	\$388
Z2460TB	60 x 24 x 29.5	381	5.25	\$720	\$836	N/A	\$383
Z2454TB	54 x 24 x 29.5	72	4.5	\$619	\$730	N/A	\$355
Z2448TB	48 x 24 x 29.5	66	4	\$565	\$664	N/A	\$316
Z2442TB	42 x 24 x 29.5	57	3.75	\$503	\$591	N/A	\$276
Z2436TB	36 x 24 x 29.5	49	3.25	\$426	\$502	N/A	\$237
Z2430TB	30 x 24 x 29.5	102	2.75	\$377	\$439	N/A	\$198
Z2096TB	96 x 20 x 29.5	116	7.75	\$988	\$1154	N/A	\$527
Z2090TB	90 x 20 x 29.5	109	7.25	\$933	\$1087	N/A	\$494
Z2084TB	84 x 20 x 29.5	102	6.75	\$875	\$1020	N/A	\$461
Z2078TB	78 x 20 x 29.5	95	6.25	\$817	\$952	N/A	\$428
Z2072TB	72 x 20 x 29.5	159	6.25	\$777	\$916	N/A	\$355
Z2066TB	66 x 20 x 29.5	81	5.5	\$777	\$916	N/A	\$355
Z2060TB	60 x 20 x 29.5	159	5.25	\$700	\$810	N/A	\$322
Z2054TB	54 x 20 x 29.5	66	4.5	\$584	\$676	N/A	\$296
Z2048TB	48 x 20 x 29.5	61	4	\$532	\$615	N/A	\$263
Z2042TB	42 x 20 x 29.5	52	3.75	\$474	\$546	N/A	\$231
Z2036TB	36 x 20 x 29.5	45	3.25	\$402	\$464	N/A	\$198
Z2030TB	30 x 20 x 29.5	38	2.75	\$355	\$407	N/A	\$166

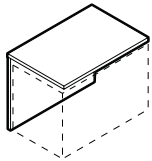

Credenza Top and Back Kits - for 28"H Storage Shells

For use with 28" high storage shells. Shipped easy to assemble in 1 carton.

Required specifications

Top finish
Top thickness/edge detail
Base finish

Optional specifications

HP laminate

STORAGE MODULES - 17.87"/18.37" HIGH

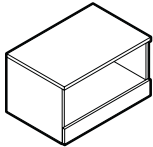

1H Open Storage

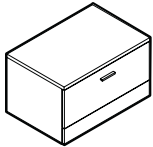

1H Lateral File*

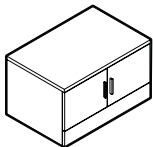

1H Storage Cabinet*



Glazed door option

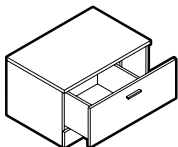

1H Split Drawer Storage - LEFT*

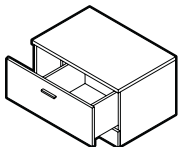

1H Split Drawer Storage - RIGHT*

MODEL #	DIMENSIONS W x D x H (1.5" TOP)	WT/LB.	CUBIC FT.	1" TOP	1.5" TOP	GLAZE ADD	HP ADD
Z36L21SHN	36 x 24 x 18.37	82	11.75	\$847	\$923	N/A	\$237
Z30L21SHN	30 x 24 x 18.37	74	10	\$777	\$840	N/A	\$198
Z36M21SHN	36 x 20 x 18.37	71	10	\$767	\$829	N/A	\$198
Z30M21SHN	30 x 20 x 18.37	62	8.5	\$691	\$743	N/A	\$166

Open shelf. Shipped assembled in 1 carton.

Z36L21E	36 x 24 x 18.37	103	11.75	\$1251	\$1327	N/A	\$237
Z30L21E	30 x 24 x 18.37	97	10	\$1069	\$1131	N/A	\$198
Z36M21E	36 x 20 x 18.37	95	10	\$1189	\$1251	N/A	\$198
Z30M21E	30 x 20 x 18.37	88	8.5	\$998	\$1049	N/A	\$166

One file drawer. Lock secures drawer. 36" and 30" wide models have front-to-back and side-to-side letter/legal filing capability. Side-to-side file bars included. Shipped assembled in 1 carton.

- Lateral file drawer construction is for accommodating hanging files NOT for stacking materials on the drawer bottom.

Z36L21SH	36 x 24 x 18.37	90	11.75	\$1085	\$1161	\$471	\$237
Z30L21SH	30 x 24 x 18.37	81	10	\$997	\$1059	\$420	\$198
Z36M21SH	36 x 20 x 18.37	80	10	\$1005	\$1067	\$471	\$198
Z30M21SH	30 x 20 x 18.37	69	8.5	\$911	\$962	\$420	\$166

Laminate doors are standard. Standard with lock. Shipped assembled in 1 carton.

Z36L21XHL	36 x 24 x 18.37	102	11.75	\$1176	\$1252	N/A	\$237
Z30L21XHL	30 x 24 x 18.37	92	10	\$1045	\$1108	N/A	\$198
Z36M21XHL	36 x 20 x 18.37	95	10	\$1113	\$1176	N/A	\$198
Z30M21XHL	30 x 20 x 18.37	83	8.5	\$974	\$1026	N/A	\$166

Pull out drawer includes filing space on **left** and storage on **right**. Lock secures drawer. 36" and 30" wide models have front-to-back letter filing capability. Shipped assembled in 1 carton.

- File drawer construction is for accommodating hanging files NOT for stacking materials on the drawer bottom.

Z36L21XHR	36 x 24 x 18.37	102	11.75	\$1176	\$1252	N/A	\$237
Z30L21XHR	30 x 24 x 18.37	92	10	\$1045	\$1108	N/A	\$198
Z36M21XHR	36 x 20 x 18.37	95	10	\$1113	\$1176	N/A	\$198
Z30M21XHR	30 x 20 x 18.37	83	8.5	\$974	\$1026	N/A	\$166

Pull out drawer includes filing space on **right** and storage on **left**. Lock secures drawer. 36" and 30" wide models have front-to-back letter filing capability. Shipped assembled in 1 carton.

- File drawer construction is for accommodating hanging files NOT for stacking materials on the drawer bottom.

Required specifications

- Top finish
- Top thickness/edge detail
- Base finish
- Handles*

Optional specifications

- HP laminate
- Key #*
- Glazed doors (only Z3xx21SH)

STORAGE MODULES - 23.75" / 24.25" HIGH

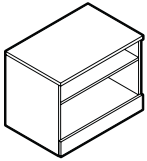

1.5H Open Storage

MODEL #	DIMENSIONS W x D x H (1.5" TOP)	WT/LB.	CUBIC FT.	1" TOP	1.5" TOP	GLAZE ADD	HP ADD
Z36L2HSHN	36 x 24 x 24.25	106	15	\$1040	\$1116	N/A	\$237
Z30L2HSHN	30 x 24 x 24.25	94	12.75	\$944	\$1006	N/A	\$198
Z36M2HSHN	36 x 20 x 24.25	92	12.75	\$938	\$1000	N/A	\$198
Z30M2HSHN	30 x 20 x 24.25	80	10.75	\$843	\$894	N/A	\$166

One adjustable shelf. Shipped assembled in 1 carton.

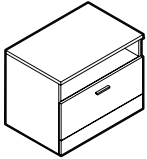

1.5H Open/Lateral File Storage*

Z36L2HFN	36 x 24 x 24.25	127	15	\$1444	\$1520	N/A	\$237
Z30L2HFN	30 x 24 x 24.25	118	12.75	\$1236	\$1299	N/A	\$198
Z36M2HFN	36 x 20 x 24.25	116	12.75	\$1360	\$1422	N/A	\$198
Z30M2HFN	30 x 20 x 24.25	106	10.75	\$1148	\$1199	N/A	\$166

Open shelf on top. Lateral file below. Lock secures drawer. 36" and 30" wide models have front-to-back and side-to-side letter/legal filing capability. Side-to-side file bars included. Shipped assembled in 1 carton.

- Lateral file drawer construction is for accommodating hanging files NOT for stacking materials on the drawer bottom.

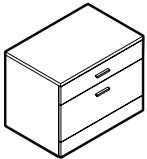

1.5H Box/Lateral File Storage*

Z36L2HE	36 x 24 x 24.25	126	15	\$1526	\$1603	N/A	\$237
Z30L2HE	30 x 24 x 24.25	118	12.75	\$1315	\$1378	N/A	\$198
Z36M2HE	36 x 20 x 24.25	118	12.75	\$1460	\$1523	N/A	\$198
Z30M2HE	30 x 20 x 24.25	108	10.75	\$1242	\$1293	N/A	\$166

Box drawer on top. Lateral file below. Lock secures both drawers. 36" and 30" wide models have front-to-back and side-to-side letter/legal filing capability. Side-to-side file bars included. Shipped assembled in 1 carton.

- Lateral file drawer construction is for accommodating hanging files NOT for stacking materials on the drawer bottom.

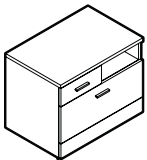

1.5H Mixed Storage - LEFT*

Z36L2HXNL	36 x 24 x 24.25	132	15	\$1580	\$1656	N/A	\$237
Z30L2HXNL	30 x 24 x 24.25	123	12.75	\$1370	\$1433	N/A	\$198
Z36M2HXNL	36 x 20 x 24.25	121	12.75	\$1497	\$1559	N/A	\$198
Z30M2HXNL	30 x 20 x 24.25	111	10.75	\$1286	\$1337	N/A	\$166

Open shelf on **right**, box drawer on **left** and lateral file storage below. Lock secures both drawers. 36" and 30" wide models have front-to-back letter filing capability. Shipped assembled in 1 carton.

- Lateral file drawer construction is for accommodating hanging files NOT for stacking materials on the drawer bottom.

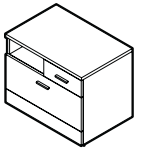

1.5H Mixed Storage - RIGHT*

Z36L2HXNR	36 x 24 x 24.25	132	15	\$1580	\$1656	N/A	\$237
Z30L2HXNR	30 x 24 x 24.25	123	12.75	\$1370	\$1433	N/A	\$198
Z36M2HXNR	36 x 20 x 24.25	121	12.75	\$1497	\$1559	N/A	\$198
Z30M2HXNR	30 x 20 x 24.25	111	10.75	\$1286	\$1337	N/A	\$166

Open shelf on **left**, box drawer on **right** and lateral file storage below. Lock secures both drawers. 36" and 30" wide models have front-to-back letter filing capability. Shipped assembled in 1 carton.

- Lateral file drawer construction is for accommodating hanging files NOT for stacking materials on the drawer bottom.

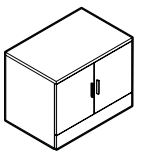

1.5H Closed Storage**



Glazed door option

Z36L2HSH	36 x 24 x 24.25	119	15	\$1327	\$1403	N/A	\$237
Z30L2HSH	30 x 24 x 24.25	105	12.75	\$1201	\$1264	N/A	\$198
Z36M2HSH	36 x 20 x 24.25	105	12.75	\$1223	\$1285	N/A	\$198
Z30M2HSH	30 x 20 x 24.25	91	10.75	\$1099	\$1150	N/A	\$166

Closed storage with one adjustable shelf. Laminate doors are standard. Includes one adjustable shelf. Standard with lock. Shipped assembled in 1 carton.

Required specifications

Top finish
Top thickness/edge detail
Base finish
Handles*

Optional specifications

HP laminate
Key #*
Glazed doors (only Z3xx2HSH)

STORAGE MODULES - 23.75" / 24.25" HIGH

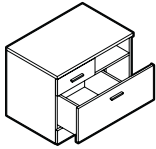

1.5H Split Drawer Storage - LEFT

MODEL #	DIMENSIONS W x D x H (1.5" TOP)	WT/LB.	CUBIC FT.	1" TOP	1.5" TOP	GLAZE ADD	HP ADD
Z36L2HXHL	36 x 24 x 24.25	132	15	\$1516	\$1592	N/A	\$237
Z30L2HXHL	30 x 24 x 24.25	118	12.75	\$1362	\$1424	N/A	\$198
Z36M2HXHL	36 x 20 x 24.25	121	12.75	\$1432	\$1494	N/A	\$198
Z30M2HXHL	30 x 20 x 24.25	107	10.75	\$1275	\$1326	N/A	\$166

Open shelf on **right**, box drawer on **left**. Pull out drawer includes filing space on **left** and storage on **right**.
Shipped assembled in 1 carton.

- File drawer construction is for accommodating hanging files **NOT** for stacking materials on the drawer bottom.

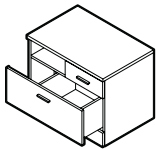

1.5H Split Drawer Storage - RIGHT

Z36L2HXHR	36 x 24 x 24.25	132	15	\$1516	\$1592	N/A	\$237
Z30L2HXHR	30 x 24 x 24.25	118	12.75	\$1362	\$1424	N/A	\$198
Z36M2HXHR	36 x 20 x 24.25	121	12.75	\$1432	\$1494	N/A	\$198
Z30M2HXHR	30 x 20 x 24.25	107	10.75	\$1275	\$1326	N/A	\$166

Open shelf on **left**, box drawer on **right**. Pull out drawer includes filing space on **right** and storage on **left**.
Shipped assembled in 1 carton.

- File drawer construction is for accommodating hanging files **NOT** for stacking materials on the drawer bottom.

STORAGE CABINET - 29.5" / 30" HIGH

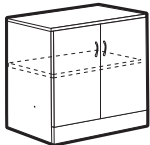

Glazed door option

Storage Cabinet with Doors*

Z36L2SH	36 x 24 x 30	143	18.5	\$1232	\$1301	\$723	\$171
Z30L2SH	30 x 24 x 30	124	15.5	\$1110	\$1172	\$666	\$144
Z36M2SH	36 x 20 x 30	126	15.5	\$1130	\$1192	\$723	\$171
Z30M2SH	30 x 20 x 30	109	13.25	\$1024	\$1076	\$666	\$144
Z36S2SH	36 x 16 x 30	110	12.5	\$1046	\$1107	\$723	\$128
Z30S2SH	30 x 16 x 30	93	10.5	\$920	\$962	\$666	\$114

Laminate doors are standard. **Includes one adjustable shelf.** Standard with lock. Shipped assembled in 1 carton.

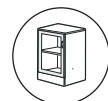
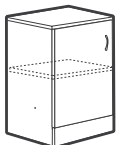

Glazed door option

Storage Cabinet with Door - LEFT*

Z21L2SHL	21 x 24 x 30	95	11	\$902	\$952	\$408	\$114
Z18L2SHL	18 x 24 x 30	85	9.75	\$848	\$890	\$373	\$87
Z16L2SHL	16 x 24 x 30	80	9	\$815	\$857	\$365	\$65
Z15L2SHL	15 x 24 x 30	77	8.25	\$758	\$792	\$326	\$65
Z12L2SHL	12 x 24 x 30	68	6.75	\$714	\$744	\$295	\$57
Z21M2SHL	21 x 20 x 30	84	9.5	\$802	\$844	\$408	\$87
Z18M2SHL	18 x 20 x 30	76	8.25	\$759	\$794	\$373	\$87
Z16M2SHL	16 x 20 x 30	69	7	\$717	\$752	\$365	\$65
Z15M2SHL	15 x 20 x 30	66	6.75	\$682	\$712	\$326	\$57
Z12M2SHL	12 x 20 x 30	60	5.75	\$636	\$661	\$295	\$57
Z21S2SHL	21 x 16 x 30	71	7.5	\$732	\$765	\$408	\$57
Z18S2SHL	18 x 16 x 30	64	6.75	\$701	\$735	\$373	\$57
Z16S2SHL	16 x 16 x 30	59	6	\$671	\$705	\$365	\$57
Z15S2SHL	15 x 16 x 30	57	5.75	\$630	\$659	\$326	\$57
Z12S2SHL	12 x 16 x 30	50	4.75	\$590	\$615	\$295	\$57

Laminate doors are standard. **Includes one adjustable shelf.** Standard with lock. Shipped assembled in 1 carton.

Required specifications

- Top finish
- Top thickness/edge detail
- Base finish
- Handles

Optional specifications

- HP laminate
- Key #
- Glazed doors*

STORAGE CABINETS - 29.5" / 30" HIGH

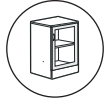
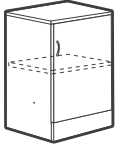

Glazed door option

Storage Cabinet with Door - RIGHT*

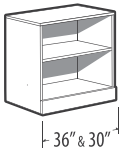

21", 18", 16", 15" & 12"

Open Storage Cabinet

MODEL #	DIMENSIONS	WT/LB.	CUBIC FT.	1" TOP	1.5" TOP	GLAZE ADD	HP ADD
W x D x H (1.5" TOP)							
Z21L2SHR	21 x 24 x 30	95	11	\$902	\$952	\$408	\$114
Z18L2SHR	18 x 24 x 30	85	9.75	\$848	\$890	\$373	\$87
Z16L2SHR	16 x 24 x 30	80	9	\$815	\$857	\$365	\$65
Z15L2SHR	15 x 24 x 30	77	8.25	\$758	\$792	\$326	\$65
Z12L2SHR	12 x 24 x 30	68	6.75	\$714	\$744	\$295	\$57
Z21M2SHR	21 x 20 x 30	84	9.5	\$802	\$844	\$408	\$87
Z18M2SHR	18 x 20 x 30	76	8.25	\$759	\$794	\$373	\$87
Z16M2SHR	16 x 20 x 30	69	7	\$717	\$752	\$365	\$65
Z15M2SHR	15 x 20 x 30	66	6.75	\$682	\$712	\$326	\$57
Z12M2SHR	12 x 20 x 30	60	5.75	\$636	\$661	\$295	\$57
Z21S2SHR	21 x 16 x 30	71	7.5	\$732	\$765	\$408	\$57
Z18S2SHR	18 x 16 x 30	64	6.75	\$701	\$735	\$373	\$57
Z16S2SHR	16 x 16 x 30	59	6	\$671	\$705	\$365	\$57
Z15S2SHR	15 x 16 x 30	57	5.75	\$630	\$659	\$326	\$57
Z12S2SHR	12 x 16 x 30	50	4.75	\$590	\$615	\$295	\$57

Laminate doors are standard. **Includes one adjustable shelf.** Standard with lock. Shipped assembled in 1 carton.

Z36L2SHN	36 x 24 x 30	127	18.5	\$971	\$1040	N/A	\$171
Z30L2SHN	30 x 24 x 30	111	15.5	\$871	\$933	N/A	\$144
Z21L2SHN	21 x 24 x 30	86	11	\$758	\$808	N/A	\$114
Z18L2SHN	18 x 24 x 30	78	9.75	\$715	\$757	N/A	\$87
Z16L2SHN	16 x 24 x 30	71	9	\$682	\$724	N/A	\$65
Z15L2SHN	15 x 24 x 30	63	8.25	\$633	\$667	N/A	\$57
Z12L2SHN	12 x 24 x 30	60	6.75	\$598	\$628	N/A	\$57
Z36M2SHN	36 x 20 x 30	112	15.5	\$868	\$930	N/A	\$128
Z30M2SHN	30 x 20 x 30	97	13.25	\$784	\$836	N/A	\$114
Z21M2SHN	21 x 20 x 30	74	9.5	\$655	\$697	N/A	\$87
Z18M2SHN	18 x 20 x 30	68	8.25	\$620	\$655	N/A	\$69
Z16M2SHN	16 x 20 x 30	63	7	\$586	\$621	N/A	\$57
Z15M2SHN	15 x 20 x 30	61	6.75	\$561	\$591	N/A	\$57
Z12M2SHN	12 x 20 x 30	55	5.75	\$518	\$543	N/A	\$57
Z36S2SHN	36 x 16 x 30	96	12.5	\$780	\$841	N/A	\$128
Z30S2SHN	30 x 16 x 30	83	10.5	\$679	\$721	N/A	\$114
Z21S2SHN	21 x 16 x 30	63	7.5	\$586	\$619	N/A	\$87
Z18S2SHN	18 x 16 x 30	56	6.75	\$564	\$598	N/A	\$69
Z16S2SHN	16 x 16 x 30	52	6	\$536	\$570	N/A	\$57
Z15S2SHN	15 x 16 x 30	50	5.75	\$507	\$536	N/A	\$57
Z12S2SHN	12 x 16 x 30	45	4.75	\$472	\$497	N/A	\$57

One adjustable shelf. Shipped assembled in 1 carton.

Required specifications

- Top finish
- Top thickness/edge detail
- Base finish
- Handles*

Optional specifications

- HP laminate
- Key #*
- Glazed door*

FILE MODULES - 29.5" / 30" HIGH

MODEL #	DIMENSIONS W x D x H (1.5" TOP)	WT/LB.	CUBIC FT.	1" TOP	1.5" TOP	GLAZE ADD	HP ADD
Z36L2FN	36 x 24 x 30	153	18.5	\$1390	\$1459	N/A	\$171
Z30L2FN	30 x 24 x 30	134	15.5	\$1254	\$1316	N/A	\$144
Z16L2FN	16 x 24 x 30	87	9	\$877	\$919	N/A	\$87
Z15L2FN	15 x 24 x 30	83	8.25	\$827	\$861	N/A	\$69
Z36M2FN	36 x 20 x 30	135	15.5	\$1286	\$1348	N/A	\$171
Z30M2FN	30 x 20 x 30	119	13.25	\$1179	\$1231	N/A	\$144
Z16M2FN	16 x 20 x 30	76	7	\$781	\$816	N/A	\$87
Z15M2FN	15 x 20 x 30	72	6.75	\$750	\$780	N/A	\$69
Z36S2FN	36 x 16 x 30	114	12.5	\$1162	\$1223	N/A	\$128
Z30S2FN	30 x 16 x 30	98	10.5	\$1030	\$1072	N/A	\$114
Z16S2FN	16 x 16 x 30	63	6	\$726	\$760	N/A	\$65
Z15S2FN	15 x 16 x 30	61	5.75	\$692	\$721	N/A	\$57

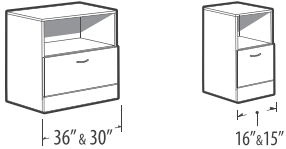

File Module with Open Shelf*

Open shelf and one file drawer on bottom. Lock secures file drawer. 36" and 30" wide models have front-to-back and side-to-side letter/legal filing capability. Side-to-side file bars included. Shipped assembled in 1 carton.

- 15" wide models have only side-to side filing capability.
- Lateral file drawer construction is for accommodating hanging files NOT for stacking materials on the drawer bottom.

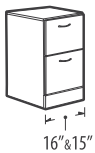

Two File Module*

Z36L2E	36 x 24 x 30	165	18.5	\$1705	\$1774	N/A	\$171
Z30L2E	30 x 24 x 30	146	15.5	\$1560	\$1622	N/A	\$144
Z16L2E	16 x 24 x 30	96	9	\$1003	\$1045	N/A	\$87
Z15L2E	15 x 24 x 30	91	8.25	\$944	\$978	N/A	\$69
Z36M2E	36 x 20 x 30	149	15.5	\$1609	\$1671	N/A	\$171
Z30M2E	30 x 20 x 30	133	13.25	\$1493	\$1545	N/A	\$144
Z16M2E	16 x 20 x 30	85	7	\$912	\$947	N/A	\$87
Z15M2E	15 x 20 x 30	82	6.75	\$878	\$908	N/A	\$69
Z36S2E	36 x 16 x 30	128	12.5	\$1514	\$1575	N/A	\$128
Z30S2E	30 x 16 x 30	110	10.5	\$1375	\$1417	N/A	\$114
Z16S2E	16 x 16 x 30	74	6	\$902	\$936	N/A	\$65
Z15S2E	15 x 16 x 30	71	5.75	\$871	\$900	N/A	\$57

Two file drawers. Lock secures all drawers. 36" and 30" wide models have front-to-back and side-to-side letter/legal filing capability. Side-to-side file bars included. Shipped assembled in 1 carton.

- 15" wide models have only side-to side filing capability.
- Lateral file drawer construction is for accommodating hanging files NOT for stacking materials on the drawer bottom.



Two File Module

Z36L2SE	36 x 24 x 30	180	18.5	\$2004	\$2073	N/A	\$171
Z36M2SE	36 x 20 x 30	164	15.5	\$1927	\$1990	N/A	\$171

Two lateral file drawers with **steel drawer interior**. Steel drawer construction includes metal sides and masonite bottoms. Lock secures all drawers. Front-to-back and side-to-side letter/legal filing capability. Side-to-side file bars included. Shipped assembled in 1 carton.

- Front-to-back filing bars available separately. Order **FBB** bars. See Metal Filing + Storage price list page 14.
- Lateral file drawer construction is for accommodating hanging files NOT for stacking materials on the drawer bottom.



Box/Box/File Module

Z16L2BF	16 x 24 x 30	98	9	\$1130	\$1172	N/A	\$87
Z15L2BF	15 x 24 x 30	93	8.25	\$1079	\$1113	N/A	\$87
Z16M2BF	16 x 20 x 30	87	7	\$1036	\$1071	N/A	\$87
Z15M2BF	15 x 20 x 30	84	6.75	\$1008	\$1038	N/A	\$87
Z16S2BF	16 x 16 x 30	74	6	\$965	\$999	N/A	\$65
Z15S2BF	15 x 16 x 30	71	5.75	\$922	\$951	N/A	\$65

Two box and one file drawer. One pencil tray. Lock secures all drawers. Shipped assembled in 1 carton.

Required specifications

- Top finish
- Top thickness/edge detail
- Base finish
- Handles

Optional specifications

- HP laminate
- Key #
- Box drawer - no upcharge (not Z36x2SE)

MIXED STORAGE CABINETS - 29.5" / 30" HIGH



Mixed Storage Cabinet



Mixed Storage Cabinet

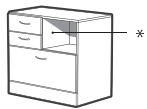

* Accepts collator

Mixed Drawer Cabinet with Open Shelf*

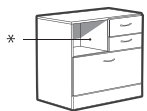

* Accepts collator

Mixed Drawer Cabinet with Open Shelf*

MODEL #	DIMENSIONS	WT/LB.	CUBIC FT.	1" TOP	1.5" TOP	GLAZE ADD	HP ADD
W x D x H (1.5" TOP)							
Z36L2XL	36 x 24 x 30	187	18.5	\$1944	\$2009	N/A	\$171
Z30L2XL	30 x 24 x 30	166	15.5	\$1772	\$1833	N/A	\$144
Z36M2XL	36 x 20 x 30	177	15.5	\$1823	\$1885	N/A	\$171
Z30M2XL	30 x 20 x 30	152	13.25	\$1683	\$1735	N/A	\$144
Z36S2XL	36 x 16 x 30	145	12.5	\$1566	\$1622	N/A	\$128
Z30S2XL	30 x 16 x 30	124	10.5	\$1405	\$1451	N/A	\$114

Two box drawers on left, one file drawer on right accommodates letter filing side-to-side and one lateral file drawer on bottom (see filing orientation on page 120). Right lock secures two box and one file drawer, the left lock secures the lateral file. One pencil tray. Front-to-back and side-to-side letter/legal filing capability in lateral drawer, file bars included. Shipped assembled in 1 carton.

- Lateral file drawer construction is for accommodating hanging files NOT for stacking materials on the drawer bottom.
- Top file drawer supports hanging folders only, does NOT accept hanging folders with plastic tabs.

Z36L2XR	36 x 24 x 30	187	18.5	\$1944	\$2009	N/A	\$171
Z30L2XR	30 x 24 x 30	166	15.5	\$1772	\$1833	N/A	\$144
Z36M2XR	36 x 20 x 30	177	15.5	\$1823	\$1885	N/A	\$171
Z30M2XR	30 x 20 x 30	152	13.25	\$1683	\$1735	N/A	\$144
Z36S2XR	36 x 16 x 30	145	12.5	\$1566	\$1622	N/A	\$128
Z30S2XR	30 x 16 x 30	124	10.5	\$1405	\$1451	N/A	\$114

Two box drawers on right, one file drawer on left accommodates letter filing side-to-side and one lateral file drawer on bottom (see filing orientation on page 120). Left lock secures two box and one file drawer, the right lock secures the lateral file. One pencil tray. Front-to-back and side-to-side letter/legal filing capability. Side-to-side file bars included. Shipped assembled in 1 carton.

- Lateral file drawer construction is for accommodating hanging files NOT for stacking materials on the drawer bottom.
- Top file drawer supports hanging folders only, does NOT accept hanging folders with plastic tabs.

Z36L2XNL	36 x 24 x 30	176	18.5	\$1686	\$1755	N/A	\$171
Z30L2XNL	30 x 24 x 30	155	15.5	\$1546	\$1608	N/A	\$144
Z36M2XNL	36 x 20 x 30	158	15.5	\$1574	\$1636	N/A	\$171
Z30M2XNL	30 x 20 x 30	139	13.25	\$1456	\$1508	N/A	\$144
Z36S2XNL	36 x 16 x 30	128	12.5	\$1414	\$1466	N/A	\$128
Z30S2XNL	30 x 16 x 30	114	10.5	\$1280	\$1314	N/A	\$114

Two box drawers on left, open shelf on right and one lateral file drawer on bottom. Lock secures all drawers. One pencil tray. Front-to-back and side-to-side letter/legal filing capability. Side-to-side file bars included. Shipped assembled in 1 carton.

- Lateral file drawer construction is for accommodating hanging files NOT for stacking materials on the drawer bottom.

Z36L2XNR	36 x 24 x 30	176	18.5	\$1686	\$1755	N/A	\$171
Z30L2XNR	30 x 24 x 30	155	15.5	\$1546	\$1608	N/A	\$144
Z36M2XNR	36 x 20 x 30	158	15.5	\$1574	\$1636	N/A	\$171
Z30M2XNR	30 x 20 x 30	139	13.25	\$1456	\$1508	N/A	\$144
Z36S2XNR	36 x 16 x 30	128	12.5	\$1414	\$1466	N/A	\$128
Z30S2XNR	30 x 16 x 30	114	10.5	\$1280	\$1314	N/A	\$114

Two box drawers on right, open shelf on left and one lateral file drawer on bottom. Lock secures all drawers. One pencil tray. Front-to-back and side-to-side letter/legal filing capability. Side-to-side file bars included. Shipped assembled in 1 carton.

- Lateral file drawer construction is for accommodating hanging files NOT for stacking materials on the drawer bottom.

Required specifications

Top finish
Top thickness/edge detail
Base finish
Handles

Optional specifications

HP laminate
Key #
Box drawer - no upcharge
Collator - position & finish*

STORAGE MODULES - 41.3" / 41.8" HIGH **MODEL #** **DIMENSIONS** **WT/LB.** **CUBIC FT.** **1" TOP** **1.5" TOP** **GLAZE ADD** **HP ADD**

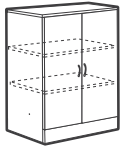

Glazed door option

Storage Cabinet with Doors

	W x D x H (1.5" TOP)							
Z36L4SH	36 x 24 x 41.8		186	25	\$1505	\$1574	\$969	\$171
Z30L4SH	30 x 24 x 41.8		162	21.25	\$1376	\$1438	\$846	\$144
Z36M4SH	36 x 20 x 41.8		166	21.25	\$1405	\$1467	\$969	\$171
Z30M4SH	30 x 20 x 41.8		144	18	\$1271	\$1323	\$846	\$144
Z36S4SH	36 x 16 x 41.8		143	17.5	\$1272	\$1333	\$969	\$128
Z30S4SH	30 x 16 x 41.8		122	14.5	\$1140	\$1182	\$846	\$69

Laminate doors are standard. **Includes two 3-position fixed/height adjustable shelves.** Standard with lock. Shipped assembled in 1 carton.

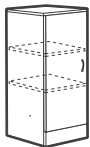

Glazed door option

Storage Cabinet with Door - LEFT

Z21L4SHL	21 x 24 x 41.8		124	15.25	\$1114	\$1164	\$529	\$114
Z18L4SHL	18 x 24 x 41.8		112	13.25	\$1049	\$1091	\$477	\$87
Z16L4SHL	16 x 24 x 41.8		105	12	\$987	\$1029	\$471	\$87
Z15L4SHL	15 x 24 x 41.8		101	11.25	\$943	\$977	\$417	\$87
Z12L4SHL	12 x 24 x 41.8		89	9.25	\$873	\$903	\$377	\$57
Z21M4SHL	21 x 20 x 41.8		117	13	\$1004	\$1046	\$529	\$114
Z18M4SHL	18 x 20 x 41.8		99	11.25	\$950	\$985	\$477	\$87
Z16M4SHL	16 x 20 x 41.8		91	10.25	\$891	\$926	\$471	\$69
Z15M4SHL	15 x 20 x 41.8		88	9.5	\$851	\$881	\$417	\$69
Z12M4SHL	12 x 20 x 41.8		79	8	\$793	\$818	\$377	\$57
Z21S4SHL	21 x 16 x 41.8		95	10.5	\$894	\$927	\$529	\$87
Z18S4SHL	18 x 16 x 41.8		84	9.5	\$860	\$894	\$477	\$69
Z16S4SHL	16 x 16 x 41.8		77	8.5	\$805	\$839	\$471	\$69
Z15S4SHL	15 x 16 x 41.8		74	8	\$763	\$792	\$417	\$69
Z12S4SHL	12 x 16 x 41.8		65	6.5	\$705	\$730	\$377	\$57

Laminate doors are standard. **Includes two 3-position fixed/height adjustable shelves.** Standard with lock. Ganging hardware included with all units 24" wide or less and 41"H or taller. Shipped assembled in 1 carton.

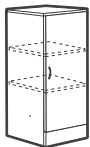

Glazed door option

Storage Cabinet with Door - RIGHT

Z21L4SHR	21 x 24 x 41.8		124	15.25	\$1114	\$1164	\$529	\$114
Z18L4SHR	18 x 24 x 41.8		112	13.25	\$1049	\$1091	\$477	\$87
Z16L4SHR	16 x 24 x 41.8		105	12	\$987	\$1029	\$471	\$87
Z15L4SHR	15 x 24 x 41.8		101	11.25	\$943	\$977	\$417	\$87
Z12L4SHR	12 x 24 x 41.8		89	9.25	\$873	\$903	\$377	\$57
Z21M4SHR	21 x 20 x 41.8		117	13	\$1004	\$1046	\$529	\$114
Z18M4SHR	18 x 20 x 41.8		99	11.25	\$950	\$985	\$477	\$87
Z16M4SHR	16 x 20 x 41.8		91	10.25	\$891	\$926	\$471	\$69
Z15M4SHR	15 x 20 x 41.8		88	9.5	\$851	\$881	\$417	\$69
Z12M4SHR	12 x 20 x 41.8		79	8	\$793	\$818	\$377	\$57
Z21S4SHR	21 x 16 x 41.8		95	10.5	\$894	\$927	\$529	\$87
Z18S4SHR	18 x 16 x 41.8		84	9.5	\$860	\$894	\$477	\$69
Z16S4SHR	16 x 16 x 41.8		77	8.5	\$805	\$839	\$471	\$69
Z15S4SHR	15 x 16 x 41.8		74	8	\$763	\$792	\$417	\$69
Z12S4SHR	12 x 16 x 41.8		65	6.5	\$705	\$730	\$377	\$57

Laminate doors are standard. **Includes two 3-position fixed/height adjustable shelves.** Standard with lock. Ganging hardware included with all units 24" wide or less and 41"H or taller. Shipped assembled in 1 carton.

Required specifications

- Top finish
- Top thickness/edge detail
- Base finish
- Handles

Optional specifications

- HP laminate
- Key #
- Glazed door

STORAGE MODULES - 41.3" / 41.8" HIGH

MODEL #	DIMENSIONS	WT/LB.	CUBIC FT.	1" TOP	1.5" TOP	GLAZE ADD	HP ADD
---------	------------	--------	-----------	--------	----------	-----------	--------

W x D x H (1.5" TOP)

Z36L4SHN	36 x 24 x 41.8	163	25	\$1181	\$1250	N/A	\$171
Z30L4SHN	30 x 24 x 41.8	142	21.25	\$1090	\$1152	N/A	\$144
Z21L4SHN	21 x 24 x 41.8	112	15.25	\$934	\$984	N/A	\$114
Z18L4SHN	18 x 24 x 41.8	101	13.25	\$884	\$926	N/A	\$87
Z16L4SHN	16 x 24 x 41.8	95	12	\$822	\$864	N/A	\$87
Z15L4SHN	15 x 24 x 41.8	92	11.25	\$798	\$832	N/A	\$87
Z12L4SHN	12 x 24 x 41.8	81	9.25	\$737	\$767	N/A	\$57
Z36M4SHN	36 x 20 x 41.8	142	21.25	\$1082	\$1144	N/A	\$171
Z30M4SHN	30 x 20 x 41.8	124	18	\$983	\$1035	N/A	\$144
Z21M4SHN	21 x 20 x 41.8	102	13	\$827	\$869	N/A	\$114
Z18M4SHN	18 x 20 x 41.8	87	11.25	\$784	\$819	N/A	\$87
Z16M4SHN	16 x 20 x 41.8	81	10.25	\$727	\$762	N/A	\$87
Z15M4SHN	15 x 20 x 41.8	78	9.5	\$706	\$736	N/A	\$87
Z12M4SHN	12 x 20 x 41.8	70	8	\$656	\$681	N/A	\$57
Z36S4SHN	36 x 16 x 41.8	120	17.5	\$949	\$1010	N/A	\$128
Z30S4SHN	30 x 16 x 41.8	112	14.5	\$851	\$893	N/A	\$114
Z21S4SHN	21 x 16 x 41.8	81	10.5	\$716	\$749	N/A	\$87
Z18S4SHN	18 x 16 x 41.8	73	9.5	\$695	\$729	N/A	\$69
Z16S4SHN	16 x 16 x 41.8	67	8.5	\$642	\$676	N/A	\$69
Z15S4SHN	15 x 16 x 41.8	65	8	\$615	\$644	N/A	\$69
Z12S4SHN	12 x 16 x 41.8	58	6.5	\$569	\$594	N/A	\$57



* Accepts collator 11" high
** Accepts collator 11.3" high

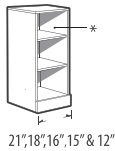
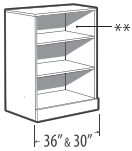

Open Storage Cabinet**

Includes two 3-position fixed/height adjustable shelves. Ganging hardware included with all units 24" wide or less and 41"H or taller. Shipped assembled in 1 carton.



* Accepts collator 11" high
** Accepts collator 11.3" high

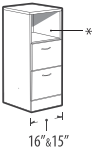
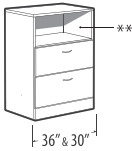

Two File Module with Open Shelf*

Z36L4EN	36 x 24 x 41.8	200	25	\$1916	\$1985	N/A	\$171
Z30L4EN	30 x 24 x 41.8	179	21.25	\$1824	\$1886	N/A	\$144
Z16L4EN	16 x 24 x 41.8	117	12	\$1148	\$1190	N/A	\$87
Z15L4EN	15 x 24 x 41.8	112	11.25	\$1114	\$1148	N/A	\$87
Z36M4EN	36 x 20 x 41.8	182	21.25	\$1822	\$1884	N/A	\$171
Z30M4EN	30 x 20 x 41.8	163	18	\$1730	\$1782	N/A	\$144
Z16M4EN	16 x 20 x 41.8	105	10.25	\$1055	\$1090	N/A	\$87
Z15M4EN	15 x 20 x 41.8	101	9.5	\$1025	\$1055	N/A	\$87
Z36S4EN	36 x 16 x 41.8	153	17.5	\$1674	\$1735	N/A	\$128
Z30S4EN	30 x 16 x 41.8	131	14.5	\$1520	\$1562	N/A	\$114
Z16S4EN	16 x 16 x 41.8	85	8.5	\$969	\$1003	N/A	\$69
Z15S4EN	15 x 16 x 41.8	83	8	\$942	\$971	N/A	\$69

Open fixed shelf and two file drawers on bottom. Lock secures all drawers. 36" and 30" wide models have front-to-back and side-to-side letter/legal filing capability. Side-to-side file bars included. Ganging hardware included with all units 24" wide or less and 41"H or taller. Shipped assembled in 1 carton.

- Lateral file drawer construction is for accommodating hanging files NOT for stacking materials on the drawer bottom.

Required specifications

Top finish
Top thickness/edge detail
Base finish
Handles*

Optional specifications

HP laminate
Glazed door*
Key #*
Box drawer - no upcharge*
Collator - position & finish**

STORAGE MODULES - 41.3" / 41.8" HIGH **MODEL #** **DIMENSIONS** **WT/LB.** **CUBIC FT.** **1" TOP** **1.5" TOP** **GLAZE ADD** **HP ADD**

W x D x H (1.5" TOP)

Z36L43F	36 x 24 x 41.8	210	25	\$2251	\$2320	N/A	\$171
Z30L43F	30 x 24 x 41.8	190	21.25	\$2137	\$2199	N/A	\$144
Z16L43F	16 x 24 x 41.8	126	12	\$1320	\$1362	N/A	\$69
Z15L43F	15 x 24 x 41.8	121	11.25	\$1286	\$1320	N/A	\$69
Z36M43F	36 x 20 x 41.8	198	21.25	\$2191	\$2253	N/A	\$171
Z30M43F	30 x 20 x 41.8	177	18	\$2048	\$2100	N/A	\$144
Z16M43F	16 x 20 x 41.8	114	10.25	\$1231	\$1266	N/A	\$69
Z15M43F	15 x 20 x 41.8	110	9.5	\$1201	\$1231	N/A	\$69
Z36S43F	36 x 16 x 41.8	166	17.5	\$1977	\$2038	N/A	\$128
Z30S43F	30 x 16 x 41.8	148	14.5	\$1821	\$1863	N/A	\$114
Z16S43F	16 x 16 x 41.8	95	8.5	\$1164	\$1198	N/A	\$69
Z15S43F	15 x 16 x 41.8	91	8	\$1125	\$1154	N/A	\$69



Three File Module

Three file drawers. Lock secures all drawers. 36" and 30" wide models have front-to-back and side-to-side letter/legal filing capability. Side-to-side file bars included. Ganging hardware included with all units 24" wide or less and 41"H or taller. Shipped assembled in 1 carton.

- Lateral file drawer construction is for accommodating hanging files NOT for stacking materials on the drawer bottom.



Three File Module

Z36L4S3F	36 x 24 x 41.8	233	25	\$2662	\$2731	N/A	\$171
Z36M4S3F	36 x 20 x 41.8	221	21.25	\$2574	\$2637	N/A	\$144

Three lateral file drawers with steel drawer interior. Steel drawer construction includes metal sides and masonite bottoms. Lock secures all drawers. Front-to-back and side-to-side letter/legal filing capability. Side-to-side file bars included. Shipped assembled in 1 carton.

- Front-to-back filing bars available separately. Order **FBB** bars. See Metal Filing + Storage price list page 14.
- Lateral file drawer construction is for accommodating hanging files NOT for stacking materials on the drawer bottom.

Required specifications

Top finish
Top thickness/edge detail
Base finish
Handles

Optional specifications

HP laminate
Key #

STORAGE MODULES - 53" / 53.5" HIGH

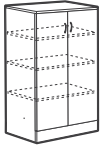

Glazed door option

Storage Cabinet with Doors**

MODEL #	DIMENSIONS W x D x H (1.5" TOP)	WT/LB.	CUBIC FT.	1" TOP	1.5" TOP	GLAZE ADD	HP ADD
Z36L5SH	36 x 24 x 53.5	230	31.25	\$1815	\$1884	\$1188	\$171
Z30L5SH	30 x 24 x 53.5	200	27	\$1649	\$1711	\$1034	\$144
Z36M5SH	36 x 20 x 53.5	204	27	\$1689	\$1751	\$1188	\$171
Z30M5SH	30 x 20 x 53.5	185	22.75	\$1482	\$1534	\$1034	\$144
Z36S5SH	36 x 16 x 53.5	175	21.75	\$1584	\$1645	\$1188	\$128
Z30S5SH	30 x 16 x 53.5	152	18.5	\$1384	\$1426	\$1034	\$114

Laminate doors are standard. **Includes three 3-position fixed/height adjustable shelves.** Standard with lock. Shipped assembled in 1 carton.

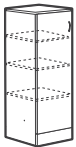

Glazed door option

Storage Cabinet with Door - LEFT**

Z21L5SHL	21 x 24 x 53.5	154	19.5	\$1304	\$1354	\$657	\$114
Z18L5SHL	18 x 24 x 53.5	140	17	\$1246	\$1288	\$589	\$87
Z16L5SHL	16 x 24 x 53.5	130	15.5	\$1175	\$1217	\$583	\$87
Z15L5SHL	15 x 24 x 53.5	125	14.25	\$1121	\$1155	\$512	\$87
Z12L5SHL	12 x 24 x 53.5	110	11.75	\$1046	\$1076	\$463	\$57
Z21M5SHL	21 x 20 x 53.5	143	16.5	\$1195	\$1237	\$657	\$114
Z18M5SHL	18 x 20 x 53.5	123	14.25	\$1130	\$1165	\$589	\$87
Z16M5SHL	16 x 20 x 53.5	113	13	\$1069	\$1104	\$583	\$87
Z15M5SHL	15 x 20 x 53.5	109	12.25	\$1015	\$1045	\$512	\$87
Z12M5SHL	12 x 20 x 53.5	97	10	\$942	\$967	\$463	\$57
Z21S5SHL	21 x 16 x 53.5	117	13.25	\$1110	\$1143	\$657	\$87
Z18S5SHL	18 x 16 x 53.5	104	11.5	\$1055	\$1089	\$589	\$69
Z16S5SHL	16 x 16 x 53.5	97	10.5	\$999	\$1033	\$583	\$69
Z15S5SHL	15 x 16 x 53.5	91	9.75	\$958	\$987	\$512	\$69
Z12S5SHL	12 x 16 x 53.5	80	8.25	\$884	\$909	\$463	\$57

Laminate doors are standard. **Includes three 3-position fixed/height adjustable shelves.** Standard with lock. Ganging hardware included with all units 24" wide or less and 41"H or taller. Shipped assembled in 1 carton.

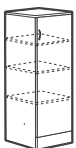

Glazed door option

Storage Cabinet with Door - RIGHT**

Z21L5SHR	21 x 24 x 53.5	154	19.5	\$1304	\$1354	\$657	\$114
Z18L5SHR	18 x 24 x 53.5	140	17	\$1246	\$1288	\$589	\$87
Z16L5SHR	16 x 24 x 53.5	130	15.5	\$1175	\$1217	\$583	\$87
Z15L5SHR	15 x 24 x 53.5	125	14.25	\$1121	\$1155	\$512	\$87
Z12L5SHR	12 x 24 x 53.5	110	11.75	\$1046	\$1076	\$463	\$57
Z21M5SHR	21 x 20 x 53.5	143	16.5	\$1195	\$1237	\$657	\$114
Z18M5SHR	18 x 20 x 53.5	123	14.25	\$1130	\$1165	\$589	\$87
Z16M5SHR	16 x 20 x 53.5	113	13	\$1069	\$1104	\$583	\$87
Z15M5SHR	15 x 20 x 53.5	109	12.25	\$1015	\$1045	\$512	\$87
Z12M5SHR	12 x 20 x 53.5	97	10	\$942	\$967	\$463	\$57
Z21S5SHR	21 x 16 x 53.5	117	13.25	\$1110	\$1143	\$657	\$87
Z18S5SHR	18 x 16 x 53.5	104	11.5	\$1055	\$1089	\$589	\$69
Z16S5SHR	16 x 16 x 53.5	97	10.5	\$999	\$1033	\$583	\$69
Z15S5SHR	15 x 16 x 53.5	91	9.75	\$958	\$987	\$512	\$69
Z12S5SHR	12 x 16 x 53.5	80	8.25	\$884	\$909	\$463	\$57

Laminate doors are standard. **Includes three 3-position fixed/height adjustable shelves.** Standard with lock. Ganging hardware included with all units 24" wide or less and 41"H or taller. Shipped assembled in 1 carton.

Required specifications

Top finish
Top thickness/edge detail
Base finish
Handles

Optional specifications

HP laminate
Key #
Glazed door

STORAGE MODULES - 53" / 53.5" HIGH

MODEL #	DIMENSIONS	WT/LB.	CUBIC FT.	1" TOP	1.5" TOP	GLAZE ADD	HP ADD
W x D x H (1.5" TOP)							
Z36L5SHN	36 x 24 x 53.5	198	31.25	\$1412	\$1481	N/A	\$171
Z30L5SHN	30 x 24 x 53.5	173	27	\$1318	\$1380	N/A	\$144
Z21L5SHN	21 x 24 x 53.5	136	19.5	\$1082	\$1132	N/A	\$114
Z18L5SHN	18 x 24 x 53.5	124	17	\$1038	\$1080	N/A	\$87
Z16L5SHN	16 x 24 x 53.5	116	15.5	\$972	\$1014	N/A	\$87
Z15L5SHN	15 x 24 x 53.5	112	14.25	\$938	\$972	N/A	\$87
Z12L5SHN	12 x 24 x 53.5	100	11.75	\$877	\$907	N/A	\$57
Z36M5SHN	36 x 20 x 53.5	172	27	\$1285	\$1347	N/A	\$171
Z30M5SHN	30 x 20 x 53.5	158	22.75	\$1148	\$1200	N/A	\$144
Z21M5SHN	21 x 20 x 53.5	124	16.5	\$969	\$1011	N/A	\$114
Z18M5SHN	18 x 20 x 53.5	107	14.25	\$926	\$961	N/A	\$87
Z16M5SHN	16 x 20 x 53.5	99	13	\$866	\$901	N/A	\$87
Z15M5SHN	15 x 20 x 53.5	96	12.25	\$833	\$863	N/A	\$87
Z12M5SHN	12 x 20 x 53.5	85	10	\$773	\$798	N/A	\$57
Z36S5SHN	36 x 16 x 53.5	145	21.75	\$1118	\$1179	N/A	\$128
Z30S5SHN	30 x 16 x 53.5	127	18.5	\$1007	\$1049	N/A	\$114
Z21S5SHN	21 x 16 x 53.5	98	13.25	\$848	\$881	N/A	\$87
Z18S5SHN	18 x 16 x 53.5	89	11.5	\$815	\$849	N/A	\$69
Z16S5SHN	16 x 16 x 53.5	83	10.5	\$762	\$796	N/A	\$69
Z15S5SHN	15 x 16 x 53.5	78	9.75	\$750	\$779	N/A	\$69
Z12S5SHN	12 x 16 x 53.5	70	8.25	\$692	\$717	N/A	\$57



* Accepts collator 11" high
** Accepts collator 11.3" high

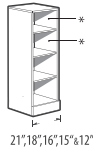
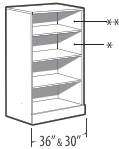

Open Storage Cabinet*

Includes three 3-position fixed/height adjustable shelves. Ganging hardware included with all units 24" wide or less and 41"H or taller. Shipped assembled in 1 carton.

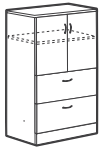

Glazed door option

Two File Module with Doors**

Z36L5E	36 x 24 x 53.5	251	31.25	\$2464	\$2533	\$723	\$171
Z30L5E	30 x 24 x 53.5	223	27	\$2298	\$2360	\$636	\$144
Z36M5E	36 x 20 x 53.5	230	27	\$2351	\$2413	\$754	\$171
Z30M5E	30 x 20 x 53.5	202	22.75	\$2137	\$2189	\$666	\$144
Z36S5E	36 x 16 x 53.5	193	21.75	\$2074	\$2135	\$754	\$128
Z30S5E	30 x 16 x 53.5	170	18.5	\$1904	\$1946	\$666	\$114

Two lateral file drawers on bottom. Laminate doors are standard. **Includes one 3-position fixed/height adjustable shelf.** Upper lock secures storage compartment. Lower lock secures two file drawers. Front-to-back and side-to-side letter/legal filing capability. Side-to-side file bars included. Shipped assembled in 1 carton.

- Lateral file drawer construction is for accommodating hanging files NOT for stacking materials on the drawer bottom.

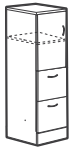

Glazed door option

Two File Module with Door - LEFT**

Z16L5EL	16 x 24 x 53.5	145	15.5	\$1430	\$1472	\$366	\$87
Z15L5EL	15 x 24 x 53.5	140	14.25	\$1376	\$1410	\$326	\$87
Z16M5EL	16 x 20 x 53.5	130	13	\$1329	\$1364	\$365	\$87
Z15M5EL	15 x 20 x 53.5	126	12.25	\$1275	\$1305	\$326	\$87
Z16S5EL	16 x 16 x 53.5	109	10.5	\$1218	\$1252	\$365	\$69
Z15S5EL	15 x 16 x 53.5	105	9.75	\$1197	\$1226	\$326	\$69

Two file drawers on bottom. Laminate door is standard. **Includes one 3-position fixed/height adjustable shelf.** Upper lock secures storage compartment. Lower lock secures two file drawers. Ganging hardware included with all units 24" wide or less and 41"H or taller. Shipped assembled in 1 carton.

Required specifications

- Top finish
- Top thickness/edge detail
- Base finish
- Handles**

Optional specifications

- HP laminate
- Glazed door**
- Key #**
- Box drawer - no upcharge**
- Collator - position & finish*

STORAGE MODULES - 53" / 53.5" HIGH

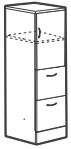

Glazed door option

Two File Module with Door - RIGHT**

MODEL #	DIMENSIONS W x D x H (1.5" TOP)	WT/LB.	CUBIC FT.	1" TOP	1.5" TOP	GLAZE ADD	HP ADD
Z16L5ER	16 x 24 x 53.5	145	15.5	\$1430	\$1472	\$366	\$87
Z15L5ER	15 x 24 x 53.5	140	14.25	\$1376	\$1410	\$326	\$87
Z16M5ER	16 x 20 x 53.5	130	13	\$1329	\$1364	\$365	\$87
Z15M5ER	15 x 20 x 53.5	126	12.25	\$1275	\$1305	\$326	\$87
Z16S5ER	16 x 16 x 53.5	109	10.5	\$1218	\$1252	\$365	\$69
Z15S5ER	15 x 16 x 53.5	105	9.75	\$1197	\$1226	\$326	\$69

Two file drawers on bottom. Laminate door is standard. **Includes one 3-position fixed/height adjustable shelf.** Upper lock secures storage compartment. Lower lock secures two file drawers. Ganging hardware included with all units 24" wide or less and 41"H or taller. Shipped assembled in 1 carton.



* Accepts collator 11" high
** Accepts collator 11.3" high

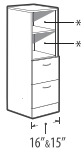
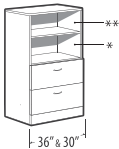

Two File Module with Open Shelves*

Z36L5EN	36 x 24 x 53.5	235	31.25	\$2197	\$2266	N/A	\$171
Z30L5EN	30 x 24 x 53.5	210	27	\$2056	\$2118	N/A	\$144
Z16L5EN	16 x 24 x 53.5	138	15.5	\$1291	\$1333	N/A	\$87
Z15L5EN	15 x 24 x 53.5	134	14.25	\$1252	\$1286	N/A	\$87
Z36M5EN	36 x 20 x 53.5	213	27	\$2086	\$2148	N/A	\$171
Z30M5EN	30 x 20 x 53.5	188	22.75	\$1898	\$1950	N/A	\$144
Z16M5EN	16 x 20 x 53.5	123	13	\$1194	\$1229	N/A	\$87
Z15M5EN	15 x 20 x 53.5	119	12.25	\$1155	\$1185	N/A	\$87
Z36S5EN	36 x 16 x 53.5	179	21.75	\$1808	\$1869	N/A	\$128
Z30S5EN	30 x 16 x 53.5	158	18.5	\$1668	\$1710	N/A	\$114
Z16S5EN	16 x 16 x 53.5	102	10.5	\$1082	\$1116	N/A	\$69
Z15S5EN	15 x 16 x 53.5	98	9.75	\$1073	\$1102	N/A	\$69

Two open shelves and two file drawers on bottom. **Includes one 3-position fixed/height adjustable shelf.** Lock secures all drawers. 36" and 30" wide models have front-to-back and side-to-side letter/legal filing capability. Side-to-side file bars included. Ganging hardware included with all units 24" wide or less and 41"H or taller. Shipped assembled in 1 carton.

- Lateral file drawer construction is for accommodating hanging files NOT for stacking materials on the drawer bottoms.



Four File Module

Z36L54F	36 x 24 x 53.5	256	31.25	\$2776	\$2845	N/A	\$171
Z30L54F	30 x 24 x 53.5	234	27	\$2662	\$2724	N/A	\$144
Z16L54F	16 x 24 x 53.5	155	15.5	\$1594	\$1636	N/A	\$87
Z15L54F	15 x 24 x 53.5	148	14.25	\$1540	\$1574	N/A	\$87
Z36M54F	36 x 20 x 53.5	239	27	\$2694	\$2756	N/A	\$171
Z30M54F	30 x 20 x 53.5	218	22.75	\$2528	\$2580	N/A	\$144
Z16M54F	16 x 20 x 53.5	142	13	\$1502	\$1537	N/A	\$87
Z15M54F	15 x 20 x 53.5	137	12.25	\$1449	\$1479	N/A	\$87
Z36S54F	36 x 16 x 53.5	205	21.75	\$2408	\$2469	N/A	\$128
Z30S54F	30 x 16 x 53.5	180	18.5	\$2192	\$2234	N/A	\$114
Z16S54F	16 x 16 x 53.5	122	10.5	\$1477	\$1511	N/A	\$69
Z15S54F	15 x 16 x 53.5	116	9.75	\$1421	\$1450	N/A	\$69

Four file drawers. Lock secures all drawers. 36" and 30" wide models have front-to-back and side-to-side letter/legal filing capability. Side-to-side file bars included. Ganging hardware included with all units 24" wide or less and 41"H or taller. Shipped assembled in 1 carton.

- Lateral file drawer construction is for accommodating hanging files NOT for stacking materials on the drawer bottoms.



Four File Module

Z36L5S4F	36 x 24 x 53.5	286	31.25	\$3322	\$3391	N/A	\$171
Z36M5S4F	36 x 20 x 53.5	269	27	\$3223	\$3286	N/A	\$171

Four file drawers with **steel drawer interior.** Steel drawer construction includes metal sides and masonite bottoms. Lock secures all drawers. Front-to-back and side-to-side letter/legal filing capability. Side-to-side file bars included. Shipped assembled in 1 carton.

- Front-to-back filing bars available separately. Order **FBB** bars. See Metal Filing + Storage price list page 14.
- Lateral file drawer construction is for accommodating hanging files NOT for stacking materials on the drawer bottoms.

Required specifications

Top finish
Top thickness/edge detail
Base finish
Handles

Optional specifications

HP laminate
Key #
Box drawer - no upcharge
Collator - position & finish*
Glazed door**

STORAGE MODULES - 65.5" / 66" HIGH

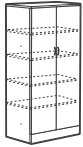

Glazed door option

Storage Cabinet with Doors

MODEL #	DIMENSIONS W x D x H (1.5" TOP)	WT/LB.	CUBIC FT.	1" TOP	1.5" TOP	GLAZE ADD	HP ADD
Z36L6SH	36 x 24 x 66	273	39	\$2149	\$2218	\$1409	N/A
Z30L6SH	30 x 24 x 66	238	32.75	\$1880	\$1942	\$1219	N/A
Z36M6SH	36 x 20 x 66	247	33.25	\$1992	\$2054	\$1409	N/A
Z30M6SH	30 x 20 x 66	212	27.75	\$1737	\$1789	\$1219	N/A
Z36S6SH	36 x 16 x 66	210	26.5	\$1805	\$1866	\$1409	N/A
Z30S6SH	30 x 16 x 66	184	22.5	\$1552	\$1594	\$1219	N/A

Laminate doors are standard. **Includes four 3-position fixed/height adjustable shelves.** Standard with lock. Shipped assembled in 1 carton.



Glazed door option

Storage Cabinet with Door - LEFT

Z21L6SHL	21 x 24 x 66	186	23.5	\$1540	\$1590	\$780	N/A
Z18L6SHL	18 x 24 x 66	168	20.5	\$1438	\$1480	\$699	N/A
Z16L6SHL	16 x 24 x 66	156	18.75	\$1352	\$1394	\$693	N/A
Z15L6SHL	15 x 24 x 66	149	17.5	\$1313	\$1347	\$603	N/A
Z12L6SHL	12 x 24 x 66	133	14.5	\$1194	\$1224	\$543	N/A
Z21M6SHL	21 x 20 x 66	170	20	\$1377	\$1419	\$780	N/A
Z18M6SHL	18 x 20 x 66	148	17.25	\$1313	\$1348	\$699	N/A
Z16M6SHL	16 x 20 x 66	138	15.75	\$1235	\$1270	\$693	N/A
Z15M6SHL	15 x 20 x 66	133	14.75	\$1176	\$1206	\$603	N/A
Z12M6SHL	12 x 20 x 66	117	12.25	\$1091	\$1116	\$543	N/A
Z21S6SHL	21 x 16 x 66	141	16	\$1271	\$1304	\$780	N/A
Z18S6SHL	18 x 16 x 66	126	14	\$1174	\$1208	\$699	N/A
Z16S6SHL	16 x 16 x 66	117	13	\$1103	\$1137	\$693	N/A
Z15S6SHL	15 x 16 x 66	111	12	\$1049	\$1078	\$603	N/A
Z12S6SHL	12 x 16 x 66	97	10	\$963	\$988	\$543	N/A

Laminate doors are standard. **Includes four 3-position fixed/height adjustable shelves.** Standard with lock. Ganging hardware included with all units 24" wide or less and 41"H or taller. Shipped assembled in 1 carton.

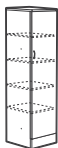

Glazed door option

Storage Cabinet with Door - RIGHT

Z21L6SHR	21 x 24 x 66	186	23.5	\$1540	\$1590	\$780	N/A
Z18L6SHR	18 x 24 x 66	168	20.5	\$1438	\$1480	\$699	N/A
Z16L6SHR	16 x 24 x 66	156	18.75	\$1352	\$1394	\$693	N/A
Z15L6SHR	15 x 24 x 66	149	17.5	\$1313	\$1347	\$603	N/A
Z12L6SHR	12 x 24 x 66	133	14.5	\$1194	\$1224	\$543	N/A
Z21M6SHR	21 x 20 x 66	170	20	\$1377	\$1419	\$780	N/A
Z18M6SHR	18 x 20 x 66	148	17.25	\$1313	\$1348	\$699	N/A
Z16M6SHR	16 x 20 x 66	138	15.75	\$1235	\$1270	\$693	N/A
Z15M6SHR	15 x 20 x 66	133	14.75	\$1176	\$1206	\$603	N/A
Z12M6SHR	12 x 20 x 66	117	12.25	\$1091	\$1116	\$543	N/A
Z21S6SHR	21 x 16 x 66	141	16	\$1271	\$1304	\$780	N/A
Z18S6SHR	18 x 16 x 66	126	14	\$1174	\$1208	\$699	N/A
Z16S6SHR	16 x 16 x 66	117	13	\$1103	\$1137	\$693	N/A
Z15S6SHR	15 x 16 x 66	111	12	\$1049	\$1078	\$603	N/A
Z12S6SHR	12 x 16 x 66	97	10	\$963	\$988	\$543	N/A

Laminate doors are standard. **Includes four 3-position fixed/height adjustable shelves.** Standard with lock. Ganging hardware included with all units 24" wide or less and 41"H or taller. Shipped assembled in 1 carton.

Required specifications

- Top finish
- Top thickness/edge detail
- Base finish
- Handles

Optional specifications

- HP laminate
- Key #

STORAGE MODULES - 53" / 53.5" HIGH

MODEL #	DIMENSIONS	WT/LB.	CUBIC FT.	1" TOP	1.5" TOP	GLAZE ADD	HP ADD
W x D x H (1.5" TOP)							
Z36L6SHN	36 x 24 x 66	234	39	\$1665	\$1734	N/A	N/A
Z30L6SHN	30 x 24 x 66	205	32.75	\$1474	\$1536	N/A	N/A
Z21L6SHN	21 x 24 x 66	163	23.5	\$1280	\$1330	N/A	N/A
Z18L6SHN	18 x 24 x 66	149	20.5	\$1202	\$1244	N/A	N/A
Z16L6SHN	16 x 24 x 66	140	18.75	\$1118	\$1160	N/A	N/A
Z15L6SHN	15 x 24 x 66	134	17.5	\$1106	\$1140	N/A	N/A
Z12L6SHN	12 x 24 x 66	120	14.5	\$1003	\$1033	N/A	N/A
Z36M6SHN	36 x 20 x 66	206	33.25	\$1506	\$1568	N/A	N/A
Z30M6SHN	30 x 20 x 66	179	27.75	\$1333	\$1385	N/A	N/A
Z21M6SHN	21 x 20 x 66	146	20	\$1118	\$1160	N/A	N/A
Z18M6SHN	18 x 20 x 66	128	17.25	\$1080	\$1115	N/A	N/A
Z16M6SHN	16 x 20 x 66	120	15.75	\$1000	\$1035	N/A	N/A
Z15M6SHN	15 x 20 x 66	117	14.75	\$971	\$1001	N/A	N/A
Z12M6SHN	12 x 20 x 66	102	12.25	\$902	\$927	N/A	N/A
Z36S6SHN	36 x 16 x 66	173	26.5	\$1318	\$1379	N/A	N/A
Z30S6SHN	30 x 16 x 66	152	22.5	\$1146	\$1188	N/A	N/A
Z21S6SHN	21 x 16 x 66	118	16	\$1007	\$1040	N/A	N/A
Z18S6SHN	18 x 16 x 66	106	14	\$938	\$972	N/A	N/A
Z16S6SHN	16 x 16 x 66	99	13	\$872	\$906	N/A	N/A
Z15S6SHN	15 x 16 x 66	95	12	\$843	\$872	N/A	N/A
Z12S6SHN	12 x 16 x 66	84	10	\$773	\$798	N/A	N/A



* Accepts collator 11" high
** Accepts collator 11.3" high

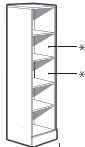
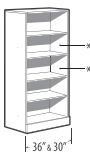

Open Storage Cabinet*

Includes four 3-position fixed/height adjustable shelves. Ganging hardware included with all units 24" wide or less and 41"H or taller. Ganging hardware included with all units 24" wide or less and 41"H or taller. Shipped assembled in 1 carton.

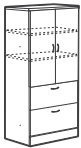

Glazed door option

Two File Module with Doors**

Two lateral file drawers on bottom. Laminate doors are standard. Includes two 3-position fixed/height adjustable shelves. Upper lock secures storage compartment. Lower lock secures two file drawers. Front-to-back and side-to-side letter/legal filing capability. Side-to-side file bars included. Shipped assembled in 1 carton.

- Lateral file drawer construction is for accommodating hanging files NOT for stacking materials on the drawer bottom.

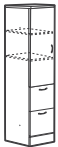

Glazed door option

Two File Module with Door - LEFT**

Two file drawers on bottom. Laminate door is standard. Includes two 3-position fixed/height adjustable shelves. Upper lock secures storage compartment. Lower lock secures two file drawers. Ganging hardware included with all units 24" wide or less and 41"H or taller. Shipped assembled in 1 carton.

Z16L6EL	16 x 24 x 66	171	18.75	\$1603	\$1645	\$473	N/A
Z15L6EL	15 x 24 x 66	164	17.5	\$1566	\$1600	\$420	N/A
Z16M6EL	16 x 20 x 66	153	15.75	\$1493	\$1528	\$473	N/A
Z15M6EL	15 x 20 x 66	148	14.75	\$1438	\$1468	\$420	N/A
Z16S6EL	16 x 16 x 66	129	13	\$1363	\$1397	\$473	N/A
Z15S6EL	15 x 16 x 66	124	12	\$1320	\$1349	\$420	N/A

Required specifications

Top finish
Top thickness/edge detail
Base finish
Handles

Optional specifications

HP laminate
Key #
Collator - position & finish*
Glazed door**

STORAGE MODULES - 65.5" / 66" HIGH



Glazed door option

Two File Module with Door - RIGHT*

MODEL #	DIMENSIONS W x D x H (1.5" TOP)	WT/LB.	CUBIC FT.	1" TOP	1.5" TOP	GLAZE ADD	HP ADD
Z16L6ER	16 x 24 x 66	171	18.75	\$1603	\$1645	\$473	N/A
Z15L6ER	15 x 24 x 66	164	17.5	\$1566	\$1600	\$420	N/A
Z16M6ER	16 x 20 x 66	153	15.75	\$1493	\$1528	\$473	N/A
Z15M6ER	15 x 20 x 66	148	14.75	\$1438	\$1468	\$420	N/A
Z16S6ER	16 x 16 x 66	129	13	\$1363	\$1397	\$473	N/A
Z15S6ER	15 x 16 x 66	124	12	\$1320	\$1349	\$420	N/A

Two file drawers on bottom. Laminate door is standard. **Includes two 3-position fixed/height adjustable shelves.** Upper lock secures storage compartment. Lower lock secures two file drawers. Ganging hardware included with all units 24" wide or less and 41"H or taller. Shipped assembled in 1 carton.

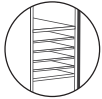

* Accepts collator 11" high

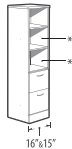
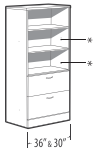

Two File Module with Open Shelves**

Z36L6EN	36 x 24 x 66	271	39	\$2367	\$2436	N/A	N/A
Z30L6EN	30 x 24 x 66	241	32.75	\$2169	\$2231	N/A	N/A
Z16L6EN	16 x 24 x 66	162	18.75	\$1440	\$1482	N/A	N/A
Z15L6EN	15 x 24 x 66	156	17.5	\$1419	\$1453	N/A	N/A
Z36M6EN	36 x 20 x 66	243	33.25	\$2253	\$2315	N/A	N/A
Z30M6EN	30 x 20 x 66	214	27.75	\$2039	\$2091	N/A	N/A
Z16M6EN	16 x 20 x 66	143	15.75	\$1329	\$1364	N/A	N/A
Z15M6EN	15 x 20 x 66	138	14.75	\$1289	\$1319	N/A	N/A
Z36S6EN	36 x 16 x 66	202	26.5	\$1877	\$1938	N/A	N/A
Z30S6EN	30 x 16 x 66	178	22.5	\$1816	\$1858	N/A	N/A
Z16S6EN	16 x 16 x 66	119	13	\$1197	\$1231	N/A	N/A
Z15S6EN	15 x 16 x 66	114	12	\$1169	\$1198	N/A	N/A

Three open shelves and two file drawers on bottom. **Includes two 3-position fixed/height adjustable shelves.** Lock secures all drawers. 36" and 30" wide models have front-to-back and side-to-side letter/legal filing capability. Side-to-side file bars included. Ganging hardware included with all units 24" wide or less and 41"H or taller. Shipped assembled in 1 carton.

- Lateral file drawer construction is for accommodating hanging files NOT for stacking materials on the drawer bottom.

WARDROBE CABINETS - 65.6" / 66" HIGH

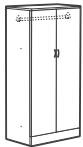

Wardrobe Cabinet

MODEL #	DIMENSIONS W x D x H (1.5" TOP)	WT/LB.	CUBIC FT.	1" TOP	1.5" TOP	GLAZE ADD	HP ADD
Z36L6WA	36 x 24 x 66	216	39	\$1841	\$1910	N/A	N/A
Z30L6WA	30 x 24 x 66	192	32.75	\$1654	\$1716	N/A	N/A
Z36M6WA	36 x 20 x 66	201	33.25	\$1766	\$1828	N/A	N/A
Z30M6WA	30 x 20 x 66	173	27.75	\$1561	\$1613	N/A	N/A

Laminate doors are standard. Full length hanging rod included. Standard with lock. Shipped assembled in 1 carton.

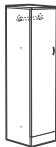

Wardrobe Cabinet - LEFT

Z24L6WAL	24 x 24 x 66	166	26.75	\$1517	\$1568	N/A	N/A
Z21L6WAL	21 x 24 x 66	152	23.5	\$1394	\$1444	N/A	N/A
Z18L6WAL	18 x 24 x 66	140	20.5	\$1244	\$1286	N/A	N/A
Z16L6WAL	16 x 24 x 66	132	18.75	\$1212	\$1254	N/A	N/A
Z15L6WAL	15 x 24 x 66	128	17.5	\$1164	\$1198	N/A	N/A
Z12L6WAL	12 x 24 x 66	116	14.5	\$1073	\$1103	N/A	N/A
Z24M6WAL	24 x 20 x 66	149	22.5	\$1304	\$1346	N/A	N/A
Z21M6WAL	21 x 20 x 66	144	20	\$1263	\$1305	N/A	N/A
Z18M6WAL	18 x 20 x 66	125	17.25	\$1146	\$1181	N/A	N/A
Z16M6WAL	16 x 20 x 66	117	15.75	\$1118	\$1153	N/A	N/A
Z15M6WAL	15 x 20 x 66	113	14.75	\$1051	\$1081	N/A	N/A
Z12M6WAL	12 x 20 x 66	103	12.25	\$1000	\$1025	N/A	N/A

Laminate doors are standard. Full length hanging rod included. Standard with lock. Ganging hardware included with all units 24" wide or less and 41"H or taller. Shipped assembled in 1 carton.

Required specifications

- Top finish
- Top thickness/edge detail
- Base finish
- Handles

Optional specifications

- Key #
- Box drawer - no upcharge
- Collator - position & finish**
- Glazed door*

WARDROBE CABINETS - 65.5" / 66" HIGH

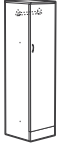

Wardrobe Cabinet - RIGHT

MODEL #	DIMENSIONS W x D x H (1.5" TOP)	WT/LB.	CUBIC FT.	1" TOP	1.5" TOP	GLAZE ADD	HP ADD
Z24L6WAR	24 x 24 x 66	166	26.75	\$1517	\$1568	N/A	N/A
Z21L6WAR	21 x 24 x 66	152	23.5	\$1394	\$1444	N/A	N/A
Z18L6WAR	18 x 24 x 66	140	20.5	\$1244	\$1286	N/A	N/A
Z16L6WAR	16 x 24 x 66	132	18.75	\$1212	\$1254	N/A	N/A
Z15L6WAR	15 x 24 x 66	128	17.5	\$1164	\$1198	N/A	N/A
Z12L6WAR	12 x 24 x 66	116	14.5	\$1073	\$1103	N/A	N/A
Z24M6WAR	24 x 20 x 66	149	22.5	\$1304	\$1346	N/A	N/A
Z21M6WAR	21 x 20 x 66	144	20	\$1263	\$1305	N/A	N/A
Z18M6WAR	18 x 20 x 66	125	17.25	\$1146	\$1181	N/A	N/A
Z16M6WAR	16 x 20 x 66	117	15.75	\$1118	\$1153	N/A	N/A
Z15M6WAR	15 x 20 x 66	113	14.75	\$1051	\$1081	N/A	N/A
Z12M6WAR	12 x 20 x 66	103	12.25	\$1000	\$1025	N/A	N/A

Laminate doors are standard. Full length hanging rod included. Standard with lock. Ganging hardware included with all units 24" wide or less and 41"H or taller. Shipped assembled in 1 carton.

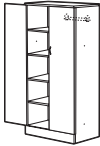

Glazed door option

Wardrobe Cabinet/Shelving Combo with Doors - LEFT*

Z36L6DIL	36 x 24 x 66	270	39	\$2199	\$2268	\$1409	N/A
Z30L6DIL	30 x 24 x 66	240	32.75	\$1945	\$2007	\$1219	N/A
Z24L6DIL	24 x 24 x 66	209	26.75	\$1817	\$1868	\$1099	N/A
Z21L6DIL	21 x 24 x 66	193	23.5	\$1707	\$1757	\$1091	N/A
Z36M6DIL	36 x 20 x 66	244	33.25	\$2070	\$2132	\$1409	N/A
Z30M6DIL	30 x 20 x 66	227	27.75	\$1806	\$1858	\$1219	N/A
Z24M6DIL	24 x 20 x 66	185	22.5	\$1619	\$1661	\$1099	N/A
Z21M6DIL	21 x 20 x 66	171	20	\$1573	\$1615	\$1091	N/A

Laminate doors are standard. Storage compartment on **left includes four 3-position fixed/height adjustable shelves**. Wardrobe compartment on **right** includes hanging rod. Two locks secure storage and wardrobe compartments. Ganging hardware included with all units 24" wide or less and 41"H or taller. Shipped assembled in 1 carton.

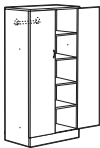

Glazed door option

Wardrobe Cabinet/Shelving Combo with Doors - RIGHT

Z36L6DIR	36 x 24 x 66	270	39	\$2199	\$2268	\$1409	N/A
Z30L6DIR	30 x 24 x 66	240	32.75	\$1945	\$2007	\$1219	N/A
Z24L6DIR	24 x 24 x 66	209	26.75	\$1817	\$1868	\$1099	N/A
Z21L6DIR	21 x 24 x 66	193	23.5	\$1707	\$1757	\$1091	N/A
Z36M6DIR	36 x 20 x 66	244	33.25	\$2070	\$2132	\$1409	N/A
Z30M6DIR	30 x 20 x 66	227	27.75	\$1806	\$1858	\$1219	N/A
Z24M6DIR	24 x 20 x 66	185	22.5	\$1619	\$1661	\$1099	N/A
Z21M6DIR	21 x 20 x 66	171	20	\$1573	\$1615	\$1091	N/A

Laminate doors are standard. Storage compartment on **right includes four 3-position fixed/height adjustable shelves**. Wardrobe compartment on **left** includes hanging rod. Two locks secure storage and wardrobe compartments. Ganging hardware included with all units 24" wide or less and 41"H or taller. Shipped assembled in 1 carton.

Required specifications

- Top finish
- Top thickness/edge detail
- Base finish
- Handles

Optional specifications

- Key #
- Glazed door*

WARDROBE CABINETS - 65.5" / 66" HIGH **MODEL #** **DIMENSIONS** **WT/LB.** **CUBIC FT.** **1" TOP** **1.5" TOP** **GLAZE ADD** **HP ADD**

W x D x H (1.5" TOP)

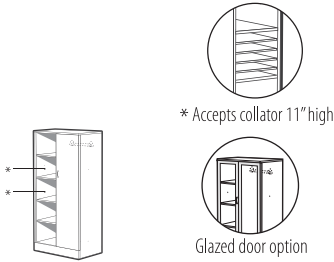

Wardrobe Cabinet/Open Shelving Combo - LEFT

Z36L6DINL	36 x 24 x 66	252	39	\$1968	\$2037	\$700	N/A
Z30L6DINL	30 x 24 x 66	224	32.75	\$1756	\$1818	\$606	N/A
Z24L6DINL	24 x 24 x 66	196	26.75	\$1653	\$1704	\$546	N/A
Z21L6DINL	21 x 24 x 66	183	23.5	\$1542	\$1592	\$540	N/A
Z36M6DINL	36 x 20 x 66	223	33.25	\$1838	\$1900	\$700	N/A
Z30M6DINL	30 x 20 x 66	198	27.75	\$1610	\$1662	\$606	N/A
Z24M6DINL	24 x 20 x 66	174	22.5	\$1456	\$1498	\$546	N/A
Z21M6DINL	21 x 20 x 66	159	20	\$1410	\$1452	\$540	N/A

Laminate door is standard. Storage compartment on **left includes four 3-position fixed/height adjustable shelves**. Wardrobe compartment on **right** includes hanging rod. Single lock secures wardrobe compartment. Ganging hardware included with all units 24" wide or less and 41"H or taller. Shipped assembled in 1 carton.

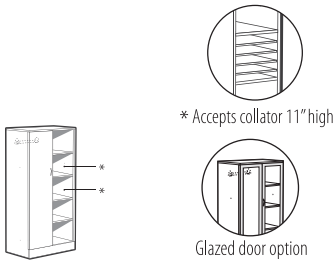

Wardrobe Cabinet/Open Shelving Combo - RIGHT

Z36L6DINR	36 x 24 x 66	252	39	\$1968	\$2037	\$700	N/A
Z30L6DINR	30 x 24 x 66	224	32.75	\$1756	\$1818	\$606	N/A
Z24L6DINR	24 x 24 x 66	196	26.75	\$1653	\$1704	\$546	N/A
Z21L6DINR	21 x 24 x 66	183	23.5	\$1542	\$1592	\$540	N/A
Z36M6DINR	36 x 20 x 66	223	33.25	\$1838	\$1900	\$700	N/A
Z30M6DINR	30 x 20 x 66	198	27.75	\$1610	\$1662	\$606	N/A
Z24M6DINR	24 x 20 x 66	174	22.5	\$1456	\$1498	\$546	N/A
Z21M6DINR	21 x 20 x 66	159	20	\$1410	\$1452	\$540	N/A

Laminate door is standard. Storage compartment on **right includes four 3-position fixed/height adjustable shelves**. Wardrobe compartment on **left** includes hanging rod. Single lock secures wardrobe compartment. Ganging hardware included with all units 24" wide or less and 41"H or taller. Shipped assembled in 1 carton.

Required specifications

- Top finish
- Top thickness/edge detail
- Base finish
- Handles

Optional specifications

- Key #
- Collator - position & finish
- Glazed door

PERSONAL TOWERS - 65.5" / 66" HIGH

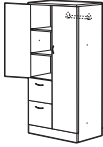

Glazed door option

Personal Tower with Doors - LEFT

MODEL #	DIMENSIONS W x D x H (1.5" TOP)	WT/LB.	CUBIC FT.	1" TOP	1.5" TOP	GLAZE ADD	HP ADD
Z36L6EL	36 x 24 x 66	291	39	\$2412	\$2481	\$1181	N/A
Z30L6EL	30 x 24 x 66	267	32.75	\$2235	\$2297	\$1076	N/A
Z24L6EL	24 x 24 x 66	243	26.75	\$2141	\$2192	\$942	N/A
Z36M6EL	36 x 20 x 66	256	33.25	\$2283	\$2345	\$1181	N/A
Z30M6EL	30 x 20 x 66	230	27.75	\$2086	\$2138	\$1076	N/A
Z24M6EL	24 x 20 x 66	217	22.5	\$1999	\$2041	\$942	N/A

Two file drawers on bottom. Laminate doors are standard. Storage compartment on **left includes two 3-position fixed/height adjustable shelves**. Wardrobe compartment on **right** includes hanging rod. Two upper locks (one per each hinged door) and one lower lock secures drawers, all keyed alike. Ganging hardware included with all units 24" wide or less and 41"H or taller. Shipped assembled in 1 carton.



Glazed door option

Personal Tower with Doors - RIGHT

Z36L6ER	36 x 24 x 66	291	39	\$2412	\$2481	\$1181	N/A
Z30L6ER	30 x 24 x 66	267	32.75	\$2235	\$2297	\$1076	N/A
Z24L6ER	24 x 24 x 66	243	26.75	\$2141	\$2192	\$942	N/A
Z36M6ER	36 x 20 x 66	256	33.25	\$2283	\$2345	\$1181	N/A
Z30M6ER	30 x 20 x 66	230	27.75	\$2086	\$2138	\$1076	N/A
Z24M6ER	24 x 20 x 66	217	22.5	\$1999	\$2041	\$942	N/A

Two file drawers on bottom. Laminate doors are standard. Storage compartment on **right includes two 3-position fixed/height adjustable shelves**. Wardrobe compartment on **left** includes hanging rod. Two upper locks (one per each hinged door) and one lower lock secures drawers, all keyed alike. Ganging hardware included with all units 24" wide or less and 41"H or taller. Shipped assembled in 1 carton.

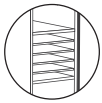
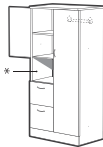

* Accepts collator 11" high



Glazed door option

Personal Tower with Doors and Cavity - LEFT

Z36L6ECL	36 x 24 x 66	289	39	\$2383	\$2452	\$1128	N/A
Z30L6ECL	30 x 24 x 66	264	32.75	\$2202	\$2264	\$1022	N/A
Z24L6ECL	24 x 24 x 66	239	26.75	\$2110	\$2161	\$887	N/A
Z36M6ECL	36 x 20 x 66	252	33.25	\$2243	\$2305	\$1128	N/A
Z30M6ECL	30 x 20 x 66	227	27.75	\$2043	\$2095	\$1022	N/A
Z24M6ECL	24 x 20 x 66	213	22.5	\$1971	\$2013	\$887	N/A

Two file drawers on bottom. Laminate doors are standard. Storage compartment on **left includes one 3-position fixed/height adjustable shelf**. Wardrobe compartment on **right** includes hanging rod. Two upper locks (one per each hinged door) and one lower lock secures drawers, all keyed alike. Ganging hardware included with all units 24" wide or less and 41"H or taller. Shipped assembled in 1 carton.

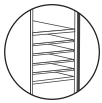
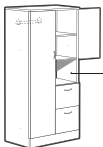

* Accepts collator 11" high



Glazed door option

Personal Tower with Doors and cavity - RIGHT

Z36L6ECR	36 x 24 x 66	289	39	\$2383	\$2452	\$1128	N/A
Z30L6ECR	30 x 24 x 66	264	32.75	\$2202	\$2264	\$1022	N/A
Z24L6ECR	24 x 24 x 66	239	26.75	\$2110	\$2161	\$887	N/A
Z36M6ECR	36 x 20 x 66	252	33.25	\$2243	\$2305	\$1128	N/A
Z30M6ECR	30 x 20 x 66	227	27.75	\$2043	\$2095	\$1022	N/A
Z24M6ECR	24 x 20 x 66	213	22.5	\$1971	\$2013	\$887	N/A

Two file drawers on bottom. Laminate doors are standard. Storage compartment on **right includes one 3-position fixed/height adjustable shelf**. Wardrobe compartment on **left** includes hanging rod. Two upper locks (one per each hinged door) and one lower lock secures drawers, all keyed alike. Ganging hardware included with all units 24" wide or less and 41"H or taller. Shipped assembled in 1 carton.

Required specifications

Top finish
Top thickness/edge detail
Base finish
Handles

Optional specifications

Key #
Box drawer - no upcharge
Collator - position & finish
Glazed door

PERSONAL TOWERS - 65.5" / 66" HIGH **MODEL #** **DIMENSIONS** **WT/LB.** **CUBIC FT.** **1" TOP** **1.5" TOP** **GLAZE ADD** **HP ADD**

W x D x H (1.5" TOP)

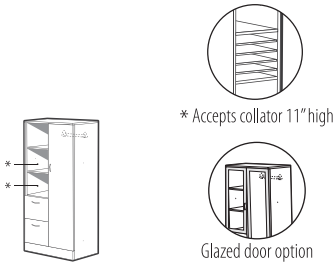

Personal Tower with Open Shelves - LEFT

Z36L6ENL	36 x 24 x 66	280	39	\$2251	\$2320	\$705	N/A
Z30L6ENL	30 x 24 x 66	257	32.75	\$2070	\$2132	\$601	N/A
Z24L6ENL	24 x 24 x 66	230	26.75	\$1980	\$2031	\$468	N/A
Z36M6ENL	36 x 20 x 66	244	33.25	\$2109	\$2171	\$705	N/A
Z30M6ENL	30 x 20 x 66	220	27.75	\$1912	\$1964	\$601	N/A
Z24M6ENL	24 x 20 x 66	204	22.5	\$1812	\$1869	\$468	N/A

Two file drawers on bottom. Laminate doors are standard on wardrobe section. Storage compartment on **left** includes **two 3-position fixed/height adjustable shelves**. Wardrobe compartment on **right** includes hanging rod. Upper lock secures wardrobe compartment. Lower lock secures all drawers. Ganging hardware included with all units 24" wide or less and 41"H or taller. Shipped assembled in 1 carton.

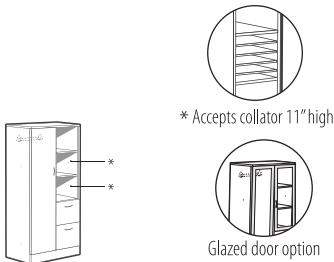

Personal Tower with Open Shelves - RIGHT

Z36L6ENR	36 x 24 x 66	280	39	\$2251	\$2320	\$705	N/A
Z30L6ENR	30 x 24 x 66	257	32.75	\$2070	\$2132	\$601	N/A
Z24L6ENR	24 x 24 x 66	230	26.75	\$1980	\$2031	\$468	N/A
Z36M6ENR	36 x 20 x 66	244	33.25	\$2109	\$2171	\$705	N/A
Z30M6ENR	30 x 20 x 66	220	27.75	\$1912	\$1964	\$601	N/A
Z24M6ENR	24 x 20 x 66	204	22.5	\$1812	\$1869	\$468	N/A

Two file drawers on bottom. Laminate doors is standard on wardrobe section. Storage compartment on **right** includes **two 3-position fixed/height adjustable shelves**. Wardrobe compartment on **left** includes hanging rod. Upper lock secures wardrobe compartment. Lower lock secures all drawers. Ganging hardware included with all units 24" wide or less and 41"H or taller. Shipped assembled in 1 carton.

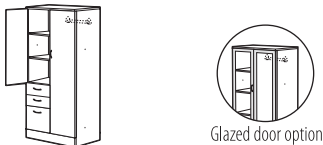

Personal Tower with Doors - LEFT

Z36L6BFL	36 x 24 x 66	294	39	\$2538	\$2607	\$1181	N/A
Z30L6BFL	30 x 24 x 66	269	32.75	\$2360	\$2422	\$1076	N/A
Z24L6BFL	24 x 24 x 66	244	26.75	\$2242	\$2293	\$942	N/A
Z36M6BFL	36 x 20 x 66	258	33.25	\$2415	\$2477	\$1181	N/A
Z30M6BFL	30 x 20 x 66	232	27.75	\$2218	\$2270	\$1076	N/A
Z24M6BFL	24 x 20 x 66	218	22.5	\$2102	\$2144	\$942	N/A

Two box and one file drawer on bottom. Laminate doors are standard. Storage compartment on **left** includes **two 3-position fixed/height adjustable shelves**. Wardrobe compartment on **right** includes hanging rod. Two upper locks (one per each hinged door) and one lower lock secures drawers, all keyed alike. Ganging hardware included with all units 24" wide or less and 41"H or taller. Shipped assembled in 1 carton.

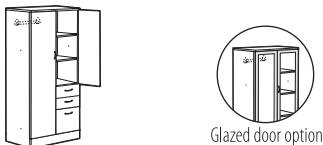

Personal Tower with Doors - RIGHT

Z36L6BFR	36 x 24 x 66	294	39	\$2538	\$2607	\$1181	N/A
Z30L6BFR	30 x 24 x 66	269	32.75	\$2360	\$2422	\$1076	N/A
Z24L6BFR	24 x 24 x 66	244	26.75	\$2242	\$2293	\$942	N/A
Z36M6BFR	36 x 20 x 66	258	33.25	\$2415	\$2477	\$1181	N/A
Z30M6BFR	30 x 20 x 66	232	27.75	\$2218	\$2270	\$1076	N/A
Z24M6BFR	24 x 20 x 66	218	22.5	\$2102	\$2144	\$942	N/A

Two box and one file drawer on bottom. Laminate doors are standard. Storage compartment on **right** includes **two 3-position fixed/height adjustable shelves**. Wardrobe compartment on **left** includes hanging rod. Two upper locks (one per each hinged door) and one lower lock secures drawers, all keyed alike. Ganging hardware included with all units 24" wide or less and 41"H or taller. Shipped assembled in 1 carton.

Required specifications

- Top finish
- Top thickness/edge detail
- Base finish
- Handles

Optional specifications

- Key #
- Box drawer - no upcharge
- Collator - position & finish*
- Glazed door

PERSONAL TOWERS - 65.5" / 66" HIGH

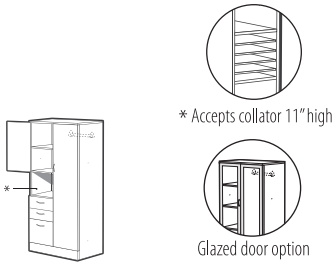

Personal Tower with Doors
Cavity - LEFT*

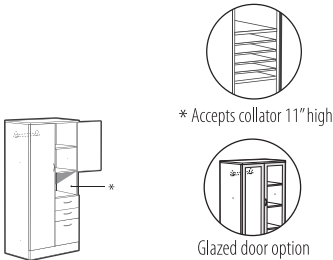

Personal Tower with Doors
and Cavity - RIGHT*

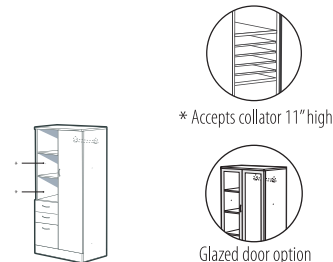

Personal Tower with Open Shelves
- LEFT

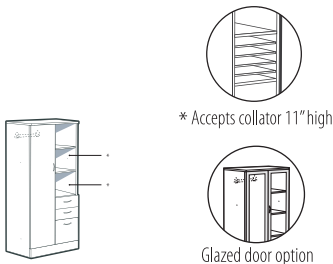

Personal Tower with Open Shelves
- RIGHT

MODEL #	DIMENSIONS W x D x H (1.5" TOP)	WT/LB.	CUBIC FT.	1" TOP	1.5" TOP	GLAZE ADD	HP ADD
Z36L6BFCL	36 x 24 x 66	292	39	\$2509	\$2578	\$1128	N/A
Z30L6BFCL	30 x 24 x 66	266	32.75	\$2330	\$2392	\$1022	N/A
Z24L6BFCL	24 x 24 x 66	240	26.75	\$2213	\$2264	\$887	N/A
Z36M6BFCL	36 x 20 x 66	254	33.25	\$2366	\$2428	\$1128	N/A
Z30M6BFCL	30 x 20 x 66	229	27.75	\$2168	\$2220	\$1022	N/A
Z24M6BFCL	24 x 20 x 66	214	22.5	\$2074	\$2116	\$887	N/A

Two box and one file drawer on bottom. Laminate doors are standard. Storage compartment on **left includes one 3-position fixed/height adjustable shelf**. Wardrobe compartment on **right** includes hanging rod. Two upper locks (one per each hinged door) and one lower lock secures drawers, all keyed alike. Ganging hardware included with all units 24" wide or less and 41"H or taller. Shipped assembled in 1 carton.

Z36L6BFCL	36 x 24 x 66	292	39	\$2509	\$2578	\$1128	N/A
Z30L6BFCL	30 x 24 x 66	266	32.75	\$2330	\$2392	\$1022	N/A
Z24L6BFCL	24 x 24 x 66	240	26.75	\$2213	\$2264	\$887	N/A
Z36M6BFCL	36 x 20 x 66	254	33.25	\$2366	\$2428	\$1128	N/A
Z30M6BFCL	30 x 20 x 66	229	27.75	\$2168	\$2220	\$1022	N/A
Z24M6BFCL	24 x 20 x 66	214	22.5	\$2074	\$2116	\$887	N/A

Two box and one file drawer on bottom. Laminate doors are standard. Storage compartment on **right includes one 3-position fixed/height adjustable shelf**. Wardrobe compartment on **left** includes hanging rod. Two upper locks (one per each hinged door) and one lower lock secures drawers, all keyed alike. Ganging hardware included with all units 24" wide or less and 41"H or taller. Shipped assembled in 1 carton.

Z36L6BFNL	36 x 24 x 66	280	39	\$2376	\$2445	\$705	N/A
Z30L6BFNL	30 x 24 x 66	257	32.75	\$2196	\$2258	\$601	N/A
Z24L6BFNL	24 x 24 x 66	232	26.75	\$2081	\$2132	\$468	N/A
Z36M6BFNL	36 x 20 x 66	242	33.25	\$2254	\$2316	\$705	N/A
Z30M6BFNL	30 x 20 x 66	219	27.75	\$2054	\$2106	\$601	N/A
Z24M6BFNL	24 x 20 x 66	206	22.5	\$1960	\$2002	\$468	N/A

Two box and one file drawer on bottom. Laminate doors are standard. Storage compartment on **left includes two 3-position fixed/height adjustable shelves**. Wardrobe compartment on **right** includes hanging rod. Upper lock secures wardrobe compartment. Lower lock secures all drawers. Ganging hardware included with all units 24" wide or less and 41"H or taller. Shipped assembled in 1 carton.

Z36L6BFNR	36 x 24 x 66	280	39	\$2376	\$2445	\$705	N/A
Z30L6BFNR	30 x 24 x 66	257	32.75	\$2196	\$2258	\$601	N/A
Z24L6BFNR	24 x 24 x 66	232	26.75	\$2081	\$2132	\$468	N/A
Z36M6BFNR	36 x 20 x 66	242	33.25	\$2254	\$2316	\$705	N/A
Z30M6BFNR	30 x 20 x 66	219	27.75	\$2054	\$2106	\$601	N/A
Z24M6BFNR	24 x 20 x 66	206	22.5	\$1960	\$2002	\$468	N/A

Two box and one file drawer on bottom. Laminate doors are standard. Storage compartment on **right includes two 3-position fixed/height adjustable shelves**. Wardrobe compartment on **left** includes hanging rod. Upper lock secures wardrobe compartment. Lower lock secures all drawers. Ganging hardware included with all units 24" wide or less and 41"H or taller. Shipped assembled in 1 carton.

Required specifications

Top finish
Top thickness/edge detail
Base finish
Handles

Optional specifications

Key #
Box drawer - no upcharge
Collator - position & finish
Glazed door

STORAGE MODULES - 72" / 72.5" HIGH

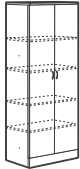

Glazed door option

Storage Cabinet with Doors

MODEL #	DIMENSIONS W x D x H (1.5" TOP)	WT/LB.	CUBIC FT.	1" TOP	1.5" TOP	GLAZE ADD	HP ADD
Z36L7SH	36 x 24 x 72.4	295	43.25	\$2244	\$2313	\$1518	N/A
Z30L7SH	30 x 24 x 72.4	253	36.25	\$1961	\$2023	\$1311	N/A
Z36M7SH	36 x 20 x 72.4	261	36.75	\$2085	\$2147	\$1518	N/A
Z30M7SH	30 x 20 x 72.4	226	30.5	\$1806	\$1858	\$1311	N/A
Z36S7SH	36 x 16 x 72.4	226	29.5	\$1867	\$1928	\$1518	N/A
Z30S7SH	30 x 16 x 72.4	195	25	\$1642	\$1684	\$1311	N/A

Laminate doors are standard. **Includes four 3-position fixed/height adjustable shelves.** Standard with lock. Ganging hardware included with all units 24" wide or less and 41"H or taller. Shipped assembled in 1 carton.



Glazed door option

Storage Cabinet with Door - LEFT

Z21L7SHL	21 x 24 x 72.4	196	26	\$1624	\$1674	\$843	N/A
Z18L7SHL	18 x 24 x 72.4	179	22.75	\$1511	\$1553	\$754	N/A
Z16L7SHL	16 x 24 x 72.4	167	20.75	\$1421	\$1463	\$748	N/A
Z15L7SHL	15 x 24 x 72.4	161	19.25	\$1359	\$1393	\$651	N/A
Z12L7SHL	12 x 24 x 72.4	137	16	\$1250	\$1280	\$584	N/A
Z21M7SHL	21 x 20 x 72.4	174	21.25	\$1449	\$1491	\$843	N/A
Z18M7SHL	18 x 20 x 72.4	156	19.25	\$1383	\$1418	\$754	N/A
Z16M7SHL	16 x 20 x 72.4	147	17.5	\$1301	\$1336	\$748	N/A
Z15M7SHL	15 x 20 x 72.4	140	16.25	\$1240	\$1270	\$651	N/A
Z12M7SHL	12 x 20 x 72.4	124	13.25	\$1135	\$1160	\$584	N/A
Z21S7SHL	21 x 16 x 72.4	150	18	\$1337	\$1370	\$843	N/A
Z18S7SHL	18 x 16 x 72.4	134	15.5	\$1246	\$1280	\$754	N/A
Z16S7SHL	16 x 16 x 72.4	125	14	\$1191	\$1225	\$748	N/A
Z15S7SHL	15 x 16 x 72.4	119	12.5	\$1146	\$1175	\$651	N/A
Z12S7SHL	12 x 16 x 72.4	104	11	\$1005	\$1030	\$584	N/A

Laminate doors are standard. **Includes four 3-position fixed/height adjustable shelves.** Standard with lock. Ganging hardware included with all units 24" wide or less and 41"H or taller. Shipped assembled in 1 carton.



Glazed door option

Storage Cabinet with Door - RIGHT

Z21L7SHR	21 x 24 x 72.4	196	26	\$1624	\$1674	\$843	N/A
Z18L7SHR	18 x 24 x 72.4	179	22.75	\$1511	\$1553	\$754	N/A
Z16L7SHR	16 x 24 x 72.4	167	20.75	\$1421	\$1463	\$748	N/A
Z15L7SHR	15 x 24 x 72.4	161	19.25	\$1359	\$1393	\$651	N/A
Z12L7SHR	12 x 24 x 72.4	137	16	\$1250	\$1280	\$584	N/A
Z21M7SHR	21 x 20 x 72.4	174	21.25	\$1449	\$1491	\$843	N/A
Z18M7SHR	18 x 20 x 72.4	156	19.25	\$1383	\$1418	\$754	N/A
Z16M7SHR	16 x 20 x 72.4	147	17.5	\$1301	\$1336	\$748	N/A
Z15M7SHR	15 x 20 x 72.4	140	16.25	\$1240	\$1270	\$651	N/A
Z12M7SHR	12 x 20 x 72.4	124	13.25	\$1135	\$1160	\$584	N/A
Z21S7SHR	21 x 16 x 72.4	150	18	\$1337	\$1370	\$843	N/A
Z18S7SHR	18 x 16 x 72.4	134	15.5	\$1246	\$1280	\$754	N/A
Z16S7SHR	16 x 16 x 72.4	125	14	\$1191	\$1225	\$748	N/A
Z15S7SHR	15 x 16 x 72.4	119	12.5	\$1146	\$1175	\$651	N/A
Z12S7SHR	12 x 16 x 72.4	104	11	\$1005	\$1030	\$584	N/A

Laminate doors are standard. **Includes four 3-position fixed/height adjustable shelves.** Standard with lock. Ganging hardware included with all units 24" wide or less and 41"H or taller. Shipped assembled in 1 carton.

Required specifications

- Top finish
- Top thickness/edge detail
- Base finish
- Handles

Optional specifications

- Key #
- Box drawer - no upcharge
- Collator - position & finish*
- Glazed door

STORAGE MODULES - 72" / 72.5" HIGH

MODEL #	DIMENSIONS	WT/LB.	CUBIC FT.	1" TOP	1.5" TOP	GLAZE ADD	HP ADD
	W x D x H (1.5" TOP)						
Z36L7SHN	36 x 24 x 72.4	250	43.25	\$1756	\$1825	N/A	N/A
Z30L7SHN	30 x 24 x 72.4	216	36.25	\$1554	\$1616	N/A	N/A
Z21L7SHN	21 x 24 x 72.4	172	26	\$1345	\$1395	N/A	N/A
Z18L7SHN	18 x 24 x 72.4	157	22.75	\$1261	\$1303	N/A	N/A
Z16L7SHN	16 x 24 x 72.4	147	20.75	\$1173	\$1215	N/A	N/A
Z15L7SHN	15 x 24 x 72.4	142	19.25	\$1140	\$1174	N/A	N/A
Z12L7SHN	12 x 24 x 72.4	121	16	\$1053	\$1162	N/A	N/A
Z36M7SHN	36 x 20 x 72.4	217	36.75	\$1594	\$1656	N/A	N/A
Z30M7SHN	30 x 20 x 72.4	188	30.5	\$1400	\$1452	N/A	N/A
Z21M7SHN	21 x 20 x 72.4	149	21.25	\$1062	\$1104	N/A	N/A
Z18M7SHN	18 x 20 x 72.4	135	19.25	\$1133	\$1168	N/A	N/A
Z16M7SHN	16 x 20 x 72.4	127	17.5	\$1051	\$1086	N/A	N/A
Z15M7SHN	15 x 20 x 72.4	122	16.25	\$1021	\$1051	N/A	N/A
Z12M7SHN	12 x 20 x 72.4	109	13.25	\$941	\$966	N/A	N/A
Z36S7SHN	36 x 16 x 72.4	181	29.5	\$1377	\$1438	N/A	N/A
Z30S7SHN	30 x 16 x 72.4	158	25	\$1235	\$1277	N/A	N/A
Z21S7SHN	21 x 16 x 72.4	124	18	\$1060	\$1093	N/A	N/A
Z18S7SHN	18 x 16 x 72.4	113	15.5	\$996	\$1030	N/A	N/A
Z16S7SHN	16 x 16 x 72.4	105	14	\$942	\$976	N/A	N/A
Z15S7SHN	15 x 16 x 72.4	100	12.5	\$928	\$957	N/A	N/A
Z12S7SHN	12 x 16 x 72.4	90	11	\$813	\$838	N/A	N/A

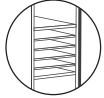

* Accepts collator 11" high

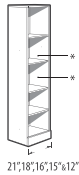
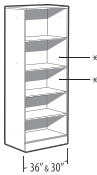

Open Storage Cabinet*

Four adjustable shelves. Ganging hardware included with all units 24" wide or less and 41"H or taller. Shipped assembled in 1 carton.

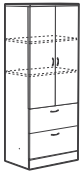

Glazed door option

Two File Module with Doors**

Z36L7E	36 x 24 x 72.4	316	43.25	\$2864	\$2933	\$1194	N/A
Z30L7E	30 x 24 x 72.4	276	36.25	\$2615	\$2677	\$1038	N/A
Z36M7E	36 x 20 x 72.4	286	36.75	\$2709	\$2771	\$1194	N/A
Z30M7E	30 x 20 x 72.4	250	30.5	\$2471	\$2523	\$1038	N/A
Z36S7E	36 x 16 x 72.4	245	29.5	\$2478	\$2539	\$1194	N/A
Z30S7E	30 x 16 x 72.4	213	25	\$2235	\$2277	\$1038	N/A

Two lateral file drawers. Laminate doors are standard. **Includes two adjustable shelves.** Upper lock secures storage compartment. Lower lock secures two file drawers. Front-to-back and side-to-side letter/legal filing capability. Side-to-side file bars included. Shipped assembled in 1 carton.

- Lateral file drawer construction is for accommodating hanging files NOT for stacking materials on the drawer bottom.



Glazed door option

Two File Module with Door - LEFT**

Z16L7EL	16 x 24 x 72.4	182	20.75	\$1689	\$1731	\$585	N/A
Z15L7EL	15 x 24 x 72.4	176	19.25	\$1624	\$1658	\$515	N/A
Z16M7EL	16 x 20 x 72.4	163	17.5	\$1566	\$1601	\$585	N/A
Z15M7EL	15 x 20 x 72.4	155	16.25	\$1506	\$1536	\$515	N/A
Z16S7EL	16 x 16 x 72.4	138	14	\$1458	\$1492	\$585	N/A
Z15S7EL	15 x 16 x 72.4	132	12.5	\$1426	\$1455	\$515	N/A

Two file drawers on bottom. Laminate door is standard. **Includes two 3-position fixed/height adjustable shelves.** Upper lock secures storage compartment. Lower lock secures two file drawers. Ganging hardware included with all units 24" wide or less and 41"H or taller. Shipped assembled in 1 carton.

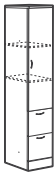

Glazed door option

Two File Module with Door - RIGHT**

Z16L7ER	16 x 24 x 72.4	182	20.75	\$1689	\$1731	\$585	N/A
Z15L7ER	15 x 24 x 72.4	176	19.25	\$1624	\$1658	\$515	N/A
Z16M7ER	16 x 20 x 72.4	163	17.5	\$1566	\$1601	\$585	N/A
Z15M7ER	15 x 20 x 72.4	155	16.25	\$1506	\$1536	\$515	N/A
Z16S7ER	16 x 16 x 72.4	138	14	\$1458	\$1492	\$585	N/A
Z15S7ER	15 x 16 x 72.4	132	12.5	\$1426	\$1455	\$515	N/A

Two file drawers on bottom. Laminate door is standard. **Includes two 3-position fixed/height adjustable shelves.** Upper lock secures storage compartment. Lower lock secures two file drawers. Ganging hardware included with all units 24" wide or less and 41"H or taller. Shipped assembled in 1 carton.

Required specifications

Top finish
Top thickness/edge detail
Base finish
Handles

Optional specifications

Key #
Box drawer - no upcharge**
Collator - position & finish*
Glazed door

STORAGE MODULES - 72" / 72.5" HIGH

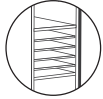

* Accepts collator 11" high

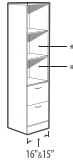
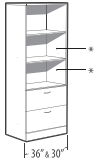

Two File Module with Open Shelves*

MODEL #	DIMENSIONS	WT/LB.	CUBIC FT.	1" TOP	1.5" TOP	GLAZE ADD	HP ADD
W x D x H (1.5" TOP)							
Z36L7EN	36 x 24 x 72.4	287	43.25	\$2489	\$2558	N/A	N/A
Z30L7EN	30 x 24 x 72.4	253	36.25	\$2287	\$2349	N/A	N/A
Z16L7EN	16 x 24 x 72.4	169	20.75	\$1499	\$1541	N/A	N/A
Z15L7EN	15 x 24 x 72.4	164	19.25	\$1455	\$1489	N/A	N/A
Z36M7EN	36 x 20 x 72.4	257	36.75	\$2336	\$2398	N/A	N/A
Z30M7EN	30 x 20 x 72.4	226	30.5	\$2144	\$2196	N/A	N/A
Z16M7EN	16 x 20 x 72.4	150	17.5	\$1377	\$1412	N/A	N/A
Z15M7EN	15 x 20 x 72.4	144	16.25	\$1338	\$1368	N/A	N/A
Z36S7EN	36 x 16 x 72.4	216	29.5	\$2104	\$2165	N/A	N/A
Z30S7EN	30 x 16 x 72.4	189	25	\$1904	\$1946	N/A	N/A
Z16S7EN	16 x 16 x 72.4	125	14	\$1271	\$1305	N/A	N/A
Z15S7EN	15 x 16 x 72.4	120	12.5	\$1256	\$1285	N/A	N/A

Three open shelves and two file drawers on bottom. **Includes two 3-position fixed/height adjustable shelves.** Lock secures all drawers. 36" and 30" wide models have front-to-back and side-to-side letter/legal filing capability. Side-to-side file bars included. Ganging hardware included with all units 24" wide or less and 41"H or taller. Shipped assembled in 1 carton.

- Lateral file drawer construction is for accommodating hanging files NOT for stacking materials on the drawer bottom.

WARDROBE CABINETS - 72" / 72.5" HIGH



Wardrobe Cabinet

W x D x H (1.5" TOP)							
Z36L7WA	36 x 24 x 72.4	252	43.25	\$2039	\$2108	N/A	N/A
Z30L7WA	30 x 24 x 72.4	218	36.25	\$1904	\$1966	N/A	N/A
Z36M7WA	36 x 20 x 72.4	227	36.75	\$1921	\$1983	N/A	N/A
Z30M7WA	30 x 20 x 72.4	196	30.5	\$1703	\$1755	N/A	N/A

Laminate doors are standard. Full length hanging rod included. **Includes one 3 fixed shelf** above hanging rod. Standard with lock. Shipped assembled in 1 carton.



Wardrobe Cabinet - LEFT

Z24L7WAL	24 x 24 x 72.4	191	29.75	\$1544	\$1595	N/A	N/A
Z21L7WAL	21 x 24 x 72.4	179	26	\$1489	\$1539	N/A	N/A
Z18L7WAL	18 x 24 x 72.4	159	22.75	\$1372	\$1414	N/A	N/A
Z16L7WAL	16 x 24 x 72.4	149	20.75	\$1313	\$1355	N/A	N/A
Z15L7WAL	15 x 24 x 72.4	145	19.25	\$1251	\$1285	N/A	N/A
Z12L7WAL	12 x 24 x 72.4	130	16	\$1163	\$1193	N/A	N/A
Z24M7WAL	24 x 20 x 72.4	171	25.25	\$1430	\$1472	N/A	N/A
Z21M7WAL	21 x 20 x 72.4	154	21.25	\$1373	\$1415	N/A	N/A
Z18M7WAL	18 x 20 x 72.4	140	19.25	\$1261	\$1296	N/A	N/A
Z16M7WAL	16 x 20 x 72.4	131	17.5	\$1208	\$1243	N/A	N/A
Z15M7WAL	15 x 20 x 72.4	126	16.25	\$1147	\$1177	N/A	N/A
Z12M7WAL	12 x 20 x 72.4	113	13.25	\$1073	\$1098	N/A	N/A

Laminate doors are standard. Full length hanging rod included. **Includes one 3 fixed shelf** above hanging rod. Standard with lock. Ganging hardware included with all units 24" wide or less and 41"H or taller. Shipped assembled in 1 carton.

Required specifications

- Top finish
- Top thickness/edge detail
- Base finish
- Handles

Optional specifications

- Key #
- Collator - position & finish*

WARDROBE CABINETS - 72" / 72.5" HIGH

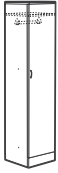

Wardrobe Cabinet - RIGHT

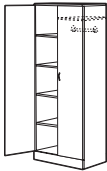

Glazed door option

Wardrobe Cabinet/Shelving Combo with Doors - LEFT*

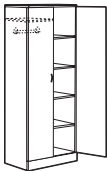

Glazed door option

Wardrobe Cabinet/Shelving Combo with Doors - RIGHT*

MODEL #	DIMENSIONS W x D x H (1.5" TOP)	WT/LB.	CUBIC FT.	1" TOP	1.5" TOP	GLAZE ADD	HP ADD
Z24L7WAR	24 x 24 x 72.4	191	29.75	\$1544	\$1595	N/A	N/A
Z21L7WAR	21 x 24 x 72.4	179	26	\$1489	\$1539	N/A	N/A
Z18L7WAR	18 x 24 x 72.4	159	22.75	\$1372	\$1414	N/A	N/A
Z16L7WAR	16 x 24 x 72.4	149	20.75	\$1313	\$1355	N/A	N/A
Z15L7WAR	15 x 24 x 72.4	145	19.25	\$1251	\$1285	N/A	N/A
Z12L7WAR	12 x 24 x 72.4	130	16	\$1163	\$1193	N/A	N/A
Z24M7WAR	24 x 20 x 72.4	171	25.25	\$1430	\$1472	N/A	N/A
Z21M7WAR	21 x 20 x 72.4	154	21.25	\$1373	\$1415	N/A	N/A
Z18M7WAR	18 x 20 x 72.4	140	19.25	\$1261	\$1296	N/A	N/A
Z16M7WAR	16 x 20 x 72.4	131	17.5	\$1208	\$1243	N/A	N/A
Z15M7WAR	15 x 20 x 72.4	126	16.25	\$1147	\$1177	N/A	N/A
Z12M7WAR	12 x 20 x 72.4	113	13.25	\$1073	\$1098	N/A	N/A

Laminate doors are standard. Full length hanging rod included. **Includes one fixed shelf** above hanging rod. Standard with lock. Ganging hardware included with all units 24" wide or less and 41"H or taller. Shipped assembled in 1 carton.

Z36L7DIL	36 x 24 x 72.4	300	43.25	\$2409	\$2478	\$1518	N/A
Z30L7DIL	30 x 24 x 72.4	263	36.25	\$2104	\$2166	\$1311	N/A
Z24L7DIL	24 x 24 x 72.4	232	29.75	\$1916	\$1967	\$1184	N/A
Z21L7DIL	21 x 24 x 72.4	201	26	\$1855	\$1905	\$1174	N/A
Z36M7DIL	36 x 20 x 72.4	276	36.75	\$2259	\$2321	\$1518	N/A
Z30M7DIL	30 x 20 x 72.4	242	30.5	\$1962	\$2014	\$1311	N/A
Z24M7DIL	24 x 20 x 72.4	214	25.25	\$1799	\$1841	\$1184	N/A
Z21M7DIL	21 x 20 x 72.4	196	21.25	\$1727	\$1769	\$1174	N/A

Laminate doors are standard. Storage compartment on **left includes four 3-position fixed/height adjustable shelves**. Wardrobe compartment on **right** includes hanging rod and one adjustable shelf above rod. Two locks secure storage and wardrobe compartments. Ganging hardware included with all units 24" wide or less and 41"H or taller. Shipped assembled in 1 carton.

Z36L7DIR	36 x 24 x 72.4	300	43.25	\$2409	\$2478	\$1518	N/A
Z30L7DIR	30 x 24 x 72.4	263	36.25	\$2104	\$2166	\$1311	N/A
Z24L7DIR	24 x 24 x 72.4	232	29.75	\$1916	\$1967	\$1184	N/A
Z21L7DIR	21 x 24 x 72.4	201	26	\$1855	\$1905	\$1174	N/A
Z36M7DIR	36 x 20 x 72.4	276	36.75	\$2259	\$2321	\$1518	N/A
Z30M7DIR	30 x 20 x 72.4	242	30.5	\$1962	\$2014	\$1311	N/A
Z24M7DIR	24 x 20 x 72.4	214	25.25	\$1799	\$1841	\$1184	N/A
Z21M7DIR	21 x 20 x 72.4	196	21.25	\$1727	\$1769	\$1174	N/A

Laminate doors are standard. Storage compartment on **right includes four 3-position fixed/height adjustable shelves**. Wardrobe compartment on **left** includes hanging rod and one adjustable shelf above rod. Two locks secure storage and wardrobe compartments. Ganging hardware included with all units 24" wide or less and 41"H or taller. Shipped assembled in 1 carton.

Required specifications

- Top finish
- Top thickness/edge detail
- Base finish
- Handles

Optional specifications

- Key #
- Glazed door*

WARDROBE CABINETS - 72" / 72.5" HIGH

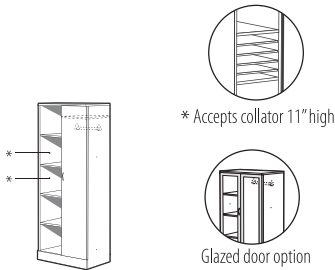

Wardrobe Cabinet/Open Shelving Combo - LEFT*

Shipped assembled in 1 carton.

MODEL #	DIMENSIONS	WT/LB.	CUBIC FT.	1" TOP	1.5" TOP	GLAZE ADD	HP ADD
W x D x H (1.5" TOP)							
Z36L7DINL	36 x 24 x 72.4	277	43.25	\$2171	\$2240	\$755	N/A
Z30L7DINL	30 x 24 x 72.4	245	36.25	\$1912	\$1974	\$653	N/A
Z24L7DINL	24 x 24 x 72.4	218	29.75	\$1737	\$1788	\$585	N/A
Z21L7DINL	21 x 24 x 72.4	189	26	\$1682	\$1732	\$581	N/A
Z36M7DINL	36 x 20 x 72.4	254	36.75	\$2023	\$2085	\$755	N/A
Z30M7DINL	30 x 20 x 72.4	223	30.5	\$1768	\$1820	\$653	N/A
Z24M7DINL	24 x 20 x 72.4	202	25.25	\$1624	\$1666	\$585	N/A
Z21M7DINL	21 x 20 x 72.4	184	21.25	\$1553	\$1595	\$581	N/A

Laminate door is standard on wardrobe section. Storage compartment on **left includes four 3-position fixed/height adjustable shelves**. Wardrobe compartment on **right** includes hanging rod and one adjustable shelf above rod. Single lock secures wardrobe compartment. Ganging hardware included with all units 24" wide or less and 41"H or taller.

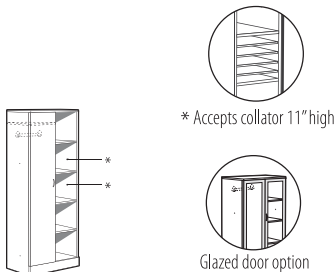

Wardrobe Cabinet/Open Shelving Combo - RIGHT*

Z36L7DINR	36 x 24 x 72.4	277	43.25	\$2171	\$2240	\$755	N/A
Z30L7DINR	30 x 24 x 72.4	245	36.25	\$1912	\$1974	\$653	N/A
Z24L7DINR	24 x 24 x 72.4	218	29.75	\$1737	\$1788	\$585	N/A
Z21L7DINR	21 x 24 x 72.4	189	26	\$1682	\$1732	\$581	N/A
Z36M7DINR	36 x 20 x 72.4	254	36.75	\$2023	\$2085	\$755	N/A
Z30M7DINR	30 x 20 x 72.4	223	30.5	\$1768	\$1820	\$653	N/A
Z24M7DINR	24 x 20 x 72.4	202	25.25	\$1624	\$1666	\$585	N/A
Z21M7DINR	21 x 20 x 72.4	184	21.25	\$1553	\$1595	\$581	N/A

Laminate door is standard on wardrobe section. Storage compartment on **right includes four 3-position fixed/height adjustable shelves**. Wardrobe compartment on **left** includes hanging rod and one adjustable shelf above rod. Single lock secures wardrobe compartment. Ganging hardware included with all units 24" wide or less and 41"H or taller. Shipped assembled in 1 carton.

PERSONAL TOWERS - 72" / 72.5" HIGH

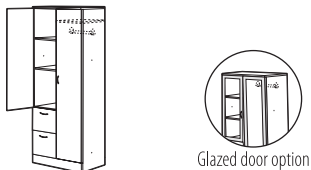

Personal Tower with Doors - LEFT**

W x D x H (1.5" TOP)							
Z36L7EL	36 x 24 x 72.4	324	43.25	\$2637	\$2706	\$1348	N/A
Z30L7EL	30 x 24 x 72.4	290	36.25	\$2418	\$2480	\$1233	N/A
Z24L7EL	24 x 24 x 72.4	261	29.75	\$2306	\$2357	\$1093	N/A
Z36M7EL	36 x 20 x 72.4	289	36.75	\$2468	\$2530	\$1348	N/A
Z30M7EL	30 x 20 x 72.4	259	30.5	\$2261	\$2313	\$1233	N/A
Z24M7EL	24 x 20 x 72.4	232	25.25	\$2153	\$2195	\$1093	N/A

Two file drawers on bottom. Laminate doors are standard. Storage compartment on **left includes two 3-position fixed/height adjustable shelves**. Wardrobe compartment on **right** includes hanging rod and one adjustable shelf above rod. Two upper locks (one per each hinged door) and one lower lock secures drawers, all keyed alike. Ganging hardware included with all units 24" wide or less and 41"H or taller. Shipped assembled in 1 carton.

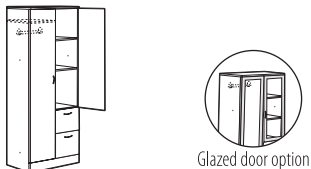

Personal Tower with Doors - RIGHT**

Z36L7ER	36 x 24 x 72.4	324	43.25	\$2637	\$2706	\$1348	N/A
Z30L7ER	30 x 24 x 72.4	290	36.25	\$2418	\$2480	\$1233	N/A
Z24L7ER	24 x 24 x 72.4	261	29.75	\$2306	\$2357	\$1093	N/A
Z36M7ER	36 x 20 x 72.4	289	36.75	\$2468	\$2530	\$1348	N/A
Z30M7ER	30 x 20 x 72.4	259	30.5	\$2261	\$2313	\$1233	N/A
Z24M7ER	24 x 20 x 72.4	232	25.25	\$2153	\$2195	\$1093	N/A

Two file drawers on bottom. Laminate doors are standard. Storage compartment on **right includes two 3-position fixed/height adjustable shelves**. Wardrobe compartment on **left** includes hanging rod and one adjustable shelf above rod. Two upper locks (one per each hinged door) and one lower lock secures drawers, all keyed alike. Ganging hardware included with all units 24" wide or less and 41"H or taller. Shipped assembled in 1 carton.

Required specifications

- Top finish
- Top thickness/edge detail
- Base finish
- Handles

Optional specifications

- Key #
- Box drawer - no upcharge**
- Collator - position & finish*
- Glazed door

PERSONAL TOWERS - 72" / 72.5" HIGH

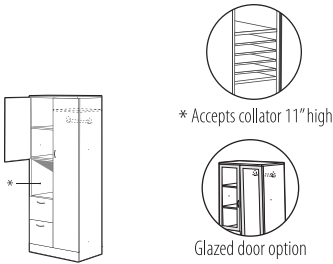

Personal Tower with Doors and Cavity - LEFT

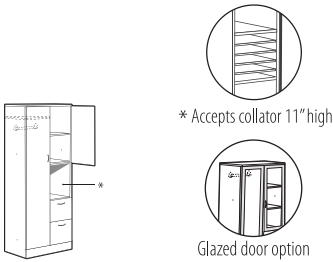

Personal Tower with Doors and Cavity - RIGHT

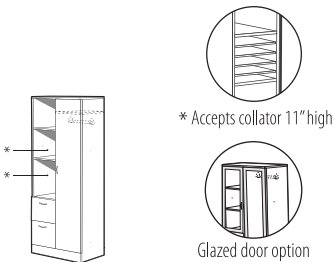

Personal Tower with Open Shelves - LEFT

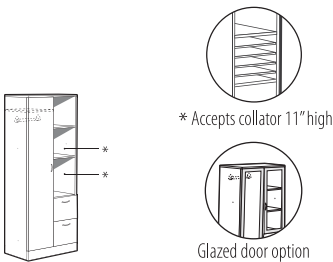

Personal Tower with Open Shelves - RIGHT

MODEL #	DIMENSIONS W x D x H (1.5" TOP)	WT/LB.	CUBIC FT.	1" TOP	1.5" TOP	GLAZE ADD	HP ADD
Z36L7ECL	36 x 24 x 72.4	320	43.25	\$2621	\$2690	\$1222	N/A
Z30L7ECL	30 x 24 x 72.4	287	36.25	\$2407	\$2469	\$1109	N/A
Z24L7ECL	24 x 24 x 72.4	257	29.75	\$2278	\$2329	\$968	N/A
Z36M7ECL	36 x 20 x 72.4	286	36.75	\$2427	\$2489	\$1222	N/A
Z30M7ECL	30 x 20 x 72.4	256	30.5	\$2221	\$2273	\$1109	N/A
Z24M7ECL	24 x 20 x 72.4	228	25.25	\$2111	\$2153	\$968	N/A

Two file drawers on bottom. Laminate doors are standard. Storage compartment on **left includes one 3-position fixed/height adjustable shelf**. Wardrobe compartment on **right** includes hanging rod and one adjustable shelf above rod. Two upper locks (one per each hinged door) and one lower lock secures drawers, all keyed alike. Ganging hardware included with all units 24" wide or less and 41"H or taller. Shipped assembled in 1 carton.

Z36L7ECR	36 x 24 x 72.4	320	43.25	\$2621	\$2690	\$1222	N/A
Z30L7ECR	30 x 24 x 72.4	287	36.25	\$2407	\$2469	\$1109	N/A
Z24L7ECR	24 x 24 x 72.4	257	29.75	\$2278	\$2329	\$968	N/A
Z36M7ECR	36 x 20 x 72.4	286	36.75	\$2427	\$2489	\$1222	N/A
Z30M7ECR	30 x 20 x 72.4	256	30.5	\$2221	\$2273	\$1109	N/A
Z24M7ECR	24 x 20 x 72.4	228	25.25	\$2111	\$2153	\$968	N/A

Two file drawers on bottom. Laminate doors are standard. Storage compartment on **right includes one 3-position fixed/height adjustable shelf**. Wardrobe compartment on **left** includes hanging rod and one adjustable shelf above rod. Two upper locks (one per each hinged door) and one lower lock secures drawers, all keyed alike. Ganging hardware included with all units 24" wide or less and 41"H or taller. Shipped assembled in 1 carton.

Z36L7ENL	36 x 24 x 72.4	310	43.25	\$2493	\$2562	\$761	N/A
Z30L7ENL	30 x 24 x 72.4	278	36.25	\$2275	\$2337	\$648	N/A
Z24L7ENL	24 x 24 x 72.4	248	29.75	\$2160	\$2211	\$505	N/A
Z36M7ENL	36 x 20 x 72.4	275	36.75	\$2308	\$2370	\$761	N/A
Z30M7ENL	30 x 20 x 72.4	247	30.5	\$2105	\$2157	\$648	N/A
Z24M7ENL	24 x 20 x 72.4	219	25.25	\$2010	\$2052	\$505	N/A

Two file drawers on bottom. Laminate door is standard on wardrobe section. Storage compartment on **left includes two 3-position fixed/height adjustable shelves**. Wardrobe compartment on **right** includes hanging rod and one adjustable shelf above rod. Upper lock secures wardrobe compartment. Lower lock secures all drawers. Ganging hardware included with all units 24" wide or less and 41"H or taller. Shipped assembled in 1 carton.

Z36L7ENR	36 x 24 x 72.4	310	43.25	\$2493	\$2562	\$761	N/A
Z30L7ENR	30 x 24 x 72.4	278	36.25	\$2275	\$2337	\$648	N/A
Z24L7ENR	24 x 24 x 72.4	248	29.75	\$2160	\$2211	\$505	N/A
Z36M7ENR	36 x 20 x 72.4	275	36.75	\$2308	\$2370	\$761	N/A
Z30M7ENR	30 x 20 x 72.4	247	30.5	\$2105	\$2157	\$648	N/A
Z24M7ENR	24 x 20 x 72.4	219	25.25	\$2010	\$2052	\$505	N/A

Two file drawers on bottom. Laminate door is standard on wardrobe section. Storage compartment on **right includes two 3-position fixed/height adjustable shelves**. Wardrobe compartment on **left** includes hanging rod and one adjustable shelf above rod. Upper lock secures wardrobe compartment. Lower lock secures all drawers. Ganging hardware included with all units 24" wide or less and 41"H or taller. Shipped assembled in 1 carton.

Required specifications

- Top finish
- Top thickness/edge detail
- Base finish
- Handles

Optional specifications

- Key #
- Box drawer - no upcharge
- Collator - position & finish
- Glazed door

PERSONAL TOWERS - 72" / 72.5" HIGH **MODEL #** **DIMENSIONS** **WT/LB.** **CUBIC FT.** **1" TOP** **1.5" TOP** **GLAZE ADD** **HP ADD**

W x D x H (1.5" TOP)

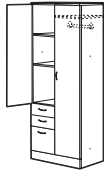

Glazed door option

Personal Tower with Doors - LEFT

Two box and one file drawer on bottom. Laminate doors are standard. Storage compartment on **left** includes **two 3-position fixed/height adjustable shelves**. Wardrobe compartment on **right** includes hanging rod and one adjustable shelf above rod. Two upper locks (one per each hinged door) and one lower lock secures drawers, all keyed alike. Ganging hardware included with all units 24" wide or less and 41"H or taller. Shipped assembled in 1 carton.

Z36L7BFL	36 x 24 x 72.4	327	43.25	\$2769	\$2838	\$1348	N/A
Z30L7BFL	30 x 24 x 72.4	293	36.25	\$2558	\$2620	\$1233	N/A
Z24L7BFL	24 x 24 x 72.4	262	29.75	\$2408	\$2459	\$1093	N/A
Z36M7BFL	36 x 20 x 72.4	292	36.75	\$2598	\$2660	\$1348	N/A
Z30M7BFL	30 x 20 x 72.4	263	30.5	\$2422	\$2474	\$1162	N/A
Z24M7BFL	24 x 20 x 72.4	233	25.25	\$2254	\$2296	\$1093	N/A



Glazed door option

Personal Tower with Doors - RIGHT

Two box and one file drawer on bottom. Laminate doors are standard. Storage compartment on **right** includes **two 3-position fixed/height adjustable shelves**. Wardrobe compartment on **left** includes hanging rod and one adjustable shelf above rod. Two upper locks (one per each hinged door) and one lower lock secures drawers, all keyed alike. Ganging hardware included with all units 24" wide or less and 41"H or taller. Shipped assembled in 1 carton.

Z36L7BFCL	36 x 24 x 72.4	318	43.25	\$2741	\$2783	\$1222	N/A
Z30L7BFCL	30 x 24 x 72.4	287	36.25	\$2531	\$2565	\$1109	N/A
Z24L7BFCL	24 x 24 x 72.4	259	29.75	\$2366	\$2417	\$968	N/A
Z36M7BFCL	36 x 20 x 72.4	289	36.75	\$2550	\$2612	\$1222	N/A
Z30M7BFCL	30 x 20 x 72.4	259	30.5	\$2375	\$2427	\$1109	N/A
Z24M7BFCL	24 x 20 x 72.4	229	25.25	\$2214	\$2256	\$968	N/A

Two box and one file drawer on bottom. Laminate doors are standard. Storage compartment on **left** includes **one fixed shelf and one 3-position fixed/height adjustable shelf**. Wardrobe compartment on **right** includes hanging rod and one adjustable shelf above rod. Two upper locks (one per each hinged door) and one lower lock secures drawers, all keyed alike. Ganging hardware included with all units 24" wide or less and 41"H or taller. Shipped assembled in 1 carton.

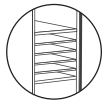
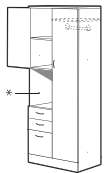

* Accepts collator 11" high



Glazed door option

Personal Tower with Doors Cavity - LEFT*

Z36L7BFCL	36 x 24 x 72.4	318	43.25	\$2741	\$2783	\$1222	N/A
Z30L7BFCL	30 x 24 x 72.4	287	36.25	\$2531	\$2565	\$1109	N/A
Z24L7BFCL	24 x 24 x 72.4	259	29.75	\$2366	\$2417	\$968	N/A
Z36M7BFCL	36 x 20 x 72.4	289	36.75	\$2550	\$2612	\$1222	N/A
Z30M7BFCL	30 x 20 x 72.4	259	30.5	\$2375	\$2427	\$1109	N/A
Z24M7BFCL	24 x 20 x 72.4	229	25.25	\$2214	\$2256	\$968	N/A

Two box and one file drawer on bottom. Laminate doors are standard. Storage compartment on **right** includes **one fixed shelf and 3-position fixed/height adjustable shelf**. Wardrobe compartment on **left** includes hanging rod and one adjustable shelf above rod. Two upper locks (one per each hinged door) and one lower lock secures drawers, all keyed alike. Ganging hardware included with all units 24" wide or less and 41"H or taller. Shipped assembled in 1 carton.

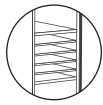
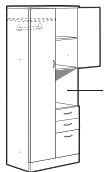

* Accepts collator 11" high



Glazed door option

Personal Tower with Doors Cavity - RIGHT*

Required specifications

- Top finish
- Top thickness/edge detail
- Base finish
- Handles

Optional specifications

- Key #
- Box drawer - no upcharge
- Collator - position & finish*
- Glazed door

PERSONAL TOWERS - 72" / 72.5" HIGH

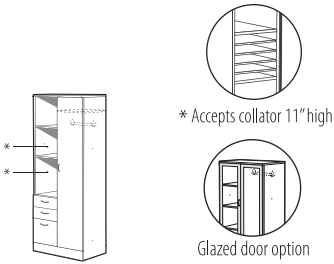

Personal Tower with Open Shelves - LEFT*

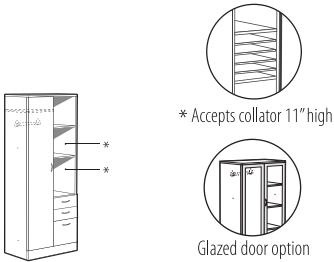

Personal Tower with Open Shelves - RIGHT*

MODEL #	DIMENSIONS W x D x H (1.5" TOP)	WT/LB.	CUBIC FT.	1" TOP	1.5" TOP	GLAZE ADD	HP ADD
Z36L7BFNL	36 x 24 x 72.4	309	43.25	\$2611	\$2659	\$761	N/A
Z30L7BFNL	30 x 24 x 72.4	277	36.25	\$2401	\$2436	\$648	N/A
Z24L7BFNL	24 x 24 x 72.4	249	29.75	\$2208	\$2259	\$505	N/A
Z36M7BFNL	36 x 20 x 72.4	274	36.75	\$2413	\$2475	\$761	N/A
Z30M7BFNL	30 x 20 x 72.4	246	30.5	\$2241	\$2293	\$648	N/A
Z24M7BFNL	24 x 20 x 72.4	220	25.25	\$2055	\$2097	\$505	N/A

Two box and one file drawer on bottom. Laminate doors are standard. Storage compartment on **left** includes **two 3-position fixed/height adjustable shelves**. Wardrobe compartment on **right** includes hanging rod and **one adjustable shelf** above rod. Upper lock secures wardrobe compartment. Lower lock secures all drawers. Ganging hardware included with all units 24" wide or less and 41"H or taller. Shipped assembled in 1 carton.

Z36L7BFNR	36 x 24 x 72.4	309	43.25	\$2611	\$2659	\$761	N/A
Z30L7BFNR	30 x 24 x 72.4	277	36.25	\$2401	\$2436	\$648	N/A
Z24L7BFNR	24 x 24 x 72.4	249	29.75	\$2208	\$2259	\$505	N/A
Z36M7BFNR	36 x 20 x 72.4	274	36.75	\$2413	\$2475	\$761	N/A
Z30M7BFNR	30 x 20 x 72.4	246	30.5	\$2241	\$2293	\$648	N/A
Z24M7BFNR	24 x 20 x 72.4	220	25.25	\$2055	\$2097	\$505	N/A

Two box and one file drawer on bottom. Laminate doors are standard. Storage compartment on **right** includes **two 3-position fixed/height adjustable shelves**. Wardrobe compartment on **left** includes hanging rod and **one adjustable shelf** above rod. Upper lock secures wardrobe compartment. Lower lock secures all drawers. Ganging hardware included with all units 24" wide or less and 41"H or taller. Shipped assembled in 1 carton.

Required specifications

- Top finish
- Top thickness/edge detail
- Base finish
- Handles

Optional specifications

- Key #
- Box drawer - no upcharge
- Collator - position & finish*
- Glazed door

STORAGE MODULES - 84.5" / 85" HIGH **MODEL #** **DIMENSIONS** **WT/LB.** **CUBIC FT.** **1" TOP** **1.5" TOP** **GLAZE ADD** **HP ADD**



Glazed door option

Storage Cabinet with Doors

	W x D x H (1.5" TOP)							
Z36L8SH	36 x 24 x 84.9		333	50	\$2571	\$2640	\$1845	N/A
Z30L8SH	30 x 24 x 84.9		291	42	\$2277	\$2339	\$1579	N/A
Z36M8SH	36 x 20 x 84.9		299	42.25	\$2367	\$2429	\$1845	N/A
Z30M8SH	30 x 20 x 84.9		259	35.5	\$2116	\$2168	\$1579	N/A
Z36S8SH	36 x 16 x 84.9		259	34	\$2134	\$2195	\$1845	N/A
Z30S8SH	30 x 16 x 84.9		225	29	\$1901	\$1943	\$1579	N/A

Laminate doors are standard. **Includes four 3-position fixed/height adjustable shelves.** Standard with lock. Ganging hardware included with all units 24" wide or less and 41"H or taller. Shipped assembled in 1 carton.

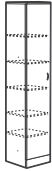

Glazed door option

Storage Cabinet with Door - LEFT

Z21L8SHL	21 x 24 x 84.9		227	30.25	\$1859	\$1909	\$1030	N/A
Z18L8SHL	18 x 24 x 84.9		206	26.25	\$1748	\$1790	\$919	N/A
Z16L8SHL	16 x 24 x 84.9		187	24	\$1641	\$1683	\$911	N/A
Z15L8SHL	15 x 24 x 84.9		182	22.5	\$1618	\$1652	\$785	N/A
Z12L8SHL	12 x 24 x 84.9		164	18.5	\$1506	\$1536	\$700	N/A
Z21M8SHL	21 x 20 x 84.9		202	25.5	\$1679	\$1721	\$1030	N/A
Z18M8SHL	18 x 20 x 84.9		181	22.25	\$1603	\$1638	\$919	N/A
Z16M8SHL	16 x 20 x 84.9		169	20.25	\$1506	\$1541	\$911	N/A
Z15M8SHL	15 x 20 x 84.9		163	19	\$1440	\$1470	\$785	N/A
Z12M8SHL	12 x 20 x 84.9		145	15.75	\$1335	\$1360	\$700	N/A
Z21S8SHL	21 x 16 x 84.9		172	21	\$1535	\$1568	\$1030	N/A
Z18S8SHL	18 x 16 x 84.9		154	18	\$1432	\$1466	\$919	N/A
Z16S8SHL	16 x 16 x 84.9		143	16.5	\$1344	\$1378	\$911	N/A
Z15S8SHL	15 x 16 x 84.9		138	15.5	\$1282	\$1311	\$785	N/A
Z12S8SHL	12 x 16 x 84.9		121	13	\$1179	\$1204	\$700	N/A

Laminate doors are standard. **Includes four 3-position fixed/height adjustable shelves.** Standard with lock. Ganging hardware included with all units 24" wide or less and 41"H or taller. Shipped assembled in 1 carton.

Required specifications

- Top finish
- Top thickness/edge detail
- Base finish
- Handles

Optional specifications

- Key #
- Collator - position & finish*
- Glazed door

STORAGE MODULES - 84.5" / 85" HIGH



Glazed door option

Storage Cabinet with Door - RIGHT

MODEL #	DIMENSIONS W x D x H (1.5" TOP)	WT/LB.	CUBIC FT.	1" TOP	1.5" TOP	GLAZE ADD	HP ADD
Z21L8SHR	21 x 24 x 84.9	227	30.25	\$1859	\$1909	\$1030	N/A
Z18L8SHR	18 x 24 x 84.9	206	26.25	\$1748	\$1790	\$919	N/A
Z16L8SHR	16 x 24 x 84.9	187	24	\$1641	\$1683	\$911	N/A
Z15L8SHR	15 x 24 x 84.9	182	22.5	\$1618	\$1652	\$785	N/A
Z12L8SHR	12 x 24 x 84.9	164	18.5	\$1506	\$1536	\$700	N/A
Z21M8SHR	21 x 20 x 84.9	202	25.5	\$1679	\$1721	\$1030	N/A
Z18M8SHR	18 x 20 x 84.9	181	22.25	\$1603	\$1638	\$919	N/A
Z16M8SHR	16 x 20 x 84.9	169	20.25	\$1506	\$1541	\$911	N/A
Z15M8SHR	15 x 20 x 84.9	163	19	\$1440	\$1470	\$785	N/A
Z12M8SHR	12 x 20 x 84.9	145	15.75	\$1335	\$1360	\$700	N/A
Z21S8SHR	21 x 16 x 84.9	172	21	\$1535	\$1568	\$1030	N/A
Z18S8SHR	18 x 16 x 84.9	154	18	\$1432	\$1466	\$919	N/A
Z16S8SHR	16 x 16 x 84.9	143	16.5	\$1344	\$1378	\$911	N/A
Z15S8SHR	15 x 16 x 84.9	138	15.5	\$1282	\$1311	\$785	N/A
Z12S8SHR	12 x 16 x 84.9	121	13	\$1179	\$1204	\$700	N/A

Laminate doors are standard. **Includes four 3-position fixed/height adjustable shelves.** Standard with lock. Ganging hardware included with all units 24" wide or less and 41"H or taller. Shipped assembled in 1 carton.

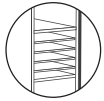

* Accepts collator 11" high

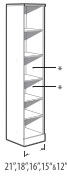
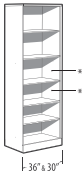

Open Storage Cabinet*

Z36L8SHN	36 x 24 x 84.9	281	50	\$1995	\$2064	N/A	N/A
Z30L8SHN	30 x 24 x 84.9	247	42	\$1773	\$1835	N/A	N/A
Z21L8SHN	21 x 24 x 84.9	228	30.25	\$1538	\$1588	N/A	N/A
Z18L8SHN	18 x 24 x 84.9	207	26.25	\$1456	\$1498	N/A	N/A
Z16L8SHN	16 x 24 x 84.9	189	24	\$1349	\$1391	N/A	N/A
Z15L8SHN	15 x 24 x 84.9	183	22.5	\$1329	\$1363	N/A	N/A
Z12L8SHN	12 x 24 x 84.9	165	18.5	\$1278	\$1308	N/A	N/A
Z36M8SHN	36 x 20 x 84.9	246	42.25	\$1796	\$1858	N/A	N/A
Z30M8SHN	30 x 20 x 84.9	215	35.5	\$1617	\$1669	N/A	N/A
Z21M8SHN	21 x 20 x 84.9	170	25.5	\$1357	\$1399	N/A	N/A
Z18M8SHN	18 x 20 x 84.9	155	22.25	\$1313	\$1348	N/A	N/A
Z16M8SHN	16 x 20 x 84.9	146	20.25	\$1218	\$1253	N/A	N/A
Z15M8SHN	15 x 20 x 84.9	141	19	\$1189	\$1219	N/A	N/A
Z12M8SHN	12 x 20 x 84.9	126	15.75	\$1106	\$1131	N/A	N/A
Z36S8SHN	36 x 16 x 84.9	207	34	\$1560	\$1621	N/A	N/A
Z30S8SHN	30 x 16 x 84.9	181	29	\$1400	\$1442	N/A	N/A
Z21S8SHN	21 x 16 x 84.9	142	21	\$1211	\$1244	N/A	N/A
Z18S8SHN	18 x 16 x 84.9	128	18	\$1142	\$1176	N/A	N/A
Z16S8SHN	16 x 16 x 84.9	120	16.5	\$1055	\$1089	N/A	N/A
Z15S8SHN	15 x 16 x 84.9	116	15.5	\$1029	\$1058	N/A	N/A
Z12S8SHN	12 x 16 x 84.9	103	13	\$952	\$977	N/A	N/A

Four adjustable shelves. Ganging hardware included with all units 24" wide or less and 41"H or taller. Shipped assembled in 1 carton.



Glazed door option

Two File Module with Doors

Z36L8E	36 x 24 x 84.9	365	50	\$3189	\$3258	\$1378	N/A
Z30L8E	30 x 24 x 84.9	307	42	\$2902	\$2964	\$1188	N/A
Z36M8E	36 x 20 x 84.9	323	42.25	\$2994	\$3056	\$1378	N/A
Z30M8E	30 x 20 x 84.9	285	35.5	\$2761	\$2813	\$1188	N/A
Z36S8E	36 x 16 x 84.9	285	34	\$2738	\$2799	\$1378	N/A
Z30S8E	30 x 16 x 84.9	245	29	\$2472	\$2514	\$1188	N/A

Two lateral file drawers. Laminate doors are standard. **Includes two adjustable shelves.** Upper lock secures storage compartment. Lower lock secures two file drawers. Front-to-back and side-to-side letter/legal filing capability. Side-to-side file bars included. Shipped assembled in 1 carton.

- Lateral file drawer construction is for accommodating hanging files NOT for stacking materials on the drawer bottom.

Required specifications

Top finish
Top thickness/edge detail
Base finish
Handles

Optional specifications

Key #
Collator - position & finish*
Glazed door (not Zxxx8SHN)

STORAGE MODULES - 84.5" / 85" HIGH **MODEL #** **DIMENSIONS** **WT/LB.** **CUBIC FT.** **1" TOP** **1.5" TOP** **GLAZE ADD** **HP ADD**



Glazed door option

Two File Module with Door - LEFT*

	W x D x H (1.5" TOP)							
Z16L8EL	16 x 24	84.9	206	24	\$1896	\$1938	\$679	N/A
Z15L8EL	15 x 24	84.9	192	22.5	\$1844	\$1878	\$589	N/A
Z16M8EL	16 x 20	84.9	186	20.25	\$1773	\$1808	\$679	N/A
Z15M8EL	15 x 20	84.9	180	19	\$1709	\$1739	\$589	N/A
Z16S8EL	16 x 16	84.9	156	16.5	\$1615	\$1649	\$679	N/A
Z15S8EL	15 x 16	84.9	149	15.5	\$1561	\$1590	\$589	N/A

Two file drawers on bottom. Laminate door is standard. **Includes two 3-position fixed/height adjustable shelves.** Upper lock secures storage compartment. Lower lock secures two file drawers. Ganging hardware included with all units 24" wide or less and 41"H or taller. Shipped assembled in 1 carton.



Glazed door option

Two File Module with Door - RIGHT*

Z16L8ER	16 x 24	84.9	206	24	\$1896	\$1938	\$679	N/A
Z15L8ER	15 x 24	84.9	192	22.5	\$1844	\$1878	\$589	N/A
Z16M8ER	16 x 20	84.9	186	20.25	\$1773	\$1808	\$679	N/A
Z15M8ER	15 x 20	84.9	180	19	\$1709	\$1739	\$589	N/A
Z16S8ER	16 x 16	84.9	156	16.5	\$1615	\$1649	\$679	N/A
Z15S8ER	15 x 16	84.9	149	15.5	\$1561	\$1590	\$589	N/A

Two file drawers on bottom. Laminate door is standard. **Includes two 3-position fixed/height adjustable shelves.** Upper lock secures storage compartment. Lower lock secures two file drawers. Ganging hardware included with all units 24" wide or less and 41"H or taller. Shipped assembled in 1 carton.

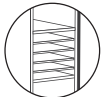

* Accepts collator 11" high

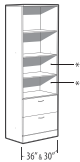

Two File Module with Open Shelves**

Z36L8EN	36 x 24	84.9	330	50	\$2734	\$2803	N/A	N/A
Z30L8EN	30 x 24	84.9	276	42	\$2503	\$2565	N/A	N/A
Z16L8EN	16 x 24	84.9	192	24	\$1668	\$1710	N/A	N/A
Z15L8EN	15 x 24	84.9	178	22.5	\$1642	\$1676	N/A	N/A
Z36M8EN	36 x 20	84.9	286	42.25	\$2539	\$2601	N/A	N/A
Z30M8EN	30 x 20	84.9	254	35.5	\$2363	\$2415	N/A	N/A
Z16M8EN	16 x 20	84.9	170	20.25	\$1544	\$1579	N/A	N/A
Z15M8EN	15 x 20	84.9	164	19	\$1506	\$1536	N/A	N/A
Z36S8EN	36 x 16	84.9	247	34	\$2110	\$2171	N/A	N/A
Z30S8EN	30 x 16	84.9	213	29	\$1902	\$1944	N/A	N/A
Z16S8EN	16 x 16	84.9	139	16.5	\$1383	\$1417	N/A	N/A
Z15S8EN	15 x 16	84.9	134	15.5	\$1357	\$1386	N/A	N/A

Four open shelves and two file drawers on bottom. **Includes one 3-position fixed/height adjustable shelf.** Lock secures all drawers. 36" and 30" wide models have front-to-back and side-to-side letter/legal filing capability. Side-to-side file bars included. Ganging hardware included with all units 24" wide or less and 41"H or taller. Shipped assembled in 1 carton.

- Lateral file drawer construction is for accommodating hanging files NOT for stacking materials on the drawer bottom.

Required specifications

- Top finish
- Top thickness/edge detail
- Base finish
- Handles (not Zxxx8SHN)

Optional specifications

- Key # (not Zxxx8SHN)
- Box drawer - no upcharge
- Collator - position & finish**
- Glazed door*

WARDROBE CABINETS - 84.5" / 85" HIGH



Wardrobe Cabinet

MODEL #	DIMENSIONS W x D x H (1.5" TOP)	WT/LB.	CUBIC FT.	1" TOP	1.5" TOP	GLAZE ADD	HP ADD
Z36L8WA	36 x 24 x 84.9	291	50	\$2383	\$2452	N/A	N/A
Z30L8WA	30 x 24 x 84.9	256	42	\$2140	\$2202	N/A	N/A
Z36M8WA	36 x 20 x 84.9	265	42.25	\$2223	\$2285	N/A	N/A
Z30M8WA	30 x 20 x 84.9	231	35.5	\$2014	\$2066	N/A	N/A

Laminate doors are standard. Full length hanging rod included. **One adjustable shelf** above hanging rod. Standard with lock. Shipped assembled in 1 carton.



Wardrobe Cabinet - LEFT

Z24L8WAL	24 x 24 x 84.9	221	34.25	\$1784	\$1835	N/A	N/A
Z21L8WAL	21 x 24 x 84.9	192	30.25	\$1718	\$1768	N/A	N/A
Z18L8WAL	18 x 24 x 84.9	185	26.25	\$1601	\$1643	N/A	N/A
Z16L8WAL	16 x 24 x 84.9	172	24	\$1529	\$1571	N/A	N/A
Z15L8WAL	15 x 24 x 84.9	162	22.5	\$1485	\$1519	N/A	N/A
Z12L8WAL	12 x 24 x 84.9	150	18.5	\$1366	\$1396	N/A	N/A
Z24M8WAL	24 x 20 x 84.9	197	28.5	\$1660	\$1702	N/A	N/A
Z21M8WAL	21 x 20 x 84.9	183	25.5	\$1599	\$1641	N/A	N/A
Z18M8WAL	18 x 20 x 84.9	165	22.25	\$1483	\$1518	N/A	N/A
Z16M8WAL	16 x 20 x 84.9	154	20.25	\$1415	\$1450	N/A	N/A
Z15M8WAL	15 x 20 x 84.9	149	19	\$1357	\$1387	N/A	N/A
Z12M8WAL	12 x 20 x 84.9	133	15.75	\$1263	\$1288	N/A	N/A

Laminate doors are standard. Full length hanging rod included. **One adjustable shelf** above hanging rod. Standard with lock. Ganging hardware included with all units 24" wide or less and 41"H or taller. Shipped assembled in 1 carton.



Wardrobe Cabinet - RIGHT

Z24L8WAR	24 x 24 x 84.9	221	34.25	\$1784	\$1835	N/A	N/A
Z21L8WAR	21 x 24 x 84.9	192	30.25	\$1718	\$1768	N/A	N/A
Z18L8WAR	18 x 24 x 84.9	185	26.25	\$1601	\$1643	N/A	N/A
Z16L8WAR	16 x 24 x 84.9	172	24	\$1529	\$1571	N/A	N/A
Z15L8WAR	15 x 24 x 84.9	162	22.5	\$1485	\$1519	N/A	N/A
Z12L8WAR	12 x 24 x 84.9	150	18.5	\$1366	\$1396	N/A	N/A
Z24M8WAR	24 x 20 x 84.9	197	28.5	\$1660	\$1702	N/A	N/A
Z21M8WAR	21 x 20 x 84.9	183	25.5	\$1599	\$1641	N/A	N/A
Z18M8WAR	18 x 20 x 84.9	165	22.25	\$1483	\$1518	N/A	N/A
Z16M8WAR	16 x 20 x 84.9	154	20.25	\$1415	\$1450	N/A	N/A
Z15M8WAR	15 x 20 x 84.9	149	19	\$1357	\$1387	N/A	N/A
Z12M8WAR	12 x 20 x 84.9	133	15.75	\$1263	\$1288	N/A	N/A

Laminate doors are standard. Full length hanging rod included. **One adjustable shelf** above hanging rod. Standard with lock. Ganging hardware included with all units 24" wide or less and 41"H or taller. Shipped assembled in 1 carton.



Glazed door option

Wardrobe Cabinet/Shelving Combo with Doors - LEFT*

Z36L8DIL	36 x 24 x 84.9	339	50	\$2759	\$2828	\$1845	N/A
Z30L8DIL	30 x 24 x 84.9	301	42	\$2417	\$2479	\$1579	N/A
Z24L8DIL	24 x 24 x 84.9	269	34.25	\$2189	\$2240	\$1449	N/A
Z21L8DIL	21 x 24 x 84.9	252	30.25	\$2115	\$2145	\$1438	N/A
Z36M8DIL	36 x 20 x 84.9	306	42.25	\$2594	\$2656	\$1845	N/A
Z30M8DIL	30 x 20 x 84.9	266	35.5	\$2285	\$2337	\$1579	N/A
Z24M8DIL	24 x 20 x 84.9	233	28.5	\$2061	\$2103	\$1449	N/A
Z21M8DIL	21 x 20 x 84.9	215	25.5	\$1961	\$2013	\$1438	N/A

Laminate doors are standard. Storage compartment on **left includes five adjustable shelves**. Wardrobe compartment on **right** includes hanging rod and **one adjustable shelf** above rod. Storage and wardrobe compartments lock independently. Each door lock keyed alike. Ganging hardware included with all units 24" wide or less and 41"H or taller. Shipped assembled in 1 carton.

Required specifications

- Top finish
- Top thickness/edge detail
- Base finish
- Handles

Optional specifications

- Key #
- Glazed door*

WARDROBE CABINETS - 84.5" / 85" HIGH **MODEL #** **DIMENSIONS** **WT/LB.** **CUBIC FT.** **1" TOP** **1.5" TOP** **GLAZE ADD** **HP ADD**



Glazed door option

Wardrobe Cabinet/Shelving Combo with Doors - RIGHT

W x D x H (1.5" TOP)

Z36L8DIR	36 x 24 x 84.9	339	50	\$2759	\$2828	\$1845	N/A
Z30L8DIR	30 x 24 x 84.9	301	42	\$2417	\$2479	\$1579	N/A
Z24L8DIR	24 x 24 x 84.9	269	34.25	\$2189	\$2240	\$1449	N/A
Z21L8DIR	21 x 24 x 84.9	252	30.25	\$2115	\$2145	\$1438	N/A
Z36M8DIR	36 x 20 x 84.9	306	42.25	\$2594	\$2656	\$1845	N/A
Z30M8DIR	30 x 20 x 84.9	266	35.5	\$2285	\$2337	\$1579	N/A
Z24M8DIR	24 x 20 x 84.9	233	28.5	\$2061	\$2103	\$1449	N/A
Z21M8DIR	21 x 20 x 84.9	215	25.5	\$1961	\$2013	\$1438	N/A

Laminate doors are standard. Storage compartment on **right includes five adjustable shelves**. Wardrobe compartment on **left** includes hanging rod and **one adjustable shelf** above rod. Storage and wardrobe compartments lock independently. Each door lock keyed alike. Ganging hardware included with all units 24" wide or less and 41"H or taller. Shipped assembled in 1 carton.

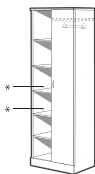

* Accepts collator 11" high



Glazed door option

Wardrobe Cabinet/Open Shelving Combo - LEFT*

Z36L8DINL	36 x 24 x 84.9	312	50	\$2468	\$2537	\$919	N/A
Z30L8DINL	30 x 24 x 84.9	278	42	\$2165	\$2227	\$785	N/A
Z24L8DINL	24 x 24 x 84.9	245	34.25	\$1981	\$2032	\$700	N/A
Z21L8DINL	21 x 24 x 84.9	236	30.25	\$1929	\$1951	\$695	N/A
Z36M8DINL	36 x 20 x 84.9	275	42.25	\$2305	\$2367	\$919	N/A
Z30M8DINL	30 x 20 x 84.9	243	35.5	\$2035	\$2087	\$785	N/A
Z24M8DINL	24 x 20 x 84.9	215	28.5	\$1855	\$1897	\$700	N/A
Z21M8DINL	21 x 20 x 84.9	199	25.5	\$1771	\$1813	\$695	N/A

Laminate door is standard on wardrobe section. Storage compartment on **left includes five adjustable shelves**. Wardrobe compartment on **right** includes hanging rod and **one adjustable shelf** above rod. Single lock secures wardrobe compartment. Ganging hardware included with all units 24" wide or less and 41"H or taller. Shipped assembled in 1 carton.

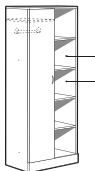

* Accepts collator 11" high



Glazed door option

Wardrobe Cabinet/Open Shelving Combo - RIGHT*

Z36L8DINR	36 x 24 x 84.9	312	50	\$2468	\$2537	\$919	N/A
Z30L8DINR	30 x 24 x 84.9	278	42	\$2165	\$2227	\$785	N/A
Z24L8DINR	24 x 24 x 84.9	245	34.25	\$1981	\$2032	\$700	N/A
Z21L8DINR	21 x 24 x 84.9	236	30.25	\$1929	\$1951	\$695	N/A
Z36M8DINR	36 x 20 x 84.9	275	42.25	\$2305	\$2367	\$919	N/A
Z30M8DINR	30 x 20 x 84.9	243	35.5	\$2035	\$2087	\$785	N/A
Z24M8DINR	24 x 20 x 84.9	215	28.5	\$1855	\$1897	\$700	N/A
Z21M8DINR	21 x 20 x 84.9	199	25.5	\$1771	\$1813	\$695	N/A

Laminate door is standard on wardrobe section. Storage compartment on **right includes five adjustable shelves**. Wardrobe compartment on **left** includes hanging rod and **one adjustable shelf** above rod. Single lock secures wardrobe compartment. Ganging hardware included with all units 24" wide or less and 41"H or taller. Shipped assembled in 1 carton.

Required specifications

- Top finish
- Top thickness/edge detail
- Base finish
- Handles

Optional specifications

- Key #
- Collator - position & finish*
- Glazed door

PERSONAL TOWERS - 84.5" / 85" HIGH

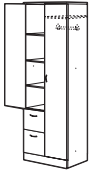

Personal Tower with Doors - LEFT

MODEL #	DIMENSIONS W x D x H (1.5" TOP)	WT/LB.	CUBIC FT.	1" TOP	1.5" TOP	GLAZE ADD	HP ADD
Z36L8EL	36 x 24 x 84.9	369	50	\$2945	\$3014	\$1601	N/A
Z30L8EL	30 x 24 x 84.9	335	42	\$2692	\$2754	\$1459	N/A
Z24L8EL	24 x 24 x 84.9	299	34.25	\$2599	\$2650	\$1258	N/A
Z36M8EL	36 x 20 x 84.9	333	42.25	\$2784	\$2846	\$1601	N/A
Z30M8EL	30 x 20 x 84.9	298	35.5	\$2567	\$2619	\$1459	N/A
Z24M8EL	24 x 20 x 84.9	266	29	\$2446	\$2488	\$1258	N/A

Two file drawers on bottom. Laminate doors are standard. Storage compartment on **left** includes **three adjustable shelves**. Wardrobe compartment on **right** includes hanging rod and **one adjustable shelf** above rod. Two upper locks secure storage and wardrobe compartments. Lower lock secures all drawers. Shipped assembled in 1 carton.

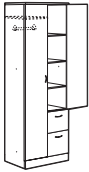

Personal Tower with Doors - RIGHT

Z36L8ER	36 x 24 x 84.9	369	50	\$2945	\$3014	\$1601	N/A
Z30L8ER	30 x 24 x 84.9	335	42	\$2692	\$2754	\$1459	N/A
Z24L8ER	24 x 24 x 84.9	299	34.25	\$2599	\$2650	\$1258	N/A
Z36M8ER	36 x 20 x 84.9	333	42.25	\$2784	\$2846	\$1601	N/A
Z30M8ER	30 x 20 x 84.9	298	35.5	\$2567	\$2619	\$1459	N/A
Z24M8ER	24 x 20 x 84.9	266	29	\$2446	\$2488	\$1258	N/A

Two file drawers on bottom. Laminate doors are standard. Storage compartment on **right** includes **three adjustable shelves**. Wardrobe compartment on **left** includes hanging rod and **one adjustable shelf** above rod. Two upper locks secure storage and wardrobe compartments. Lower lock secures all drawers. Shipped assembled in 1 carton.

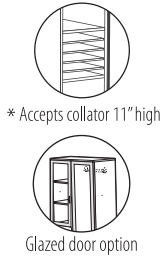
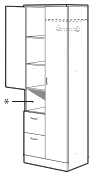

Personal Tower with Doors and Cavity - LEFT*

Z36L8ECL	36 x 24 x 84.9	366	50	\$2918	\$2987	\$1510	N/A
Z30L8ECL	30 x 24 x 84.9	332	42	\$2660	\$2722	\$1367	N/A
Z24L8ECL	24 x 24 x 84.9	295	34.25	\$2558	\$2609	\$1170	N/A
Z36M8ECL	36 x 20 x 84.9	329	42.25	\$2741	\$2803	\$1510	N/A
Z30M8ECL	30 x 20 x 84.9	295	35.5	\$2526	\$2578	\$1367	N/A
Z24M8ECL	24 x 20 x 84.9	263	29	\$2409	\$2451	\$1170	N/A

Two file drawers on bottom. Laminate doors are standard. Storage compartment on **left** includes **two 3-position fixed/height adjustable shelves**. Wardrobe compartment on **right** includes hanging rod and **one adjustable shelf** above rod. Two upper locks secure storage and wardrobe compartments. Lower lock secures all drawers. Shipped assembled in 1 carton.

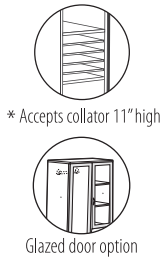
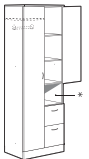

Personal Tower with Doors and Cavity - RIGHT*

Z36L8ECR	36 x 24 x 84.9	366	50	\$2918	\$2987	\$1510	N/A
Z30L8ECR	30 x 24 x 84.9	332	42	\$2660	\$2722	\$1367	N/A
Z24L8ECR	24 x 24 x 84.9	295	34.25	\$2558	\$2609	\$1170	N/A
Z36M8ECR	36 x 20 x 84.9	329	42.25	\$2741	\$2803	\$1510	N/A
Z30M8ECR	30 x 20 x 84.9	295	35.5	\$2526	\$2578	\$1367	N/A
Z24M8ECR	24 x 20 x 84.9	263	29	\$2409	\$2451	\$1170	N/A

Two file drawers on bottom. Laminate doors are standard. Storage compartment on **right** includes **two 3-position fixed/height adjustable shelves**. Wardrobe compartment on **left** includes hanging rod and **one adjustable shelf** above rod. Two upper locks secure storage and wardrobe compartments. Lower lock secures all drawers. Shipped assembled in 1 carton.

Required specifications

- Top finish
- Top thickness/edge detail
- Base finish
- Handles

Optional specifications

- Key #
- Box drawer - no upcharge
- Collator - position & finish*
- Glazed door

PERSONAL TOWERS - 84.5" / 85" HIGH

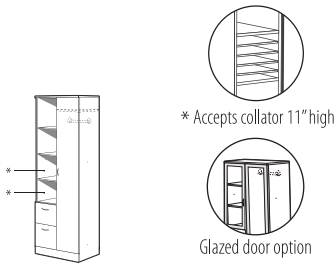

Personal Tower with Open Shelves - LEFT*

MODEL #	DIMENSIONS W x D x H (1.5" TOP)	WT/LB.	CUBIC FT.	1" TOP		GLAZE ADD	HP ADD
				1" TOP	1.5" TOP		
Z36L8ENL	36 x 24 x 84.9	352	50	\$2760	\$2829	\$924	N/A
Z30L8ENL	30 x 24 x 84.9	320	42	\$2501	\$2563	\$781	N/A
Z24L8ENL	24 x 24 x 84.9	283	34.25	\$2369	\$2420	\$583	N/A
Z36M8ENL	36 x 20 x 84.9	314	42.25	\$2582	\$2644	\$919	N/A
Z30M8ENL	30 x 20 x 84.9	283	35.5	\$2365	\$2417	\$785	N/A
Z24M8ENL	24 x 20 x 84.9	249	29	\$2220	\$2262	\$583	N/A

Two file drawers on bottom. Laminate door is standard on wardrobe section. Storage compartment on **left** includes **three 3-position fixed/height adjustable shelves**. Wardrobe compartment on **right** includes hanging rod and **one adjustable shelf** above rod. Upper lock secures wardrobe compartment. Lower lock secures all drawers. Shipped assembled in 1 carton.

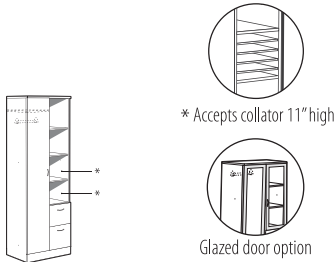

Personal Tower with Open Shelves - RIGHT*

Z36L8ENR	36 x 24 x 84.9	352	50	\$2760	\$2829	\$924	N/A
Z30L8ENR	30 x 24 x 84.9	320	42	\$2501	\$2563	\$781	N/A
Z24L8ENR	24 x 24 x 84.9	283	34.25	\$2369	\$2420	\$583	N/A
Z36M8ENR	36 x 20 x 84.9	314	42.25	\$2582	\$2644	\$919	N/A
Z30M8ENR	30 x 20 x 84.9	283	35.5	\$2365	\$2417	\$785	N/A
Z24M8ENR	24 x 20 x 84.9	249	29	\$2220	\$2262	\$583	N/A

Two file drawers on bottom. Laminate door is standard on wardrobe section. Storage compartment on **right** includes **three 3-position fixed/height adjustable shelves**. Wardrobe compartment on **left** includes hanging rod and **one adjustable shelf** above rod. Upper lock secures wardrobe compartment. Lower lock secures all drawers. Shipped assembled in 1 carton.

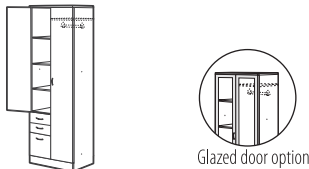

Personal Tower with Doors - LEFT

Z36L8BFL	36 x 24 x 84.9	372	50	\$3083	\$3152	\$1601	N/A
Z30L8BFL	30 x 24 x 84.9	337	42	\$2840	\$2902	\$1459	N/A
Z24L8BFL	24 x 24 x 84.9	301	34.25	\$2702	\$2753	\$1258	N/A
Z36M8BFL	36 x 20 x 84.9	335	42.25	\$2910	\$2972	\$1601	N/A
Z30M8BFL	30 x 20 x 84.9	300	35.5	\$2702	\$2754	\$1459	N/A
Z24M8BFL	24 x 20 x 84.9	268	29	\$2550	\$2592	\$1258	N/A

Two box and one file drawer on bottom. Laminate doors are standard. Storage compartment on **left** includes **three 3-position fixed/height adjustable shelves**. Wardrobe compartment on **right** includes hanging rod and **one adjustable shelf** above rod. Two upper locks secure storage and wardrobe compartments. Lower lock secures all drawers. Shipped assembled in 1 carton.

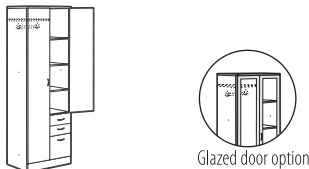

Personal Tower with Doors - RIGHT

Z36L8BFR	36 x 24 x 84.9	372	50	\$3083	\$3152	\$1601	N/A
Z30L8BFR	30 x 24 x 84.9	337	42	\$2840	\$2902	\$1459	N/A
Z24L8BFR	24 x 24 x 84.9	301	34.25	\$2702	\$2753	\$1258	N/A
Z36M8BFR	36 x 20 x 84.9	335	42.25	\$2910	\$2972	\$1601	N/A
Z30M8BFR	30 x 20 x 84.9	300	35.5	\$2702	\$2754	\$1459	N/A
Z24M8BFR	24 x 20 x 84.9	268	29	\$2550	\$2592	\$1258	N/A

Two box and one file drawer on bottom. Laminate doors are standard. Storage compartment on **right** includes **three 3-position fixed/height adjustable shelves**. Wardrobe compartment on **left** includes hanging rod and **one adjustable shelf** above rod. Two upper locks secure storage and wardrobe compartments. Lower lock secures all drawers. Shipped assembled in 1 carton.

Required specifications

- Top finish
- Top thickness/edge detail
- Base finish
- Handles

Optional specifications

- Key #
- Box drawer - no upcharge
- Collator - position & finish*
- Glazed door

PERSONAL TOWERS - 84.5" / 85" HIGH

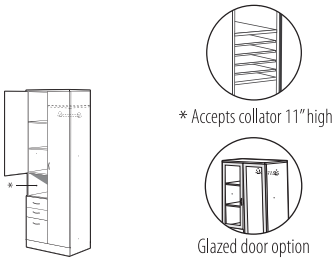

Personal Tower with Doors and Cavity - LEFT

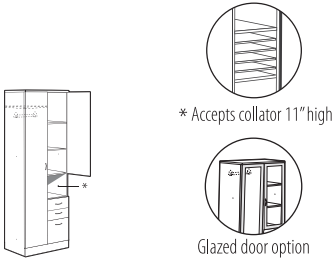

Personal Tower with Doors and Cavity - RIGHT

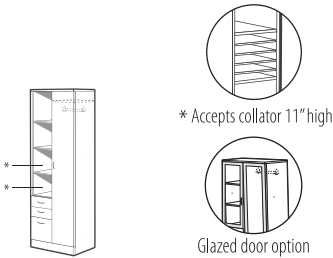

Personal Tower with Open Shelves - LEFT

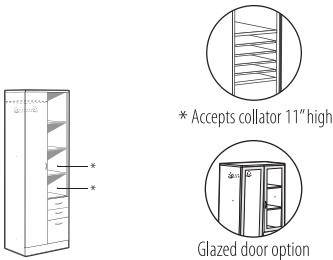

Personal Tower with Open Shelves - RIGHT

MODEL #	DIMENSIONS W x D x H (1.5" TOP)	WT/LB.	CUBIC FT.	1" TOP	1.5" TOP	GLAZE ADD	HP ADD
Z36L8BFCL	36 x 24 x 84.9	370	50	\$3042	\$3111	\$1510	N/A
Z30L8BFCL	30 x 24 x 84.9	335	42	\$2800	\$2862	\$1367	N/A
Z24L8BFCL	24 x 24 x 84.9	297	34.25	\$2660	\$2711	\$1170	N/A
Z36M8BFCL	36 x 20 x 84.9	331	42.25	\$2868	\$2930	\$1510	N/A
Z30M8BFCL	30 x 20 x 84.9	299	35.5	\$2660	\$2712	\$1367	N/A
Z24M8BFCL	24 x 20 x 84.9	265	29	\$2509	\$2551	\$1170	N/A

Two box and one file drawer on bottom. Laminate doors are standard. Storage compartment on **left** includes **one fixed shelf and one 3-position fixed/height adjustable shelf**. Wardrobe compartment on **right** includes hanging rod and **one adjustable shelf** above rod. Two upper locks secure storage and wardrobe compartments. Lower lock secures all drawers. Shipped assembled in 1 carton.

Z36L8BFCL	36 x 24 x 84.9	370	50	\$3042	\$3111	\$1510	N/A
Z30L8BFCL	30 x 24 x 84.9	335	42	\$2800	\$2862	\$1367	N/A
Z24L8BFCL	24 x 24 x 84.9	297	34.25	\$2660	\$2711	\$1170	N/A
Z36M8BFCL	36 x 20 x 84.9	331	42.25	\$2868	\$2930	\$1510	N/A
Z30M8BFCL	30 x 20 x 84.9	299	35.5	\$2660	\$2712	\$1367	N/A
Z24M8BFCL	24 x 20 x 84.9	265	29	\$2509	\$2551	\$1170	N/A

Two box and one file drawer on bottom. Laminate doors are standard. Storage compartment on **right** includes **one fixed shelf and one 3-position fixed/height adjustable shelf**. Wardrobe compartment on **left** includes hanging rod and one adjustable shelf above rod. Two upper locks secure storage and wardrobe compartments. Lower lock secures all drawers. Shipped assembled in 1 carton.

Z36L8BFNL	36 x 24 x 84.9	355	50	\$2882	\$2951	\$924	N/A
Z30L8BFNL	30 x 24 x 84.9	322	42	\$2639	\$2701	\$781	N/A
Z24L8BFNL	24 x 24 x 84.9	285	34.25	\$2473	\$2524	\$583	N/A
Z36M8BFNL	36 x 20 x 84.9	316	42.25	\$2707	\$2783	\$919	N/A
Z30M8BFNL	30 x 20 x 84.9	287	35.5	\$2501	\$2553	\$785	N/A
Z24M8BFNL	24 x 20 x 84.9	251	29	\$2322	\$2364	\$583	N/A

Two box and one file drawer on bottom. Laminate door is standard on wardrobe section. Storage compartment on **left** includes **three 3-position fixed/height adjustable shelves**. Wardrobe compartment on **right** includes hanging rod and **one adjustable shelf** above rod. Upper lock secures wardrobe compartment. Lower lock secures all drawers. Shipped assembled in 1 carton.

Z36L8BFNR	36 x 24 x 84.9	355	50	\$2882	\$2951	\$924	N/A
Z30L8BFNR	30 x 24 x 84.9	322	42	\$2639	\$2701	\$781	N/A
Z24L8BFNR	24 x 24 x 84.9	285	34.25	\$2473	\$2524	\$583	N/A
Z36M8BFNR	36 x 20 x 84.9	316	42.25	\$2707	\$2783	\$919	N/A
Z30M8BFNR	30 x 20 x 84.9	287	35.5	\$2501	\$2553	\$785	N/A
Z24M8BFNR	24 x 20 x 84.9	251	29	\$2322	\$2364	\$583	N/A

Two box and one file drawer on bottom. Laminate door is standard on wardrobe section. Storage compartment on **right** includes **three 3-position fixed/height adjustable shelves**. Wardrobe compartment on **left** includes hanging rod and **one adjustable shelf** above rod. Upper lock secures wardrobe compartment. Lower lock secures all drawers. Shipped assembled in 1 carton.

Required specifications

Top finish
Top thickness/edge detail
Base finish
Handles

Optional specifications

Key #
Box drawer - no upcharge
Collator - position & finish
Glazed door

OVERHEAD STORAGE - 33"H

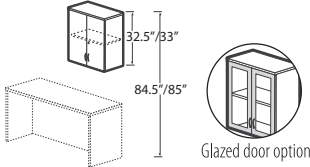

Closed Front Overhead Storage with Doors - 33"/33.5" High*

MODEL #	DIMENSIONS W x D x H (1.5" TOP)	WT/LB.	CUBIC FT.	1" TOP	1.5" TOP	GLAZE ADD	HP ADD
Z42S330S	42 x 16 x 33	136	16.25	\$1078	\$1146	\$1055	N/A
Z36S330S	36 x 16 x 33	120	14	\$976	\$1037	\$952	N/A
Z30S330S	30 x 16 x 33	104	11.75	\$871	\$907	\$827	N/A
Z24S330S	24 x 16 x 33	81	9.75	\$780	\$822	\$722	N/A

Includes steel hanging rail for wall mount applications. Includes one fixed shelf. Doors lock. Shipped easy to assemble in 1 carton.

• **NOTE:** Care should be taken to mount the units. Units should be mounted to wall studs using correct fasteners. Failure to do so may result in collapse of the unit and subsequent personal injury. **Fastening hardware not included.** Mounting hardware used should be based on wall material. Consult an installation professional for proper wall mounting.

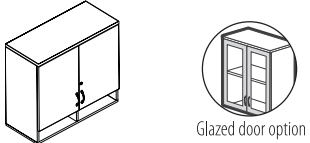

Closed Front Overhead Storage with Pigeon Hole - 32.5"/33" H

Z42S330P	42 x 16 x 33	140	16.25	\$1639	\$1726	\$848	N/A
Z36S330P	36 x 16 x 33	122	14	\$1416	\$1495	\$773	N/A
Z30S330P	30 x 16 x 33	105	12	\$1267	\$1331	\$688	N/A
Z24S330P	24 x 16 x 33	88	9.75	\$1139	\$1198	\$624	N/A

Includes steel hanging rail for wall mount applications. Includes one fixed shelf. Doors lock. Shipped easy to assemble in 1 carton.

• **NOTE:** Care should be taken to mount the units. Units should be mounted to wall studs using correct fasteners. Failure to do so may result in collapse of the unit and subsequent personal injury. **Fastening hardware not included.** Mounting hardware used should be based on wall material. Consult an installation professional for proper wall mounting.
• **42"W** unit has four pigeon hole compartments.

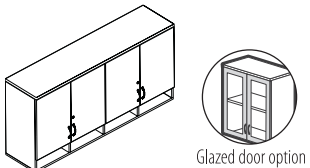

Closed Front Overhead Storage with Pigeon Hole - 32.5"/33" H

Z72S330S	72 x 16 x 33	230	26	\$2659	\$2772	\$1552	N/A
Z66S330S	66 x 16 x 33	215	24	\$2553	\$2659	\$1522	N/A
Z60S330S	60 x 16 x 33	199	22	\$2355	\$2451	\$1379	N/A
Z54S330S	54 x 16 x 33	184	21	\$2237	\$2327	\$1351	N/A

Includes steel hanging rail for wall mount applications. Includes one fixed shelf. Doors lock. Shipped easy to assemble in 1 carton.

• **NOTE:** Care should be taken to mount the units. Units should be mounted to wall studs using correct fasteners. Failure to do so may result in collapse of the unit and subsequent personal injury. **Fastening hardware not included.** Mounting hardware used should be based on wall material. Consult an installation professional for proper wall mounting.

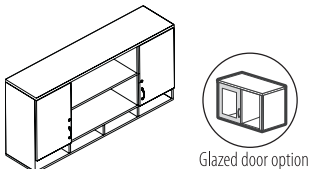

Overhead Storage, 2 Outer Doors with Pigeon Hole - 32.5"/33" H

Z72S33SOS	72 x 16 x 33	215	26	\$2402	\$2515	\$778	N/A
Z66S33SOS	66 x 16 x 33	201	24	\$2294	\$2400	\$762	N/A
Z60S33SOS	60 x 16 x 33	187	22	\$2156	\$2252	\$748	N/A
Z54S33SOS	54 x 16 x 33	173	21	\$2005	\$2095	\$675	N/A

Doors on upper outer compartments only. Includes steel hanging rail for wall mount applications. Includes one fixed shelf. Doors lock. Shipped easy to assemble in 1 carton.

• **NOTE:** Care should be taken to mount the units. Units should be mounted to wall studs using correct fasteners. Failure to do so may result in collapse of the unit and subsequent personal injury. **Fastening hardware not included.** Mounting hardware used should be based on wall material. Consult an installation professional for proper wall mounting.

Required specifications

- Top finish
- Top thickness/edge detail
- Base finish
- Handles

Optional specifications

- Key #
- Glazed doors

OVERHEAD STORAGE - 33"H

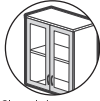
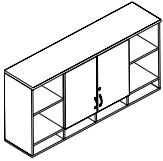

Glazed door option

Overhead Storage, 2 Center Doors with Pigeon Hole - 32.5"/33"H

MODEL #	DIMENSIONS W x D x H (1.5" TOP)	WT/LB.	CUBIC FT.	1" TOP	1.5" TOP	GLAZE ADD	HP ADD
Z72S330SO	72 x 16 x 33	214	26	\$2357	\$2470	\$777	N/A
Z66S330SO	66 x 16 x 33	200	24	\$2255	\$2361	\$762	N/A
Z60S330SO	60 x 16 x 33	186	22	\$2114	\$2211	\$691	N/A
Z54S330SO	54 x 16 x 33	172	21	\$2000	\$2090	\$675	N/A

Doors on upper inner compartments only. Includes steel hanging rail for wall mount applications. Includes one fixed shelf. Doors lock. Shipped easy to assemble in 1 carton.

• **NOTE:** Care should be taken to mount the units. Units should be mounted to wall studs using correct fasteners. Failure to do so may result in collapse of the unit and subsequent personal injury. **Fastening hardware not included.** Mounting hardware used should be based on wall material. Consult an installation professional for proper wall mounting.

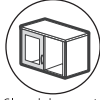
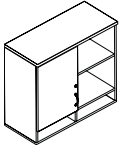

Glazed door option

Overhead Storage, 1 Door - LEFT with Pigeon Hole - 32.5"/33"H

Z36S330SL	36 x 16 x 33	119	14	\$1327	\$1406	\$386	N/A
Z30S330SL	30 x 16 x 33	104	11.75	\$1208	\$1271	\$344	N/A
Z24S330SL	24 x 16 x 33	88	9.75	\$1084	\$1143	\$300	N/A

Includes steel hanging rail for wall mount applications. Includes one fixed shelf. Closed on **left**, open shelf on **right**. Door locks. Shipped easy to assemble in 1 carton.

• **NOTE:** Care should be taken to mount the units. Units should be mounted to wall studs using correct fasteners. Failure to do so may result in collapse of the unit and subsequent personal injury. **Fastening hardware not included.** Mounting hardware used should be based on wall material. Consult an installation professional for proper wall mounting.

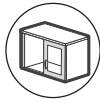
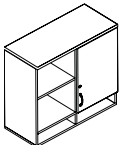

Glazed door option

Overhead Storage, 1 Door - RIGHT with Pigeon Hole - 32.5"/33"H

Z36S330SR	36 x 16 x 33	119	14	\$1327	\$1406	\$386	N/A
Z30S330SR	30 x 16 x 33	104	11.75	\$1208	\$1271	\$344	N/A
Z24S330SR	24 x 16 x 33	88	9.75	\$1084	\$1143	\$300	N/A

Includes steel hanging rail for wall mount applications. Includes one fixed shelf. Closed on **right**, open shelf on **left**. Door locks. Shipped easy to assemble in 1 carton.

• **NOTE:** Care should be taken to mount the units. Units should be mounted to wall studs using correct fasteners. Failure to do so may result in collapse of the unit and subsequent personal injury. **Fastening hardware not included.** Mounting hardware used should be based on wall material. Consult an installation professional for proper wall mounting.

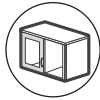
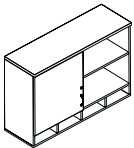

Glazed door option

Overhead Storage, 1 Door - LEFT with Pigeon Hole - 32.5"/33"H

Z48S330SL	48 x 16 x 33	150	17.7	\$1717	\$1807	\$436	N/A
Z42S330SL	42 x 16 x 33	135	16.25	\$1525	\$1612	\$425	N/A

Includes steel hanging rail for wall mount applications. Includes one fixed shelf. Closed on **left**, open shelf on **right**. Door locks. Shipped easy to assemble in 1 carton.

• **NOTE:** Care should be taken to mount the units. Units should be mounted to wall studs using correct fasteners. Failure to do so may result in collapse of the unit and subsequent personal injury. **Fastening hardware not included.** Mounting hardware used should be based on wall material. Consult an installation professional for proper wall mounting.

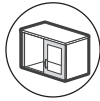
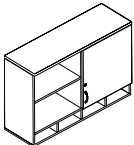

Glazed door option

Overhead Storage, 1 Door - RIGHT with Pigeon Hole - 32.5"/33"H

Z48S330SR	48 x 16 x 33	150	17.7	\$1717	\$1807	\$436	N/A
Z42S330SR	42 x 16 x 33	135	16.25	\$1525	\$1612	\$425	N/A

Includes steel hanging rail for wall mount applications. Includes one fixed shelf. Closed on **right**, open shelf on **left**. Door locks. Shipped easy to assemble in 1 carton.

• **NOTE:** Care should be taken to mount the units. Units should be mounted to wall studs using correct fasteners. Failure to do so may result in collapse of the unit and subsequent personal injury. **Fastening hardware not included.** Mounting hardware used should be based on wall material. Consult an installation professional for proper wall mounting.

Required specifications

Top finish
Top thickness/edge detail
Base finish
Handles

Optional specifications

Key #
Glazed doors

OVERHEAD STORAGE - 33"H **MODEL #** **DIMENSIONS** **WT/LB.** **CUBIC FT.** **1" TOP** **1.5" TOP** **GLAZE ADD** **HP ADD**

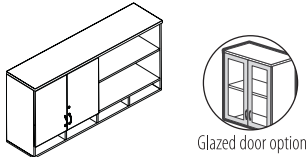

Overhead Storage, 2 Doors - LEFT with Pigeon Hole - 32.5"/33"H*

W x D x H (1.5" TOP)

Z72S330SL	72 x 16 x 33	207	26	\$2308	\$2422	\$777	N/A
Z66S330SL	66 x 16 x 33	193	24	\$2202	\$2308	\$762	N/A
Z60S330SL	60 x 16 x 33	179	22	\$2041	\$2137	\$691	N/A
Z54S330SL	54 x 16 x 33	166	21	\$1928	\$2018	\$675	N/A

Includes steel hanging rail for wall mount applications. Includes one fixed shelf. Closed on **left**, open shelves on **right**. Doors lock. Shipped easy to assemble in 1 carton.

• **NOTE:** Care should be taken to mount the units. Units should be mounted to wall studs using correct fasteners. Failure to do so may result in collapse of the unit and subsequent personal injury. **Fastening hardware not included.** Mounting hardware used should be based on wall material. Consult an installation professional for proper wall mounting.

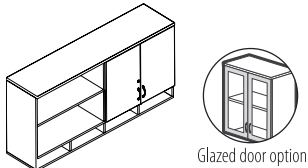

Overhead Storage, 2 Doors - RIGHT with Pigeon Hole - 32.5"/33"H*

Z72S330SR	72 x 16 x 33	207	26	\$2308	\$2422	\$777	N/A
Z66S330SR	66 x 16 x 33	193	24	\$2202	\$2308	\$762	N/A
Z60S330SR	60 x 16 x 33	179	22	\$2041	\$2137	\$691	N/A
Z54S330SR	54 x 16 x 33	166	21	\$1928	\$2018	\$675	N/A

Includes steel hanging rail for wall mount applications. Includes one fixed shelf. Closed on **right**, open shelves on **left**. Doors lock. Shipped easy to assemble in 1 carton.

• **NOTE:** Care should be taken to mount the units. Units should be mounted to wall studs using correct fasteners. Failure to do so may result in collapse of the unit and subsequent personal injury. **Fastening hardware not included.** Mounting hardware used should be based on wall material. Consult an installation professional for proper wall mounting.

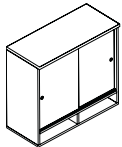

Overhead Storage, Sliding Glass Doors with Pigeon Hole - 32.5"/33"H

Z36S330SD	36 x 16 x 33	127	15.4	\$2815	\$2894	N/A	N/A
Z30S330SD	30 x 16 x 33	110	13.2	\$2477	\$2540	N/A	N/A
Z24S330SD	24 x 16 x 33	91	10.8	\$2196	\$2255	N/A	N/A

Includes steel hanging rail for wall mount applications. Includes one fixed shelf. Sliding glass doors do not lock. Shipped easy to assemble in 2 cartons (glass doors shipped separately).

• **NOTE:** Care should be taken to mount the units. Units should be mounted to wall studs using correct fasteners. Failure to do so may result in collapse of the unit and subsequent personal injury. **Fastening hardware not included.** Mounting hardware used should be based on wall material. Consult an installation professional for proper wall mounting.

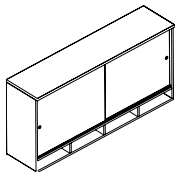

Overhead Storage, Sliding Glass Doors with Pigeon Hole - 32.5"/33"H

Z72S330SD	72 x 16 x 33	224	28.5	\$4965	\$5079	N/A	N/A
Z66S330SD	66 x 16 x 33	208	26.3	\$4642	\$4749	N/A	N/A
Z60S330SD	60 x 16 x 33	193	24.1	\$4296	\$4393	N/A	N/A
Z54S330SD	54 x 16 x 33	178	22.9	\$4002	\$4092	N/A	N/A
Z48S330SD	48 x 16 x 33	162	19.5	\$3654	\$3744	N/A	N/A
Z42S330SD	42 x 16 x 33	145	17.9	\$3266	\$3353	N/A	N/A

Includes steel hanging rail for wall mount applications. Includes one fixed shelf. Sliding glass doors do not lock. Shipped easy to assemble in 2 cartons (glass doors shipped separately).

• **NOTE:** Care should be taken to mount the units. Units should be mounted to wall studs using correct fasteners. Failure to do so may result in collapse of the unit and subsequent personal injury. **Fastening hardware not included.** Mounting hardware used should be based on wall material. Consult an installation professional for proper wall mounting.

Required specifications

- Top finish
- Top thickness/edge detail
- Base finish
- Handles*

Optional specifications

- Key #*
- Glazed doors*

OVERHEAD STORAGE - 20" H

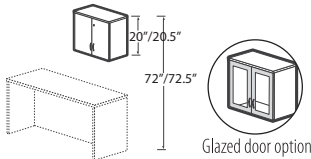

Closed Front Overhead Storage with Doors - 20.5"/21" High*

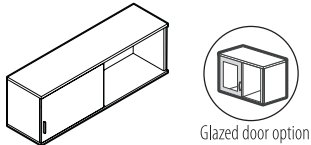

Overhead Storage w/1 door - LEFT* 20"/20.5"H

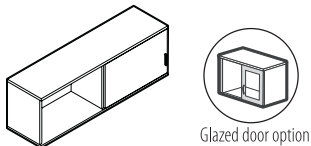

Overhead Storage w/1 door - RIGHT* 20"/20.5"H*

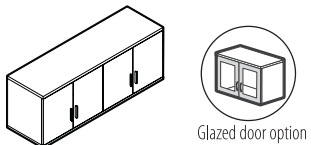

Closed Front Overhead Storage w/Center Divider- 20"/20.5"H*

MODEL # DIMENSIONS WT/LB. CUBIC FT. 1" TOP 1.5" TOP GLAZE ADD HP ADD

	W x D x H (1.5" TOP)						
Z42S200S	42 x 16 x 20.5	94	10.5	\$767	\$835	\$751	N/A
Z36S200S	36 x 16 x 20.5	83	9	\$702	\$763	\$686	N/A
Z30S200S	30 x 16 x 20.5	72	7.5	\$633	\$669	\$607	N/A
Z24S200S	24 x 16 x 20.5	56	6.25	\$595	\$637	\$545	N/A

Includes steel hanging rail for wall mount applications. Doors lock. Shipped easy to assemble in 1 carton.

• **NOTE:** Care should be taken to mount the units. Units should be mounted to wall studs using correct fasteners. Failure to do so may result in collapse of the unit and subsequent personal injury. **Fastening hardware not included.** Mounting hardware used should be based on wall material. Consult an installation professional for proper wall mounting.

Z48S200SL	48 x 16 x 20.5	95	12.5	\$1041	\$1132	\$373	N/A
Z42S200SL	42 x 16 x 20.5	85	10.5	\$923	\$1010	\$344	N/A
Z36S200SL	36 x 16 x 20.5	76	9	\$845	\$923	\$315	N/A
Z30S200SL	30 x 16 x 20.5	67	7.6	\$773	\$837	\$268	N/A
Z24S200SL	24 x 16 x 20.5	58	6.5	\$716	\$774	\$249	N/A

Hinged door on **left**, open on **right**. Includes steel hanging rail for wall mount applications. Door locks. Shipped easy to assemble in 1 carton.

• **NOTE:** Care should be taken to mount the units. Units should be mounted to wall studs using correct fasteners. Failure to do so may result in collapse of the unit and subsequent personal injury. **Fastening hardware not included.** Mounting hardware used should be based on wall material. Consult an installation professional for proper wall mounting.

Z48S200SR	48 x 16 x 20.5	95	12.5	\$1041	\$1132	\$373	N/A
Z42S200SR	42 x 16 x 20.5	85	10.5	\$923	\$1010	\$344	N/A
Z36S200SR	36 x 16 x 20.5	76	9	\$845	\$923	\$315	N/A
Z30S200SR	30 x 16 x 20.5	67	7.6	\$773	\$837	\$268	N/A
Z24S200SR	24 x 16 x 20.5	58	6.5	\$716	\$774	\$249	N/A

Hinged door on **right**, open on **left**. Includes steel hanging rail for wall mount applications. Door locks. Shipped easy to assemble in 1 carton.

• **NOTE:** Care should be taken to mount the units. Units should be mounted to wall studs using correct fasteners. Failure to do so may result in collapse of the unit and subsequent personal injury. **Fastening hardware not included.** Mounting hardware used should be based on wall material. Consult an installation professional for proper wall mounting.

Z72S200S	72 x 16 x 20.5	149	18	\$1758	\$1872	\$1254	N/A
Z66S200S	66 x 16 x 20.5	139	16.5	\$1676	\$1782	\$1225	N/A
Z60S200S	60 x 16 x 20.5	129	15	\$1547	\$1644	\$1123	N/A
Z54S200S	54 x 16 x 20.5	119	13.75	\$1472	\$1563	\$1095	N/A

Includes steel hanging rail for wall mount applications. Doors lock. Shipped easy to assemble in 1 carton.

• **NOTE:** Care should be taken to mount the units. Units should be mounted to wall studs using correct fasteners. Failure to do so may result in collapse of the unit and subsequent personal injury. **Fastening hardware not included.** Mounting hardware used should be based on wall material. Consult an installation professional for proper wall mounting.

Required specifications

Top finish
Top thickness/edge detail
Base finish
Handles

Optional specifications

Key #
Glazed doors

OVERHEAD STORAGE - 20"H	MODEL #	DIMENSIONS	WT/LB.	CUBIC FT.	1" TOP	1.5" TOP	GLAZE ADD	HP ADD
-------------------------	---------	------------	--------	-----------	--------	----------	-----------	--------

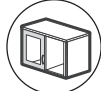
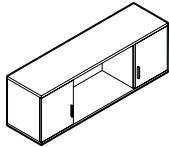

Glazed door option

**Overhead Storage w/2 Outer Doors
20"/20.5"H***

	W x D x H (1.5" TOP)							
Z72S20SOS	72 x 16 x 20.5	137	18	\$1510	\$1623	\$631	N/A	
Z66S20SOS	66 x 16 x 20.5	128	16.5	\$1430	\$1537	\$616	N/A	
Z60S20SOS	60 x 16 x 20.5	120	15	\$1345	\$1441	\$603	N/A	
Z54S20SOS	54 x 16 x 20.5	110	13.75	\$1253	\$1343	\$550	N/A	

Doors on outer compartments only. Includes steel hanging rail for wall mount applications. Doors lock. Shipped easy to assemble in 1 carton.

• **NOTE:** Care should be taken to mount the units. Units should be mounted to wall studs using correct fasteners. Failure to do so may result in collapse of the unit and subsequent personal injury. **Fastening hardware not included.** Mounting hardware used should be based on wall material. Consult an installation professional for proper wall mounting.

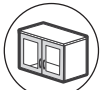
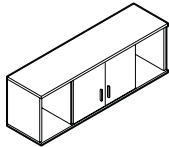

Glazed door option

**Overhead Storage w/2 Inner Doors
20"/20.5"H***

Z72S20OSO	72 x 16 x 20.5	137	18	\$1529	\$1642	\$628	N/A	
Z66S20OSO	66 x 16 x 20.5	128	16.5	\$1449	\$1556	\$613	N/A	
Z60S20OSO	60 x 16 x 20.5	120	15	\$1364	\$1460	\$561	N/A	
Z54S20OSO	54 x 16 x 20.5	110	13.75	\$1272	\$1362	\$547	N/A	

Doors on inner compartments only. Includes steel hanging rail for wall mount applications. Doors lock. Shipped easy to assemble in 1 carton.

• **NOTE:** Care should be taken to mount the units. Units should be mounted to wall studs using correct fasteners. Failure to do so may result in collapse of the unit and subsequent personal injury. **Fastening hardware not included.** Mounting hardware used should be based on wall material. Consult an installation professional for proper wall mounting.

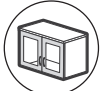
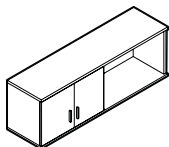

Glazed door option

**Overhead Storage w/2 Doors - LEFT
20"/20.5"H***

Z72S20OSL	72 x 16 x 20.5	132	18	\$1463	\$1577	\$628	N/A	
Z66S20OSL	66 x 16 x 20.5	123	16.5	\$1385	\$1491	\$613	N/A	
Z60S20OSL	60 x 16 x 20.5	114	15	\$1282	\$1378	\$561	N/A	
Z54S20OSL	54 x 16 x 20.5	105	13.75	\$1208	\$1298	\$550	N/A	

2 hinged doors on **left**, open shelf on **right**. Includes steel hanging rail for wall mount applications. Doors lock. Shipped easy to assemble in 1 carton.

• **NOTE:** Care should be taken to mount the units. Units should be mounted to wall studs using correct fasteners. Failure to do so may result in collapse of the unit and subsequent personal injury. **Fastening hardware not included.** Mounting hardware used should be based on wall material. Consult an installation professional for proper wall mounting.

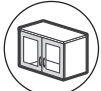
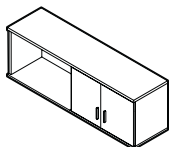

Glazed door option

**Overhead Storage w/2 Doors - RIGHT
20"/20.5"H***

Z72S20OSR	72 x 16 x 20.5	132	18	\$1463	\$1577	\$628	N/A	
Z66S20OSR	66 x 16 x 20.5	123	16.5	\$1385	\$1491	\$613	N/A	
Z60S20OSR	60 x 16 x 20.5	114	15	\$1282	\$1378	\$561	N/A	
Z54S20OSR	54 x 16 x 20.5	105	13.75	\$1208	\$1298	\$550	N/A	

2 hinged doors on **right**, open shelf on **left**. Includes steel hanging rail for wall mount applications. Doors lock. Shipped easy to assemble in 1 carton.

• **NOTE:** Care should be taken to mount the units. Units should be mounted to wall studs using correct fasteners. Failure to do so may result in collapse of the unit and subsequent personal injury. **Fastening hardware not included.** Mounting hardware used should be based on wall material. Consult an installation professional for proper wall mounting.

Required specifications

- Top finish
- Top thickness/edge detail
- Base finish
- Handles*

Optional specifications

- Key #*
- Glazed doors*

OVERHEAD STORAGE - 20"H

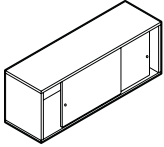

Overhead Storage, w/Sliding Glass Doors 20"/20.5"H

MODEL #	DIMENSIONS W x D x H (1.5" TOP)	WT/LB.	CUBIC FT.	1" TOP	1.5" TOP	GLAZE ADD	HP ADD
Z72S200SD	72 x 16 x 20.5	145	19.9	\$3711	\$3824	N/A	N/A
Z66S200SD	66 x 16 x 20.5	135	18.2	\$3456	\$3563	N/A	N/A
Z60S200SD	60 x 16 x 20.5	125	16.6	\$3187	\$3283	N/A	N/A
Z54S200SD	54 x 16 x 20.5	115	15.2	\$3050	\$3141	N/A	N/A
Z48S200SD	48 x 16 x 20.5	104	13.8	\$2696	\$2786	N/A	N/A
Z42S200SD	42 x 16 x 20.5	93	11.7	\$2409	\$2496	N/A	N/A
Z36S200SD	36 x 16 x 20.5	83	10	\$2129	\$2207	N/A	N/A
Z30S200SD	30 x 16 x 20.5	75	8.5	\$1905	\$1969	N/A	N/A
Z24S200SD	24 x 16 x 20.5	63	7.1	\$1766	\$1824	N/A	N/A

Includes steel hanging rail for wall mount applications. Sliding glass doors do not lock. Shipped easy to assemble in 2 cartons (glass doors shipped separately).

- **NOTE:** Care should be taken to mount the units. Units should be mounted to wall studs using correct fasteners. Failure to do so may result in collapse of the unit and subsequent personal injury. **Fastening hardware not included.** Mounting hardware used should be based on wall material. Consult an installation professional for proper wall mounting.

OVERHEAD STORAGE - 16"H

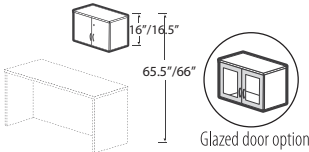

Closed Front Overhead Storage with Doors - 16"/16.5" High*

Z48S160S	48 x 15 x 16.5	99	9.25	\$766	\$829	\$722	N/A
Z42S160S	42 x 15 x 16.5	87	7.75	\$661	\$718	\$700	N/A
Z36S160S	36 x 15 x 16.5	77	6.75	\$603	\$653	\$633	N/A
Z30S160S	30 x 15 x 16.5	64	5.75	\$551	\$593	\$552	N/A

Includes French cleat style wooden blocks for wall mounting applications. Doors lock. Shipped easy to assemble in 1 carton.

- **NOTE:** Care should be taken to mount the units. Units should be mounted to wall studs using correct fasteners. Failure to do so may result in collapse of the unit and subsequent personal injury. **Fastening hardware not included.** Mounting hardware used should be based on wall material. Consult an installation professional for proper wall mounting.

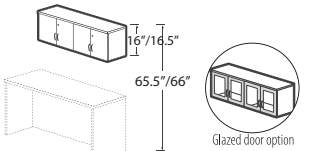

Closed Front Overhead Storage with Doors - 16"/16.5" High, 60" Wide*

Z60S160S	60 x 15 x 16.5	118	11	\$1005	\$1083	\$1103	N/A
----------	----------------	-----	----	---------------	---------------	---------------	-----

Includes French cleat style wooden blocks for wall mounting applications. Doors lock. Shipped easy to assemble in 1 carton.

- **NOTE:** Care should be taken to mount the units. Units should be mounted to wall studs using correct fasteners. Failure to do so may result in collapse of the unit and subsequent personal injury. **Fastening hardware not included.** Mounting hardware used should be based on wall material. Consult an installation professional for proper wall mounting.

Required specifications

- Top finish
- Top thickness/edge detail
- Base finish
- Handles*

Optional specifications

- Key #*
- Glazed doors*

OVERHEAD STORAGE W/OPEN FRONTS - 33"H **MODEL #** **DIMENSIONS** **WT/LB.** **CUBIC FT.** **1" TOP** **1.5" TOP** **GLAZE ADD** **HP ADD**

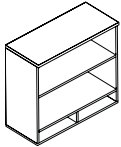

Open Front Overhead Storage w/Pigeon Hole - 32.5"/33"H

W x D x H (1.5" TOP)

Z42S330PN	42 x 16 x 33	116	16.25	\$1257	\$1344	N/A	N/A
Z36S330PN	36 x 16 x 33	101	14	\$1070	\$1148	N/A	N/A
Z30S330PN	30 x 16 x 33	88	12	\$959	\$1023	N/A	N/A
Z24S330PN	24 x 16 x 33	74	9.75	\$858	\$917	N/A	N/A

Includes steel hanging rail for wall mount applications. Includes one fixed shelf. Shipped easy to assemble in 1 carton.

- **NOTE:** Care should be taken to mount the units. Units should be mounted to wall studs using correct fasteners. Failure to do so may result in collapse of the unit and subsequent personal injury. **Fastening hardware not included.** Mounting hardware used should be based on wall material. Consult an installation professional for proper wall mounting.
- **42"W** unit has four pigeon hole compartments.

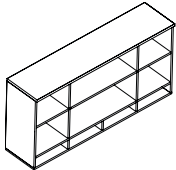

Open Front Overhead Storage w/Pigeon Hole - 32.5"/33"H

Z72S330N	72 x 16 x 33	194	26	\$2081	\$2187	N/A	N/A
Z66S330N	66 x 16 x 33	181	24	\$1955	\$2051	N/A	N/A
Z60S330N	60 x 16 x 33	169	22	\$1812	\$1902	N/A	N/A
Z54S330N	54 x 16 x 33	157	21	\$1697	\$1787	N/A	N/A

Six compartments and pigeon hole storage. Includes steel hanging rail for wall mount applications. Includes one fixed shelf. Shipped easy to assemble in 1 carton.

- **NOTE:** Care should be taken to mount the units. Units should be mounted to wall studs using correct fasteners. Failure to do so may result in collapse of the unit and subsequent personal injury. **Fastening hardware not included.** Mounting hardware used should be based on wall material. Consult an installation professional for proper wall mounting.

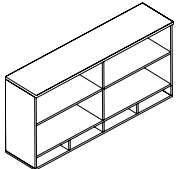

Open Front Overhead Storage w/Pigeon Hole - 32.5"/33"H

Z72S330SN	72 x 16 x 33	187	26	\$1961	\$2068	N/A	N/A
Z66S330SN	66 x 16 x 33	174	24	\$1860	\$1957	N/A	N/A
Z60S330SN	60 x 16 x 33	162	22	\$1737	\$1827	N/A	N/A
Z54S330SN	54 x 16 x 33	149	21	\$1625	\$1715	N/A	N/A

Four compartments and pigeon hole storage. Includes steel hanging rail for wall mount applications. Includes one fixed shelf. Shipped easy to assemble in 1 carton.

- **NOTE:** Care should be taken to mount the units. Units should be mounted to wall studs using correct fasteners. Failure to do so may result in collapse of the unit and subsequent personal injury. **Fastening hardware not included.** Mounting hardware used should be based on wall material. Consult an installation professional for proper wall mounting.

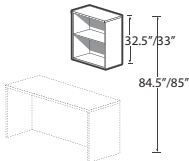

Open Front Overhead Storage 33"/33.5" High

Z42S330SN	42 x 16 x 33	109	16.25	\$726	\$794	N/A	N/A
Z36S330SN	36 x 16 x 33	97	14	\$659	\$720	N/A	N/A
Z30S330SN	30 x 16 x 33	84	11.75	\$591	\$627	N/A	N/A
Z24S330SN	24 x 16.2 x 33	67	9.75	\$546	\$588	N/A	N/A

Includes steel hanging rail for wall mount applications. Includes one fixed shelf. Shipped easy to assemble in 1 carton.

- **NOTE:** Care should be taken to mount the units. Units should be mounted to wall studs using correct fasteners. Failure to do so may result in collapse of the unit and subsequent personal injury. **Fastening hardware not included.** Mounting hardware used should be based on wall material. Consult an installation professional for proper wall mounting.

Required specifications

- Top finish
- Top thickness/edge detail
- Base finish

OVERHEAD STORAGE W/OPEN FRONTS - 20"H

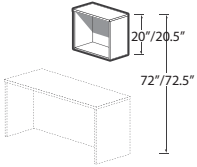

Open Front Overhead Storage
20.5"/21" High

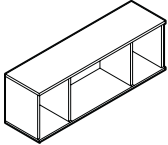

Open Front Overhead Storage
20"/20.5"H

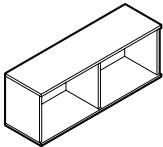

Open Front Overhead Storage
w/Center Divider - 20"/20.5"H

MODEL # DIMENSIONS WT/LB. CUBIC FT. 1" TOP 1.5" TOP GLAZE ADD HP ADD

W x D x H (1.5" TOP)

Z42S200SN	42 x 16 x 20.5	78	10.5	\$507	\$575	N/A	N/A
Z36S200SN	36 x 16 x 20.5	70	9	\$458	\$519	N/A	N/A
Z30S200SN	30 x 16 x 20.5	60	7.5	\$410	\$446	N/A	N/A
Z24S200SN	24 x 16 x 20.5	48	6.25	\$374	\$416	N/A	N/A

Includes steel hanging rail for wall mount applications. Shipped easy to assemble in 1 carton.

• **NOTE:** Care should be taken to mount the units. Units should be mounted to wall studs using correct fasteners. Failure to do so may result in collapse of the unit and subsequent personal injury. **Fastening hardware not included.** Mounting hardware used should be based on wall material. Consult an installation professional for proper wall mounting.

Z72S200N	72 x 16 x 20.5	122	18	\$1220	\$1334	N/A	N/A
Z66S200N	66 x 16 x 20.5	114	16.5	\$1143	\$1249	N/A	N/A
Z60S200N	60 x 16 x 20.5	106	15	\$1064	\$1161	N/A	N/A
Z54S200N	54 x 16 x 20.5	99	13.75	\$992	\$1083	N/A	N/A

Four compartments. Includes steel hanging rail for wall mount applications. Shipped easy to assemble in 1 carton.

• **NOTE:** Care should be taken to mount the units. Units should be mounted to wall studs using correct fasteners. Failure to do so may result in collapse of the unit and subsequent personal injury. **Fastening hardware not included.** Mounting hardware used should be based on wall material. Consult an installation professional for proper wall mounting.

Z72S200SN	72 x 16 x 20.5	117	18	\$1177	\$1291	N/A	N/A
Z66S200SN	66 x 16 x 20.5	109	16.5	\$1098	\$1205	N/A	N/A
Z60S200SN	60 x 16 x 20.5	101	15	\$1020	\$1116	N/A	N/A
Z54S200SN	54 x 16 x 20.5	94	13.75	\$949	\$1039	N/A	N/A

Two compartments. Includes steel hanging rail for wall mount applications. Shipped easy to assemble in 1 carton.

• **NOTE:** Care should be taken to mount the units. Units should be mounted to wall studs using correct fasteners. Failure to do so may result in collapse of the unit and subsequent personal injury. **Fastening hardware not included.** Mounting hardware used should be based on wall material. Consult an installation professional for proper wall mounting.

OVERHEAD STORAGE W/OPEN FRONTS - 16"H

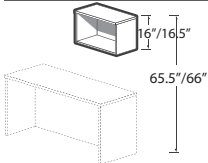

Open Front Overhead Storage
16"/16.5" High

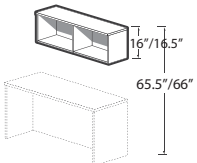

Open Front Overhead Storage
16"/16.5" High, 60" Wide

Z48S160SN	48 x 15 x 16.5	80	9.25	\$507	\$570	N/A	N/A
Z42S160SN	42 x 15 x 16.5	70	7.75	\$442	\$499	N/A	N/A
Z36S160SN	36 x 15 x 16.5	63	6.75	\$404	\$454	N/A	N/A
Z30S160SN	30 x 15 x 16.5	54	5.75	\$372	\$414	N/A	N/A

Includes French cleat style wooden blocks for wall mounting applications. Shipped easy to assemble in 1 carton.

• **NOTE:** Care should be taken to mount the units. Units should be mounted to wall studs using correct fasteners. Failure to do so may result in collapse of the unit and subsequent personal injury. **Fastening hardware not included.** Mounting hardware used should be based on wall material. Consult an installation professional for proper wall mounting.

Z60S160SN	60 x 15 x 16.5	98	11	\$626	\$704	N/A	N/A
-----------	----------------	----	----	-------	-------	-----	-----

Includes French cleat style wooden blocks for wall mounting applications. Shipped easy to assemble in 1 carton.

• **NOTE:** Care should be taken to mount the units. Units should be mounted to wall studs using correct fasteners. Failure to do so may result in collapse of the unit and subsequent personal injury. **Fastening hardware not included.** Mounting hardware used should be based on wall material. Consult an installation professional for proper wall mounting.

Required specifications

Top finish
Top thickness/edge detail
Base finish

Optional specifications

HP laminate*

Accessories

Tackboard (for hutches)

OPEN HUTCHES	MODEL #	DIMENSIONS	WT/LB.	CUBIC FT.	1" TOP	1.5" TOP	GLAZE ADD	HP ADD
		W x D x H (1.5 TOP)						
	Z84S23HN	84 x 15 x 23.5	129	23	\$920	\$1028	N/A	\$344
	Z72S23HN	72 x 15 x 23.5	114	19.75	\$804	\$912	N/A	\$257
	Z71S23HN	71.7 x 15 x 23.5	113	19.75	\$804	\$895	N/A	\$257
	Z66S23HN	66 x 15 x 23.5	106	18.25	\$735	\$822	N/A	\$257
	Z60S23HN	60 x 15 x 23.5	99	16.5	\$651	\$729	N/A	\$215
	Z48S23HN	48 x 15 x 23.5	84	13.5	\$564	\$627	N/A	\$171
	Z42S23HN	42 x 15 x 23.5	76	11.75	\$523	\$580	N/A	\$171
	Z36S23HN	36 x 15 x 23.5	68	10.25	\$483	\$533	N/A	\$144
	Z30S23HN	30 x 15 x 23.5	61	8.5	\$449	\$497	N/A	\$114

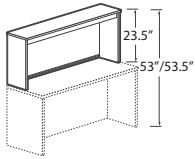

**Open Hutch with Closed Back
23.5" High***

Closed back features one grommet and flexible sweep for wire management. Shipped assembled in 1 carton.

- Hutch with 1" top clearance from work surface to valance is 20.5"; with 1.5" top clearance is 20".
- Woodgrain runs horizontal on both the upper and lower back panels.

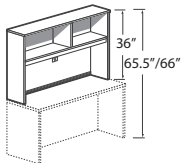

**Open Hutch with Closed Back
36" High**

Z84S36HN	84 x 15 x 36	206	33	\$1194	\$1302	N/A	N/A
Z72S36HN	72 x 15 x 36	181	28.25	\$1091	\$1182	N/A	N/A
Z71S36HN	71.7 x 15 x 36	173	28.25	\$1081	\$1172	N/A	N/A
Z66S36HN	66 x 15 x 36	161	26	\$1022	\$1109	N/A	N/A
Z60S36HN	60 x 15 x 36	150	23.75	\$955	\$1033	N/A	N/A

One fixed shelf **and fixed shelf divider**. Closed back features one grommet and flexible sweep for wire management. Shipped assembled in 1 carton.

- Hutch with 1" top clearance from work surface to valance is 17.75"; with 1.5" top clearance is 17.25".
- Woodgrain runs horizontal on both the upper and lower back panels.

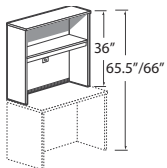

**Open Hutch with Closed Back
36" High**

Z48S36HN	48 x 15 x 36	123	19	\$788	\$851	N/A	N/A
Z42S36HN	42 x 15 x 36	112	16.75	\$727	\$784	N/A	N/A
Z36S36HN	36 x 15 x 36	100	14.5	\$669	\$719	N/A	N/A
Z30S36HN	30 x 15 x 36	89	12.25	\$606	\$648	N/A	N/A

One fixed shelf. Closed back features one grommet and flexible sweep for wire management.

Shipped assembled in 1 carton.

- Hutch with 1" top clearance from work surface to valance is 17.75"; hutch with 1.5" top clearance is 17.25".
- Woodgrain runs horizontal on both the upper and lower back panels.

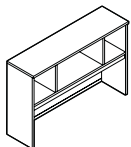

**Open Hutch with Closed Back
36" High**

Z72S360HN	72 x 15 x 36	162	27.75	\$1502	\$1622	N/A	N/A
Z66S360HN	66 x 15 x 36	152	25.5	\$1422	\$1532	N/A	N/A
Z60S360HN	60 x 15 x 36	142	23.25	\$1337	\$1436	N/A	N/A
Z54S360HN	54 x 15 x 36	133	21	\$1252	\$1343	N/A	N/A

Four compartments. Closed back features one grommet and flexible sweep for wire management.

Shipped assembled in 1 carton.

- Hutch with 1" top clearance from work surface to valance is 17.75"; hutch with 1.5" top clearance is 17.25".
- Woodgrain runs horizontal on both the upper and lower back panels.

Required specifications

Top finish
Top thickness/edge detail
Base finish

Optional specifications

HP laminate*

Accessories

Tackboard

OPEN HUTCHES

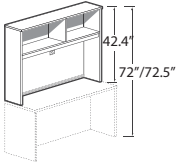

**Open Hutch with Closed Back
42.4" High**

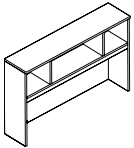

**Open Hutch w/Closed Back
42.4" High**

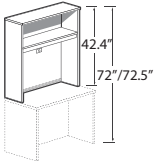

**Open Hutch with Closed Back
42.4" High**

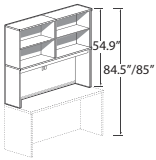

**Open Hutch with Closed Back
54.9" High**

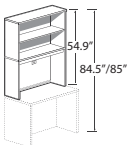

**Open Hutch with Closed Back
54.9" High**

MODEL #	DIMENSIONS	WT/LB.	CUBIC FT.	1" TOP	1.5" TOP	GLAZE ADD	HP ADD
---------	------------	--------	-----------	--------	----------	-----------	--------

W x D x H (1.5 TOP)

Z84S42HN	84 x 15 x 42.4	223	38.5	\$1273	\$1381	N/A	N/A
Z72S42HN	72 x 15 x 42.4	196	33	\$1175	\$1266	N/A	N/A
Z71S42HN	71.7 x 15 x 42.4	188	33	\$1166	\$1257	N/A	N/A
Z66S42HN	66 x 15 x 42.4	175	30.75	\$1100	\$1187	N/A	N/A
Z60S42HN	60 x 15 x 42.4	164	27.75	\$1030	\$1108	N/A	N/A

One fixed shelf **and fixed shelf divider**. Closed back features one grommet and flexible sweep for wire management.

Shipped assembled in 1 carton.

- Hutch with 1" top clearance from work surface to valance is 24.25"; hutch with 1.5" top clearance is 23.75".
- Woodgrain runs horizontal on both the upper and lower back panels.

Z72S42OHN	72 x 15 x 42.4	177	32.5	\$1676	\$1785	N/A	N/A
Z66S42OHN	66 x 15 x 42.4	166	29.75	\$1536	\$1635	N/A	N/A
Z60S42OHN	60 x 15 x 42.4	155	27.25	\$1444	\$1533	N/A	N/A
Z54S42OHN	54 x 15 x 42.4	145	24.5	\$1352	\$1433	N/A	N/A

Four compartments. Closed back features one grommet and flexible sweep for wire management.

Shipped assembled in 1 carton.

- Hutch with 1" top clearance from work surface to valance is 24.25"; hutch with 1.5" top clearance is 23.75".
- Woodgrain runs horizontal on both the upper and lower back panels.

Z48S42HN	48 x 15 x 42.4	134	22.25	\$851	\$914	N/A	N/A
Z42S42HN	42 x 15 x 42.4	123	19.5	\$788	\$845	N/A	N/A
Z36S42HN	36 x 15 x 42.4	110	17	\$721	\$771	N/A	N/A
Z30S42HN	30 x 15 x 42.4	105	14.25	\$653	\$695	N/A	N/A

One fixed shelf. Closed back features one grommet and flexible sweep for wire management.

Shipped assembled in 1 carton.

- Hutch with 1" top clearance from work surface to valance is 24.25"; hutch with 1.5" top clearance is 23.75".
- Woodgrain runs horizontal on both the upper and lower back panels.

Z84S55HN	84 x 15 x 54.9	306	62.5	\$2088	\$2200	N/A	N/A
Z72S55HN	72 x 15 x 54.9	272	53.75	\$1945	\$2042	N/A	N/A
Z71S55HN	71.7 x 15 x 54.9	271	53.75	\$1937	\$2034	N/A	N/A
Z66S55HN	66 x 15 x 54.9	254	49.5	\$1873	\$1967	N/A	N/A
Z60S55HN	60 x 15 x 54.9	238	45.25	\$1675	\$1759	N/A	N/A

One fixed shelf and one adjustable shelf (per compartment). Closed back features one grommet and flexible sweep for wire management. Shipped easy to assemble in 3 cartons.

- Hutch with 1" top clearance from work surface to valance is 24.25"; with 1.5" top clearance is 23.75".
- Woodgrain runs horizontal on both the upper and lower back panels.

Z48S55HN	48 x 15 x 54.9	183	36	\$1258	\$1321	N/A	N/A
Z42S55HN	42 x 15 x 54.9	168	31.5	\$1164	\$1221	N/A	N/A
Z36S55HN	36 x 15 x 54.9	149	27.25	\$1059	\$1109	N/A	N/A
Z30S55HN	30 x 15 x 54.9	132	23	\$963	\$1005	N/A	N/A

One fixed shelf and one adjustable shelf. Closed back features one grommet and flexible sweep for wire management.

Shipped easy to assemble in 2 cartons.

- Hutch with 1" top clearance from work surface to valance is 24.25"; hutch with 1.5" top clearance is 23.75".
- Woodgrain runs horizontal on both the upper and lower back panels.

Required specifications

Top finish
Top thickness/edge detail
Base finish
Handles*

Optional specifications

Key #*
Glazed doors*

Accessories

Tackboard
Pigeon-hole storage

OPEN HUTCHES **MODEL #** **DIMENSIONS** **WT/LB.** **CUBIC FT.** **1" TOP** **1.5" TOP** **GLAZE ADD** **HP ADD**

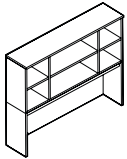

Open Hutch w/Closed Back
54.9"/55.4"H

W x D x H (1.5 TOP)

Z72S550HN	72 x 15 x 54.9	242	26	\$2471	\$2585	N/A	N/A
Z66S550HN	66 x 15 x 54.9	228	24	\$2328	\$2435	N/A	N/A
Z60S550HN	60 x 15 x 54.9	214	22	\$2190	\$2286	N/A	N/A
Z54S550HN	54 x 15 x 54.9	199	19.75	\$2055	\$2142	N/A	N/A

Four compartments. Closed back features one grommet and flexible sweep for wire management. -

Shipped easy to assemble in 2 cartons

- Hutch with 1" top clearance from work surface to valance is 24.25"; hutch with 1.5" top clearance is 23.75".
- Woodgrain runs horizontal on both the upper and lower back panels.

CLOSED HUTCHES

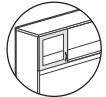
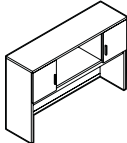

Glazed door option

Hutch with 2 Outer Doors 36" High*

Z72S36HOH	72 x 15 x 36	172	27.75	\$1760	\$1880	\$548	N/A
Z66S36HOH	66 x 15 x 36	161	25.5	\$1680	\$1791	\$532	N/A
Z60S36HOH	60 x 15 x 36	151	23.25	\$1576	\$1676	\$491	N/A
Z54S36HOH	54 x 15 x 36	140	21	\$1488	\$1579	\$476	N/A

Four compartments. **Doors on outer compartments only.** Closed back features one grommet and flexible sweep for wire management. Doors lock. Shipped assembled in 1 carton.

- Hutch with 1" top clearance from work surface to valance is 17.75"; hutch with 1.5" top clearance is 17.25".
- Woodgrain runs horizontal on both the upper and lower back panels.

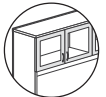
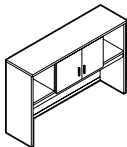

Glazed door option

Hutch with 2 Inner Doors 36" High*

Z72S36OHO	72 x 15 x 36	173	27.75	\$1757	\$1884	\$553	N/A
Z66S36OHO	66 x 15 x 36	162	25.5	\$1683	\$1793	\$537	N/A
Z60S36OHO	60 x 15 x 36	151	23.25	\$1596	\$1695	\$518	N/A
Z54S36OHO	54 x 15 x 36	141	21	\$1492	\$1582	\$483	N/A

Four compartments. **Doors on inner compartments only.** Closed back features one grommet and flexible sweep for wire management. Doors lock. Shipped assembled in 1 carton.

- Hutch with 1" top clearance from work surface to valance is 17.75"; hutch with 1.5" top clearance is 17.25".
- Woodgrain runs horizontal on both the upper and lower back panels.

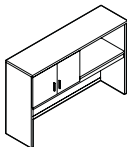

Glazed door option

Hutch with 2 Doors 36" High - LEFT*

Z72S36HSL	72 x 15 x 36	169	27.75	\$1722	\$1842	\$547	N/A
Z66S36HSL	66 x 15 x 36	157	25.5	\$1641	\$1751	\$529	N/A
Z60S36HSL	60 x 15 x 36	146	23.25	\$1536	\$1636	\$492	N/A
Z54S36HSL	54 x 15 x 36	135	21	\$1449	\$1540	\$483	N/A

Hinged doors on **left** side, open storage on **right**. Closed back features one grommet and flexible sweep for wire management. Doors lock. Shipped assembled in 1 carton.

- Hutch with 1" top clearance from work surface to valance is 17.75"; hutch with 1.5" top clearance is 17.25".
- Woodgrain runs horizontal on both the upper and lower back panels.

Required specifications

- Top finish
- Top thickness/edge detail
- Base finish
- Handles*

Optional specifications

- Key #*
- Glazed doors*

Accessories

- Tackboard
- Pigeon-hole storage

CLOSED HUTCHES

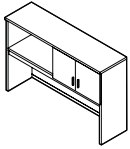

Glazed door option

Hutch with 2 Doors 36" High - RIGHT*

MODEL #	DIMENSIONS W x D x H (1.5" TOP)	WT/LB.	CUBIC FT.	1" TOP	1.5" TOP	GLAZE ADD	HP ADD
Z72S36HSR	72 x 15 x 36	169	27.75	\$1722	\$1842	\$547	N/A
Z66S36HSR	66 x 15 x 36	157	25.5	\$1641	\$1751	\$529	N/A
Z60S36HSR	60 x 15 x 36	146	23.25	\$1536	\$1636	\$492	N/A
Z54S36HSR	54 x 15 x 36	135	21	\$1449	\$1540	\$483	N/A

Hinged doors on **right** side, open storage on **left**. Closed back features one grommet and flexible sweep for wire management. Doors lock. Shipped assembled in 1 carton.

- Hutch with 1" top clearance from work surface to valance is 17.75"; hutch with 1.5" top clearance is 17.25".
- Woodgrain runs horizontal on both the upper and lower back panels.

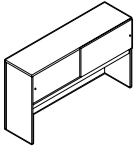

Hutch w/Sliding Glass Doors 36" High

Z72S36HSD	72 x 15 x 36	178	29.3	\$3759	\$3880	N/A	N/A
Z66S36HSD	66 x 15 x 36	166	26.9	\$3510	\$3620	N/A	N/A
Z60S36HSD	60 x 15 x 36	154	24.5	\$3256	\$3356	N/A	N/A
Z54S36HSD	54 x 15 x 36	143	22.1	\$3011	\$3111	N/A	N/A

Sliding glass doors do not lock. Closed back features one grommet and flexible sweep for wire management. Shipped assembled in 2 cartons (glass doors shipped separately).

- Hutch with 1" top clearance from work surface to valance is 17.75"; hutch with 1.5" top clearance is 17.25".
- Woodgrain runs horizontal on both the upper and lower back panels.

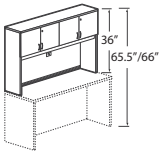

Glazed door option

Closed Hutch with Doors 36" High*

Z84S36H	84 x 15 x 36	231	33	\$1639	\$1747	\$1322	N/A
Z72S36H	72 x 15 x 36	201	28.25	\$1522	\$1613	\$1207	N/A
Z71S36H	71.7 x 15 x 36	193	28.25	\$1511	\$1602	\$1205	N/A
Z66S36H	66 x 15 x 36	179	26	\$1436	\$1523	\$1146	N/A
Z60S36H	60 x 15 x 36	167	23.75	\$1337	\$1415	\$1077	N/A

One fixed shelf **and fixed shelf divider**. Closed back features one grommet and flexible sweep for wire management. Doors lock. Shipped assembled in 1 carton.

- Hutch with 1" top clearance from work surface to valance is 17.75"; with 1.5" top clearance is 17.25".
- Woodgrain runs horizontal on both the upper and lower back panels.

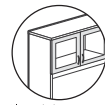
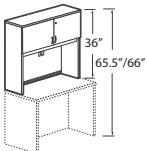

Glazed door option

Closed Hutch with Doors 36" High*

Z48S36H	48 x 15 x 36	136	19	\$1048	\$1111	\$686	N/A
Z42S36H	42 x 15 x 36	124	16.75	\$952	\$1009	\$661	N/A
Z36S36H	36 x 15 x 36	110	14.5	\$870	\$920	\$605	N/A
Z30S36H	30 x 15 x 36	98	12.25	\$793	\$835	\$542	N/A

One fixed shelf. Closed back features one grommet and flexible sweep for wire management. Doors lock. Shipped assembled in 1 carton.

- Hutch with 1" top clearance from work surface to valance is 17.75"; with 1.5" top clearance is 17.25".
- Woodgrain runs horizontal on both the upper and lower back panels.

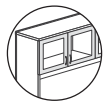
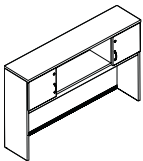

Glazed door option

Hutch with 2 Outer Doors 42.4" High*

Z72S42HOH	72 x 15 x 42.4	187	32.5	\$1937	\$2046	\$548	N/A
Z66S42HOH	66 x 15 x 42.4	176	29.75	\$1792	\$1892	\$532	N/A
Z60S42HOH	60 x 15 x 42.4	164	27.25	\$1681	\$1772	\$491	N/A
Z54S42HOH	54 x 15 x 42.4	153	24.5	\$1588	\$1669	\$476	N/A

Four compartments. **Doors on outer compartments only**. Closed back features one grommet and flexible sweep for wire management. Doors lock. Shipped assembled in 1 carton.

- Hutch with 1" top clearance from work surface to valance is 24.25"; hutch with 1.5" top clearance is 23.75".
- Woodgrain runs horizontal on both the upper and lower back panels.

Required specifications

Top finish
Top thickness/edge detail
Base finish
Handles*

Optional specifications

Key #*
Glazed doors*

Accessories

Tackboard
Pigeon-hole storage

CLOSED HUTCHES **MODEL #** **DIMENSIONS** **WT/LB.** **CUBIC FT.** **1" TOP** **1.5" TOP** **GLAZE ADD** **HP ADD**

W x D x H (1.5" TOP)

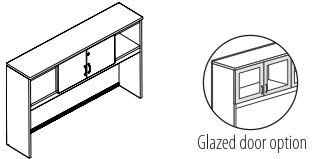

Hutch with 2 Inner Doors 42.4" High*

Z72S42OHO	72 x 15 x 42.4	188	32.5	\$1939	\$2049	\$553	N/A
Z66S42OHO	66 x 15 x 42.4	176	29.75	\$1796	\$1895	\$537	N/A
Z60S42OHO	60 x 15 x 42.4	165	27.25	\$1704	\$1793	\$518	N/A
Z54S42OHO	54 x 15 x 42.4	153	24.5	\$1592	\$1673	\$483	N/A

Four compartments. **Doors on inner compartments only.** Closed back features one grommet and flexible sweep for wire management. Doors lock. Shipped assembled in 1 carton.

- Hutch with 1" top clearance from work surface to valance is 24.25"; hutch with 1.5" top clearance is 23.75".
- Woodgrain runs horizontal on both the upper and lower back panels.

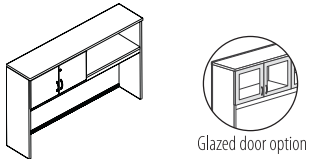

Hutch with 2 Doors 42.4" High - LEFT*

Z72S42HSL	72 x 15 x 42.4	184	32.5	\$1896	\$2005	\$547	N/A
Z66S42HSL	66 x 15 x 42.4	171	29.75	\$1750	\$1850	\$529	N/A
Z60S42HSL	60 x 15 x 42.4	159	27.25	\$1642	\$1731	\$492	N/A
Z54S42HSL	54 x 15 x 42.4	148	24.5	\$1549	\$1630	\$483	N/A

Hinged doors on **left** side, open storage on **right**. Closed back features one grommet and flexible sweep for wire management. Doors lock. Shipped assembled in 1 carton.

- Hutch with 1" top clearance from work surface to valance is 24.25"; hutch with 1.5" top clearance is 23.75".
- Woodgrain runs horizontal on both the upper and lower back panels.

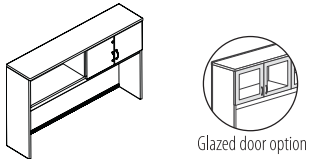

Hutch with 2 Doors 42.4" High - RIGHT*

Z72S42HSR	72 x 15 x 42.4	184	32.5	\$1896	\$2005	\$547	N/A
Z66S42HSR	66 x 15 x 42.4	171	29.75	\$1750	\$1850	\$529	N/A
Z60S42HSR	60 x 15 x 42.4	159	27.25	\$1642	\$1731	\$492	N/A
Z54S42HSR	54 x 15 x 42.4	148	24.5	\$1549	\$1630	\$483	N/A

Hinged doors on **right** side, open storage on **left**. Closed back features one grommet and flexible sweep for wire management. Doors lock. Shipped assembled in 1 carton.

- Hutch with 1" top clearance from work surface to valance is 24.25"; hutch with 1.5" top clearance is 23.75".
- Woodgrain runs horizontal on both the upper and lower back panels.

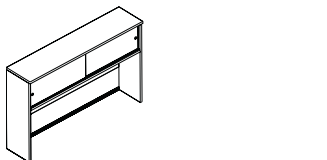

Hutch w/Sliding Glass Doors 42.4" High

Z72S42HSD	72 x 15 x 42.4	193	34	\$3926	\$4036	N/A	N/A
Z66S42HSD	66 x 15 x 42.4	180	31.2	\$3620	\$3719	N/A	N/A
Z60S42HSD	60 x 15 x 42.4	168	24.5	\$3359	\$3449	N/A	N/A
Z54S42HSD	54 x 15 x 42.4	156	25.6	\$3111	\$3192	N/A	N/A

Sliding glass doors do not lock. Closed back features one grommet and flexible sweep for wire management. Shipped assembled in 2 cartons (glass doors shipped separately).

- Hutch with 1" top clearance from work surface to valance is 24.25"; hutch with 1.5" top clearance is 23.75".
- Woodgrain runs horizontal on both the upper and lower back panels.

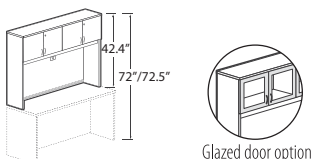

Closed Hutch with Doors 42.4" High

Z84S42H	84 x 15 x 42.4	247	38.5	\$1818	\$1926	\$1322	N/A
Z72S42H	72 x 15 x 42.4	217	33	\$1609	\$1700	\$1207	N/A
Z71S42H	71.7 x 15 x 42.4	207	33	\$1599	\$1690	\$1205	N/A
Z66S42H	66 x 15 x 42.4	194	30.75	\$1514	\$1601	\$1146	N/A
Z60S42H	60 x 15 x 42.4	180	27.75	\$1412	\$1490	\$1077	N/A

One fixed shelf **and fixed shelf divider**. Closed back features one grommet and flexible sweep for wire management. Doors lock. Shipped assembled in 1 carton.

- Hutch with 1" top clearance from work surface to valance is 24.25"; with 1.5" top clearance is 23.75".
- Woodgrain runs horizontal on both the upper and lower back panels.

Required specifications

- Top finish
- Top thickness/edge detail
- Base finish
- Handles*

Optional specifications

- Key #*
- Glazed doors*

Accessories

- Tackboard
- Pigeon-hole storage

CLOSED HUTCHES

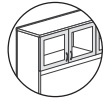
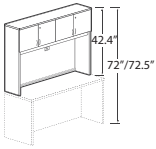

Glazed door option

Closed Hutch with Doors 42.4" High

MODEL #	DIMENSIONS W x D x H (1.5" TOP)	WT/LB.	CUBIC FT.	1" TOP	1.5" TOP	GLAZE ADD	HP ADD
Z48S42H	48 x 15 x 42.4	148	22.25	\$1113	\$1176	\$686	N/A
Z42S42H	42 x 15 x 42.4	134	19.5	\$1008	\$1065	\$661	N/A
Z36S42H	36 x 15 x 42.4	120	17	\$923	\$973	\$605	N/A
Z30S42H	30 x 15 x 42.4	106	14.25	\$845	\$887	\$542	N/A

One fixed shelf. Closed back features one grommet and flexible sweep for wire management. Doors lock. Shipped assembled in 1 carton.

- Hutch with 1" top clearance from work surface to valance is 24.25"; with 1.5" top clearance is 23.75".
- Woodgrain runs horizontal on both the upper and lower back panels.

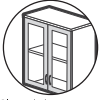
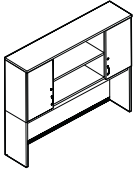

Glazed door option

Hutch with 2 Outer Doors 55" High

Z72S55HOH	72 x 15 x 54.9	262	26	\$2822	\$2935	\$785	N/A
Z66S55HOH	66 x 15 x 54.9	246	24	\$2675	\$2781	\$768	N/A
Z60S55HOH	60 x 15 x 54.9	229	22	\$2499	\$2673	\$699	N/A
Z54S55HOH	54 x 15 x 54.9	213	19.75	\$2363	\$2527	\$683	N/A

Hinged doors on outer compartments only. Closed back features one grommet and flexible sweep for wire management. Doors lock. Shipped easy to assemble in 2 cartons.

- Hutch with 1" top clearance from work surface to valance is 24.25"; with 1.5" top clearance is 23.75".
- Woodgrain runs horizontal on both the upper and lower back panels.

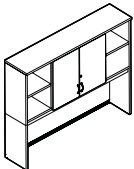

Glazed door option

Hutch with 2 Inner Doors 55" High

Z72S55OHO	72 x 15 x 54.9	263	26	\$2824	\$2938	\$788	N/A
Z66S55OHO	66 x 15 x 54.9	247	24	\$2677	\$2784	\$774	N/A
Z60S55OHO	60 x 15 x 54.9	230	22	\$2538	\$2634	\$703	N/A
Z54S55OHO	54 x 15 x 54.9	214	19.75	\$2365	\$2452	\$689	N/A

Hinged doors on inner compartments only. Closed back features one grommet and flexible sweep for wire management. Doors lock. Shipped easy to assemble in 2 cartons.

- Hutch with 1" top clearance from work surface to valance is 24.25"; with 1.5" top clearance is 23.75".
- Woodgrain runs horizontal on both the upper and lower back panels.

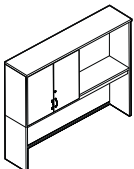

Glazed door option

Hutch with 2 Doors 55" High - LEFT

Z72S55HSL	72 x 15 x 54.9	258	26	\$2726	\$2839	\$757	N/A
Z66S55HSL	66 x 15 x 54.9	237	24	\$2602	\$2708	\$743	N/A
Z60S55HSL	60 x 15 x 54.9	221	22	\$2413	\$2509	\$699	N/A
Z54S55HSL	54 x 15 x 54.9	204	19.75	\$2290	\$2377	\$689	N/A

Hinged doors on left side, open storage on right. Closed back features one grommet and flexible sweep for wire management. Doors lock. Shipped easy to assemble in 2 cartons.

- Hutch with 1" top clearance from work surface to valance is 24.25"; with 1.5" top clearance is 23.75".
- Woodgrain runs horizontal on both the upper and lower back panels.

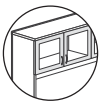
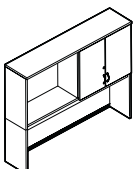

Glazed door option

Hutch with 2 Doors 55" High - RIGHT*

Z72S55HSR	72 x 15 x 54.9	258	26	\$2726	\$2839	\$757	N/A
Z66S55HSR	66 x 15 x 54.9	237	24	\$2602	\$2708	\$743	N/A
Z60S55HSR	60 x 15 x 54.9	221	22	\$2413	\$2509	\$699	N/A
Z54S55HSR	54 x 15 x 54.9	204	19.75	\$2290	\$2377	\$689	N/A

Hinged doors on right side, open storage on left. Closed back features one grommet and flexible sweep for wire management. Doors lock. Shipped easy to assemble in 2 cartons.

- Hutch with 1" top clearance from work surface to valance is 24.25"; with 1.5" top clearance is 23.75".
- Woodgrain runs horizontal on both the upper and lower back panels.

Required specifications

Top finish
Top thickness/edge detail
Base finish
Handles*

Optional specifications

Key #*
Glazed doors*

Accessories

Tackboard
Pigeon-hole storage

CLOSED HUTCHES

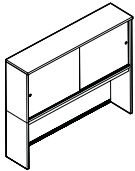

Hutch w/Sliding Glass Doors 55" High*

MODEL #	DIMENSIONS W x D x H	WT/LB.	CUBIC FT.	1" TOP	1.5" TOP	GLAZE ADD	HP ADD
Z72S55HSD	72 x 15 x 54.9	271	28.6	\$5336	\$5449	N/A	N/A
Z66S55HSD	66 x 15 x 54.9	253	26.4	\$4989	\$5095	N/A	N/A
Z60S55HSD	60 x 15 x 54.9	235	24.2	\$4617	\$4713	N/A	N/A
Z54S55HSD	54 x 15 x 54.9	217	21.8	\$4276	\$4363	N/A	N/A

Sliding glass doors do not lock. Closed back features one grommet and flexible sweep for wire management. Shipped easy to assemble in 3 cartons (glass doors shipped separately).

- Hutch with 1" top clearance from work surface to valance is 24.25"; with 1.5" top clearance is 23.75".
- Woodgrain runs horizontal on both the upper and lower back panels.

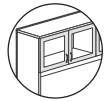
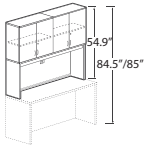

Glazed door option

Closed Hutch w/Doors 54.9" High*

Z84S55H	84 x 15 x 54.9	349	62.5	\$2761	\$2873	\$1924	N/A
Z72S55H	72 x 15 x 54.9	308	53.75	\$2487	\$2598	\$1737	N/A
Z71S55H	71.7 x 15 x 54.9	307	53.75	\$2477	\$2574	\$1720	N/A
Z66S55H	66 x 15 x 54.9	287	49.5	\$2346	\$2440	\$1637	N/A
Z60S55H	60 x 15 x 54.9	269	45.25	\$2156	\$2240	\$1521	N/A

One fixed shelf and one adjustable shelf (per compartment). Closed back features one grommet and flexible sweep for wire management. Doors lock. Shipped easy to assemble in 3 cartons.

- Hutch with 1" top clearance from work surface to valance is 24.25"; with 1.5" top clearance is 23.75".
- Woodgrain runs horizontal on both the upper and lower back panels.

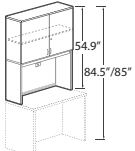

Glazed door option

Closed Hutch w/Doors 54.9" High*

Z48S55H	48 x 15 x 54.9	207	36	\$1601	\$1652	\$1062	N/A
Z42S55H	42 x 15 x 54.9	188	31.5	\$1459	\$1516	\$961	N/A
Z36S55H	36 x 15 x 54.9	167	27.25	\$1330	\$1380	\$870	N/A
Z30S55H	30 x 15 x 54.9	148	23	\$1202	\$1244	\$761	N/A

One fixed shelf and one adjustable shelf. Closed back features one grommet and flexible sweep for wire management. Doors lock. Shipped easy to assemble in 2 cartons.

- Hutch with 1" top clearance from work surface to valance is 24.25"; with 1.5" top clearance is 23.75".
- Woodgrain runs horizontal on both the upper and lower back panels.

PIGEON-HOLE STORAGE

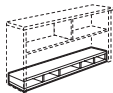
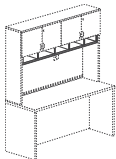

Horizontal Pigeon-Hole Storage**

ZHS84	82 x 12 x 5.7	49	3.34	\$803	N/A	N/A	N/A
ZHS72	70 x 12 x 5.7	49	3	\$699	N/A	N/A	N/A
ZHS71	69.6 x 12 x 5.7	49	3	\$699	N/A	N/A	N/A
ZHS66	63.9 x 12 x 5.7	46	2.8	\$658	N/A	N/A	N/A
ZHS60	58 x 12 x 5.7	42	2.5	\$630	N/A	N/A	N/A
ZHS48	45.9 x 12 x 5.7	33	2	\$470	N/A	N/A	N/A
ZHS42	40 x 12 x 5.7	29	2	\$439	N/A	N/A	N/A
ZHS36	33.9 x 12 x 5.7	26	2	\$414	N/A	N/A	N/A

For additional storage. Can be **top** or **bottom** mounted. For use with hutches (as shown only). Shipped easy to assemble in 1 carton.

- Available in all standard laminate finishes, see page 111.

Required specifications

Top finish* Shell finish**
 Top thickness/edge detail*
 Base finish*
 Handles*

Optional specifications

Key #*
 Glazed doors (only ZxxS55H)

Accessories

Tackboard*
 Pigeon-hole storage*

PIGEON-HOLE STORAGE

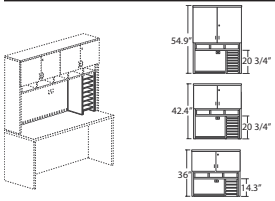

Vertical Pigeon-Hole Storage**

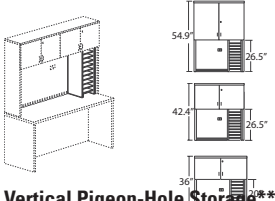

Vertical Pigeon-Hole Storage**

MODEL #	DIMENSIONS	WT/LB.	CUBIC FT.	1" TOP	1.5" TOP	GLAZE ADD	HP ADD
W x D x H							
ZVS21	13.42 x 11.81 x 20.24	30	1.8	\$352	N/A	N/A	N/A
ZVS14	13.42 x 11.81 x 13.83	24	1.8	\$287	N/A	N/A	N/A

For use in conjunction with horizontal pigeon-hole storage. Can be used **under** or **over** horizontal unit. **Not freestanding.** Shipped easy to assemble in 1 carton.

- Vertical pigeon-hole shell - available in all standard laminate finishes, see page 111.
- Collator shelves - available in Black (BK) or Brushed Cobalt (BC) finish, please specify.
Use Brushed Cobalt to match Silver finish handles.
- When used together with tackboard and hutch, reduce tackboard width by 12.5".

ZVS26	13.42 x 11.81 x 25.91	36	1.8	\$425	N/A	N/A	N/A
ZVS20	13.42 x 11.81 x 19.5	29	1.8	\$340	N/A	N/A	N/A

Not freestanding. Shipped easy to assemble in 1 carton.

- Vertical pigeon-hole shell - available in all standard laminate finishes, see page 111.
- Collator shelves - available in Black (BK) or Brushed Cobalt (BC) finish, please specify.
Use Brushed Cobalt to match Silver finish handles.
- Removal of valence required.
- When used together with tackboard and hutch, reduce tackboard width by 12.5".

TRANSITIONAL PIGEON-HOLE STORAGE

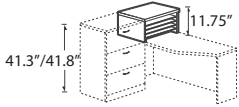

Transitional Pigeon-Hole Storage 11.75" High*

W x D x H (1.5" TOP)

Z24L12PH	24 x 24 x 11.75	63	2.7	\$702	\$770	N/A	N/A
Z20L12PH	20 x 24 x 11.75	56	2.7	\$619	\$676	N/A	N/A
Z16L12PH	16 x 24 x 11.75	46	1.6	\$567	\$618	N/A	N/A
Z24M12PH	24 x 20 x 11.75	55	2.7	\$619	\$676	N/A	N/A
Z20M12PH	20 x 20 x 11.75	48	2.7	\$549	\$597	N/A	N/A
Z16M12PH	16 x 20 x 11.75	40	1.6	\$499	\$538	N/A	N/A
Z24S12PH	24 x 16 x 11.75	43	1.6	\$570	\$620	N/A	N/A
Z20S12PH	20 x 16 x 11.75	38	1.6	\$503	\$540	N/A	N/A
Z16S12PH	16 x 16 x 11.75	33	1.6	\$471	\$505	N/A	N/A

Designed to fit on top of returns and transition worksurface to match 41.3"/41.8" high storage modules. Pigeon-hole shell and four collator shelves. Shipped easy to assemble in 1 carton.

- Pigeon-hole shell - available in all standard laminate finishes, see page 111.
- Collator shelves - available in Black (BK) or Brushed Cobalt (BC) finish, please specify.
Use Brushed Cobalt to match Silver finish handles.

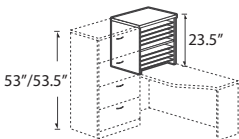

Transitional Pigeon-Hole Storage 23.5" High*

Z24L23PH	24 x 24 x 23.5	101	2.7	\$1271	\$1337	N/A	N/A
Z20L23PH	20 x 24 x 23.5	88	2.7	\$1111	\$1168	N/A	N/A
Z16L23PH	16 x 24 x 23.5	76	2.7	\$1038	\$1089	N/A	N/A
Z24M23PH	24 x 20 x 23.5	87	2.7	\$1113	\$1170	N/A	N/A
Z20M23PH	20 x 20 x 23.5	76	2.7	\$972	\$1020	N/A	N/A
Z16M23PH	16 x 20 x 23.5	64	1.6	\$891	\$930	N/A	N/A
Z24S23PH	24 x 16 x 23.5	74	2.7	\$1052	\$1102	N/A	N/A
Z20S23PH	20 x 16 x 23.5	65	2.7	\$920	\$959	N/A	N/A
Z16S23PH	16 x 16 x 23.5	54	1.6	\$842	\$876	N/A	N/A

Designed to fit on top of returns and transition worksurface to match 53"/53.5" high storage modules. Pigeon-hole shell and eight collator shelves. Shipped easy to assemble in 1 carton.

- Pigeon-hole shell - available in all standard laminate finishes, see page 111.
- Collator shelves - available in Black (BK) or Brushed Cobalt (BC) finish, please specify.
Use Brushed Cobalt to match Silver finish handles.

Required specifications

- Top finish*
- Top thickness/edge detail*
- Base finish*
- Shell finish**

FLOATING SHELVES **MODEL #** **DIMENSIONS** **WT/LB.** **CUBIC FT.** **1" TOP** **1.5" TOP** **GLAZE ADD** **HP ADD**

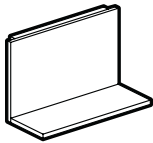

Floating Shelf 20" High

	W x D x H (1.5" TOP)							
ZFS4220	42 x 14.25 x 20	55	2.75	\$684	\$726	N/A	N/A	
ZFS3620	36 x 14.25 x 20	47	2.4	\$615	\$651	N/A	N/A	
ZFS3020	30 x 14.25 x 20	39	2	\$523	\$553	N/A	N/A	
ZFS2420	24 x 14.25 x 20	33	1.9	\$463	\$492	N/A	N/A	

To match 71.9"/72.4"H units. Standard with pre-mounted "J" bracket for wall mount applications. End cap required at the end of a run of floating shelves. End cap sold separately, see page 236. Shipped easy to assemble in 1 carton.

• **NOTE:** Care should be taken to mount the units. Units should be mounted to wall studs using correct fasteners. Failure to do so may result in collapse of the unit and subsequent personal injury. **Fastening hardware not included.** Mounting hardware used should be based on wall material. Consult an installation professional for proper wall mounting.

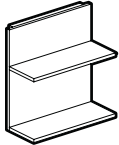

Double Floating Shelf 32.5" High

ZF2S4232	42 x 14.25 x 32.5	85	3.3	\$980	\$1022	N/A	N/A	
ZF2S3632	36 x 14.25 x 32.5	73	2.9	\$877	\$913	N/A	N/A	
ZF2S3032	30 x 14.25 x 32.5	60	2.5	\$746	\$776	N/A	N/A	
ZF2S2432	24 x 14.25 x 32.5	50	2.4	\$659	\$689	N/A	N/A	

To match 84.4"/84.9"H units. Standard with pre-mounted "J" bracket for wall mount applications. End cap required at the end of a run of floating shelves. End cap sold separately, see page 236. Shipped easy to assemble in 1 carton.

• **NOTE:** Care should be taken to mount the units. Units should be mounted to wall studs using correct fasteners. Failure to do so may result in collapse of the unit and subsequent personal injury. **Fastening hardware not included.** Mounting hardware used should be based on wall material. Consult an installation professional for proper wall mounting.

WALLS W/OVERHEADS

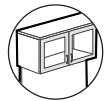
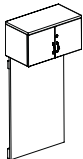

Glazed door option

Wall w/Closed Storage 66" High*

Z4266WS	42 x 16 x 66	122	8.25	\$1650	\$1717	\$600	N/A	
Z3666WS	36 x 16 x 66	113	8.8	\$1525	\$1567	\$550	N/A	
Z3066WS	30 x 16 x 66	97	7.5	\$1390	\$1429	\$491	N/A	
Z2466WS	24 x 16 x 66	79	6.6	\$1227	\$1269	\$443	N/A	

Standard with pre-mounted "J" bracket for wall mount applications. Doors lock. End cap required at the end of a run of wall units. End cap sold separately, see page 236. Shipped easy to assemble in 2 cartons.

• **NOTE:** Care should be taken to mount the units. Units should be mounted to wall studs using correct fasteners. Failure to do so may result in collapse of the unit and subsequent personal injury. **Mounting hardware not included.** Mounting hardware used should be based on wall material. Consult an installation professional for proper wall mounting.

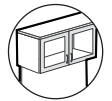
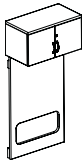

Glazed door option

Wall w/Closed Storage and Access Cut-Out 66" High*

Z4266WSO	42 x 16 x 66	112	9.3	\$1760	\$1828	\$600	N/A	
Z3666WSO	36 x 16 x 66	100	8.1	\$1602	\$1663	\$550	N/A	
Z3066WSO	30 x 16 x 66	85	6.75	\$1395	\$1452	\$491	N/A	
Z2466WSO	24 x 16 x 66	70	6.2	\$1238	\$1279	\$443	N/A	

Standard with pre-mounted "J" bracket for wall mount applications. Doors lock. Large cutout provides direct access to wall for access to electrical. End cap required at the end of a run of wall units. End cap sold separately, see page 236. Shipped easy to assemble in 2 cartons.

• **NOTE:** Care should be taken to mount the units. Units should be mounted to wall studs using correct fasteners. Failure to do so may result in collapse of the unit and subsequent personal injury. **Mounting hardware not included.** Mounting hardware used should be based on wall material. Consult an installation professional for proper wall mounting.

Required specifications

Top finish	Handles*
Top thickness/edge detail	
Wall finish	
Shelf or door finish if laminate doors	

Optional specifications

Key #*
Glazed doors*
Grommet position*
End filler cap

WALLS W/OVERHEADS MODEL # DIMENSIONS WT/LB. CUBIC FT. 1" TOP 1.5" TOP GLAZE ADD HP ADD

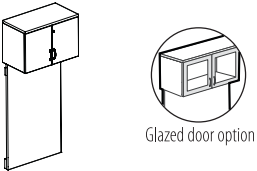

Wall w/Closed Storage 72" High*

W x D x H (1.5" TOP)

Z4272WS	42 x 16 x 72.4	134	10.2	\$1760	\$1848	\$689	N/A
Z3672WS	36 x 16 x 72.4	119	9.45	\$1695	\$1772	\$628	N/A
Z3072WS	30 x 16 x 72.4	102	8.1	\$1491	\$1555	\$561	N/A
Z2472WS	24 x 16 x 72.4	84	6.6	\$1307	\$1358	\$510	N/A

Standard with pre-mounted "J" bracket for wall mount applications. Doors lock. End cap required at the end of a run of wall units. End cap sold separately, see page 236. Shipped easy to assemble in 2 cartons.

• **NOTE:** Care should be taken to mount the units. Units should be mounted to wall studs using correct fasteners. Failure to do so may result in collapse of the unit and subsequent personal injury. **Mounting hardware not included.** Mounting hardware used should be based on wall material. Consult an installation professional for proper wall mounting.

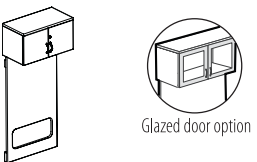

Wall w/Closed Storage and Access Cut-Out 72" High*

Z4272WSO	42 x 16 x 72.4	120	9.3	\$1777	\$1864	\$689	N/A
Z3672WSO	36 x 16 x 72.4	105	8.65	\$1711	\$1788	\$628	N/A
Z3072WSO	30 x 16 x 72.4	91	7.5	\$1503	\$1590	\$561	N/A
Z2472WSO	24 x 16 x 72.4	74	6.2	\$1317	\$1369	\$510	N/A

Standard with pre-mounted "J" bracket for wall mount applications. Doors lock. Large cutout provides direct access to wall for access to electrical. End cap required at the end of a run of wall units. End cap sold separately, see page 236. Shipped easy to assemble in 2 cartons.

• **NOTE:** Care should be taken to mount the units. Units should be mounted to wall studs using correct fasteners. Failure to do so may result in collapse of the unit and subsequent personal injury. **Mounting hardware not included.** Mounting hardware used should be based on wall material. Consult an installation professional for proper wall mounting.

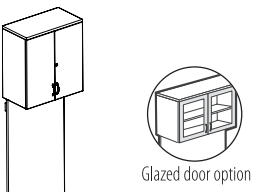

Wall w/Closed Storage 84" High*

Z4284WS	42 x 16 x 84.9	134	10.2	\$2178	\$2265	\$956	N/A
Z3684WS	36 x 16 x 84.9	119	9.45	\$2068	\$2159	\$871	N/A
Z3084WS	30 x 16 x 84.9	102	8.1	\$1817	\$1881	\$773	N/A
Z2484WS	24 x 16 x 84.9	84	6.6	\$1601	\$1653	\$703	N/A

Standard with pre-mounted "J" bracket for wall mount applications. Fixed interior shelf. Doors lock. End cap required at the end of a run of wall units. End cap sold separately, see page 236. Shipped easy to assemble in 2 cartons.

• **NOTE:** Care should be taken to mount the units. Units should be mounted to wall studs using correct fasteners. Failure to do so may result in collapse of the unit and subsequent personal injury. **Mounting hardware not included.** Mounting hardware used should be based on wall material. Consult an installation professional for proper wall mounting.

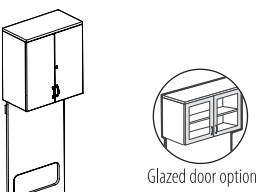

Wall w/Closed Storage and Access Cut-Out 84" High*

Z4284WSO	42 x 16 x 84.9	120	9.3	\$2195	\$2282	\$956	N/A
Z3684WSO	36 x 16 x 84.9	105	8.65	\$2085	\$2175	\$871	N/A
Z3084WSO	30 x 16 x 84.9	91	7.5	\$1832	\$1895	\$773	N/A
Z2484WSO	24 x 16 x 84.9	74	6.2	\$1610	\$1661	\$703	N/A

Standard with pre-mounted "J" bracket for wall mount applications. Fixed interior shelf. Doors lock. Large cutout provides direct access to wall for access to electrical. End cap required at the end of a run of wall units. End cap sold separately, see page 236. Shipped easy to assemble in 2 cartons.

• **NOTE:** Care should be taken to mount the units. Units should be mounted to wall studs using correct fasteners. Failure to do so may result in collapse of the unit and subsequent personal injury. **Mounting hardware not included.** Mounting hardware used should be based on wall material. Consult an installation professional for proper wall mounting.

Required specifications

- Top finish
- Handles
- Top thickness/edge detail
- Wall finish
- Door front finish if laminate doors

Optional specifications

- Key #
- Glazed doors
- Grommet position
- End filler cap

WALLS W/FLOATING SHELVES MODEL # DIMENSIONS WT/LB. CUBIC FT. 1" TOP 1.5" TOP GLAZE ADD HP ADD

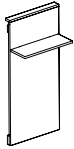

Wall w/Floating Shelf 66" High

	W x D x H (1.5" TOP)							
ZF1S4266	42 x 14.25 x 66	119	7.5	\$1288	\$1331	N/A	N/A	
ZF1S3666	36 x 14.25 x 66	105	6.6	\$1121	\$1158	N/A	N/A	
ZF1S3066	30 x 14.25 x 66	88	5.7	\$969	\$1005	N/A	N/A	
ZF1S2466	24 x 14.25 x 66	70	4.7	\$831	\$857	N/A	N/A	

Fixed position shelf, 10.75"D. Standard with pre-mounted "J" bracket for wall mount applications. End cap required at the end of a run of floating shelves. End cap sold separately, see page 236. Shipped easy to assemble in 1 carton.

- **NOTE:** Care should be taken to mount the units. Units should be mounted to wall studs using correct fasteners. Failure to do so may result in collapse of the unit and subsequent personal injury. **Fastening hardware not included.** Mounting hardware used should be based on wall material. Consult an installation professional for proper wall mounting.

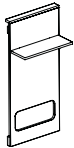

Wall w/Floating Shelf and Access Cut-Out 66" High

ZF1S42660	42 x 14.25 x 66	112	7.5	\$1300	\$1342	N/A	N/A	
ZF1S36660	36 x 14.25 x 66	99	6.6	\$1135	\$1168	N/A	N/A	
ZF1S30660	30 x 14.25 x 66	83	5.7	\$974	\$1010	N/A	N/A	
ZF1S24660	24 x 14.25 x 66	67	4.7	\$836	\$862	N/A	N/A	

Fixed position shelf, 10.75"D. Standard with pre-mounted "J" bracket for wall mount applications. Large cutout provides direct access to wall for access to electrical. End cap required at the end of a run of floating shelves. End cap sold separately, see page 236. Shipped easy to assemble in 1 carton.

- **NOTE:** Care should be taken to mount the units. Units should be mounted to wall studs using correct fasteners. Failure to do so may result in collapse of the unit and subsequent personal injury. **Fastening hardware not included.** Mounting hardware used should be based on wall material. Consult an installation professional for proper wall mounting.

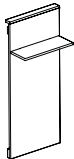

Wall w/Floating Shelf 72" High

ZF1S4272	42 x 14.25 x 72.4	129	8	\$1357	\$1400	N/A	N/A	
ZF1S3672	36 x 14.25 x 72.4	112	7.1	\$1185	\$1216	N/A	N/A	
ZF1S3072	30 x 14.25 x 72.4	94	6.1	\$1041	\$1077	N/A	N/A	
ZF1S2472	24 x 14.25 x 72.4	75	5	\$884	\$910	N/A	N/A	

Fixed position shelf, 10.75"D. Standard with pre-mounted "J" bracket for wall mount applications. End cap required at the end of a run of floating shelves. End cap sold separately, see page 236. Shipped easy to assemble in 1 carton.

- **NOTE:** Care should be taken to mount the units. Units should be mounted to wall studs using correct fasteners. Failure to do so may result in collapse of the unit and subsequent personal injury. **Fastening hardware not included.** Mounting hardware used should be based on wall material. Consult an installation professional for proper wall mounting.

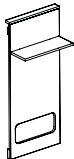

Wall w/Floating Shelf and Access Cut-Out 72" High*

ZF1S42720	42 x 14.25 x 72.4	122	8	\$1374	\$1410	N/A	N/A	
ZF1S36720	36 x 14.25 x 72.4	106	7.1	\$1200	\$1233	N/A	N/A	
ZF1S30720	30 x 14.25 x 72.4	89	6.1	\$1058	\$1095	N/A	N/A	
ZF1S24720	24 x 14.25 x 72.4	72	5	\$890	\$921	N/A	N/A	

Fixed position shelf, 10.75"D. Standard with pre-mounted "J" bracket for wall mount applications. Large cutout provides direct access to wall for access to electrical. End cap required at the end of a run of floating shelves. End cap sold separately, see page 236. Shipped easy to assemble in 1 carton.

- **NOTE:** Care should be taken to mount the units. Units should be mounted to wall studs using correct fasteners. Failure to do so may result in collapse of the unit and subsequent personal injury. **Fastening hardware not included.** Mounting hardware used should be based on wall material. Consult an installation professional for proper wall mounting.

Required specifications

- Top finish
- Top thickness/edge detail
- Wall finish
- Shelf finish

Optional specifications

- Grommet position
- End filler cap

WALLS W/FLOATING SHELVES

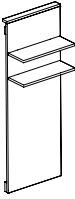

Wall w/Floating Shelves 84" High

MODEL #	DIMENSIONS W x D x H (1.5" TOP)	WT/LB.	CUBIC FT.	1" TOP	1.5" TOP	GLAZE ADD	HP ADD
ZF2S4284	42 x 14.25 x 84.9	160	9.5	\$1595	\$1637	N/A	N/A
ZF2S3684	36 x 14.25 x 84.9	138	8.4	\$1374	\$1421	N/A	N/A
ZF2S3084	30 x 14.25 x 84.9	115	7.1	\$1209	\$1237	N/A	N/A
ZF2S2484	24 x 14.25 x 84.9	92	6.25	\$1052	\$1078	N/A	N/A

Fixed position shelves, 10.75"D. Standard with pre-mounted "J" bracket for wall mount applications. End cap required at the end of a run of floating shelves. End cap sold separately, see page 236. Shipped easy to assemble in 1 carton.

- **NOTE:** Care should be taken to mount the units. Units should be mounted to wall studs using correct fasteners. Failure to do so may result in collapse of the unit and subsequent personal injury. **Fastening hardware not included.** Mounting hardware used should be based on wall material. Consult an installation professional for proper wall mounting.

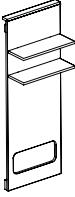

Wall w/Floating Shelves and Access Cut-Out 84" High

ZF2S42840	42 x 14.25 x 84.9	140	9.5	\$1604	\$1646	N/A	N/A
ZF2S36840	36 x 14.25 x 84.9	130	8.4	\$1389	\$1431	N/A	N/A
ZF2S30840	30 x 14.25 x 84.9	108	7.1	\$1316	\$1342	N/A	N/A
ZF2S24840	24 x 14.25 x 84.9	87	6.25	\$1058	\$1084	N/A	N/A

Fixed position shelves, 10.75"D. Standard with pre-mounted "J" bracket for wall mount applications. Large cutout provides direct access to wall for access to electrical. End cap required at the end of a run of floating shelves. End cap sold separately, see page 236. Shipped easy to assemble in 1 carton.

- **NOTE:** Care should be taken to mount the units. Units should be mounted to wall studs using correct fasteners. Failure to do so may result in collapse of the unit and subsequent personal injury. **Fastening hardware not included.** Mounting hardware used should be based on wall material. Consult an installation professional for proper wall mounting.

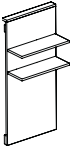

Wall w/Floating Shelves 66" High

ZF2S4266	42 x 14.25 x 66	132	7.5	\$1327	\$1369	N/A	N/A
ZF2S3666	36 x 14.25 x 66	115	6.6	\$1148	\$1184	N/A	N/A
ZF2S3066	30 x 14.25 x 66	96	5.7	\$998	\$1028	N/A	N/A
ZF2S2466	24 x 14.25 x 66	77	4.7	\$851	\$881	N/A	N/A

Fixed position shelves, 10.75"D. Standard with pre-mounted "J" bracket for wall mount applications. End cap required at the end of a run of floating shelves. End cap sold separately, see page 236. Shipped easy to assemble in 1 carton.

- **NOTE:** Care should be taken to mount the units. Units should be mounted to wall studs using correct fasteners. Failure to do so may result in collapse of the unit and subsequent personal injury. **Fastening hardware not included.** Mounting hardware used should be based on wall material. Consult an installation professional for proper wall mounting.

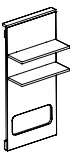

Wall w/Floating Shelves and Access Cut-Out 66" High

ZF2S42660	42 x 14.25 x 66	125	7.5	\$1342	\$1385	N/A	N/A
ZF2S36660	36 x 14.25 x 66	109	6.6	\$1163	\$1199	N/A	N/A
ZF2S30660	30 x 14.25 x 66	91	5.7	\$1009	\$1040	N/A	N/A
ZF2S24660	24 x 14.25 x 66	74	4.7	\$862	\$891	N/A	N/A

Fixed position shelves, 10.75"D. Standard with pre-mounted "J" bracket for wall mount applications. Large cutout provides direct access to wall for access to electrical. End cap required at the end of a run of floating shelves. End cap sold separately, see page 236. Shipped easy to assemble in 1 carton.

- **NOTE:** Care should be taken to mount the units. Units should be mounted to wall studs using correct fasteners. Failure to do so may result in collapse of the unit and subsequent personal injury. **Fastening hardware not included.** Mounting hardware used should be based on wall material. Consult an installation professional for proper wall mounting.

Required specifications

Top finish
Top thickness/edge detail
Wall finish
Shelf finish

Optional specifications

Grommet position
End filler cap

WALLS W/FLOATING SHELVES	MODEL #	DIMENSIONS	WT/LB.	CUBIC FT.	1" TOP	1.5" TOP	GLAZE ADD	HP ADD
--------------------------	---------	------------	--------	-----------	--------	----------	-----------	--------

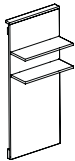

Wall w/Floating Shelves 72" High

	W x D x H (1.5" TOP)							
ZF2S4272	42 x 14.25 x 72.4	142	8	\$1395	\$1437	N/A	N/A	
ZF2S3672	36 x 14.25 x 72.4	122	7.1	\$1212	\$1247	N/A	N/A	
ZF2S3072	30 x 14.25 x 72.4	102	6.1	\$1076	\$1106	N/A	N/A	
ZF2S2472	24 x 14.25 x 72.4	82	5	\$908	\$938	N/A	N/A	

Fixed position shelves, 10.75"D. Standard with pre-mounted "J" bracket for wall mount applications. End cap required at the end of a run of floating shelves. End cap sold separately, see page 236. Shipped easy to assemble in 1 carton.

• **NOTE:** Care should be taken to mount the units. Units should be mounted to wall studs using correct fasteners. Failure to do so may result in collapse of the unit and subsequent personal injury. **Fastening hardware not included.** Mounting hardware used should be based on wall material. Consult an installation professional for proper wall mounting.

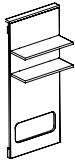

Wall w/Floating Shelves and Access Cut-Out 72" High

ZF2S42720	42 x 14.25 x 72.4	135	8	\$1412	\$1454	N/A	N/A	
ZF2S36720	36 x 14.25 x 72.4	116	7.1	\$1228	\$1263	N/A	N/A	
ZF2S30720	30 x 14.25 x 72.4	97	6.1	\$1086	\$1116	N/A	N/A	
ZF2S24720	24 x 14.25 x 72.4	79	5	\$919	\$949	N/A	N/A	

Fixed position shelves, 10.75"D. Standard with pre-mounted "J" bracket for wall mount applications. Large cutout provides direct access to wall for access to electrical. End cap required at the end of a run of floating shelves. End cap sold separately, see page 236. Shipped easy to assemble in 1 carton.

• **NOTE:** Care should be taken to mount the units. Units should be mounted to wall studs using correct fasteners. Failure to do so may result in collapse of the unit and subsequent personal injury. **Fastening hardware not included.** Mounting hardware used should be based on wall material. Consult an installation professional for proper wall mounting.

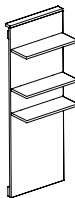

Wall w/Floating Shelves 84" High

ZF3S4284	42 x 14.25 x 84.9	173	9.5	\$1631	\$1673	N/A	N/A	
ZF3S3684	36 x 14.25 x 84.9	148	8.4	\$1412	\$1448	N/A	N/A	
ZF3S3084	30 x 14.25 x 84.9	123	7.1	\$1241	\$1271	N/A	N/A	
ZF3S2484	24 x 14.25 x 84.9	99	6.25	\$1077	\$1106	N/A	N/A	

Fixed position shelves, 10.75"D. Standard with pre-mounted "J" bracket for wall mount applications. End cap required at the end of a run of floating shelves. End cap sold separately, see page 236. Shipped easy to assemble in 1 carton.

• **NOTE:** Care should be taken to mount the units. Units should be mounted to wall studs using correct fasteners. Failure to do so may result in collapse of the unit and subsequent personal injury. **Fastening hardware not included.** Mounting hardware used should be based on wall material. Consult an installation professional for proper wall mounting.

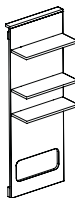

Wall w/Floating Shelves and Access Cut-Out 84" High

ZF3S42840	42 x 14.25 x 84.9	163	9.5	\$1647	\$1689	N/A	N/A	
ZF3S36840	36 x 14.25 x 84.9	140	8.4	\$1427	\$1463	N/A	N/A	
ZF3S30840	30 x 14.25 x 84.9	116	7.1	\$1346	\$1377	N/A	N/A	
ZF3S24840	24 x 14.25 x 84.9	94	6.25	\$1081	\$1111	N/A	N/A	

Fixed position shelves, 10.75"D. Standard with pre-mounted "J" bracket for wall mount applications. Large cutout provides direct access to wall for access to electrical. End cap required at the end of a run of floating shelves. End cap sold separately, see page 236. Shipped easy to assemble in 1 carton.

• **NOTE:** Care should be taken to mount the units. Units should be mounted to wall studs using correct fasteners. Failure to do so may result in collapse of the unit and subsequent personal injury. **Fastening hardware not included.** Mounting hardware used should be based on wall material. Consult an installation professional for proper wall mounting.

Required specifications

Top finish
Top thickness/edge detail
Wall finish
Shelf finish

Optional specifications

Grommet position
End filler cap

WALL PANELS MODEL # DIMENSIONS WT/LB. CUBIC FT. 1" TOP 1.5" TOP GLAZE ADD HP ADD

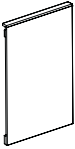

Wall Panel 66" High

	W x D x H (1.5" TOP)							
ZWHP4266	42 x 3.5 x 66	99	7.5	\$1139	\$1181	N/A	N/A	
ZWHP3666	36 x 3.5 x 66	90	6.6	\$904	\$940	N/A	N/A	
ZWHP3066	30 x 3.5 x 66	75	5.7	\$783	\$813	N/A	N/A	
ZWHP2466	24 x 3.5 x 66	61	4.7	\$670	\$700	N/A	N/A	

Standard with pre-mounted "J" bracket for wall mount applications. End cap required at the end of a run of floating shelves. End cap sold separately, see page 236. Shipped easy to assemble in 1 carton.

• **NOTE:** Care should be taken to mount the units. Units should be mounted to wall studs using correct fasteners. Failure to do so may result in collapse of the unit and subsequent personal injury. **Fastening hardware not included.** Mounting hardware used should be based on wall material. Consult an installation professional for proper wall mounting.

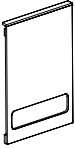

Wall Panel w/Access Cut-Out 66" High

ZWHP4266O	42 x 3.5 x 66	90	7.5	\$1156	\$1198	N/A	N/A	
ZWHP3666O	36 x 3.5 x 66	82	6.6	\$919	\$955	N/A	N/A	
ZWHP3066O	30 x 3.5 x 66	69	5.7	\$795	\$826	N/A	N/A	
ZWHP2466O	24 x 3.5 x 66	56	4.7	\$679	\$709	N/A	N/A	

Standard with pre-mounted "J" bracket for wall mount applications. Large cutout provides direct access to wall for access to electrical. End cap required at the end of a run of floating shelves. End cap sold separately, see page 236. Shipped easy to assemble in 1 carton.

• **NOTE:** Care should be taken to mount the units. Units should be mounted to wall studs using correct fasteners. Failure to do so may result in collapse of the unit and subsequent personal injury. **Fastening hardware not included.** Mounting hardware used should be based on wall material. Consult an installation professional for proper wall mounting.



Wall Panel 72" High

ZWHP4272	42 x 3.5 x 72.4	113	8	\$1112	\$1154	N/A	N/A	
ZWHP3672	36 x 3.5 x 72.4	97	7.1	\$969	\$1004	N/A	N/A	
ZWHP3072	30 x 3.5 x 72.4	81	6.1	\$861	\$891	N/A	N/A	
ZWHP2472	24 x 3.5 x 72.4	67	5	\$724	\$754	N/A	N/A	

Standard with pre-mounted "J" bracket for wall mount applications. End cap required at the end of a run of floating shelves. End cap sold separately, see page 236. Shipped easy to assemble in 1 carton.

• **NOTE:** Care should be taken to mount the units. Units should be mounted to wall studs using correct fasteners. Failure to do so may result in collapse of the unit and subsequent personal injury. **Fastening hardware not included.** Mounting hardware used should be based on wall material. Consult an installation professional for proper wall mounting.

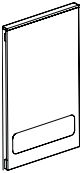

Wall Panel w/Access Cut-Out 72" High

ZWHP4272O	42 x 3.5 x 72.4	104	8	\$1128	\$1170	N/A	N/A	
ZWHP3672O	36 x 3.5 x 72.4	89	7.1	\$983	\$1018	N/A	N/A	
ZWHP3072O	30 x 3.5 x 72.4	75	6.1	\$872	\$902	N/A	N/A	
ZWHP2472O	24 x 3.5 x 72.4	62	5	\$735	\$765	N/A	N/A	

Standard with pre-mounted "J" bracket for wall mount applications. Large cutout provides direct access to wall for access to electrical. End cap required at the end of a run of floating shelves. End cap sold separately, see page 236. Shipped easy to assemble in 1 carton.

• **NOTE:** Care should be taken to mount the units. Units should be mounted to wall studs using correct fasteners. Failure to do so may result in collapse of the unit and subsequent personal injury. **Fastening hardware not included.** Mounting hardware used should be based on wall material. Consult an installation professional for proper wall mounting.

Required specifications

Top finish
Top thickness/edge detail
Wall finish

Optional specifications

Grommet position
End filler cap

WALL PANELS **MODEL #** **DIMENSIONS** **WT/LB.** **CUBIC FT.** **1" TOP** **1.5" TOP** **GLAZE ADD** **HP ADD**

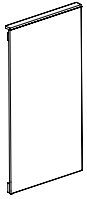

Wall Panel 84" High

W x D x H (1.5" TOP)

ZWHP4284	42 x 3.5 x 84.9	128	9.5	\$1187	\$1229	N/A	N/A
ZWHP3684	36 x 3.5 x 84.9	111	8.4	\$1045	\$1081	N/A	N/A
ZWHP3084	30 x 3.5 x 84.9	92	7.1	\$930	\$960	N/A	N/A
ZWHP2484	24 x 3.5 x 84.9	75	6.25	\$802	\$831	N/A	N/A

Standard with pre-mounted "J" bracket for wall mount applications. End cap required at the end of a run of floating shelves. End cap sold separately, see page 236. Shipped easy to assemble in 1 carton.

- **NOTE:** Care should be taken to mount the units. Units should be mounted to wall studs using correct fasteners. Failure to do so may result in collapse of the unit and subsequent personal injury. **Fastening hardware not included.** Mounting hardware used should be based on wall material. Consult an installation professional for proper wall mounting.

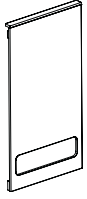

Wall Panel w/Access Cut-Out 84" High

ZWHP42840	42 x 3.5 x 84.9	119	9.5	\$1203	\$1245	N/A	N/A
ZWHP36840	36 x 3.5 x 84.9	103	8.4	\$1059	\$1095	N/A	N/A
ZWHP30840	30 x 3.5 x 84.9	86	7.1	\$942	\$972	N/A	N/A
ZWHP24840	24 x 3.5 x 84.9	70	6.25	\$811	\$841	N/A	N/A

Standard with pre-mounted "J" bracket for wall mount applications. Large cutout provides direct access to wall for access to electrical. End cap required at the end of a run of floating shelves. End cap sold separately, see page 236. Shipped easy to assemble in 1 carton.



- **NOTE:** Care should be taken to mount the units. Units should be mounted to wall studs using correct fasteners. Failure to do so may result in collapse of the unit and subsequent personal injury. **Fastening hardware not included.** Mounting hardware used should be based on wall material. Consult an installation professional for proper wall mounting.

Required specifications

- Top finish
- Top thickness/edge detail
- Wall finish

Optional specifications

- Grommet position
- End filler cap

END FILLER CAPS	MODEL #	DIMENSIONS	WT/LB.	CUBIC FT.	LIST PRICE
		W x D x H			
	ZEFC19	2.5 x 0.75 x 17	1.5	0.25	\$189
End Cap		For 20"H floating shelf: ZFSxxxx.			
					
	ZEFC32	2.5 x 0.75 x 30	2	2	\$304
End Cap		For 32.5"H floating shelf: ZF2Sxxxx.			
					
	ZEFC49	2.5 x 0.75 x 47	3	1.2	\$405
End Cap		For 65.5"/66"H walls with overhead: Zxx66WS or Zxx66WSO.			
					
	ZEFC52	2.5 x 0.75 x 50	4	1.3	\$431
End Cap		For 71.9"/72.4"H or 84.4"/84.9"H walls with overhead: Zxx72WS, Zxx72WSO, Zxx84WS or Zxx84WSO			
					
	ZEFC66	2.5 x 0.75 x 64	4	4	\$527
End Cap		For 65.5"/66"H wall panels, with or without shelves: ZF1Sxx66, ZF1Sxx66O, ZF2Sxx66, ZF2Sxx66O, ZWHPxx66 or ZWHPxx66O.			
					
	ZEFC72	2.5 x 0.75 x 70.5	4	4	\$568
End Cap		For 71.9"/72.4"H wall panels, with or without shelves: ZF1Sxx72, ZF1Sxx72O, ZF2Sxx72, ZF2Sxx72O, ZWHPxx72 or ZWHPxx72O.			
					
	ZEFC84	2.5 x 0.75 x 83	5	4.5	\$670
End Cap		For 84.4"/84.9"H wall panels, with or without shelves: ZF1Sxx84, ZF1Sxx84O, ZF2Sxx84, ZF2Sxx84O, ZWHPxx84 or ZWHPxx84O.			

Required specifications
Base finish

TACKBOARDS FOR HUTCHES

NOTES: Tackboards can be upholstered in all of the following fabrics:

- Anchorage
- Global seating fabrics*
- Lola
- Merge

For a custom size tackboard that is less than 82"W x 21"H, price = next size up plus 5%.
ie: ZTB4921: next size up - ZTB5821 plus 5%.

* Contact Customer Service for pricing.

TACKBOARDS FOR HUTCHES - 23.5" HIGH

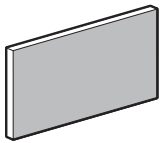

Tackboard

MODEL #	DIMENSIONS W x D x H	WT/LB.	CUBIC FT.	LIST PRICE
ZTB8217	82 x 0.62 x 17	8.2	2	\$502

For use on **Z84S23HN** hutch. Includes mounting screws.

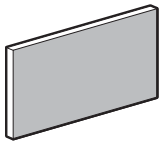

Tackboard

ZTB7017	70 x 0.62 x 17	7	1.3	\$356
---------	----------------	---	-----	-------

For use on **Z72S23HN** hutch. Includes mounting screws.

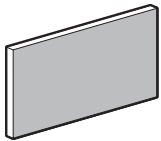

Tackboard

ZTB6917	69 x 0.62 x 17	7	1.3	\$353
---------	----------------	---	-----	-------

For use on **Z71S23HN** hutch. Includes mounting screws.

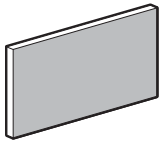

Tackboard

ZTB6417	64 x 0.62 x 17	6.4	1.3	\$345
---------	----------------	-----	-----	-------

For use on **Z66S23HN** hutch. Includes mounting screws.

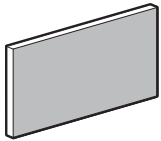

Tackboard

ZTB5817	58 x 0.62 x 17	5.8	1.08	\$339
---------	----------------	-----	------	-------

For use on **Z60S23HN** hutch. Includes mounting screws.

Required specifications

Fabric

TACKBOARDS FOR HUTCHES - 23.5" HIGH

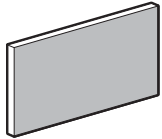

Tackboard

MODEL #	DIMENSIONS W x D x H	WT/LB.	CUBIC FT.	LIST PRICE
ZTB4617	46 x 0.62 x 17	4.6	0.85	\$327

For use on **Z48S23HN** hutch. Includes mounting screws.

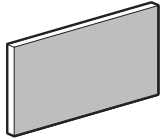

Tackboard

ZTB4017	40 x 0.62 x 17	4	0.85	\$313
---------	----------------	---	------	--------------

For use on **Z42S23HN** hutch. Includes mounting screws.

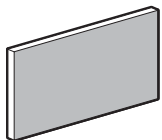

Tackboard

ZTB3417	34 x 0.62 x 17	3.4	0.85	\$206
---------	----------------	-----	------	--------------

For use on **Z36S23HN** hutch. Includes mounting screws.

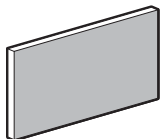

Tackboard

ZTB2817	28 x 0.62 x 17	2.8	0.85	\$196
---------	----------------	-----	------	--------------

For use on **Z30S23HN** hutch. Includes mounting screws.

TACKBOARDS FOR HUTCHES - 36" HIGH

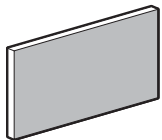

Tackboard

ZTB8216	82 x 0.62 x 15.5	8.2	2	\$485
---------	------------------	-----	---	--------------

For use on **Z84S36H** and **Z84S36HN** hutches. Includes mounting screws.

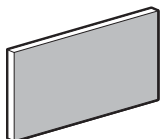

Tackboard

ZTB7016	70 x 0.62 x 15.5	7	1.3	\$356
---------	------------------	---	-----	--------------

For use on **Z72S36H** and **Z72S36HN** hutches. Includes mounting screws.

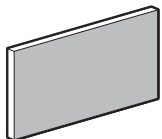

Tackboard

ZTB6916	69.5 x 0.62 x 15.5	7	1.3	\$353
---------	--------------------	---	-----	--------------

For use on **Z71S36H** and **Z71S36HN** hutches. Includes mounting screws.

Required specifications
Fabric

TACKBOARDS FOR HUTCHES - 36" HIGH		MODEL #	DIMENSIONS	WT/LB.	CUBIC FT.	LIST PRICE
		W x D x H				
	Tackboard	ZTB6416	64 x 0.62 x 15.5	6.4	1.3	\$345
For use on Z66S36H and Z66S36HN hutches. Includes mounting screws.						
	Tackboard	ZTB5816	58 x 0.62 x 15.5	5.8	1.08	\$339
For use on Z60S36H and Z60S36HN hutches. Includes mounting screws.						
	Tackboard	ZTB4616	46 x 0.62 x 15.5	4.6	0.85	\$327
For use on Z48S36H and Z48S36HN hutches. Includes mounting screws.						
	Tackboard	ZTB4016	40 x 0.62 x 15.5	4	0.85	\$313
For use on Z42S36H and H42S36HN hutch. Includes mounting screws.						
	Tackboard	ZTB3416	34 x 0.62 x 15.5	3.4	0.85	\$206
For use on Z36S36H and H36S36HN hutch. Includes mounting screws.						
	Tackboard	ZTB2816	28 x 0.62 x 15.5	2.8	0.85	\$196
For use on Z30S36H and H30S36HN hutch. Includes mounting screws.						

Required specifications
Fabric

TACKBOARDS - 42.4" & 54.9" HIGH

MODEL # DIMENSIONS WT/LB. CUBIC FT. LIST PRICE

W x D x H

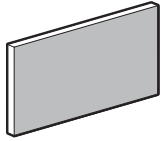

Tackboard

ZTB8221 82 x 0.62 x 21 12.8 2.3 \$594

For use on **Z84S42H, Z84S42HN, Z84S55H** and **Z84S55HN** hutches. Includes mounting screws.

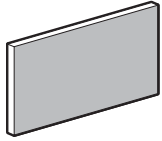

Tackboard

ZTB7021 70 x 0.62 x 21 11 1.5 \$422

For use on **Z72S42H, Z72S42HN, Z72S55H** and **Z72S55HN** hutches. Includes mounting screws.

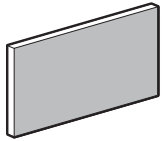

Tackboard

ZTB6921 69 x 0.62 x 21 10.7 1.5 \$418

For use on **Z71S42H, Z71S42HN, Z71S55H** and **Z71S55HN** hutches. Includes mounting screws.

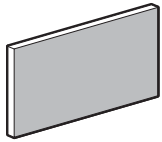

Tackboard

ZTB6421 64 x 0.62 x 21 10 1.5 \$409

For use on **Z66S42H, Z66S42HN, Z66S55H** and **Z66S55HN** hutches. Includes mounting screws.

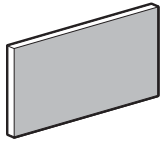

Tackboard

ZTB5821 58 x 0.62 x 21 9 1.5 \$399

For use on **Z60S42H, Z60S42HN, Z60S55H** and **Z60S55HN** hutches. Includes mounting screws.

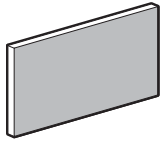

Tackboard

ZTB4621 46 x 0.62 x 21 7.2 1 \$387

For use on **Z48S42H, Z48S42HN, Z48S55H** and **Z48S55HN** hutches. Includes mounting screws.

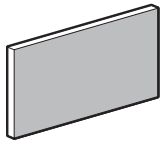

Tackboard

ZTB4021 40 x 0.62 x 21 6.2 1 \$372

For use on **Z42S42H, Z42S42HN, Z42S55H** and **Z42S55HN** hutches. Includes mounting screws.

Required specifications

Fabric

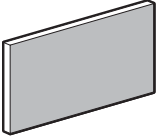
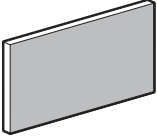
TACKBOARDS - 42.4" & 54.9" HIGH		MODEL #	DIMENSIONS	WT/LB.	CUBIC FT.	LIST PRICE
			W x D x H			
 Tackboard	ZTB3421	34 x 0.62 x 21	5.3	1	\$251	
	For use on Z36S42H, Z36S42HN, Z36S55H and Z36S55HN hutches. Includes mounting screws.					
 Tackboard	ZTB2821	28 x 0.62 x 21	4.5	1	\$230	
	For use on Z30S42H, Z30S42HN, Z30S55H and Z30S55HN hutches. Includes mounting screws.					

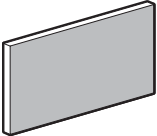
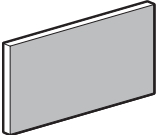
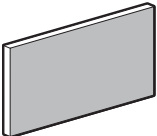
14" WALL MOUNTED TACKBOARDS						
 Wall Mounted Tackboard	ZWHT2414	24 x 1.25 x 14	3.7	1	\$226	
	For use under Z24S200S/OSN for a finished height of 65.5"/66" . Standard with pre-mounted "J" bracket for wall mount applications. • NOTE: Care should be taken to mount the units. Units should be mounted to wall studs using correct fasteners. Mounting hardware not included. Mounting hardware used should be based on wall material. Consult an installation professional for proper wall mounting.					
 Wall Mounted Tackboard	ZWHT3014	30 x 1.25 x 14	4.7	1	\$228	
	For use under Z30S200S/OSN for a finished height of 65.5"/66" . Standard with pre-mounted "J" bracket for wall mount applications. • NOTE: Care should be taken to mount the units. Units should be mounted to wall studs using correct fasteners. Mounting hardware not included. Mounting hardware used should be based on wall material. Consult an installation professional for proper wall mounting.					
 Wall Mounted Tackboard	ZWHT3614	36 x 1.25 x 14	5.6	1	\$261	
	For use under Z36S200S/OSN for a finished height of 65.5"/66" . Standard with pre-mounted "J" bracket for wall mount applications. • NOTE: Care should be taken to mount the units. Units should be mounted to wall studs using correct fasteners. Mounting hardware not included. Mounting hardware used should be based on wall material. Consult an installation professional for proper wall mounting.					

Required specifications
Fabric

14" WALL MOUNTED TACKBOARDS

MODEL # DIMENSIONS WT/LB. CUBIC FT. LIST PRICE

W x D x H

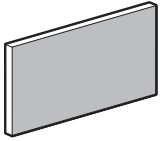

Wall Mounted Tackboard

ZWHT4214	42 x 1.25 x 14	6.5	1	\$386
----------	----------------	-----	---	--------------

For use under **Z42S200S/OSN** for a finished height of **65.5"/66"**. Standard with pre-mounted "J" bracket for wall mount applications.

- **NOTE:** Care should be taken to mount the units. Units should be mounted to wall studs using correct fasteners. Mounting hardware not included. Mounting hardware used should be based on wall material. Consult an installation professional for proper wall mounting.

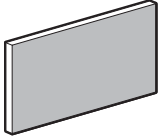

Wall Mounted Tackboard

ZWHT4814	48 x 1.25 x 14	7.5	1	\$399
----------	----------------	-----	---	--------------

For use under **Z48S200S/OSN** for a finished height of **65.5"/66"**. Standard with pre-mounted "J" bracket for wall mount applications.

- **NOTE:** Care should be taken to mount the units. Units should be mounted to wall studs using correct fasteners. Mounting hardware not included. Mounting hardware used should be based on wall material. Consult an installation professional for proper wall mounting.

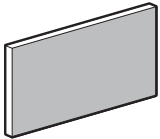

Wall Mounted Tackboard

ZWHT6014	60 x 1.25 x 14	9.3	1.8	\$416
----------	----------------	-----	-----	--------------

For use under **Z60S200S/OSN** for a finished height of **65.5"/66"**. Standard with pre-mounted "J" bracket for wall mount applications.

- **NOTE:** Care should be taken to mount the units. Units should be mounted to wall studs using correct fasteners. Mounting hardware not included. Mounting hardware used should be based on wall material. Consult an installation professional for proper wall mounting.

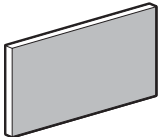

Wall Mounted Tackboard

ZWHT6614	66 x 1.25 x 14	10.3	1.8	\$423
----------	----------------	------	-----	--------------

For use under **ZxxS200S/OSN** for a finished height of **65.5"/66"**. Standard with pre-mounted "J" bracket for wall mount applications.

- **NOTE:** Care should be taken to mount the units. Units should be mounted to wall studs using correct fasteners. Mounting hardware not included. Mounting hardware used should be based on wall material. Consult an installation professional for proper wall mounting.

Required specifications

Fabric

14" WALL MOUNTED TACKBOARDS

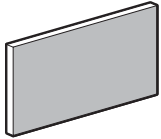

Wall Mounted Tackboard

MODEL #	DIMENSIONS W x D x H	WT/LB.	CUBIC FT.	LIST PRICE
ZWHT7214	72 x 1.25 x 14	11.2	1.8	\$437

For use under **ZxxS200S/OSN** for a finished height of **65.5"/66"**. Standard with pre-mounted "J" bracket for wall mount applications.

- **NOTE:** Care should be taken to mount the units. Units should be mounted to wall studs using correct fasteners. Mounting hardware not included. Mounting hardware used should be based on wall material. Consult an installation professional for proper wall mounting.

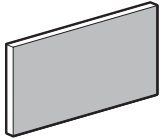

Wall Mounted Tackboard

ZWHT7814	78 x 1.25 x 14	12.1	1.8	\$524
----------	----------------	------	-----	--------------

For use under **ZxxS200S/OSN** for a finished height of **65.5"/66"**. Standard with pre-mounted "J" bracket for wall mount applications.

- **NOTE:** Care should be taken to mount the units. Units should be mounted to wall studs using correct fasteners. Mounting hardware not included. Mounting hardware used should be based on wall material. Consult an installation professional for proper wall mounting.

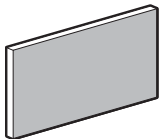

Wall Mounted Tackboard

ZWHT8414	84 x 1.25 x 14	13.1	1.8	\$615
----------	----------------	------	-----	--------------

For use under **ZxxS200S/OSN** for a finished height of **65.5"/66"**. Standard with pre-mounted "J" bracket for wall mount applications.

- **NOTE:** Care should be taken to mount the units. Units should be mounted to wall studs using correct fasteners. Mounting hardware not included. Mounting hardware used should be based on wall material. Consult an installation professional for proper wall mounting.

18" WALL MOUNTED TACKBOARDS

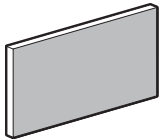

Wall Mounted Tackboard

ZWHT3018	30 x 1.25 x 18	6	1	\$237
----------	----------------	---	---	--------------

For use under **Z30S160S/OSN** for a finished height of **65.5"/66"**. Standard with pre-mounted "J" bracket for wall mount applications.

- **NOTE:** Care should be taken to mount the units. Units should be mounted to wall studs using correct fasteners. Failure to do so may result in collapse of the unit and subsequent personal injury. Mounting hardware not included. Mounting hardware used should be based on wall material. Consult an installation professional for proper wall mounting.

Required specifications
Fabric

18" WALL MOUNTED TACKBOARDS

MODEL # DIMENSIONS WT/LB. CUBIC FT. LIST PRICE

W x D x H

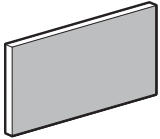

Wall Mounted Tackboard

ZWHT3618	36 x 1.25 x 18	7.2	1	\$270
----------	----------------	-----	---	--------------

For use under **Z36S160S/OSN** for a finished height of **65.5"/66"**. Standard with pre-mounted "J" bracket for wall mount applications.

- **NOTE:** Care should be taken to mount the units. Units should be mounted to wall studs using correct fasteners. Failure to do so may result in collapse of the unit and subsequent personal injury. Mounting hardware not included. Mounting hardware used should be based on wall material. Consult an installation professional for proper wall mounting.

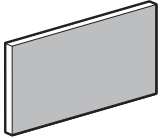

Wall Mounted Tackboard

ZWHT4218	42 x 1.25 x 18	8.4	1	\$402
----------	----------------	-----	---	--------------

For use under **Z42S160S/OSN** for a finished height of **65.5"/66"**. Standard with pre-mounted "J" bracket for wall mount applications.

- **NOTE:** Care should be taken to mount the units. Units should be mounted to wall studs using correct fasteners. Failure to do so may result in collapse of the unit and subsequent personal injury. Mounting hardware not included. Mounting hardware used should be based on wall material. Consult an installation professional for proper wall mounting.

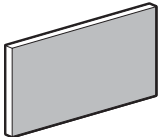

Wall Mounted Tackboard

ZWHT4818	48 x 1.25 x 18	9.6	1	\$418
----------	----------------	-----	---	--------------

For use under **Z48S160S/OSN** for a finished height of **65.5"/66"**. Standard with pre-mounted "J" bracket for wall mount applications.

- **NOTE:** Care should be taken to mount the units. Units should be mounted to wall studs using correct fasteners. Failure to do so may result in collapse of the unit and subsequent personal injury. Mounting hardware not included. Mounting hardware used should be based on wall material. Consult an installation professional for proper wall mounting.

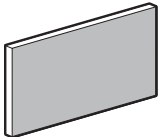

Wall Mounted Tackboard

ZWHT6018	60 x 1.25 x 18	12	1.8	\$431
----------	----------------	----	-----	--------------

For use under **Z60S160S/OSN** for a finished height of **65.5"/66"**. Standard with pre-mounted "J" bracket for wall mount applications.

- **NOTE:** Care should be taken to mount the units. Units should be mounted to wall studs using correct fasteners. Failure to do so may result in collapse of the unit and subsequent personal injury. Mounting hardware not included. Mounting hardware used should be based on wall material. Consult an installation professional for proper wall mounting.

Required specifications

Fabric

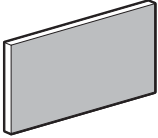
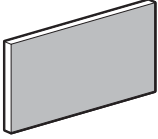
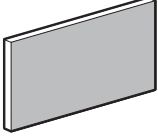
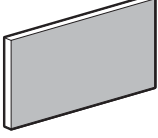
18" WALL MOUNTED TACKBOARDS	MODEL #	DIMENSIONS W x D x H	WT/LB.	CUBIC FT.	LIST PRICE
	ZWHT6618	66 x 1.25 x 18	13.2	1.8	\$441
Wall Mounted Tackboard	<p>For use under ZxxS160S/OSN for a finished height of 65.5"/66". Standard with pre-mounted "J" bracket for wall mount applications.</p> <ul style="list-style-type: none"> NOTE: Care should be taken to mount the units. Units should be mounted to wall studs using correct fasteners. Failure to do so may result in collapse of the unit and subsequent personal injury. Mounting hardware not included. Mounting hardware used should be based on wall material. Consult an installation professional for proper wall mounting. 				
	ZWHT7218	72 x 1.25 x 18	14.4	1.8	\$457
Wall Mounted Tackboard	<p>For use under ZxxS160S/OSN for a finished height of 65.5"/66". Standard with pre-mounted "J" bracket for wall mount applications.</p> <ul style="list-style-type: none"> NOTE: Care should be taken to mount the units. Units should be mounted to wall studs using correct fasteners. Failure to do so may result in collapse of the unit and subsequent personal injury. Mounting hardware not included. Mounting hardware used should be based on wall material. Consult an installation professional for proper wall mounting. 				
	ZWHT7818	78 x 1.25 x 18	15.6	1.8	\$546
Wall Mounted Tackboard	<p>For use under ZxxS160S/OSN for a finished height of 65.5"/66". Standard with pre-mounted "J" bracket for wall mount applications.</p> <ul style="list-style-type: none"> NOTE: Care should be taken to mount the units. Units should be mounted to wall studs using correct fasteners. Failure to do so may result in collapse of the unit and subsequent personal injury. Mounting hardware not included. Mounting hardware used should be based on wall material. Consult an installation professional for proper wall mounting. 				
	ZWHT8418	84 x 1.25 x 18	16.8	1.8	\$640
Wall Mounted Tackboard	<p>For use under ZxxS160S/OSN for a finished height of 65.5"/66". Standard with pre-mounted "J" bracket for wall mount applications.</p> <ul style="list-style-type: none"> NOTE: Care should be taken to mount the units. Units should be mounted to wall studs using correct fasteners. Failure to do so may result in collapse of the unit and subsequent personal injury. Mounting hardware not included. Mounting hardware used should be based on wall material. Consult an installation professional for proper wall mounting. 				

Required specifications
Fabric

21" WALL MOUNTED TACKBOARDS MODEL # DIMENSIONS WT/LB. CUBIC FT. LIST PRICE

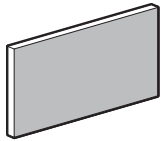

Wall Mounted Tackboard

W x D x H					
ZWHT2421	24 x 1.25 x 21	5.6	1		\$232

For use under **Z24S200S/OSN** or **Z24S330S/OSN** for a finished height of **72"/72.5"**. For use under **ZxxS330S/OSN** for a finished height of **84.5"/85"**. Standard with pre-mounted "J" bracket for wall mount applications.
 • **NOTE:** Care should be taken to mount the units. Units should be mounted to wall studs using correct fasteners. Mounting hardware not included. Mounting hardware used should be based on wall material. Consult an installation professional for proper wall mounting.

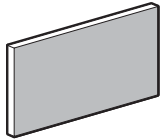

Wall Mounted Tackboard

ZWHT3021	30 x 1.25 x 21	7	1		\$242
----------	----------------	---	---	--	--------------

For use under **Z30S200S/OSN** or **Z30S330S/OSN** for a finished height of **72"/72.5"**. For use under **Z30S330S/OSN** for a finished height of **84.5"/85"**. Standard with pre-mounted "J" bracket for wall mount applications.
 • **NOTE:** Care should be taken to mount the units. Units should be mounted to wall studs using correct fasteners. Mounting hardware not included. Mounting hardware used should be based on wall material. Consult an installation professional for proper wall mounting.

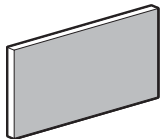

Wall Mounted Tackboard

ZWHT3621	36 x 1.25 x 21	8.4	1		\$275
----------	----------------	-----	---	--	--------------

For use under **Z36S200S/OSN** or **Z36S330S/OSN** for a finished height of **72"/72.5"**. For use under **Z30S330S/OSN** for a finished height of **84.5"/85"**. Standard with pre-mounted "J" bracket for wall mount applications.
 • **NOTE:** Care should be taken to mount the units. Units should be mounted to wall studs using correct fasteners. Mounting hardware not included. Mounting hardware used should be based on wall material. Consult an installation professional for proper wall mounting.

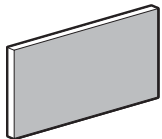

Wall Mounted Tackboard

ZWHT4221	42 x 1.25 x 21	9.8	1		\$407
----------	----------------	-----	---	--	--------------

For use under **Z42S200S/OSN** or **Z42S330S/OSN** for a finished height of **72"/72.5"**. For use under **Z30S330S/OSN** for a finished height of **84.5"/85"**. Standard with pre-mounted "J" bracket for wall mount applications.
 • **NOTE:** Care should be taken to mount the units. Units should be mounted to wall studs using correct fasteners. Mounting hardware not included. Mounting hardware used should be based on wall material. Consult an installation professional for proper wall mounting.

Required specifications
 Fabric

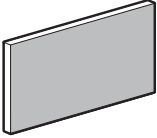
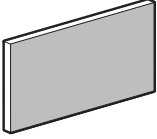
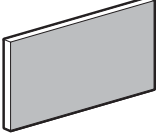
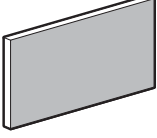
21" WALL MOUNTED TACKBOARDS	MODEL #	DIMENSIONS W x D x H	WT/LB.	CUBIC FT.	LIST PRICE
	ZWHT4821	48 x 1.25 x 21	11.2	1	\$425
Wall Mounted Tackboard	<p>For use under Z48S160S/OSN or Z48S330S/OSN for a finished height of 72"/72.5". For use under Z30S330S/OSN for a finished height of 84.5"/85". Standard with pre-mounted "J" bracket for wall mount applications.</p> <ul style="list-style-type: none"> • NOTE: Care should be taken to mount the units. Units should be mounted to wall studs using correct fasteners. Mounting hardware not included. Mounting hardware used should be based on wall material. Consult an installation professional for proper wall mounting. 				
	ZWHT6021	60 x 1.25 x 21	14	1.8	\$441
Wall Mounted Tackboard	<p>For use under Z60S200S/OSN or Z60S330S/OSN for a finished height of 72"/72.5". For use under Z30S330S/OSN for a finished height of 84.5"/85". Standard with pre-mounted "J" bracket for wall mount applications.</p> <ul style="list-style-type: none"> • NOTE: Care should be taken to mount the units. Units should be mounted to wall studs using correct fasteners. Mounting hardware not included. Mounting hardware used should be based on wall material. Consult an installation professional for proper wall mounting. 				
	ZWHT6621	66 x 1.25 x 21	15.4	1.8	\$449
Wall Mounted Tackboard	<p>For use under ZxxS210S/OSN or ZxxS330S/OSN for a finished height of 72"/72.5". For use under Z30S330S/OSN for a finished height of 84.5"/85". Standard with pre-mounted "J" bracket for wall mount applications.</p> <ul style="list-style-type: none"> • NOTE: Care should be taken to mount the units. Units should be mounted to wall studs using correct fasteners. Mounting hardware not included. Mounting hardware used should be based on wall material. Consult an installation professional for proper wall mounting. 				
	ZWHT7221	72 x 1.25 x 21	16.8	1.8	\$465
Wall Mounted Tackboard	<p>For use under ZxxS210S/OSN or ZxxS330S/OSN for a finished height of 72"/72.5". For use under Z30S330S/OSN for a finished height of 84.5"/85". Standard with pre-mounted "J" bracket for wall mount applications.</p> <ul style="list-style-type: none"> • NOTE: Care should be taken to mount the units. Units should be mounted to wall studs using correct fasteners. Mounting hardware not included. Mounting hardware used should be based on wall material. Consult an installation professional for proper wall mounting. 				

Required specifications
Fabric

21" WALL MOUNTED TACKBOARDS

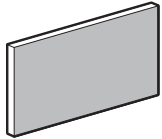

Wall Mounted Tackboard

MODEL #	DIMENSIONS W x D x H	WT/LB.	CUBIC FT.	LIST PRICE
ZWHT7821	78 x 1.25 x 21	18.2	1.8	\$559

For use under **ZxxS210S/OSN** or **ZxxS330S/OSN** for a finished height of **72"/72.5"**. For use under **Z30S330S/OSN** for a finished height of **84.5"/85"**. Standard with pre-mounted "J" bracket for for wall mount applications.

- **NOTE:** Care should be taken to mount the units. Units should be mounted to wall studs using correct fasteners. Mounting hardware not included. Mounting hardware used should be based on wall material. Consult an installation professional for proper wall mounting.

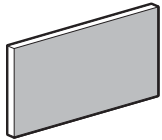

Wall Mounted Tackboard

ZWHT8421	84 x 1.25 x 21	19.6	1.8	\$654
----------	----------------	------	-----	-------

For use under **ZxxS210S/OSN** or **ZxxS330S/OSN** for a finished height of **72"/72.5"**. For use under **Z30S330S/OSN** for a finished height of **84.5"/85"**. Standard with pre-mounted "J" bracket for wall mount applications.

- **NOTE:** Care should be taken to mount the units. Units should be mounted to wall studs using correct fasteners. Mounting hardware not included. Mounting hardware used should be based on wall material. Consult an installation professional for proper wall mounting.

25" WALL MOUNTED TACKBOARDS

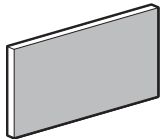

Wall Mounted Tackboard

ZWHT3025	30 x 1.25 x 25.5	8.3	1	\$251
----------	------------------	-----	---	-------

For use under **Z30S160S/OSN** for a finished height of **72"/72.5"**. Standard with pre-mounted "J" bracket for wall mount applications.

- **NOTE:** Care should be taken to mount the units. Units should be mounted to wall studs using correct fasteners. Mounting hardware not included. Mounting hardware used should be based on wall material. Consult an installation professional for proper wall mounting.

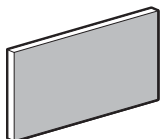

Wall Mounted Tackboard

ZWHT3625	36 x 1.25 x 25	10	1	\$285
----------	----------------	----	---	-------

For use under **Z36S160S/OSN** for a finished height of **72"/72.5"**. Standard with pre-mounted "J" bracket for wall mount applications.

- **NOTE:** Care should be taken to mount the units. Units should be mounted to wall studs using correct fasteners. Mounting hardware not included. Mounting hardware used should be based on wall material. Consult an installation professional for proper wall mounting.

Required specifications
Fabric

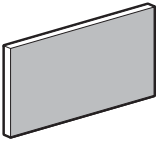
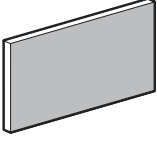
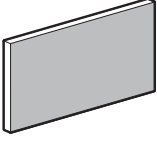
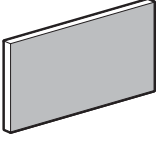
25" WALL MOUNTED TACKBOARDS	MODEL #	DIMENSIONS	WT/LB.	CUBIC FT.	LIST PRICE
 <p>Wall Mounted Tackboard</p>	ZWHT4225	W x D x H 42 x 1.25 x 25	11.7	1	\$422
<p>For use under Z42S160S/OSN for a finished height of 72"/72.5". Standard with pre-mounted "J" bracket for wall mount applications.</p> <ul style="list-style-type: none"> NOTE: Care should be taken to mount the units. Units should be mounted to wall studs using correct fasteners. Mounting hardware not included. Mounting hardware used should be based on wall material. Consult an installation professional for proper wall mounting. 					
 <p>Wall Mounted Tackboard</p>	ZWHT4825	48 x 1.25 x 25	13.3	1	\$439
<p>For use under Z48S160S/OSN for a finished height of 72"/72.5". Standard with pre-mounted "J" bracket for wall mount applications.</p> <ul style="list-style-type: none"> NOTE: Care should be taken to mount the units. Units should be mounted to wall studs using correct fasteners. Mounting hardware not included. Mounting hardware used should be based on wall material. Consult an installation professional for proper wall mounting. 					
 <p>Wall Mounted Tackboard</p>	ZWHT6025	60 x 1.25 x 25	16.7	1.8	\$455
<p>For use under Z60S160S/OSN for a finished height of 72"/72.5". Standard with pre-mounted "J" bracket for wall mount applications.</p> <ul style="list-style-type: none"> NOTE: Care should be taken to mount the units. Units should be mounted to wall studs using correct fasteners. Mounting hardware not included. Mounting hardware used should be based on wall material. Consult an installation professional for proper wall mounting. 					
 <p>Wall Mounted Tackboard</p>	ZWHT6625	66 x 1.25 x 25	18.3	1.8	\$464
<p>For use under ZxxS160S/OSN for a finished height of 72"/72.5". Standard with pre-mounted "J" bracket for wall mount applications.</p> <ul style="list-style-type: none"> NOTE: Care should be taken to mount the units. Units should be mounted to wall studs using correct fasteners. Mounting hardware not included. Mounting hardware used should be based on wall material. Consult an installation professional for proper wall mounting. 					

Required specifications
Fabric

25" WALL MOUNTED TACKBOARDS **MODEL #** **DIMENSIONS** **WT/LB.** **CUBIC FT.** **LIST PRICE**

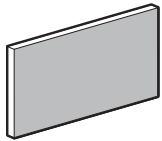

Wall Mounted Tackboard

	W x D x H			
ZWHT7225	72 x 1.25 x 25	20	1.8	\$476

For use under **ZxxS160S/OSN** for a finished height of **72"/72.5"**. Standard with pre-mounted "J" bracket for wall mount applications.
 • **NOTE:** Care should be taken to mount the units. Units should be mounted to wall studs using correct fasteners. Mounting hardware not included. Mounting hardware used should be based on wall material. Consult an installation professional for proper wall mounting.

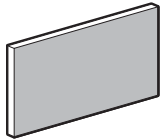

Wall Mounted Tackboard

ZWHT7825	78 x 1.25 x 25	21.7	1.8	\$574
----------	----------------	------	-----	--------------

For use under **ZxxS160S/OSN** for a finished height of **72"/72.5"**. Standard with pre-mounted "J" bracket for wall mount applications.
 • **NOTE:** Care should be taken to mount the units. Units should be mounted to wall studs using correct fasteners. Mounting hardware not included. Mounting hardware used should be based on wall material. Consult an installation professional for proper wall mounting.

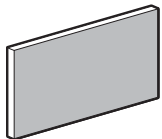

Wall Mounted Tackboard

ZWHT8425	84 x 1.25 x 25	23.3	1.8	\$672
----------	----------------	------	-----	--------------

For use under **ZxxS160S/OSN** for a finished height of **72"/72.5"**. Standard with pre-mounted "J" bracket for wall mount applications.
 • **NOTE:** Care should be taken to mount the units. Units should be mounted to wall studs using correct fasteners. Mounting hardware not included. Mounting hardware used should be based on wall material. Consult an installation professional for proper wall mounting.

BOOKCASES **MODEL #** **DIMENSIONS** **WT/LB.** **CUBIC FT.** **1" TOP** **1.5" TOP**

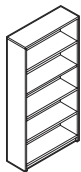

Bookcase - 72"/72.5" High

	W x D x H (1.5" TOP)				
ZHBC72	36 x 12 x 72.4	170	23	\$1126	\$1187

One fixed shelf and three adjustable shelves. Shipped assembled in 1 carton.

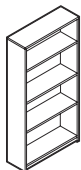

Bookcase - 65.5"/66" High

ZHBC65	36 x 12 x 66	150	21	\$988	\$1049
--------	--------------	-----	----	--------------	---------------

One fixed shelf and two adjustable shelves. Shipped assembled in 1 carton.

Required specifications
 Fabric (only tackboards)
 Finish
 Top/edge detail (bookcases only)
 Base finish

BOOKCASES	MODEL #	DIMENSIONS	WT/LB.	CUBIC FT.	1" TOP	1.5" TOP	GLAZE ADD	HP ADD
		W x D x H (1.5" TOP)						
	ZHBC48	36 x 12 x 49	116	15.75	\$926	\$983	N/A	N/A
Bookcase - 48.5" / 49" High	Two adjustable shelves. Shipped assembled in 1 carton.							
	ZHSHELF	34 x 11 x 1	13.41	1.5	\$216	N/A	N/A	N/A
Bookcase Shelf	Extra shelf for bookcases. 1" thick.							

TABLE TOP BOOKCASES **NOTE: UNITS UNDER 30"W MUST BE SECURELY FASTENED TO THE WALL OR GANGED TO AN ADJACENT UNIT 30"W OR WIDER**

	Z36S12TN	36 x 16 x 11.75	45	5.25	\$314	\$375	N/A	\$128
	Z30S12TN	30 x 16 x 11.75	39	4.3	\$287	\$338	N/A	\$114
Table Top Bookcase 11.75" High*	To be placed on top of 29.5"/30" high units to achieve 41.3"/41.8" final height or placed on top of 41.3"/41.8" high units to achieve 53"/53.5" final height . Shipped assembled in 1 carton.							
	Z21S12TN	21 x 16 x 11.75	29	3.1	\$239	\$278	N/A	\$87
	Z18S12TN	18 x 16 x 11.75	27	2.7	\$227	\$261	N/A	\$69
	Z16S12TN	16 x 16 x 11.75	25	2.4	\$218	\$252	N/A	\$69
	Z15S12TN	15 x 16 x 11.75	24	2.3	\$209	\$238	N/A	\$69
	Z12S12TN	12 x 16 x 11.75	22	1.9	\$197	\$221	N/A	\$57
Table Top Bookcase 11.75" High*	To be placed on top of 29.5"/30" high units to achieve 41.3"/41.8" final height or placed on top of 41.3"/41.8" high units to achieve 53"/53.5" final height . Shipped assembled in 1 carton.							
	Z36S41T	36 x 16 x 41.85	128	17.75	\$1469	\$1544	\$1007	N/A
	Z30S41T	30 x 16 x 41.85	111	15	\$1330	\$1373	\$898	N/A
Closed Table Top Bookcase 41" High**	Designed to be placed on top of 23.75"/24.25" high units to achieve 65.5"/66" final height . Laminate doors are standard. Includes one adjustable shelf . Standard with lock. Shipped assembled in 1 carton.							
	Z36S48T	36 x 16 x 47.7	149	20.25	\$1709	\$1784	\$1103	N/A
	Z30S48T	30 x 16 x 47.7	130	17	\$1529	\$1591	\$986	N/A
Closed Table Top Bookcase 47.7" High**	Designed to be placed on top of 17.87"/18.37" high units to achieve 65.5"/66" final height . Laminate doors are standard. Includes one adjustable shelf . Standard with lock. Shipped assembled in 1 carton.							

Required specifications

Top finish Handles**
 Top thickness/edge detail
 Base finish
 Finish (only ZHSHELF)

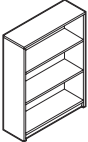
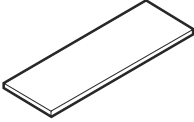
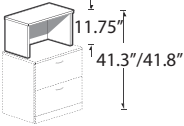
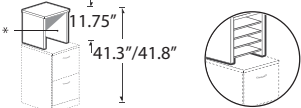
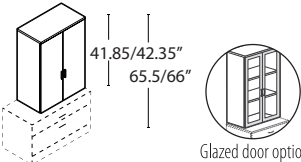
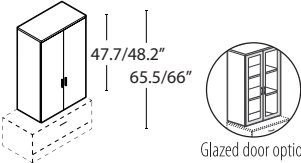
Optional specifications

HP laminate*
 Key #**
 Collator - position & finish (only ZxxS12TN)
 Glazed doors**

TABLE TOP BOOKCASES	MODEL #	DIMENSIONS	WT/LB.	CUBIC FT.	1" TOP	1.5" TOP	GLAZE ADD	HP ADD
---------------------	---------	------------	--------	-----------	--------	----------	-----------	--------

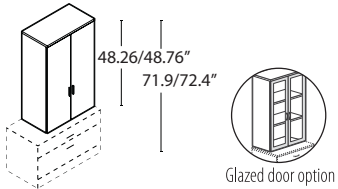

Closed Table Top Bookcase 48" High

	W x D x H (1.5" TOP)							
Z36S49T	36 x 16 x 48.26	141	20.25	\$1619	\$1694	\$1110	N/A	
Z30S49T	30 x 16 x 48.26	123	17.25	\$1452	\$1514	\$990	N/A	

Designed to be placed **on top of 23.75"/24.25" high units to achieve 71.9"/72.4" final height.**
Laminate doors are standard. **Includes one adjustable shelf.** Standard with lock. Shipped assembled in 1 carton.

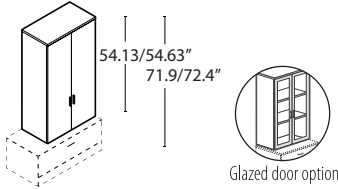

Closed Table Top Bookcase 54" High

Z36S54T	36 x 16 x 54.13	163	22.75	\$1822	\$1897	\$1211	N/A	
Z30S54T	30 x 16 x 54.13	142	19	\$1629	\$1691	\$1080	N/A	

Designed to be placed **on top of 17.87"/18.37" high units to achieve 71.9"/72.4" final height.**
Laminate doors are standard. **Includes one adjustable shelf.** Standard with lock. Shipped assembled in 1 carton.

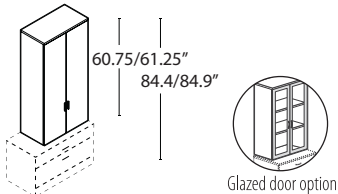

Closed Table Top Bookcase 61" High

Z36S61T	36 x 16 x 60.75	176	25.25	\$1913	\$1988	\$1321	N/A	
Z30S61T	30 x 16 x 60.75	153	21.25	\$1709	\$1771	\$1179	N/A	

Designed to be placed **on top of 23.75"/24.25" high units to achieve 84.4"/84.9" final height.**
Laminate doors are standard. **Includes one adjustable shelf.** Standard with lock. Shipped assembled in 1 carton.

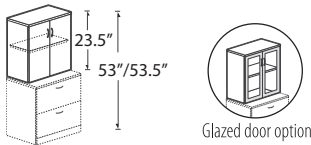

Table Top Bookcase with Doors 23.5" High*

Z36S23T	36 x 16 x 23.5	87	9.5	\$758	\$819	\$754	\$128	
Z30S23T	30 x 16 x 23.5	76	8	\$686	\$737	\$666	\$114	

Designed to be placed **on top of 29.5"/30" high units to achieve 53"/53.5" final height.** DO NOT USE ON TOP OF 41.3"/41.8" HIGH UNITS. Laminate doors are standard. **Includes one adjustable shelf.** Standard with lock. Shipped assembled in 1 carton.

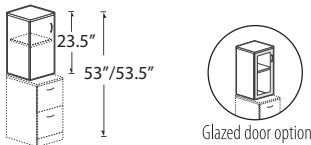

Table Top Bookcase with Door 23.5" High - LEFT*

Z21S23TL	21 x 16 x 23.5	59	5.75	\$536	\$575	\$408	\$87	
Z18S23TL	18 x 16 x 23.5	55	5	\$518	\$552	\$373	\$69	
Z16S23TL	16 x 16 x 23.5	47	4.5	\$458	\$492	\$365	\$69	
Z15S23TL	15 x 16 x 23.5	46	4.2	\$436	\$465	\$326	\$69	
Z12S23TL	12 x 16 x 23.5	41	3.5	\$405	\$429	\$295	\$57	

Designed to be placed **on top of 29.5"/30" high units to achieve 53"/53.5" final height.** DO NOT USE ON TOP OF 41.3"/41.8" HIGH UNITS. Laminate door is standard. **Includes one adjustable shelf.** Standard with lock. Shipped assembled in 1 carton.

Required specifications

- Top finish
- Top thickness/edge detail
- Base finish
- Handles

Optional specifications

- HP laminate*
- Key #
- Glazed doors

TABLE TOP BOOKCASES **MODEL #** **DIMENSIONS** **WT/LB.** **CUBIC FT.** **1" TOP** **1.5" TOP** **GLAZE ADD** **HP ADD**

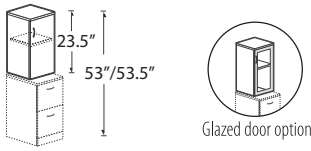

Table Top Bookcase with Door 23.5" High - RIGHT*

W x D x H (1.5" TOP)

Z21S23TR	21 x 16 x 23.5	59	5.75	\$536	\$575	\$408	\$87
Z18S23TR	18 x 16 x 23.5	55	5	\$518	\$552	\$373	\$69
Z16S23TR	16 x 16 x 23.5	47	4.5	\$458	\$492	\$365	\$69
Z15S23TR	15 x 16 x 23.5	46	4.2	\$436	\$465	\$326	\$69
Z12S23TR	12 x 16 x 23.5	41	3.5	\$405	\$429	\$295	\$57

Designed to be placed **on top of 29.5"/30" high units to achieve 53"/53.5" final height.** DO NOT USE ON TOP OF 41.3"/41.8" HIGH UNITS. Laminate door is standard. **Includes one adjustable shelf.** Standard with lock. Shipped assembled in 1 carton.

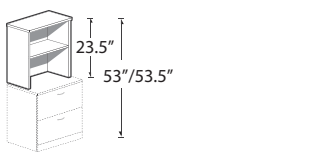

Table Top Bookcase 23.5" High

Z36S23TN	36 x 16 x 23.5	69	9.5	\$491	\$552	N/A	\$128
Z30S23TN	30 x 16 x 23.5	60	8	\$452	\$503	N/A	\$114

Designed to be placed **on top of 29.5"/30" high units to achieve 53"/53.5" final height.** DO NOT USE ON TOP OF 41.3"/41.8" HIGH UNITS. **Includes one adjustable shelf.** Shipped assembled in 1 carton.

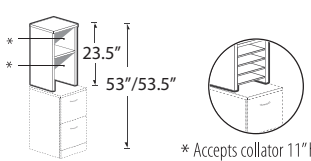

Table Top Bookcase 23.5" High**

Z21S23TN	21 x 16 x 23.5	48	5.75	\$386	\$425	N/A	\$87
Z18S23TN	18 x 16 x 23.5	45	5	\$378	\$412	N/A	\$69
Z16S23TN	16 x 16 x 23.5	38	4.5	\$319	\$353	N/A	\$69
Z15S23TN	15 x 16 x 23.5	37	4.2	\$309	\$338	N/A	\$69
Z12S23TN	12 x 16 x 23.5	34	3.5	\$287	\$311	N/A	\$57

Designed to be placed **on top of 29.5"/30" high units to achieve 53"/53.5" final height.** DO NOT USE ON TOP OF 41.3"/41.8" HIGH UNITS. **Includes one adjustable shelf.** Shipped assembled in 1 carton.

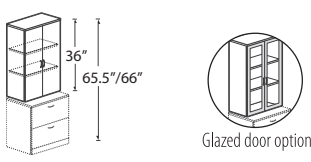

Table Top Bookcase with Doors 36" High*

Z36S36T	36 x 16 x 36	124	14.25	\$974	\$1035	\$972	N/A
Z30S36T	30 x 16 x 36	107	12	\$844	\$895	\$851	N/A

Designed to be placed **on top of 29.5"/30" high units to achieve 65.5"/66" final height.** Laminate doors are standard. **Includes two adjustable shelves.** Standard with lock. Shipped assembled in 1 carton.

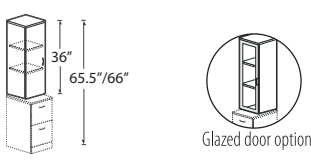

Table Top Bookcase with Doors 36" High - LEFT*

Z21S36TL	21 x 16 x 36	83	8.75	\$686	\$725	\$530	N/A
Z18S36TL	18 x 16 x 36	75	7.5	\$659	\$693	\$480	N/A
Z16S36TL	16 x 16 x 36	68	6.75	\$601	\$635	\$473	N/A
Z15S36TL	15 x 16 x 36	66	6.5	\$571	\$600	\$420	N/A
Z12S36TL	12 x 16 x 36	59	5.25	\$532	\$556	\$380	N/A

Designed to be placed **on top of 29.5"/30" high units to achieve 65.5"/66" final height.** Laminate door is standard. **Includes two adjustable shelves.** Standard with lock. Shipped assembled in 1 carton.

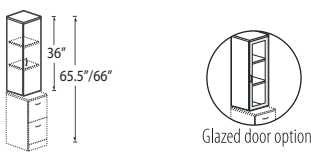

Table Top Bookcase with Doors 36" High - RIGHT*

Z21S36TR	21 x 16 x 36	83	8.75	\$686	\$725	\$530	N/A
Z18S36TR	18 x 16 x 36	75	7.5	\$659	\$693	\$480	N/A
Z16S36TR	16 x 16 x 36	68	6.75	\$601	\$635	\$473	N/A
Z15S36TR	15 x 16 x 36	66	6.5	\$571	\$600	\$420	N/A
Z12S36TR	12 x 16 x 36	59	5.25	\$532	\$556	\$380	N/A

Designed to be placed **on top of 29.5"/30" high units to achieve 65.5"/66" final height.** Laminate door is standard. **Includes two adjustable shelves.** Standard with lock. Shipped assembled in 1 carton.

Required specifications
 Top finish
 Top thickness/edge detail
 Base finish
 Handles*

Optional specifications
 HP laminate (only ZxxS23TR and ZxxS23TN)
 Key #*
 Collator - position & finish**
 Glazed door*

TABLE TOP BOOKCASES **MODEL #** **DIMENSIONS** **WT/LB.** **CUBIC FT.** **1" TOP** **1.5" TOP** **GLAZE ADD** **HP ADD**

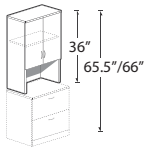

Glazed door option

Table Top Bookcase with Doors and Cavity - 36" High*

Designed to be placed **on top of 29.5"/30" high units to achieve 65.5"/66" final height.** Laminate doors are standard. **Includes one adjustable shelf.** Standard with lock. Shipped assembled in 1 carton.

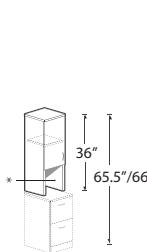

* Accepts collator 11"high



Glazed door option

Table Top Bookcase with Doors and Cavity - 36" High - LEFT*

MODEL #	W x D x H (1.5" TOP)	WT/LB.	CUBIC FT.	1" TOP	1.5" TOP	GLAZE ADD	HP ADD
Z21S36TCL	21 x 16 x 36	79	8.75	\$656	\$695	\$473	N/A
Z18S36TCL	18 x 16 x 36	71	7.5	\$631	\$665	\$428	N/A
Z16S36TCL	16 x 16 x 36	65	6.75	\$573	\$607	\$420	N/A
Z15S36TCL	15 x 16 x 36	63	6.5	\$549	\$578	\$373	N/A
Z12S36TCL	12 x 16 x 36	57	5.25	\$512	\$536	\$332	N/A

Designed to be placed **on top of 29.5"/30" high units to achieve 65.5"/66" final height.** Laminate door is standard. **Includes one adjustable shelf.** Standard with lock. Shipped assembled in 1 carton.

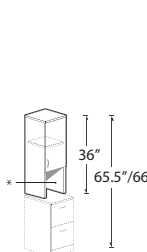

* Accepts collator 11"high



Glazed door option

Table Top Bookcase with Doors and Cavity - 36" High - RIGHT*

MODEL #	W x D x H (1.5" TOP)	WT/LB.	CUBIC FT.	1" TOP	1.5" TOP	GLAZE ADD	HP ADD
Z21S36TCR	21 x 16 x 36	79	8.75	\$656	\$695	\$473	N/A
Z18S36TCR	18 x 16 x 36	71	7.5	\$631	\$665	\$428	N/A
Z16S36TCR	16 x 16 x 36	65	6.75	\$573	\$607	\$420	N/A
Z15S36TCR	15 x 16 x 36	63	6.5	\$549	\$578	\$373	N/A
Z12S36TCR	12 x 16 x 36	57	5.25	\$512	\$536	\$332	N/A

Designed to be placed **on top of 29.5"/30" high units to achieve 65.5"/66" final height.** Laminate door is standard. **Includes one adjustable shelf.** Standard with lock. Shipped assembled in 1 carton.

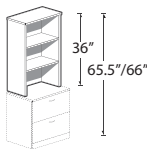
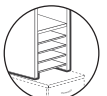
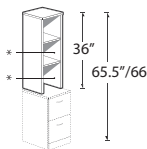

Table Top Bookcase 36" High

MODEL #	W x D x H (1.5" TOP)	WT/LB.	CUBIC FT.	1" TOP	1.5" TOP	GLAZE ADD	HP ADD
Z36S36TN	36 x 16 x 36	95	14.25	\$653	\$714	N/A	N/A
Z30S36TN	30 x 16 x 36	82	12	\$558	\$609	N/A	N/A

Designed to be placed **on top of 29.5"/30" high units to achieve 65.5"/66" final height.** **Includes two adjustable shelves.** Shipped assembled in 1 carton.



* Accepts collator 11"high

Table Top Bookcase 36" High

MODEL #	W x D x H (1.5" TOP)	WT/LB.	CUBIC FT.	1" TOP	1.5" TOP	GLAZE ADD	HP ADD
Z21S36TN	21 x 16 x 36	66	8.75	\$505	\$544	N/A	N/A
Z18S36TN	18 x 16 x 36	60	7.5	\$488	\$522	N/A	N/A
Z16S36TN	16 x 16 x 36	56	6.75	\$435	\$469	N/A	N/A
Z15S36TN	15 x 16 x 36	54	6.5	\$421	\$450	N/A	N/A
Z12S36TN	12 x 16 x 36	49	6.25	\$389	\$413	N/A	N/A

Designed to be placed **on top of 29.5"/30" high units to achieve 65.5"/66" final height.** **Includes two adjustable shelves.** Shipped assembled in 1 carton.

Required specifications

- Top finish
- Top thickness/edge detail
- Base finish
- Handles*

Optional specifications

- Key #*
- Glazed door*
- Collator - position & finish (not Z3xS36TC or Z3xS36TN)

TABLE TOP BOOKCASES **MODEL #** **DIMENSIONS** **WT/LB.** **CUBIC FT.** **1" TOP** **1.5" TOP** **GLAZE ADD** **HP ADD**

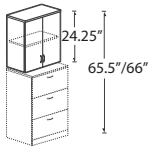

Table Top Bookcase with Doors
24.25"/24.75" High*

Designed to be placed **on top of 41.3"/41.8" high units to achieve 65.5"/66" final height.** DO NOT USE ON TOP OF 29.5"/30" HIGH UNITS. Laminate doors are standard. **Includes one adjustable shelf.** Standard with lock. Shipped assembled in 1 carton.

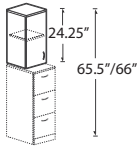

Table Top Bookcase with Door
24.25"/24.75" High - LEFT*

MODEL #	DIMENSIONS	WT/LB.	CUBIC FT.	1" TOP	1.5" TOP	GLAZE ADD	HP ADD
Z21S24TL	21 x 16 x 24.25	59	6	\$539	\$578	\$473	N/A
Z18S24TL	18 x 16 x 24.25	56	5.25	\$519	\$553	\$428	N/A
Z16S24TL	16 x 16 x 24.25	48	4.6	\$459	\$493	\$420	N/A
Z15S24TL	15 x 16 x 24.25	46	4.3	\$437	\$466	\$373	N/A
Z12S24TL	12 x 16 x 24.25	44	3.6	\$406	\$430	\$332	N/A

Designed to be placed **on top of 41.3"/41.8" high units to achieve 65.5"/66" final height.** DO NOT USE ON TOP OF 29.5"/30" HIGH UNITS. Laminate door is standard. **Includes one adjustable shelf.** Standard with lock. Shipped assembled in 1 carton.

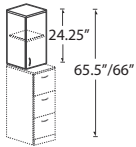

Table Top Bookcase with Door
24.25"/24.75" High - RIGHT*

Z21S24TR	21 x 16 x 24.25	59	6	\$539	\$578	\$473	N/A
Z18S24TR	18 x 16 x 24.25	56	5.25	\$519	\$553	\$428	N/A
Z16S24TR	16 x 16 x 24.25	48	4.6	\$459	\$493	\$420	N/A
Z15S24TR	15 x 16 x 24.25	46	4.3	\$437	\$466	\$373	N/A
Z12S24TR	12 x 16 x 24.25	44	3.6	\$406	\$430	\$332	N/A

Designed to be placed **on top of 41.3"/41.8" high units to achieve 65.5"/66" final height.** DO NOT USE ON TOP OF 29.5"/30" HIGH UNITS. Laminate door is standard. **Includes one adjustable shelf.** Standard with lock. Shipped assembled in 1 carton.

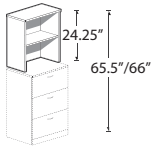
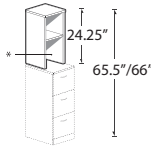

Table Top Bookcase
24.25"/24.75" High

Z36S24TN	36 x 16 x 24.25	70	10	\$492	\$553	N/A	N/A
Z30S24TN	30 x 16 x 24.25	61	8.25	\$452	\$503	N/A	N/A

Designed to be placed **on top of 41.3"/41.8" high units to achieve 65.5"/66" final height.** DO NOT USE ON TOP OF 29.5"/30" HIGH UNITS. **Includes one adjustable shelf.** Shipped assembled in 1 carton.



* Accepts collator 11" high

Table Top Bookcase
24.25"/24.75" High**

Z21S24TN	21 x 16 x 24.25	48	6	\$386	\$425	N/A	N/A
Z18S24TN	18 x 16 x 24.25	46	5.25	\$380	\$414	N/A	N/A
Z16S24TN	16 x 16 x 24.25	39	4.6	\$319	\$353	N/A	N/A
Z15S24TN	15 x 16 x 24.25	38	4.3	\$309	\$338	N/A	N/A
Z12S24TN	12 x 16 x 24.25	37	3.6	\$287	\$311	N/A	N/A

Designed to be placed **on top of 41.3"/41.8" high units to achieve 65.5"/66" final height.** DO NOT USE ON TOP OF 29.5"/30" HIGH UNITS. **Includes one adjustable shelf.** Shipped assembled in 1 carton.

Required specifications

- Top finish
- Top thickness/edge detail
- Base finish
- Handles*

Optional specifications

- Key #*
- Collator - position & finish**
- Glazed door*

TABLE TOP BOOKCASES **MODEL #** **DIMENSIONS** **WT/LB.** **CUBIC FT.** **1" TOP** **1.5" TOP** **GLAZE ADD** **HP ADD**

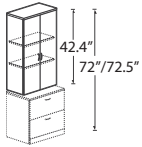

Glazed door option

Table Top Bookcase with Doors
42.4" High

Designed to be placed **on top of 29.5"/30" high units to achieve 72"/72.5" final height.** DO NOT USE ON TOP OF 41.3"/41.8" HIGH UNITS. Laminate doors are standard. **Includes two adjustable shelves.** Standard with lock. Shipped assembled in 1 carton.

	W x D x H (1.5" TOP)							
Z36S42T	36 x 16 x 42.4	137	16.75	\$1062	\$1123	\$1194	N/A	
Z30S42T	30 x 16 x 42.4	119	14	\$928	\$979	\$1038	N/A	

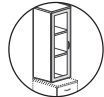
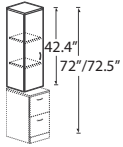

Glazed door option

Table Top Bookcase with Door
42.4" High - LEFT

Designed to be placed **on top of 29.5"/30" high units to achieve 72"/72.5" final height.** DO NOT USE ON TOP OF 41.3"/41.8" HIGH UNITS. Laminate door is standard. **Includes two adjustable shelves.** Standard with lock. Shipped assembled in 1 carton.

Z21S42TL	21 x 16 x 42.4	119	10	\$752	\$791	\$659	N/A	
Z18S42TL	18 x 16 x 42.4	117	8.75	\$721	\$755	\$593	N/A	
Z16S42TL	16 x 16 x 42.4	112	8	\$648	\$682	\$585	N/A	
Z15S42TL	15 x 16 x 42.4	109	7.5	\$616	\$645	\$515	N/A	
Z12S42TL	12 x 16 x 42.4	105	6	\$571	\$595	\$464	N/A	

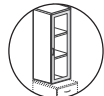
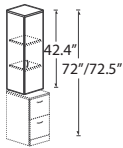

Glazed door option

Table Top Bookcase with Door
42.4" High - RIGHT

Designed to be placed **on top of 29.5"/30" high units to achieve 72"/72.5" final height.** DO NOT USE ON TOP OF 41.3"/41.8" HIGH UNITS. Laminate door is standard. **Includes two adjustable shelves.** Standard with lock. Shipped assembled in 1 carton.

Z21S42TR	21 x 16 x 42.4	119	10	\$752	\$791	\$659	N/A	
Z18S42TR	18 x 16 x 42.4	117	8.75	\$721	\$755	\$593	N/A	
Z16S42TR	16 x 16 x 42.4	112	8	\$648	\$682	\$585	N/A	
Z15S42TR	15 x 16 x 42.4	109	7.5	\$616	\$645	\$515	N/A	
Z12S42TR	12 x 16 x 42.4	105	6	\$571	\$595	\$464	N/A	

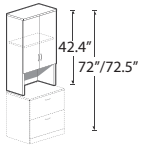

Glazed door option

Table Top Bookcase with Doors and Cavity
42.4" High

Designed to be placed **on top of 29.5"/30" high units to achieve 72"/72.5" final height.** DO NOT USE ON TOP OF 41.3"/41.8" HIGH UNITS. Laminate doors are standard. **Includes one adjustable shelf.** Standard with lock. Shipped assembled in 1 carton.

Z36S42TC	36 x 16 x 42.4	130	16.75	\$1030	\$1091	\$938	N/A	
Z30S42TC	30 x 16 x 42.4	113	14	\$898	\$949	\$817	N/A	



* Accepts collator 11" high

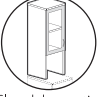
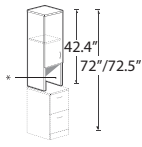

Glazed door option

Table Top Bookcase with Door and Cavity
42.4" High - LEFT*

Designed to be placed **on top of 29.5"/30" high units to achieve 72"/72.5" final height.** DO NOT USE ON TOP OF 41.3"/41.8" HIGH UNITS. Laminate door is standard. **Includes one adjustable shelf.** Standard with lock. Shipped assembled in 1 carton.

Z21S42TCL	21 x 16 x 42.4	88	10	\$733	\$772	\$520	N/A	
Z18S42TCL	18 x 16 x 42.4	80	8.75	\$705	\$739	\$468	N/A	
Z16S42TCL	16 x 16 x 42.4	74	8	\$631	\$665	\$463	N/A	
Z15S42TCL	15 x 16 x 42.4	71	7.5	\$601	\$630	\$406	N/A	
Z12S42TCL	12 x 16 x 42.4	63	6	\$560	\$584	\$365	N/A	

Required specifications

- Top finish
- Top thickness/edge detail
- Base finish
- Handles

Optional specifications

- Key #
- Glazed door
- Collator - position & finish*

TABLE TOP BOOKCASES	MODEL #	DIMENSIONS	WT/LB.	CUBIC FT.	1" TOP	1.5" TOP	GLAZE ADD	HP ADD
---------------------	---------	------------	--------	-----------	--------	----------	-----------	--------

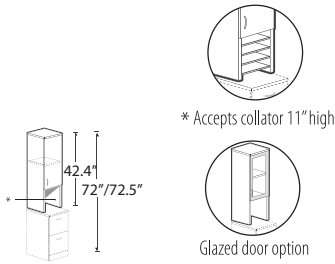

Table Top Bookcase with Door and Cavity 42.4" High - RIGHT*

	W x D x H (1.5" TOP)							
Z21S42TCR	21 x 16 x 42.4	88	10	\$733	\$772	\$520	N/A	
Z18S42TCR	18 x 16 x 42.4	80	8.75	\$705	\$739	\$468	N/A	
Z16S42TCR	16 x 16 x 42.4	74	8	\$631	\$665	\$463	N/A	
Z15S42TCR	15 x 16 x 42.4	71	7.5	\$601	\$630	\$406	N/A	
Z12S42TCR	12 x 16 x 42.4	63	6	\$560	\$584	\$365	N/A	

Designed to be placed **on top of 29.5"/30" high units to achieve 72"/72.5" final height**. DO NOT USE ON TOP OF 41.3"/41.8" HIGH UNITS. Laminate door is standard. **Includes one adjustable shelf**. Standard with lock. Shipped assembled in 1 carton.

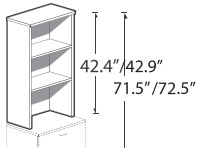

Table Top Bookcase 42.4" High

Z36S42TN	36 x 16 x 42.4	104	16.75	\$712	\$773	N/A	N/A
Z30S42TN	30 x 16 x 42.4	91	14	\$616	\$667	N/A	N/A

Designed to be placed **on top of 29.5"/30" high units to achieve 72"/72.5" final height**. DO NOT USE ON TOP OF 41.3"/41.8" HIGH UNITS. **Includes two adjustable shelves**. Standard with lock. Shipped assembled in 1 carton.

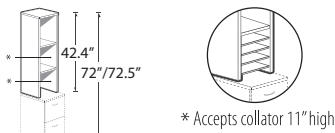

Table Top Bookcase 42.4" High

Z21S42TN	21 x 16 x 42.4	72	10	\$550	\$589	N/A	N/A
Z18S42TN	18 x 16 x 42.4	66	8.75	\$536	\$570	N/A	N/A
Z16S42TN	16 x 16 x 42.4	61	8	\$464	\$498	N/A	N/A
Z15S42TN	15 x 16 x 42.4	59	7.5	\$454	\$483	N/A	N/A
Z12S42TN	12 x 16 x 42.4	53	6	\$422	\$446	N/A	N/A

Designed to be placed **on top of 29.5"/30" high units to achieve 72"/72.5" final height**. DO NOT USE ON TOP OF 41.3"/41.8" HIGH UNITS. **Includes two adjustable shelves**. Standard with lock. Shipped assembled in 1 carton.

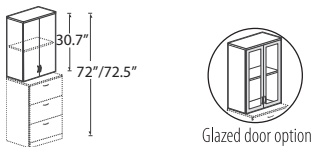

Table Top Bookcase with Doors 30.7" High*

Z36S31T	36 x 16 x 30.7	104	12.25	\$835	\$896	\$938	N/A
Z30S31T	30 x 16 x 30.7	89	10.5	\$750	\$801	\$817	N/A

Designed to be placed **on top of 41.3"/41.8" high units to achieve 72"/72.5" final height**. Laminate doors are standard. **Includes one adjustable shelf**. Standard with lock. Shipped assembled in 1 carton.



Table Top Bookcase with Door 30.7" High - LEFT*

Z21S31TL	21 x 16 x 30.7	70	7.5	\$596	\$635	\$520	N/A
Z18S31TL	18 x 16 x 30.7	65	6.5	\$547	\$581	\$468	N/A
Z16S31TL	16 x 16 x 30.7	59	5.75	\$519	\$553	\$463	N/A
Z15S31TL	15 x 16 x 30.7	56	5.5	\$492	\$521	\$406	N/A
Z12S31TL	12 x 16 x 30.7	50	4.4	\$461	\$485	\$365	N/A

Designed to be placed **on top of 41.3"/41.8" high units to achieve 72"/72.5" final height**. Laminate door is standard. **Includes one adjustable shelf**. Standard with lock. Shipped assembled in 1 carton.

Required specifications

- Top finish
- Top thickness/edge detail
- Base finish
- Handles*

Optional specifications

- Key #*
- Glazed door*
- Collator - position & finish (only ZxxS42TCR and ZxxS42TN)

TABLE TOP BOOKCASES

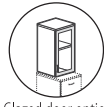
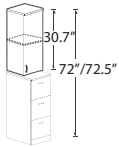

Glazed door option

Table Top Bookcase with Door
30.7" High - RIGHT*

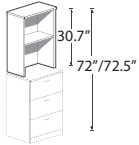
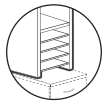
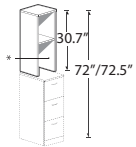
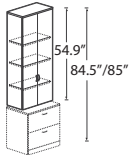

Table Top Bookcase
30.7" High



* Accepts collar 11" high

Table Top Bookcase
30.7" High



Glazed door option

Table Top Bookcase with Doors
54.9" High*

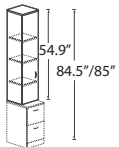

Glazed door option

Table Top Bookcase with Door
54.9" High - LEFT*

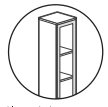
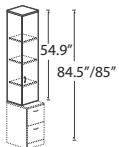

Glazed door option

Table Top Bookcase with Door
54.9" High - RIGHT*

MODEL #	DIMENSIONS W x D x H (1.5" TOP)	WT/LB.	CUBIC FT.	1" TOP	1.5" TOP	GLAZE ADD	HP ADD
Z21S31TR	21 x 16 x 30.7	70	7.5	\$596	\$635	\$520	N/A
Z18S31TR	18 x 16 x 30.7	65	6.5	\$547	\$581	\$468	N/A
Z16S31TR	16 x 16 x 30.7	59	5.75	\$519	\$553	\$463	N/A
Z15S31TR	15 x 16 x 30.7	56	5.5	\$492	\$521	\$406	N/A
Z12S31TR	12 x 16 x 30.7	50	4.4	\$461	\$485	\$365	N/A

Designed to be placed on top of 41.3"/41.8" high units to achieve 72"/72.5" final height. Laminate door is standard. Includes one adjustable shelf. Standard with lock. Shipped assembled in 1 carton.

Z36S31TN	36 x 16 x 30.7	80	12.25	\$542	\$603	N/A	N/A
Z30S31TN	30 x 16 x 30.7	69	10.5	\$486	\$537	N/A	N/A

Designed to be placed on top of 41.3"/41.8" high units to achieve 72"/72.5" final height. Includes one adjustable shelf. Shipped assembled in 1 carton.

Z21S31TN	21 x 16 x 30.7	55	7.5	\$427	\$466	N/A	N/A
Z18S31TN	18 x 16 x 30.7	52	6.5	\$388	\$422	N/A	N/A
Z16S31TN	16 x 16 x 30.7	48	5.75	\$369	\$403	N/A	N/A
Z15S31TN	15 x 16 x 30.7	45	5.5	\$352	\$381	N/A	N/A
Z12S31TN	12 x 16 x 30.7	42	4.4	\$332	\$356	N/A	N/A

Designed to be placed on top of 41.3"/41.8" high units to achieve 72"/72.5" final height. Includes one adjustable shelf. Shipped assembled in 1 carton.

Z36S55T	36 x 16 x 54.9	174	21.5	\$1291	\$1352	\$1378	N/A
Z30S55T	30 x 16 x 54.9	152	18	\$1179	\$1230	\$1188	N/A

Designed to be placed on top of 29.5"/30" high units to achieve 84.5"/85" final height. Laminate doors are standard. Includes three adjustable shelves. Standard with lock. Shipped assembled in 1 carton.

Z21S55TL	21 x 16 x 54.9	116	13	\$919	\$958	\$762	N/A
Z18S55TL	18 x 16 x 54.9	105	11.25	\$861	\$895	\$683	N/A
Z16S55TL	16 x 16 x 54.9	98	10	\$818	\$852	\$679	N/A
Z15S55TL	15 x 16 x 54.9	94	9.5	\$780	\$809	\$589	N/A
Z12S55TL	12 x 16 x 54.9	84	7.75	\$724	\$748	\$527	N/A

Designed to be placed on top of 29.5"/30" high units to achieve 84.5"/85" final height. Laminate door is standard. Includes three adjustable shelves. Standard with lock. Shipped assembled in 1 carton.

Z21S55TR	21 x 16 x 54.9	116	13	\$919	\$958	\$762	N/A
Z18S55TR	18 x 16 x 54.9	105	11.25	\$861	\$895	\$683	N/A
Z16S55TR	16 x 16 x 54.9	98	10	\$818	\$852	\$679	N/A
Z15S55TR	15 x 16 x 54.9	94	9.5	\$780	\$809	\$589	N/A
Z12S55TR	12 x 16 x 54.9	84	7.75	\$724	\$748	\$527	N/A

Designed to be placed on top of 29.5"/30" high units to achieve 84.5"/85" final height. Laminate door is standard. Includes three adjustable shelves. Standard with lock. Shipped assembled in 1 carton.

Required specifications

- Top finish
- Top thickness/edge detail
- Base finish
- Handles*

Optional specifications

- Key #*
- Glazed door*
- Collator - position & finish (only ZxxS31TN)

TABLE TOP BOOKCASES **MODEL #** **DIMENSIONS** **WT/LB.** **CUBIC FT.** **1" TOP** **1.5" TOP** **GLAZE ADD** **HP ADD**

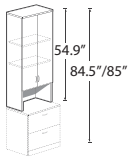

Glazed door option

Table Top Bookcase with Doors and Cavity 54.9" High*

Designed to be placed **on top of 29.5"/30" high units to achieve 84.5"/85" final height.** Laminate doors are standard. **Includes two adjustable shelves.** Standard with lock. Shipped assembled in 1 carton.

	W x D x H (1.5" TOP)							
Z36S55TC	36 x 16 x 54.9	167	21.5	\$1258	\$1319	\$1200		N/A
Z30S55TC	30 x 16 x 54.9	146	18	\$1151	\$1202	\$1041		N/A

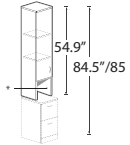

* Accepts collator 11" high



Glazed door option

Table Top Bookcase with Door and Cavity 54.9" High - LEFT*

Designed to be placed **on top of 29.5"/30" high units to achieve 84.5"/85" final height.** Laminate door is standard. **Includes two adjustable shelves.** Standard with lock. Shipped assembled in 1 carton.

Z21S55TCL	21 x 16 x 54.9	112	13	\$887	\$926	\$660		N/A
Z18S55TCL	18 x 16 x 54.9	101	11.25	\$833	\$867	\$594		N/A
Z16S55TCL	16 x 16 x 54.9	94	10	\$789	\$823	\$589		N/A
Z15S55TCL	15 x 16 x 54.9	91	9.5	\$757	\$786	\$516		N/A
Z12S55TCL	12 x 16 x 54.9	81	7.75	\$701	\$725	\$466		N/A

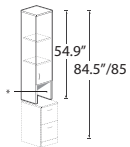

* Accepts collator 11" high



Glazed door option

Table Top Bookcase with Door and Cavity - 54.9" High - RIGHT*

Designed to be placed **on top of 29.5"/30" high units to achieve 84.5"/85" final height.** Laminate door is standard. **Includes two adjustable shelves.** Standard with lock. Shipped assembled in 1 carton.

Z21S55TCR	21 x 16 x 54.9	112	13	\$887	\$926	\$660		N/A
Z18S55TCR	18 x 16 x 54.9	101	11.25	\$833	\$867	\$594		N/A
Z16S55TCR	16 x 16 x 54.9	94	10	\$789	\$823	\$589		N/A
Z15S55TCR	15 x 16 x 54.9	91	9.5	\$757	\$786	\$516		N/A
Z12S55TCR	12 x 16 x 54.9	81	7.75	\$701	\$725	\$466		N/A

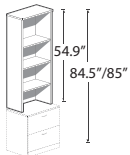
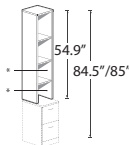

Table Top Bookcase 54.9" High

Designed to be placed **on top of 29.5"/30" high units to achieve 84.5"/85" final height.** **Includes three adjustable shelves.** Shipped assembled in 1 carton.

Z36S55TN	36 x 16 x 54.9	130	21.5	\$860	\$921	N/A		N/A
Z30S55TN	30 x 16 x 54.9	115	18	\$799	\$850	N/A		N/A



* Accepts collator 11" high

Table Top Bookcase 54.9" High

Designed to be placed **on top of 29.5"/30" high units to achieve 84.5"/85" final height.** **Includes three adjustable shelves.** Shipped assembled in 1 carton.

Z21S55TN	21 x 16 x 54.9	90	13	\$671	\$710	N/A		N/A
Z18S55TN	18 x 16 x 54.9	82	11.25	\$638	\$672	N/A		N/A
Z16S55TN	16 x 16 x 54.9	77	10	\$595	\$629	N/A		N/A
Z15S55TN	15 x 16 x 54.9	75	9.5	\$579	\$608	N/A		N/A
Z12S55TN	12 x 16 x 54.9	68	7.75	\$542	\$566	N/A		N/A

Required specifications

- Top finish
- Top thickness/edge detail
- Base finish
- Handles*

Optional specifications

- Key #*
- Glazed door*
- Collator - position & finish (only ZxxS55CL ZxxS55TCR and ZxxS55TN)

TABLE TOP BOOKCASES

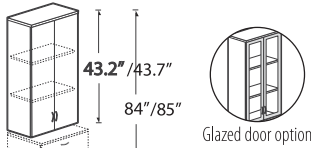

Table Top Bookcase with Doors
43.2" High

MODEL #	DIMENSIONS W x D x H (1.5" TOP)	WT/LB.	CUBIC FT.	1" TOP	1.5" TOP	GLAZE ADD	HP ADD
Z36S43T	36 x 16 x 43.2	139	17	\$1085	\$1146	\$1200	N/A
Z30S43T	30 x 16 x 43.2	121	14.5	\$928	\$979	\$1041	N/A

Designed to be placed on top of 41.3"/41.8" high units to achieve 84.5"/85" final height. Laminate doors are standard. DO NOT USE ON TOP OF 29.5"/30" HIGH UNITS. Includes two adjustable shelves. Standard with lock. Shipped assembled in 1 carton.



Table Top Bookcase with Door
43.2" High

Z21S43TL	21 x 16 x 43.2	94	10.25	\$767	\$806	\$660	N/A
Z18S43TL	18 x 16 x 43.2	85	9	\$734	\$768	\$594	N/A
Z16S43TL	16 x 16 x 43.2	78	8	\$658	\$692	\$589	N/A
Z15S43TL	15 x 16 x 43.2	75	7.5	\$617	\$646	\$516	N/A
Z12S43TL	12 x 16 x 43.2	66	6.25	\$573	\$597	\$466	N/A

Designed to be placed on top of 41.3"/41.8" high units to achieve 84.5"/85" final height. Laminate door is standard. DO NOT USE ON TOP OF 29.5"/30" HIGH UNITS. Includes two adjustable shelves. Standard with lock. Shipped assembled in 1 carton.



Table Top Bookcase with Door
43.2" High

Z21S43TR	21 x 16 x 43.2	94	10.25	\$767	\$806	\$660	N/A
Z18S43TR	18 x 16 x 43.2	85	9	\$734	\$768	\$594	N/A
Z16S43TR	16 x 16 x 43.2	78	8	\$658	\$692	\$589	N/A
Z15S43TR	15 x 16 x 43.2	75	7.5	\$617	\$646	\$516	N/A
Z12S43TR	12 x 16 x 43.2	66	6.25	\$573	\$597	\$466	N/A

Designed to be placed on top of 41.3"/41.8" high units to achieve 84.5"/85" final height. Laminate door is standard. DO NOT USE ON TOP OF 29.5"/30" HIGH UNITS. Includes two adjustable shelves. Standard with lock. Shipped assembled in 1 carton.

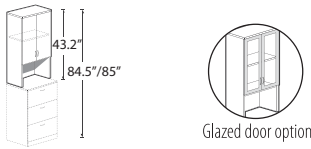

Table Top Bookcase with Doors
and Cavity - 43.2" High

Z36S43TC	36 x 16 x 43.2	132	17	\$1051	\$1112	\$943	N/A
Z30S43TC	30 x 16 x 43.2	115	14.5	\$919	\$970	\$803	N/A

Designed to be placed on top of 41.3"/41.8" high units to achieve 84.5"/85" final height. Laminate doors are standard. DO NOT USE ON TOP OF 29.5"/30" HIGH UNITS. Includes one adjustable shelf. Standard with lock. Shipped assembled in 1 carton.

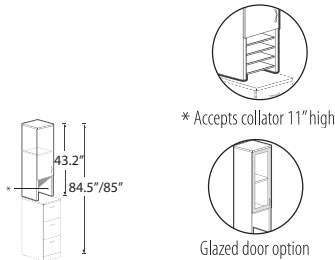

Table Top Bookcase with Door
and Cavity - 43.2" High - LEFT*

Z21S43TCL	21 x 16 x 43.2	89	10.25	\$748	\$787	\$520	N/A
Z18S43TCL	18 x 16 x 43.2	81	9	\$716	\$750	\$466	N/A
Z16S43TCL	16 x 16 x 43.2	75	8	\$641	\$675	\$463	N/A
Z15S43TCL	15 x 16 x 43.2	72	7.5	\$603	\$632	\$406	N/A
Z12S43TCL	12 x 16 x 43.2	64	6.25	\$561	\$585	\$365	N/A

Designed to be placed on top of 41.3"/41.8" high units to achieve 84.5"/85" final height. Laminate door is standard. DO NOT USE ON TOP OF 29.5"/30" HIGH UNITS. Includes one adjustable shelf. Standard with lock. Shipped assembled in 1 carton.

Required specifications

- Top finish
- Top thickness/edge detail
- Base finish
- Handles

Optional specifications

- Key #
- Collator - position & finish*
- Glazed door

TABLE TOP BOOKCASES

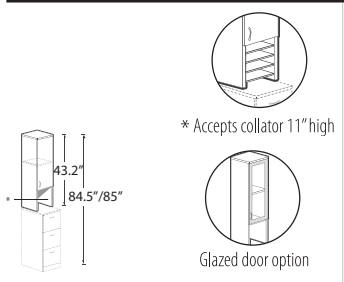

Table Top Bookcase with Door and Cavity - 43.2" High - RIGHT*

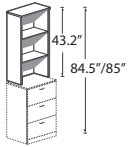

Table Top Bookcase 43.2" High



Table Top Bookcase 43.2" High*

MODEL #	DIMENSIONS W x D x H (1.5" TOP)	WT/LB.	CUBIC FT.	1" TOP	1.5" TOP	GLAZE ADD	HP ADD
Z21S43TCR	21 x 16 x 43.2	89	10.25	\$748	\$787	\$520	N/A
Z18S43TCR	18 x 16 x 43.2	81	9	\$716	\$750	\$466	N/A
Z16S43TCR	16 x 16 x 43.2	75	8	\$641	\$675	\$463	N/A
Z15S43TCR	15 x 16 x 43.2	72	7.5	\$603	\$632	\$406	N/A
Z12S43TCR	12 x 16 x 43.2	64	6.25	\$561	\$585	\$365	N/A

Designed to be placed **on top of 41.3"/41.8" high units to achieve 84.5"/85" final height.** Laminate door is standard. **DO NOT USE ON TOP OF 29.5"/30" HIGH UNITS. Includes one adjustable shelf.** Standard with lock. Shipped assembled in 1 carton.

Z36S43TN	36 x 16 x 43.2	105	17	\$733	\$794	N/A	N/A
Z30S43TN	30 x 16 x 43.2	92	14.5	\$636	\$687	N/A	N/A

Designed to be placed **on top of 41.3"/41.8" high units to achieve 84.5"/85" final height.** **DO NOT USE ON TOP OF 29.5"/30" HIGH UNITS. Includes two adjustable shelves.** Shipped assembled in 1 carton.

Z21S43TN	21 x 16 x 43.2	73	10.25	\$565	\$604	N/A	N/A
Z18S43TN	18 x 16 x 43.2	67	9	\$549	\$583	N/A	N/A
Z16S43TN	16 x 16 x 43.2	62	8	\$476	\$510	N/A	N/A
Z15S43TN	15 x 16 x 43.2	60	7.5	\$454	\$483	N/A	N/A
Z12S43TN	12 x 16 x 43.2	54	6.25	\$422	\$446	N/A	N/A

Designed to be placed **on top of 41.3"/41.8" high units to achieve 84.5"/85" final height.** **DO NOT USE ON TOP OF 29.5"/30" HIGH UNITS. Includes two adjustable shelves.** Shipped assembled in 1 carton.

END SHELVES

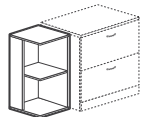

End Shelf 29.5"/30" High - LEFT

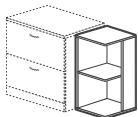

End Shelf 29.5"/30" High - RIGHT

Z24L2ESHL	24 x 24 x 30	100	4.75	\$628	\$679	N/A	\$114
Z20M2ESHL	20 x 20 x 30	77	3.75	\$519	\$555	N/A	\$69
Z16S2ESHL	16 x 16 x 30	54	2.25	\$439	\$473	N/A	\$69

For use at **left** end of **29.5"/30"H units. One adjustable shelf.** Shipped easy to assemble in 1 carton.

Z24L2ESHR	24 x 24 x 30	100	4.75	\$628	\$679	N/A	\$114
Z20M2ESHR	20 x 20 x 30	77	3.75	\$519	\$555	N/A	\$69
Z16S2ESHR	16 x 16 x 30	54	2.25	\$439	\$473	N/A	\$69

For use at **right** end of **29.5"/30"H units. One adjustable shelf.** Shipped easy to assemble in 1 carton.

Required specifications

- Top finish
- Top thickness/edge detail
- Base finish
- Handles*

Optional specifications

- HP laminate (only end shelves)
- Key #*
- Glazed door*
- Collator - position & finish*

END SHELVES	MODEL #	DIMENSIONS	WT/LB.	CUBIC FT.	1" TOP	1.5" TOP	GLAZE ADD	HP ADD
-------------	---------	------------	--------	-----------	--------	----------	-----------	--------

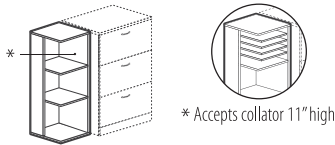

End Shelf 41.3"/41.8" High - LEFT*

	W x D x H (1.5" TOP)							
Z24L4ESHL	24 x 24 x 41.8	130	4.75	\$807	\$858	N/A	\$114	
Z20M4ESHL	20 x 20 x 41.8	101	3.25	\$677	\$713	N/A	\$69	
Z16S4ESHL	16 x 16 x 41.8	74	2.5	\$573	\$607	N/A	\$69	

For use at **left** end of **41.3"/41.8" H units**. **Two adjustable shelves**. Shipped easy to assemble in 1 carton.
 • Collator only available on **Z16S4ESHL**.

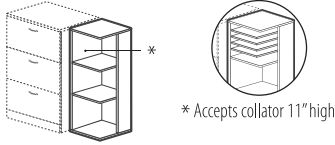

End Shelf 41.3"/41.8" High - RIGHT*

Z24L4ESHR	24 x 24 x 41.8	130	4.75	\$807	\$858	N/A	\$114	
Z20M4ESHR	20 x 20 x 41.8	101	3.25	\$677	\$713	N/A	\$69	
Z16S4ESHR	16 x 16 x 41.8	74	2.5	\$573	\$607	N/A	\$69	

For use at **right** end of **41.3"/41.8" H units**. **Two adjustable shelves**. Shipped easy to assemble in 1 carton.
 • Collator only available on **Z16S4ESHR**.

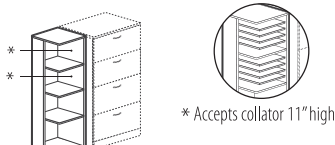

End Shelf 53"/53.5" High - LEFT*

Z24L5ESHL	24 x 24 x 53.5	163	4.75	\$1000	\$1051	N/A	\$114	
Z20M5ESHL	20 x 20 x 53.5	126	4	\$824	\$860	N/A	\$69	
Z16S5ESHL	16 x 16 x 53.5	91	3.25	\$695	\$729	N/A	\$69	

For use at **left** end of **53"/53.5" H units**. **Three adjustable shelves**. Shipped easy to assemble in 1 carton.
 • Collator only available on **Z16S5ESHL**.

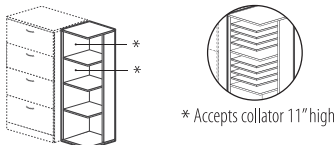

End Shelf 53"/53.5" High - RIGHT*

Z24L5ESHR	24 x 24 x 53.5	163	4.75	\$1000	\$1051	N/A	\$114	
Z20M5ESHR	20 x 20 x 53.5	126	4	\$824	\$860	N/A	\$69	
Z16S5ESHR	16 x 16 x 53.5	91	3.25	\$695	\$729	N/A	\$69	

For use at **right** end of **53"/53.5" H units**. **Three adjustable shelves**. Shipped easy to assemble in 1 carton.
 • Collator only available on **Z16S5ESHR**.

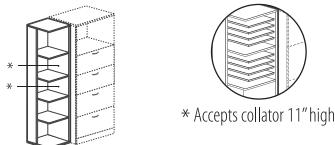

End Shelf 65.5"/66" High - LEFT

Z24L6ESHL	24 x 24 x 66	196	6	\$1169	\$1220	N/A	N/A	
Z20M6ESHL	20 x 20 x 66	152	5	\$972	\$1008	N/A	N/A	
Z16S6ESHL	16 x 16 x 66	111	4.25	\$829	\$863	N/A	N/A	

For use at **left** end of **65.5"/66" H units**. **Four adjustable shelves**. Shipped easy to assemble in 1 carton.
 • Collator only available on **Z16S6ESHL**.

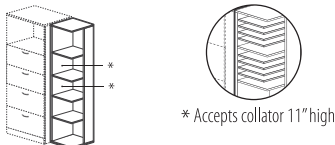

End Shelf 65.5"/66" High - RIGHT

Z24L6ESHR	24 x 24 x 66	196	6	\$1169	\$1220	N/A	N/A	
Z20M6ESHR	20 x 20 x 66	152	5	\$972	\$1008	N/A	N/A	
Z16S6ESHR	16 x 16 x 66	111	4.25	\$829	\$863	N/A	N/A	

For use at **right** end of **65.5"/66" H units**. **Four adjustable shelves**. Shipped easy to assemble in 1 carton.
 • Collator only available on **Z16S6ESHR**.

Required specifications

Top finish
 Top thickness/edge detail
 Base finish

Optional specifications

HP laminate*
 Collator - position & finish

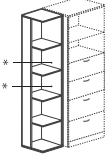
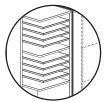
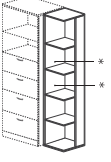
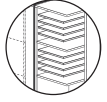
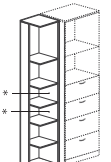
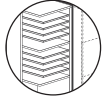
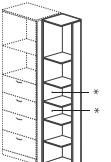
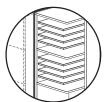
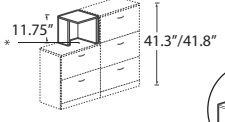
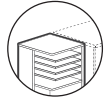
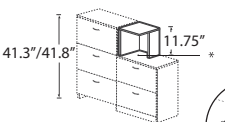
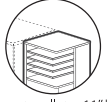
END SHELVES	MODEL #	DIMENSIONS	WT/LB.	CUBIC FT.	1" TOP	1.5" TOP	GLAZE ADD	HP ADD
		W x D x H (1.5" TOP)						
  * Accepts collator 11" high	Z24L7ESHL	24 x 24 x 72.4	207	6.5	\$1228	\$1279	N/A	N/A
	Z20M7ESHL	20 x 20 x 72.4	161	5.75	\$1025	\$1061	N/A	N/A
	Z16S7ESHL	16 x 16 x 72.4	118	4.75	\$870	\$904	N/A	N/A
For use at left end of 72"/72.5"H units . Four adjustable shelves . Shipped easy to assemble in 1 carton. <ul style="list-style-type: none"> • Collator only available on Z16S7ESHL. 								
  * Accepts collator 11" high	Z24L7ESHR	24 x 24 x 72.4	207	6.5	\$1228	\$1279	N/A	N/A
	Z20M7ESHR	20 x 20 x 72.4	161	5.75	\$1025	\$1061	N/A	N/A
	Z16S7ESHR	16 x 16 x 72.4	118	4.75	\$870	\$904	N/A	N/A
For use at right end of 72"/72.5"H units . Four adjustable shelves . Shipped easy to assemble in 1 carton. <ul style="list-style-type: none"> • Collator only available on Z16S7ESHR. 								
  * Accepts collator 11" high	Z24L8ESHL	24 x 24 x 84.9	242	7.75	\$1412	\$1463	N/A	N/A
	Z20M8ESHL	20 x 20 x 84.9	186	6.5	\$1175	\$1211	N/A	N/A
	Z16S8ESHL	16 x 16 x 84.9	137	5.5	\$998	\$1032	N/A	N/A
For use at left end of 84.5"/85"H units . Five adjustable shelves . Shipped easy to assemble in 1 carton. <ul style="list-style-type: none"> • Collator only available on Z16S8ESHL. 								
  * Accepts collator 11" high	Z24L8ESHR	24 x 24 x 84.9	242	7.75	\$1412	\$1463	N/A	N/A
	Z20M8ESHR	20 x 20 x 84.9	186	6.5	\$1175	\$1211	N/A	N/A
	Z16S8ESHR	16 x 16 x 84.9	137	5.5	\$998	\$1032	N/A	N/A
For use at RIGHT end of 84.5"/85"H units . Five adjustable shelves . Shipped easy to assemble in 1 carton. <ul style="list-style-type: none"> • Collator only available on Z16S8ESHR. 								
  * Accepts collator 11" high	Z16S12DL	16 x 16 x 11.75	26	1.6	\$222	\$256	N/A	\$69
	To be placed on top of 29.5"/30"H units . For use at left end of 41.3"/41.8"H units . Shipped easy to assemble in 1 carton.							
  * Accepts collator 11" high	Z16S12DR	16 x 16 x 11.75	26	1.6	\$222	\$256	N/A	\$69
	To be placed on top of 29.5"/30"H units . For use at right end of 41.3"/41.8"H units . Shipped easy to assemble in 1 carton.							

Required specifications

Top finish
 Top thickness/edge detail
 Base finish

Optional specifications

HP laminate*
 Collator - position & finish

TABLE TOP END SHELVES	MODEL #	DIMENSIONS	WT/LB.	CUBIC FT.	1" TOP	1.5" TOP	GLAZE ADD	HP ADD
-----------------------	---------	------------	--------	-----------	--------	----------	-----------	--------

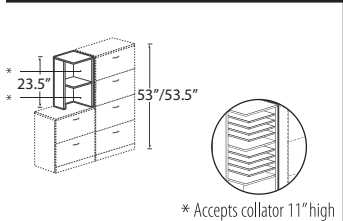

Table Top End Shelf 23.5\"/>

W x D x H (1.5\"/>								
Z16S23DL	16 x 16 x 23.5	42	1.6	\$343	\$377	N/A	\$69	

To be placed **on top of 29.5\"/>**

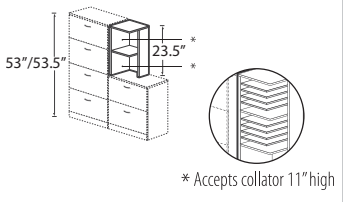

Table Top End Shelf 23.5\"/>

Z16S23DR	16 x 16 x 23.5	42	1.6	\$343	\$377	N/A	\$69	
----------	----------------	----	-----	-------	-------	-----	------	--

To be placed **on top of 29.5\"/>**

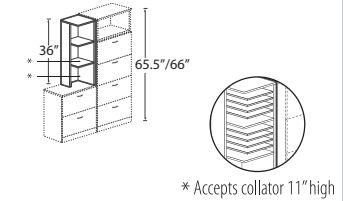

Table Top End Shelf 36\"/>

Z16S36DL	16 x 16 x 36	63	2.8	\$480	\$514	N/A	N/A	
----------	--------------	----	-----	-------	-------	-----	-----	--

To be placed **on top of 29.5\"/>**

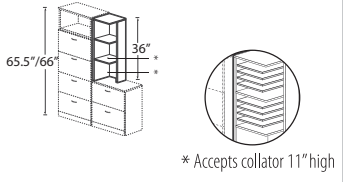

Table Top End Shelf 36\"/>

Z16S36DR	16 x 16 x 36	63	2.8	\$480	\$514	N/A	N/A	
----------	--------------	----	-----	-------	-------	-----	-----	--

To be placed **on top of 29.5\"/>**

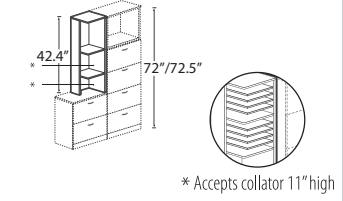

Table Top End Shelf 42.4\"/>

Z16S42DL	16 x 16 x 42.4	70	2.8	\$518	\$552	N/A	N/A	
----------	----------------	----	-----	-------	-------	-----	-----	--

To be placed **on top of 29.5\"/>**

Required specifications

- Top finish
- Top thickness/edge detail
- Base finish

Optional specifications

- HP laminate*
- Collator - position & finish

TABLE TOP END SHELVES	MODEL #	DIMENSIONS	WT/LB.	CUBIC FT.	1" TOP	1.5" TOP	GLAZE ADD	HP ADD
		W x D x H (1.5" TOP)						
" data-bbox="88 75 270 160"/> <p>72"/72.5" 42.4" * Accepts collator 11" high</p> <p>Table Top End Shelf 42.4" High - RIGHT</p>	Z16S42DR	16 x 16 x 42.4	70	2.8	\$518	\$552	N/A	N/A
To be placed on top of 29.5"/30"H units . For use at right end of 72"/72.5"H units . Two adjustable shelves. Shipped easy to assemble in 1 carton.								
" data-bbox="88 225 270 310"/> <p>54.9" 84.5"/85" * Accepts collator 11" high</p> <p>Table Top End Shelf 54.9" High - LEFT</p>	Z16S55DL	16 x 16 x 54.9	89	2.8	\$642	\$676	N/A	N/A
To be placed on top of 29.5"/30"H units . For use at left end of 84.5"/85"H units . Three adjustable shelves. Shipped easy to assemble in 1 carton.								
" data-bbox="88 385 270 470"/> <p>84.5"/85" 54.9" * Accepts collator 11" high</p> <p>Table Top End Shelf 54.9" High - RIGHT</p>	Z16S55DR	16 x 16 x 54.9	89	2.8	\$642	\$676	N/A	N/A
To be placed on top of 29.5"/30"H units . For use at right end of 84.5"/85"H units . Three adjustable shelves. Shipped easy to assemble in 1 carton.								

ACCESSORIES	LIST PRICE							
-------------	------------	--	--	--	--	--	--	--

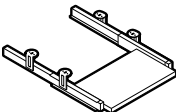
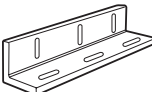
 <p>Pull-Out Keyboard*</p>	APOKL28	28 x 17 x 3.5	13	0.9	\$296			
	APOKL22	22 x 17 x 3.5	12	0.9	\$270			
APOKL28 will accommodate keyboard and mouse pad. APOKL28 will only fit on a single pedestal desk, freestanding table, or Z42205C .								
 <p>L Bracket*</p>	MLB90	4 x 1 x 1	0.10	0.10	\$12			
Used to attach worksurfaces to end panels. Black only.								

Required specifications

Top finish
Top thickness/edge detail
Base finish
Finish*

Optional specifications

Collator - position & finish

ACCESSORIES	MODEL #	DIMENSIONS W x D x H	WT/LB.	CUBIC FT.	LIST PRICE	HP ADD
Skateboard - LEFT*	Z1425SKL	25 x 13.9 x 3.7	13	1.5	\$124	\$128
Mobile CPU holder designed to fit inside 'faux' pedestals of a single pedestal desk.						
Skateboard - RIGHT*	Z1425SKR	25 x 13.9 x 3.7	13	1.5	\$124	\$128
Mobile CPU holder designed to fit inside 'faux' pedestals of a single pedestal desk.						

CENTER DRAWERS	MODEL #	DIMENSIONS W x D x H	WT/LB.	CUBIC FT.	LIST PRICE	HP ADD
Center Drawer	CD28	28 x 18 x 3	5	1	\$248	N/A
Laminate drawer front is attached to a four-sided frame. Recommended for use on 36" and 72" desks.						

HANDLES	MODEL #	DIMENSIONS W x D x H	WT/LB.	CUBIC FT.	LIST PRICE	HP ADD
Silver Handle (HV)	HANDLE HV	5 x - x -	0.25	0.1	\$18	N/A
Silver finish, square edge handle style. For use on pedestals and all lateral files.						
<ul style="list-style-type: none"> This handle has a measurement of 96mm center to center. Drawer handles on this page are for purchase. Installation is done by the customer. To purchase as a factory installed option on desks, credenzas and returns, see series notes (page 111) for option codes and upcharge. 						
Matte Black Handle (HU)	HANDLE HU	5 x - x -	0.25	0.1	\$18	N/A
Black matte finish, square edge handle style. For use on pedestals and all lateral files.						
<ul style="list-style-type: none"> This handle has a measurement of 96mm center to center. Drawer handles on this page are for purchase. Installation is done by the customer. To purchase as a factory installed option on desks, credenzas and returns, see series notes (page 111) for option codes and upcharge. 						
Flared Black Handle (HX)	HANDLE HX	5.25 x - x -	0.25	0.1	\$18	N/A
Black matte finish, flared handle style. For use on pedestals and all lateral files.						
<ul style="list-style-type: none"> This handle has a measurement of 96mm center to center. Drawer handles on this page are for purchase. Installation is done by the customer. To purchase as a factory installed option on desks, credenzas and returns, see series notes (page 111) for option codes and upcharge. 						
Flared Silver Handle (HS)	HANDLE HS	4.5 x - x -	0.25	0.1	\$18	N/A
Silver matte finish, flared handle style. For use on pedestals and all lateral files.						
<ul style="list-style-type: none"> This handle has a measurement of 96mm center to center. Drawer handles on this page are for purchase. Installation is done by the customer. To purchase as a factory installed option on desks, credenzas and returns, see series notes (page 111) for option codes and upcharge. 						

Required specifications
Finish (not handles)

Optional specifications
HP laminate*

HANDLES	MODEL #	DIMENSIONS	WT/LB.	CUBIC FT.	LIST PRICE
<p>Dimpled Nickel Handle (HZ)</p>		W x D x H			
	HANDLE HZ	4.9 x - x -	0.25	0.1	\$18
<p>Nickel matte finish, dimpled handle style. For use on pedestals and all lateral files.</p> <ul style="list-style-type: none"> • This handle has a measurement of 96mm center to center. • Drawer handles on this page are for purchase. Installation is done by the customer. To purchase as a factory installed option on desks, credenzas and returns, see series notes (page 111) for option codes and upcharge. 					
<p>Crescent Black Handle (HO)</p>		W x D x H			
	HANDLE HO	4.75 x - x -	0.25	0.1	\$18
<p>Black matte finish, crescent handle style. For use on pedestals and all lateral files.</p> <ul style="list-style-type: none"> • This handle has a measurement of 96mm center to center. • Drawer handles on this page are for purchase. Installation is done by the customer. To purchase as a factory installed option on desks, credenzas and returns only, see series notes (page 111) for option codes and upcharge. 					
<p>Bar Silver Handle (HQ)</p>		W x D x H			
	HANDLE HQ	4.6 x - x -	0.25	0.1	\$18
<p>Silver finish, bar handle style. For use on pedestals and all lateral files.</p> <ul style="list-style-type: none"> • This handle has a measurement of 96mm center to center. • Drawer handles on this page are for purchase. Installation is done by the customer. To purchase as a factory installed option on desks, credenzas and returns only, see series notes (page 111) for option codes and upcharge. 					
<p>Bar Black Handle (HR)</p>		W x D x H			
	HANDLE HR	4.6 x - x -	0.25	0.1	\$18
<p>Black finish, bar handle style. For use on pedestals and all lateral files.</p> <ul style="list-style-type: none"> • This handle has a measurement of 96mm center to center. • Drawer handles on this page are for purchase. Installation is done by the customer. To purchase as a factory installed option on desks, credenzas and returns only, see series notes (page 111) for option codes and upcharge. 					

TOP AND BASE FINISHES

ACJ Absolute Acajou	FCL First Class
ASN Asian Night	NBL Noce Biondo
AWC Avant Cherry	NGL Noce Grigio
AWH Avant Honey	NEL Noce Leggero
BLK Black	NML Noce Medio
BZD Blizzard	QTM Quartered Mahogany
BRC Brushed Cobalt	SBY Sheer Beauty
CMB Clear Maple	SDT Stonedust
CGY Custom Grey	SOG Storm Grey
DES Dark Espresso	WHE Walnut Heights
DWT Designer White	WHC White Chocolate
FAS Fashionista	WCR Winter Cherry

BASE TRIM FINISHES

BRC Brushed Cobalt
BLK Black

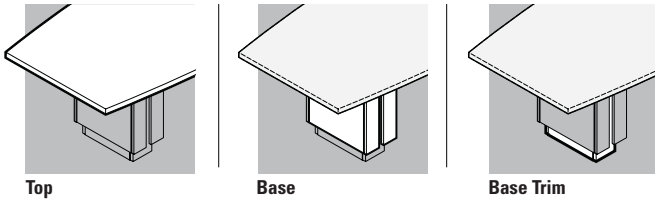

TOP THICKNESS/EDGE DETAIL



BASES

- 2 doors on base for wire management access from both sides.
- Because of base sizes, custom width less than 96" cannot be accommodated.

TOPS

- 96" tops are standard in one piece. All tops 120", 144" and 168" tops are standard in two equal size pieces. Woodgrain laminate finishes may NOT align where the two tops join. Tops 192" and larger are standard in 3 equal pieces.
- 96" tops are standard with **two bases**.
- Tops 120", 144" and 168" are standard with **three bases**.
- Tops 169" to 288" and larger are standard with **four bases**.
- **Five** top shapes: **boat shaped, bow end, rectangular, racetrack** and **wedge**.

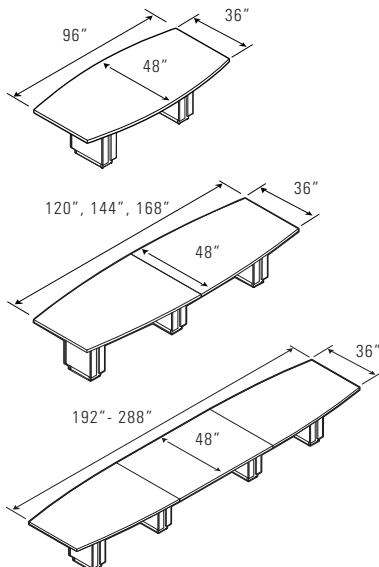

POWER BLOCK OPTIONS AND CUT-OUT LOCATIONS

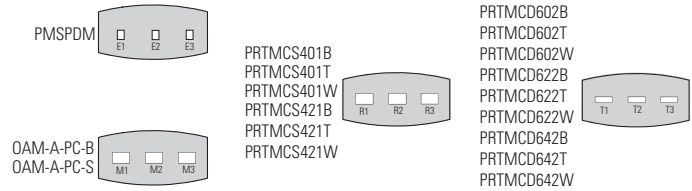

- For **Square, Media** and **Collaborative Tables**, please refer to the electronic Zira Design Guide found on the Global website under Brochures.

CUT-OUTS

- **Boardroom** and **collaborative tables** offer optional cut-outs for in-surface mounted power modules in three standard locations - left, center or right (E1, E2 or E3, etc as per above grid) for all table shapes excluding square boardroom tables. **Add \$91** for each cut-out.
- Cut-out options for **square boardroom tables** in centered position only - E2, M2, R2 or T2. **Add \$91**.
- Cut-out options for **media tables** in position 1 only - E1, M1, R1 or T1. **Add \$91**.
- Cut-outs may be placed at non-standard locations. Please submit a NON-STANDARD CUT-OUT request form with your order. Forms can be found on the Global Dealer Center under "Specials".
- Available power modules are listed on pages 467-469.
- Be sure to specify matching power module with corresponding cut-out codes (as per above grid). Cut-out size(s) and orientation(s) are specific to the power module(s).
- Refer to **Zira Boardroom Design Guide** online for more information.

AUDIOVISUAL

Three components: multimedia cart, lectern and visual board.

Multimedia Cart

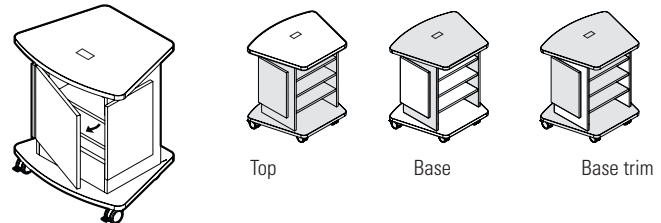

Lectern

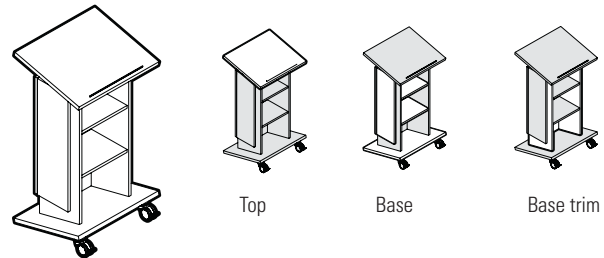

Multimedia Cart and Lectern:

- Available in all laminates listed on previous page.
- Color of casters will match base trim.
- Offered in the following **top thickness and edge details:**



A3 1" top, standard flat edge



AR 1" top, bicut edge



C3 1.5" top, standard flat edge



CR 1.5" top, bicut edge



CF 1.5" top, fluted edge

Visual Board:

- Available in all laminates listed on previous page.
- Push bar available in Black (**BLK**) or Tungsten (**TUN**).
- Color of casters and aluminum trim will match push bar.
- Visual board comes standard in White color.

BUFFET

Three components - buffet carts, buffets and serving carts:

- Top and/or base available in all laminates.
- Push bar on buffet and serving carts, and aluminum trim on open and mixed buffets available in Black (**BLK**) or Tungsten (**TUN**).
- Optional glazing available on serving carts and buffets with hinged doors.

Buffet Carts



Top



Base

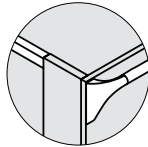

Serving Cart with Doors

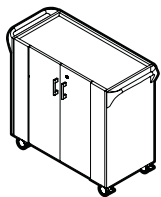

Top



Base

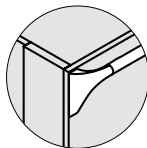

Serving Cart - Open

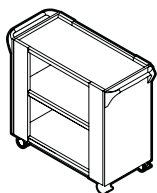

Top



Base

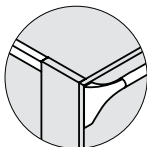

SPECIFICATIONS

- Specifications marked with an * are applicable to only those products which have the * symbol beside the product name.

Buffet - Open

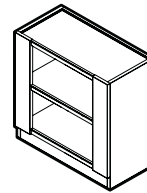

Top



Base

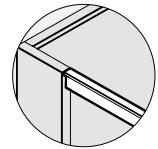

Buffet with Doors

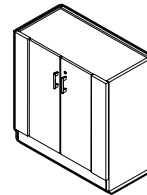

Top



Base

Buffet - Mixed

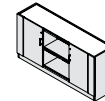
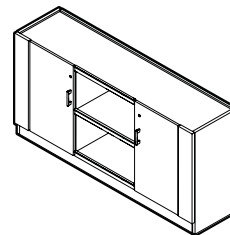

Top

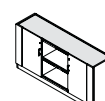

Base

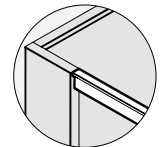

Glazing (Doors - Serving Cart and Buffets)



Z1 frosted glazing, Tungsten (TUN) frame



Z2 frosted glazing, Black (BLK) frame



Z3 ribbed glazing, Tungsten (TUN) frame

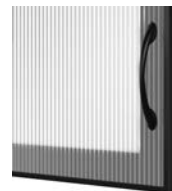

Z4 ribbed glazing, Black (BLK) frame

HANDLES

- Handles are standard on models with doors. Each handle is identified by the letters **HS, HV, HO, HW, HU, HZ, HX, HQ** and **HR**. To specify a handle, please specify the code after the model number. Lock finish will complement handle lock finish.



HS flared Silver



HV square edge Silver



HO crescent Black



HW flared Brass



HU square edge Black



HZ dimpled Nickel



HX flared Black



HQ bar Silver



HR bar Black

TABLE NOTES - ESTIMATED CAPACITY

- Use the following to determine the size of a round table and the number of chairs needed for a conference area. All estimates are based on an average chair width of 23" with a 4" clearance between chairs. Adjust accordingly for a different chair size.

Top Size	Rectangular	Bow End	Boat	Racetrack
48 x 96	6-8	6-8	6-8	6-8
48 x 120	8-10	8-10	8-10	8-10
48 x 144	10-12	10-12	10-12	10-12
48 x 168	12-14	12-14	12-14	12-14
48 x 192	14-16	14-16	14-16	14-16
48 x 216	16-18	16-18	16-18	16-18
48 x 240	18-20	18-20	18-20	18-20
48 x 264	20-22	20-22	20-22	20-22
48 x 288	22-24	22-24	22-24	22-24

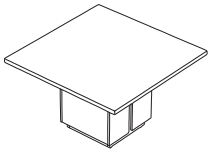
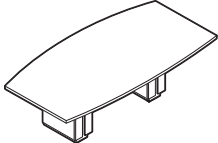
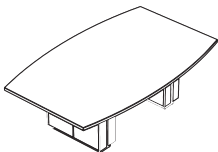
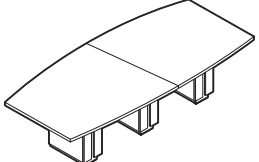
BOARDROOM TABLES	MODEL #	DIMENSIONS	WT/LB.	CUBIC FT.	1" TOP	1.5" TOP	GLAZE ADD	HP ADD	
 <p>Boardroom Table - Square</p>	W x D x H (1.5" TOP)								
	Z3636SQ	36 x 36 x 30	129	10	N/A	\$2716	N/A	\$309	
	Z4242SQ	42 x 42 x 30	165.5	13.5	N/A	\$3097	N/A	\$421	
	Z4848SQ	48 x 48 x 30	190	14.25	N/A	\$3357	N/A	\$548	
	Z5454SQ	54 x 54 x 30	262	21.25	N/A	\$3753	N/A	\$695	
	Z6060SQ	60 x 60 x 30	300	22.75	N/A	\$4014	N/A	\$857	
Square table includes one base with wire access doors on each side of base. Shipped easy to assemble in 2 cartons.									
 <p>Boardroom Table - Boat Shaped</p>	Z4896BE	96 x 48 x 30	342	22	N/A	\$3578	N/A	\$935	
	Boat shaped table includes two bases with wire access doors on each side of base and wire concealment runners between bases. Shipped easy to assemble in 3 cartons.								
 <p>Boardroom Table - Boat Shaped</p>	Z6096BE	96 x 60 x 30	432	35.5	N/A	\$7197	N/A	\$1368	
	Boat shaped table includes two bases with wire access doors on each side of base and wire concealment runners between bases. Shipped easy to assemble in 3 cartons.								
 <p>Boardroom Table - Boat Shaped</p>	Z48120BE	120 x 48 x 30	452	28.3	N/A	\$5146	N/A	\$1170	
	Z48144BE	144 x 48 x 30	502	30.5	N/A	\$5196	N/A	\$1405	
	Z48168BE	168 x 48 x 30	557	37.25	N/A	\$6768	N/A	\$1597	
Boat shaped table includes three bases with wire access doors on each side of base and wire concealment runners between bases. Z48144BE and Z48120BE shipped easy to assemble in 4 cartons. Z48168BE shipped easy to assemble in 5 cartons.									

Required specifications

Top finish
Top thickness/edge detail
Base finish
Base trim finish

Optional specifications

HP laminate
Cut-out for power block

Accessories

Power block

BOARDROOM TABLES	MODEL #	DIMENSIONS	WT/LB.	CUBIC FT.	1" TOP	1.5" TOP	GLAZE ADD	HP ADD
------------------	---------	------------	--------	-----------	--------	----------	-----------	--------

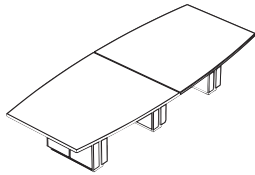

Boardroom Table - Boat Shaped

	W x D x H (1.5" TOP)							
Z60120BE	120 x 60 x 30	599	48.5	N/A	\$10918	N/A	\$1711	
Z60144BE	144 x 60 x 30	664.65	53.25	N/A	\$11684	N/A	\$2054	
Z60168BE	168 x 60 x 30	741.3	58	N/A	\$12598	N/A	\$2396	

Boat shaped table includes three bases with wire access doors on each side of base and wire concealment runners between bases. Shipped easy to assemble in 5 cartons.

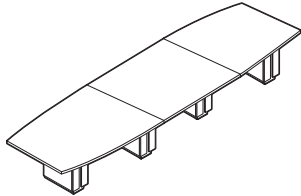

Boardroom Table - Boat Shaped

Z48192BE	192 x 48 x 30	688	45.75	N/A	\$8455	N/A	\$1824	
Z48216BE	216 x 48 x 30	746	48.75	N/A	\$8850	N/A	\$2054	
Z48240BE	240 x 48 x 30	803	51.75	N/A	\$9411	N/A	\$2281	
Z48264BE	264 x 48 x 30	855	54.75	N/A	\$9967	N/A	\$2509	
Z48288BE	288 x 48 x 30	906	57.75	N/A	\$9967	N/A	\$2739	

Boat shaped table includes four bases with wire access doors on each side of base and wire concealment runners between bases. Shipped easy to assemble in 7 cartons.

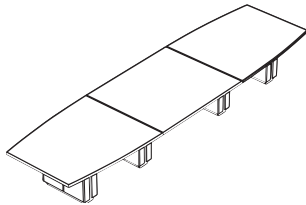

Boardroom Table - Boat Shaped

Z60192BE	192 x 60 x 30	912.45	71.25	N/A	\$15850	N/A	\$2739	
Z60216BE	216 x 60 x 30	980.7	76	N/A	\$16734	N/A	\$3081	
Z60240BE	240 x 60 x 30	1062.6	81	N/A	\$17456	N/A	\$3422	
Z60264BE	264 x 60 x 30	1129.8	85.75	N/A	\$18148	N/A	\$3763	
Z60288BE	288 x 60 x 30	1198.05	90.5	N/A	\$19260	N/A	\$4106	

Boat shaped table includes four bases with wire access doors on each side of base and wire concealment runners between bases. Shipped easy to assemble in 7 cartons.

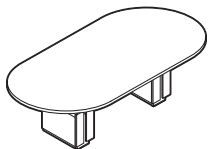

Boardroom Table - Racetrack

Z4896RTE	96 x 48 x 30	336	22	N/A	\$3478	N/A	\$935	
----------	--------------	-----	----	-----	---------------	-----	--------------	--

Racetrack shaped table includes two bases with wire access doors on each side of base and wire concealment runners between bases. Shipped easy to assemble in 3 cartons.

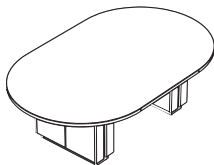

Boardroom Table - Racetrack

Z6096RTE	96 x 60 x 30	417	35.5	N/A	\$7197	N/A	\$1368	
----------	--------------	-----	------	-----	---------------	-----	---------------	--

Racetrack shaped table includes two bases with wire access doors on each side of base and wire concealment runners between bases. Shipped easy to assemble in 3 cartons.

Required specifications

- Top finish
- Top thickness/edge detail
- Base finish
- Base trim finish

Optional specifications

- HP laminate
- Cut-out for power block

Accessories

- Power block

Z ZIRA™ BOARDROOM

BOARDROOM TABLES

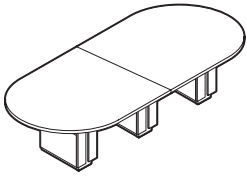

Boardroom Table - Racetrack

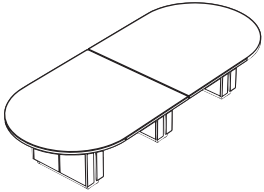

Boardroom Table - Racetrack

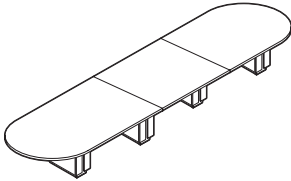

Boardroom Table - Racetrack

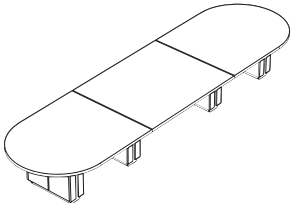

Boardroom Table - Racetrack

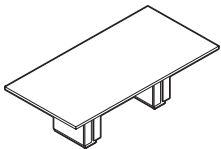

Boardroom Table - Rectangular

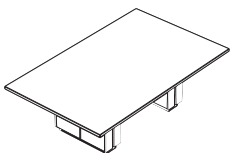

Boardroom Table - Rectangular

MODEL #	DIMENSIONS W x D x H (1.5" TOP)	WT/LB.	CUBIC FT.	1" TOP	1.5" TOP	GLAZE ADD	HP ADD
Z4812ORTE	120 x 48 x 30	453	28.3	N/A	\$4839	N/A	\$1170
Z48144RTE	144 x 48 x 30	506	30.5	N/A	\$5158	N/A	\$1405
Z48168RTE	168 x 48 x 30	563	37.25	N/A	\$6809	N/A	\$1597

Racetrack shaped table includes three bases with wire access doors on each side of base and wire concealment runners between bases. Z48144RTE and Z4812ORTE shipped easy to assemble in 4 cartons. Z48168RTE shipped easy to assemble in 5 cartons.

Z6012ORTE	120 x 60 x 30	585.9	48.5	N/A	\$10918	N/A	\$1711
Z60144RTE	144 x 60 x 30	656.25	53.25	N/A	\$11684	N/A	\$2054
Z60168RTE	168 x 60 x 30	737.1	58	N/A	\$12598	N/A	\$2396

Racetrack shaped table includes three bases with wire access doors on each side of base and wire concealment runners between bases. Shipped easy to assemble in 5 cartons.

Z48192RTE	192 x 48 x 30	689	45.75	N/A	\$8494	N/A	\$1824
Z48216RTE	216 x 48 x 30	749	48.75	N/A	\$8891	N/A	\$2054
Z48240RTE	240 x 48 x 30	809	51.75	N/A	\$9451	N/A	\$2281
Z48264RTE	264 x 48 x 30	862	54.75	N/A	\$10009	N/A	\$2509
Z48288RTE	288 x 48 x 30	917	57.75	N/A	\$10009	N/A	\$2739

Racetrack shaped table includes four bases with wire access doors on each side of base and wire concealment runners between bases. Shipped easy to assemble in 7 cartons.

Z60192RTE	192 x 60 x 30	901.95	71.25	N/A	\$15850	N/A	\$2739
Z60216RTE	216 x 60 x 30	972.3	76	N/A	\$16734	N/A	\$3081
Z60240RTE	240 x 60 x 30	1057.35	81	N/A	\$17456	N/A	\$3422
Z60264RTE	264 x 60 x 30	1127.7	85.75	N/A	\$18148	N/A	\$3763
Z60288RTE	288 x 60 x 30	1198.05	90.5	N/A	\$19260	N/A	\$4106

Racetrack shaped table includes four bases with wire access doors on each side of base and wire concealment runners between bases. Shipped easy to assemble in 7 cartons.

Z4896REE	96 x 48 x 30	356	22	N/A	\$3562	N/A	\$935
----------	--------------	-----	----	-----	---------------	-----	--------------

Rectangular shaped table includes two bases with wire access doors on each side of base and wire concealment runners between bases. Shipped easy to assemble in 3 cartons.

Z6096REE	96 x 60 x 30	448	35.5	N/A	\$6598	N/A	\$1368
----------	--------------	-----	------	-----	---------------	-----	---------------

Rectangular shaped table includes two bases with wire access doors on each side of base and wire concealment runners between bases. Shipped easy to assemble in 3 cartons.

Required specifications

Top finish
Top thickness/edge detail
Base finish
Base trim finish

Optional specifications

HP laminate
Cut-out for power block

Accessories

Power block

BOARDROOM TABLES	MODEL #	DIMENSIONS	WT/LB.	CUBIC FT.	1" TOP	1.5" TOP	GLAZE ADD	HP ADD
------------------	---------	------------	--------	-----------	--------	----------	-----------	--------

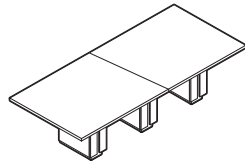

Boardroom Table - Rectangular

	W x D x H (1.5" TOP)							
Z48120REE	120 x 48 x 30	472	28.3	N/A	\$4824	N/A	\$1170	
Z48144REE	144 x 48 x 30	525	30.5	N/A	\$5166	N/A	\$1405	
Z48168REE	168 x 48 x 30	583	37.25	N/A	\$6708	N/A	\$1597	

Rectangular shaped table includes three bases with wire access doors on each side of base and wire concealment runners between bases. Z48144REE and Z48120REE shipped easy to assemble in 4 cartons. Z48168REE shipped easy to assemble in 5 cartons.

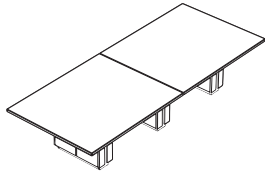

Boardroom Table - Rectangular

Z60120REE	120 x 60 x 30	618	48.5	N/A	\$10001	N/A	\$1711	
Z60144REE	144 x 60 x 30	688	53.25	N/A	\$10705	N/A	\$2054	
Z60168REE	168 x 60 x 30	769	58	N/A	\$11532	N/A	\$2396	

Rectangular shaped table includes three bases with wire access doors on each side of base and wire concealment runners between bases. Shipped easy to assemble in 5 cartons.

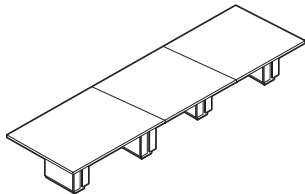

Boardroom Table - Rectangular

Z48192REE	192 x 48 x 30	708	45.75	N/A	\$8397	N/A	\$1824	
Z48216REE	216 x 48 x 30	768	48.75	N/A	\$8791	N/A	\$2054	
Z48240REE	240 x 48 x 30	828	51.75	N/A	\$9351	N/A	\$2281	
Z48264REE	264 x 48 x 30	882	54.75	N/A	\$9909	N/A	\$2509	
Z48288REE	288 x 48 x 30	936	57.75	N/A	\$9909	N/A	\$2739	

Rectangular shaped table includes four bases with wire access doors on each side of base and wire concealment runners between bases. Shipped easy to assemble in 7 cartons.

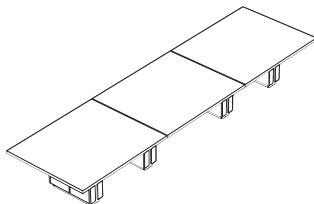

Boardroom Table - Rectangular

Z60192REE	192 x 60 x 30	941.85	71.25	N/A	\$14523	N/A	\$2739	
Z60216REE	216 x 60 x 30	1003.8	76	N/A	\$15334	N/A	\$3081	
Z60240REE	240 x 60 x 30	1088.85	81	N/A	\$15992	N/A	\$3422	
Z60264REE	264 x 60 x 30	1159.2	85.75	N/A	\$16619	N/A	\$3763	
Z60288REE	288 x 60 x 30	1229.55	90.5	N/A	\$17624	N/A	\$4106	

Rectangular shaped table includes four bases with wire access doors on each side of base and wire concealment runners between bases. Shipped easy to assemble in 7 cartons.

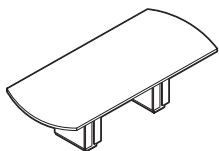

Boardroom Table - Bow End

Z4896BW	96 x 48 x 30	329	22	N/A	\$3688	N/A	\$935	
---------	--------------	-----	----	-----	---------------	-----	--------------	--

Bow end table includes two bases with wire access doors on each side of base and wire concealment runners between bases. Shipped easy to assemble in 3 cartons.

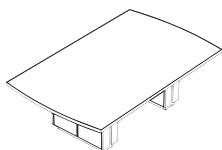

Boardroom Table - Bow End

Z6096BW	96 x 60 x 30	436	35.5	N/A	\$7197	N/A	\$1368	
---------	--------------	-----	------	-----	---------------	-----	---------------	--

Bow end table includes two bases with wire access doors on each side of base and wire concealment runners between bases. Shipped easy to assemble in 3 cartons.

Required specifications

- Top finish
- Top thickness/edge detail
- Base finish
- Base trim finish

Optional specifications

- HP laminate
- Cut-out for power block

Accessories

- Power block

Z ZIRA™ BOARDROOM

BOARDROOM TABLES

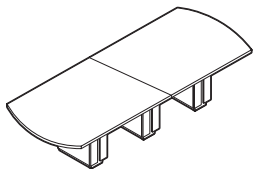

Boardroom Table - Bow End

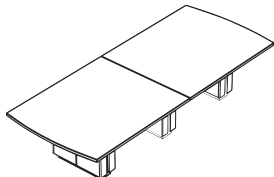

Boardroom Table - Bow End

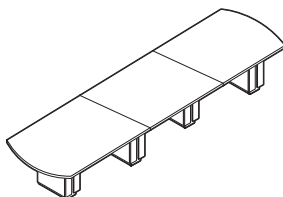

Boardroom Table - Bow End

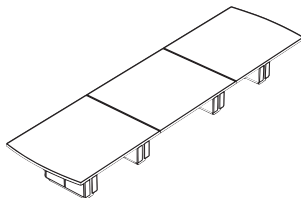

Boardroom Table - Bow End

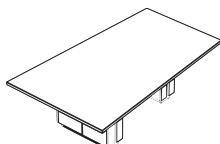

Boardroom Table - Wedge

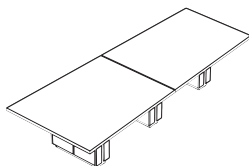

Boardroom Table - Wedge

MODEL #	DIMENSIONS W x D x H (1.5" TOP)	WT/LB.	CUBIC FT.	1" TOP	1.5" TOP	GLAZE ADD	HP ADD
Z48120BW	120 x 48 x 30	476	28.3	N/A	\$4914	N/A	\$1170
Z48144BW	144 x 48 x 30	513	30.5	N/A	\$5259	N/A	\$1405
Z48168BW	168 x 48 x 30	573	37.25	N/A	\$6739	N/A	\$1597

Bow end table includes three bases with wire access doors on each side of base and wire concealment runners between bases. Z48144BW and Z48120BW shipped easy to assemble in 4 cartons. Z48168BW shipped easy to assemble in 5 cartons.

Z60120BW	120 x 60 x 30	602	48.5	N/A	\$10918	N/A	\$1711
Z60144BW	144 x 60 x 30	673	53.25	N/A	\$11684	N/A	\$2054
Z60168BW	168 x 60 x 30	753	58	N/A	\$12598	N/A	\$2396

Bow end table includes three bases with wire access doors on each side of base and wire concealment runners between bases. Shipped easy to assemble in 5 cartons.

Z48192BW	192 x 48 x 30	698	45.75	N/A	\$8426	N/A	\$1824
Z48216BW	216 x 48 x 30	758	48.75	N/A	\$8821	N/A	\$2054
Z48240BW	240 x 48 x 30	818	51.75	N/A	\$9381	N/A	\$2281
Z48264BW	264 x 48 x 30	872	54.75	N/A	\$9939	N/A	\$2509
Z48288BW	288 x 48 x 30	926	57.75	N/A	\$9939	N/A	\$2739

Bow end table includes four bases with wire access doors on each side of base and wire concealment runners between bases. Shipped easy to assemble in 7 cartons.

Z60192BW	192 x 60 x 30	917.7	71.25	N/A	\$15850	N/A	\$2739
Z60216BW	216 x 60 x 30	988.05	76	N/A	\$16734	N/A	\$3081
Z60240BW	240 x 60 x 30	1073.1	81	N/A	\$17456	N/A	\$3422
Z60264BW	264 x 60 x 30	1143.45	85.75	N/A	\$18148	N/A	\$3763
Z60288BW	288 x 60 x 30	1213.8	90.5	N/A	\$19260	N/A	\$4106

Bow end table includes four bases with wire access doors on each side of base and wire concealment runners between bases. Shipped easy to assemble in 7 cartons.

Z6096WE	96 x 60 x 30	398	26.25	N/A	\$7197	N/A	\$1368
---------	--------------	-----	-------	-----	---------------	-----	---------------

Wedge table includes two bases with wire access doors on each side of base and wire concealment runners between bases. Wedge tapers from 60"W to 48"W. Shipped easy to assemble in 3 cartons.

Z60120WE	120 x 60 x 30	544.95	36.5	N/A	\$10918	N/A	\$1711
Z60144WE	144 x 60 x 30	603.75	39.5	N/A	\$11684	N/A	\$2054
Z60168WE	168 x 60 x 30	673.05	42.5	N/A	\$12598	N/A	\$2396

Wedge table includes three bases with wire access doors on each side of base and wire concealment runners between bases. Wedge tapers from 60"W to 48"W. Shipped easy to assemble in 5 cartons.

Required specifications

Top finish
Top thickness/edge detail
Base finish
Base trim finish

Optional specifications

HP laminate
Cut-out for power block

Accessories

Power block

BOARDROOM TABLES **MODEL #** **DIMENSIONS** **WT/LB.** **CUBIC FT.** **1" TOP** **1.5" TOP** **GLAZE ADD** **HP ADD**

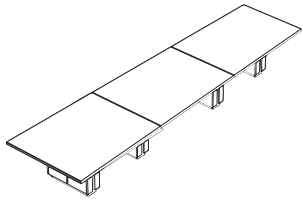

Boardroom Table - Wedge

W x D x H (1.5" TOP)

Z60192WE	192 x 60 x 30	824.25	63.75	N/A	\$15850	N/A	\$2739
Z60216WE	216 x 60 x 30	884.1	68.25	N/A	\$16734	N/A	\$3081
Z60240WE	240 x 60 x 30	948.15	73	N/A	\$17456	N/A	\$3422
Z60264WE	264 x 60 x 30	1006.95	77.5	N/A	\$18148	N/A	\$3763
Z60288WE	288 x 60 x 30	1065.75	82	N/A	\$19260	N/A	\$4106

Wedge table includes four bases with wire access doors on each side of base and wire concealment runners between bases. Wedge tapers from 60"W to 48"W. Shipped easy to assemble in 7 cartons.

MEDIA TABLES

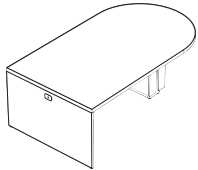

Media Table - D Island

Z4860DMIL	60 x 48 x 30	267	17.75	N/A	\$4492	N/A	\$686
Z4872DMIL	72 x 48 x 30	298.2	19.75	N/A	\$4813	N/A	\$821
Z4884DMIL	84 x 48 x 30	326.55	21.5	N/A	\$5122	N/A	\$958
Z4896DMIL	96 x 48 x 30	347.55	23.5	N/A	\$5427	N/A	\$1096

D media island table includes one base with wire access doors on each side of base and wire concealment runners between the base and the end panel. Grommet centered at the top of the end panel for wire pass through. Shipped easy to assemble in 3 cartons.

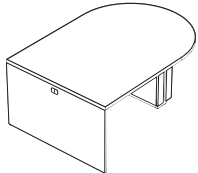

Media Table - D Island

Z6060DMIL	60 x 60 x 30	323.92	23.25	N/A	\$5383	N/A	\$857
Z6072DMIL	72 x 60 x 30	359.1	25.75	N/A	\$5760	N/A	\$1027
Z6084DMIL	84 x 60 x 30	397.95	28	N/A	\$6151	N/A	\$1200
Z6096DMIL	96 x 60 x 30	433.65	30.5	N/A	\$6512	N/A	\$1368

D media island table includes one base with wire access doors on each side of base and wire concealment runners between the base and the end panel. Grommet centered at the top of the end panel for wire pass through. Shipped easy to assemble in 3 cartons.

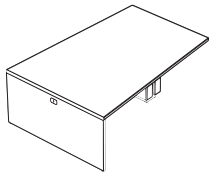

Media Table - Wedge

Z6060WMIL	60 x 60 x 30	306.6	20.75	N/A	\$5383	N/A	\$857
Z6072WMIL	72 x 60 x 30	338.1	23	N/A	\$5760	N/A	\$1027
Z6084WMIL	84 x 60 x 30	374.85	25.5	N/A	\$6151	N/A	\$1200
Z6096WMIL	96 x 60 x 30	407.4	28	N/A	\$6512	N/A	\$1368

Wedge media island table includes one base with wire access doors on each side of base and wire concealment runners between the base and the end panel. Grommet centered at the top of the end panel for wire pass through. Wedge tapers from 60"W to 48"W. Shipped easy to assemble in 3 cartons.

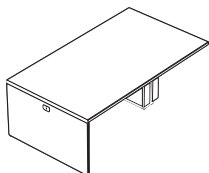

Media Table - Rectangular Island

Z4860RMIL	60 x 48 x 30	279.3	17.75	N/A	\$4132	N/A	\$686
Z4872RMIL	72 x 48 x 30	307.65	19.75	N/A	\$4429	N/A	\$821
Z4884RMIL	84 x 48 x 30	337.05	21.5	N/A	\$4706	N/A	\$958
Z4896RMIL	96 x 48 x 30	357	23.5	N/A	\$4986	N/A	\$1096

Rectangular media island table includes one base with wire access doors on each side of base and wire concealment runners between the base and the end panel. Grommet centered at the top of the end panel for wire pass through. Shipped easy to assemble in 3 cartons.

Required specifications

- Top finish
- Top thickness/edge detail
- Base finish
- Base trim finish

Optional specifications

- HP laminate
- Cut-out for power block

Accessories

- Power block

Z ZIRA™ BOARDROOM

MEDIA TABLES	MODEL #	DIMENSIONS	WT/LB.	CUBIC FT.	1" TOP	1.5" TOP	GLAZE ADD	HP ADD
--------------	---------	------------	--------	-----------	--------	----------	-----------	--------

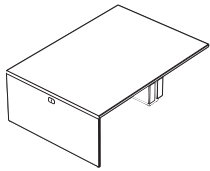

Media Table - Rectangular Island

	W x D x H (1.5" TOP)							
Z6060RMIL	60 x 60 x 30	339.15	23.25	N/A	\$4946	N/A	\$857	
Z6072RMIL	72 x 60 x 30	373.8	25.75	N/A	\$5290	N/A	\$1027	
Z6084RMIL	84 x 60 x 30	414.75	28	N/A	\$5643	N/A	\$1200	
Z6096RMIL	96 x 60 x 30	449.4	30.5	N/A	\$5971	N/A	\$1368	

Rectangular media island table includes one base with wire access doors on each side of base and wire concealment runners between the base and the end panel. Grommet centered at the top of the end panel for wire pass through. Shipped easy to assemble in 3 cartons.

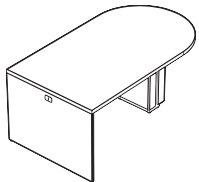

Media Table - D Island, 36.5"H

Z4860DMIM	60 x 48 x 36.5	291.9	19.25	N/A	\$4904	N/A	\$686	
Z4872DMIM	72 x 48 x 36.5	321.3	21.25	N/A	\$5232	N/A	\$821	
Z4884DMIM	84 x 48 x 36.5	349.65	23	N/A	\$5541	N/A	\$958	
Z4896DMIM	96 x 48 x 36.5	370.65	25	N/A	\$5843	N/A	\$1096	

D media island table includes one base with wire access doors on each side of base and wire concealment runners between the base and the end panel. Grommet centered at the top of the end panel for wire pass through. Shipped easy to assemble in 3 cartons.

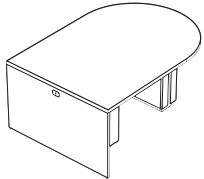

Media Table - D Island, 36.5"H

Z6060DMIM	60 x 60 x 36.5	352.27	25.5	N/A	\$5797	N/A	\$857	
Z6072DMIM	72 x 60 x 36.5	386.4	27.75	N/A	\$6174	N/A	\$1027	
Z6084DMIM	84 x 60 x 36.5	426.3	30.25	N/A	\$6565	N/A	\$1200	
Z6096DMIM	96 x 60 x 36.5	462	32.75	N/A	\$6923	N/A	\$1368	

D media island table includes one base with wire access doors on each side of base and wire concealment runners between the base and the end panel. Grommet centered at the top of the end panel for wire pass through. Shipped easy to assemble in 3 cartons.

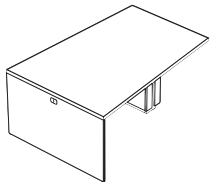

Media Table - Wedge, 36.5"H

Z6060WMIM	60 x 60 x 36.5	331.8	22.25	N/A	\$5797	N/A	\$857	
Z6072WMIM	72 x 60 x 36.5	364.35	24.75	N/A	\$6174	N/A	\$1027	
Z6084WMIM	84 x 60 x 36.5	424.2	27	N/A	\$6565	N/A	\$1200	
Z6096WMIM	96 x 60 x 36.5	432.6	29.5	N/A	\$6923	N/A	\$1368	

Wedge media island table includes one base with wire access doors on each side of base and wire concealment runners between the base and the end panel. Grommet centered at the top of the end panel for wire pass through. Wedge tapers from 60"W to 48"W. Shipped easy to assemble in 3 cartons.

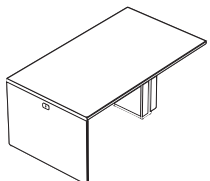

Media Table - Rectangular Island, 36.5"H

Z4860RMIM	60 x 48 x 36.5	301.35	19.25	N/A	\$4509	N/A	\$686	
Z4872RMIM	72 x 48 x 36.5	330.75	21.25	N/A	\$4807	N/A	\$821	
Z4884RMIM	84 x 48 x 36.5	360.15	23	N/A	\$5086	N/A	\$958	
Z4896RMIM	96 x 48 x 36.5	380.1	25	N/A	\$5364	N/A	\$1096	

Rectangular media island table includes one base with wire access doors on each side of base and wire concealment runners between the base and the end panel. Grommet centered at the top of the end panel for wire pass through. Shipped easy to assemble in 3 cartons.

Required specifications

Top finish
Top thickness/edge detail
Base finish
Base trim finish

Optional specifications

HP laminate
Cut-out for power block

Accessories

Power block

MEDIA TABLES	MODEL #	DIMENSIONS	WT/LB.	CUBIC FT.	1" TOP	1.5" TOP	GLAZE ADD	HP ADD
--------------	---------	------------	--------	-----------	--------	----------	-----------	--------

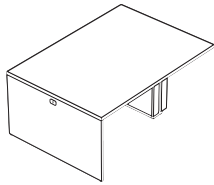

Media Table - Rectangular Island, 36.5" H

	W x D x H (1.5" TOP)							
Z6060RMIM	60 x 60 x 36.5	367.5	25.5	N/A	\$5320	N/A	\$857	
Z6072RMIM	72 x 60 x 36.5	402.15	27.75	N/A	\$5662	N/A	\$1027	
Z6084RMIM	84 x 60 x 36.5	442.05	30.25	N/A	\$6016	N/A	\$1200	
Z6096RMIM	96 x 60 x 36.5	477.75	32.75	N/A	\$6343	N/A	\$1368	

Rectangular media island table includes one base with wire access doors on each side of base and wire concealment runners between the base and the end panel. Grommet centered at the top of the end panel for wire pass through. Shipped easy to assemble in 3 cartons.

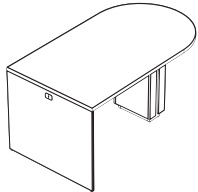

Media Table - D Island, 42.5" H

Z4860DMIH	60 x 48 x 42.5	312.9	20.75	N/A	\$5218	N/A	\$686	
Z4872DMIH	72 x 48 x 42.5	342.3	22.75	N/A	\$5546	N/A	\$821	
Z4884DMIH	84 x 48 x 42.5	371.7	24.5	N/A	\$5854	N/A	\$958	
Z4896DMIH	96 x 48 x 42.5	391.65	26.5	N/A	\$6156	N/A	\$1096	

D media island table includes one base with wire access doors on each side of base and wire concealment runners between the base and the end panel. Grommet centered at the top of the end panel for wire pass through. Shipped easy to assemble in 3 cartons.

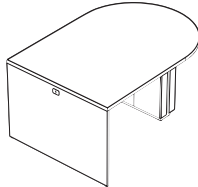

Media Table - D Island, 42.5" H

Z6060DMIH	60 x 60 x 42.5	378	27.5	N/A	\$6111	N/A	\$857	
Z6072DMIH	72 x 60 x 42.5	413.7	30	N/A	\$6487	N/A	\$1027	
Z6084DMIH	84 x 60 x 42.5	453.6	32.5	N/A	\$6878	N/A	\$1200	
Z6096DMIH	96 x 60 x 42.5	488.25	35	N/A	\$7238	N/A	\$1368	

D media island table includes one base with wire access doors on each side of base and wire concealment runners between the base and the end panel. Grommet centered at the top of the end panel for wire pass through. Shipped easy to assemble in 3 cartons.

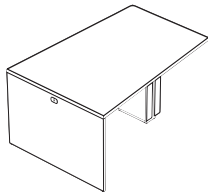

Media Table - Wedge, 42.5" H

Z6060WMIH	60 x 60 x 42.5	355	24	N/A	\$6111	N/A	\$857	
Z6072WMIH	72 x 60 x 42.5	387	26.25	N/A	\$6487	N/A	\$1027	
Z6084WMIH	84 x 60 x 42.5	424	28.75	N/A	\$6878	N/A	\$1200	
Z6096WMIH	96 x 60 x 42.5	457	31.25	N/A	\$7238	N/A	\$1368	

Wedge media island table includes one base with wire access doors on each side of base and wire concealment runners between the base and the end panel. Grommet centered at the top of the end panel for wire pass through. Wedge tapers from 60"W to 48"W. Shipped easy to assemble in 3 cartons.

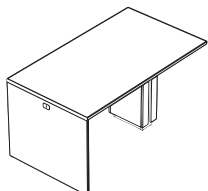

Media Table - Rectangular Island, 42.5" H

Z4860RMIH	60 x 48 x 42.5	324	20.75	N/A	\$4794	N/A	\$686	
Z4872RMIH	72 x 48 x 42.5	353	22.75	N/A	\$5091	N/A	\$821	
Z4884RMIH	84 x 48 x 42.5	382	24.5	N/A	\$5371	N/A	\$958	
Z4896RMIH	96 x 48 x 42.5	402	26.5	N/A	\$5651	N/A	\$1096	

Rectangular media island table includes one base with wire access doors on each side of base and wire concealment runners between the base and the end panel. Grommet centered at the top of the end panel for wire pass through. Shipped easy to assemble in 3 cartons.

Required specifications

- Top finish
- Top thickness/edge detail
- Base finish
- Base trim finish

Optional specifications

- HP laminate
- Cut-out for power block

Accessories

- Power block

Z ZIRA™ BOARDROOM

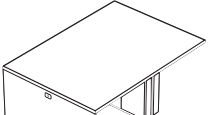
MEDIA TABLES	MODEL #	DIMENSIONS	WT/LB.	CUBIC FT.	1" TOP	1.5" TOP	GLAZE ADD	HP ADD
	W x D x H (1.5" TOP)							
	Z6060RMIH	60 x 60 x 42.5	394	27.5	N/A	\$5605	N/A	\$857
	Z6072RMIH	72 x 60 x 42.5	429	30	N/A	\$5947	N/A	\$1027
	Z6084RMIH	84 x 60 x 42.5	469	32.5	N/A	\$6301	N/A	\$1200
	Z6096RMIH	96 x 60 x 42.5	504	35	N/A	\$6629	N/A	\$1368

Media Table - Rectangular Island, 42.5"H

Rectangular media island table includes one base with wire access doors on each side of base and wire concealment runners between the base and the end panel. Grommet centered at the top of the end panel for wire pass through. Shipped easy to assemble in 3 cartons.

METAL BASE COVERS FOR MEDIA TABLES LIST PRICE

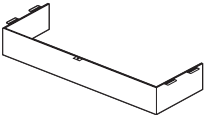
	Z48BEC	22.5 x 12.2 x 4.3	5	1.5	\$513
	Z60BEC	34.5 x 12.2 x 4.3	6	2	\$561

Metal Base Cover for Media Tables

For use on Zira media tables. Can also be used on any Zira boardroom table of corresponding width. Acts as a cap at the upper part of a base to hide any wire or power block that may be visible to users. Available in Black or Silver finish. Shipped easy to assemble in 1 carton.

COLLABORATIVE TABLES

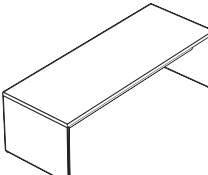
	W x D x H (1.5" TOP)							
		Z367229BT						
Z368429BT		84 x 36 x 30	263	14.75	N/A	\$2583	N/A	\$719
Z369629BT		96 x 36 x 30	289	16.5	N/A	\$2792	N/A	\$821

Collaborative Table, 30"H

Collaborative table with full end panels. Wire management runners span the length of the table between end panels. Shipped easy to assemble in 3 cartons.

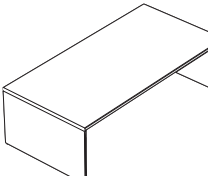
	Z487229BT	72 x 48 x 30	302	14	N/A	\$2783	N/A	\$821
	Z488429BT	84 x 48 x 30	335	15.75	N/A	\$2996	N/A	\$958
	Z489629BT	96 x 48 x 30	360	17.5	N/A	\$3246	N/A	\$1096

Collaborative Table, 30"H

Collaborative table with full end panels. Wire management runners span the length of the table between end panels. Shipped easy to assemble in 3 cartons.

	Z367236BT	72 x 36 x 36.5	249	13.25	N/A	\$2299	N/A	\$615
	Z368436BT	84 x 36 x 36.5	275	15	N/A	\$2664	N/A	\$719
	Z369636BT	96 x 36 x 36.5	301	16.75	N/A	\$2881	N/A	\$821

Collaborative Table, 36.5"H

Collaborative table with full end panels. Wire management runners span the length of the table between end panels. Shipped easy to assemble in 3 cartons.

Required specifications

Top finish
Top thickness/edge detail
Base finish
Base trim finish

Optional specifications

HP laminate
Cut-out for power block

Accessories

Power block

COLLABORATIVE TABLES **MODEL #** **DIMENSIONS** **WT/LB.** **CUBIC FT.** **1" TOP** **1.5" TOP** **GLAZE ADD** **HP ADD**

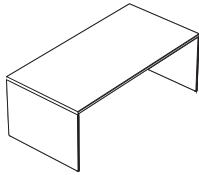

Collaborative Table, 36.5" H

	W x D x H (1.5" TOP)							
Z487236BT	72 x 48 x 36.5	319	14.5	N/A	\$2893	N/A	\$821	
Z488436BT	84 x 48 x 36.5	351	16.25	N/A	\$3106	N/A	\$958	
Z489636BT	96 x 48 x 36.5	376	18	N/A	\$3357	N/A	\$1096	

Collaborative table with full end panels. Wire management runners span the length of the table between end panels. Shipped easy to assemble in 3 cartons.

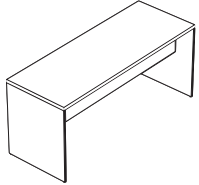

Collaborative Table, 42.5" H

Z367242BT	72 x 36 x 42.5	283	14.25	N/A	\$2572	N/A	\$615	
Z368442BT	84 x 36 x 42.5	312	16	N/A	\$2967	N/A	\$719	
Z369642BT	96 x 36 x 42.5	342	18	N/A	\$3213	N/A	\$821	

Collaborative table with full end panels. Wire management runners span the length of the table between end panels. Shipped easy to assemble in 3 cartons.

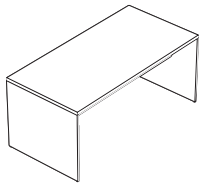

Collaborative Table, 42.5" H

Z487242BT	72 x 48 x 42.5	356	15.5	N/A	\$3189	N/A	\$821	
Z488442BT	84 x 48 x 42.5	392	17.5	N/A	\$3434	N/A	\$958	
Z489642BT	96 x 48 x 42.5	421	19.25	N/A	\$3711	N/A	\$1096	

Collaborative table with full end panels. Wire management runners span the length of the table between end panels. Shipped easy to assemble in 3 cartons.

AUDIOVISUAL

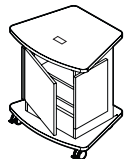

Multimedia Cart*

Z2822MCE	28 x 22.25 x 29.5	86	13.5	\$845	\$908	N/A	\$174	
----------	-------------------	----	------	--------------	--------------	-----	--------------	--

Multimedia cart features one non-locking hinged door on the back. Includes three fixed shelves, one grommet on top and one grommet in bottom panel for wire pass-through. Four locking casters included. Shipped assembled in 1 carton.

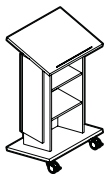

Lectern*

Z2444LEC	24 x 18 x 44.3	100	17	\$820	\$868	N/A	\$174	
----------	----------------	-----	----	--------------	--------------	-----	--------------	--

Features angled stand and storage with two fixed shelves. Two locking casters included. Shipped assembled in 1 carton.

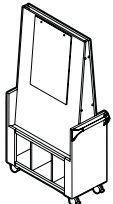

Visual Board**

Z361872VB	36 x 18 x 72.4	187	26.5	\$2698	N/A	N/A	N/A	
-----------	----------------	-----	------	---------------	-----	-----	-----	--

Angled visual board with paper pad on one side and dry erase board on the opposite side. Unique push handles are standard. Locking casters included. Decorative aluminum trim is standard on the lip of each shelf. Height aligns with 36" buffets. Shipped easy to assemble in 2 cartons.

- Wall mounted visual boards are available on page 47.

Required specifications

Top finish (not Z361872VB)
Top thickness/edge detail*
Base finish
Base trim finish

Optional specifications

HP laminate
Cut-out for power block (collaborative tables only)

Accessories

Power block (collaborative tables only)

Push bar finish**

Z ZIRA™ BOARDROOM

ACCESSORIES	MODEL #	DIMENSIONS	WT/LB.	CUBIC FT.	1" TOP	1.5" TOP	GLAZE ADD	HP ADD
		W x D x H						
<p>Serving Cart with Doors*</p> <p>Cart features two doors with lock and one fixed height adjustable shelf. Top is recessed within side and end panels to act as a tray. Unique push handles are standard on both sides of the cart. Four locking casters included. Please specify handles. Shipped assembled in 1 carton.</p>	Z361836KD	36 x 18 x 36	150	20	\$1718	N/A	\$438	N/A
	Z361829KD	36 x 18 x 29	113	16	\$1455	N/A	\$366	N/A
<p>Serving Cart</p> <p>Cart features one fixed height adjustable shelf. Top is recessed within side and end panels to act as a tray. Decorative aluminum trim is standard on the lip of each shelf. Unique push handles are standard on both sides of the cart. Four locking casters included. Shipped assembled in 1 carton.</p>	Z361836KO	36 x 18 x 36	121	20	\$1865	N/A	N/A	N/A
	Z361829KO	36 x 18 x 29	108	16	\$1561	N/A	N/A	N/A
<p>Buffet Cart</p> <p>Cart features one fixed shelf. Top is recessed within side and end panels to act as a tray. Unique push handles are standard. Decorative aluminum trim is standard on the lip of each shelf. Locking casters included. Height aligns with 36" buffets. Shipped assembled in 1 carton.</p>	Z261836BK	26 x 18 x 36	79	14.9	\$1771	N/A	N/A	\$174
<p>Buffet</p> <p>Buffet features one fixed height adjustable shelf. Top is recessed within side and end panels to act as a tray. Decorative aluminum trim is standard on the lip of each shelf. Shipped assembled in 1 carton.</p>	Z481836BO	48 x 18 x 36	152.5	22.5	\$1641	N/A	N/A	\$234
	Z481829BO	48 x 18 x 29	135	18	\$1514	N/A	N/A	\$234
	Z361836BO	36 x 18 x 36	126	18	\$1352	N/A	N/A	\$174
	Z361829BO	36 x 18 x 29	112	14	\$1244	N/A	N/A	\$174
<p>Buffet with Doors*</p> <p>Buffet features two doors with lock and one fixed height adjustable shelf. Top is recessed within side and end panels to act as a tray. Shipped assembled in 1 carton.</p>	Z481836BD	48 x 18 x 36	171	22.5	\$1709	N/A	\$382	\$234
	Z481829BD	48 x 18 x 29	148	18	\$1524	N/A	\$439	\$234
	Z361836BD	36 x 18 x 36	138.5	18	\$1517	N/A	\$438	\$174
	Z361829BD	36 x 18 x 29	119	14	\$1278	N/A	\$366	\$174
<p>Buffet with Doors*</p> <p>Buffet features two drawers and two doors with lock. One fixed height adjustable shelf. Shipped assembled in 1 carton.</p>	Z482036BD	48 x 20 x 36	199	24.7	\$2494	\$2636	\$1098	\$477

Required specifications

Top finish
 Top/edge detail (only Z482036BD)
 Push bar finish (only ZxxxxxKD/KO/BK)
 Aluminum trim finish (only ZxxxxxBO/BU)

Base finish
 Handles*

Optional specifications

HP laminate
 Glazed door*
 Key #*

ACCESSORIES **MODEL #** **DIMENSIONS** **WT/LB.** **CUBIC FT.** **1" TOP** **1.5" TOP** **GLAZE ADD** **HP ADD**

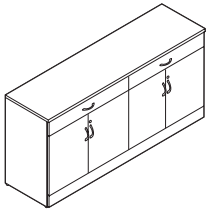

Buffet with Doors*

	W x D x H							
Z602036BD	60 x 20 x 36	228	30.75	\$3159	\$3354	\$2193	\$759	
Z722036BD	72 x 20 x 36	265	36.5	\$3632	\$3827	\$2193	\$759	

Buffet features two drawers and four doors with lock. Two fixed height adjustable shelves. Shipped assembled in 1 carton.

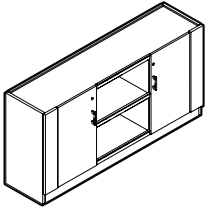

Buffet with Doors

Z721836BU	72 x 18 x 36	242	33.5	\$2527	N/A	\$529	\$351	
Z721829BU	72 x 18 x 29	211	27	\$2283	N/A	\$438	\$351	
Z601836BU	60 x 18 x 36	188	28	\$2272	N/A	\$438	\$293	
Z601829BU	60 x 18 x 29	163	22.5	\$2079	N/A	\$366	\$293	

Buffet features three separate compartments. The two outer compartments come standard with locking doors and each features one fixed height adjustable shelf. The center compartment is open with one fixed height adjustable shelf. Decorative aluminum trim is standard on the lip of the open shelf. Top is recessed within side and end panels to act as a tray. Shipped assembled in 1 carton.

Required specifications

- Top finish
- Top/edge detail*
- Base finish
- Handles

Optional specifications

- HP laminate
- Glazed door
- Key #

RECEPTION DESKS AND RETURNS

- Offered with **straight** and **bow** front transaction tops.
- **Transaction tops** available in 1" or 1.5" thick top with a variety of edge details.
- **Worksurface** available in 1" thickness with A3 edge only.
- Widths and depths listed are outside dimensions including transaction top overhang front and sides or outside surrounds modesty panels and gables. Model numbers reflect primary worksurface dimensions.

TOP AND BASE FINISHES

ACJ Absolute Acajou	FCL First Class
ASN Asian Night	NBL Noce Biondo
AWC Avant Cherry	NGL Noce Grigio
AWH Avant Honey	NEL Noce Leggero
BLK Black	NML Noce Medio
BZD Blizzard	QTM Quartered Mahogany
BRC Brushed Cobalt	SBY Sheer Beauty
CMB Clear Maple	SDT Stonedust
CGY Custom Grey	SOG Storm Grey
DES Dark Espresso	WHE Walnut Heights
DWT Designer White	WHC White Chocolate
FAS Fashionista	WCR Winter Cherry

RECEPTION DESKS

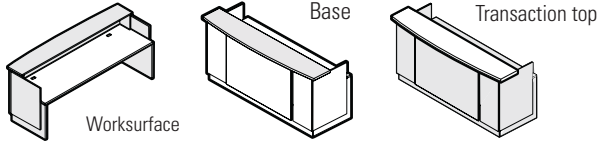

RECEPTION RETURNS

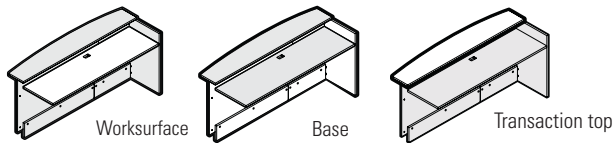

TRANSACTION TOP THICKNESS/EDGE DETAIL



A3 1" top, standard flat edge



AR 1" top, bicut edge



C3 1.5" top, standard flat edge



CR 1.5" top, bicut edge



CF 1.5" top, fluted edge

GLAZING (Center Panels)



Z1 frosted glazing, Tungsten (TUN) frame



Z2 frosted glazing, Black (BLK) frame



Z3 ribbed glazing, Tungsten (TUN) frame



Z4 ribbed glazing, Black (BLK) frame

GROMMETS

- Two grommets are standard in position **FOG1** and **FOG3**.
- Standard grommets can be removed at an upcharge.
- Optional grommets available in **FOG2**.

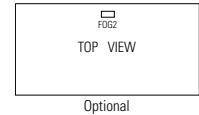
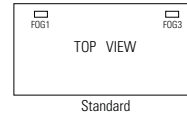
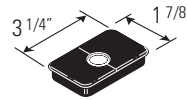

- Grommet hole dimensions are 3.25"W x 1.875"D.

POWER BLOCK

- A power block (model **PMSPDM**) may be ordered on transaction tops.
- A power block is a rectangular worksurface power/data module with one electrical duplex receptacle and two data (RJ45) receptacles. 9 foot Black cord included. Power block dimensions are 6.5"W x 3.5"D x 2.75"H.
- To purchase a power block, you must specify both the power block cut-out location and the power block model #. Order power block as **PMSPDM**. Add \$268. Power blocks are available in standard worksurface locations (left, center or right). Order as **E1, E2** or **E3**. Add \$91.



Power block **PMSPDM**. Add \$268.

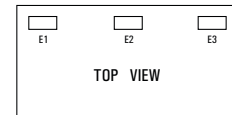

Specify location **E1, E2** or **E3**. Add \$91.

TASK LIGHT

- Illuminates worksurface and optional glazed center panel.
- Specify LED task light separately. Use PLED50 for 60", 66" and 72" wide reception units. Use PLED50 or PLED100 for 84" and 96" wide units. See page 466 for details.

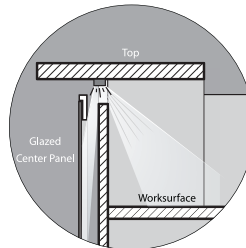

RECEPTION RETURNS - PIGEON

- Available in all laminates.
- Worksurface available in 1" thickness with A3 edge only.
- Collator shelves offered in Black (**BLK**) or Brushed Cobalt (**BRC**).
- One grommet is standard in position **FOG3**.
- Standard grommet can be removed at an upcharge.
- Optional grommet available in position **FOG2**, see upcharges above.
- Power blocks are available in positions **E2** and **E3**.



Worksurface

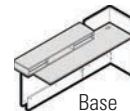

Base

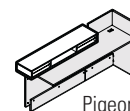

Pigeon

RECEPTION RETURNS - BOOKCASE

- Available in all laminates listed above.
- Worksurface available in 1" thickness with A3 edge only.
- One grommet is standard in position **FOG2**.
- Standard grommet can be removed at an upcharge.
- Optional grommet available in position **FOG3** for **54", 60" and 72" wide units only**.
- Power blocks are available in positions **E2** and **E3** for **54", 60" and 72" wide units only**.

RECEPTION DESKS	MODEL #	DIMENSIONS	WT/LB.	CUBIC FT.	1" TOP	1.5" TOP	GLAZE ADD	HP ADD
		W x D x H (1.5" TOP)						
	Z3096RDS	96 x 35.5 x 43.3	415	23.25	\$3270	\$3445	\$668	\$818
	Z3084RDS	89.4 x 35.5 x 43.3	368	20.5	\$2907	\$3063	\$575	\$717
	Z3072RDS	77.4 x 35.5 x 43.3	331	18	\$2680	\$2815	\$483	\$613
	Z3066RDS	71.4 x 35.5 x 43.3	313	17	\$2541	\$2672	\$436	\$564
	Z3060RDS	65.4 x 35.5 x 43.3	295	16	\$2390	\$2545	\$387	\$513
	Z2496RDS	96 x 30 x 43.3	380	22	\$3083	\$3258	\$668	\$702
	Z2484RDS	89.4 x 30 x 43.3	338	19.5	\$2747	\$2903	\$575	\$613
	Z2472RDS	77.4 x 30 x 43.3	303	17	\$2528	\$2669	\$483	\$526
	Z2466RDS	71.4 x 30 x 43.3	287	16	\$2396	\$2527	\$436	\$484
	Z2460RDS	65.4 x 30 x 43.3	269	15	\$2283	\$2403	\$387	\$439

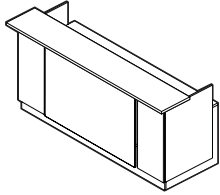

Reception Desk**

Z24xxRDS not freestanding, must be connected to a return. Z30xxRDS can be used as freestanding. Standard with two grommets. Accommodates shells of all depths. Shipped easy to assemble in 3 cartons.

	Z3096RDB	96 x 35.5 x 43.3	412	23.25	\$3270	\$3445	\$668	\$818
	Z3084RDB	89.4 x 35.5 x 43.3	365	20.5	\$2907	\$3063	\$575	\$717
	Z3072RDB	77.4 x 35.5 x 43.3	328	18	\$2680	\$2815	\$483	\$613
	Z3066RDB	71.4 x 35.5 x 43.3	310	17	\$2541	\$2672	\$436	\$564
	Z3060RDB	65.4 x 35.5 x 43.3	292	16	\$2390	\$2545	\$387	\$513
	Z2496RDB	96 x 30 x 43.3	377	22	\$3083	\$3258	\$668	\$702
	Z2484RDB	89.4 x 30 x 43.3	335	19.5	\$2747	\$2903	\$575	\$613
	Z2472RDB	77.4 x 30 x 43.3	300	17	\$2528	\$2669	\$483	\$526
	Z2466RDB	71.4 x 30 x 43.3	284	16	\$2396	\$2527	\$436	\$484
	Z2460RDB	65.4 x 30 x 43.3	266	15	\$2283	\$2403	\$387	\$439

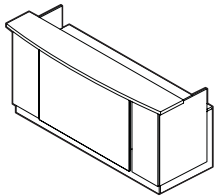

Reception Desk - Bow Front Trans. Top**

Z24xxRDB not freestanding, must be connected to a return. Z30xxRDB can be used as freestanding. Standard with two grommets. Accommodates shells of all depths. Shipped easy to assemble in 3 cartons.

HIGH RECEPTION RETURNS	MODEL #	DIMENSIONS	WT/LB.	CUBIC FT.	1" TOP	1.5" TOP	GLAZE ADD	HP ADD
		W x D x H						
	Z2472HRRRL	75.7 x 25 x 40.3	151	8.2	\$1220	N/A	N/A	\$351
	Z2460HRRRL	63.7 x 25 x 40.3	131.2	7	\$1065	N/A	N/A	\$293
	Z2454HRRRL	57.7 x 25 x 40.3	120.9	5.75	\$969	N/A	N/A	\$263
	Z2448HRRRL	51.7 x 25 x 40.3	110.9	5.25	\$899	N/A	N/A	\$234
	Z2442HRRRL	45.7 x 25 x 40.3	100.8	4.8	\$828	N/A	N/A	\$205
	Z2436HRRRL	39.7 x 25 x 40.3	90.7	4.3	\$757	N/A	N/A	\$174

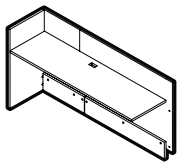

High Reception Return - LEFT

Not freestanding, must be connected to a reception desk. Grommet in worksurface. Accommodates shells of all depths. Connecting hardware included. Shipped easy to assemble in 1 carton.

	Z2072HRRRL	75.7 x 20.9 x 40.3	139	8.2	\$1078	N/A	N/A	\$293
	Z2060HRRRL	63.7 x 20.9 x 40.3	121	7	\$938	N/A	N/A	\$244
	Z2054HRRRL	57.7 x 20.9 x 40.3	111	5.75	\$846	N/A	N/A	\$220
	Z2048HRRRL	51.7 x 20.9 x 40.3	102	5.25	\$785	N/A	N/A	\$195
	Z2042HRRRL	45.7 x 20.9 x 40.3	92	4.8	\$721	N/A	N/A	\$171
	Z2036HRRRL	39.7 x 20.9 x 40.3	83	4.3	\$657	N/A	N/A	\$145

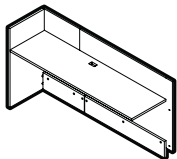

High Reception Return - LEFT

Not freestanding, must be connected to a reception desk. Grommet in worksurface. Accommodates shells of 20" depths. Connecting hardware included. Shipped easy to assemble in 1 carton.

Required specifications

- Top finish
- Transaction top thickness/edge detail**
- Base finish
- Transaction top finish**

Optional specifications

- HP laminate
- Additional grommet
- Glazed center panel**

Accessories

- Power block

Z ZIRA™ RECEPTION

HIGH RECEPTION RETURNS

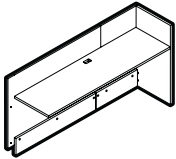

High Reception Return - RIGHT

MODEL #	DIMENSIONS W x D x H	WT/LB.	CUBIC FT.	1" TOP	1.5" TOP	GLAZE ADD	HP ADD
Z2472HRRR	75.7 x 25 x 40.3	151	8.2	\$1220	N/A	N/A	\$351
Z2460HRRR	63.7 x 25 x 40.3	131.2	7	\$1065	N/A	N/A	\$293
Z2454HRRR	57.7 x 25 x 40.3	120.9	5.75	\$969	N/A	N/A	\$263
Z2448HRRR	51.7 x 25 x 40.3	110.9	5.25	\$899	N/A	N/A	\$234
Z2442HRRR	45.7 x 25 x 40.3	100.8	4.8	\$828	N/A	N/A	\$205
Z2436HRRR	39.7 x 25 x 40.3	90.7	4.3	\$757	N/A	N/A	\$174

Not freestanding, must be connected to a reception desk. Grommet in worksurface. Accommodates shells of all depths. Connecting hardware included. Shipped easy to assemble in 1 carton.

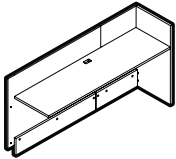

High Reception Return - RIGHT

Z2072HRRR	75.7 x 20.9 x 40.3	139	8.2	\$1078	N/A	N/A	\$293
Z2060HRRR	63.7 x 20.9 x 40.3	121	7	\$938	N/A	N/A	\$244
Z2054HRRR	57.7 x 20.9 x 40.3	111	5.75	\$846	N/A	N/A	\$220
Z2048HRRR	51.7 x 20.9 x 40.3	102	5.25	\$785	N/A	N/A	\$195
Z2042HRRR	45.7 x 20.9 x 40.3	92	4.8	\$721	N/A	N/A	\$171
Z2036HRRR	39.7 x 20.9 x 40.3	83	4.3	\$657	N/A	N/A	\$145

Not freestanding, must be connected to a reception desk. Grommet in worksurface. Accommodates shells of 20" depths. Connecting hardware included. Shipped easy to assemble in 1 carton.

LOW RECEPTION RETURNS

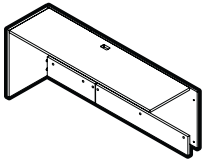

Low Reception Return - LEFT

Z2472LRRL	75.7 x 25 x 29.6	141	6.75	\$1187	N/A	N/A	\$351
Z2460LRRL	63.7 x 25 x 29.6	122	5.75	\$1022	N/A	N/A	\$293
Z2454LRRL	57.7 x 25 x 29.6	112.9	5.5	\$937	N/A	N/A	\$263
Z2448LRRL	51.7 x 25 x 29.6	103.4	5	\$870	N/A	N/A	\$234
Z2442LRRL	45.7 x 25 x 29.6	94	4.5	\$799	N/A	N/A	\$205
Z2436LRRL	39.7 x 25 x 29.6	84.3	4	\$726	N/A	N/A	\$174

Not freestanding, must be connected to a reception desk. Grommet in worksurface. Accommodates shells of all depths. Connecting hardware included. Shipped easy to assemble in 1 carton.

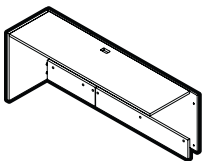

Low Reception Return - LEFT

Z2072LRRL	75.7 x 20.9 x 29.6	128.8	6.75	\$1045	N/A	N/A	\$293
Z2060LRRL	63.7 x 20.9 x 29.6	111.3	5.75	\$894	N/A	N/A	\$244
Z2054LRRL	57.7 x 20.9 x 29.6	102.8	5.5	\$817	N/A	N/A	\$220
Z2048LRRL	51.7 x 20.9 x 29.6	94.1	5	\$758	N/A	N/A	\$195
Z2042LRRL	45.7 x 20.9 x 29.6	85.3	4.5	\$693	N/A	N/A	\$171
Z2036LRRL	39.7 x 20.9 x 29.6	76.3	4	\$630	N/A	N/A	\$145

Not freestanding, must be connected to a reception desk. Grommet in worksurface. Accommodates shells of 20" depths. Connecting hardware included. Shipped easy to assemble in 1 carton.

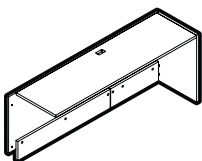

Low Reception Return - RIGHT

Z2472LRRR	75.7 x 25 x 29.6	141	6.75	\$1187	N/A	N/A	\$351
Z2460LRRR	63.7 x 25 x 29.6	122	5.75	\$1022	N/A	N/A	\$293
Z2454LRRR	57.7 x 25 x 29.6	112.9	5.5	\$937	N/A	N/A	\$263
Z2448LRRR	51.7 x 25 x 29.6	103.4	5	\$870	N/A	N/A	\$234
Z2442LRRR	45.7 x 25 x 29.6	94	4.5	\$799	N/A	N/A	\$205
Z2436LRRR	39.7 x 25 x 29.6	84.3	4	\$726	N/A	N/A	\$174

Not freestanding, must be connected to a reception desk. Grommet in worksurface. Accommodates shells of all depths. Connecting hardware included. Shipped easy to assemble in 1 carton.

Required specifications

Top finish
Base finish

Optional specifications

HP laminate
Additional grommet

Accessories

Power block

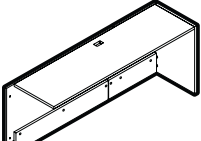
LOW RECEPTION RETURNS	MODEL #	DIMENSIONS	WT/LB.	CUBIC FT.	1" TOP	1.5" TOP	GLAZE ADD	HP ADD	
	W x D x H								
	Z2072LRRR	75.7 x 20.9 x 29.6	128.8	6.75	\$1045	N/A	N/A	\$293	
	Z2060LRRR	63.7 x 20.9 x 29.6	111.3	5.75	\$894	N/A	N/A	\$244	
	Z2054LRRR	57.7 x 20.9 x 29.6	102.8	5.5	\$817	N/A	N/A	\$220	
	Z2048LRRR	51.7 x 20.9 x 29.6	94.1	5	\$758	N/A	N/A	\$195	
	Z2042LRRR	45.7 x 20.9 x 29.6	85.3	4.5	\$693	N/A	N/A	\$171	
Z2036LRRR	39.7 x 20.9 x 29.6	76.3	4	\$630	N/A	N/A	\$145		

Low Reception Return - RIGHT

Not freestanding, must be connected to a reception desk. Grommet in worksurface. Accommodates shells of 20" depths. Connecting hardware included. Shipped easy to assemble in 1 carton.

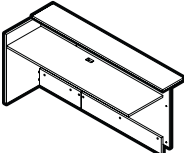
TRANSACTIONAL RETURNS	MODEL #	DIMENSIONS	WT/LB.	CUBIC FT.	1" TOP	1.5" TOP	GLAZE ADD	HP ADD	
	W x D x H (1.5" TOP)								
	Z2472TSRL	75.7 x 29.7 x 37.5	176	9.75	\$1455	\$1565	N/A	\$351	
	Z2460TSRL	63.7 x 29.7 x 37.5	152	8.75	\$1253	\$1344	N/A	\$293	
	Z2454TSRL	57.7 x 29.7 x 37.5	140	7.5	\$1139	\$1224	N/A	\$263	
	Z2448TSRL	51.7 x 29.7 x 37.5	127	7	\$1047	\$1125	N/A	\$234	
	Z2442TSRL	45.7 x 29.7 x 37.5	116	6.25	\$958	\$1024	N/A	\$205	
Z2436TSRL	39.7 x 29.7 x 37.5	103	5.5	\$871	\$930	N/A	\$174		

Transactional Return - LEFT*

Not freestanding, must be connected to a reception desk. Grommet in worksurface. Accommodates shells of all depths. Connecting hardware included. Shipped easy to assemble in 1 carton.

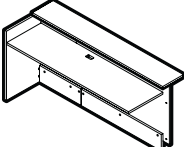
	Z2072TSRL	75.7 x 25.6 x 37.5	163	8.25	\$1305	\$1415	N/A	\$293
	Z2060TSRL	63.7 x 25.6 x 37.5	141	7.25	\$1121	\$1213	N/A	\$244
	Z2054TSRL	57.7 x 25.6 x 37.5	129	6.25	\$1015	\$1100	N/A	\$220
	Z2048TSRL	51.7 x 25.6 x 37.5	118	5.5	\$931	\$1009	N/A	\$195
	Z2042TSRL	45.7 x 25.6 x 37.5	106	5	\$848	\$914	N/A	\$171
	Z2036TSRL	39.7 x 25.6 x 37.5	95	4.4	\$769	\$828	N/A	\$145

Transactional Return - LEFT*

Not freestanding, must be connected to a reception desk. Grommet in worksurface. Accommodates shells of 20" depths. Connecting hardware included. Shipped easy to assemble in 1 carton.

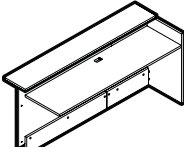
	Z2472TSRR	75.7 x 29.7 x 37.5	176	9.75	\$1455	\$1565	N/A	\$351
	Z2460TSRR	63.7 x 29.7 x 37.5	152	8.75	\$1253	\$1344	N/A	\$293
	Z2454TSRR	57.7 x 29.7 x 37.5	140	7.5	\$1139	\$1224	N/A	\$263
	Z2448TSRR	51.7 x 29.7 x 37.5	127	7	\$1047	\$1125	N/A	\$234
	Z2442TSRR	45.7 x 29.7 x 37.5	116	6.25	\$958	\$1024	N/A	\$205
	Z2436TSRR	39.7 x 29.7 x 37.5	103	5.5	\$871	\$930	N/A	\$174

Transactional Return - RIGHT*

Not freestanding, must be connected to a reception desk. Grommet in worksurface. Accommodates shells of all depths. Connecting hardware included. Shipped easy to assemble in 1 carton.

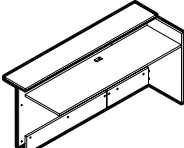
	Z2072TSRR	75.7 x 25.6 x 37.5	163	8.25	\$1305	\$1415	N/A	\$293
	Z2060TSRR	63.7 x 25.6 x 37.5	141	7.25	\$1121	\$1213	N/A	\$244
	Z2054TSRR	57.7 x 25.6 x 37.5	129	6.25	\$1015	\$1100	N/A	\$220
	Z2048TSRR	51.7 x 25.6 x 37.5	118	5.5	\$931	\$1009	N/A	\$195
	Z2042TSRR	45.7 x 25.6 x 37.5	106	5	\$848	\$914	N/A	\$171
	Z2036TSRR	39.7 x 25.6 x 37.5	95	4.4	\$769	\$828	N/A	\$145

Transactional Return - RIGHT*

Not freestanding, must be connected to a reception desk. Grommet in worksurface. Accommodates shells of 20" depths. Connecting hardware included. Shipped easy to assemble in 1 carton.

Required specifications

Top finish
Transaction top thickness/edge detail*
Base finish
Transaction top finish*

Optional specifications

HP laminate
Additional grommet

Accessories

Power block

Z ZIRA™ RECEPTION

TRANSACTIONAL RETURNS

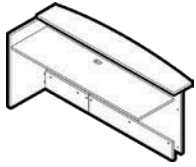

Transactional Return, Bow Front - LEFT**

MODEL #	DIMENSIONS W x D x H (1.5" TOP)	WT/LB.	CUBIC FT.	1" TOP	1.5" TOP	GLAZE ADD	HP ADD
Z2472TBRL	75.7 x 32.7 x 37.5	180.6	9.75	\$1455	\$1565	N/A	\$351
Z2460TBRL	63.7 x 32.7 x 37.5	155.7	8.5	\$1253	\$1344	N/A	\$293
Z2454TBRL	57.7 x 32.7 x 37.5	143.9	7.5	\$1139	\$1224	N/A	\$263
Z2448TBRL	51.7 x 32.7 x 37.5	130.7	7	\$1047	\$1125	N/A	\$234
Z2442TBRL	45.7 x 32.7 x 37.5	118.3	6.25	\$958	\$1024	N/A	\$205
Z2436TBRL	39.7 x 32.7 x 37.5	104.9	5.5	\$871	\$930	N/A	\$174

Not freestanding, must be connected to a reception desk. Grommet in worksurface. Accommodates shells of all depths. Connecting hardware included. Shipped easy to assemble in 1 carton.

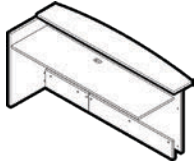

Transactional Return, Bow Front - LEFT**

Z2072TBRL	75.7 x 28.6 x 37.5	168	8.25	\$1305	\$1415	N/A	\$293
Z2060TBRL	63.7 x 28.6 x 37.5	144.6	7.5	\$1121	\$1213	N/A	\$244
Z2054TBRL	57.7 x 28.6 x 37.5	133.5	6.5	\$1015	\$1100	N/A	\$220
Z2048TBRL	51.7 x 28.6 x 37.5	121	6	\$931	\$1009	N/A	\$195
Z2042TBRL	45.7 x 28.6 x 37.5	109.3	5.25	\$848	\$914	N/A	\$171
Z2036TBRL	39.7 x 28.6 x 37.5	96.6	4.7	\$769	\$828	N/A	\$145

Not freestanding, must be connected to a reception desk. Grommet in worksurface. Accommodates shells of 20" depths. Connecting hardware included. Shipped easy to assemble in 1 carton.

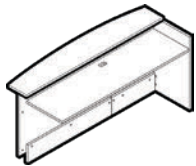

Transactional Return, Bow Front - RIGHT**

Z2472TBRR	75.7 x 32.7 x 37.5	180.6	9.75	\$1455	\$1565	N/A	\$351
Z2460TBRR	63.7 x 32.7 x 37.5	155.7	8.5	\$1253	\$1344	N/A	\$293
Z2454TBRR	57.7 x 32.7 x 37.5	143.9	7.5	\$1139	\$1224	N/A	\$263
Z2448TBRR	51.7 x 32.7 x 37.5	130.7	7	\$1047	\$1125	N/A	\$234
Z2442TBRR	45.7 x 32.7 x 37.5	118.3	6.25	\$958	\$1024	N/A	\$205
Z2436TBRR	39.7 x 32.7 x 37.5	104.9	5.5	\$871	\$930	N/A	\$174

Not freestanding, must be connected to a reception desk. Grommet in worksurface. Accommodates shells of all depths. Connecting hardware included. Shipped easy to assemble in 1 carton.

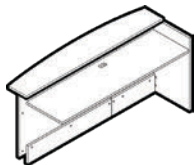

Transactional Return, Bow Front - RIGHT**

Z2072TBRR	75.7 x 28.6 x 37.5	168	8.25	\$1305	\$1415	N/A	\$293
Z2060TBRR	63.7 x 28.6 x 37.5	144.6	7.5	\$1121	\$1213	N/A	\$244
Z2054TBRR	57.7 x 28.6 x 37.5	133.5	6.5	\$1015	\$1100	N/A	\$220
Z2048TBRR	51.7 x 28.6 x 37.5	121	6	\$931	\$1009	N/A	\$195
Z2042TBRR	45.7 x 28.6 x 37.5	109.3	5.25	\$848	\$914	N/A	\$171
Z2036TBRR	39.7 x 28.6 x 37.5	96.6	4.7	\$769	\$828	N/A	\$145

Not freestanding, must be connected to a reception desk. Grommet in worksurface. Accommodates shells of 20" depths. Connecting hardware included. Shipped easy to assemble in 1 carton.

PIGEON RECEPTION RETURNS

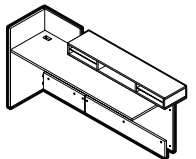

Pigeon Reception Return - LEFT**

MODEL #	DIMENSIONS W x D x H	WT/LB.	CUBIC FT.	1" TOP	1.5" TOP	GLAZE ADD	HP ADD
Z2472PRRL	75.7 x 31 x 40.3	171.3	9.75	\$1646	N/A	N/A	\$351
Z2460PRRL	63.7 x 31 x 40.3	149	8.25	\$1447	N/A	N/A	\$293
Z2454PRRL	57.7 x 31 x 40.3	136.4	7.5	\$1344	N/A	N/A	\$263

Not freestanding, must be connected to a reception desk. Grommet in worksurface. Accommodates shells of all depths. Connecting hardware included. Shipped easy to assemble in 1 carton.

Required specifications

Top finish
Trans. top thickness/edge**
Base finish
Trans. top** or pigeon hole finish*

Optional specifications

HP laminate
Additional grommet

Accessories

Power block

PIGEON RECEPTION RETURNS **MODEL #** **DIMENSIONS** **WT/LB.** **CUBIC FT.** **1" TOP** **1.5" TOP** **GLAZE ADD** **HP ADD**

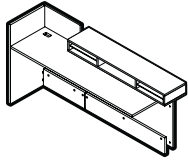

Pigeon Reception Return - LEFT**

	W x D x H							
Z2072PRRL	75.7 x 26.9 x 40.3	159	9.75	\$1503	N/A	N/A	\$293	
Z2060PRRL	63.7 x 26.9 x 40.3	138.2	8.25	\$1317	N/A	N/A	\$244	
Z2054PRRL	57.7 x 26.9 x 40.3	126.2	7.5	\$1222	N/A	N/A	\$220	

Not freestanding, must be connected to a reception desk. Grommet in worksurface. Accommodates shells of 20" depths. Connecting hardware included. Shipped easy to assemble in 1 carton.

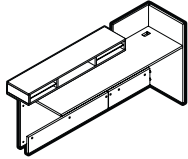

Pigeon Reception Return - RIGHT**

Z2472PRRR	75.7 x 31 x 40.3	171.3	9.75	\$1646	N/A	N/A	\$351
Z2460PRRR	63.7 x 31 x 40.3	149	8.25	\$1447	N/A	N/A	\$293
Z2454PRRR	57.7 x 31 x 40.3	136.4	7.5	\$1344	N/A	N/A	\$263

Not freestanding, must be connected to a reception desk. Grommet in worksurface. Accommodates shells of all depths. Connecting hardware included. Shipped easy to assemble in 1 carton.

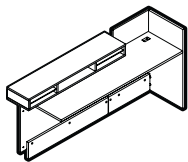

Pigeon Reception Return - RIGHT**

Z2072PRRR	75.7 x 26.9 x 40.3	159	9.75	\$1503	N/A	N/A	\$293
Z2060PRRR	63.7 x 26.9 x 40.3	138.2	8.25	\$1317	N/A	N/A	\$244
Z2054PRRR	57.7 x 26.9 x 40.3	126.2	7.5	\$1222	N/A	N/A	\$220

Not freestanding, must be connected to a reception desk. Grommet in worksurface. Accommodates shells of 20" depths. Connecting hardware included. Shipped easy to assemble in 1 carton.

BOOKCASE RECEPTION RETURNS

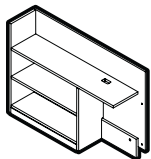

Bookcase Reception Return - LEFT

Z1272BRRL	75.7 x 13.7 x 40.3	158	7.5	\$1316	N/A	N/A	\$174
Z1260BRRL	63.7 x 13.7 x 40.3	139	6.25	\$1163	N/A	N/A	\$145

Not freestanding, must be connected to a reception desk. Grommet in worksurface. Accommodates shells of all depths. Connecting hardware included. Shipped easy to assemble in 1 carton.

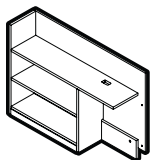

Bookcase Reception Return - LEFT

Z1254BRRL	57.7 x 13.7 x 40.3	131	5.75	\$1078	N/A	N/A	\$132
Z1248BRRL	51.7 x 13.7 x 40.3	114	5.25	\$956	N/A	N/A	\$117
Z1242BRRL	45.7 x 13.7 x 40.3	106	4.6	\$900	N/A	N/A	\$105
Z1236BRRL	39.7 x 13.7 x 40.3	98	4.1	\$844	N/A	N/A	\$88

Not freestanding, must be connected to a reception desk. Grommet in worksurface. Accommodates shells of all depths. Connecting hardware included. Shipped easy to assemble in 1 carton.

Required specifications

- Top finish
- Base finish
- Pigeon hole finish**
- Collator finish**

Optional specifications

- HP laminate
- Additional grommet

Accessories

- Power block

Z ZIRA™ RECEPTION

BOOKCASE RECEPTION RETURNS

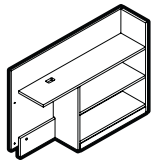

Bookcase Reception Return - RIGHT*

MODEL #	DIMENSIONS W x D x H	WT/LB.	CUBIC FT.	1" TOP	1.5" TOP	GLAZE ADD	HP ADD
Z1272BRRR	75.7 x 13.7 x 40.3	158	7.5	\$1316	N/A	N/A	\$174
Z1260BRRR	63.7 x 13.7 x 40.3	139	6.25	\$1163	N/A	N/A	\$145

Not freestanding, must be connected to a reception desk. Grommet in worksurface. Accommodates shells of all depths. Connecting hardware included. Shipped easy to assemble in 1 carton.

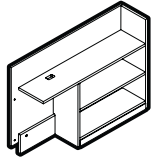

Bookcase Reception Return - RIGHT*

Z1254BRRR	57.7 x 13.7 x 40.3	131	5.75	\$1078	N/A	N/A	\$132
Z1248BRRR	51.7 x 13.7 x 40.3	114	5.25	\$956	N/A	N/A	\$117
Z1242BRRR	45.7 x 13.7 x 40.3	106	4.6	\$900	N/A	N/A	\$105
Z1236BRRR	39.7 x 13.7 x 40.3	98	4.1	\$844	N/A	N/A	\$88

Not freestanding, must be connected to a reception desk. Grommet in worksurface. Accommodates shells of all depths. Connecting hardware included. Shipped easy to assemble in 1 carton.

RECEPTION DESK VERTICAL STORAGE

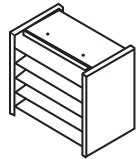

Reception Desk - Vertical Storage**

ZRDVS13	13.4 x 8.6 x 12.2	12.5	0.8	\$212	N/A	N/A	N/A
---------	-------------------	------	-----	--------------	-----	-----	-----

Collator shelves. Shipped assembled in 1 carton.

Required specifications

Top finish*
Base finish*
Collator finish**

Optional specifications

HP laminate*
Additional grommet*

Accessories

Power block*

panels and components



Divide

290





Divide is a modular desk mounted panel system that can be retro-installed on many Global desks. The panels can be vertically stacked to provide varying degrees of privacy. The panels are available in laminate or fabric tackboards as well as glazed panels that allow light to pass through. Divide's off-desk accessories help to organize paperwork and free up the workspace. Divide is offered in many laminate and fabric color options to complement any office environment.



Features and Benefits

- Available as fabric, glazed or laminate partitioning panels in an array of heights and widths.
- Easy to specify: choose the desired panel height and width and its corresponding height divide post(s).
- A built-in paper management rail (on fabric and glazed panels) is designed to accommodate off-desk accessories for workspace organization.
- Laminate panels offer an optional wire access cut-out at the bottom of each panel (order as SCP2).
- Laminate transaction tops are offered in various shapes and sizes, and are standard as either 1" thick or 1.5" thick to match.
- All Adaptabilities, Zira and Genoa laminate colors are offered as well as a wide variety of fabrics.

GENERAL INFORMATION

- Divide is a desk mounted panel system that can be field installed at any time on many Global desks.
- Vertical stacking of varying heights provide semi-private to private work areas.
- Designed for use on the Adaptabilities, Genoa and Zira laminate desk series, and may be retrofitted onto non-Global square edged product if necessary.
- Panels are available in 12", 18", 24" and 36" heights and can be stacked to produce heights of 24", 30", 36" and 42" for a virtually limitless variety of configurations.
- Progressive, desk mounted partition system consisting of three major categories:
 - Divide posts - to support the partitions.
 - Partitioning screens - a variety of widths and heights to create personalized privacy; offered in laminate, glaze or select fabrics.
 - Transaction tops - laminate tops ideal for creating reception stations.
- For environmental certifications, please visit globalfurnituregroup.com.
- Model numbers reflect total width of panel and posts.

DIVIDE POSTS

- Available in 6 standard heights:
 - 12" high - to create **semi-private** spaces and to support transaction tops.
 - 18" high - to create **semi-private** spaces.
 - 24" high - to create **semi-private** spaces.
 - 30" high - to create **semi-private** spaces.
 - 36" high - to create **private** spaces and to match the height of 36" high hutches and/or 65" high Adaptabilities, Genoa, and Zira cabinets.
 - 42" high - to create **private** spaces and to match the height of 42" high hutches and/or 72" high Zira cabinets.
- Posts are field installed. Each plate divider includes: 1 post mounting plate, 1 threaded rod, 3 cover strips and 1 top cap plus mounting hardware (contains 8 screws, 1 washer, 1 locking nut). 2 divide posts are required per partitioning panel.
- Available in Black (**BLK**) or Tungsten (**TUN**) finish, please specify.

PARTITIONING SCREENS

- Available in 4 standard heights: 12", 18", 24" and 36" and can be used in combinations to create systems consisting of 12", 18", 24", 30", 36" and 42" heights.
- Available in 3 materials:
 - **Laminate** - available in all laminate colors used on Adaptabilities, Genoa and Zira (see right). Accent edging at top and bottom in Black (**BLK**) only. Optional wire access scoop cut-out is offered, centered at the bottom of the panel - order as "**SCP2**" after model #.
 - **Glazed** - choice of **Clear**, **Ribbed** or **Frosted** glazing. Top and bottom rail are optional in Black (**BLK**) or Tungsten (**TUN**) finish, please specify. Top rail is designed to accommodate off-desk accessories. Glazed panels are also available with 4" raised bottom for pass-through options - see models DRGPxxxx on pages 296-298.
 - **Fabric** - available in select panel fabrics only (see right). Top and bottom rail are optional in Black (**BLK**) or Tungsten (**TUN**) finish, please specify. Top rail is designed to accommodate off-desk accessories.
- Divide posts partitioning panels are sold separately. Filler panels are included with each Divide panel. To be used between two posts in a straight run from worksurface to worksurface.
- Special width panels are available in laminate or glazed material options only. For pricing, contact Specials Department for a quote.

TRANSACTION TOPS

- Tops are available in 1" or 1.5" thick thermally fused laminate.
- Tops are sealed with Global's preferred edging in matching color.
- Woodgrain surfaces feature edging with matching printed woodgrain.
- Transaction tops are available with optional edges at no upcharge, please specify.



A3 1" top, standard flat edge



AR 1" top, bicut edge



C3 1.5" top, standard flat edge



CR 1.5" top, bicut edge



FL 1.5" top, fluted edge

- Includes all necessary flat mounting plates and joining plates.
- Features predrilled locating holes to allow for quick alignment with the divide post.
- Available with a radius cut on one or both ends (each radius adds a 6" overhang).

LAMINATE AND EDGE FINISHES (laminate panels and transaction tops)

ACJ	Absolute Acajou	FCL	First Class
ASN	Asian Night	NBL	Noce Biondo
AWC	Avant Cherry	NGL	Noce Grigio
AWH	Avant Honey	NEL	Noce Leggero
BLK	Black	NML	Noce Medio
BZD	Blizzard	QTM	Quartered Mahogany
BRC	Brushed Cobalt	SBY	Sheer Beauty
CMB	Clear Maple	SDT	Stonedust
CGY	Custom Grey	SOG	Storm Grey
DES	Dark Espresso	WHE	Walnut Heights
DWT	Designer White	WHC	White Chocolate
FAS	Fashionista	WCR	Winter Cherry

FABRICS (fabric screens)

Note: Fabric screens can be upholstered in the following fabrics only:

- Anchorage*
- Lola*
- Merge*

* Contact Customer Service for pricing.

D DIVIDE™ - NOTES

PLEASE NOTE:

- Divide screens cannot be centered between two back to back worksurfaces.
- Screens must be installed on one worksurface or the other.
- Divide cannot be used with Adaptabilities reception units.
- When panels are mounted on a 30" deep worksurface from Adaptabilities, Genoa or Zira, please specify 29" wide panel.

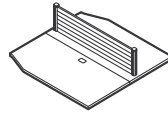

Correct installation

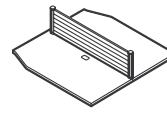

Incorrect installation

HOW TO ORDER DIVIDE SCREENS

example: DTB 1236 GN31

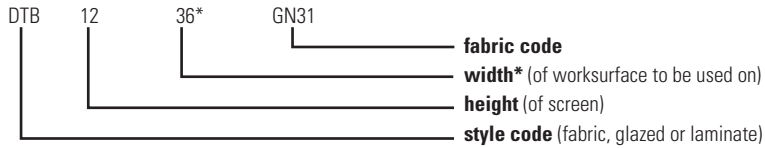

*NOTE: number denotes width of worksurface to use - please see dimensions in price book for actual dimensions of the screen.

PARTS AND COMPONENTS

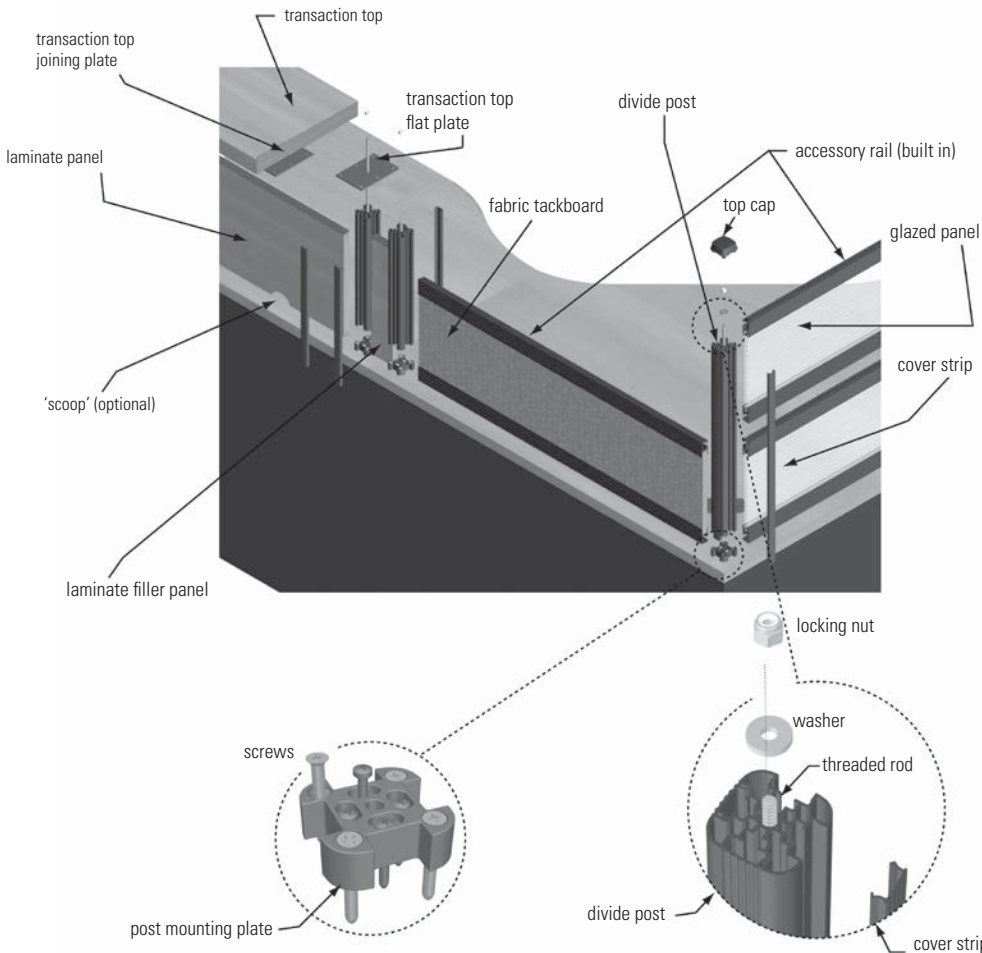

INSTALLATION IS AS SIMPLE AS 1...2...3

- 1) Attach the threaded **post mounting plate** with enclosed screws to the top side of the worksurface.
- 2) **Divide post** is bolted to the mounting plate.
- 3) **Top cap** is attached to the top of the divide post.

12" high system



18" high system



24" high system

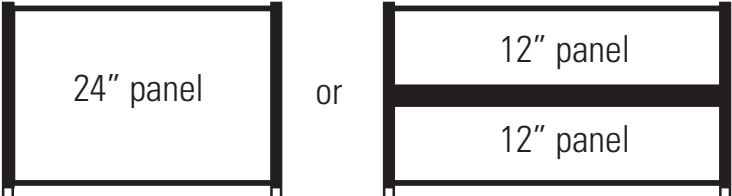

30" high system

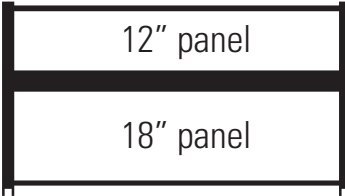

36" high system



42" high system

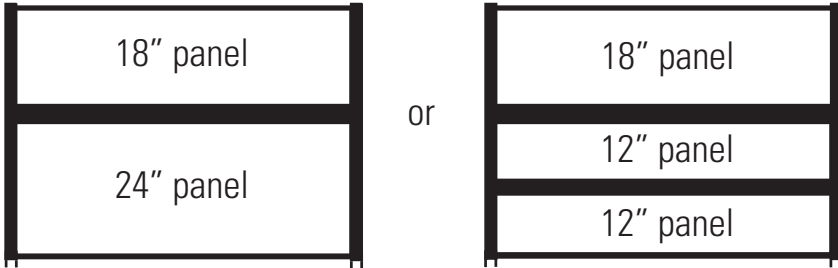

FABRIC PANELS

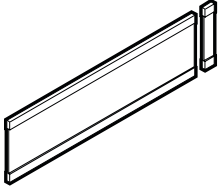

Fabric Panel - 12" High

MODEL # DIMENSIONS WT/LB. CUBIC FT. LIST PRICE

W x D x H

DTB1220	14.8 x 0.68 x 12	3	0.3	\$281
DTB1224	18.9 x 0.68 x 12	4	0.3	\$310
DTB1229	24.5 x 0.68 x 12	4	0.4	\$365
DTB1230	24.8 x 0.68 x 12	5	0.4	\$365
DTB1236	30.8 x 0.68 x 12	5	0.4	\$391
DTB1242	36.8 x 0.68 x 12	6	0.5	\$423
DTB1248	42.8 x 0.68 x 12	7	0.6	\$449
DTB1260	54.8 x 0.68 x 12	9	0.7	\$520
DTB1266	60.8 x 0.68 x 12	10	0.8	\$572
DTB1272	66.8 x 0.68 x 12	11	0.8	\$614

Features built-in accessory rail. Includes matching filler panel. **Specify DTB1229 for panels placed along the depth side of a 30" deep worksurface.** 1 set per carton.

- Top and bottom rail are optional in Black (BLK) or Tungsten (TUN), please specify.
- Model # depicts size of worksurface to be used on - see notes on page 292 for additional ordering information.
- Divide post MUST be ordered separately. Two posts are required per panel.

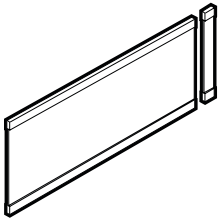

Fabric Panel - 18" High

DTB1820	14.8 x 0.68 x 18	4	0.3	\$300
DTB1824	18.9 x 0.68 x 18	5	0.4	\$323
DTB1829	24.5 x 0.68 x 18	6	0.5	\$391
DTB1830	24.8 x 0.68 x 18	6	0.5	\$391
DTB1836	30.8 x 0.68 x 18	7	0.6	\$433
DTB1842	36.8 x 0.68 x 18	8	0.7	\$433
DTB1848	42.8 x 0.68 x 18	10	0.8	\$477
DTB1860	54.8 x 0.68 x 18	12	0.9	\$520
DTB1866	60.8 x 0.68 x 18	14	1	\$667
DTB1872	66.8 x 0.68 x 18	14	1.1	\$717

Features built-in accessory rail. Includes matching filler panel. **Specify DTB1829 for panels placed along the depth side of a 30" deep worksurface.** 1 set per carton.

- Top and bottom rail are optional in Black (BLK) or Tungsten (TUN), please specify.
- Model # depicts size of worksurface to be used on - see notes on page 292 for additional ordering information.
- Divide post MUST be ordered separately. Two posts are required per panel.

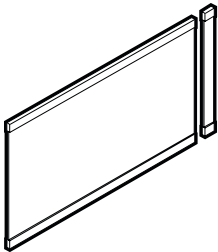

Fabric Panel - 24" High

DTB2420	14.8 x 0.68 x 24	4	0.4	\$310
DTB2424	18.9 x 0.68 x 24	4	0.5	\$337
DTB2429	24.5 x 0.68 x 24	6	0.6	\$429
DTB2430	24.8 x 0.68 x 24	6	0.6	\$429
DTB2436	30.8 x 0.68 x 24	7	0.7	\$455
DTB2442	36.8 x 0.68 x 24	8	0.8	\$496
DTB2448	42.8 x 0.68 x 24	9	0.9	\$534
DTB2460	54.8 x 0.68 x 24	11	1.1	\$648
DTB2466	60.8 x 0.68 x 24	12	1.2	\$686
DTB2472	66.8 x 0.68 x 24	14	1.4	\$742

Features built-in accessory rail. Includes matching filler panel. **Specify DTB2429 for panels placed along the depth side of a 30" deep worksurface.** 1 set per carton.

- Top and bottom rail are optional in Black (BLK) or Tungsten (TUN), please specify.
- Model # depicts size of worksurface to be used on - see notes on page 292 for additional ordering information.
- Divide post MUST be ordered separately. Two posts are required per panel.

Required specifications

Fabric

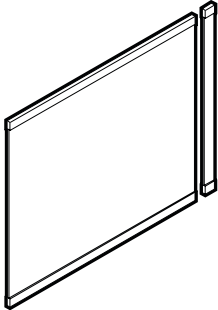
FABRIC PANELS	MODEL #	DIMENSIONS	WT/LB.	CUBIC FT.	LIST PRICE
		W x D x H			
	DTB3620	14.8 x 0.68 x 36	6	0.6	\$365
	DTB3624	18.9 x 0.68 x 36	7	0.7	\$391
	DTB3629	24.5 x 0.68 x 36	9	0.9	\$461
	DTB3630	24.8 x 0.68 x 36	9	0.9	\$461
	DTB3636	30.8 x 0.68 x 36	10	1	\$675
	DTB3642	36.8 x 0.68 x 36	12	1.2	\$717
	DTB3648	42.8 x 0.68 x 36	14	1.3	\$785
	DTB3660	54.8 x 0.68 x 36	17	1.6	\$952
	DTB3666	60.8 x 0.68 x 36	19	1.8	\$982
DTB3672	66.8 x 0.68 x 36	21	1.9	\$1024	

Fabric Panel - 36" High

Features built-in accessory rail. Includes matching filler panel. **Specify DTB3629 for panels placed along the depth side of a 30" deep worksurface.** 1 set per carton.

- Top and bottom rail are optional in Black (BLK) or Tungsten (TUN), please specify.
- Model # depicts size of worksurface to be used on - see notes on page 292 for additional ordering information.
- Divide post MUST be ordered separately. Two posts are required per panel.

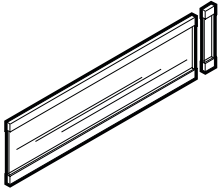
GLAZED PANELS	MODEL #	DIMENSIONS	WT/LB.	CUBIC FT.	LIST PRICE
	DGP1220	14.8 x 0.68 x 12	2	0.3	\$206
	DGP1224	18.9 x 0.68 x 12	3	0.3	\$241
	DGP1229	24.5 x 0.68 x 12	3	0.4	\$284
	DGP1230	24.8 x 0.68 x 12	4	0.4	\$284
	DGP1236	30.8 x 0.68 x 12	4	0.4	\$333
	DGP1242	36.8 x 0.68 x 12	5	0.5	\$370
	DGP1248	42.8 x 0.68 x 12	5	0.6	\$446
	DGP1260	54.8 x 0.68 x 12	7	0.7	\$538
	DGP1266	60.8 x 0.68 x 12	7	0.8	\$583
	DGP1272	66.8 x 0.68 x 12	8	0.8	\$624

Glazed Panel - 12" High

Features built-in accessory rail. Includes matching filler panel. **Specify DGP1229 for panels placed along the depth side of a 30" deep worksurface.** 1 set per carton.

- Top and bottom rail are optional in Black (BLK) or Tungsten (TUN), please specify.
- Model # depicts size of worksurface to be used on - see notes on page 292 for additional ordering information.
- Divide post MUST be ordered separately. Two posts are required per panel.
- Glazing is available in Frosted (GF), Clear (GC) or Ribbed (RG).

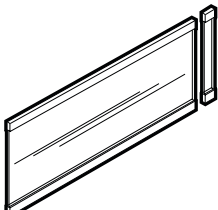
	DGP1820	14.8 x 0.68 x 18	3	0.3	\$241
	DGP1824	18.9 x 0.68 x 18	3	0.4	\$270
	DGP1829	24.5 x 0.68 x 18	4	0.5	\$320
	DGP1830	24.8 x 0.68 x 18	4	0.5	\$320
	DGP1836	30.8 x 0.68 x 18	5	0.6	\$370
	DGP1842	36.8 x 0.68 x 18	5	0.7	\$415
	DGP1848	42.8 x 0.68 x 18	6	0.8	\$499
	DGP1860	54.8 x 0.68 x 18	8	0.9	\$600
	DGP1866	60.8 x 0.68 x 18	8	1	\$650
	DGP1872	66.8 x 0.68 x 18	9	1.1	\$698

Glazed Panel - 18" High

Features built-in accessory rail. Includes matching filler panel. **Specify DGP1829 for panels placed along the depth side of a 30" deep worksurface.** 1 set per carton.

- Top and bottom rail are optional in Black (BLK) or Tungsten (TUN), please specify.
- Model # depicts size of worksurface to be used on - see notes on page 292 for additional ordering information.
- Divide post MUST be ordered separately. Two posts are required per panel.
- Glazing is available in Frosted (GF), Clear (GC) or Ribbed (RG).

Required specifications

Fabric (fabric panels)
Glaze (glazed panels)

GLAZED PANELS

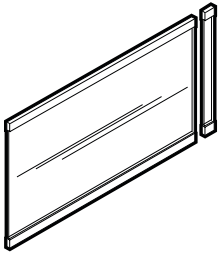

Glazed Panel - 24" High

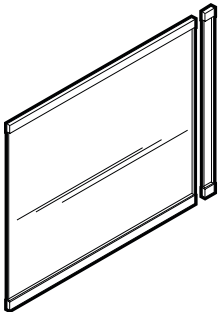

Glazed Panel - 36" High

MODEL # DIMENSIONS WT/LB. CUBIC FT. LIST PRICE

W x D x H

DGP2420	14.8 x 0.68 x 24	3	0.4	\$270
DGP2424	18.9 x 0.68 x 24	4	0.5	\$303
DGP2429	24.5 x 0.68 x 24	4	0.6	\$367
DGP2430	24.8 x 0.68 x 24	5	0.6	\$367
DGP2436	30.8 x 0.68 x 24	5	0.7	\$429
DGP2442	36.8 x 0.68 x 24	6	0.8	\$485
DGP2448	42.8 x 0.68 x 24	7	0.9	\$574
DGP2460	54.8 x 0.68 x 24	9	1.1	\$694
DGP2466	60.8 x 0.68 x 24	10	1.2	\$756
DGP2472	66.8 x 0.68 x 24	10	1.4	\$813

Features built-in accessory rail. Includes matching filler panel. **Specify DGP2429 for panels placed along the depth side of a 30" deep worksurface.** 1 set per carton.

- Top and bottom rail are optional in Black (**BLK**) or Tungsten (**TUN**), please specify.
- *Model # depicts size of worksurface to be used on - see notes on page 292 for additional ordering information.*
- Divide post **MUST** be ordered separately. Two posts are required per panel.
- Glazing is available in Frosted (**GF**), Clear (**GC**) or Ribbed (**RG**).

DGP3620	14.8 x 0.68 x 36	4	0.6	\$333
DGP3624	18.9 x 0.68 x 36	4	0.7	\$367
DGP3629	24.5 x 0.68 x 36	5	0.9	\$442
DGP3630	24.8 x 0.68 x 36	6	0.9	\$442
DGP3636	30.8 x 0.68 x 36	7	1	\$521
DGP3642	36.8 x 0.68 x 36	8	1.2	\$590
DGP3648	42.8 x 0.68 x 36	9	1.3	\$698
DGP3660	54.8 x 0.68 x 36	11	1.6	\$851
DGP3666	60.8 x 0.68 x 36	12	1.8	\$929
DGP3672	66.8 x 0.68 x 36	13	1.9	\$1001

Features built-in accessory rail. Includes matching filler panel. **Specify DGP3629 for panels placed along the depth side of a 30" deep worksurface.** 1 set per carton.

- Top and bottom rail are optional in Black (**BLK**) or Tungsten (**TUN**), please specify.
- *Model # depicts size of worksurface to be used on - see notes on page 292 for additional ordering information.*
- Divide post **MUST** be ordered separately. Two posts are required per panel.
- Glazing is available in Frosted (**GF**), Clear (**GC**) or Ribbed (**RG**).

RAISED GLAZED PANELS

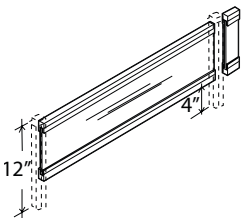

Raised Glazed Panel - 12" High

DRGP1220	20 x 0.68 x 12	2	0.2	\$247
DRGP1224	24 x 0.68 x 12	3	0.3	\$289
DRGP1229	29 x 0.68 x 12	3	0.3	\$343
DRGP1230	30 x 0.68 x 12	4	0.3	\$343
DRGP1236	36 x 0.68 x 12	4	0.4	\$399
DRGP1242	42 x 0.68 x 12	5	0.5	\$453
DRGP1248	48 x 0.68 x 12	5	0.5	\$538
DRGP1260	60 x 0.68 x 12	7	0.7	\$632
DRGP1266	66 x 0.68 x 12	7	0.7	\$694
DRGP1272	72 x 0.68 x 12	8	0.8	\$751

Features raised bottom with 4" pass-through and built-in accessory rail. Includes matching filler panel. **Specify DRGP1229 for panels placed along the depth side of a 30" deep worksurface.** 1 set per carton.

- Top and bottom rail are optional in Black (**BLK**) or Tungsten (**TUN**), please specify.
- *Model # depicts size of worksurface to be used on - see notes on page 292 for additional ordering information.*
- Divide post **MUST** be ordered separately. Two posts are required per panel.
- Raised glazed panels to be used in the bottom position only and may be stacked upon but cannot be used to stack above other panel modules. 4" pass-through to be at the desktop level only.
- Glazing is available in Frosted (**GF**), Clear (**GC**) or Ribbed (**RG**).

Required specifications

Glaze

RAISED GLAZED PANELS **MODEL #** **DIMENSIONS** **WT/LB.** **CUBIC FT.** **LIST PRICE**

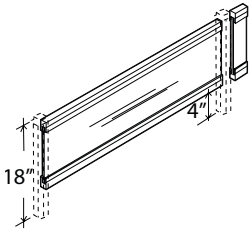

Raised Glazed Panel - 18" High

	W x D x H			
DRGP1820	20 x 0.68 x 18	3	0.3	\$289
DRGP1824	24 x 0.68 x 18	3	0.4	\$327
DRGP1829	29 x 0.68 x 18	4	0.5	\$381
DRGP1830	30 x 0.68 x 18	4	0.5	\$381
DRGP1836	36 x 0.68 x 18	5	0.6	\$446
DRGP1842	42 x 0.68 x 18	5	0.6	\$499
DRGP1848	48 x 0.68 x 18	6	0.7	\$594
DRGP1860	60 x 0.68 x 18	8	0.9	\$713
DRGP1866	66 x 0.68 x 18	8	1	\$770
DRGP1872	72 x 0.68 x 18	9	1.1	\$837

Features raised bottom with 4" pass-through and built-in accessory rail. Includes matching filler panel. **Specify DRGP1829 for panels placed along the depth side of a 30" deep worksurface.** 1 set per carton.

- Top and bottom rail are optional in Black (BLK) or Tungsten (TUN), please specify.
- Model # depicts size of worksurface to be used on - see notes on page 292 for additional ordering information.
- Divide post MUST be ordered separately. Two posts are required per panel.
- Raised glazed panels to be used in the bottom position only and may be stacked upon but cannot be used to stack above other panel modules. 4" pass-through to be at the desktop level only.
- Glazing is available in Frosted (GF), Clear (GC) or Ribbed (RG).

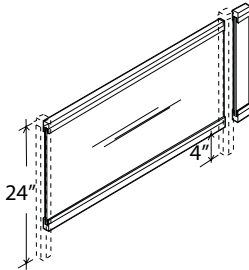

Raised Glazed Panel - 24" High

DRGP2420	20 x 0.68 x 24	3	0.4	\$327
DRGP2424	24 x 0.68 x 24	4	0.5	\$366
DRGP2429	29 x 0.68 x 24	4	0.6	\$438
DRGP2430	30 x 0.68 x 24	5	0.6	\$438
DRGP2436	36 x 0.68 x 24	5	0.7	\$509
DRGP2442	42 x 0.68 x 24	6	0.8	\$580
DRGP2448	48 x 0.68 x 24	7	0.9	\$679
DRGP2460	60 x 0.68 x 24	9	1.1	\$831
DRGP2466	66 x 0.68 x 24	10	1.2	\$908
DRGP2472	72 x 0.68 x 24	10	1.3	\$979

Features raised bottom with 4" pass-through and built-in accessory rail. Includes matching filler panel. **Specify DRGP2429 for panels placed along the depth side of a 30" deep worksurface.** 1 set per carton.

- Top and bottom rail are optional in Black (BLK) or Tungsten (TUN), please specify.
- Model # depicts size of worksurface to be used on - see notes on page 292 for additional ordering information.
- Divide post MUST be ordered separately. Two posts are required per panel.
- Raised glazed panels to be used in the bottom position only and may be stacked upon but cannot be used to stack above other panel modules. 4" pass-through to be at the desktop level only.
- Glazing is available in Frosted (GF), Clear (GC) or Ribbed (RG).

Required specifications

Glaze

RAISED GLAZED PANELS

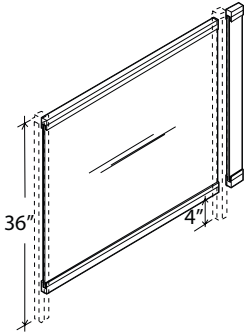

Raised Glazed Panel - 36" High

MODEL #	DIMENSIONS			WT/LB.	CUBIC FT.	LIST PRICE
	W x D x H					
DRGP3620	20 x 0.68 x 36	4	0.6			\$399
DRGP3624	24 x 0.68 x 36	4	0.7			\$438
DRGP3629	29 x 0.68 x 36	5	0.8			\$529
DRGP3630	30 x 0.68 x 36	6	0.8			\$529
DRGP3636	36 x 0.68 x 36	7	1			\$628
DRGP3642	42 x 0.68 x 36	8	1.1			\$713
DRGP3648	48 x 0.68 x 36	9	1.3			\$837
DRGP3660	60 x 0.68 x 36	11	1.6			\$1009
DRGP3666	66 x 0.68 x 36	12	1.7			\$1098
DRGP3672	72 x 0.68 x 36	13	1.9			\$1188

Features raised bottom with 4" pass-through and built-in accessory rail. Includes matching filler panel. **Specify DRGP3629 for panels placed along the depth side of a 30" deep worksurface.** 1 set per carton.

- Top and bottom rail are optional in Black (**BLK**) or Tungsten (**TUN**), please specify.
- *Model # depicts size of worksurface to be used on - see notes on page 292 for additional ordering information.*
- Divide post **MUST** be ordered separately. Two posts are required per panel.
- Raised glazed panels to be used in the bottom position only and may be stacked upon but cannot be used to stack above other panel modules. 4" pass-through to be at the desktop level only.
- Glazing is available in Frosted (**GF**), Clear (**GC**) or Ribbed (**RG**).

LAMINATE PANELS

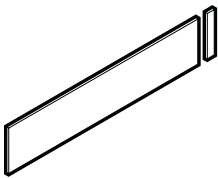

Laminate Panel - 12" High

DLP1220	14.8 x 0.68 x 12	5	0.3			\$70
DLP1224	18.9 x 0.68 x 12	5	0.3			\$82
DLP1229	24.5 x 0.68 x 12	7	0.4			\$103
DLP1230	24.8 x 0.68 x 12	7	0.4			\$103
DLP1236	30.8 x 0.68 x 12	8	0.4			\$113
DLP1242	36.8 x 0.68 x 12	10	0.5			\$131
DLP1248	42.8 x 0.68 x 12	11	0.6			\$151
DLP1260	54.8 x 0.68 x 12	14	0.7			\$166
DLP1266	60.8 x 0.68 x 12	16	0.8			\$183
DLP1272	66.8 x 0.68 x 12	17	0.8			\$202

Includes matching filler panel. Scoop option (**SCP2**) available, add \$33. **Specify DLP1229 for panels placed along the depth side of a 30" deep worksurface.** 1 set per carton.

- *Model # depicts size of worksurface to be used on - see notes on page 292 for additional ordering information.*
- Divide post **MUST** be ordered separately. Two posts are required per panel.
- Accent edging at top and bottom in Black (**BLK**) only.

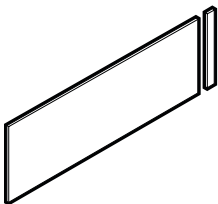

Laminate Panel - 18" High

DLP1820	14.8 x 0.68 x 18	7	0.3			\$82
DLP1824	18.9 x 0.68 x 18	8	0.4			\$95
DLP1829	24.5 x 0.68 x 18	10	0.5			\$115
DLP1830	24.8 x 0.68 x 18	10	0.5			\$115
DLP1836	30.8 x 0.68 x 18	12	0.6			\$131
DLP1842	36.8 x 0.68 x 18	15	0.7			\$156
DLP1848	42.8 x 0.68 x 18	17	0.8			\$179
DLP1860	54.8 x 0.68 x 18	21	0.9			\$197
DLP1866	60.8 x 0.68 x 18	23	1			\$217
DLP1872	66.8 x 0.68 x 18	25	1.1			\$241

Includes matching filler panel. Scoop option (**SCP2**) available, add \$33. **Specify DLP1829 for panels placed along the depth side of a 30" deep worksurface.** 1 set per carton.

- *Model # depicts size of worksurface to be used on - see notes on page 292 for additional ordering information.*
- Divide post **MUST** be ordered separately. Two posts are required per panel.
- Accent edging at top and bottom in Black (**BLK**) only.

Required specifications

Finish (laminate panels)
Glaze (glazed panels)

LAMINATE PANELS MODEL # DIMENSIONS WT/LB. CUBIC FT. LIST PRICE

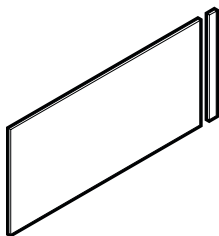

Laminate Panel - 24" High

	W x D x H			
DLP2420	14.8 x 0.68 x 24	9	0.4	\$95
DLP2424	18.9 x 0.68 x 24	11	0.5	\$108
DLP2429	24.5 x 0.68 x 24	13	0.6	\$131
DLP2430	24.8 x 0.68 x 24	13	0.6	\$131
DLP2436	30.8 x 0.68 x 24	16	0.7	\$151
DLP2442	36.8 x 0.68 x 24	19	0.8	\$179
DLP2448	42.8 x 0.68 x 24	22	0.9	\$202
DLP2460	54.8 x 0.68 x 24	28	1.1	\$228
DLP2466	60.8 x 0.68 x 24	30	1.2	\$253
DLP2472	66.8 x 0.68 x 24	33	1.4	\$280

Includes matching filler panel. Scoop option (SCP2) available, add \$33. Specify DLP2429 for panels placed along the depth side of a 30" deep worksurface. 1 set per carton.

- Model # depicts size of worksurface to be used on - see notes on page 292 for additional ordering information.
- Divide post MUST be ordered separately. Two posts are required per panel.
- Accent edging at top and bottom in Black (BLK) only.

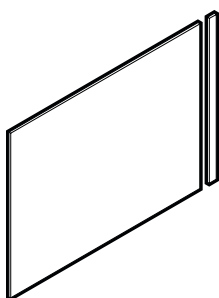

Laminate Panel - 36" High

DLP3620	14.8 x 0.68 x 36	13	0.6	\$120
DLP3624	18.9 x 0.68 x 36	16	0.7	\$131
DLP3629	24.5 x 0.68 x 36	20	0.9	\$166
DLP3630	24.8 x 0.68 x 36	20	0.9	\$166
DLP3636	30.8 x 0.68 x 36	24	1	\$190
DLP3642	36.8 x 0.68 x 36	28	1.2	\$222
DLP3648	42.8 x 0.68 x 36	33	1.3	\$253
DLP3660	54.8 x 0.68 x 36	41	1.6	\$290
DLP3666	60.8 x 0.68 x 36	45	1.8	\$320
DLP3672	66.8 x 0.68 x 36	50	1.9	\$352

Includes matching filler panel. Scoop option (SCP2) available, add \$33. Specify DLP3629 for panels placed along the depth side of a 30" deep worksurface. 1 set per carton.

- Model # depicts size of worksurface to be used on - see notes on page 292 for additional ordering information.
- Divide post MUST be ordered separately. Two posts are required per panel.
- Accent edging at top and bottom in Black (BLK) only.

Required specifications

Finish

D DIVIDE™

DIVIDE POSTS



Divide Post

MODEL #	DIMENSIONS	WT/LB.	CUBIC FT.	LIST PRICE
---------	------------	--------	-----------	------------

W x D x H

DPOST12	1.68 x 1.68 x 12	3	0.1	\$95
DPOST18	1.68 x 1.68 x 18	3	0.1	\$131
DPOST24	1.68 x 1.68 x 24	3	0.1	\$183
DPOST30	1.68 x 1.68 x 30	3	0.1	\$253
DPOST36	1.68 x 1.68 x 36	4	0.2	\$284
DPOST42	1.68 x 1.68 x 42	5	0.2	\$320

For supporting panels. Includes one post, one mounting plate, one top cap, three cover strips, threaded rod and all mounting hardware. Installation templates are supplied with each project. MUST specify Black (**BLK**) or Tungsten (**TUN**).

- Requires 2 divide posts per panel.
- Divide post is mounted 1,063" from worksurface edge.



Post-to-Wall Filler Strip

DFS12	0.75 x 1.43 x 12	2	0.5	\$55
DFS18	0.75 x 1.43 x 18	2	0.5	\$55
DFS24	0.75 x 1.43 x 24	2	0.5	\$55
DFS30	0.75 x 1.43 x 30	2	0.5	\$55
DFS36	0.75 x 1.43 x 36	2	0.5	\$55
DFS42	0.75 x 1.43 x 42	3	0.6	\$55

Used to fill gap between divide post and an adjacent wall, wardrobe unit, or hutch. Black only.

Required specifications

Finish

TRANSACTION TOPS

- To order a radius end on one side of a transaction top, add the suffix "D" to the model number (ex. DATT30D). **Add 15% upcharge.**
- To order a radius end on both sides of a transaction top, add the suffix "DD" to the model number (ex. DATT30DD). **Add 20% upcharge.**
- Each radius end adds a 6" overhang per side (see illustrations below).

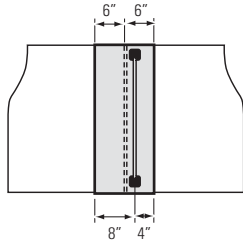

Transaction top is offset 6" from edge of worksurface in both directions.

Transaction top is offset 4" from the center of divide post towards the inside and 8" toward the outside.

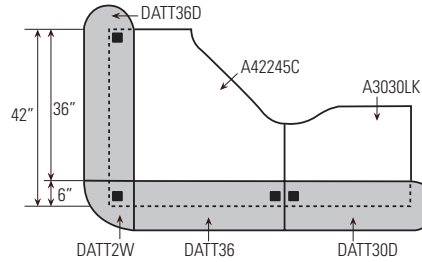

Two Way Connector Transaction Top (DATT2W/DCTT2W)
Use with a corner worksurface to link transaction tops together.

Transaction Top Offset

- 4" from the center of the divide post to the inside of worksurface.
- 8" from the center of the divide post to the outside of worksurface.

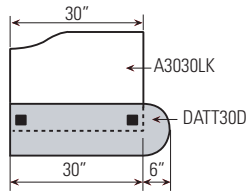

Radius End Transaction Top - One Side
Add suffix "D" to model number for radius end on one side.

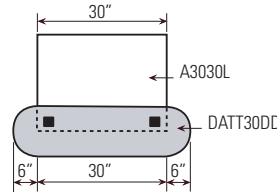

Radius End Transaction Top - Two Sides
Add suffix "DD" to model number for radius end on both sides.

STRAIGHT TRANSACTION TOPS

MODEL # DIMENSIONS WT/LB. CUBIC FT. LIST PRICE

W x D x H

DATT14	14 x 12 x 1	7	0.3	\$126
DATT18	18 x 12 x 1	8	0.4	\$126
DATT20	20 x 12 x 1	9	0.5	\$126
DATT23	23 x 12 x 1	10	0.5	\$126
DATT24	24 x 12 x 1	10	0.5	\$126
DATT29	29 x 12 x 1	12	0.6	\$190
DATT30	30 x 12 x 1	12	0.6	\$190
DATT36	36 x 12 x 1	14	0.7	\$190
DATT42	42 x 12 x 1	16	0.8	\$253
DATT48	48 x 12 x 1	18	0.9	\$253
DATT54	54 x 12 x 1	21	1	\$315
DATT60	60 x 12 x 1	23	1.1	\$315
DATT66	66 x 12 x 1	25	1.2	\$381
DATT72	72 x 12 x 1	27	1.3	\$381



Straight Transaction Top - 1" Thick

12" deep x 1" thick top. Includes all necessary flat plates, joining plates and screws. Thickness matches Adaptabilities, Genoa and Zira series worksurfaces. 1 set per carton.

- Add "D" to model number for radius end on one side. **Add 15% upcharge** (excluding 18" this must be quoted).
- Add "DD" to model number for radius end on both sides. **Add 20% upcharge.**
- Each radius adds 6" overhang per side.

Required specifications
Laminate finish (transaction tops)

Optional specifications
Edge detail

STRAIGHT TRANSACTION TOPS



Straight Transaction Top - 1.5" Thick

MODEL #	DIMENSIONS W x D x H	WT/LB.	CUBIC FT.	LIST PRICE
DCTT14	14 x 12 x 1.5	9	0.3	\$190
DCTT18	18 x 12 x 1.5	11	0.4	\$190
DCTT20	20 x 12 x 1.5	12	0.5	\$190
DCTT23	23 x 12 x 1.5	14	0.5	\$190
DCTT24	24 x 12 x 1.5	14	0.5	\$190
DCTT29	29 x 12 x 1.5	17	0.6	\$284
DCTT30	30 x 12 x 1.5	17	0.6	\$284
DCTT36	36 x 12 x 1.5	20	0.7	\$284
DCTT42	42 x 12 x 1.5	23	0.8	\$347
DCTT48	48 x 12 x 1.5	26	0.9	\$347
DCTT54	54 x 12 x 1.5	29	1	\$409
DCTT60	60 x 12 x 1.5	32	1.1	\$409
DCTT66	66 x 12 x 1.5	35	1.2	\$472
DCTT72	72 x 12 x 1.5	38	1.3	\$472

12" deep x 1.5" thick top. Includes all necessary flat plates, joining plates and screws. Thickness matches Zira series worksurfaces. 1 set per carton.

- Add "D" to model number for radius end on one side. **Add 15% upcharge** (excluding 18" this must be quoted).
- Add "DD" to model number for radius end on both sides. **Add 20% upcharge.**
- Each radius adds 6" overhang per side.

GALLERY CORNER TRANSACTION TOPS

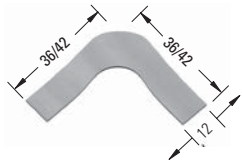

**Gallery Corner Transaction Top
1" Thick**

DA1GC36	36 x 36 x 1	32	5	\$804
DA1GC42	42 x 42 x 1	38	6.5	\$804

One piece corner top to be used on 36" and 42" 5-sided corners. Cut-out maximizes use of worksurface space allowing for computer screen. Includes all necessary flat plates, joining plates and screws. Thickness matches Adaptabilities, Genoa and Zira series worksurfaces. 1 set per carton.

- Woodgrain runs in two directions. Transaction tops are only to be used on 12" high divide posts. Taller posts are not safe.

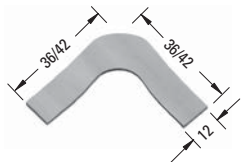

**Gallery Corner Transaction Top
- 1.5" Thick**

DC1GC36	36 x 36 x 1.5	43	5	\$929
DC1GC42	42 x 42 x 1.5	50	6.5	\$929

One piece corner top to be used on 36" and 42" 5-sided corners. Cut-out maximizes use of worksurface space allowing for computer screen. Includes all necessary flat plates, joining plates and screws. Thickness matches Zira series worksurfaces. 1 set per carton.

- Woodgrain runs in two directions. Transaction tops are only to be used on 12" high divide posts. Taller posts are not safe.

2 PIECE GALLERY CORNER TRANSACTION TOPS

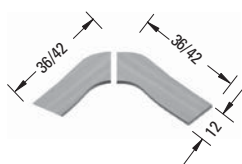

**2 Piece Gallery Corner
Transaction Top - 1" Thick**

DA2GC36	36 x 36 x 1	29	1.9	\$548
DA2GC42	42 x 42 x 1	33	1.9	\$548

Two piece corner top to be used on 36" and 42" 5-sided corners. Cut-out maximizes use of worksurface space allowing for computer screen. Includes all necessary flat plates, joining plates and screws. Thickness matches Adaptabilities, Genoa and Zira series worksurfaces. 1 set per carton.

- Woodgrain runs in two directions. Transaction tops are only to be used on 12" high divide posts. Taller posts are not safe.

Required specifications
Laminate finish

Optional specifications
Edge detail

2 PIECE GALLERY CORNER TOPS

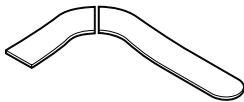
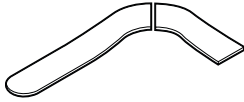
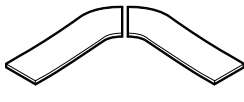
	MODEL #	DIMENSIONS	WT/LB.	CUBIC FT.	LIST PRICE
 <p>2 Piece Extended Gallery Corner Transaction Top - 1" Thick - LEFT</p>		W x D x H			
	DA2GC66L	66 x 36 x 1	37	3	\$770
<p>Two piece corner top to be used on 30" x 66" desktop. "D" radius end on long transaction top. Includes all necessary flat plates, joining plates and screws. Thickness matches Adaptabilities, Genoa and Zira series worksurfaces. 1 set per carton.</p> <ul style="list-style-type: none"> • Woodgrain runs in two directions. Transaction tops are only to be used on 12" high divide post. Taller posts are not safe. 					
 <p>2 Piece Extended Gallery Corner Transaction Top - 1" Thick - RIGHT</p>		W x D x H			
	DA2GC66R	66 x 36 x 1	37	3	\$770
<p>Two piece corner top to be used on 30" x 66" desktop. "D" radius end on long transaction top. Includes all necessary flat plates, joining plates and screws. Thickness matches Adaptabilities, Genoa and Zira series worksurfaces. 1 set per carton.</p> <ul style="list-style-type: none"> • Woodgrain runs in two directions. Transaction tops are only to be used on 12" high divide posts. Taller posts are not safe. 					
 <p>2 Piece Gallery Corner Transaction Top - 1.5" Thick</p>		W x D x H			
	DC2GC36 DC2GC42	36 x 36 x 1.5 42 x 42 x 1.5	39 45	1.9 1.9	\$673 \$673
<p>Two piece corner top to be used on 36" and 42" 5-sided corners. Cut-out maximizes use of worksurface space allowing for computer screen. Includes all necessary flat plates, joining plates and screws. Thickness matches Zira series worksurfaces. 1 set per carton.</p> <ul style="list-style-type: none"> • Woodgrain runs in two directions. Transaction tops are only to be used on 12" high divide posts. Taller posts are not safe. 					

2-WAY CONNECTOR TOPS

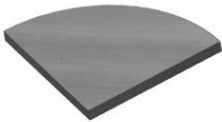
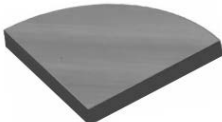
 <p>2-Way Connector Transaction Top - 1" Thick</p>	DATT2W	12 x 12 x 1	6	0.3	\$222
	<p>Used as a corner piece to link four transaction tops. Deduct 6" from each side adjoining the corner piece. Includes all necessary flat plates, joining plates and screws. Thickness matches Adaptabilities, Genoa and Zira series worksurfaces. 1 set per carton.</p> <ul style="list-style-type: none"> • Woodgrain runs diagonally. Transaction tops are only to be used on 12" high divide posts. Taller posts are not safe. 				
 <p>2-Way Connector Transaction Top - 1.5" Thick</p>	DCTT2W	12 x 12 x 1.5	7	0.3	\$315
	<p>Used as a corner piece to link four transaction tops. Deduct 6" from each side adjoining the corner piece. Includes all necessary flat plates, joining plates and screws. Thickness matches Zira series worksurfaces. 1 set per carton.</p> <ul style="list-style-type: none"> • Woodgrain runs diagonally. Transaction tops are only to be used on 12" high divide posts. Taller posts are not safe. 				

Required specifications
Laminate finish

Optional specifications
Edge detail

D DIVIDE™

4-WAY CONNECTOR TOPS

MODEL # DIMENSIONS WT/LB. CUBIC FT. LIST PRICE

W x D x H

DATT4W 12 x 12 x 1 8 0.3 **\$190**

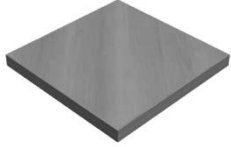

4-Way Connector Transaction Top - 1" Thick

Used as a corner piece to link four transaction tops. Deduct 6" from each side adjoining the corner piece. Includes all necessary flat plates, joining plates and screws. Thickness matches Adaptabilities, Genoa and Zira series worksurfaces. 1 set per carton.

- Woodgrain runs diagonally. Transaction tops are only to be used on 12" high divide posts. Taller posts are not safe.

DCTT4W 12 x 12 x 1.5 10 0.3 **\$284**

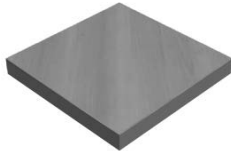

4-Way Connector Transaction Top - 1.5" Thick

Used as a corner piece to link four transaction tops. Deduct 6" from each side adjoining the corner piece. Includes all necessary flat plates, joining plates and screws. Thickness matches Zira series worksurfaces. 1 set per carton.

- Woodgrain runs diagonally. Transaction tops are only to be used on 12" high divide posts. Taller posts are not safe.

Required specifications

Laminate finish

Optional specifications

Edge detail

tables

café, meeting and conference



Alba

306



Boardroom

309



Swap

321





Contemporary and stylish meeting tables with unique metal bases. Alba tables offer a variety of options to suit the needs of any office.

Tops are available in round and square shapes.

Sculpted four-legged base is available in Black (**BLK**) or Tungsten 2 (**TU2**).

Five edge options - self, bullnose, T-mold, built up and slant. Slant edge and metal base finishes are available in either Black (**BLK**) or Tungsten 2 (**TU2**).

No matter the size of the space or the style of the office, Global's laminate meeting tables will work in any setting.

Designed exclusively for Global by world renowned designer Zooney Chu.

Features and Benefits

- All tops and bases are assembled using a metal-to-metal connection.
- All tops are 1.125" thick.
- Bullnose edges available in Black or Grey.
- T-mold edge available in Black and Grey, also available in 22 coordinating laminate finishes.
- Self edge and built-up self edge available in same color as laminate finish.
- Slant edge is available in Black or Tungsten 2.
- All edges available on all tables.
- All metal bases are available in Black or Tungsten 2.

GENERAL INFORMATION

- Designed by Zooney Chu.
- Ideal for small meeting spaces or cafeteria tables; 30" round or square top four-legged base.
- Five edge options: self (**SE**), bullnose (**BN**), T-mold (**TM**), built-up (**BU**) and slant (**ZS**).
- Sculpted four-legged base available in Black (**BLK**) or Tungsten 2 (**TU2**).
- For environmental certifications, please visit globalfurnituregroup.com.

CONSTRUCTION

- All tops are 1.125" thick with high performance, thermally fused laminate on both sides. A 1.75" built-up self edge is available on all models.
- All tops and bases use a metal-to-metal connection, allowing for easy installation.

EDGE OPTIONS

- Self, bullnose, T-mold, built-up, and slant edges are available on all models. Corners of rectangular, square and boat tables ordered with T-mold or bullnose will be rounded.
- **Bullnose** edge is available in Black (**BLK**) only.
- **T-mold** edge is available in Black (**BLK**) or coordinating laminate finish (**ME**).
- **Slant** edge is available in Black (**BLK**) or Tungsten (**TU2**).
- **Self** edge and **built-up** edges are same color as laminate finish.

LAMINATE FINISHES

ACJ	Absolute Acajou	FCL	First Class
ASN	Asian Night	NBL	Noce Biondo
AWC	Avant Cherry	NGL	Noce Grigio
AWH	Avant Honey	NEL	Noce Leggero
BLK	Black	NML	Noce Medio
BZD	Blizzard	QTM	Quartered Mahogany
BRC	Brushed Cobalt	SBY	Sheer Beauty
CMB	Clear Maple	SDT	Stonedust
CGY	Custom Grey	SOG	Storm Grey
DES	Dark Espresso	WHE	Walnut Heights
DWT	Designer White	WHC	White Chocolate
FAS	Fashionista	WCR	Winter Cherry

- The above laminate finishes are available in **high pressure**. Contact our Specials Department for a quote.
- If other than a Global standard laminate finish is preferred, contact our Specials Department. Information needed includes the name of the laminate manufacturer, color name, number and table model. You will then be given a quote for this special order.

A ALBA™ TABLES

ROUND TOPS



Round Top - Four Leg Base

MODEL #	DIMENSIONS	WT/LB.	CUBIC FT.	LIST PRICE
	W x D x H			
C30CF	30 x - x 28.5	54.5	7.06	\$536

Please specify edge detail: self edge (**SE**), bullnose (**BN**), T-mold (**TM**), built-up (**BU**) or slant edge (**ZS**).
Shipped easy to assemble in 2 cartons.

SQUARE TOPS



Square Top - Four Leg Base

C30SF	30 x 30 x 28.5	54.5	7.06	\$536
-------	----------------	------	------	--------------

Please specify edge detail: self edge (**SE**), bullnose (**BN**), T-mold (**TM**), built-up (**BU**) or slant edge (**ZS**).
Shipped easy to assemble in 2 cartons.

Required specifications

Finish

Edge detail

BOARDROOM & CAFETERIA TABLES



Sturdy and economically priced, Global boardroom and cafeteria tables are an excellent choice. All tables are made from thermally fused, high performance laminate and are easy to maintain.

Choose from four attractive table edges: self edge, bullnose, T-mold, or built-up self edge. Available in a variety of colors, all edge options are durable and wear-resistant.

Table tops are offered in six shapes - rectangular, racetrack, boat, elliptical, square and round - and a variety of bases including slab, cross, drum and arch. Add to this an impressive variety of laminate finishes that can be mixed and matched and you'll find Global can satisfy any and every business need.

From small meeting rooms to large boardrooms, from traditional to contemporary, Global's incredible range of table components, shapes, sizes and colors will enhance any office decor.

Features and Benefits

- Tables 144" or less are standard in one piece.
- One piece tops can be cut into two pieces for an upcharge.
- All tops are 1.125" thick.
- Tops and bases boxed as appropriate.
- Custom finish laminate tables available as special order.
- Bullnose edges available in Black or Grey.
- T-mold edge available in Black, Grey or coordinating laminate finish.
- Self edge and built-up self edge available in same color as laminate finish.
- All edges available on all tables.
- Metal legs and bases are standard in Chrome - also available in Black or Grey.

B BOARDROOM & CAFETERIA TABLES - NOTES

GENERAL INFORMATION

- Practical and economical table solutions for cafeteria, meeting spaces and more.
- All tables are 29" high.
- Tops are thermally fused laminate with 45 lb. density particle board core.
- Multiple base styles available in thermally fused laminate or metal.
- Tables 72", 84", 96", 120", 144" are standard in one piece.
- One piece tops can be cut into two pieces for an upcharge.
- Six top shapes: rectangular, racetrack, boat, square, round, barrel and elliptical.
- Four edge options: self edge, bullnose, T-mold or built-up self edge.
- For environmental certifications, please visit globalfurnituregroup.com.

CONSTRUCTION

- All tables are 29" high and made of 45 lb. density particle board covered on both sides with high performance, thermally fused laminate. Table width is nominal.
- All tables with cross bases use Blum fasteners.
- Round and square tops up to 60" dia. are 1" thick; all other tops are 1.125" thick thick. Both thickness are in high performance, thermally fused laminate.
- Tops with built-up (BU) edge option have a 1.75" built-up self edge.
- Tops are crated and bases boxed or crated as appropriate.
- All tops are **PRE-MARKED** as to base location, and the slot and hook assembly method (on selected tables) allows for easy installation.
- All racetrack, boat and rectangular tables 144" and under are standard with two drum, slab, arch, 2-legged, or tubular bases and are priced accordingly.
- Custom table sizes must be quoted. Contact our Specials Department.

LAMINATE FINISHES

ACJ Absolute Acajou	FCL First Class
ASN Asian Night	NBL Noce Biondo
AWC Avant Cherry	NGL Noce Grigio
AWH Avant Honey	NEL Noce Leggero
BLK Black	NML Noce Medio
BZD Blizzard	QTM Quartered Mahogany
BRC Brushed Cobalt	SBY Sheer Beauty
CMB Clear Maple	SDT Stonedust
CGY Custom Grey	SOG Storm Grey
DES Dark Espresso	WHE Walnut Heights
DWT Designer White	WHC White Chocolate
FAS Fashionista	WCR Winter Cherry

- The above laminate finishes are also available in **high pressure laminate**. Contact our Specials Department for a quote.
- All tables with one or more drum bases require a minimum of 50 lbs. of sand in each base for stability. Sand is not included, to be sourced locally.

METAL BASE FINISHES

- Available for CRRxx, CASxx, TCSxx, CARxx, TCRxx and CRSxx tables.

Paint finishes

TBL Black	TIN Ink
TBZ Buzz Blue	TKA Kalua
TCC Cactus	TLA Latte
TCR Carrot	TMO Mocha
TIV Cloud	TNE Nevada
TDW Designer White	TSN Sand
TDJ Dijon	TSR Scarlet
TEG Eggplant	TSH Shadow
TFO Fog	TOA Toast
TFR Frost	TTU Tungsten

Plated finishes - upcharge applies

ACO Antique Copper	CHM Chrome
BCH Brushed Chrome	SBR Satin Brass

EDGE OPTIONS

- Self, bullnose, T-mold and built-up edges are available on all models. Corners of rectangular, square and boat tables ordered with T-mold or bullnose will be rounded.
- **Bullnose** edge is available in Black (**BLK**) only.
- **T-mold** edge is available in Black (**BLK**) or coordinating laminate finish (**ME**) with upcharge (5%).
- **Self edge and built-up** edges are same color as laminate finish.

GROMMETS

- Grommets available in standard table top locations (left, center or right). Order as: **FOG1, FOG2** or **FOG3**. **Add \$91**.
- Grommet hole dimensions are 3.25" wide x 1.875" deep.

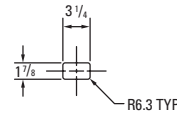

- Actual grommet locations will vary according to base selection.

POWER BLOCK

- A power block (model **PMSPPDM**) may be ordered on all worksurfaces.
- A power block is a rectangular worksurface power/data module with one electrical duplex receptacle and two data (RJ45) receptacles. 9' Black cord included. Power block dimensions are 6.5"W x 3.5"D x 2.75"H.
- Actual power block locations vary according to base selection. The locations will be left (E1), center (E2), and right (E3). **Example:** 8' table with drum base does not have a modesty panel, so the power block (E2) can be perfectly centered in the table. An 8' table with a slab base has the modesty panel, so the power block (E2) will be offset alongside the modesty panel.
- To purchase a power block, you must specify both the power block cut-out location and the power block model #. Order power block as **PMSPPDM**. **Add \$268**.
- Power blocks are available in standard worksurface locations (left, center or right). Order as **E1, E2** or **E3**. **Add \$91**.

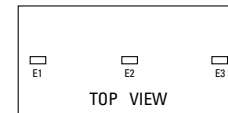
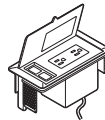

Power block **PMSPPDM**. **Add \$268**.

Specify location **E1, E2** or **E3**. **Add \$91**.

SPECIFICATIONS

- Specifications marked with an * are applicable to only those products which have the * symbol beside the product name.

SHIPPING

- Shipped easy to assemble.

BASE SIZE CHART (table width is nominal)

Round or Square Tops:

Top	Slab	Drum	Arch	Cross	4 Leg	Trumpet	Tube
36"	N/A	N/A	N/A	N/A	32"	24"	30"
42"	N/A	18"	N/A	30"	32"	24"	30"
48"	N/A	24"	N/A	30"	32"	N/A	30"
60"	N/A	30"	N/A	36"	N/A	N/A	N/A

Rectangular, Boat or Racetrack Tops:

Top	Slab	Drum	Arch	Cross	2 Leg	Trumpet	Tube
36" x 72"	24"	18"	24"	N/A	32"	N/A	30"
48" x 96"	28"	18"	28"	N/A	32"	N/A	30"
48" x 120"	28"	24"	28"	N/A	32"	N/A	30"
48" x 144"	28"	24"	28"	N/A	32"	N/A	30"

TABLE NOTES - ESTIMATED CAPACITY

- Use the following to determine the size of a round table and the number of chairs needed for a conference area. All estimates are based on an average chair width of 23" with a 4" clearance between chairs. Adjust accordingly for a different chair size.

NUMBER OF CHAIRS

Top Size	Round	Square	Rectangular	Boat	Racetrack	Elliptical
30 x 30	3	3	N/A	N/A	N/A	N/A
36 x 36	4	4	N/A	N/A	N/A	N/A
42 x 42	4	4	N/A	N/A	N/A	N/A
48 x 48	4	4	N/A	N/A	N/A	N/A
60 x 60	5	6	N/A	N/A	N/A	N/A
30 x 60	N/A	N/A	4-6	4-6	4-6	4
36 x 72	N/A	N/A	4-6	4-6	4-6	4
44 x 84	N/A	N/A	6-8	6-8	6-8	6
48 x 96	N/A	N/A	6-8	6-8	6-8	6
48 x 120	N/A	N/A	8-10	8-10	8-10	8
48 x 144	N/A	N/A	10-12	10-12	10-12	10
48 x 168	N/A	N/A	12-14	12-14	12-14	12
48 x 192	N/A	N/A	14-16	14-16	14-16	14
48 x 216	N/A	N/A	16-18	16-18	16-18	16
48 x 240	N/A	N/A	18-20	18-20	18-20	18
48 x 264	N/A	N/A	20-22	20-22	20-22	20
48 x 288	N/A	N/A	22-24	22-24	22-24	22

BASE OPTIONS

Laminate

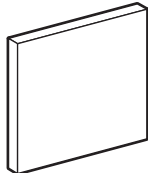

slab

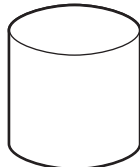

drum

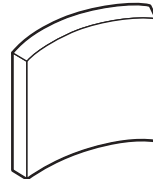

arch

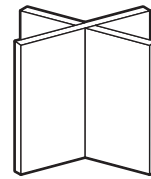

cross



self edge

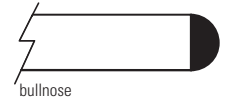

bullnose

Metal



2-leg



4-leg

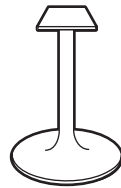

trumpet

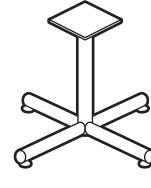

tube



T-mold

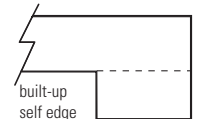

built-up self edge

T-mold matching edge available - add 5% upcharge.

TABLE TOP STYLES



square

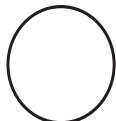

round

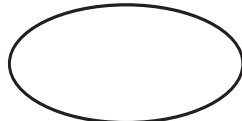

elliptical



racetrack

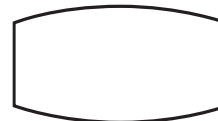

boat



rectangular

B BOARDROOM & CAFETERIA TABLES

ROUND TOPS	MODEL #	DIMENSIONS	WT/LB.	CUBIC FT.	LIST PRICE	BCH / CHM	ACO / SBR
------------	---------	------------	--------	-----------	------------	-----------	-----------

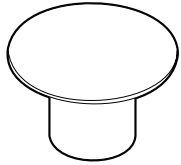

Round Top - Drum Base*

	W x D x H						
42CZ	42 x - x 29	150	12.5	\$1144	N/A	N/A	
48CZ	48 x - x 29	145	13.25	\$1264	N/A	N/A	
60CZ	60 x - x 29	194	19	\$1662	N/A	N/A	

Please specify edge detail: self edge (**SE**), bullnose (**BN**), T-mold (**TM**) or built-up (**BU**).

Shipped easy to assemble in 2 cartons.

- All drum bases require approximately 50 lbs. of sand in each base for adequate stability. Sand is not included.



Round Top - Three Legs*

48C	48 x - x 29	99	6.5	\$1309	N/A	N/A	
60C	60 x - x 29	140	14.4	\$1534	N/A	N/A	

Please specify edge detail: self edge (**SE**), bullnose (**BN**), T-mold (**TM**) or built-up (**BU**).

Shipped easy to assemble in 2 cartons.



Round Top - Three Tubular Legs*

60RC	60 x - x 29	140	14.4	\$1769	N/A	N/A	
------	-------------	-----	------	---------------	-----	-----	--

Please specify edge detail: self edge (**SE**), bullnose (**BN**), T-mold (**TM**) or built-up (**BU**).

Shipped easy to assemble in 2 cartons.



Round Top - Four Leg Base

CAR30	30 x - x 29.5	35	9.49	\$431	\$40	\$242	
CAR36	36 x - x 29.5	42	12.31	\$538	\$73	\$273	
CAR42	42 x - x 29.5	52	12.61	\$621	\$73	\$273	

Please specify edge detail: self edge (**SE**), bullnose (**BN**), T-mold (**TM**) or built-up (**BU**).

Shipped easy to assemble in 2 cartons.

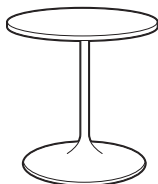

Round Top - Trumpet Base

TCR24	24 x - x 29.5	30	9.09	\$497	\$73	\$299	
TCR30	30 x - x 29.5	35	9.49	\$590	\$73	\$299	
TCR36	36 x - x 29.5	42	12.31	\$707	\$73	\$299	
TCR42	42 x - x 29.5	52	12.61	\$787	\$73	\$299	

Please specify edge detail: self edge (**SE**), bullnose (**BN**), T-mold (**TM**) or built-up (**BU**).

Shipped easy to assemble in 2 cartons.

Required specifications

Top finish
Base finish
Edge detail

Optional specifications

Grommet*
Power block cut-out*

Accessories

Power block*

ROUND TOPS



Round Top - Tubular Base

MODEL #	DIMENSIONS W x D x H	WT/LB.	CUBIC FT.	LIST PRICE	BCH / CHM	ACO / SBR
CRR24	24 x - x 29.5	30	9.09	\$417	\$78	\$327
CRR30	30 x - x 29.5	35	9.49	\$526	\$78	\$327
CRR36	36 x - x 29.5	42	12.31	\$630	\$78	\$327
CRR42	42 x - x 29.5	52	12.61	\$718	\$78	\$327
CRR48	48 x - x 29.5	10	13.26	\$863	\$78	\$327

Please specify edge detail: self edge (**SE**), bullnose (**BN**), T-mold (**TM**) or built-up (**BU**).
Shipped easy to assemble in 2 cartons.



Round Top - Cross Base*

42CX	42 x - x 29	100	3.5	\$1144	N/A	N/A
48CX	48 x - x 29	120	4.25	\$1264	N/A	N/A
60CX	60 x - x 29	144	6.2	\$1662	N/A	N/A

Please specify edge detail: self edge (**SE**), bullnose (**BN**), T-mold (**TM**) or built-up (**BU**).
Shipped easy to assemble in 2 cartons.

SQUARE TOPS

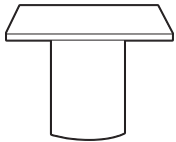

Square Top - Drum Base*

42SZ	42 x 42 x 29	100	12.5	\$1144	N/A	N/A
48SZ	48 x 48 x 29	160	13.16	\$1264	N/A	N/A
60SZ	60 x 60 x 29	190	19	\$1662	N/A	N/A

Please specify edge detail: self edge (**SE**), bullnose (**BN**), T-mold (**TM**) or built-up (**BU**).
Shipped easy to assemble in 2 cartons.

- All drum bases require approximately 50 lbs. of sand in each base for adequate stability. Sand is not included.

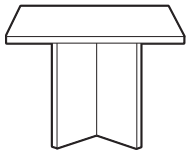

Square Top - Cross Base*

42SH	42 x 42 x 29	100	3.5	\$1144	N/A	N/A
48SH	48 x 48 x 29	120	4.25	\$1264	N/A	N/A
60SH	60 x 60 x 29	144	6.2	\$1662	N/A	N/A

Please specify edge detail: self edge (**SE**), bullnose (**BN**), T-mold (**TM**) or built-up (**BU**).
Shipped easy to assemble in 2 cartons.



Square Top - Four Leg Base

CAS30	30 x 30 x 29.5	37	9.49	\$431	\$40	\$242
CAS36	36 x 36 x 29.5	44	12.31	\$538	\$73	\$273
CAS42	42 x 42 x 29.5	54	12.61	\$621	\$73	\$273

Please specify edge detail: self edge (**SE**), bullnose (**BN**), T-mold (**TM**) or built-up (**BU**).
Shipped easy to assemble in 2 cartons.



Square Top - Trumpet Base

TCS24	24 x 24 x 29.5	32	9.09	\$497	\$73	\$299
TCS30	30 x 30 x 29.5	37	9.49	\$590	\$73	\$299
TCS36	36 x 36 x 29.5	44	12.31	\$707	\$73	\$299
TCS42	42 x 42 x 29.5	54	12.61	\$787	\$73	\$299

Please specify edge detail: self edge (**SE**), bullnose (**BN**), T-mold (**TM**) or built-up (**BU**).
Shipped easy to assemble in 2 cartons.

Required specifications

Top finish
Base finish
Edge detail

Optional specifications

Grommet*
Power block cut-out*

Accessories

Power block*

B BOARDROOM & CAFETERIA TABLES

SQUARE TOPS



Square Top - Tubular Base

MODEL #	DIMENSIONS W x D x H	WT/LB.	CUBIC FT.	LIST PRICE	BCH / CHM	ACO / SBR
CRS30	30 x 30 x 29.5	37	9.49	\$526	\$78	\$327
CRS36	36 x 36 x 29.5	44	12.31	\$630	\$78	\$327
CRS42	42 x 42 x 29.5	54	12.61	\$718	\$78	\$327

Please specify edge detail: self edge (**SE**), bullnose (**BN**), T-mold (**TM**) or built-up (**BU**).
Shipped easy to assemble in 2 cartons.

RECTANGULAR TOPS

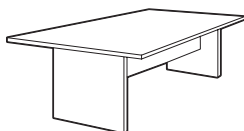

Rectangular Top - Two Slab Bases*

CT6RX	72 x 36 x 29	114	4.6	\$1811	N/A	N/A
CT8RX	96 x 36 x 29	144	7.3	\$1945	N/A	N/A
CT8WRX	96 x 48 x 29	154	7.3	\$2064	N/A	N/A

Please specify edge detail: self edge (**SE**), bullnose (**BN**), T-mold (**TM**) or built-up (**BU**).
Shipped easy to assemble in 3 cartons (except CT6RX shipped easy to assemble in 2 cartons).

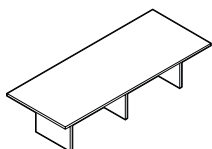

Rectangular Top - Three Slab Bases*

CT10RX	120 x 36 x 29	216	8.25	\$2968	N/A	N/A
CT10WRX	120 x 48 x 29	251	8.75	\$3330	N/A	N/A
CT12WRX	144 x 48 x 29	276	10.6	\$3499	N/A	N/A

Please specify edge detail: self edge (**SE**), bullnose (**BN**), T-mold (**TM**) or built-up (**BU**).
Shipped easy to assemble in 2 cartons.

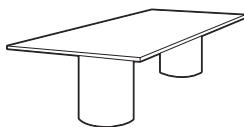

Rectangular Top - Two Drum Bases*

CT6RZ	72 x 36 x 29	164	15.32	\$2064	N/A	N/A
CT8RZ	96 x 36 x 29	194	16.35	\$2193	N/A	N/A
CT8WRZ	96 x 48 x 29	204	17.7	\$2324	N/A	N/A

Please specify edge detail: self edge (**SE**), bullnose (**BN**), T-mold (**TM**) or built-up (**BU**).
Shipped easy to assemble in 2 cartons.
• All drum bases require approximately 50 lbs. of sand in each base for adequate stability. Sand is not included.

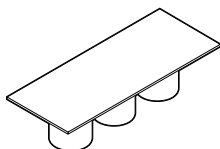

Rectangular Top - Three Drum Bases*

CT10RZ	120 x 36 x 29	291	23.65	\$3206	N/A	N/A
CT10WRZ	120 x 48 x 29	326	25.3	\$3563	N/A	N/A
CT12WRZ	144 x 48 x 29	351	26.67	\$3766	N/A	N/A

Please specify edge detail: self edge (**SE**), bullnose (**BN**), T-mold (**TM**) or built-up (**BU**).
Shipped easy to assemble in 2 cartons.
• All drum bases require approximately 50 lbs. of sand in each base for adequate stability. Sand is not included.

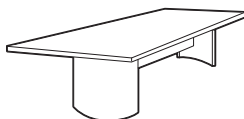

Rectangular Top - Two Arch Bases*

CT6RA	72 x 36 x 29	114	5.6	\$2064	N/A	N/A
CT8RA	96 x 36 x 29	144	7.1	\$2193	N/A	N/A
CT8WRA	96 x 48 x 29	154	10.15	\$2324	N/A	N/A
CT10RA	120 x 36 x 29	174	9.85	\$3206	N/A	N/A
CT10WRA	120 x 48 x 29	184	11.5	\$3563	N/A	N/A
CT12WRA	144 x 48 x 29	194	13.25	\$3766	N/A	N/A

Please specify edge detail: self edge (**SE**), bullnose (**BN**), T-mold (**TM**) or built-up (**BU**).
Shipped easy to assemble in 3 cartons (except CT6RA shipped easy to assemble in 2 cartons).

Required specifications

Top finish
Base finish (square tops)
Edge detail

Optional specifications

Grommet*
Power block cut-out*

Accessories

Power block*

RECTANGULAR TOPS



Rectangular Top - Two Legs

MODEL #	DIMENSIONS W x D x H	WT/LB.	CUBIC FT.	LIST PRICE
CT6R	72 x 36 x 29	110	13.75	\$1202
CT8R	96 x 36 x 29	140	14.75	\$1357
CT8WR	96 x 48 x 29	150	16.25	\$1490

Please specify edge detail: self edge (**SE**), bullnose (**BN**), T-mold (**TM**) or built-up (**BU**).
Shipped easy to assemble in 2 cartons.

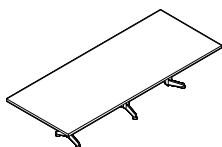

Rectangular Top - Three Legs

CT10R	120 x 36 x 29	210	15.75	\$1921
CT10WR	120 x 48 x 29	245	17.5	\$2321
CT12WR	144 x 48 x 29	270	19	\$2510

Please specify edge detail: self edge (**SE**), bullnose (**BN**), T-mold (**TM**) or built-up (**BU**).
Shipped easy to assemble in 2 cartons.



Rectangular Top - Two Tubular Legs

CR6R	72 x 36 x 29	110	13.75	\$1357
CR8R	96 x 36 x 29	10	14.75	\$1521
CR8WR	96 x 48 x 29	150	16.25	\$1648

Please specify edge detail: self edge (**SE**), bullnose (**BN**), T-mold (**TM**) or built-up (**BU**).
Shipped easy to assemble in 2 cartons.

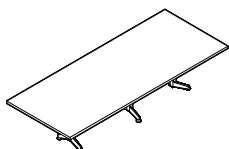

Rectangular Top - Three Tubular Legs

CR10R	120 x 36 x 29	210	15.75	\$2151
CR10WR	120 x 48 x 29	245	17.5	\$2558
CR12WR	144 x 48 x 29	270	19	\$2748

Please specify edge detail: self edge (**SE**), bullnose (**BN**), T-mold (**TM**) or built-up (**BU**).
Shipped easy to assemble in 2 cartons.

BOAT TOPS



Boat Top - Two Slab Bases

CT6BX	72 x 36 x 29	114	4.6	\$1811
CT8BX	96 x 36 x 29	144	7.3	\$1945
CT8WBX	96 x 48 x 29	154	7.3	\$2064

Please specify edge detail: self edge (**SE**), bullnose (**BN**), T-mold (**TM**) or built-up (**BU**).
Shipped easy to assemble in 3 cartons (except CT6BX shipped easy to assemble in 2 cartons).

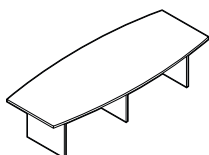

Boat Top - Three Slab Bases

CT10BX	120 x 36 x 29	216	8.25	\$2968
CT10WBX	120 x 48 x 29	251	8.25	\$3330
CT12WBX	144 x 48 x 29	276	10.6	\$3499

Please specify edge detail: self edge (**SE**), bullnose (**BN**), T-mold (**TM**) or built-up (**BU**).
Shipped easy to assemble in 3 cartons.

Required specifications

Top finish
Base finish (rectangular tops)
Edge detail

Optional specifications

Grommet
Power block cut-out

Accessories

Power block

B BOARDROOM & CAFETERIA TABLES

BOAT TOPS

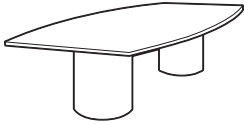

Boat Top - Two Drum Bases

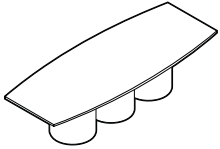

Boat Top - Three Drum Bases

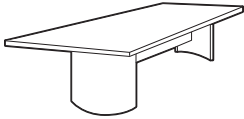

Boat Top - Two Arch Bases



Boat Top - Two Legs*

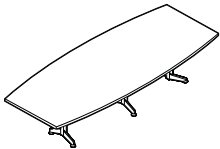

Boat Top - Three Legs*



Boat Top - Two Tubular Legs*

MODEL #	DIMENSIONS	WT/LB.	CUBIC FT.	LIST PRICE
---------	------------	--------	-----------	------------

W x D x H

CT6BZ	72 x 36 x 29	164	15.32	\$1993
CT8BZ	96 x 36 x 29	194	16.35	\$2193
CT8WBZ	96 x 48 x 29	204	17.7	\$2244

Please specify edge detail: self edge (**SE**), bullnose (**BN**), T-mold (**TM**) or built-up (**BU**).

Shipped easy to assemble in 2 cartons.

- All drum bases require approximately 50 lbs. of sand in each base for adequate stability. Sand is not included.

CT10BZ	120 x 36 x 29	291	23.65	\$3206
CT10WBZ	120 x 48 x 29	326	25.3	\$3563
CT12WBZ	144 x 48 x 29	351	26.67	\$3734

Please specify edge detail: self edge (**SE**), bullnose (**BN**), T-mold (**TM**) or built-up (**BU**).

Shipped easy to assemble in 2 cartons.

- All drum bases require approximately 50 lbs. of sand in each base for adequate stability. Sand is not included.

CT6BA	72 x 36 x 29	114	5.6	\$2064
CT8BA	96 x 36 x 29	144	7.1	\$2193
CT8WBA	96 x 48 x 29	154	10.15	\$2324
CT10BA	120 x 36 x 29	174	9.85	\$3206
CT10WBA	120 x 48 x 29	184	11.5	\$3563
CT12WBA	144 x 48 x 29	194	13.25	\$3734

Please specify edge detail: self edge (**SE**), bullnose (**BN**), T-mold (**TM**) or built-up (**BU**).

Shipped easy to assemble in 3 cartons, (except CT6BA shipped easy to assemble in 2 cartons).

CT6B	72 x 36 x 29	110	13.75	\$1202
CT8B	96 x 36 x 29	140	14.75	\$1357
CT8WB	96 x 48 x 29	150	16.25	\$1490

Please specify edge detail: self edge (**SE**), bullnose (**BN**), T-mold (**TM**) or built-up (**BU**).

Shipped easy to assemble in 2 cartons.

CT10B	120 x 36 x 29	210	15.75	\$1921
CT10WB	120 x 48 x 29	245	17.5	\$2321
CT12WB	144 x 48 x 29	270	19	\$2510

Please specify edge detail: self edge (**SE**), bullnose (**BN**), T-mold (**TM**) or built-up (**BU**).

Shipped easy to assemble in 2 cartons.

CR6B	72 x 36 x 29	110	13.75	\$1357
CR8B	96 x 36 x 29	140	14.75	\$1503
CR8WB	96 x 48 x 29	150	16.25	\$1648

Please specify edge detail: self edge (**SE**), bullnose (**BN**), T-mold (**TM**) or built-up (**BU**).

Shipped easy to assemble in 2 cartons.

Required specifications

Top finish
Leg finish*
Edge detail

Optional specifications

Grommet
Power block cut-out

Accessories

Power block

BOAT TOPS



Boat Top - Three Tubular Legs*

MODEL #	DIMENSIONS W x D x H	WT/LB.	CUBIC FT.	LIST PRICE
CR10B	120 x 36 x 29	210	20	\$2151
CR10WB	120 x 48 x 29	245	23	\$2558
CR12WB	144 x 48 x 29	270	19	\$2748

Please specify edge detail: self edge (**SE**), bullnose (**BN**), T-mold (**TM**) or built-up (**BU**).
Shipped easy to assemble in 2 cartons.

RACETRACK TOPS

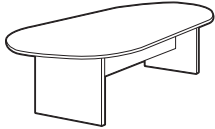

Racetrack Top - Two Slab Bases

RT6X	72 x 36 x 29	114	4.6	\$1811
RT8X	96 x 36 x 29	144	7.3	\$1945
RT8WX	96 x 48 x 29	154	7.3	\$2064

Please specify edge detail: self edge (**SE**), bullnose (**BN**), T-mold (**TM**) or built-up (**BU**).
Shipped easy to assemble in 3 cartons (except RT6X shipped easy to assemble in 2 cartons).

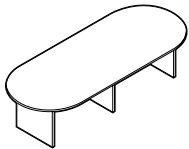

Racetrack Top - Three Slab Bases

RT10X	120 x 36 x 29	216	8.25	\$2968
RT10WX	120 x 48 x 29	251	8.75	\$3330
RT12WX	144 x 48 x 29	276	10.6	\$3499

Please specify edge detail: self edge (**SE**), bullnose (**BN**), T-mold (**TM**) or built-up (**BU**).
Shipped easy to assemble in 3 cartons.

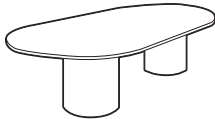

Racetrack Top - Two Drum Bases

RT6Z	72 x 36 x 29	164	15.32	\$2064
RT8Z	96 x 36 x 29	194	16.35	\$2193
RT8WZ	96 x 48 x 29	204	17.7	\$2324

Please specify edge detail: self edge (**SE**), bullnose (**BN**), T-mold (**TM**) or built-up (**BU**).
Shipped easy to assemble in 2 cartons.
• All drum bases require approximately 50 lbs. of sand in each base for adequate stability. Sand is not included.

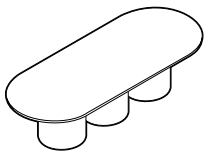

Racetrack Top - Three Drum Bases

RT10Z	120 x 36 x 29	291	23.65	\$3206
RT10WZ	120 x 48 x 29	326	25.3	\$3563
RT12WZ	144 x 48 x 29	351	26.67	\$3734

Please specify edge detail: self edge (**SE**), bullnose (**BN**), T-mold (**TM**) or built-up (**BU**).
Shipped easy to assemble in 3 cartons.
• All drum bases require approximately 50 lbs. of sand in each base for adequate stability. Sand is not included.

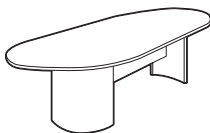

Racetrack Top - Two Arch Bases

RT6A	72 x 36 x 29	114	5.6	\$1993
RT8A	96 x 36 x 29	144	7.1	\$2193
RT8WA	96 x 48 x 29	154	10.15	\$2244
RT10A	120 x 36 x 29	174	9.85	\$3206
RT10WA	120 x 48 x 29	184	11.5	\$3563
RT12WA	144 x 48 x 29	194	13.25	\$3734

Please specify edge detail: self edge (**SE**), bullnose (**BN**), T-mold (**TM**) or built-up (**BU**).
Shipped easy to assemble in 3 cartons (except RT6A shipped easy to assemble in 2 cartons).

Required specifications

Top finish
Leg finish*
Edge detail

Optional specifications

Grommet
Power block cut-out

Accessories

Power block

B BOARDROOM & CAFETERIA TABLES

RACETRACK TOPS



Racetrack Top - Two Legs*

MODEL #	DIMENSIONS W x D x H	WT/LB.	CUBIC FT.	LIST PRICE
RT6	72 x 36 x 29	110	13.75	\$1202
RT8	96 x 36 x 29	140	14.75	\$1357
RT8W	96 x 48 x 29	150	16.25	\$1490

Please specify edge detail: self edge (**SE**), bullnose (**BN**), T-mold (**TM**) or built-up (**BU**).
Shipped easy to assemble in 2 cartons.

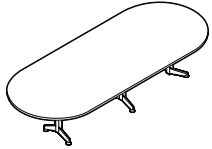

Racetrack Top - Three Legs*

RT10	120 x 36 x 29	210	15.75	\$1921
RT10W	120 x 48 x 29	245	17.5	\$2321
RT12W	144 x 48 x 29	270	19	\$2510

Please specify edge detail: self edge (**SE**), bullnose (**BN**), T-mold (**TM**) or built-up (**BU**).
Shipped easy to assemble in 2 cartons.



Racetrack Top - Two Tubular Legs*

RT6R	72 x 36 x 29	110	13.75	\$1357
RT8R	96 x 36 x 29	140	14.75	\$1503
RT8WR	96 x 48 x 29	150	16.25	\$1648

Please specify edge detail: self edge (**SE**), bullnose (**BN**), T-mold (**TM**) or built-up (**BU**).
Shipped easy to assemble in 2 cartons.



Racetrack Top - Three Tubular Legs*

RT10R	120 x 36 x 29	210	15.75	\$2151
RT10WR	120 x 48 x 29	245	17.5	\$2558
RT12WR	144 x 48 x 29	270	19	\$2748

Please specify edge detail: self edge (**SE**), bullnose (**BN**), T-mold (**TM**) or built-up (**BU**).
Shipped easy to assemble in 2 cartons.

ELLIPTICAL TOPS

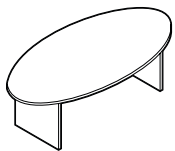

Elliptical Top - Two Slab Bases

EL6X	72 x 36 x 29	114	4.6	\$1811
EL8X	96 x 36 x 29	144	7.3	\$1945
EL8WX	96 x 48 x 29	154	7.3	\$2064

Please specify edge detail: self edge (**SE**), bullnose (**BN**), T-mold (**TM**) or built-up (**BU**).
Shipped easy to assemble in 3 cartons (except EL6X shipped easy to assemble in 2 cartons).

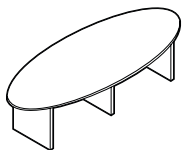

Elliptical Top - Three Slab Bases

EL10X	120 x 36 x 29	216	8.25	\$2968
EL10WX	120 x 48 x 29	251	8.75	\$3330
EL12WX	144 x 48 x 29	276	10.6	\$3499

Please specify edge detail: self edge (**SE**), bullnose (**BN**), T-mold (**TM**) or built-up (**BU**).
Shipped easy to assemble in 2 cartons.

Required specifications

Top finish
Leg finish*
Edge detail

Optional specifications

Grommet
Power block cut-out

Accessories

Power block

ELLIPTICAL TOPS

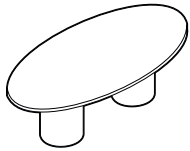

Elliptical Top - Two Drum Bases

MODEL #	DIMENSIONS	WT/LB.	CUBIC FT.	LIST PRICE
W x D x H				
EL6Z	72 x 36 x 29	164	15.32	\$2064
EL8Z	96 x 36 x 29	194	16.35	\$2193
EL8WZ	96 x 48 x 29	204	17.7	\$2324

Please specify edge detail: self edge **(SE)**, bullnose **(BN)**, T-mold **(TM)** or built-up **(BU)**.
Shipped easy to assemble in 2 cartons.

- All drum bases require approximately 50 lbs. of sand in each base for adequate stability. Sand is not included.

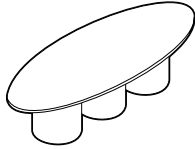

Elliptical Top - Three Drum Bases

EL10Z	120 x 36 x 29	291	23.65	\$3206
EL10WZ	120 x 48 x 29	326	25.3	\$3563
EL12WZ	144 x 48 x 29	351	26.67	\$3734

Please specify edge detail: self edge **(SE)**, bullnose **(BN)**, T-mold **(TM)** or built-up **(BU)**.
Shipped easy to assemble in 2 cartons.

- All drum bases require approximately 50 lbs. of sand in each base for adequate stability. Sand is not included.

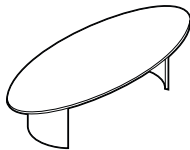

Elliptical Top - Two Arch Bases

EL6A	72 x 36 x 29	114	5.6	\$2064
EL8A	96 x 36 x 29	144	7.1	\$2193
EL8WA	96 x 48 x 29	154	10.15	\$2324
EL10A	120 x 36 x 29	174	9.85	\$3206
EL10WA	120 x 48 x 29	184	11.5	\$3563
EL12WA	144 x 48 x 29	194	13.25	\$3734

Please specify edge detail: self edge **(SE)**, bullnose **(BN)**, T-mold **(TM)** or built-up **(BU)**.
Shipped easy to assemble in 3 cartons (except EL6A shipped easy to assemble in 2 cartons).

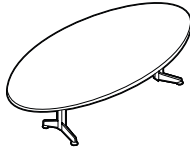

Elliptical Top - Two Legs*

EL6	72 x 36 x 29	110	13.75	\$1202
EL8	96 x 36 x 29	140	14.75	\$1357
EL8W	96 x 48 x 29	150	16.25	\$1490

Please specify edge detail: self edge **(SE)**, bullnose **(BN)**, T-mold **(TM)** or built-up **(BU)**.
Shipped easy to assemble in 2 cartons.

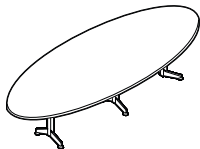

Elliptical Top - Three Legs*

EL10	120 x 36 x 29	210	15.75	\$1921
EL10W	120 x 48 x 29	245	17.5	\$2321
EL12W	144 x 48 x 29	270	19	\$2510

Please specify edge detail: self edge **(SE)**, bullnose **(BN)**, T-mold **(TM)** or built-up **(BU)**.
Shipped easy to assemble in 2 cartons.



Elliptical Top - Two Tubular Legs*

EL6R	72 x 36 x 29	110	13.75	\$1357
EL8R	96 x 36 x 29	140	14.75	\$1503
EL8WR	96 x 48 x 29	150	16.25	\$1648

Please specify edge detail: self edge **(SE)**, bullnose **(BN)**, T-mold **(TM)** or built-up **(BU)**.
Shipped easy to assemble in 2 cartons.

Required specifications

Top finish
Leg finish*
Edge detail

Optional specifications

Grommet
Power block cut-out

Accessories

Power block

B BOARDROOM & CAFETERIA TABLES

ELLIPTICAL TOPS

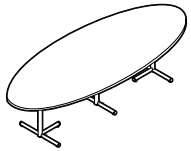

Elliptical Top - Three Tubular Legs*

MODEL

DIMENSIONS

WT/LB.

CUBIC FT.

LIST PRICE

W x D x H

MODEL #	DIMENSIONS W x D x H	WT/LB.	CUBIC FT.	LIST PRICE
EL10R	120 x 36 x 29	210	15.75	\$2151
EL10WR	120 x 48 x 29	245	17.5	\$2558
EL12WR	144 x 48 x 29	270	19	\$2748

Please specify edge detail: self edge (**SE**), bullnose (**BN**), T-mold (**TM**) or built-up (**BU**).
Shipped easy to assemble in 2 cartons.

Required specifications

Top finish
Leg finish*
Edge detail*

Optional specifications

Grommet
Power block cut-out

Accessories

Power block

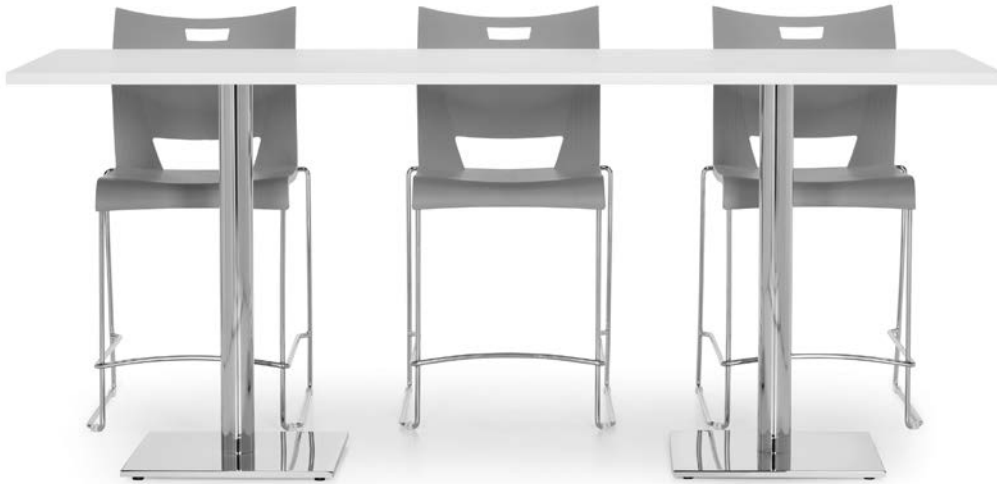

Global's Swap collection is a comprehensive offering including laptop tables, casual meeting tables, café tables, huddle tables and more. Suitable for a variety of applications: break rooms, dedicated/enclosed meeting rooms, casual/open area meeting spaces (lounge, seated, counter and bar height options), and private office (accommodate smaller 3-4 person discussions). Tops and bases are sold separately for ease of specification. Mix and match capabilities to create spaces for multi-purpose use. Choose your top, choose your base. Create the combination you desire for the way you want to work.

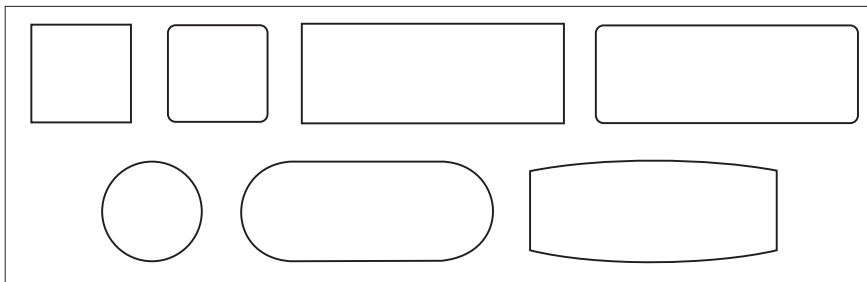

Top shapes

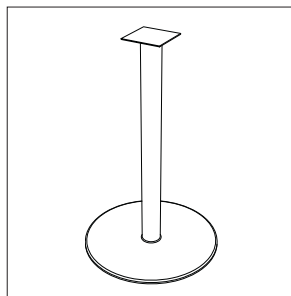

Round base

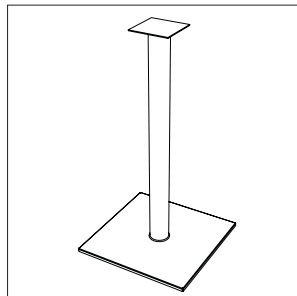

Square base

Features and Benefits

- Tops are available in four materials to help perfect your interior design: thermally fused laminate, high pressure laminate, veneer and solid surface.
- **High performance thermally fused laminate** tops are 1" thick with a 45 lb. density particle board core and feature 2mm thick edgeband.
- **High pressure laminate** tops are 1 1/16" thick with 2mm flat edge or 1 3/16" thick with knife edge profile. Tops with flat edge have a 45 lb. density particle board core; tops with knife edge have a MDF core.
- **Veneer** tops are 1 3/16" thick overall with matching flat edge or knife edge.
- **Solid surface** tops are 1 1/4" thick with a plywood or particle board melamine subtop depending on size, available with flat edge or knife edge.
- Bases are constructed of a solid steel metal plate and cover - round or square.
- Power block cut-outs are available on most tables.
- 6 heights:
Coffee table height at 16"H.
End table height at 22"H.
Lounge height at 27"H.
Seated height at 29"H.
Counter height at 36"H.
Bar height at 41.5"H.

GENERAL INFORMATION

- Swap is a series of tables for use in casual meeting spaces, lounges, café areas and more.
- The right proportions, flawless surfaces and a solid foundation is sure to become your favorite table series to spec.
- Finish palette coordinates with most Global laminate and veneer casegoods series as well as a variety of solid surface options to choose from - tables can stand-alone or blend with other solutions.
- Each component is packed individually. Bases are shipped assembled, 1 per carton. Easy to assemble.
- For environmental certifications, please visit globalfurnituregroup.com.

WORKSURFACES

- Four material choices: high performance thermally fused laminate, high pressure laminate, veneer and solid surface.
- **Thermally fused laminate** tops are 1" thick overall with a 45 lb. density particle board core and feature 2mm thick edgeband. Edgeband finish can be specified to match or contrast the surface finish.
- **High pressure laminate** tops are 1 1/16" thick with 2mm flat edge or 1 3/16" thick with knife edge. 1 1/16" thick tops have a 45 lb. density particle board core and the 2mm flat edge finish can be specified to match or complement the top surface. 1 3/16" thick tops have an MDF core and the knife edge finish will match top surface. Models ending in **(LK)** indicate high pressure laminate with knife edge.
- **Veneer** tops are 1 3/16" thick overall with choice of edge detail - flat edge or knife edge. Edge finish will correspond to surface finish. When flat edge, core material is 45 lb. density particle board; when knife edge, core material is MDF. Models ending in **(V)** indicate veneer.
- **Solid surface** tops are 1 1/4" thick overall with choice of edge detail - flat edge or knife edge. Solid surface material is 0.5" thick with built up edge profile over a particle board or plywood subtop depending on overall top size. Models ending in **(SF)** indicate solid surface with flat edge; models ending in **(SK)** indicate solid surface with knife edge.
- Please see model # for pricing and availability of various material and edge options.
- Refer to page 323 or globalfurnituregroup.com for available finish options.
- While not all sizes are available in all materials:
 - Worksurfaces of 96" or less in length are standard in one piece (1 carton).
 - Worksurfaces 120" to 144" in length are standard in two pieces (2 cartons).
 - Worksurfaces 96", 120" and 144" x 48" include support channels.

BASES

- **Caution:** to meet BIFMA standards for performance and stability, appropriate base size must be specified with corresponding top sizes identified. **Top plates and base plates vary by base size and will only work with table shape sizes as referenced on the following pages.**
- Bases are constructed of a round or square solid steel metal plate for counter balance, covered with a finished steel shroud, affixed with four bolts to a cold rolled steel tube.
- GRB14H25 attaches to tops with a 6" x 6" steel plate, welded to a 1.5" diameter steel tube, bolted to a 0.5" thick solid steel counter balance. Not to be used on tops greater than 22" x 22" in size.
- GSB13H25 and GSOB13H25 attach to tops with a 6" x 6" steel plate, welded to a 1.5" diameter steel tube, bolted to a 0.5" thick solid steel counter balance. Not to be used on tops greater than 22" x 22" in size.
- GRB22H15, GRB22H21, GRB22H26, GRB22, GRB22H35, GRB22H41, GSB19H15, GSB19H21, GSB19H26, GSB19, GSB19H35 and GSB19H41 attach to tops with a 6" x 6" steel plate, welded to a 3" diameter steel tube, bolted to a 0.5" thick solid steel counter balance.
- Top plate and base plate of GRB22 and GSB19 models in all heights, have pass-through cut-outs to accommodate a single port simplex or dual USB module to deliver power or USB charging to the surface. This allows the module to be mounted directly above the base and to pass the unit's cord through the base column resulting in the cord and plug head exiting from the bottom of the base for plugging into a floor or wall mount power source.
- GRB28, GRB34, GSB23 and GSB28 attach to tops with an 11" x 11" steel plate, welded to a 4" diameter steel tube, bolted to a 0.375" thick solid steel counter balance.
- Bases are available PAINTED in "Sandtex" finish for extra durability. Also available in plated finishes (see page 323) at an upcharge and with an extended lead time. Please see model # for pricing.
- All bases come with six height adjustable glides with 0.75" of adjustability.
- Round bases available in 22", 28" and 34" dia.
- Square bases available in 18.5", 22.5" and 28.5".

1. SPECIFY MODEL NUMBER

2. SPECIFY FINISH

Laminate finishes (thermally fused and high pressure laminate):

ACJ Absolute Acajou	FCL First Class
ASN Asian Night	NBL Noce Biondo
AWC Avant Cherry	NGL Noce Grigio
AWH Avant Honey	NEL Noce Leggero
BLK Black	NML Noce Medio
BZD Blizzard	QTM Quartered Mahogany
BRC Brushed Cobalt	SBY Sheer Beauty
CMB Clear Maple	SDT Stonedust
CGY Custom Grey	SOG Storm Grey
DES Dark Espresso	WHE Walnut Heights
DWT Designer White	WHC White Chocolate
FAS Fashionista	WCR Winter Cherry

Veneer finishes (applicable for models ending in **V** only):

AMW Almond Cherry	LTW Latte
ACW Amber Cherry	MHW Mahogany on Walnut
BTW Biscotti	MPW Natural Maple
CAW Cocoa Walnut	MTW Milestone
CRW Coral	NLW Natural Walnut
DCW Dark Cherry	RCW Red Cherry
DWW Dark Walnut	ULW Umber Walnut
EWV Espresso	VNW Vintage Cherry
EVW Evening Oak	WLW Walnut
GRW Grey on Oak	WMW White Maple
HAW Hazelnut	WCW Warm Cherry
JAW Java	

Solid surface (applicable for models ending in **SF** or **SK** only):

Grade 1	Grade 2
SWH Designer White	SBT Beige Tempest
	SBX Black Onyx Mirage
	SFW Frosty White Mirage
	SHS Hot Stone
	SMG Milk Glass Spectra
	SNM Northern Melange

Bases (paint finishes):

TBL Black	TIN Ink
TBZ Buzz Blue	TKA Kalua
TCC Cactus	TLA Latte
TCR Carrot	TMO Mocha
TIV Cloud	TNE Nevada
TDW Designer White	TSN Sand
TDJ Dijon	TSR Scarlet
TEG Eggplant	TSH Shadow
TFO Fog	TOA Toast
TFR Frost	TTU Tungsten

Bases (plated finishes - upcharge applies):

ACO Antique Copper	CHM Chrome
BCH Brushed Chrome	SBR Satin Brass

3. SPECIFY EDGE PROFILE (where applicable)

- Thermally fused laminate and high pressure with flat edge tops:
 - Flat edge (FE) - default profile
 - 3" radiused corners (R3) - optional for square and rectangular tops, upcharge applies
- High pressure laminate tops (models ending in **LK**):
 - Knife edge only
 - 3" radiused corners available by quote request only
- Veneer tops (models ending in **V**):
 - Flat edge (FE) - default profile
 - Knife edge (KS) - optional
 - 3" radiused corners available by quote request only
- Solid surface tops (models ending is **SF**):
 - Flat edge (FE) - default profile
 - 3" radiused corners (R3) - optional for square and rectangular tops, upcharge applies
- Solid surface tops (models ending is **SK**):
 - Knife edge (KS) - default profile
 - Knife edge with 3" radiused corners (KR) - optional for square and rectangular tops, upcharge applies

4. SPECIFY EDGE FINISH

Edge finish only applicable for thermally fused laminate and high pressure tops with flat edge (FE)

AAE Absolute Acajou	CGY Custom Grey	NML Noce Medio
ASE Asian Night	DEE Dark Espresso	QTM Quarter Mahogany
ACE Avant Cherry	DWE Designer White	SAR Scarlet
AHE Avant Honey	DJN Dijon	SHW Shadow
BLK Black	FAS Fashionista	SBY Sheer Beauty
BZD Blizzard	FCL First Class	SDT Stonedust
BRC Brushed Cobalt	FOG Fog	SOG Storm Grey
BZB Buzz Blue	LAB Latte	WHE Walnut Heights
CCT Cactus	NBL Noce Biondo	CBE White Chocolate
CRO Carrot	NGL Noce Grigio	WCE Winter Cherry
CME Clear Maple	NEL Noce Leggero	

5. SPECIFY OPTIONS

POWER BLOCKS AND CUT-OUTS LOCATIONS

- A power block delivers power/data to the table surface.
- Power block modules are ordered separately.
- Not all power block locations are available on all table sizes. Please refer to the top/base chart on the following pages for more information.
- To purchase a power block, you must specify the power block cut-out location when ordering the top and order the power block separately.
- Optional cut-out available in standard worksurface locations (left, center or right) for all table shapes.
Example: Order as **E1, R1, T1**, etc. **Add \$91** for each cut-out.
- Cut-outs may be placed at non-standard locations. Please contact Customer Service.
- Select power block option from Productivity Solutions pages 467-470.
- Custom locations or cut-outs available (drawing required). **Add \$132.**

POWER BLOCK OPTIONS AND CUT-OUT LOCATIONS

(Power modules and blocks can be found in the Productivity Solutions section of the price list)

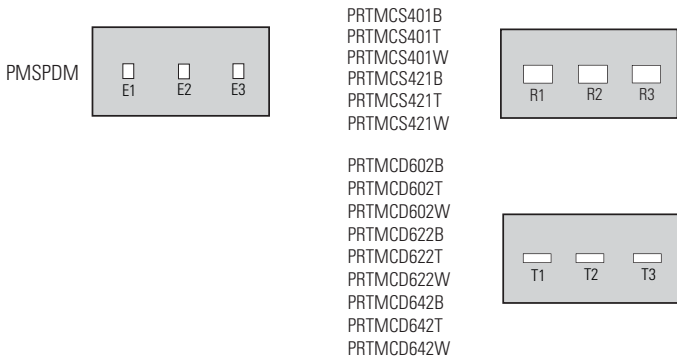

- Match power block desired with cut-out code and location from above grid.
- Example: If power block module # PRTMC401B is required in the center position, specify cut-out option R2 when specifying the top.

SINGLE PORT MODULES

- Single port module with one simplex or one dual USB charging port centered over the base, available for tops supported with single GRB22xx or GSB19xx base in any height
- Specify optional cut-out (**Q2**) to accommodate when specifying tops. **Add \$91** to list.
- Modules are listed on product pages with applicable tops and bases. Modules are ordered separately.

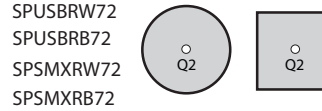

- For White colored modules, specify code ending in (**W72**); for Black colored modules, specify code ending in (**B72**).









SPECIFICATIONS



- Required and optional specifications marked with an * on the pricelist pages with products are applicable to only those products which have the * symbol beside the product name.

TABLE NOTES - ESTIMATED CAPACITY







- Use the following to determine the size of a table and the number of chairs needed for a conference area.
- All estimates are based on an average chair width of 23" with a 4" clearance between chairs. Adjust accordingly for a different chair size.

Top Size	Round	NUMBER OF CHAIRS				Racetrack
		Square	Rectangular	Boat		
24 x 24	2	2	N/A	N/A	N/A	
24 x 30	N/A	N/A	2-3	N/A	N/A	
24 x 36	N/A	N/A	3-4	N/A	N/A	
30 x 30	3	4	N/A	N/A	N/A	
30 x 36	N/A	N/A	4	N/A	N/A	
30 x 42	N/A	N/A	4	N/A	N/A	
36 x 36	4	4	N/A	N/A	N/A	
36 x 42	N/A	N/A	4	N/A	N/A	
42 x 42	4	4	N/A	N/A	N/A	
48 x 48	4	4	N/A	N/A	N/A	
54 x 54	5	6	N/A	N/A	N/A	
60 x 60	5	6	N/A	N/A	N/A	
24 x 60	N/A	N/A	4-6	N/A	4-6	
24 x 66	N/A	N/A	4-6	N/A	4-6	
24 x 72	N/A	N/A	4-6	N/A	4-6	
24 x 84	N/A	N/A	4-6	N/A	4-6	
24 x 96	N/A	N/A	6-8	N/A	6-8	
30 x 60	N/A	N/A	4-6	4-6	4-6	
30 x 66	N/A	N/A	4-6	4-6	4-6	
30 x 72	N/A	N/A	4-6	4-6	4-6	
30 x 84	N/A	N/A	4-6	4-6	4-6	
30 x 96	N/A	N/A	6-8	6-8	6-8	
36 x 60	N/A	N/A	4-6	4-6	4-6	
36 x 66	N/A	N/A	4-6	4-6	4-6	
36 x 72	N/A	N/A	4-6	4-6	4-6	
36 x 84	N/A	N/A	4-6	4-6	4-6	
36 x 96	N/A	N/A	6-8	6-8	6-8	
48 x 84	N/A	N/A	6-8	6-8	6-8	
48 x 96	N/A	N/A	6-8	6-8	6-8	
48 x 120	N/A	N/A	8-10	8-10	8-10	
48 x 144	N/A	N/A	10-12	10-12	10-12	

APPLICABLE BASE OPTIONS FOR CORRESPONDING TOP										POWER MGMT OPTIONS		
Table Shape/Size	Top #	Lounge Height 27"H		Seated Height 28.5"H		Counter Height 36"H		Bar Height 41.5"H		Base Qty.	# top pieces	Grommet and Power Block Cut-outs Available
		Round base 22" 	Square base 18.5" 	Round base 22", 28", 34" 	Square base 18.5", 22.5", 28.5" 	Round base 22" 	Square base 18.5" 	Round base 22" 	Square base 18.5" 			
Round ○ Nominal base plate dimension indicated by 4th and 5th characters in base model numbers												
24" diameter top	GRBTP24_	GRB22H26	GSB19H26	GRB22	GSB19	GRB22H35	GSB19H35	GRB22H41	GSB19H41	1	1	Q2 only
30" diameter top	GRBTP30_	GRB22H26	GSB19H26	GRB22	GSB19	GRB22H35	GSB19H35	GRB22H41	GSB19H41	1	1	Q2 only
36" diameter top	GRBTP36_	GRB22H26	GSB19H26	GRB22	GSB19	GRB22H35	GSB19H35	GRB22H41	GSB19H41	1	1	Q2 only
42" diameter top	GRBTP42_	N/A	N/A	GRB28	GSB23	N/A	N/A	N/A	N/A	1	1	None
48" diameter top	GRBTP48_	N/A	N/A	GRB28	GSB23	N/A	N/A	N/A	N/A	1	1	None
54" diameter top	GRBTP54_	N/A	N/A	GRB34	GSB28	N/A	N/A	N/A	N/A	1	1	None
60" diameter top	GRBTP60_	N/A	N/A	GRB34	GSB28	N/A	N/A	N/A	N/A	1	1	None
Square □												
24" square top	GSBTP24_	GRB22H26	GSB19H26	GRB22	GSB19	GRB22H35	GSB19H35	GRB22H41	GSB19H41	1	1	Q2 only
30" square top	GSBTP30_	GRB22H26	GSB19H26	GRB22	GSB19	GRB22H35	GSB19H35	GRB22H41	GSB19H41	1	1	Q2 only
36" square top	GSBTP36_	GRB22H26	GSB19H26	GRB22	GSB19	GRB22H35	GSB19H35	GRB22H41	GSB19H41	1	1	Q2 only
42" square top	GSBTP42_	N/A	N/A	GRB28	GSB23	N/A	N/A	N/A	N/A	1	1	None
Rectangular ▭												
30x24 Rectangular	GSBTP2430_	GRB22H26	GSB19H26	GRB22	GSB19	GRB22H35	GSB19H35	GRB22H41	GSB19H41	1	1	Q2 only
36x24 Rectangular	GSBTP2436_	GRB22H26	GSB19H26	GRB22	GSB19	GRB22H35	GSB19H35	GRB22H41	GSB19H41	1	1	Q2 only
36x30 Rectangular	GSBTP3036_	GRB22H26	GSB19H26	GRB22	GSB19	GRB22H35	GSB19H35	GRB22H41	GSB19H41	1	1	Q2 only
42x30 Rectangular	GSBTP3042_	N/A	N/A	GRB28	GSB23	N/A	N/A	N/A	N/A	1	1	None
42x36 Rectangular	GSBTP3642_	N/A	N/A	GRB28	GSB23	N/A	N/A	N/A	N/A	1	1	None
60x24 Rectangular	GRT5STP_	GRB22H26	GSB19H26	N/A	N/A	GRB22H35	GSB19H35	GRB22H41	GSB19H41	2	1	Center: E2, R2, T2, FOG2
66x24 Rectangular	GRT5HSTP_	GRB22H26	GSB19H26	N/A	N/A	GRB22H35	GSB19H35	GRB22H41	GSB19H41	2	1	
72x24 Rectangular	GRT6STP_	GRB22H26	GSB19H26	N/A	N/A	GRB22H35	GSB19H35	GRB22H41	GSB19H41	2	1	
84x24 Rectangular	GRT7STP_	GRB22H26	GSB19H26	N/A	N/A	GRB22H35	GSB19H35	GRB22H41	GSB19H41	2	1	3 positions - Left/ Center/Right
96x24 Rectangular	GRT8STP_	GRB22H26	GSB19H26	N/A	N/A	GRB22H35	GSB19H35	GRB22H41	GSB19H41	2	1	
60x30 Rectangular	GRT5NTP_	GRB22H26	GSB19H26	GRB22	GSB19	GRB22H35	GSB19H35	GRB22H41	GSB19H41	2	1	Center: E2, R2, T2, FOG2
60x36 Rectangular	GRT5TP_	GRB22H26	GSB19H26	GRB22	GSB19	GRB22H35	GSB19H35	GRB22H41	GSB19H41	2	1	
66x30 Rectangular	GRT5NHTP_	GRB22H26	GSB19H26	GRB22	GSB19	GRB22H35	GSB19H35	GRB22H41	GSB19H41	2	1	
66x36 Rectangular	GRT5HTP_	GRB22H26	GSB19H26	GRB22	GSB19	GRB22H35	GSB19H35	GRB22H41	GSB19H41	2	1	
72x30 Rectangular	GRT6NTP_	GRB22H26	GSB19H26	GRB22	GSB19	GRB22H35	GSB19H35	GRB22H41	GSB19H41	2	1	
72x36 Rectangular	GRT6TP_	GRB22H26	GSB19H26	GRB22	GSB19	GRB22H35	GSB19H35	GRB22H41	GSB19H41	2	1	
84x30 Rectangular	GRT7NTP_	GRB22H26	GSB19H26	GRB22	GSB19	GRB22H35	GSB19H35	GRB22H41	GSB19H41	2	1	3 positions - Left/ Center/Right: E1/2/3, R1/2/3, T1/2/3, FOG1/2/3
84x36 Rectangular	GRT7TP_	GRB22H26	GSB19H26	GRB22	GSB19	GRB22H35	GSB19H35	GRB22H41	GSB19H41	2	1	
96x30 Rectangular	GRT8NTP_	GRB22H26	GSB19H26	GRB22	GSB19	GRB22H35	GSB19H35	GRB22H41	GSB19H41	2	1	
96x36 Rectangular	GRT8TP_	GRB22H26	GSB19H26	GRB22	GSB19	GRB22H35	GSB19H35	GRB22H41	GSB19H41	2	1	
96x42 Rectangular	GRT8MTP_	N/A	N/A	GRB28	GSB23	N/A	N/A	N/A	N/A	2	1	
96x48 Rectangular	GRT8WTP_	N/A	N/A	GRB28	GSB23	N/A	N/A	N/A	N/A	2	1	
120x48 Rectangular	GRT10WTP_	N/A	N/A	GRB28	GSB23	N/A	N/A	N/A	N/A	3	2	Both ends: E1, E3, R1, R3, T1, T3, FOG1, FOG3
144x48 Rectangular	GRT12WTP_	N/A	N/A	GRB28	GSB23	N/A	N/A	N/A	N/A	3	2	

APPLICABLE BASE OPTIONS FOR CORRESPONDING TOP										POWER MGMT OPTIONS		
Table Shape/Size	Top #	Lounge Height 27"H		Seated Height 28.5"H		Counter Height 36"H		Bar Height 41.5"H		Base Qty.	# top pieces	Grommet and Power Block Cut-outs Available
		Round base 22"	Square base 18.5"	Round base 22", 28", 34"	Square base 18.5", 22.5", 28.5"	Round base 22"	Square base 18.5"	Round base 22"	Square base 18.5"			
Racetrack  Nominal base plate dimension indicated by 4th and 5th characters in base model numbers												
60X24 Racetrack	GRC5STP_	GRB22H26	GSB19H26	N/A	N/A	GRB22H35	GSB19H35	GRB22H41	GSB19H41	2	1	Center: E2, R2, T2, FOG2
66X24 Racetrack	GRC5HSTP_	GRB22H26	GSB19H26	N/A	N/A	GRB22H35	GSB19H35	GRB22H41	GSB19H41	2	1	
72X24 Racetrack	GRC6STP_	GRB22H26	GSB19H26	N/A	N/A	GRB22H35	GSB19H35	GRB22H41	GSB19H41	2	1	3 positions - Left/ Center/Right
84X24 Racetrack	GRC7STP_	GRB22H26	GSB19H26	N/A	N/A	GRB22H35	GSB19H35	GRB22H41	GSB19H41	2	1	
96X24 Racetrack	GRC8STP_	GRB22H26	GSB19H26	N/A	N/A	GRB22H35	GSB19H35	GRB22H41	GSB19H41	2	1	Center: E2, R2, T2, FOG2
60x30 Racetrack	GRC5NTP_	GRB22H26	GSB19H26	GRB22	GSB19	GRB22H35	GSB19H35	GRB22H41	GSB19H41	2	1	
60X36 Racetrack	GRC5TP_	GRB22H26	GSB19H26	GRB22	GSB19	GRB22H35	GSB19H35	GRB22H41	GSB19H41	2	1	
66x30 Racetrack	GRC5NHTP_	GRB22H26	GSB19H26	GRB22	GSB19	GRB22H35	GSB19H35	GRB22H41	GSB19H41	2	1	
66X36 Racetrack	GRC5HTP_	GRB22H26	GSB19H26	GRB22	GSB19	GRB22H35	GSB19H35	GRB22H41	GSB19H41	2	1	
72x30 Racetrack	GRC6NTP_	GRB22H26	GSB19H26	GRB22	GSB19	GRB22H35	GSB19H35	GRB22H41	GSB19H41	2	1	
72x36 Racetrack	GRC6TP_	GRB22H26	GSB19H26	GRB22	GSB19	GRB22H35	GSB19H35	GRB22H41	GSB19H41	2	1	3 positions - Left/ Center/Right: E1/2/3; R1/2/3, T1/2/3, FOG1/2/3
84x30 Racetrack	GRC7NTP_	GRB22H26	GSB19H26	GRB22	GSB19	GRB22H35	GSB19H35	GRB22H41	GSB19H41	2	1	
84x36 Racetrack	GRC7TP_	GRB22H26	GSB19H26	GRB22	GSB19	GRB22H35	GSB19H35	GRB22H41	GSB19H41	2	1	
96x30 Racetrack	GRC8NTP_	GRB22H26	GSB19H26	GRB22	GSB19	GRB22H35	GSB19H35	GRB22H41	GSB19H41	2	1	
96x36 Racetrack	GRC8TP_	GRB22H26	GSB19H26	GRB22	GSB19	GRB22H35	GSB19H35	GRB22H41	GSB19H41	2	1	
96x42 Racetrack	GRC8MTP_	N/A	N/A	GRB28	GSB23	N/A	N/A	N/A	N/A	2	1	
96x48 Racetrack	GRC8WTP_	N/A	N/A	GRB28	GSB23	N/A	N/A	N/A	N/A	2	1	Both ends: E1, E3; R1, R3, T1, T3, FOG1, FOG3
120x48 Racetrack	GRC10WTP_	N/A	N/A	GRB28	GSB23	N/A	N/A	N/A	N/A	3	2	
144x48 Racetrack	GRC12WTP_	N/A	N/A	GRB28	GSB23	N/A	N/A	N/A	N/A	3	2	
Boat Shape 												
60x30 Boat shape	GBT5NTP_	GRB22H26	GSB19H26	GRB22	GSB19	GRB22H35	GSB19H35	GRB22H41	GSB19H41	2	1	Center: E2, R2, T2, FOG2
60X36 Boat shape	GBT5TP_	GRB22H26	GSB19H26	GRB22	GSB19	GRB22H35	GSB19H35	GRB22H41	GSB19H41	2	1	
66x30 Boat shape	GBT5NHTP_	GRB22H26	GSB19H26	GRB22	GSB19	GRB22H35	GSB19H35	GRB22H41	GSB19H41	2	1	
66X36 Boat shape	GBT5HTP_	GRB22H26	GSB19H26	GRB22	GSB19	GRB22H35	GSB19H35	GRB22H41	GSB19H41	2	1	
72x30 Boat shape	GBT6NTP_	GRB22H26	GSB19H26	GRB22	GSB19	GRB22H35	GSB19H35	GRB22H41	GSB19H41	2	1	
72x36 Boat shape	GBT6TP_	GRB22H26	GSB19H26	GRB22	GSB19	GRB22H35	GSB19H35	GRB22H41	GSB19H41	2	1	3 positions - Left/ Center/Right: E1/2/3; R1/2/3, T1/2/3, FOG1/2/3
84x30 Boat shape	GBT7NTP_	GRB22H26	GSB19H26	GRB22	GSB19	GRB22H35	GSB19H35	GRB22H41	GSB19H41	2	1	
84x36 Boat shape	GBT7TP_	GRB22H26	GSB19H26	GRB22	GSB19	GRB22H35	GSB19H35	GRB22H41	GSB19H41	2	1	
96x30 Boat shape	GBT8NTP_	GRB22H26	GSB19H26	GRB22	GSB19	GRB22H35	GSB19H35	GRB22H41	GSB19H41	2	1	
96x36 Boat shape	GBT8TP_	GRB22H26	GSB19H26	GRB22	GSB19	GRB22H35	GSB19H35	GRB22H41	GSB19H41	2	1	
96X42 Boat shape	GBT8MTP_	N/A	N/A	GRB28	GSB23	N/A	N/A	N/A	N/A	2	1	
96x48 Boat shape	GBT8WTP_	N/A	N/A	GRB28	GSB23	N/A	N/A	N/A	N/A	2	1	Both ends: E1, E3; R1, R2, T1, T2, FOG1, FOG 3
120x48 Boat shape	GBT10WTP_	N/A	N/A	GRB28	GSB23	N/A	N/A	N/A	N/A	3	2	
144x48 Boat shape	GBT12WTP_	N/A	N/A	GRB28	GSB23	N/A	N/A	N/A	N/A	3	2	

S SWAP™ TABLES - NOTES

APPLICABLE BASE OPTIONS FOR CORRESPONDING TOP						POWER MGMT OPTIONS		
Table Shape/Size	Top #	Laptop Height 25.6" H				Base Qty.	# Top pieces	Power Block Cut-outs available
		Round base 14" Centered column	Square base 12.5" Centered column	Round base	Square base 12.5" Offset column			
				N/A				
Round Laptop ○ <i>*Nominal base plate dimension indicated by 4th and 5th characters in base model numbers.</i>								
16.5" dia	GRBTP16_	GRB14H25	GSB13H25	N/A	N/A	1	1	None
20" dia	GRBTP20_	GRB14H25	GSB13H25	N/A	N/A	1	1	None
22" dia	GRBTP22_	GRB14H25	GSB13H25	N/A	N/A	1	1	None
16.5" dia	GRBOTP16_	N/A	N/A	N/A	GSOB13H25	1	1	None
20" dia	GRBOTP20_	N/A	N/A	N/A	GSOB13H25	1	1	None
22" dia	GRBOTP22_	N/A	N/A	N/A	GSOB13H25	1	1	None
Square Laptop □								
16.5"x16.5"	GSBTP16_	GRB14H25	GSB13H25	N/A	N/A	1	1	None
20"x20"	GSBTP20_	GRB14H25	GSB13H25	N/A	N/A	1	1	None
22"x22"	GSBTP22_	GRB14H25	GSB13H25	N/A	N/A	1	1	None
16.5"x16.5"	GSBOTP16_	N/A	N/A	N/A	GSOB13H25	1	1	None
20"x20"	GSBOTP20_	N/A	N/A	N/A	GSOB13H25	1	1	None
22"x22"	GSBOTP22_	N/A	N/A	N/A	GSOB13H25	1	1	None
Rectangular Laptop □								
16"x20"	GSBTP1620_	GRB14H25	GSB13H25	N/A	N/A	1	1	None
16"x22"	GSBTP1622_	GRB14H25	GSB13H25	N/A	N/A	1	1	None
16"x20"	GSBOT1620_	N/A	N/A	N/A	GSOB13H25	1	1	None
16"x22"	GSBOT1622_	N/A	N/A	N/A	GSOB13H25	1	1	None
APPLICABLE BASE OPTIONS FOR CORRESPONDING TOP						POWER MGMT OPTIONS		
Table Shape	Top #	Coffee Table 16" H		End Table 22" H		Base Qty.	# top pieces	Power Block Cut-outs available
		Round base 22"	Square base 18.5"	Round base 22"	Square base 18.5"			
								
Round Coffee/End Tables ○ <i>*Nominal base plate dimension indicated by 4th and 5th characters in base model numbers.</i>								
24" dia	GRBTP24_	GRB22H15	GSB19H15	GRB22H21	GSB19H21	1	1	Q2 only
30" dia	GRBTP30_	GRB22H15	GSB19H15	GRB22H21	GSB19H21	1	1	Q2 only
36" dia	GRBTP36_	GRB22H15	GSB19H15	GRB22H21	GSB19H21	1	1	Q2 only
Square Coffee/End Tables □								
24" square	GSBTP24_	GRB22H15	GSB19H15	GRB22H21	GSB19H21	1	1	Q2 only
30" square	GSBTP30_	GRB22H15	GSB19H15	GRB22H21	GSB19H21	1	1	Q2 only
36" square	GSBTP36_	GRB22H15	GSB19H15	GRB22H21	GSB19H21	1	1	Q2 only

ROUND LAPTOP TABLES FOR CENTER BASE

MODEL #	DIMENSIONS	WT/LB.	CUBIC FT.	LIST PRICE	HP ADD	GRADE 2	R3 ADD	KS ADD
---------	------------	--------	-----------	------------	--------	---------	--------	--------

W x D x H

Thermally fused laminate, flat edge ⁽¹⁾

GRBTP16	16.5 x - x 1	6	0.3	\$188	\$80	N/A	N/A	N/A
GRBTP20	20 x - x 1	9	0.5	\$206	\$89	N/A	N/A	N/A
GRBTP22	22 x - x 1	9	0.5	\$206	\$89	N/A	N/A	N/A

High pressure laminate, knife edge

GRBTP16LK	16.5 x - x 1.19	7.5	1	\$537	N/A	N/A	N/A	N/A
GRBTP20LK	20 x - x 1.19	11	1.5	\$608	N/A	N/A	N/A	N/A
GRBTP22LK	22 x - x 1.19	11	2	\$660	N/A	N/A	N/A	N/A

Veneer ⁽²⁾

GRBTP16V	16.5 x - x 1.19	7.5	1	\$809	N/A	N/A	N/A	\$77
GRBTP20V	20 x - x 1.19	11	1.5	\$875	N/A	N/A	N/A	\$77
GRBTP22V	22 x - x 1.19	11	2	\$942	N/A	N/A	N/A	\$77

Solid surface, flat edge ⁽³⁾

GRBTP16SF	16.5 x - x 1.25	11	0.6	\$1689	N/A	\$88	N/A	N/A
GRBTP20SF	20 x - x 1.25	16	1	\$1982	N/A	\$118	N/A	N/A
GRBTP22SF	22 x - x 1.25	20	1	\$2077	N/A	\$171	N/A	N/A

Solid surface, knife edge ⁽³⁾

GRBTP16SK	16.5 x - x 1.25	11	0.6	\$1789	N/A	\$100	N/A	N/A
GRBTP20SK	20 x - x 1.25	16	1	\$2088	N/A	\$123	N/A	N/A
GRBTP22SK	22 x - x 1.25	20	1	\$2188	N/A	\$176	N/A	N/A



Round Tops, for Centered Base

Only applicable bases to use with above tops: GRB14H25 round base or GSB13H25 square base with centered column.

Tops feature metal inserts for ease of assembly to base. One base required.

SQUARE LAPTOP TABLES FOR CENTER BASE

Thermally fused laminate, flat edge ⁽¹⁾⁽⁴⁾

GSBTP16	16.5 x 16.5 x 1	7	0.3	\$188	\$80	N/A	\$18.80	N/A
GSBTP20	20 x 20 x 1	11	0.5	\$206	\$89	N/A	\$20.60	N/A
GSBTP22	22 x 22 x 1	13	0.5	\$206	\$89	N/A	\$20.60	N/A

High pressure laminate, knife edge

GSBTP16LK	16.5 x 16.5 x 1.19	8.5	1	\$359	N/A	N/A	N/A	N/A
GSBTP20LK	20 x 20 x 1.19	13	1.5	\$450	N/A	N/A	N/A	N/A
GSBTP22LK	22 x 22 x 1.19	16	2	\$491	N/A	N/A	N/A	N/A

Veneer ⁽²⁾

GSBTP16V	16.5 x 16.5 x 1.19	8.5	1	\$461	N/A	N/A	N/A	\$72
GSBTP20V	20 x 20 x 1.19	13	1.5	\$578	N/A	N/A	N/A	\$87
GSBTP22V	22 x 22 x 1.19	16	2	\$635	N/A	N/A	N/A	\$97

Solid surface, flat edge ⁽³⁾⁽⁴⁾

GSBTP16SF	16.5 x 16.5 x 1.25	14	0.6	\$1447	N/A	\$83	\$206	N/A
GSBTP20SF	20 x 20 x 1.25	21	1	\$1736	N/A	\$123	\$206	N/A
GSBTP22SF	22 x 22 x 1.25	26	1	\$1829	N/A	\$147	\$206	N/A

Solid surface, knife edge ⁽³⁾⁽⁴⁾

GSBTP16SK	16.5 x 16.5 x 1.25	14	0.6	\$1789	N/A	\$100	\$206	N/A
GSBTP20SK	20 x 20 x 1.25	21	1	\$2088	N/A	\$130	\$206	N/A
GSBTP22SK	22 x 22 x 1.25	26	1	\$2188	N/A	\$176	\$206	N/A

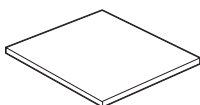

Square Tops, for Centered Base

Only applicable bases to use with above tops: GRB14H25 round base or GSB13H25 square base with centered column.

Tops feature metal inserts for ease of assembly to base. One base required.

Required specifications

Top finish
Edge finish ⁽¹⁾

Optional specifications

HP laminate ⁽¹⁾
Knife edge ⁽²⁾
Grade 2 solid surface ⁽³⁾
3" radiused corners ⁽⁴⁾

Applicable bases

GRB14H25 - round
GSB13H25 - square

S SWAP™ TABLES

RECTANGULAR LAPTOP TABLES FOR CENTER BASE

MODEL # DIMENSIONS WT/LB. CUBIC FT. LIST PRICE HP ADD GRADE 2 R3 ADD KS ADD

W x D x H

Thermally fused laminate, flat edge ⁽¹⁾⁽⁴⁾

GSBTP1620	16 x 20 x 1	9	0.4	\$206	\$89	N/A	\$20.60	N/A
GSBTP1622	16 x 22 x 1	11	0.5	\$206	\$89	N/A	\$20.60	N/A

High pressure laminate, knife edge

GSBTP1620LK	20 x 16 x 1.19	11	1	\$461	N/A	N/A	N/A	N/A
GSBTP1622LK	22 x 16 x 1.19	13	1.5	\$506	N/A	N/A	N/A	N/A

Veneer ⁽²⁾

GSBTP1620V	20 x 16 x 1.19	11	1	\$568	N/A	N/A	N/A	\$87
GSBTP1622V	22 x 16 x 1.19	13	1.5	\$624	N/A	N/A	N/A	\$92

Solid surface, flat edge ⁽³⁾⁽⁴⁾

GSBTP1620SF	16 x 20 x 1.25	17	0.8	\$1606	N/A	\$100	\$206	N/A
GSBTP1622SF	16 x 22 x 1.25	19	0.8	\$1629	N/A	\$106	\$206	N/A

Solid surface, knife edge ⁽³⁾⁽⁴⁾

GSBTP1620SK	16 x 20 x 1.25	17	0.8	\$1929	N/A	\$123	\$206	N/A
GSBTP1622SK	16 x 22 x 1.25	19	0.8	\$1965	N/A	\$141	\$206	N/A

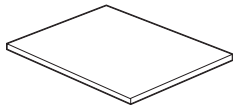

Rectangular Tops, for Centered Base

Only applicable bases to use with above tops: GRB14H25 round base or GSB13H25 square base with centered column. Tops feature metal inserts for ease of assembly to base. One base required.

ROUND LAPTOP TABLES FOR OFFSET BASE

Thermally fused laminate, flat edge ⁽¹⁾

GRBOTP16	16.5 x - x 1	6	0.3	\$188	\$80	N/A	N/A	N/A
GRBOTP20	20 x - x 1	9	0.5	\$206	\$89	N/A	N/A	N/A
GRBOTP22	22 x - x 1	11	0.7	\$206	\$89	N/A	N/A	N/A

High pressure laminate, knife edge

GRBOTP16LK	16.5 x - x 1.19	8	1	\$537	N/A	N/A	N/A	N/A
GRBOTP20LK	20 x - x 1.19	13	1.5	\$608	N/A	N/A	N/A	N/A
GRBOTP22LK	22 x - x 1.19	16	2	\$660	N/A	N/A	N/A	N/A

Veneer ⁽²⁾

GRBOTP16V	16.5 x - x 1.19	8	1	\$809	N/A	N/A	N/A	\$77
GRBOTP20V	20 x - x 1.19	13	1.5	\$875	N/A	N/A	N/A	\$77
GRBOTP22V	22 x - x 1.19	16	2	\$942	N/A	N/A	N/A	\$77

Solid surface, flat edge ⁽³⁾

GRBOTP16SF	16.5 x - x 1.25	11	0.6	\$1689	N/A	\$88	N/A	N/A
GRBOTP20SF	20 x - x 1.25	16	1	\$1982	N/A	\$118	N/A	N/A
GRBOTP22SF	22 x - x 1.25	20	1	\$2077	N/A	\$171	N/A	N/A

Solid surface, knife edge ⁽³⁾

GRBOTP16SK	16.5 x - x 1.25	11	0.6	\$1789	N/A	\$100	N/A	N/A
GRBOTP20SK	20 x - x 1.25	16	1	\$2088	N/A	\$123	N/A	N/A
GRBOTP22SK	22 x - x 1.25	20	1	\$2188	N/A	\$176	N/A	N/A



Round Tops, for Offset Base

Only applicable bases to use with above tops: GSOB13H25 square base with OFFSET column. Tops feature metal inserts for ease of assembly to base. One base required.

Required specifications

Top finish
Edge finish ⁽¹⁾

Optional specifications

HP laminate ⁽¹⁾
Knife edge ⁽²⁾
Grade 2 solid surface ⁽³⁾
3" radiused corners ⁽⁴⁾

Applicable bases

GRB14H25 - round centered
GSB13H25 - square centered
GSOB13H25 - square offset

SQUARE LAPTOP TABLES FOR OFFSET BASE

MODEL #	DIMENSIONS	WT/LB.	CUBIC FT.	LIST PRICE	HP ADD	GRADE 2	R3 ADD	KS ADD
W x D x H								
Thermally fused laminate, flat edge ⁽¹⁾⁽⁴⁾								
GSBOTP16	16.5 x 16.5 x 1	7	0.3	\$188	\$80	N/A	\$18.80	N/A
GSBOTP20	20 x 20 x 1	11	0.5	\$206	\$89	N/A	\$20.60	N/A
GSBOTP22	22 x 22 x 1	13	0.7	\$206	\$89	N/A	\$20.60	N/A
High pressure laminate, knife edge								
GSBOTP16LK	16.5 x 16.5 x 1.19	8.5	1	\$359	N/A	N/A	N/A	N/A
GSBOTP20LK	20 x 20 x 1.19	13	1.5	\$450	N/A	N/A	N/A	N/A
GSBOTP22LK	22 x 22 x 1.19	16	2	\$491	N/A	N/A	N/A	N/A
Veneer ⁽²⁾								
GSBOTP16V	16.5 x 16.5 x 1.19	8.5	1	\$461	N/A	N/A	N/A	\$72
GSBOTP20V	20 x 20 x 1.19	13	1.5	\$578	N/A	N/A	N/A	\$87
GSBOTP22V	22 x 22 x 1.19	16	2	\$635	N/A	N/A	N/A	\$97
Solid surface, flat edge ⁽³⁾⁽⁴⁾								
GSBOTP16SF	16.5 x 16.5 x 1.25	14	0.6	\$1447	N/A	\$83	\$206	N/A
GSBOTP20SF	20 x 20 x 1.25	21	1	\$1736	N/A	\$123	\$206	N/A
GSBOTP22SF	22 x 22 x 1.25	26	1	\$1829	N/A	\$147	\$206	N/A
Solid surface, knife edge ⁽³⁾⁽⁴⁾								
GSBOTP16SK	16.5 x 16.5 x 1.25	14	0.6	\$1789	N/A	\$100	\$206	N/A
GSBOTP20SK	20 x 20 x 1.25	21	1	\$2088	N/A	\$130	\$206	N/A
GSBOTP22SK	22 x 22 x 1.25	26	1	\$2188	N/A	\$176	\$206	N/A

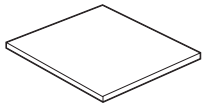

Square Tops, for Offset Base

Only applicable bases to use with above tops: GSOB13H25 square base with OFFSET column.
Tops feature metal inserts for ease of assembly to base. One base required.

RECTANGULAR LAPTOP TABLES FOR OFFSET BASE

Thermally fused laminate, flat edge ⁽¹⁾⁽⁴⁾								
GSBOT1620	16 x 20 x 1	9	0.4	\$210	\$91	N/A	\$21	N/A
GSBOT1622	16 x 22 x 1	11	0.5	\$210	\$91	N/A	\$21	N/A
High pressure laminate, knife edge								
GSBOT1620LK	20 x 16 x 1.19	11	1.5	\$461	N/A	N/A	N/A	N/A
GSBOT1622LK	22 x 16 x 1.19	13	2	\$506	N/A	N/A	N/A	N/A
Veneer ⁽²⁾								
GSBOT1620V	20 x 16 x 1.19	11	1.5	\$568	N/A	N/A	N/A	\$87
GSBOT1622V	22 x 16 x 1.19	13	2	\$624	N/A	N/A	N/A	\$92
Solid surface, flat edge ⁽³⁾⁽⁴⁾								
GSBOT1620SF	16 x 20 x 1.25	17	0.8	\$1606	N/A	\$100	\$206	N/A
GSBOT1622SF	16 x 22 x 1.25	19	0.8	\$1629	N/A	\$106	\$206	N/A
Solid surface, knife edge ⁽³⁾⁽⁴⁾								
GSBOT1620SK	16 x 20 x 1.25	17	0.8	\$1929	N/A	\$123	\$206	N/A
GSBOT1622SK	16 x 22 x 1.25	19	0.8	\$1965	N/A	\$141	\$206	N/A

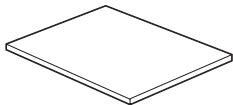

Rectangular Tops, for Offset Base

Only applicable bases to use with above tops: GSOB13H25 square base with OFFSET column.
Tops feature metal inserts for ease of assembly to base. One base required.

Required specifications

Top finish
Edge finish ⁽¹⁾

Optional specifications

HP laminate ⁽¹⁾
Knife edge ⁽²⁾
Grade 2 solid surface ⁽³⁾
3" radiused corners ⁽⁴⁾

Applicable base

GSOB13H25 - square

S SWAP™ TABLES

LAPTOP TABLE BASES

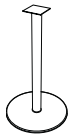

14" Round Centered Base

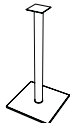

12.5" Square Centered Base

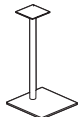

12.5" Square Offset Base

MODEL #	DIMENSIONS	WT/LB.	CUBIC FT.	LIST PRICE	BCH / CHM	ACO / SBR
---------	------------	--------	-----------	------------	-----------	-----------

W x D x H

GRB14H25	14 x - x 24.6	27	3.26	\$633	\$87	\$172
GSB13H25	12.5 x 12.5 x 24.6	26	3.26	\$653	\$87	\$186
GSOB13H25	12.5 x 12.5 x 24.6	26	3.26	\$653	\$87	\$186

1.5" diameter column. Weighted base for balance includes top plate, 0.5" adjustable glides to level on uneven surfaces. Screws included with base for attaching to appropriate top(s). Available in paint and plated finishes as listed on page 323. Upcharge applies on plated finishes.

Required specifications

Finish

Optional specifications

Plated finish

ROUND TOPS, 24" - 36"W **MODEL #** **DIMENSIONS** **WT/LB.** **CUBIC FT.** **LIST PRICE** **HP ADD** **GRADE 2** **R3 ADD** **KS ADD**

W x D x H

Thermally fused laminate, flat edge ⁽¹⁾

GRBTP24	24 x - x 1	16	1	\$206	\$91	N/A	N/A	N/A
GRBTP30	30 x - x 1	25	1.5	\$239	\$108	N/A	N/A	N/A
GRBTP36	36 x - x 1	36	2	\$303	\$136	N/A	N/A	N/A

High pressure laminate, knife edge

GRBTP24LK	24 x - x 1.19	19	2	\$845	N/A	N/A	N/A	N/A
GRBTP30LK	30 x - x 1.19	30	3	\$1038	N/A	N/A	N/A	N/A
GRBTP36LK	36 x - x 1.19	43	4	\$1228	N/A	N/A	N/A	N/A

Veneer ⁽²⁾

GRBTP24V	24 x - x 1.19	19	2	\$1008	N/A	N/A	N/A	\$77
GRBTP30V	30 x - x 1.19	30	3	\$1202	N/A	N/A	N/A	\$77
GRBTP36V	36 x - x 1.19	43	4	\$1407	N/A	N/A	N/A	\$77

Solid surface, flat edge ⁽³⁾

GRBTP24SF	24 x - x 1.25	24	1.2	\$2130	N/A	\$171	N/A	N/A
GRBTP30SF	29.8 x - x 1.25	37	1.8	\$2323	N/A	\$235	N/A	N/A
GRBTP36SF	36 x - x 1.25	53	2.5	\$2970	N/A	\$353	N/A	N/A

Solid surface, knife edge ⁽³⁾

GRBTP24SK	24 x - x 1.25	24	1.2	\$2188	N/A	\$183	N/A	N/A
GRBTP30SK	29.8 x - x 1.25	37	1.8	\$2411	N/A	\$253	N/A	N/A
GRBTP36SK	36 x - x 1.25	53	2.5	\$3147	N/A	\$376	N/A	N/A



Round Tops

Applicable bases to use with above tops: GRB22Hxx round base or GSB19Hxx square base (15", 21", 26", 28" 35" or 40.5"H). Tops feature metal inserts for ease of assembly to base. One base required.

SQUARE TOPS, 24" - 36"W

Thermally fused laminate, flat edge ⁽¹⁾⁽⁴⁾

GSBTP24	24 x 24 x 1	20	1	\$206	\$91	N/A	\$20.60	N/A
GSBTP30	30 x 30 x 1	30	1.5	\$239	\$108	N/A	\$23.90	N/A
GSBTP36	36 x 36 x 1	44	2	\$303	\$136	N/A	\$30.30	N/A

High pressure laminate, knife edge

GSBTP24LK	24 x 24 x 1.19	24	2	\$768	N/A	N/A	N/A	N/A
GSBTP30LK	30 x 30 x 1.19	36	3	\$834	N/A	N/A	N/A	N/A
GSBTP36LK	36 x 36 x 1.19	53	4	\$895	N/A	N/A	N/A	N/A

Veneer ⁽²⁾

GSBTP24V	24 x 24 x 1.19	24	2	\$1038	N/A	N/A	N/A	\$72
GSBTP30V	30 x 30 x 1.19	36	3	\$1100	N/A	N/A	N/A	\$72
GSBTP36V	36 x 36 x 1.19	53	4	\$1166	N/A	N/A	N/A	\$72

Solid surface, flat edge ⁽³⁾⁽⁴⁾

GSBTP24SF	24 x 24 x 1.25	30	1.2	\$1882	N/A	\$176	\$206	N/A
GSBTP30SF	29.8 x 29.8 x 1.25	47	1.8	\$2323	N/A	\$235	\$206	N/A
GSBTP36SF	36 x 36 x 1.25	68	2.5	\$3024	N/A	\$288	\$206	N/A

Solid surface, knife edge ⁽¹⁾⁽⁴⁾

GSBTP24SK	24 x 24 x 1.25	30	1.2	\$1942	N/A	\$188	\$206	N/A
GSBTP30SK	29.8 x 29.8 x 1.25	47	1.8	\$2912	N/A	\$265	\$206	N/A
GSBTP36SK	36 x 36 x 1.25	68	2.5	\$3606	N/A	\$329	\$206	N/A

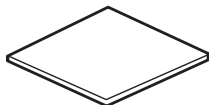

Square Tops

Applicable bases to use with above tops: GRB22Hxx round base or GSB19Hxx square base (15", 21", 26", 28" 35" or 40.5"H). Tops feature metal inserts for ease of assembly to base. One base required.

Required specifications

Top finish
Edge finish ⁽¹⁾

Optional specifications

HP laminate ⁽¹⁾ Knife edge ⁽²⁾
Grade 2 solid surface ⁽³⁾
3" radiused corners ⁽⁴⁾
Q2 cut-out for single port module

Applicable bases

Round bases: GRB22H15, GRB22H21, GRB22H26, GRB22, GRB22H35, GRB22H41
Square bases: GSB19H15, GSB19H21, GSB19H26, GSB19, GSB19H35, GSB19H41

Accessories

Single port modules

RECTANGULAR TOPS, SMALL

MODEL # DIMENSIONS WT/LB. CUBIC FT. LIST PRICE HP ADD GRADE 2 R3 ADD KS ADD

W x D x H

Thermally fused laminate, flat edge ⁽¹⁾⁽⁴⁾

GSBTP2430	30 x 24 x 1	20	0.91	\$235	\$103	N/A	\$23.50	N/A
GSBTP2436	36 x 24 x 1	24	1.08	\$271	\$117	N/A	\$27.10	N/A
GSBTP3036	36 x 30 x 1	31	1.34	\$297	\$128	N/A	\$29.70	N/A

High pressure laminate, knife edge

GSBTP2430LK	30 x 24 x 1.19	24	2.5	\$768	N/A	N/A	N/A	N/A
GSBTP2436LK	36 x 24 x 1.19	29	3	\$895	N/A	N/A	N/A	N/A
GSBTP3036LK	36 x 30 x 1.19	37	3.5	\$942	N/A	N/A	N/A	N/A

Veneer ⁽²⁾

GSBTP2430V	30 x 24 x 1.19	24	2.5	\$1038	N/A	N/A	N/A	\$72
GSBTP2436V	36 x 24 x 1.19	29	3	\$1100	N/A	N/A	N/A	\$72
GSBTP3036V	36 x 30 x 1.19	37	3.5	\$1166	N/A	N/A	N/A	\$72

Solid surface, flat edge ⁽³⁾⁽⁴⁾

GSBTP2430SF	24 x 29.8 x 1.25	38	1.8	\$2035	N/A	\$176	\$206	N/A
GSBTP2436SF	24 x 36 x 1.25	45	2.1	\$2295	N/A	\$223	\$206	N/A
GSBTP3036SF	29.8 x 36 x 1.25	57	2.1	\$2606	N/A	\$248	\$206	N/A

Solid surface, knife edge ⁽³⁾⁽⁴⁾

GSBTP2430SK	24 x 29.8 x 1.25	38	1.8	\$2453	N/A	\$218	\$206	N/A
GSBTP2436SK	24 x 36 x 1.25	45	2.1	\$2664	N/A	\$271	\$206	N/A
GSBTP3036SK	29.8 x 36 x 1.25	57	2.1	\$3006	N/A	\$300	\$206	N/A

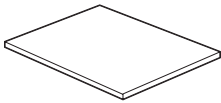

Rectangular Tops

Applicable bases to use with above tops: GRB22Hxx round base or GSB19Hxx square base (15", 21", 26", 28" 35" or 40.5"H). Tops feature metal inserts for ease of assembly to base. One base required.

Required specifications

Top finish
Edge finish ⁽¹⁾

Optional specifications

HP laminate ⁽¹⁾ Knife edge ⁽²⁾
Grade 2 solid surface ⁽³⁾
3" radiused corners ⁽⁴⁾
Q2 cut-out for single port module

Applicable bases

Round bases: GRB22H15, GRB22H21, GRB22H26, GRB22, GRB22H35, GRB22H41
Square bases: GSB19H15, GSB19H21, GSB19H26, GSB19, GSB19H35, GSB19H41

Accessories

Single port modules

BASES FOR TOPS 24" - 36"W MODEL # DIMENSIONS WT/LB. CUBIC FT. LIST PRICE BCH / CHM ACO / SBR

W x D x H

BASE VALID FOR TOPS ON PAGES 333-334:

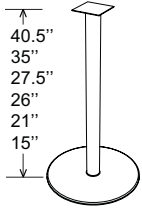

22" Dia Round Bases ⁽¹⁾

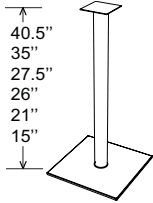

18.5" Square Bases ⁽¹⁾

GRB22H15	22 x - x 15	47.6	4.69	\$793	\$147	\$211
GRB22H21	22 x - x 21	48.6	6.45	\$793	\$147	\$211
GRB22H26	22 x - x 26	55	8.63	\$793	\$147	\$221
GRB22	22 x - x 27.5	55	9.33	\$793	\$147	\$221
GRB22H35	22 x - x 35	57.1	12	\$831	\$164	\$253
GRB22H41	22 x - x 40.5	58.3	14	\$844	\$171	\$259

GRB22H15 - coffee table height **GRB22H26** - lounge height **GRB22H35** - counter height
GRB22H21 - end table height **GRB22** - seated height **GRB22H41** - bar height

GSB19H15	18.5 x 18.5 x 15	43.7	3.52	\$857	\$136	\$204
GSB19H21	18.5 x 18.5 x 21	44.8	4.84	\$857	\$136	\$204
GSB19H26	18.5 x 18.5 x 26	50	5.94	\$857	\$136	\$212
GSB19	18.5 x 18.5 x 27.5	50	6.06	\$857	\$136	\$212
GSB19H35	18.5 x 18.5 x 35	51.8	7.52	\$906	\$151	\$262
GSB19H41	18.5 x 18.5 x 40.5	53.2	8.77	\$937	\$166	\$267

GSB19H15 - coffee table height **GSB19H26** - lounge height **GSB1935** - counter height
GSB19H21 - end table height **GSB19** - seated height **GSB19H41** - bar height

Base comes fully assembled and features 0.5" adjustable glides to level on uneven surfaces. Screws included with base for attaching to appropriate top(s). Base top plate and base plate include pass-through for single port power or USB module (sold separately). Available in paint and plated finishes as listed on page 323. Upcharge applies on plated finishes.

Required specifications
 Finish

Optional specifications
 Plated finish ⁽¹⁾

S SWAP™ TABLES

ROUND TOPS, 42" - 48"W

MODEL # DIMENSIONS WT/LB. CUBIC FT. LIST PRICE HP ADD GRADE 2 R3 ADD KS ADD

W x D x H

Thermally fused laminate, flat edge ⁽¹⁾

GRBTP42	42 x - x 1	44	2.5	\$424	\$174	N/A	N/A	N/A
GRBTP48	48 x - x 1	56	3	\$452	\$188	N/A	N/A	N/A

High pressure laminate, knife edge

GRBTP42LK	42 x - x 1.19	53	5	\$1432	N/A	N/A	N/A	N/A
GRBTP48LK	48 x - x 1.19	67	6.5	\$1637	N/A	N/A	N/A	N/A

Veneer ⁽²⁾

GRBTP42V	42 x - x 1.19	53	5	\$1718	N/A	N/A	N/A	\$72
GRBTP48V	48 x - x 1.19	67	6.5	\$1965	N/A	N/A	N/A	\$81

Solid surface, flat edge ⁽³⁾

GRBTP42SF	42 x - x 1.25	73	3.4	\$4029	N/A	\$453	N/A	N/A
GRBTP48SF	48 x - x 1.25	95	4.3	\$4588	N/A	\$576	N/A	N/A

Solid surface, knife edge ⁽³⁾

GRBTP42SK	42 x - x 1.25	73	3.4	\$4242	N/A	\$506	N/A	N/A
GRBTP48SK	48 x - x 1.25	95	4.3	\$5117	N/A	\$641	N/A	N/A



Round Tops

Applicable bases to use with above tops: GRB28 round base or GSB23 square base (28"H). Tops feature metal inserts for ease of assembly to base. One base required.

SQUARE/RECTANGULAR TOPS, 42"W

Thermally fused laminate, flat edge ⁽¹⁾⁽⁴⁾

GSBTP3042	42 x 30 x 1	36	1.55	\$392	\$169	N/A	\$39.20	N/A
GSBTP3642	42 x 36 x 1	43	1.86	\$421	\$182	N/A	\$42.10	N/A
GSBTP42	42 x 42 x 1	58	2.5	\$424	\$174	N/A	\$42.40	N/A

High pressure laminate, knife edge

GSBTP3042LK	42 x 30 x 1.19	43	4	\$1013	N/A	N/A	N/A	N/A
GSBTP3642LK	42 x 36 x 1.19	52	4.5	\$1075	N/A	N/A	N/A	N/A
GSBTP42LK	42 x 42 x 1.19	70	5	\$1120	N/A	N/A	N/A	N/A

Veneer ⁽²⁾

GSBTP3042V	42 x 30 x 1.19	43	4	\$1274	N/A	N/A	N/A	\$56
GSBTP3642V	42 x 36 x 1.19	52	4.5	\$1330	N/A	N/A	N/A	\$66
GSBTP42V	42 x 42 x 1.19	70	5	\$1560	N/A	N/A	N/A	\$72

Solid surface, flat edge ⁽³⁾⁽⁴⁾

GSBTP3042SF	29.8 x 42 x 1.25	66	2.9	\$2736	N/A	\$300	\$206	N/A
GSBTP3642SF	36 x 42 x 1.25	79	2.9	\$3511	N/A	\$400	\$206	N/A
GSBTP42SF	42 x 42 x 1.25	92	3.4	\$3659	N/A	\$436	\$206	N/A

Solid surface, knife edge ⁽³⁾⁽⁴⁾

GSBTP3042SK	29.8 x 42 x 1.25	66	2.9	\$3205	N/A	\$353	\$206	N/A
GSBTP3642SK	36 x 42 x 1.25	79	2.9	\$4052	N/A	\$476	\$206	N/A
GSBTP42SK	42 x 42 x 1.25	92	3.4	\$4242	N/A	\$529	\$206	N/A

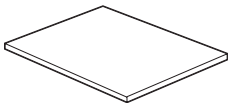

Rectangular Tops

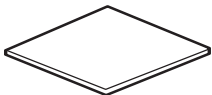

Square Tops

Applicable bases to use with above tops: GRB28 round base or GSB23 square base (28"H). Tops feature metal inserts for ease of assembly to base. One base required.

Required specifications

Top finish
Edge finish ⁽¹⁾

Optional specifications

HP laminate ⁽¹⁾
Knife edge ⁽²⁾
Grade 2 solid surface ⁽³⁾
3" radiused corners ⁽⁴⁾

Applicable bases

GRB28 - round
GSB23 - square

BASES FOR TOPS 42" - 48"W MODEL # DIMENSIONS WT/LB. CUBIC FT. LIST PRICE BCH / CHM ACO / SBR

W x D x H

BASES VALID FOR TOPS ON PAGE 336:

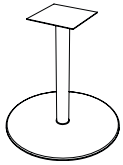

28" Dia Round Base

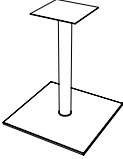

23" Square Base

GRB28	28 x - x 27.5	100	15.63	\$1250	\$147	\$372
seated height						

GSB23	22.5 x 22.5 x 27.5	82	9.33	\$1146	\$136	\$235
seated height						

Base comes fully assembled and features 0.5" adjustable glides to level on uneven surfaces. Screws included with base for attaching to appropriate top(s). Available in paint and plated finishes as listed on page 323. Upcharge applies on plated finishes.

Required Specifications
Finish

Optional Specifications
Plated finish

S SWAP™ TABLES

ROUND TOPS, 54" - 60"W

MODEL #	DIMENSIONS	WT/LB.	CUBIC FT.	LIST PRICE	HP ADD	GRADE 2	R3 ADD	KS ADD
---------	------------	--------	-----------	------------	--------	---------	--------	--------

W x D x H

Thermally fused laminate, flat edge ⁽¹⁾

GRBTP54	54 x - x 1	73	4.5	\$603	\$271	N/A	N/A	N/A
GRBTP60	60 x - x 1	92	5	\$627	\$282	N/A	N/A	N/A

High pressure laminate, knife edge

GRBTP54LK	54 x - x 1.19	88	8	\$1847	N/A	N/A	N/A	N/A
GRBTP60LK	60 x - x 1.19	110	10	\$2276	N/A	N/A	N/A	N/A

Veneer ⁽²⁾

GRBTP54V	54 x - x 1.19	88	8	\$2507	N/A	N/A	N/A	\$97
GRBTP60V	60 x - x 1.19	110	10	\$3094	N/A	N/A	N/A	\$102

Solid surface, flat edge ⁽³⁾

GRBTP54SF	54 x - x 1.25	120	5.4	\$4971	N/A	\$706	N/A	N/A
GRBTP60SF	60 x - x 1.25	148	6.7	\$6530	N/A	\$882	N/A	N/A

Solid surface, knife edge ⁽³⁾

GRBTP54SK	54 x - x 1.25	120	5.4	\$5876	N/A	\$888	N/A	N/A
GRBTP60SK	60 x - x 1.25	148	6.7	\$7189	N/A	\$1077	N/A	N/A



Round Tops

Applicable bases to use with above tops: GRB34 round base or GSB28 square base (28"H). Tops feature metal inserts for ease of assembly to base. One base required.

BASES FOR TOPS 54" - 60"W

MODEL #	DIMENSIONS	WT/LB.	CUBIC FT.	LIST PRICE	BCH / CHM	ACO / SBR
---------	------------	--------	-----------	------------	-----------	-----------

W x D x H

BASES VALID FOR TOPS ABOVE:

Order the quantity of bases as indicated by each top size.

GRB34	34 x - x 27.5	135	20.56	\$1538	\$147	\$449
-------	---------------	-----	-------	---------------	--------------	--------------

seated height

GSB28	28.5 x 28.5 x 27.5	125	15.63	\$1432	\$136	\$242
-------	--------------------	-----	-------	---------------	--------------	--------------

seated height

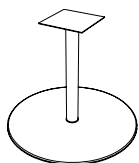

34" Dia Round Base

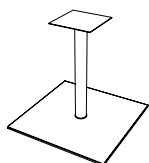

28" Square Base

Base comes fully assembled and features 0.5" adjustable glides to level on uneven surfaces. Screws included with base for attaching to appropriate top(s). Available in paint and plated finishes as listed on page 323. Upcharge applies on plated finishes.

Required specifications

Top finish
Edge finish ⁽¹⁾
Base finish

Optional specifications

HP laminate ⁽¹⁾
Knife edge ⁽²⁾
Grade 2 solid surface ⁽³⁾
Base plated finish

Applicable bases

GRB34 - round
GSB28 - square

RECTANGULAR LOUNGE TOPS, 24" D **MODEL #** **DIMENSIONS** **WT/LB.** **CUBIC FT.** **LIST PRICE** **HP ADD** **GRADE 2** **R3 ADD** **KS ADD**

W x D x H

Thermally fused laminate, flat edge ⁽¹⁾⁽⁴⁾

GRT5STP	60 x 24 x 1	41	1.79	\$406	\$173	N/A	\$40.60	N/A
GRT5HSTP	66 x 24 x 1	46	1.97	\$474	\$173	N/A	\$47.40	N/A
GRT6STP	72 x 24 x 1	49	2.14	\$494	\$184	N/A	\$49.40	N/A
GRT7STP	84 x 24 x 1	57	2.49	\$573	\$219	N/A	\$49.40	N/A
GRT8STP	96 x 24 x 1	66	2.84	\$615	\$240	N/A	\$61.50	N/A

High pressure laminate, knife edge

GRT5STPLK	60 x 24 x 1.19	49	4	\$1100	N/A	N/A	N/A	N/A
GRT5HSTPLK	66 x 24 x 1.19	55	4.5	\$1166	N/A	N/A	N/A	N/A
GRT6STPLK	72 x 24 x 1.19	59	5	\$1228	N/A	N/A	N/A	N/A
GRT7STPLK	84 x 24 x 1.19	68	5.5	\$1356	N/A	N/A	N/A	N/A
GRT8STPLK	96 x 24 x 1.19	79	6.5	\$1535	N/A	N/A	N/A	N/A

Veneer ⁽²⁾

GRT5STPV	60 x 24 x 1.19	49	4	\$1356	N/A	N/A	N/A	\$66
GRT5HSTPV	66 x 24 x 1.19	55	4.5	\$1422	N/A	N/A	N/A	\$66
GRT6STPV	72 x 24 x 1.19	59	5	\$1550	N/A	N/A	N/A	\$66
GRT7STPV	84 x 24 x 1.19	68	5.5	\$1806	N/A	N/A	N/A	\$66
GRT8STPV	96 x 24 x 1.19	79	6.5	\$2061	N/A	N/A	N/A	\$66

Solid surface, flat edge ⁽³⁾⁽⁴⁾

GRT5STPSF	60 x 24 x 1.25	75	2.8	\$3941	N/A	\$441	\$206	N/A
GRT5HSTPSF	66 x 24 x 1.25	83	3.1	\$4117	N/A	\$453	\$206	N/A
GRT6STPSF	71.8 x 24 x 1.25	90	3.3	\$4341	N/A	\$464	\$206	N/A
GRT7STPSF	84 x 24 x 1.25	105	3.9	\$4824	N/A	\$606	\$206	N/A
GRT8STPSF	96 x 24 x 1.25	120	4.4	\$5294	N/A	\$617	\$206	N/A

Solid surface, knife edge ⁽³⁾⁽⁴⁾

GRT5STPSK	60 x 24 x 1.25	75	2.8	\$4441	N/A	\$471	\$206	N/A
GRT5HSTPSK	66 x 24 x 1.25	83	3.1	\$4618	N/A	\$494	\$206	N/A
GRT6STPSK	71.8 x 24 x 1.25	90	3.3	\$4841	N/A	\$518	\$206	N/A
GRT7STPSK	84 x 24 x 1.25	105	3.9	\$5518	N/A	\$671	\$206	N/A
GRT8STPSK	96 x 24 x 1.25	120	4.4	\$6006	N/A	\$694	\$206	N/A

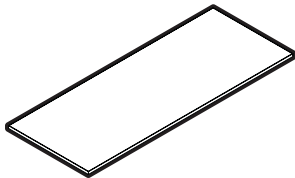

Rectangular Tops

Applicable bases to use with above tops - two bases required: GRB22Hxx round bases or GSB19Hxx square bases (26", 35" or 40.5" H). Tops feature metal inserts for ease of assembly to base. 24"D tops not recommended with 28"H bases.

Required specifications

Top finish
Edge finish ⁽¹⁾

Optional specifications

HP laminate ⁽¹⁾ Knife edge ⁽²⁾
Grade 2 solid surface ⁽³⁾
3" radiused corners ⁽⁴⁾
Grommet position or power block cut-out

Applicable bases (two required)

Round bases:
GRB22H26, GRB22H35, GRB22H41
Square bases:
GSB19H26, GSB19H35, GSB19H41

Accessories

Power block

RACETRACK LOUNGE TOPS, 24"D

MODEL # DIMENSIONS WT/LB. CUBIC FT. LIST PRICE HP ADD KS ADD

W x D x H

Thermally fused laminate, flat edge ⁽¹⁾

GRC5STP	60 x 24 x 1	41	1.79	\$406	\$173	N/A
GRC5HSTP	66 x 24 x 1	46	1.97	\$474	\$173	N/A
GRC6STP	72 x 24 x 1	49	2.14	\$494	\$185	N/A
GRC7STP	84 x 24 x 1	57	2.49	\$573	\$222	N/A
GRC8STP	96 x 24 x 1	66	2.84	\$615	\$244	N/A

High pressure laminate, knife edge

GRC5STPLK	60 x 24 x 1.19	49	4	\$1356	N/A	N/A
GRC5HSTPLK	66 x 24 x 1.19	55	4.5	\$1484	N/A	N/A
GRC6STPLK	72 x 24 x 1.19	59	5	\$1612	N/A	N/A
GRC7STPLK	84 x 24 x 1.19	68	5.5	\$1739	N/A	N/A
GRC8STPLK	96 x 24 x 1.19	79	6.5	\$1868	N/A	N/A

Veneer ⁽²⁾

GRC5STPV	60 x 24 x 1.19	49	4	\$1612	N/A	\$230
GRC5HSTPV	66 x 24 x 1.19	55	4.5	\$1766	N/A	\$256
GRC6STPV	72 x 24 x 1.19	59	5	\$1918	N/A	\$275
GRC7STPV	84 x 24 x 1.19	68	5.5	\$2225	N/A	\$275
GRC8STPV	96 x 24 x 1.19	79	6.5	\$2532	N/A	\$275

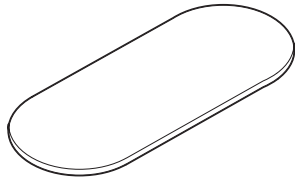

Racetrack Tops

Applicable bases to use with above tops - two bases required: GRB22Hxx round bases or GSB19Hxx square bases (26", 35" or 40.5" H). Tops feature metal inserts for ease of assembly to base. 24"D tops not recommended with 28"H bases.

Required specifications

Top finish
Edge finish ⁽¹⁾

Optional specifications

HP laminate ⁽¹⁾
Knife edge ⁽²⁾
Grommet position or power block cut-out

Applicable bases (two required)

Round bases:
GRB22H26, GRB22H35, GRB22H41
Square bases:
GSB19H26, GSB19H35, GSB19H41

Accessories

Power block

RECTANGULAR TOPS, 60" - 96"W

MODEL #	DIMENSIONS	WT/LB.	CUBIC FT.	LIST PRICE	HP ADD	GRADE 2	R3 ADD	KS ADD
---------	------------	--------	-----------	------------	--------	---------	--------	--------

W x D x H

Thermally fused laminate, flat edge ⁽¹⁾⁽⁴⁾

GRT5NTP	60 x 30 x 1	46	2.5	\$414	\$173	N/A	\$41.40	N/A
GRT5NHTP	66 x 30 x 1	56	2.44	\$443	\$184	N/A	\$44.30	N/A
GRT6NTP	72 x 30 x 1	62	3	\$449	\$194	N/A	\$44.90	N/A
GRT7NTP	84 x 30 x 1	72	7.5	\$536	\$231	N/A	\$53.60	N/A
GRT8NTP	96 x 30 x 1	80	8.5	\$592	\$241	N/A	\$59.20	N/A
GRT5TP	60 x 36 x 1	70	6.6	\$472	\$188	N/A	\$47.20	N/A
GRT5HTP	66 x 36 x 1	79	7.21	\$481	\$195	N/A	\$48.10	N/A
GRT6TP	72 x 36 x 1	72	8	\$481	\$195	N/A	\$48.10	N/A
GRT7TP	84 x 36 x 1	85	8.75	\$591	\$241	N/A	\$59.10	N/A
GRT8TP	96 x 36 x 1	94	9	\$648	\$275	N/A	\$64.80	N/A

High pressure laminate, knife edge

GRT5NTPLK	60 x 30 x 1.19	55	5	\$1218	N/A	N/A	N/A	N/A
GRT5NHTPLK	66 x 30 x 1.19	67	5.5	\$1330	N/A	N/A	N/A	N/A
GRT6NTPLK	72 x 30 x 1.19	74	6	\$1448	N/A	N/A	N/A	N/A
GRT7NTPLK	84 x 30 x 1.19	86	7	\$1668	N/A	N/A	N/A	N/A
GRT8NTPLK	96 x 30 x 1.19	96	8	\$1898	N/A	N/A	N/A	N/A
GRT5TPLK	60 x 36 x 1.19	84	6	\$1448	N/A	N/A	N/A	N/A
GRT5HTPLK	66 x 36 x 1.19	95	6.5	\$1581	N/A	N/A	N/A	N/A
GRT6TPLK	72 x 36 x 1.19	86	7	\$1719	N/A	N/A	N/A	N/A
GRT7TPLK	84 x 36 x 1.19	102	8	\$1990	N/A	N/A	N/A	N/A
GRT8TPLK	96 x 36 x 1.19	113	9	\$2266	N/A	N/A	N/A	N/A

Veneer ⁽²⁾

GRT5NTPV	60 x 30 x 1.19	55	5	\$1663	N/A	N/A	N/A	\$77
GRT5NHTPV	66 x 30 x 1.19	67	5.5	\$1770	N/A	N/A	N/A	\$77
GRT6NTPV	72 x 30 x 1.19	74	6	\$1898	N/A	N/A	N/A	\$97
GRT7NTPV	84 x 30 x 1.19	86	7	\$2204	N/A	N/A	N/A	\$112
GRT8NTPV	96 x 30 x 1.19	96	8	\$2507	N/A	N/A	N/A	\$128
GRT5TPV	60 x 36 x 1.19	84	6	\$1898	N/A	N/A	N/A	\$97
GRT5HTPV	66 x 36 x 1.19	95	6.5	\$2072	N/A	N/A	N/A	\$128
GRT6TPV	72 x 36 x 1.19	86	7	\$2251	N/A	N/A	N/A	\$143
GRT7TPV	84 x 36 x 1.19	102	8	\$2614	N/A	N/A	N/A	\$164
GRT8TPV	96 x 36 x 1.19	113	9	\$2982	N/A	N/A	N/A	\$179

Solid surface, flat edge ⁽³⁾⁽⁴⁾

GRT5NTPSF	60 x 29.8 x 1.25	94	3.4	\$4106	N/A	\$436	\$206	N/A
GRT5NHTPSF	66 x 29.8 x 1.25	104	3.8	\$4406	N/A	\$506	\$206	N/A
GRT6NTPSF	71.8 x 29.8 x 1.25	113	4.1	\$5029	N/A	\$706	\$206	N/A
GRT7NTPSF	84 x 29.8 x 1.25	132	4.8	\$5836	N/A	\$694	\$206	N/A
GRT8NTPSF	96 x 29.8 x 1.25	150	5.4	\$6423	N/A	\$900	\$206	N/A
GRT5TPSF	60 x 36 x 1.25	113	4.1	\$5465	N/A	\$647	\$206	N/A
GRT5HTPSF	66 x 36 x 1.25	124	4.5	\$5641	N/A	\$647	\$206	N/A
GRT6TPSF	71.8 x 36 x 1.25	135	4.9	\$6229	N/A	\$706	\$206	N/A
GRT7TPSF	84 x 36 x 1.25	158	5.7	\$6776	N/A	\$853	\$206	N/A
GRT8TPSF	96 x 36 x 1.25	180	6.5	\$7271	N/A	\$894	\$206	N/A

Solid surface, knife edge ⁽³⁾⁽⁴⁾

GRT5NTPSK	60 x 29.8 x 1.25	94	3.4	\$4494	N/A	\$494	\$206	N/A
GRT5NHTPSK	66 x 29.8 x 1.25	104	3.8	\$4853	N/A	\$576	\$206	N/A
GRT6NTPSK	71.8 x 29.8 x 1.25	113	4.1	\$5470	N/A	\$789	\$206	N/A
GRT7NTPSK	84 x 29.8 x 1.25	132	4.8	\$6277	N/A	\$789	\$206	N/A
GRT8NTPSK	96 x 29.8 x 1.25	150	5.4	\$6971	N/A	\$1005	\$206	N/A
GRT5TPSK	60 x 36 x 1.25	113	4.1	\$6053	N/A	\$729	\$206	N/A
GRT5HTPSK	66 x 36 x 1.25	124	4.5	\$6206	N/A	\$741	\$206	N/A
GRT6TPSK	71.8 x 36 x 1.25	135	4.9	\$6876	N/A	\$812	\$206	N/A
GRT7TPSK	84 x 36 x 1.25	158	5.7	\$7429	N/A	\$970	\$206	N/A
GRT8TPSK	96 x 36 x 1.25	180	6.5	\$7911	N/A	\$1023	\$206	N/A

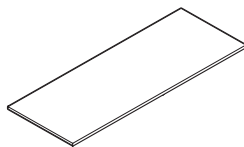

Rectangular Tops

Applicable bases to use with above tops - two bases required: GRB22H26, GRB22, GRB22H35, GRB22H41 round bases or GSB19H26, GSB19, GSB19H35, GSB19H41 square bases. Tops feature metal inserts for ease of assembly to base.

Required specifications

Top finish
Edge finish ⁽¹⁾

Optional specifications

HP laminate ⁽¹⁾ Knife edge ⁽²⁾
Grade 2 solid surface ⁽³⁾
3" radiused corners ⁽⁴⁾
Grommet position or power block cut-out

Applicable bases (two required)

Round bases:
GRB22H26, GRB22, GRB22H35, GRB22H41
Square bases:
GSB19H26, GSB19, GSB19H35, GSB19H41

Accessories

Power block

RACETRACK TOPS, 60" - 96"W

MODEL # DIMENSIONS WT/LB. CUBIC FT. LIST PRICE HP ADD KS ADD

W x D x H

Thermally fused laminate, flat edge ⁽¹⁾

GRC5NTP	60 x 30 x 1	46	2.5	\$422	\$178	N/A
GRC5NHTP	66 x 30 x 1	56	2.44	\$457	\$187	N/A
GRC6NTP	72 x 30 x 1	62	3	\$459	\$195	N/A
GRC7NTP	84 x 30 x 1	72	7.5	\$548	\$233	N/A
GRC8NTP	96 x 30 x 1	80	8.5	\$601	\$244	N/A
GRC5TP	60 x 36 x 1	70	6.6	\$483	\$195	N/A
GRC5HTP	66 x 36 x 1	79	7.21	\$488	\$199	N/A
GRC6TP	72 x 36 x 1	72	7.5	\$488	\$199	N/A
GRC7TP	84 x 36 x 1	85	8.75	\$600	\$244	N/A
GRC8TP	96 x 36 x 1	94	9	\$659	\$275	N/A

High pressure laminate, knife edge

GRC5NTPLK	60 x 30 x 1.19	55	5	\$1673	N/A	N/A
GRC5NHTPLK	66 x 30 x 1.19	67	5.5	\$1826	N/A	N/A
GRC6NTPLK	72 x 30 x 1.19	74	6	\$1990	N/A	N/A
GRC7NTPLK	84 x 30 x 1.19	86	7	\$2133	N/A	N/A
GRC8NTPLK	96 x 30 x 1.19	96	8	\$2287	N/A	N/A
GRC5TPLK	60 x 36 x 1.19	84	6	\$1826	N/A	N/A
GRC5HTPLK	66 x 36 x 1.19	95	6.5	\$1980	N/A	N/A
GRC6TPLK	72 x 36 x 1.19	86	7	\$2144	N/A	N/A
GRC7TPLK	84 x 36 x 1.19	102	8	\$2451	N/A	N/A
GRC8TPLK	96 x 36 x 1.19	113	9	\$2758	N/A	N/A

Veneer ⁽²⁾

GRC5NTPV	60 x 30 x 1.19	55	5	\$1882	N/A	\$271
GRC5NHTPV	66 x 30 x 1.19	67	5.5	\$2026	N/A	\$292
GRC6NTPV	72 x 30 x 1.19	74	6	\$2175	N/A	\$312
GRC7NTPV	84 x 30 x 1.19	86	7	\$2527	N/A	\$363
GRC8NTPV	96 x 30 x 1.19	96	8	\$2870	N/A	\$415
GRC5TPV	60 x 36 x 1.19	84	6	\$2175	N/A	\$312
GRC5HTPV	66 x 36 x 1.19	95	6.5	\$2374	N/A	\$343
GRC6TPV	72 x 36 x 1.19	86	7	\$2578	N/A	\$373
GRC7TPV	84 x 36 x 1.19	102	8	\$2998	N/A	\$435
GRC8TPV	96 x 36 x 1.19	113	9	\$3417	N/A	\$496

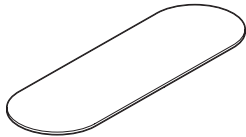

Racetrack Tops

Applicable bases to use with above tops - two bases required: GRB22H26, GRB22, GRB22H35, GRB22H41 round bases or GSB19H26, GSB19, GSB19H35, GSB19H41 square bases. Tops feature metal inserts for ease of assembly to base.

Required specifications

Top finish
Edge finish ⁽¹⁾

Optional specifications

HP laminate ⁽¹⁾
Knife edge ⁽²⁾
Grommet position or power block cut-out

Applicable bases (two required)

Round bases:
GRB22H26, GRB22, GRB22H35, GRB22H41
Square bases:
GSB19H26, GSB19, GSB19H35, GSB19H41

Accessories

Power block

BOAT SHAPE TOPS, 60" - 96"W **MODEL #** **DIMENSIONS** **WT/LB.** **CUBIC FT.** **LIST PRICE** **HP ADD** **KS ADD**

W x D x H

Thermally fused laminate, flat edge ⁽¹⁾

GBT5NTP	60 x 30 x 1	46	2.5	\$422	\$178	N/A
GBT5NHTP	66 x 30 x 1	56	2.44	\$457	\$187	N/A
GBT6NTP	72 x 30 x 1	62	3	\$459	\$195	N/A
GBT7NTP	84 x 30 x 1	72	7.5	\$548	\$233	N/A
GBT8NTP	96 x 30 x 1	80	8.5	\$601	\$244	N/A
GBT5TP	60 x 36 x 1	70	6.6	\$483	\$195	N/A
GBT5HTP	66 x 36 x 1	79	7.21	\$488	\$199	N/A
GBT6TP	72 x 36 x 1	72	7.5	\$488	\$199	N/A
GBT7TP	84 x 36 x 1	85	8.75	\$600	\$244	N/A
GBT8TP	96 x 36 x 1	94	9	\$659	\$275	N/A

High pressure laminate, knife edge

GBT5NTPLK	60 x 30 x 1.19	55	5	\$1673	N/A	N/A
GBT5NHTPLK	66 x 30 x 1.19	67	5.5	\$1826	N/A	N/A
GBT6NTPLK	72 x 30 x 1.19	74	6	\$1990	N/A	N/A
GBT7NTPLK	84 x 30 x 1.19	86	7	\$2133	N/A	N/A
GBT8NTPLK	96 x 30 x 1.19	96	8	\$2287	N/A	N/A
GBT5TPLK	60 x 36 x 1.19	84	6	\$1826	N/A	N/A
GBT5HTPLK	66 x 36 x 1.19	95	6.5	\$1980	N/A	N/A
GBT6TPLK	72 x 36 x 1.19	86	7	\$2144	N/A	N/A
GBT7TPLK	84 x 36 x 1.19	102	8	\$2451	N/A	N/A
GBT8TPLK	96 x 36 x 1.19	113	9	\$2758	N/A	N/A

Veneer ⁽²⁾

GBT5NTPV	60 x 30 x 1.19	55	5	\$1882	N/A	\$271
GBT5NHTPV	66 x 30 x 1.19	67	5.5	\$2026	N/A	\$292
GBT6NTPV	72 x 30 x 1.19	74	6	\$2175	N/A	\$312
GBT7NTPV	84 x 30 x 1.19	86	7	\$2527	N/A	\$363
GBT8NTPV	96 x 30 x 1.19	96	8	\$2870	N/A	\$415
GBT5TPV	60 x 36 x 1.19	84	6	\$2175	N/A	\$312
GBT5HTPV	66 x 36 x 1.19	95	6.5	\$2374	N/A	\$343
GBT6TPV	72 x 36 x 1.19	86	7	\$2578	N/A	\$373
GBT7TPV	84 x 36 x 1.19	102	8	\$2998	N/A	\$435
GBT8TPV	96 x 36 x 1.19	113	9	\$3417	N/A	\$496

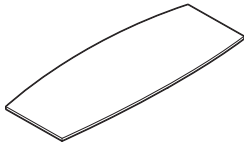

Boat Shape Tops

Applicable bases to use with above tops - two bases required: GRB22H26, GRB22, GRB22H35, GRB22H41 round bases or GSB19H26, GSB19, GSB19H35, GSB19H41 square bases. Tops feature metal inserts for ease of assembly to base.

- GBTxNTP/GBTxNHTP: 30"D across center and 24"D at ends.
- GBTxTP/GBTxHTP: 36"D across center and 28"D at ends.

Required specifications

Top finish
Edge finish ⁽¹⁾

Optional specifications

HP laminate ⁽¹⁾
Knife edge ⁽²⁾
Grromet position or power block cut-out

Applicable bases (two required)

Round bases:
GRB22H26, GRB22, GRB22H35, GRB22H41
Square bases:
GSB19H26, GSB19, GSB19H35, GSB19H41

Accessories

Power block

S SWAP™ TABLES

BASES FOR TOPS 60" - 96"W

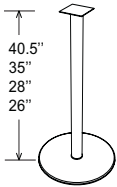

22" Dia Round Bases

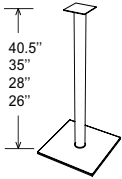

18.5" Square Bases

MODEL #	DIMENSIONS	WT/LB.	CUBIC FT.	LIST PRICE	BCH / CHM	ACO / SBR
---------	------------	--------	-----------	------------	-----------	-----------

W x D x H

Order the quantity of bases as indicated by each top size.

GRB22H26	22 x - x 26	55	8.63	\$793	\$147	\$221
GRB22	22 x - x 27.5	55	9.33	\$793	\$147	\$221
GRB22H35	22 x - x 35	57.1	12	\$831	\$164	\$253
GRB22H41	22 x - x 40.5	58.3	14	\$844	\$171	\$259

GRB22H26 - lounge height **GRB22** - seated height **GRB22H35** - counter height **GRB22H41** - bar height

GSB19H26	18.5 x 18.5 x 26	50	5.94	\$857	\$136	\$212
GSB19	18.5 x 18.5 x 27.5	50	6.06	\$857	\$136	\$212
GSB19H35	18.5 x 18.5 x 35	51.8	7.52	\$906	\$151	\$262
GSB19H41	18.5 x 18.5 x 40.5	53.2	8.77	\$937	\$166	\$267

GSB19H26 - lounge height **GSB19** - seated height **GSB19H35** - counter height **GSB19H41** - bar height

Base comes fully assembled and features 0.5" adjustable glides to level on uneven surfaces. Screws included with base for attaching to appropriate top(s). Available in paint and plated finishes as listed on page 323. Upcharge applies on plated finishes.

Required Specifications

Finish

Optional Specifications

Plated finish

RECTANGULAR TOPS, 96" - 144"W

MODEL #	DIMENSIONS	WT/LB.	CUBIC FT.	LIST PRICE	HP ADD	R3 ADD	KS ADD
W x D x H							
Thermally fused laminate, flat edge (1 piece top - 2 bases required) ⁽¹⁾⁽⁴⁾							
GRT8MTP	96 x 42 x 1	128	11.84	\$1221	\$504	\$122.10	N/A
GRT8WTP	96 x 48 x 1	190	14	\$1221	\$512	\$122.10	N/A
Thermally fused laminate, flat edge (2 piece tops - 3 bases required) ⁽¹⁾⁽⁴⁾							
GRT10WTP	120 x 48 x 1	220	17	\$1537	\$636	\$153.70	N/A
GRT12WTP	144 x 48 x 1	262	21	\$1791	\$739	\$179.10	N/A
High pressure laminate, knife edge (1 piece top - 2 bases required)							
GRT8MTPLK	96 x 42 x 1.19	154	11	\$3069	N/A	N/A	N/A
GRT8WTPLK	96 x 48 x 1.19	228	12	\$3432	N/A	N/A	N/A
High pressure laminate, knife edge (2 piece tops - 3 bases required)							
GRT10WTPLK	120 x 48 x 1.19	264	15	\$4630	N/A	N/A	N/A
GRT12WTPLK	144 x 48 x 1.19	314	18	\$5524	N/A	N/A	N/A
Veneer (1 piece top - 2 bases required) ⁽²⁾							
GRT8MTPV	96 x 42 x 1.19	154	11	\$3903	N/A	N/A	\$378
GRT8WTPV	96 x 48 x 1.19	228	12	\$4389	N/A	N/A	\$430
Veneer (2 piece tops - 3 bases required) ⁽²⁾							
GRT10WTPV	120 x 48 x 1.19	264	15	\$5821	N/A	N/A	\$573
GRT12WTPV	144 x 48 x 1.19	314	18	\$6952	N/A	N/A	\$685

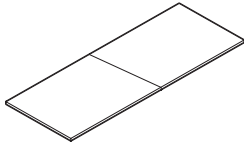

Rectangular Tops

Applicable bases to use with above tops: GRB28 round base or GSB23 square base (28" H).
Two bases required for 96"W tops or three bases required for 120" and 144"W tops.
 Tops feature metal inserts for ease of assembly to base.

RACETRACK TOPS, 96" - 144"W

Thermally fused laminate, flat edge (1 piece top - 2 bases required) ⁽¹⁾							
GRC8MTP	96 x 42 x 1	128	11.84	\$1240	\$504	N/A	N/A
GRC8WTP	96 x 48 x 1	190	14	\$1240	\$512	N/A	N/A
Thermally fused laminate, flat edge (2 piece tops - 3 bases required) ⁽¹⁾							
GRC10WTP	120 x 48 x 1	220	17	\$1560	\$636	N/A	N/A
GRC12WTP	144 x 48 x 1	262	21	\$1818	\$739	N/A	N/A
High pressure laminate, knife edge (1 piece top - 2 bases required)							
GRC8MTPLK	96 x 42 x 1.19	154	11	\$3658	N/A	N/A	N/A
GRC8WTPLK	96 x 48 x 1.19	228	12	\$4169	N/A	N/A	N/A
High pressure laminate, knife edge (2 piece tops - 3 bases required)							
GRC10WTPLK	120 x 48 x 1.19	264	15	\$5192	N/A	N/A	N/A
GRC12WTPLK	144 x 48 x 1.19	314	18	\$6215	N/A	N/A	N/A
Veneer (1 piece top - 2 bases required) ⁽²⁾							
GRC8MTPV	96 x 42 x 1.19	154	11	\$4630	N/A	N/A	\$455
GRC8WTPV	96 x 48 x 1.19	228	12	\$5141	N/A	N/A	\$506
Veneer (2 piece tops - 3 bases required) ⁽²⁾							
GRC10WTPV	120 x 48 x 1.19	264	15	\$6727	N/A	N/A	\$666
GRC12WTPV	144 x 48 x 1.19	314	18	\$7954	N/A	N/A	\$788

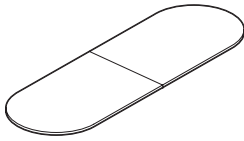

Racetrack Tops

Applicable bases to use with above tops: GRB28 round base or GSB23 square base (28" H).
Two bases required for 96"W tops or three bases required for 120" and 144"W tops.
 Tops feature metal inserts for ease of assembly to base.

Required specifications	Optional specifications	Applicable bases (two or three required)	Accessories
Top finish Edge finish ⁽¹⁾	HP laminate ⁽¹⁾ Knife edge ⁽²⁾ 3" radiused corners ⁽⁴⁾ Grommet position or power block cut-out	GRB28 - round GSB23 - square	Power block

BOAT SHAPE TOPS, 96" - 144"W

MODEL #	DIMENSIONS	WT/LB.	CUBIC FT.	LIST PRICE	HP ADD	KS ADD
---------	------------	--------	-----------	------------	--------	--------

W x D x H

Thermally fused laminate, flat edge (1 piece top - 2 bases required) ⁽¹⁾

GBT8MTP	96 x 42 x 1	128	11.84	\$1240	\$504	N/A
GBT8WTP	96 x 48 x 1	190	14	\$1240	\$512	N/A

Thermally fused laminate, flat edge (2 piece tops - 3 bases required) ⁽¹⁾

GBT10WTP	120 x 48 x 1	220	17	\$1560	\$636	N/A
GBT12WTP	144 x 48 x 1	262	21	\$1818	\$739	N/A

High pressure laminate, knife edge (1 piece top - 2 bases required)

GBT8MTPLK	96 x 42 x 1.19	154	11	\$3658	N/A	N/A
GBT8WTPLK	96 x 48 x 1.19	228	12	\$4169	N/A	N/A

High pressure laminate, knife edge (2 piece tops - 3 bases required)

GBT10WTPLK	120 x 48 x 1.19	264	15	\$5192	N/A	N/A
GBT12WTPLK	144 x 48 x 1.19	314	18	\$6215	N/A	N/A

Veneer (1 piece top - 2 bases required) ⁽²⁾

GBT8MTPV	96 x 42 x 1.19	154	11	\$4630	N/A	\$455
GBT8WTPV	96 x 48 x 1.19	228	12	\$5141	N/A	\$506

Veneer (2 piece tops - 3 bases required) ⁽²⁾

GBT10WTPV	120 x 48 x 1.19	264	15	\$6727	N/A	\$666
GBT12WTPV	144 x 48 x 1.19	314	18	\$7954	N/A	\$788

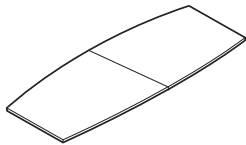

Boat Shape Tops

Applicable bases to use with above tops: GRB28 round base or GSB23 square base (28"H).

Two bases required for 96"W tops or three bases required for 120" and 144"W tops.

Tops feature metal inserts for ease of assembly to base.

- GBTxMTP: 42"D at center and 33"D at ends.
- GBTxxWTP: 48"D at center and 38"D at ends.

BASES FOR TOPS 60" - 96"W

MODEL #	DIMENSIONS	WT/LB.	CUBIC FT.	LIST PRICE	BCH / CHM	ACO / SBR
---------	------------	--------	-----------	------------	-----------	-----------

W x D x H

BASE VALID FOR TOPS ON PAGES 345-346:

Order the quantity of bases as indicated by each top size.

GRB28	28 x - x 27.5	100	15.63	\$1250	\$147	\$372
-------	---------------	-----	-------	---------------	--------------	--------------

seated height

GSB23	22.5 x 22.5 x 27.5	82	9.33	\$1146	\$136	\$235
-------	--------------------	----	------	---------------	--------------	--------------

seated height

Base comes fully assembled and features 0.5" adjustable glides to level on uneven surfaces. Screws included with base for attaching to appropriate top(s). Available in paint and plated finishes as listed on page 323. Upcharge applies on plated finishes.

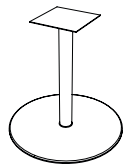

28" Dia Round Base

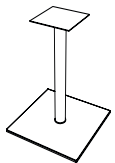

23" Square Base

Required specifications

Top finish
Edge finish ⁽¹⁾
Base finish

Optional specifications

HP laminate ⁽¹⁾
Knife edge ⁽²⁾
Grommet position or power block cut-out
Base plated finish

Applicable bases (two or three required)

GRB28 - round
GSB23 - square

Accessories

Power block

RECTANGULAR TOPS FOR DUAL COLUMN BASE

MODEL #	DIMENSIONS	WT/LB.	CUBIC FT.	LIST PRICE	HP ADD	R3 ADD	KS ADD
W x D x H							
Thermally fused laminate, flat edge ⁽¹⁾⁽⁴⁾							
GRTD5TP	60 x 36 x 1	60	6.6	\$472	\$188	\$47.20	N/A
GRTD5HTP	66 x 36 x 1	69	7.21	\$481	\$195	\$48.10	N/A
GRTD6TP	72 x 36 x 1	75	7.82	\$481	\$195	\$48.10	N/A
GRTD5MTP	60 x 42 x 1	73	7.62	\$633	\$273	\$63.30	N/A
GRTD5HMTP	66 x 42 x 1	81	8.32	\$675	\$294	\$67.50	N/A
GRTD6MTP	72 x 42 x 1	89	9.02	\$694	\$300	\$69.40	N/A
High pressure laminate, knife edge							
GRTD5TPLK	60 x 36 x 1.19	72	6	\$1448	N/A	N/A	N/A
GRTD5HTPLK	66 x 36 x 1.19	83	6.5	\$1581	N/A	N/A	N/A
GRTD6TPLK	72 x 36 x 1.19	90	7	\$1719	N/A	N/A	N/A
GRTD5MTPLK	60 x 42 x 1.19	88	7	\$1668	N/A	N/A	N/A
GRTD5HMTPK	66 x 42 x 1.19	97	7.5	\$1832	N/A	N/A	N/A
GRTD6MTPLK	72 x 42 x 1.19	107	8	\$1990	N/A	N/A	N/A
Veneer ⁽²⁾							
GRTD5TPV	60 x 36 x 1.19	72	6	\$1898	N/A	N/A	\$184
GRTD5HTPV	66 x 36 x 1.19	83	6.5	\$2072	N/A	N/A	\$199
GRTD6TPV	72 x 36 x 1.19	90	7	\$2251	N/A	N/A	\$215
GRTD5MTPV	60 x 42 x 1.19	88	7	\$2195	N/A	N/A	\$210
GRTD5HMTPV	66 x 42 x 1.19	97	7.5	\$2405	N/A	N/A	\$230
GRTD6MTPV	72 x 42 x 1.19	107	8	\$2614	N/A	N/A	\$256



Rectangular Tops

Tops feature metal inserts for ease of assembly to base. One dual column base (**GDCB36H28**) required. Limited cut-out options available for power modules, include E2 or FOG2 only. Power modules corresponding to applicable cut-out codes ordered separately.

RACETRACK TOPS FOR DUAL COLUMN BASE

MODEL #	DIMENSIONS	WT/LB.	CUBIC FT.	LIST PRICE	HP ADD	R3 ADD	KS ADD
Thermally fused laminate, flat edge ⁽¹⁾							
GRCD5TP	60 x 36 x 1	60	6.6	\$483	\$195	N/A	N/A
GRCD5HTP	66 x 36 x 1	69	7.21	\$488	\$199	N/A	N/A
GRCD6TP	72 x 36 x 1	75	7.82	\$488	\$199	N/A	N/A
GRCD5MTP	60 x 42 x 1	73	7.62	\$633	\$273	N/A	N/A
GRCD5HMTP	66 x 42 x 1	81	8.32	\$675	\$294	N/A	N/A
GRCD6MTP	72 x 42 x 1	89	9.02	\$694	\$300	N/A	N/A
High pressure laminate, knife edge							
GRCD5TPLK	60 x 36 x 1.19	72	6	\$1995	N/A	N/A	N/A
GRCD5HTPLK	66 x 36 x 1.19	83	6.5	\$2123	N/A	N/A	N/A
GRCD6TPLK	72 x 36 x 1.19	90	7	\$2251	N/A	N/A	N/A
GRCD5MTPLK	60 x 42 x 1.19	88	7	\$2379	N/A	N/A	N/A
GRCD5HMTPK	66 x 42 x 1.19	97	7.5	\$2507	N/A	N/A	N/A
GRCD6MTPLK	72 x 42 x 1.19	107	8	\$2635	N/A	N/A	N/A
Veneer ⁽²⁾							
GRCD5TPV	60 x 36 x 1.19	72	6	\$2379	N/A	N/A	\$230
GRCD5HTPV	66 x 36 x 1.19	83	6.5	\$2507	N/A	N/A	\$241
GRCD6TPV	72 x 36 x 1.19	90	7	\$2635	N/A	N/A	\$256
GRCD5MTPV	60 x 42 x 1.19	88	7	\$2762	N/A	N/A	\$271
GRCD5HMTPV	66 x 42 x 1.19	97	7.5	\$2891	N/A	N/A	\$282
GRCD6MTPV	72 x 42 x 1.19	107	8	\$3018	N/A	N/A	\$292



Racetrack Tops

Tops feature metal inserts for ease of assembly to base. One dual column base (**GDCB36H28**) required. Limited cut-out options available for power modules, include E2 or FOG2 only. Power modules corresponding to applicable cut-out codes ordered separately.

Required specifications	Optional specifications	Applicable bases	Accessories
Top finish Edge finish ⁽¹⁾	HP laminate ⁽¹⁾ Knife edge ⁽²⁾ 3" radiused corners ⁽⁴⁾ Grommet position or power block cut-out	GDCB36H28	Power block

BOAT SHAPE TOPS FOR DUAL COLUMN BASE

MODEL #	DIMENSIONS	WT/LB.	CUBIC FT.	LIST PRICE	HP ADD	KS ADD
---------	------------	--------	-----------	------------	--------	--------

W x D x H

Thermally fused laminate, flat edge ⁽¹⁾

GBTD5TP	60 x 36 x 1	60	6.6	\$483	\$195	N/A
GBTD5HTP	66 x 36 x 1	69	7.21	\$488	\$199	N/A
GBTD6TP	72 x 36 x 1	75	7.82	\$488	\$199	N/A
GBTD5MTP	60 x 42 x 1	73	7.62	\$633	\$273	N/A
GBTD5HMTP	66 x 42 x 1	81	8.32	\$675	\$294	N/A
GBTD6MTP	72 x 42 x 1	89	9.02	\$694	\$300	N/A

High pressure laminate, knife edge

GBTD5TPLK	60 x 36 x 1.19	72	6	\$1995	N/A	N/A
GBTD5HTPLK	66 x 36 x 1.19	83	6.5	\$2123	N/A	N/A
GBTD6TPLK	72 x 36 x 1.19	90	7	\$2251	N/A	N/A
GBTD5MTPLK	60 x 42 x 1.19	88	7	\$2379	N/A	N/A
GBTD5HMTPLK	66 x 42 x 1.19	97	7.5	\$2507	N/A	N/A
GBTD6MTPLK	72 x 42 x 1.19	107	8	\$2635	N/A	N/A

Veneer ⁽²⁾

GBTD5TPV	60 x 36 x 1.19	72	6	\$2379	N/A	\$230
GBTD5HTPV	66 x 36 x 1.19	83	6.5	\$2507	N/A	\$241
GBTD6TPV	72 x 36 x 1.19	90	7	\$2635	N/A	\$256
GBTD5MTPV	60 x 42 x 1.19	88	7	\$2762	N/A	\$271
GBTD5HMTPV	66 x 42 x 1.19	97	7.5	\$2891	N/A	\$282
GBTD6MTPV	72 x 42 x 1.19	107	8	\$3018	N/A	\$292

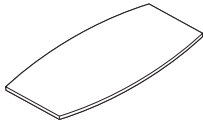

Boat Shape Tops

Tops feature metal inserts for ease of assembly to base. One dual column base (**GDCB36H28**) required.

Limited cut-out options available for power modules, include E2 or FOG2 only. Power modules corresponding to applicable cut-out codes ordered separately.

- GBTDxTP/GBTDxHTP: 36"D at center and 28"D at ends
- GBTDxMTP/GBTDxHMTP: 42"D at center and 33"D at ends.

DUAL COLUMN BASE FOR GxTDxxx TOPS

MODEL #	DIMENSIONS	WT/LB.	CUBIC FT.	LIST PRICE	BCH / CHM	ACO / SBR
---------	------------	--------	-----------	------------	-----------	-----------

W x D x H

BASE VALID FOR TOPS ON PAGES 347-348:

GDCB36H28	19 x 36 x 28	116.23	12.16	\$2103	\$582	\$768
-----------	--------------	--------	-------	---------------	--------------	--------------

seated height

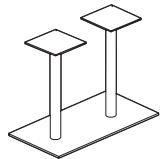

28"H Dual Column Base

Base ships knocked-down; assembly required. Features 0.5" adjustable glides to level on uneven surfaces. Screws included with base for attaching to appropriate top(s). Available in paint and plated finishes as listed on page 323. Upcharge applies on plated finishes.

Required specifications

Top finish
Edge finish ⁽¹⁾
Base finish

Optional specifications

HP laminate ⁽¹⁾
Knife edge ⁽²⁾
Grommet position or power block cut-out
Base plated finish

Applicable bases

GDCB36H28

Accessories

Power block

HUDDLE TABLES OVERVIEW

Bring teams together to huddle, share and collaborate.

Three heights available - seated desk height: 29", counter height: 36", bar height: 41.5" with D top, wedge, rectangular or soft ellipse shaped tops.

Laminate kits (consisting of laminate top and U-base) are sold separately from metal bases for huddle tables. Tops include metal inserts for ease of assembly to metal base. All tops are standard with an edge scoop to help manage cables from wall mounted flat screen monitors and/or edge mounting power module (PS305057/PS305002 as an example). Support channels are included with tops over 60" wide.

Metal bases ship fully assembled and include 0.5" adjustable glides and metal screws for attaching to the top. Be sure to specify bases specific to huddle tables GRHB22Hxx or GSB19Hxx.

D-TOP HUDDLE TABLES

MODEL #	DIMENSIONS	WT/LB.	CUBIC FT.	LIST PRICE	HP ADD
W x D x H					
GDH364829	36 x 48 x 29	77.05	3.94	\$952	\$188
GDH366029	36 x 60 x 29	86.95	4.46	\$1162	\$188
GDH367229	36 x 72 x 29	97	4.99	\$1295	\$195
GDH426029	42 x 60 x 29	99.82	5.18	\$1301	\$273
GDH427229	42 x 72 x 29	111.5	5.79	\$1459	\$300
GDH428429	42 x 84 x 29	123.1	11.98	\$1616	\$477
GDH429629	42 x 96 x 29	134.74	13.31	\$1746	\$504
GDH486029	48 x 60 x 29	112.6	5.89	\$1453	\$374
GDH487229	48 x 72 x 29	126	6.58	\$1626	\$443
GDH488429	48 x 84 x 29	139.24	13.5	\$1738	\$469
GDH489629	48 x 96 x 29	152.56	15	\$1880	\$512

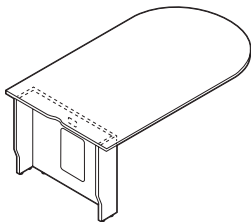

29" H D-Top Huddle

Laminate U-base support is 8"D with 7" inside clearance to wall. Access wall through 14.5"H x 9.5"W hinged door with touch latch in front panel of u-base support. U-base includes 0.5" adjustable glides. U-base side panels are tapered at the bottom to clear most baseboards. **Cut-out locations available in positions 1 or 2 only (except for model GDH364829 - cut-out position available in position 1 only).**

- Metal bases sold separately. Compatible with **GRHB22H28** or **GSB19H28** only, requires one base.

GDH364836	36 x 48 x 36	85.95	4.31	\$980	\$188
GDH366036	36 x 60 x 36	95.85	4.84	\$1189	\$188
GDH367236	36 x 72 x 36	105.9	5.37	\$1323	\$195
GDH426036	42 x 60 x 36	109.82	5.61	\$1332	\$273
GDH427236	42 x 72 x 36	121.5	6.22	\$1491	\$300
GDH428436	42 x 84 x 36	133.1	12.4	\$1646	\$477
GDH429636	42 x 96 x 36	144.74	13.75	\$1777	\$504
GDH486036	48 x 60 x 36	123.6	6.38	\$1488	\$374
GDH487236	48 x 72 x 36	137	7.08	\$1661	\$443
GDH488436	48 x 84 x 36	150.24	14	\$1773	\$469
GDH489636	48 x 96 x 36	163.56	15.5	\$1916	\$512

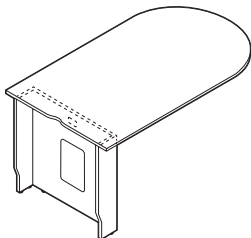

36" H D-Top Huddle

Laminate U-base support is 8"D with 7" inside clearance to wall. Access wall through 14.5"H x 9.5"W hinged door with touch latch in front panel of U-base support. U-base includes 0.5" adjustable glides. U-base side panels are tapered at the bottom to clear most baseboards. **Cut-out locations available in positions 1 or 2 only (except for model GDH364836 - cut-out position available in position 1 only).**

- Metal bases sold separately. Compatible with **GRHB22H35** or **GSB19H35** only, requires one base.

Required Specifications

Top finish
Base finish

Optional Specifications

HP laminate
Grommet position or power block cut-out

Accessories

Power block

S SWAP™ TABLES

D-TOP HUDDLE TABLES

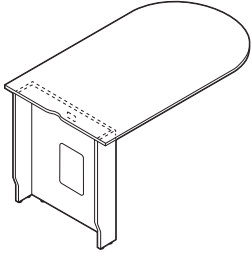

41.5"H D-Top Huddle

MODEL #	DIMENSIONS W x D x H	WT/LB.	CUBIC FT.	LIST PRICE	HP ADD
GDH364841	36 x 48 x 41.5	92.65	4.58	\$1032	\$188
GDH366041	36 x 60 x 41.5	102.55	5.11	\$1241	\$188
GDH367241	36 x 72 x 41.5	112.6	5.63	\$1375	\$195
GDH426041	42 x 60 x 41.5	117.32	5.92	\$1392	\$273
GDH427241	42 x 72 x 41.5	129	6.53	\$1549	\$300
GDH428441	42 x 84 x 41.5	140.6	12.72	\$1706	\$477
GDH429641	42 x 96 x 41.5	152.24	14.06	\$1837	\$504
GDH486041	48 x 60 x 41.5	130.1	6.74	\$1552	\$374
GDH487241	48 x 72 x 41.5	143.5	7.43	\$1726	\$443
GDH488441	48 x 84 x 41.5	156.74	14.53	\$1839	\$469
GDH489641	48 x 96 x 41.5	170.06	15.85	\$1980	\$512

Laminate U-base support is 8"D with 7" inside clearance to wall. Access wall through 14.5"H x 9.5"W hinged door with touch latch in front panel of U-base support. U-base includes 0.5" adjustable glides. U-base side panels are tapered at the bottom to clear most baseboards. **Cut-out locations available in positions 1 or 2 only (except for model GDH364841 - cut-out position available in position 1 only).**

- Metal bases sold separately. Compatible with **GRHB22H41** or **GSHB19H41** only, requires one base.

Required Specifications

Top finish
Base finish

Optional Specifications

HP laminate
Grommet position or power block cut-out

Accessories

Power block

WEDGE HUDDLE TABLES **MODEL #** **DIMENSIONS** **WT/LB.** **CUBIC FT.** **LIST PRICE** **HP ADD**

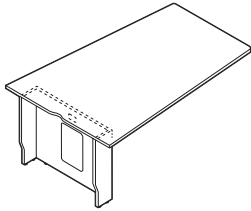

29"H Wedge Huddle

	W x D x H					
GWH486029	48 x 60 x 29	112.6	5.89	\$1448	\$374	
GWH487229	48 x 72 x 29	126	6.58	\$1626	\$443	
GWH488429	48 x 84 x 29	139.24	13.5	\$1738	\$469	
GWH489629	48 x 96 x 29	152.56	15	\$1880	\$512	

Laminate U-base support is 8"D with 7" inside clearance to wall. Access wall through 14.5"H x 9.5"W hinged door with touch latch in front panel of U-base support. U-base includes 0.5" adjustable glides. U-base side panels are tapered at the bottom to clear most baseboards. **Cut-out locations available in positions 1 or 2 only.**

- Metal bases sold separately. Compatible with **GRHB22H28** or **GSHB19H28** only, requires one base.

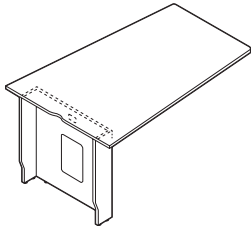

36"H Wedge Huddle

GWH486036	48 x 60 x 36	123.6	6.38	\$1483	\$374	
GWH487236	48 x 72 x 36	137	7.08	\$1661	\$443	
GWH488436	48 x 84 x 36	150.24	14	\$1773	\$469	
GWH489636	48 x 96 x 36	163.56	15.5	\$1916	\$512	

Laminate U-base support is 8"D with 7" inside clearance to wall. Access wall through 14.5"H x 9.5"W hinged door with touch latch in front panel of U-base support. U-base includes 0.5" adjustable glides. U-base side panels are tapered at the bottom to clear most baseboards. **Cut-out locations available in positions 1 or 2 only.**

- Metal bases sold separately. Compatible with **GRHB22H35** or **GSHB19H35** only, requires one base.

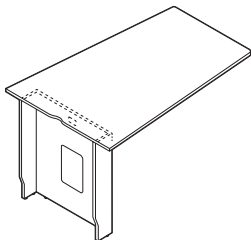

41.5"H Wedge Huddle

GWH486041	48 x 60 x 41.5	130.1	6.74	\$1548	\$374	
GWH487241	48 x 72 x 41.5	143.5	7.43	\$1726	\$443	
GWH488441	48 x 84 x 41.5	156.74	14.35	\$1839	\$469	
GWH489641	48 x 96 x 41.5	170.06	15.85	\$1980	\$512	

Laminate U-base support is 8"D with 7" inside clearance to wall. Access wall through 14.5"H x 9.5"W hinged door with touch latch in front panel of U-base support. U-base includes 0.5" adjustable glides. U-base side panels are tapered at the bottom to clear most baseboards. **Cut-out locations available in positions 1 or 2 only.**

- Metal bases sold separately. Compatible with **GRHB22H41** or **GSHB19H41** only, requires one base.

Required Specifications

Top finish
Base finish

Optional Specifications

HP laminate
Grommet position or power block cut-out

Accessories

Power block

S SWAP™ TABLES

RECTANGULAR HUDDLE TABLES

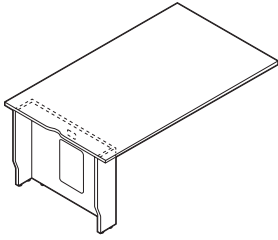

29"H Rectangular Huddle

MODEL #	DIMENSIONS	WT/LB.	CUBIC FT.	LIST PRICE	HP ADD
W x D x H					
GRH364829	36 x 48 x 29	77.05	3.94	\$952	\$188
GRH366029	36 x 60 x 29	86.95	4.46	\$1161	\$188
GRH367229	36 x 72 x 29	97	4.99	\$1295	\$195
GRH426029	42 x 60 x 29	99.82	5.18	\$1301	\$273
GRH427229	42 x 72 x 29	111.5	5.79	\$1459	\$300
GRH428429	42 x 84 x 29	123.1	11.98	\$1616	\$477
GRH429629	42 x 96 x 29	134.74	13.31	\$1746	\$504
GRH486029	48 x 60 x 29	112.6	5.89	\$1453	\$374
GRH487229	48 x 72 x 29	126	6.58	\$1626	\$443
GRH488429	48 x 84 x 29	139.24	13.5	\$1738	\$469
GRH489629	48 x 96 x 29	152.56	15	\$1880	\$512

Laminate u-base support is 8"D with 7" inside clearance to wall. Access wall through 14.5"H x 9.5"W hinged door with touch latch in front panel of u-base support. U-base includes 0.5" adjustable glides. U-base side panels are tapered at the bottom to clear most baseboards. **Cut-out locations available in positions 1 or 2 only (except for model GRH364829 - cut-out position available in position 1 only).**

- Metal bases sold separately. Compatible with **GRHB22H28** or **GSHB19H28** only, requires one base.

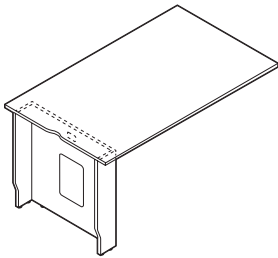

36"H Rectangular Huddle

GRH364836	36 x 48 x 36	85.95	4.31	\$980	\$188
GRH366036	36 x 60 x 36	95.85	4.84	\$1189	\$188
GRH367236	36 x 72 x 36	105.9	5.37	\$1323	\$195
GRH426036	42 x 60 x 36	109.82	5.61	\$1332	\$273
GRH427236	42 x 72 x 36	121.5	6.22	\$1491	\$300
GRH428436	42 x 84 x 36	133.1	12.41	\$1646	\$477
GRH429636	42 x 96 x 36	144.74	13.75	\$1777	\$504
GRH486036	48 x 60 x 36	123.6	6.38	\$1488	\$374
GRH487236	48 x 72 x 36	137	7.08	\$1661	\$443
GRH488436	48 x 84 x 36	150.24	14	\$1773	\$469
GRH489636	48 x 96 x 36	163.56	15.5	\$1916	\$512

Laminate u-base support is 8"D with 7" inside clearance to wall. Access wall through 14.5"H x 9.5"W hinged door with touch latch in front panel of u-base support. U-base includes 0.5" adjustable glides. U-base side panels are tapered at the bottom to clear most baseboards. **Cut-out locations available in positions 1 or 2 only (except for model GRH364836 - cut-out position available in position 1 only).**

- Metal bases sold separately. Compatible with **GRHB22H35** or **GSHB19H35** only, requires one base.

Required Specifications

Top finish
Base finish

Optional Specifications

HP laminate
Grommet position or power block cut-out

Accessories

Power block

RECTANGULAR HUDDLE TABLES MODEL # DIMENSIONS WT/LB. CUBIC FT. LIST PRICE HP ADD

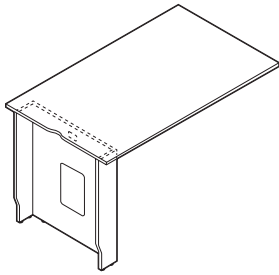

41.5"H Rectangular Huddle

	W x D x H				
GRH364841	36 x 48 x 41.5	92.65	4.58	\$1032	\$188
GRH366041	36 x 60 x 41.5	102.55	5.11	\$1241	\$188
GRH367241	36 x 72 x 41.5	112.6	5.63	\$1375	\$195
GRH426041	42 x 60 x 41.5	117.32	5.92	\$1392	\$374
GRH427241	42 x 72 x 41.5	129	6.53	\$1549	\$300
GRH428441	42 x 84 x 41.5	140.6	12.72	\$1706	\$477
GRH429641	42 x 96 x 41.5	152.24	14.06	\$1837	\$504
GRH486041	48 x 60 x 41.5	130.1	6.74	\$1552	\$374
GRH487241	48 x 72 x 41.5	143.5	7.43	\$1726	\$443
GRH488441	48 x 84 x 41.5	156.74	14.35	\$1839	\$469
GRH489641	48 x 96 x 41.5	170.06	15.85	\$1980	\$512

Laminate U-base support is 8"D with 7" inside clearance to wall. Access wall through 14.5"H x 9.5"W hinged door with touch latch in front panel of U-base support. U-base includes 0.5" adjustable glides. U-base side panels are tapered at the bottom to clear most baseboards. **Cut-out locations available in positions 1 or 2 only (except for model GRH364841 - cut-out position available in position 1 only).**

- Metal bases sold separately. Compatible with **GRHB22H41** or **GSHB19H41** only, requires one base.

Required Specifications

Top finish
Base finish

Optional Specifications

HP laminate
Grommet position or power block cut-out

Accessories

Power block

S SWAP™ TABLES

SOFT ELLIPSE HUDDLE TABLES

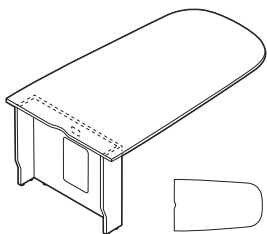

29"H Soft Ellipse Huddle

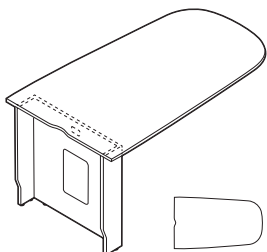

36"H Soft Ellipse Huddle

MODEL #	DIMENSIONS W x D x H	WT/LB.	CUBIC FT.	LIST PRICE	HP ADD
GSEH364829	36 x 48 x 29	77.05	3.94	\$952	\$188
GSEH366029	36 x 60 x 29	86.95	4.46	\$1161	\$188
GSEH367229	36 x 72 x 29	97	4.99	\$1295	\$195
GSEH426029	42 x 60 x 29	99.82	5.18	\$1301	\$273
GSEH427229	42 x 72 x 29	111.5	5.79	\$1459	\$300
GSEH428429	42 x 84 x 29	123.1	11.98	\$1616	\$477
GSEH429629	42 x 96 x 29	134.7	13.31	\$1746	\$504
GSEH486029	48 x 60 x 29	112.6	5.89	\$1453	\$374
GSEH487229	48 x 72 x 29	126	6.58	\$1626	\$443
GSEH488429	48 x 84 x 29	139.2	13.5	\$1738	\$469
GSEH489629	48 x 96 x 29	152.6	15	\$1880	\$512

Laminate u-base support is 8"D with 7" inside clearance to wall. Access wall through 14.5"H x 9.5"W hinged door with touch latch in front panel of u-base support. U-base includes 0.5" adjustable glides. U-base side panels are tapered at the bottom to clear most baseboards. **Cut-out locations available in positions 1 or 2 only (except for model GSEH364829 - cut-out position available in position 1 only).**

- Metal bases sold separately. Compatible with **GRHB22H28** or **GSHB19H28** only, requires one base.

GSEH364836	36 x 48 x 36	86	4.31	\$980	\$188
GSEH366036	36 x 60 x 36	95.9	4.84	\$1189	\$188
GSEH367236	36 x 72 x 36	105.9	5.37	\$1323	\$195
GSEH426036	42 x 60 x 36	109.8	5.61	\$1332	\$273
GSEH427236	42 x 72 x 36	121.5	6.22	\$1491	\$300
GSEH428436	42 x 84 x 36	133.1	12.41	\$1646	\$477
GSEH429636	42 x 96 x 36	144.74	13.75	\$1777	\$504
GSEH486036	48 x 60 x 36	123.6	6.38	\$1488	\$374
GSEH487236	48 x 72 x 36	137	7.08	\$1661	\$443
GSEH488436	48 x 84 x 36	150.24	14	\$1773	\$469
GSEH489636	48 x 96 x 36	163.56	15.5	\$1916	\$512

Laminate u-base support is 8"D with 7" inside clearance to wall. Access wall through 14.5"H x 9.5"W hinged door with touch latch in front panel of u-base support. U-base includes 0.5" adjustable glides. U-base side panels are tapered at the bottom to clear most baseboards. **Cut-out locations available in positions 1 or 2 only (except for model GSEH364836 - cut-out position available in position 1 only).**

- Metal bases sold separately. Compatible with **GRHB22H35** or **GSHB19H35** only, requires one base.

Required Specifications

Top finish
Base finish

Optional Specifications

HP laminate
Grommet position or power block cut-out

Accessories

Power block

SOFT ELLIPSE HUDDLE TABLES

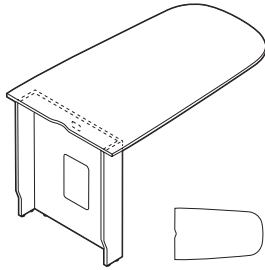

41.5"H Soft Ellipse Huddle

MODEL #	DIMENSIONS	WT/LB.	CUBIC FT.	LIST PRICE	HP ADD
W x D x H					
GSEH364841	36 x 48 x 41.5	92.65	4.58	\$1032	\$188
GSEH366041	36 x 60 x 41.5	102.55	5.11	\$1241	\$188
GSEH367241	36 x 72 x 41.5	112.6	5.63	\$1375	\$195
GSEH426041	42 x 60 x 41.5	117.32	5.92	\$1392	\$273
GSEH427241	42 x 72 x 41.5	129	6.53	\$1549	\$300
GSEH428441	42 x 84 x 41.5	140.6	12.72	\$1706	\$477
GSEH429641	42 x 96 x 41.5	152.24	14.06	\$1837	\$504
GSEH486041	48 x 60 x 41.5	130.1	6.74	\$1552	\$374
GSEH487241	48 x 72 x 41.5	143.5	7.43	\$1726	\$443
GSEH488441	48 x 84 x 41.5	156.74	14.35	\$1839	\$469
GSEH489641	48 x 96 x 41.5	170.06	15.85	\$1980	\$512

Laminate u-base support is 8"D with 7" inside clearance to wall. Access wall through 14.5"H x 9.5"W hinged door with touch latch in front panel of u-base support. U-base includes 0.5" adjustable glides. U-base side panels are tapered at the bottom to clear most baseboards. **Cut-out locations available in positions 1 or 2 only (except for model GSEH364841 - cut-out position available in position 1 only).**

- Metal bases sold separately. Compatible with **GRHB22H41** or **GSHB19H41** only, requires one base.

Required Specifications

Top finish
Base finish

Optional Specifications

HP laminate
Grommet position or power block cut-out

Accessories

Power block

HUDDLE BASES

MODEL # DIMENSIONS WT/LB. CUBIC FT. LIST PRICE HP ADD BCH / CHM ACO / SBR

W x D x H

SELECT BASE COMPATIBLE WITH TOP HEIGHT:

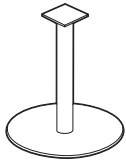

22" Round Huddle Base

MODEL #	DIMENSIONS	WT/LB.	CUBIC FT.	LIST PRICE	HP ADD	BCH / CHM	ACO / SBR
GRHB22H28	22 x - x 28	60	10	\$898	N/A	\$147	\$249
GRHB22H35	22 x - x 35	62	12.7	\$933	N/A	\$164	\$268
GRHB22H41	22 x - x 40.5	63	14.2	\$949	N/A	\$171	\$270

GRHB22H35 - counter height **GRHB22H28** - seated height **GRHB22H41** - bar height

Metal base ships fully assembled. Features 0.5" adjustable glides to level on uneven surfaces. Screws included with base for attaching to appropriate huddle table laminate pieces. See page 323 for available finishes.

Be sure to double check huddle table laminate units and metal bases are the same corresponding heights.

- Plated finishes are available at an upcharge.

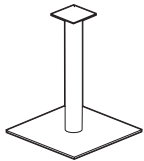

18.5" Square Huddle Base

MODEL #	DIMENSIONS	WT/LB.	CUBIC FT.	LIST PRICE	HP ADD	BCH / CHM	ACO / SBR
GSHB19H28	18.5 x 18.5 x 28	55	6.94	\$966	N/A	\$136	\$250
GSHB19H35	18.5 x 18.5 x 35	57	8.8	\$1022	N/A	\$151	\$287
GSHB19H41	18.5 x 18.5 x 40.5	58	9.84	\$1056	N/A	\$166	\$287

GSHB19H35 - counter height **GSHB19H28** - seated height **GSHB19H41** - bar height

Metal base ships fully assembled. Features 0.5" adjustable glides to level on uneven surfaces. Screws included with base for attaching to appropriate huddle table laminate pieces. See page 323 for available finishes.

Be sure to double check huddle table laminate units and metal bases are the same corresponding heights.

- Plated finishes are available at an upcharge.

Required Specifications

Finish

Optional Specifications

tables training



2gether 358



Bungee/Bungee SL 361



ConnectTABLES 396



Duet 411



Edventure 414



Junction 424



Zook 431



2gether tables are multi-purpose flip-top tables that create dynamic spaces for people to easily connect and learn; ideal for collaborative, classroom, training and conference applications.

2gether tables feature an intuitive “easy touch” mechanism (located at both ends of the table) which allows the user to flip the tables up or down with ease.

2gether tables can be joined in rows for seminars, rearranged in groups to exchange ideas or set up in rows for training rooms. When they are no longer needed, they can be easily folded down and rolled away for compact storage.

2gether works great and looks great in any setting, any time.

Features and Benefits

- Flip-top tables.
- Worksurfaces feature 2mm edging in matching color.
- Tops and bases boxed as appropriate.
- Adjustable leveling casters provide smooth mobility.
- Bumpers prevent tables from being damaged while nested.
- Optional modesty panel with integrated wire trough available.
- Optional Black grommets for convenient wire management can be ordered “factory installed”.
- Easy to assemble.
- Available in three sizes: 18”D x 60”W, 24”D x 60”W and 24”D x 72”W
- 2gether table tops are available in a variety of Global laminate finishes.
- Champagne base finish.



Bumpers on legs and undercarriage provide protection while nested.



Offset “Y” leg allows for in line space saving when nested.

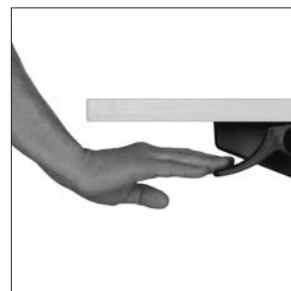

Easy touch lever releases mechanism for effortless movement of table surface.

GENERAL INFORMATION

- 2gether is a series of multi-purpose flip-top tables for collaborative, classroom, training and conference applications.
- Created by the designers of G20 seating.
- Off-set “Y” sculpted legs allow for parallel space saving table nesting, to minimize footprint required for storage.
- Optional modesty panels with integrated wire troughs are available.
- Grommets are available on 24” deep worksurfaces.
- Available in three sizes: 18”D x 60”W, 24”D x 60”W and 24”D x 72”W.
- Shipped easy to assemble. Each component is packaged individually; legs are shipped 1 per carton.
- Deliver power to the table top with individually corded modules or the ModPower daisy chain solution.
- For environmental certifications, please visit globalfurnituregroup.com.

WORKSURFACES

- 1” thick tops constructed of 45 lb. density particle board with high performance thermally fused laminate.

CONSTRUCTION

- “Easy touch” lever located at both sides of the table for flip-top operation from either side.
- 60” and 72” tops include a steel support channel for structural rigidity.
- All finishes feature Global’s preferred edging in matching color (i.e. woodgrain surfaces feature edging with matching printed woodgrain).
- Tops are predrilled with threaded steel inserts.
- 14.25” high optional articulating modesty panel attaches to underside of flip-top.
- Bumpers on legs and under carriage prevent tables from being damaged while nested.
- Champagne base finish.

FINISHES

ACJ Absolute Acajou	FCL First Class
ASN Asian Night	NBL Noce Biondo
AWC Avant Cherry	NGL Noce Grigio
AWH Avant Honey	NEL Noce Leggero
BLK Black	NML Noce Medio
BZD Blizzard	QTM Quartered Mahogany
BRC Brushed Cobalt	SBY Sheer Beauty
CMB Clear Maple	SDT Stonedust
CGY Custom Grey	SOG Storm Grey
DES Dark Espresso	WHE Walnut Heights
DWT Designer White	WHC White Chocolate
FAS Fashionista	WCR Winter Cherry

EDGE DETAIL

- 2mm matching edge is standard.

MODESTY PANEL

- Optional articulating modesty panel available. Champagne finish.

CASTERS

- Adjustable leveling casters and two locking casters (**BLK**) on Champagne finish legs are standard.

WIRE MANAGEMENT

- Standard with integrated trough underneath table.

GANGING CONNECTORS

- Ganging connectors (model **CNGFP**) are available for adjoining tables together, to be ordered separately.
- Tops include predrilled threaded inserts to accept ganging connectors.

SPECIFICATIONS

- Specifications marked with an * are applicable to only those products which have the * symbol beside the product name.

GROMMETS

- Grommets are optional on 24” deep tops only.
- Additional grommets available in standard worksurface locations (left, center or right). Order as: **FOG1, FOG2 or FOG3. Add \$91.**
- Grommet hole dimensions are 3.25” wide x 1.875” deep.

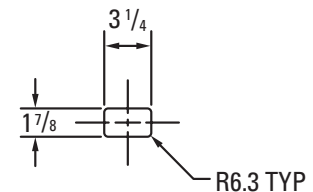

- Actual grommet locations on the worksurface are depicted in the example drawings shown above. Dimensions shown are actual measurements (in inches).

POWER BLOCK

- An individual corded power block (model **PMSPDM**) may be ordered for 24”D worksurfaces.
- A power block is a rectangular worksurface power/data module with one electrical duplex receptacle and two data (RJ45) receptacles. 9’ Black cord included. Power block dimensions are 6.5”W x 3.5”D x 2.75”H. Units cannot be daisy-chained.
- To purchase a power block, you must specify both the power block cut-out location and the power block model #. Order power block as **PMSPDM. Add \$268.** Power blocks are available in standard worksurface locations (left, center or right). Order as **E1, E2 or E3. Add \$91.**



Power block **PMSPDM. Add \$268.**

MODPOWER DAISY CHAIN SOLUTION

- Add flexible power and USB charging to 2gether tables. Connect up to four units with a single corded infeed with NEMA plug.
- ModPower units are sold separately, refer to Productivity Solutions page 473.
- Begin run with a starter unit which includes a corded infeed. Add additional middle or end units as required. Middle and end units are equipped with connecting cables.
- To be used with **rectangular tables IT2460RX and IT2472RX** only.
- On-surface modules clamp on or screw mount to the table tops.
- In-surface modules require table top cut-outs for mounting. Specify cut-out option:
 - **MPS** for a single cut-out to accommodate one ModPower in-surface unit (cut-out will be centered on the approach side). Add **\$91.**
 - **MPD** for two cut-outs in the left and right positions, 15” from ends to center of unit on approach side. Add **\$183.**

2 2GETHER™ TABLES

TABLES AND MODESTY PANELS

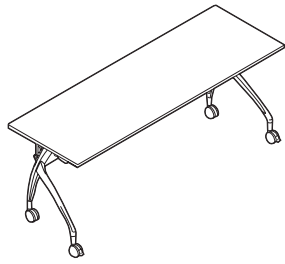

Flip-Top Rectangular Table*

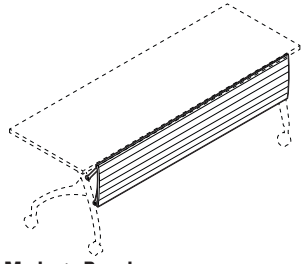

Modesty Panel

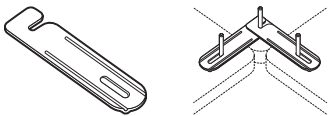

Ganging Connector

MODEL #	DIMENSIONS	WT/LB.	CUBIC FT.	LIST PRICE
---------	------------	--------	-----------	------------

W x D x H

IT1860RX	60 x 18 x 29	63.4	7	\$1552
IT2460RX	60 x 24 x 29	73.6	7.7	\$1584
IT2472RX	72 x 24 x 29	83.4	8.7	\$1766

Flip-top table on four adjustable leveling casters, two locking. Easy-touch lever located at both ends of the table allows for activation on either side of the table; offset Y leg accommodates in line nesting for space saving storage. Champagne finish leg. Black/dark grey casters. Optional articulating modesty panel available. Shipped easy to assemble in 3 cartons.

IT60MP	51 x 2.75 x 14.25	8.4	1.6	\$287
IT72MP	63 x 2.75 x 14.25	9.3	2	\$315

Articulating modesty panel for use with flip-top or fixed top 2gether tables. Champagne finish. Integrated wire management trough. Shipped easy to assemble in 1 carton.

CNGFP	2.5 x 5 x 1.13	0.2	0.1	\$33
-------	----------------	-----	-----	-------------

Black epoxy coated 13 gauge steel with two thumbscrews included. Used to connect table tops together for additional stability or for connecting freestanding tops together. Holes with steel inserts are located in the corner of all tops to accommodate this plate. **Sold individually.**

Required specifications

Top finish*

Optional specifications

Grommet* (24" deep only)
Power block cut-out* (24" deep only)

Accessories

Modesty panel*



Bungee is a series of freestanding tables and accessories designed for classrooms, training rooms, boardrooms and any other multi-functional space that may require frequent configurations. Tables are sold complete with legs and Bungee cords so they may quickly and easily be connected together without searching for tools or worrying about loose parts.

Bungee tables feature optional rounded corners with a unique Bubble molding that is engineered to compress under the tension of the Bungee cords. The compressed molding creates a seal that serves to locate and align interconnected tables while also providing a soft and forgiving edge. Four additional edge options are available.

Choose from a variety of top shapes and laminate finishes to create your individual style. In addition, most tables offer a choice of tapered legs or spider legs in a Black or Tungsten finish with adjustable levelers or optional casters. Optional modesty panels, grommets, wire management and power blocks further enhance your workspace.

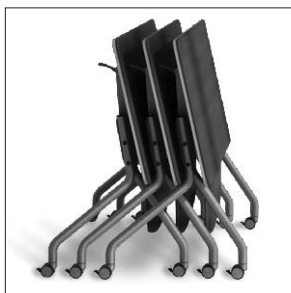

Flip-top tables can be nested and easily stored by activating the single hand release mechanism from the left or right side.

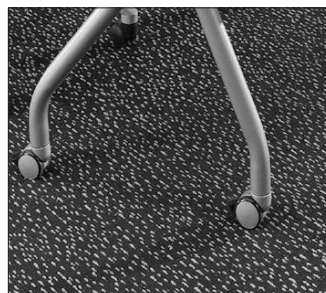

Optional locking casters are available in Black or Tungsten finish (standard on flip-top models).

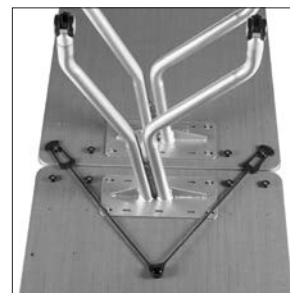

Bungee cords are utilized to quickly and easily reconfigure tables.

Features and Benefits

- Bungee tables are complete with top, legs and Bungee cords.
- Bungee cords provide a fast and easy method of reconfiguring tables without requiring tools.
- Tops are 1" thick and are offered in a variety of shapes and sizes.
- Legs are offered in tapered or spider design in a Black or Tungsten finish.
- Levelers on legs are standard.
- Laminate modesty panels and filler modesty inserts help conceal wires and enhance visual appeal.
- Wire management tracks neatly contain wires, using two separate channels for data and voice wires.
- Optional grommets or power blocks offer technological flexibility.
- Models with handles feature a bow handle in Silver or Black Nickel finish.
- Metal feet are height adjustable and offered in Black or Tungsten finish.
- Boardrooms were never easier to specify - table "sets" and accessories such as AV cabinets and credenza buffets are specified with one model number.

GENERAL INFORMATION

- Bungee is a series of freestanding tables and accessories designed for classrooms, training rooms, boardrooms and any other multifunctional space that requires frequent reconfigurations.
- Bungee tables come complete with a work top, a set of legs and built-in Bungee cord connectors.
- Bungee cords allow the movement and reconfiguration of tables without a risk of damage or losing loose parts.
- High pressure tops are available in all Bungee laminate finishes at an extended lead time - please see model # for pricing.
- Unique “bubble molding” edging is specially engineered to create a secure seal to align interconnected tables. Alternate edge options are also available.
- Bungee products have been tested and comply with all mechanical tests.
- For environmental certifications, please visit globalfurnituregroup.com.

CONSTRUCTION

- Tops are 1" thick. Modesty panels are 11/16" thick.
- All components are made of 45 lb. commercial density particle board, covered on both sides with high performance, thermally fused laminate.
- Tops 54" and over feature a built-in support bar.

BUNGEE CORDS

- Bungee cords are patented elastic devices designed to provide a rapid, no-tool method of attaching tables of the same depth.
- The elastic nature of cords allows two connected tables to be moved around without risk of damage to the table top or connecting hardware.
- Bungee cords are included with all freestanding tables and carry a Lifetime Warranty.

EDGE DETAIL

- Six edge details to choose from.
- Unique “bubble molding” is engineered to compress under the tension of the Bungee cords, creating a seal that serves to locate and align interconnected tables.
- Bubble molding finish matches surface laminate with Silver (**BS**) or Black (**BB**) accent trim.
- Split color flat edge top half matches surfaces laminate with Silver (**AS**) or Black (**AB**) bottom accent trim.
- For matching 2mm flat edge, specify (**A3**).
- For matching bicut edge, specify (**AR**).
- Cabinetry and accessories feature Global's preferred edging in matching color.

LEGS

- Tables feature two styles of legs - tapered leg and spider leg. Available in Black (**TBL**) or Tungsten (**TTU**) finish.
- Levelers are standard. Optional locking casters are available at no upcharge, specify Black (**TBC**) or Tungsten (**TTTC**) finish.
(Casters must match base finish.) Adjust 3mm - 10mm in height.



tapered leg



spider leg

HANDLES

- Metal handles are standard on all drawers and doors. Handles are offered in two finishes: Silver (**HS**) or Black Nickel (**HT**), please specify.
- Handle finish will match leg finish.



bow handle, Silver finish
specify (**HS**)



bow handle, Black Nickel finish
specify (**HT**)

FEET

- Metal feet are standard on all cabinets. Feet adjust 0.75" in height.
- Feet are available in Black (**TBL**) or Tungsten (**TTU**) finish, please specify.



TBL - Black



TTU - Tungsten

MODESTY PANELS

- Panels are 13" high, recessed 0.75" from the back and inset 7" from the sides.
- Panels feature a built-in flexible wire pass-through.
- Available in all Bungee laminate finishes.

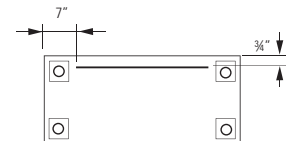
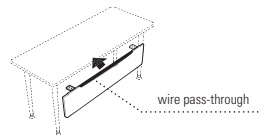

FILLER MODESTY PANELS

- Used to fill the space between two modesty panels when two tables are linked together. Helps conceal wires and enhance visual appeal.
- Available in Silver finish (**SI**) or Black finish (**BK**), please specify.

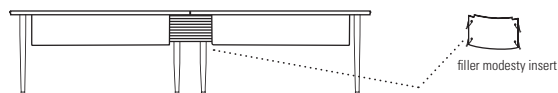

WIRE MANAGEMENT

- Wire management tracks are mounted to the underside of the worksurface. Available in 5" and 22" track lengths.
- 5" track includes one wire clamp; 22" track includes two wire clamps.
- Data and voice wires can be routed separately using two separate channels on each clamp.
- Available in Black only.

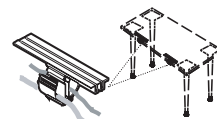

5" wire management track

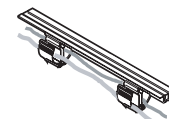

22" wire management track

1. SPECIFY MODEL NUMBER

2. SPECIFY FINISH

Laminate Finishes:

ACJ Absolute Acajou	FCL First Class
ASN Asian Night	NBL Noce Biondo
AWC Avant Cherry	NGL Noce Grigio
AWH Avant Honey	NEL Noce Leggero
BLK Black	NML Noce Medio
BZD Blizzard	QTM Quartered Mahogany
BRC Brushed Cobalt	SBY Sheer Beauty
CMB Clear Maple	SDT Stonedust
CGY Custom Grey	SOG Storm Grey
DES Dark Espresso	WHE Walnut Heights
DWT Designer White	WHC White Chocolate
FAS Fashionista	WCR Winter Cherry

Edge:

BB Bubble edge with Black trim
BS Bubble edge with Silver trim
AB Split color flat edge with Black trim
AS Split color flat edge with Silver trim
A3 Matching 2mm flat edge
AR Matching bicut edge

Legs:

TBL Black
TTU Tungsten

Casters:

TBC Black
TTC Tungsten

Handles:

HS Silver finish
HT Black finish

Modesty Panel Edge:

SI Silver
BK Black Nickel

Feet

TBL Black	TTU Tungsten
------------------	---------------------

3. SPECIFY OPTIONS

GROMMETS

- Optional grommets available in standard worksurface locations (left, center or right) for **rectangular tops** (48" wide and up). Order as: **FOG1, FOG2 or FOG3. Add \$91.**
- Optional grommets are available in **center position only** for **rectangular tops** (36" and 42" wide), **trapezoid tables** and **ALL flip-top and transformer tables.** Order as **FOG2. Add \$91** per table.
- FOG2** when selected will apply to all 4 or 6 tables in transformer table kits accordingly.
- Grommet hole dimensions are 3.25" wide x 1.875" deep.
- Grommets may be placed at non-standard locations. Order as: **CSG. Add \$132.** A drawing must be supplied with vertical and horizontal dimensions to the center of the cut-out (as in drawing above). Please refer to the **custom grommet location form** in the back reference section.

Grommet hole dimensions

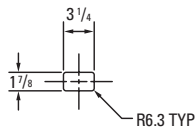

Grommet

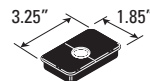

Rectangular Tops

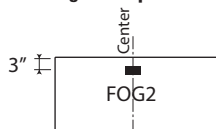

For 36", 42" and 48" wide units

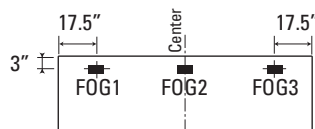

For 60" and 72" wide units

Trapezoid Tables and all Flip-Top Tables

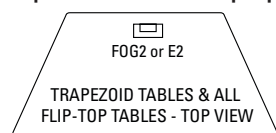

grommet location
FOG2. Add \$91.

Transformer Tables

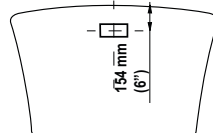

grommet location
FOG2. Add \$91 x number of tables in kit

POWER BLOCK

- An individual corded power block is a rectangular worksurface power/data module with one electrical duplex receptacle and two data (RJ45) receptacles. 9' Black cord included. Power block dimensions are 6.5"W x 3.5"D x 2.75"H. Power blocks are ordered separately. Units cannot be daisy-chained.
- A power block cut-out may be ordered for **rectangular tables** (60" wide and up) in left, center or right position. Order as **E1, E2 or E3. Add \$91.**
- A power block cut-out may be ordered for **rectangular tables** (36", 42" and 48" wide), **all trapezoid tables, flip-top and transformer tables** as an option in center position only, order as **E2. Add \$91** per table.
- E2** when selected will apply to all 4 or 6 tables in transformer table kit accordingly.
- Power block(s) ordered separately, specify model **PMSPPM. Add \$268** each.
- See left example for placement.**

Rectangular Tops

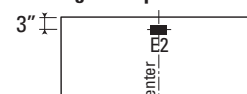

For 36", 42" and 48" wide units



For 60" and 72" wide units

Transformer Tables

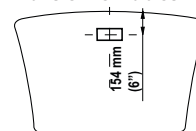

cut-out location



Power block **PMSPPM. Add \$268.**

MODPOWER DAISY-CHAIN SOLUTION

- Add flexible power and USB charging to Bungee **rectangular tables.** Connect up to four units with a single corded infeed with NEMA plug.
- ModPower units are sold separately, refer to Productivity Solutions page 473.
- Begin run with a starter unit which includes a corded infeed. Add additional middle or end units as required. Middle and end units are equipped with connecting cables.
- On-surface modules clamp on or screw mount to the table tops.
- In-surface modules require table top cut-outs for mounting. Specify cut-out option:
 - MPS** for a single cut-out to accommodate one ModPower in-surface unit (cut-out will be centered on the approach side) for **42" to 72" wide fixed top** rectangular tables and **48" to 72" wide flip-top** rectangular tables. Add **\$91.** Note: MPS not available for 36" wide fixed top tables or 42" wide flip-top tables.
 - MPD** for two cut-outs in the left and right positions, 18.25" from ends to center of unit on approach side for **60", 66" and 72" wide rectangular tables.** Add **\$183.**

SPECIFICATIONS

- Specifications marked with an * are applicable to only those products which have the * symbol beside the product name.

B BUNGEE™ TABLES - NOTES

CONNECTING CONDITIONS

- Bungee cords allow for fast and easy reconfiguring of tables whenever needed. Due to the elastic nature of the Bungee cord, two tables connected with Bungee cords can be moved around without risk of damage to the table top or the connecting hardware.
- Connecting tables is simple and intuitive. Tools are not required and there are no loose parts that may be misplaced.
- Bungee cords connect tables of the same depth in all directions.
- Rectangular tables 48" and longer connect in both straight and "L" configurations. Rectangular tables 36" and 42" connect in straight configurations only.

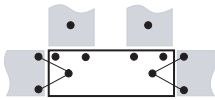
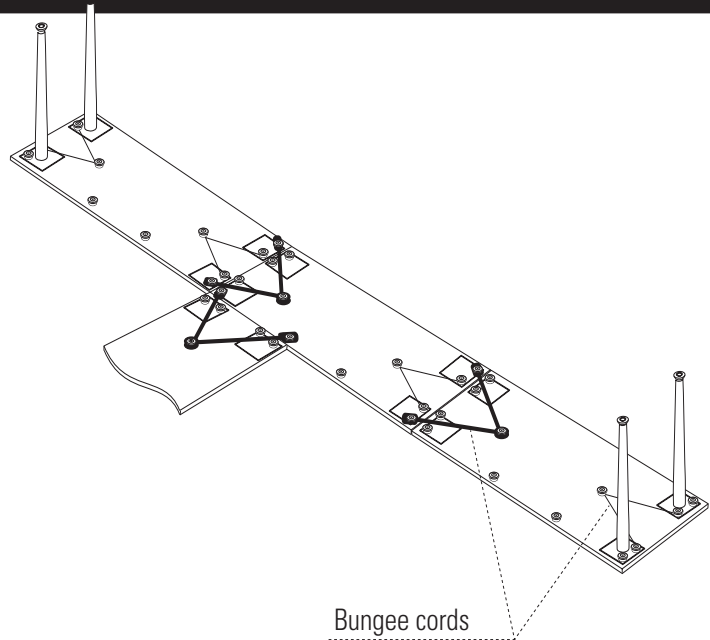

rectangular tables

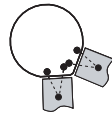

round wedge tables

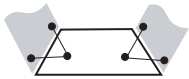

trapezoid tables

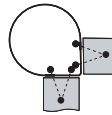

teardrop tables

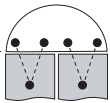

half moon tables

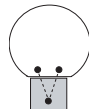

flat round tables

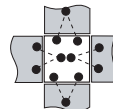

square tables



keystone tables

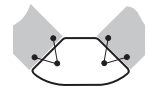

wedge tables

SAMPLE TABLE CONFIGURATIONS

- The following table configurations can be created using Bungee boardroom table sets only. See pages 372-373 for specific models / configurations.

meeting/boardroom table



meeting/boardroom table



training

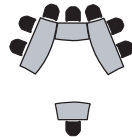

lecture/
AV presentations

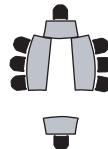

small
teaming stations



large
teaming stations



meeting/boardroom table

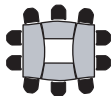

training



FLIP-TOP TABLE NESTING DIAGRAM

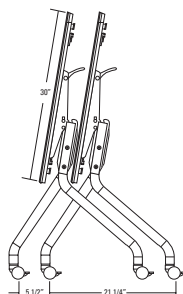
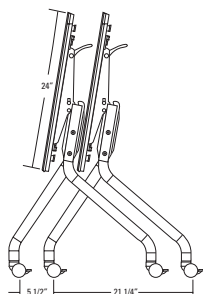

RECTANGULAR TABLES

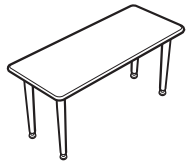
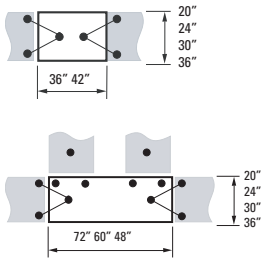

Rectangular Table - Tapered Legs

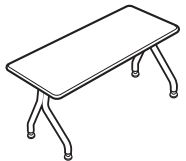
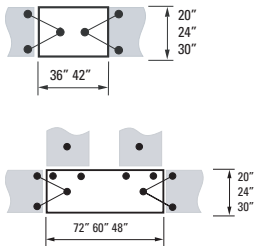

Rectangular Table - Spider Legs

MODEL #	DIMENSIONS	WT/LB.	CUBIC FT.	LIST PRICE	HP ADD
W x D x H					
B2036REF	36 x 20 x 28.7	59	5.25	\$717	\$169
B2042REF	42 x 20 x 28.7	62	5.75	\$740	\$226
B2048REF	48 x 20 x 28.7	67	6	\$773	\$226
B2060REF	60 x 20 x 28.7	74	7	\$881	\$310
B2072REF	72 x 20 x 28.7	81	7.25	\$965	\$352
B2436REF	36 x 24 x 28.7	65	5.75	\$762	\$169
B2442REF	42 x 24 x 28.7	69	6	\$789	\$226
B2448REF	48 x 24 x 28.7	72	6.5	\$813	\$226
B2460REF	60 x 24 x 28.7	82	7.25	\$938	\$339
B2472REF	72 x 24 x 28.7	91	8	\$1020	\$527
B3036REF	36 x 30 x 28.7	70	7.25	\$757	\$317
B3042REF	42 x 30 x 28.7	78	7.5	\$789	\$352
B3048REF	48 x 30 x 28.7	81	7.5	\$813	\$386
B3060REF	60 x 30 x 28.7	92	8.25	\$938	\$386
B3072REF	72 x 30 x 28.7	102	9	\$1033	\$527
B3642REF	42 x 36 x 28.7	83	7.5	\$870	\$339
B3648REF	48 x 36 x 28.7	91	8	\$952	\$352
B3660REF	60 x 36 x 28.7	103	9	\$1033	\$386
B3672REF	72 x 36 x 28.7	116	10	\$1159	\$527

Freestanding table includes four tapered legs with levelers and Bungee cords. When **(BB)** or **(BS)** edge option is specified, surface corners are radiused; when **(AS)**, **(AB)**, **(A3)** or **(AR)** edge option is specified, surface corners are square. Each table can be "Bungee-tied" to other tables of the same depth. Shipped easy to assemble in 2 cartons. Modesty panels available, see page 370.

- **Tables 48" and longer connect in both straight and "L" configurations.**
- **Tables 36" and 42" connect in straight configurations only.**
- Available with optional locking casters, specify Black **(TBC)** or Tungsten **(TTC)**.

B2036RES	36 x 20 x 28.7	57	6.75	\$813	\$169
B2042RES	42 x 20 x 28.7	60	7.25	\$837	\$226
B2048RES	48 x 20 x 28.7	65	7.5	\$870	\$226
B2060RES	60 x 20 x 28.7	72	8.5	\$975	\$310
B2072RES	72 x 20 x 28.7	79	8.75	\$1063	\$352
B2436RES	36 x 24 x 28.7	62	7.25	\$857	\$169
B2442RES	42 x 24 x 28.7	67	7.5	\$881	\$226
B2448RES	48 x 24 x 28.7	71	10	\$912	\$226
B2460RES	60 x 24 x 28.7	80	10.75	\$1033	\$339
B2472RES	72 x 24 x 28.7	89	11.25	\$1119	\$527
B3036RES	36 x 30 x 28.7	72	10.25	\$881	\$317
B3042RES	42 x 30 x 28.7	80	10.5	\$909	\$352
B3048RES	48 x 30 x 28.7	83	10.5	\$938	\$386
B3060RES	60 x 30 x 28.7	94	11.25	\$1063	\$386
B3072RES	72 x 30 x 28.7	104	12	\$1144	\$528

Freestanding table includes two spider legs with levelers and Bungee cords. When **(BB)** or **(BS)** edge option is specified, surface corners are radiused; when **(AS)**, **(AB)**, **(A3)** or **(AR)** edge option is specified, surface corners are square. Each table can be "Bungee-tied" to other tables of the same depth. Shipped easy to assemble in 2 cartons. Modesty panels available, see page 370.

- **Tables 48" and longer connect in both straight and "L" configurations.**
- **Tables 36" and 42" connect in straight configurations only.**
- Available with optional locking casters, specify Black **(TBC)** or Tungsten **(TTC)**.

Required specifications

Top finish
Edge detail
Leg finish

Optional specifications

Casters
Grommet
Power block cut-out
HP laminate

Accessories

Power block

B BUNGEE™ TABLES

TRAPEZOID TABLES

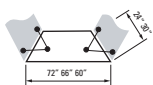

Trapezoid Table - Tapered Legs

MODEL #	DIMENSIONS W x D x H	WT/LB.	CUBIC FT.	LIST PRICE	HP ADD
B2460TRF	60 x 24 x 28.7	71	7.5	\$870	\$339
B2466TRF	66 x 24 x 28.7	74	8	\$881	\$527
B2472TRF	72 x 24 x 28.7	78	8.25	\$952	\$527
B3060TRF	60 x 30 x 28.7	78	8.5	\$926	\$386
B3066TRF	66 x 30 x 28.7	81	9.5	\$965	\$527
B3072TRF	72 x 30 x 28.7	85	9.5	\$1020	\$527

Freestanding table includes four tapered legs with levelers and Bungee cords. Bubble edge options (**BB**) or (**BS**) only apply (edge options (**AS**), (**AB**), (**A3**) and (**AR**) are not applicable on trapezoid tables). Each table can be "Bungee-tied" to other tables of the same depth. Shipped easy to assemble in 2 cartons. Modesty panels available, see pages 370-371.

- Available with optional locking casters, specify Black (**TBC**) or Tungsten (**TTC**).

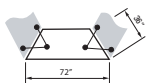

Trapezoid Table - Tapered Legs

B3672TRF	72 x 36 x 28.7	91	10.5	\$1185	N/A
----------	----------------	----	------	---------------	-----

Freestanding table includes five tapered legs with levelers and Bungee cords. Bubble edge options (**BB**) or (**BS**) only apply (edge options (**AS**), (**AB**), (**A3**) and (**AR**) are not applicable on trapezoid tables). Each table can be "Bungee-tied" to other tables of the same depth. Shipped easy to assemble in 2 cartons. Modesty panels available, see pages 370-371.

- Available with optional locking casters, specify Black (**TBC**) or Tungsten (**TTC**).

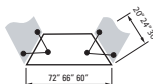

Trapezoid Table - Spider Legs

B2060TRS	60 x 20 x 28.7	67	8.75	\$938	\$310
B2066TRS	66 x 20 x 28.7	68	9	\$965	\$352
B2072TRS	72 x 20 x 28.7	74	9.25	\$1005	\$352
B2460TRS	60 x 24 x 28.7	69	9.25	\$965	\$339
B2466TRS	66 x 24 x 28.7	72	9.75	\$1005	\$527
B2472TRS	72 x 24 x 28.7	76	10	\$1047	\$527
B3060TRS	60 x 30 x 28.7	79	11.5	\$1038	\$386
B3066TRS	66 x 30 x 28.7	83	12.5	\$1078	\$527
B3072TRS	72 x 30 x 28.7	87	12.5	\$1134	\$527

Freestanding table includes two spider legs with levelers and Bungee cords. Bubble edge options (**BB**) or (**BS**) only apply (edge options (**AS**), (**AB**), (**A3**) and (**AR**) are not applicable on trapezoid tables). Each table can be "Bungee-tied" to other tables of the same depth. Shipped easy to assemble in 2 cartons. Modesty panels available, see pages 370-371.

- Available with optional locking casters, specify Black (**TBC**) or Tungsten (**TTC**).

KEYSTONE TABLES

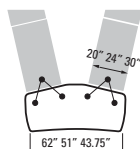
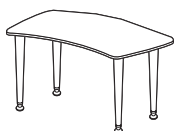

Keystone Table - Tapered Legs

B30KSF	62 x 30 x 28.7	69	7.6	\$998	\$377
B24KSF	51 x 24 x 28.7	60	6.5	\$920	\$251
B20KSF	43.75 x 20 x 28.7	58	6.5	\$909	\$199

Freestanding table includes four tapered legs with levelers and Bungee cords. When (**BB**) or (**BS**) edge option is specified, surface corners are radiused; when (**AS**), (**AB**), (**A3**) or (**AR**) edge option is specified, surface corners are square. Each table can be "Bungee-tied" to other tables of 24" and 30" depth. Shipped easy to assemble in 2 cartons. Modesty panels or filler panels are NOT available.

Required specifications

Top finish
Edge detail
Leg finish

Optional specifications

Grommet (only trapezoid tables)
Casters (only trapezoid tables)
Power block cut-out (only trapezoid tables)
HP laminate

Accessories

Power block (only trapezoid tables)

KEYSTONE TABLES

MODEL #	DIMENSIONS	WT/LB.	CUBIC FT.	LIST PRICE	HP ADD
B36KSF	74.13 x 36 x 28.7	84	8.4	\$1232	\$527

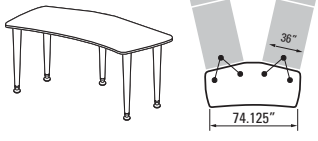

Keystone Table - Tapered Legs

Freestanding table includes five tapered legs with levelers and Bungee cords. When **(BB)** or **(BS)** edge option is specified, surface corners are radiused; when **(AS)**, **(AB)**, **(A3)** or **(AR)** edge option is specified, surface corners are square. Each table can be "Bungee-tied" to other tables of 36" depth. Shipped easy to assemble in 2 cartons. Modesty panels or filler panels are NOT available.

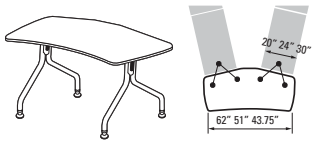

Keystone Table - Spider Legs

B30KSS	62 x 30 x 28.7	77	7.6	\$1164	\$377
B24KSS	51 x 24 x 28.7	66	6.5	\$1059	\$251
B20KSS	43.75 x 20 x 28.7	64	6.5	\$1059	\$199

Freestanding table includes two spider legs with levelers and Bungee cords. When **(BB)** or **(BS)** edge option is specified, surface corners are radiused; when **(AS)**, **(AB)**, **(A3)** or **(AR)** edge option is specified, surface corners are square. Each table can be "Bungee-tied" to other tables of 24" and 30" depth. Shipped easy to assemble in 2 cartons. Modesty panels or filler panels are NOT available.

WEDGE TABLES

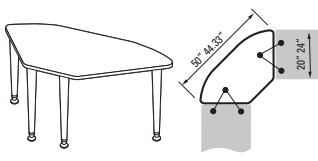

Wedge Table - Tapered Legs

B24WEF	63 x 24 x 28.7	54	6.6	\$957	\$251
B20WEF	57 x 20 x 28.7	46	5.1	\$881	\$199

Freestanding table includes four tapered legs with levelers and Bungee cords. When **(BB)** or **(BS)** edge option is specified, surface corners are radiused; when **(AS)**, **(AB)**, **(A3)** or **(AR)** edge option is specified, surface corners are square. Each table can be "Bungee-tied" to other tables of the same depth. Shipped easy to assemble in 2 cartons. Modesty panels available, see page 370.

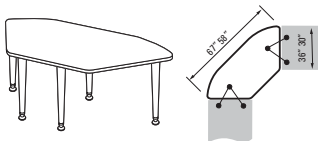

Wedge Table - Tapered Legs

B36WEF	80 x 36 x 28.7	84	9.4	\$1310	\$450
B30WEF	70 x 30 x 28.7	70	7.2	\$1164	\$312

Freestanding table includes five tapered legs with levelers and Bungee cords. When **(BB)** or **(BS)** edge option is specified, surface corners are radiused; when **(AS)**, **(AB)**, **(A3)** or **(AR)** edge option is specified, surface corners are square. Each table can be "Bungee-tied" to other tables of the same depth. Shipped easy to assemble in 2 cartons. Modesty panels available, see page 370.

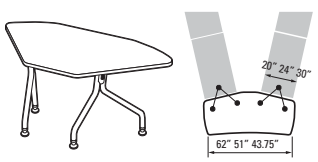

Wedge Table - Spider Legs

B30WES	70 x 30 x 28.7	73	7.2	\$1151	\$312
B24WES	63 x 24 x 28.7	62	6.6	\$1073	\$251
B20WES	57 x 20 x 28.7	52	5.1	\$998	\$199

Freestanding table includes two spider legs with levelers and Bungee cords. When **(BB)** or **(BS)** edge option is specified, surface corners are radiused; when **(AS)**, **(AB)**, **(A3)** or **(AR)** edge option is specified, surface corners are square. Each table can be "Bungee-tied" to other tables of the same depth. Shipped easy to assemble in 2 cartons. Modesty panels available, see page 370.

Required specifications	Optional specifications	Accessories
Top finish Edge detail Leg finish	Casters (only half moon tables) Grommet (only half moon tables) HP laminate	Power block (only position 2)

B BUNGEE™ TABLES

HALF MOON TABLES

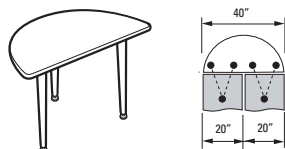

Half Moon Table - Tapered Legs

MODEL #	DIMENSIONS W x D x H	WT/LB.	CUBIC FT.	LIST PRICE	HP ADD
B2040HMF	40 x 20 x 28.7	49	6	\$567	\$226

Freestanding table includes three tapered legs with levelers and Bungee cords. When **(BB)** or **(BS)** edge option is specified, surface corners are radiused; when **(AS)**, **(AB)**, **(A3)** or **(AR)** edge option is specified, surface corners are square. Each table can be "Bungee-tied" to other tables of the same depth. Shipped easy to assemble in 2 cartons. Modesty panels or filler panels are NOT available.

- Available with optional locking casters, specify Black **(TBC)** or Tungsten **(TTC)**.

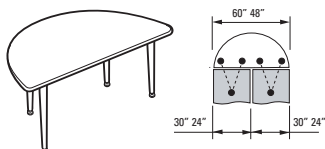

Half Moon Table - Tapered Legs

B2448HMF	48 x 24 x 28.7	110	7.75	\$740	\$226
B3060HMF	60 x 30 x 28.7	81	8.5	\$789	\$386

Freestanding table includes four tapered legs with levelers and Bungee cords. When **(BB)** or **(BS)** edge option is specified, surface corners are radiused; when **(AS)**, **(AB)**, **(A3)** or **(AR)** edge option is specified, surface corners are square. Each table can be "Bungee-tied" to other tables of the same depth. Shipped easy to assemble in 2 cartons. Modesty panels or filler panels are NOT available.

- Available with optional locking casters, specify Black **(TBC)** or Tungsten **(TTC)**.

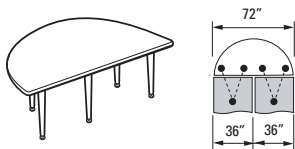

Half Moon Table - Tapered Legs

B3672HMF	72 x 36 x 28.7	110	11.5	\$1114	\$527
----------	----------------	-----	------	---------------	--------------

Freestanding table includes five tapered legs with levelers and Bungee cords. When **(BB)** or **(BS)** edge option is specified, surface corners are radiused; when **(AS)**, **(AB)**, **(A3)** or **(AR)** edge option is specified, surface corners are square. Each table can be "Bungee-tied" to other tables of the same depth. Shipped easy to assemble in 2 cartons. Modesty panels or filler panels are NOT available.

- Available with optional locking casters, specify Black **(TBC)** or Tungsten **(TTC)**.

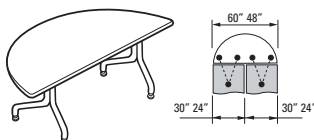

Half Moon Table - Spider Legs*

B2448HMS	48 x 24 x 28.7	67	9.25	\$844	\$226
B3060HMS	60 x 30 x 28.7	83	11.5	\$909	\$386

Freestanding table includes two spider legs with levelers and Bungee cords. When **(BB)** or **(BS)** edge option is specified, surface corners are radiused; when **(AS)**, **(AB)**, **(A3)** or **(AR)** edge option is specified, surface corners are square. Each table can be "Bungee-tied" to other tables of the same depth. Shipped easy to assemble in 2 cartons. Modesty panels or filler panels are NOT available.

- Available with optional locking casters, specify Black **(TBC)** or Tungsten **(TTC)**.

SQUARE TABLES

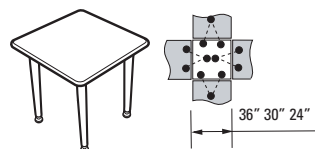

Square Table - Tapered Legs

B2424SQF	24 x 24 x 28.7	55	4.6	\$705	\$141
B3030SQF	30 x 30 x 28.7	65	7.5	\$717	\$209
B3636SQF	36 x 36 x 28.7	78	8	\$824	\$253

Freestanding table includes four tapered legs with levelers and Bungee cords. When **(BB)** or **(BS)** edge option is specified, surface corners are radiused; when **(AS)**, **(AB)**, **(A3)** or **(AR)** edge option is specified, surface corners are square. Each table can be "Bungee-tied" to other tables of the same depth. Shipped easy to assemble in 2 cartons. Note: Square tables will NOT accept laminate modesty panels.

- Available with optional locking casters, specify (Black **(TBC)** or Tungsten **(TTC)**).

Required specifications

Top finish
Edge detail
Leg finish

Optional specifications

Casters
HP laminate
Grommet*

ROUND WEDGE TABLES

MODEL # DIMENSIONS WT/LB. CUBIC FT. LIST PRICE HP ADD

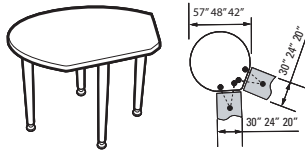

Round Wedge 120° Table

	W x D x H					
B2042RWF	42	20	28.7	76	8.25	\$789 \$494
B2448RWF	48	24	28.7	85	10.75	\$813 \$494
B3057RWF	57	30	28.7	102	12	\$965 \$703

Freestanding table includes four tapered legs with levelers and Bungee cords. Bubble edge options **(BB)** or **(BS)** only apply (edge options **(AS)**, **(AB)**, **(A3)** and **(AR)** are not applicable on round wedge tables). Each table can be "Bungee-tied" to other tables of the same depth. Shipped easy to assemble in 2 cartons. Modesty panels or filler panels are NOT available.

- Available with optional locking casters, specify Black **(TBC)** or Tungsten **(TTC)**.

TEARDROP TABLES

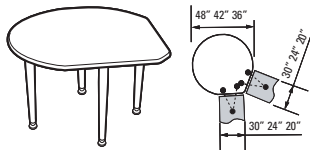

Teardrop 90° Table

B2036TDF	36	20	28.7	71	8	\$740 \$317
B2442TDF	42	24	28.7	81	8.5	\$813 \$494
B3048TDF	48	30	28.7	91	11	\$891 \$459

Freestanding table includes four tapered legs with levelers and Bungee cords. Bubble edge options **(BB)** or **(BS)** only apply (edge options **(AS)**, **(AB)**, **(A3)** and **(AR)** are not applicable on teardrop tables). Each table can be "Bungee-tied" to other tables of the same depth. Shipped easy to assemble in 2 cartons. Filler modesty panels available, see page 371.

- Available with optional locking casters, specify Black **(TBC)** or Tungsten **(TTC)**.

FLAT ROUND TABLES

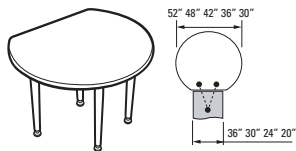

Flat Round Table

B2030FRF	30	20	28.7	56	6	\$717 \$283
B2036FRF	36	20	28.7	66	7.25	\$717 \$317
B2436FRF	36	24	28.7	64	7.25	\$717 \$317
B2442FRF	42	24	28.7	76	8.25	\$857 \$494
B3042FRF	42	30	28.7	74	8	\$857 \$494
B3048FRF	48	30	28.7	88	11	\$857 \$494
B3648FRF	48	36	28.7	85	11	\$952 N/A
B3652FRF	52	36	28.7	93	11	\$952 N/A

Freestanding table includes four tapered legs with levelers and Bungee cords. Bubble edge options **(BB)** or **(BS)** only apply (edge options **(AS)**, **(AB)**, **(A3)** and **(AR)** are not applicable on flat round tables). Each table can be "Bungee-tied" to other tables of the same depth. Shipped easy to assemble in 2 cartons. Modesty panels or filler panels are NOT available.

- Available with optional locking casters, specify Black **(TBC)** or Tungsten **(TTC)**.

Required specifications

op finish
Edge detail
Leg finish

Optional specifications

Casters
HP laminate

B BUNGEE™ TABLES

MODESTY PANELS - SQUARE

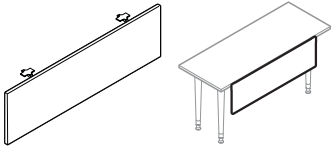

Modesty Panel - Square

MODEL #	DIMENSIONS W x D x H	WT/LB.	CUBIC FT.	LIST PRICE	HP ADD
BX36QMP	21 x 0.69 x 9.6	6	0.9	\$97	N/A
BX42QMP	27 x 0.69 x 9.6	7	1.1	\$101	N/A
BX48QMP	33 x 0.69 x 9.6	9	1.2	\$109	N/A
BX60QMP	45 x 0.69 x 9.6	12	1.6	\$117	N/A
BX66QMP	51 x 0.69 x 9.6	13	1.8	\$123	N/A
BX72QMP	57 x 0.69 x 9.6	14	2	\$127	N/A

For use on **rectangular** tables. Includes hinged mounting bracket.

Available in standard line finishes. Edging only available in Silver (**SI**) or Black (**BK**). Please specify.

- Modesty panel model number indicates the width of table to be used on.

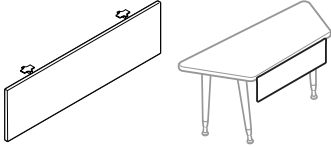

Modesty Panel - Square

BXM60QMP	27 x 0.69 x 9.6	7	1.1	\$101	N/A
BXM66QMP	33 x 0.69 x 9.6	9	1.2	\$109	N/A
BXM72QMP	39 x 0.69 x 9.6	10	1.4	\$113	N/A
BXL60QMP	21 x 0.69 x 9.6	6	0.9	\$98	N/A
BXL66QMP	27 x 0.69 x 9.6	7	1.1	\$101	N/A
BXL72QMP	33 x 0.69 x 9.6	9	1.2	\$109	N/A

For use on **trapezoid** tables. Includes hinged mounting bracket. Intended for use on the short side of the table; may be used on long side but leaves a larger gap.

Available in standard line finishes. Edging only available in Silver (**SI**) or Black (**BK**). Please specify.

- Modesty panel model number indicates the width of table to be used on.
- Specify **BXM** models for 24"D tables and **BXL** models for 30"D tables.

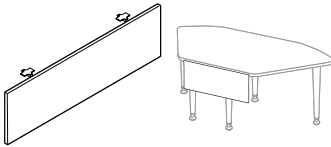

Modesty Panel - Square

BXWQMP	27 x 0.69 x 9.6	7	1.1	\$101	N/A
--------	-----------------	---	-----	--------------	-----

For use on **wedge** tables. Includes hinged mounting bracket. Intended for use on the short side of the table.

Available in standard line finishes. Edging only available in Silver (**SI**) or Black (**BK**). Please specify.

FILLER MODESTY PANELS

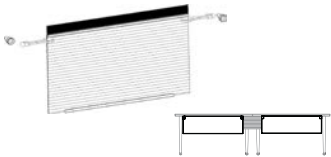

Filler Modesty Panel - Straight

BSFMS	21 x 0.25 x 9	1	0.3	\$98	N/A
-------	---------------	---	-----	-------------	-----

Used to fill the space between two **square** modesty panels where tables are linked in a straight configuration.

Available in Silver (**SI**) or Black (**BK**). Please specify.

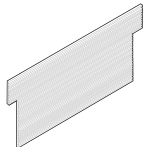

Filler Modesty Panel - Straight to Wedge

BSWFM	19.6 x 9 x 0.25	2	0.1	\$127	N/A
-------	-----------------	---	-----	--------------	-----

Used to fill the space between a straight modesty panel and wedge table.

Use for regular wedge table - tapered legs and flip-top wedge - spider legs.

Required specifications

Finish

FILLER MODESTY PANELS **MODEL #** **DIMENSIONS** **WT/LB.** **CUBIC FT.** **LIST PRICE**

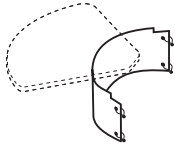

Filler Modesty Panel - Inside Curve

	W x D x H			
B23IFMS	23 x 0.06 x 9	3	1.5	\$127
B29IFMS	29 x 0.06 x 9	3	1.5	\$127
B30IFMS	30 x 0.06 x 9	3	1.5	\$127

Used to fill the space (inside curve) between two modesty panels where tables are linked at an angle or curve. Use for the inside curve of round wedge tables, teardrop tables or trapezoid tables.

- Use model **B23IFMS** for trapezoid tables inside curve only.
- Use model **B29IFMS** for teardrop tables inside curve only.
- Use model **B30IFMS** for round wedge tables inside curve only.

Available in Silver (**SI**) or Black (**BK**). Please specify.

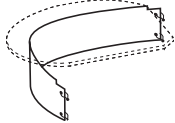

Filler Modesty Panel - Outside Curve

B56S	56 x 0.06 x 9	4	1.5	\$178
B62S	62 x 0.06 x 9	4	1.5	\$194
B71S	71 x 0.06 x 9	4	1.5	\$206

Used to fill the space (outside curve) between two modesty panels where tables are linked at an angle or curve. Use for teardrop tables only (**B2036TDF, B2442TDF and B3048TDF**).

- Use model **B56S** for **B2036TDF** teardrop tables outside curve only.
- Use model **B62S** for **B2442TDF** teardrop tables outside curve only.
- Use model **B71S** for **B3048TDF** teardrop tables outside curve only.

Available in Silver (**SI**) or Black (**BK**). Please specify.

WIRE MANAGEMENT

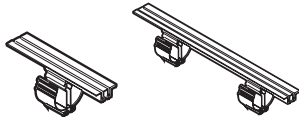

Wire Management - 5" / 22" Track

BWMS5	5 x 2 x 3.5	1	0.1	\$6
BWMD22	22 x 2 x 3.5	1.5	0.1	\$15

Retrofittable track mounts to the underside of worksurface. Includes wire clamp that can route data and voice wires separately. Black only. There are no specifications for Wire Management.

- For a 5" track, order model **BWMS5** - includes one wire clamp.
- For a 22" track, order model **BWMD22** - includes two wire clamps.

Required specifications
Finish (only modesty panels)

B BUNGEE™ TABLES

TRANSFORMER TABLES - 11 FT.

11 Foot Configurations

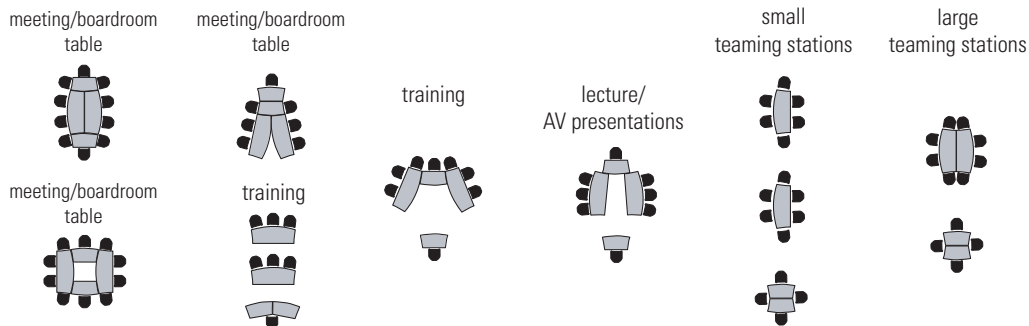

TRANSFORMER TABLES - 11 FT.

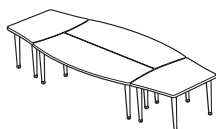

Transformer Table Set - 11 Foot*



Transformer Table Set - 11 Foot*

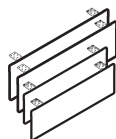

Square Modesty Panel Set For 11 Foot Transformer Table Set**

MODEL #	DIMENSIONS	WT/LB.	CUBIC FT.	LIST PRICE
---------	------------	--------	-----------	------------

W x D x H

BK132F	132 x 60 x 28.7	290	19.25	\$3499
--------	-----------------	-----	-------	---------------

Includes four freestanding tables. Each table includes **four tapered legs** with levelers and Bungee cords to be "Bungee-tied" together. Corners of all tops in the set are radiused for all edge options **(BB)**, **(BS)**, **(AB)**, **(AS)**, **(A3)** and **(AR)** due to geometry of the tables together. Shipped easy to assemble in 6 cartons. Modesty panel set available, order **BXK132QMP**.

- Available with optional locking casters, specify Black **(TBC)** or Tungsten **(TTC)**.

BK132S	132 x 60 x 28.7	290	22.25	\$3936
--------	-----------------	-----	-------	---------------

Includes four freestanding tables. Each table includes **two spider legs** with levelers and Bungee cords to be "Bungee-tied" together. Corners of all tops in the set are radiused for all edge options **(BB)**, **(BS)**, **(AB)**, **(AS)**, **(A3)** and **(AR)** due to geometry of the tables together. Shipped easy to assemble in 6 cartons. Modesty panel set available, order **BXK132QMP**.

- Available with optional locking casters, specify Black **(TBC)** or Tungsten **(TTC)**.

BXK132QMP	45 x 0.69 x 9.6	31	3.2	\$402
-----------	-----------------	----	-----	--------------

For use on **11 Foot Transformer Table Set**. Includes mounting bracket and wire access sweep. Available in standard line finishes. Edging only available in Silver **(SI)** or Black **(BK)**. Please specify.

Required specifications

Top finish*	Edge detail*
Leg finish*	
Modesty panel finish	
Edge finish**	

Optional specifications

Casters*
Grommet*
Power block cut-out*

Accessories

Power block*

TRANSFORMER TABLES - 13 AND 15 FT.

13/15 Foot Configurations

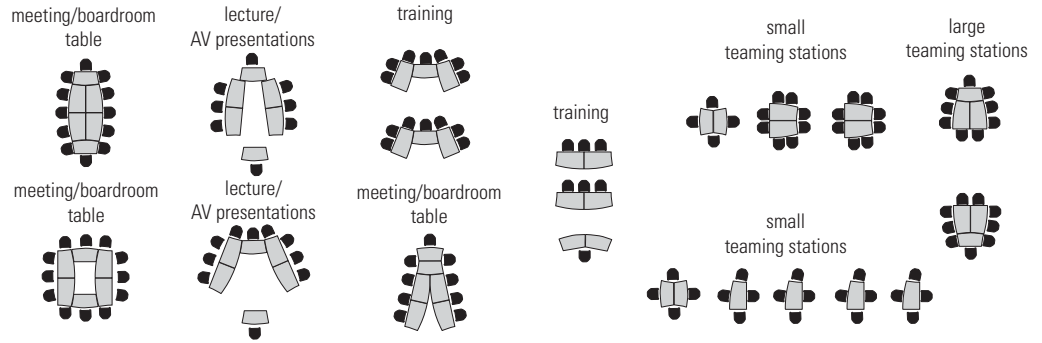

TRANSFORMER TABLES - 13 AND 15 FT.

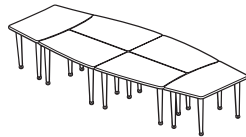

Transformer Table Set - 13 and 15 Foot*

MODEL #	DIMENSIONS W x D x H	WT/LB.	CUBIC FT.	LIST PRICE
BK156F	156 x 60 x 28.7	374	26.25	\$5154
BK180F	180 x 60 x 28.7	420	29.75	\$5622

Includes six freestanding tables. Each table includes **four tapered legs** with levelers and Bungee cords to be "Bungee-tied" together. Corners of all tops in the set are radiused for all edge options **(BB)**, **(BS)**, **(AB)**, **(AS)**, **(A3)** and **(AR)** due to geometry of the tables together. Shipped easy to assemble in 9 cartons.

Modesty panel set available, order **BXK156QMP/BXK180QMP**.

- Available with optional locking casters, specify Black **(TBC)** or Tungsten **(TTC)**.

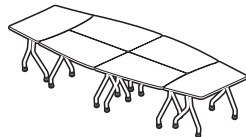

Transformer Table Set - 13 and 15 Foot*

BK156S	156 x 60 x 28.7	374	28.75	\$5327
BK180S	180 x 60 x 28.7	420	32.5	\$5772

Includes six freestanding tables. Each table includes **two spider legs** with levelers and Bungee cords to be "Bungee-tied" together. Corners of all tops in the set are radiused for all edge options **(BB)**, **(BS)**, **(AB)**, **(AS)**, **(A3)** and **(AR)** due to geometry of the tables together. Shipped easy to assemble in 9 cartons.

Modesty panel set available, order **BXK156QMP/BXK180QMP**.

- Available with optional locking casters, specify Black **(TBC)** or Tungsten **(TTC)**.

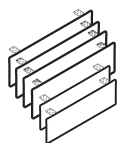

Square Modesty Panel Set for 13 and 15 Foot Transformer Table Sets**

BXK156QMP	33 x 0.69 x 9.6	41	3.8	\$680
BXK180QMP	45 x 0.69 x 9.6	51	4.2	\$655

For use on **13 & 15 foot transformer table sets**. Includes mounting bracket and wire access sweep. Available in standard line finishes. Edging only available in Silver **(SI)** or Black **(BK)**. Please specify.

- Use model **BXK156QMP** for **BK156F/S** transformer table set.
- Use model **BXK180QMP** for **BK180F/S** transformer table set.

Required specifications

Top finish* Edge detail*
 Leg finish*
 Modesty panel finish
 Edge finish**

Optional specifications

Grommet*
 Casters*
 Power block cut-out*

Accessories

Power block*

B BUNGEE™ TABLES

SPIDER LEG TABLES - FLIP-TOP

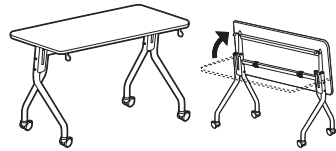
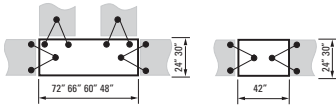

Flip-Top Rectangular Table - Spider Legs*

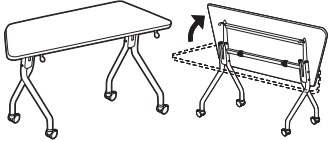
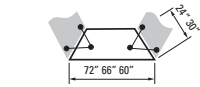

Flip-Top Trapezoid Table - Spider Legs*

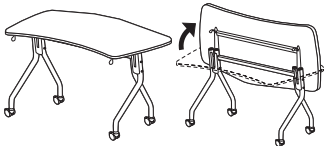

Flip-Top Keystone Table - Spider Legs

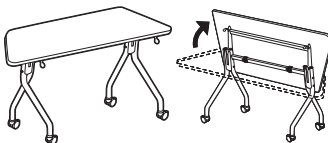

Flip-Top Wedge Table - Spider Legs*

MODEL #	DIMENSIONS W x D x H	WT/LB.	CUBIC FT.	LIST PRICE	HP ADD
BX2442RES	42 x 24 x 29.2	66	20.75	\$1407	\$199
BX2448RES	48 x 24 x 29.2	72	23.5	\$1423	\$199
BX2460RES	60 x 24 x 29.2	84	29	\$1443	\$251
BX2466RES	66 x 24 x 29.2	97	31.75	\$1462	\$299
BX2472RES	72 x 24 x 29.2	102	34.75	\$1497	\$299
BX3042RES	42 x 30 x 29.2	73	25.5	\$1412	\$251
BX3048RES	48 x 30 x 29.2	79	28.75	\$1431	\$251
BX3060RES	60 x 30 x 29.2	94	35.75	\$1462	\$312
BX3066RES	66 x 30 x 29.2	106	39.25	\$1482	\$377
BX3072RES	72 x 30 x 29.2	112	42.5	\$1516	\$377

Table features a flip-top worksurface for ease of storage. When **(BB)** or **(BS)** edge option is specified, surface corners are radiused; when **(AS)**, **(AB)**, **(A3)** or **(AR)** edge option is specified, surface corners are square. Single hand release mechanism can be activated from left or right side of the table. Tables can be nested when folded. Each table can be "Bungee-tied" to other tables of the same depth. Shipped in 1 carton. Folding modesty panels available, see page 375.

- **Tables 48" and longer connect in both straight and "L" configurations.**
- Standard with locking casters, specify Black **(TBC)** or Tungsten **(TTC)**.

BX2460TRS	60 x 24 x 29.2	69	29	\$1343	\$251
BX2466TRS	66 x 24 x 29.2	74	31.75	\$1360	\$299
BX2472TRS	72 x 24 x 29.2	80	34.75	\$1381	\$299
BX3060TRS	60 x 30 x 29.2	72	35.75	\$1356	\$312
BX3066TRS	66 x 30 x 29.2	78	39.25	\$1374	\$377
BX3072TRS	72 x 30 x 29.2	84	42.5	\$1392	\$377

Table features a flip-top worksurface for ease of storage. Bubble edge options **(BB)** or **(BS)** only apply (edge options **(AS)**, **(AB)**, **(A3)** and **(AR)** are not applicable on trapezoid tables). Single hand release mechanism can be activated from left or right side of the table. Tables can be nested when folded. Each table can be "Bungee-tied" to other tables of the same depth. Shipped in 1 carton. Folding modesty panels available, see page 375.

- Standard with locking casters, specify Black **(TBC)** or Tungsten **(TTC)**.

BX24KSS	51 x 24 x 29.2	69	24.75	\$1317	\$251
BX30KSS	62 x 30 x 29.2	79	36.75	\$1370	\$377

Table features a flip-top worksurface for ease of storage. When **(BB)** or **(BS)** edge option is specified, surface corners are radiused; when **(AS)**, **(AB)**, **(A3)** or **(AR)** edge option is specified, surface corners are square. Single hand release mechanism can be activated from left or right side of the table. Tables can be nested when folded. Each table can be "Bungee-tied" to other tables of the same depth. Shipped in 1 carton. Modesty panels or filler panels are NOT available.

- Standard with locking casters, specify Black **(TBC)** or Tungsten **(TTC)**.

BX24WES	63 x 24 x 29.2	76	33	\$1654	\$377
BX30WES	70 x 30 x 29.2	84	33	\$1680	\$377

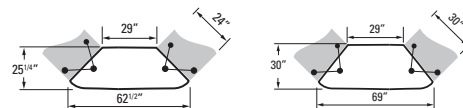

Table features a flip-top worksurface for ease of storage. When **(BB)** or **(BS)** edge option is specified, surface corners are radiused; when **(AS)**, **(AB)**, **(A3)** or **(AR)** edge option is specified, surface corners are square. Single hand release mechanism can be activated from left or right side of the table. Tables can be nested when folded. Each table can be "Bungee-tied" to other tables of the same depth. Shipped in 1 carton. Folding modesty panels available, see page 375.

- Standard with locking casters, specify Black **(TBC)** or Tungsten **(TTC)**.

Required specifications

Top finish*
Edge detail*
Leg finish*

Optional specifications

Grommet*
Power block cut-out*
HP laminate*

Accessories

Power block*

MODESTY PANELS - FLIP-TOP - SQUARE **MODEL #** **DIMENSIONS** **WT/LB.** **CUBIC FT.** **LIST PRICE** **HP ADD**

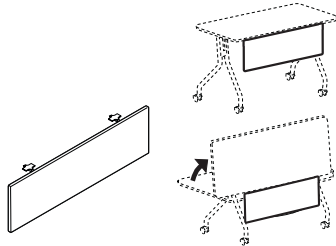

Modesty Panel - Square

	W x D x H				
BX36QMP	21 x 0.69 x 9.6	6	0.9	\$97	
BX42QMP	27 x 0.69 x 9.6	7	1.1	\$101	
BX48QMP	33 x 0.69 x 9.6	9	1.2	\$109	
BX60QMP	45 x 0.69 x 9.6	12	1.6	\$117	
BX66QMP	51 x 0.69 x 9.6	13	1.8	\$123	
BX72QMP	57 x 0.69 x 9.6	14	2	\$127	

For use on **flip-top rectangular tables**. Includes hinged mounting bracket. Available in standard line finishes. Edging only available in Silver (**SI**) or Black (**BK**). Please specify.

- Modesty panel model number indicates the width of table to be used on.

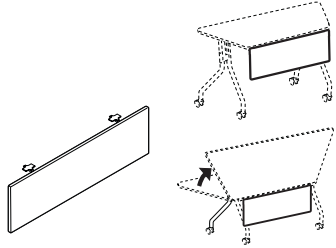

Modesty Panel - Square

BXM60QMP	27 x 0.69 x 9.6	7	1.1	\$101	
BXM66QMP	33 x 0.69 x 9.6	9	1.2	\$109	
BXM72QMP	39 x 0.69 x 9.6	10	1.4	\$113	
BXL60QMP	21 x 0.69 x 9.6	6	0.9	\$98	
BXL66QMP	27 x 0.69 x 9.6	7	1.1	\$101	
BXL72QMP	33 x 0.69 x 9.6	9	1.2	\$109	

For use on **flip-top trapezoid tables**. Includes hinged mounting bracket. Intended for use on the short side of the table; may be used on long side but leaves a larger gap. Available in standard line finishes. Edging only available in Silver (**SI**) or Black (**BK**). Please specify.

- Modesty panel model number indicates the width of table to be used on.

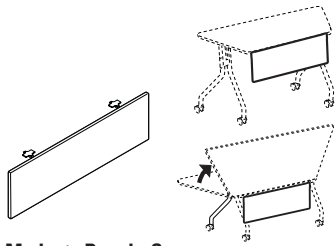

Modesty Panel - Square

BXWQMP	27 x 0.69 x 9.6	7	1.1	\$101	
--------	-----------------	---	-----	--------------	--

For use on **flip-top wedge tables**. Includes hinged mounting bracket. Intended for use on the short side of the table. Available in standard line finishes. Edging only available in Silver (**SI**) or Black (**BK**). Please specify.

- Modesty panel model number indicates the width of table to be used on.

Required specifications

- Modesty panel finish
- Edge finish

B BUNGEE™ TABLES

TRANSFORMER TABLES - FLIP-TOP - 4 PC.

4 pc. Configurations

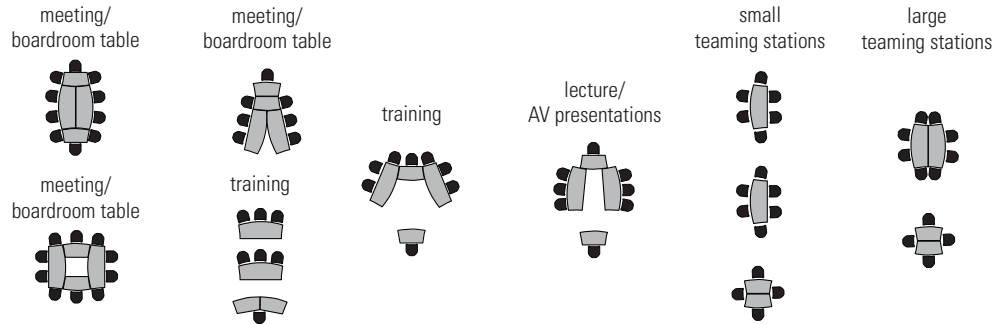

TRANSFORMER TABLES - FLIP-TOP - 4 PC.

MODEL #	DIMENSIONS	WT/LB.	CUBIC FT.	LIST PRICE	HP ADD
---------	------------	--------	-----------	------------	--------

W x D x H

BXK132S	132 x 60 x 29.2	352	151.25	\$5525	\$1442
---------	-----------------	-----	--------	--------	--------



Transformer Table Set - 4pc. Flip-Top

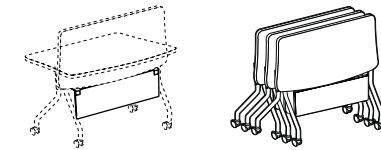

Includes four freestanding tables with spider legs. All tables feature a flip-top worksurface for ease of storage. Single hand release mechanism can be activated from left or right side of the table. Tables can be nested when folded. Each table can be "Bungee-tied" to other tables. Corners of all tops in the set are radiused for all edge options (**BB**), (**BS**), (**AB**), (**AS**), (**A3**) and (**AR**) due to geometry of the tables together. Shipped in 4 cartons.

Folding modesty panel set available, order **BXK132QMP**.

- Standard with locking casters, specify Black (**TBC**) or Tungsten (**TTC**).

BXK132QMP	45 x 0.69 x 9.6	31	3.2	\$402	N/A
-----------	-----------------	----	-----	-------	-----

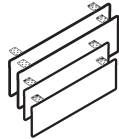

Square Modesty Panel Set for 4 pc. Flip-Top Table*

For use on **4 pc. flip-top table kits**. Modesty panels flip down for storage. Features Black wire access sweep. Available in standard line finishes. Edging only available in Silver (**SI**) or Black (**BK**). Please specify.

Required specifications

Top finish	Edge detail*
Leg finish	
Modesty panel finish	
Edge finish*	

Optional specifications

HP laminate
Grommet
Casters
Power block cut-out

Accessories

Power block

TRANSFORMER TABLES - FLIP-TOP - 6 PC.

6 pc. Configurations

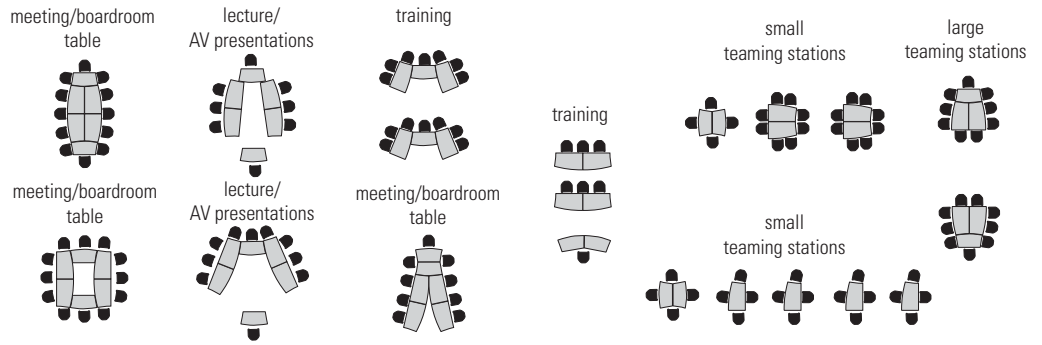

TRANSFORMER TABLES - FLIP-TOP - 6 PC.

MODEL #	DIMENSIONS	WT/LB.	CUBIC FT.	LIST PRICE	HP ADD
---------	------------	--------	-----------	------------	--------

W x D x H

BXK156S	156 x 60 x 29.2	452	181.75	\$8115	\$1659
BXK180S	180 x 60 x 29.2	507	209.5	\$8253	\$1911

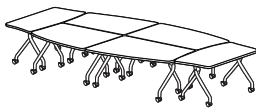

Transformer Table Set - 6 pc. Flip-Top*

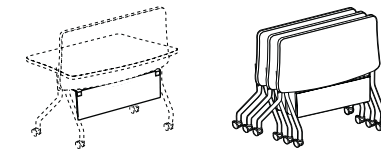

Includes six freestanding tables with spider legs. All tables feature a flip-top worksurface for ease of storage. Single hand release mechanism can be activated from left or right side of the table. Tables can be nested when folded. Each table can be "Bungee-tied" to other tables. Corners of all tops in the set are radiused for all edge options (BB), (BS), (AB), (AS), (A3) and (AR) due to geometry of the tables together. Shipped in 6 cartons.

Folding modesty panel set available, order **BXK156QMP/ BXK180QMP**.

- Standard with locking casters, specify Black (TBC) or Tungsten (TTC).

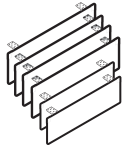

Square Modesty Panel Set for 6 pc. Flip-Top Table**

BXK156QMP	33 x 0.69 x 9.6	41	3.8	\$680	N/A
BXK180QMP	45 x 0.69 x 9.6	51	4.2	\$655	N/A

For use on 6 pc. flip-top table kits. Modesty panels flip down for storage. Features Black wire access sweep. Available in standard line finishes. Edging only available in Silver (SI) or Black (BK). Please specify.

Required specifications

Top finish*	Edge detail*
Leg finish*	
Modesty panel finish	
Edge finish**	

Optional specifications

Grommet*
Casters*
Power block cut-out*
HP laminate*

Accessories

Power block*

B BUNGEE™ TABLES

ACCESSORIES	MODEL #	DIMENSIONS	WT/LB.	CUBIC FT.	LIST PRICE	HP ADD
-------------	---------	------------	--------	-----------	------------	--------

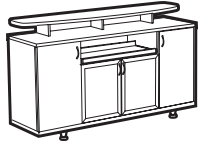

Credenza Buffet**

	W x D x H					
B2072BUF	72 x 20 x 42	305	37.5	\$3055	\$520	

Pull-out shelf. Top transaction shelf has optional edge details **(BB)**, **(BS)**, **(AB)**, **(AS)**, **(A3)** or **(AR)**; surface corners are always radiused. Side storage compartments feature a laminate door and one adjustable shelf each. Center storage features frosted aluminum doors with one adjustable shelf. Leveler feet are standard. Some assembly required.

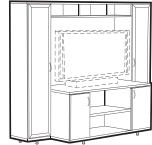

Audio/Visual Cabinet

B249072AV	90 x 24 x 72	530	52.5	\$5042	\$527	
-----------	--------------	-----	------	---------------	--------------	--

Top pigeon holes and center adjustable shelf accommodate electronic equipment, CDs and other media. Bottom storage compartments feature laminate doors and one adjustable shelf. Side storage towers feature frosted aluminum doors with three adjustable shelves each. Accommodates TVs up to 58"W x 34"H x 24"D. Some assembly required.

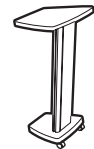

Lectern

B44LEC	22 x 17 x 44	36	12.5	\$801	N/A	
--------	--------------	----	------	--------------	-----	--

Features angled stand with pencil ledge. Optional edge details for angled surface **(BB)**, **(BS)**, **(AB)**, **(AS)**, **(A3)** or **(AR)**; surface corners are always radiused. Locking casters. Specify Black **(TBC)** or Tungsten **(TTC)**. Shipped assembled in 1 carton.

Required specifications

Finish
Fabric*
Handles**

Optional specifications

GENERAL INFORMATION

- Introducing Bungee SL - a product line to complement and coordinate with the top selling Bungee training tables series.
- Bungee SL takes the popular aesthetic of the Bungee series and allows tables to be specified in shared leg and permanent applications - great for benching, training, teaming and academic areas.
- Bungee SL tops and legs are sold separately, increasing the flexibility of the product in the future and allows for space saving in areas where real estate is a premium.
- High pressure tops are available in all Bungee SL laminates at an extended lead time - please refer to model # for pricing.
- For environmental certifications, please visit globalfurnituregroup.com.

CONSTRUCTION

- Tops are 1" thick.
- All laminate components are made of 45 lb. density particle board with high performance thermally fused laminate.
- Tops 60" and over feature a built-in support bar. The support bar is 10" from the **approach** side, and clearance to the bottom of the support bar is 27" from the floor.
- **BUNGEE CORDS ARE NOT INCLUDED AND ARE NOT COMPATIBLE WITH BUNGEE SL TOPS.**

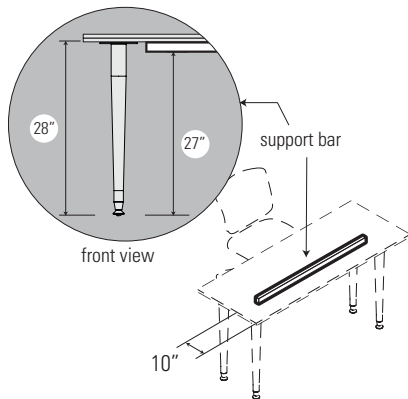

EDGE DETAIL

- Bungee SL comes with a choice of four edge styles (two with two-trim finish options):



A3 - square corner, matching edge



AR - square corner, matching bicut edge

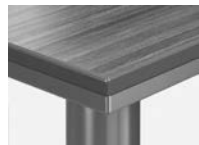

AS - square corner, Silver



AB - square corner, Black

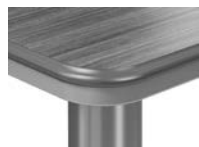

BS - rounded corner, Silver



BB - rounded corner, Black

- **BB/BS** - Bungee bubble edge: Unique "bubble" molding found on original Bungee.
- **AB/AS** - Split color PVC edge: Edge matches split color aesthetic of the bubble edge, but allows for 90 degree corners and a cleaner look.
- **A3** - 2mm preferred matching edge. Coordinates well with Adaptabilities and Zira 1" tops.
- **AR** - Bicut edge. Coordinates well with Adaptabilities and Zira 1" tops.

LEGS

- Two leg styles are available: tapered and spider leg. Available in Black (**TBL**) or Tungsten (**TTU**) finish, please specify. Levelers are standard; casters are not available for Bungee SL legs. Levelers adjust 3mm - 10mm in height.

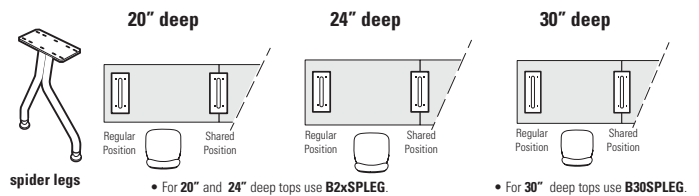

MODESTY PANELS

- See **POWER AND DATA MANAGEMENT TROUGHS**, pages 394-394.
- For modesty panels without power and data management, see **Bungee modesty panels**, pages 370-371.

WIRE MANAGEMENT / POWER OPTIONS

- **TO UTILIZE BUNGEE SL TO THE FULLEST EXTENT, SPECIFY POWER AND DATA MANAGEMENT TROUGHS**, see page 391.
- For basic wire management see details on pages 393-394.

SPECIFICATIONS

- Specifications marked with an * are applicable to only those products which have the * symbol beside the product name.

B BUNGEE SL™ - HOW TO SPECIFY

1. SPECIFY MODEL NUMBER

2. SPECIFY FINISH

ACJ Absolute Acajou	FCL First Class
ASN Asian Night	NBL Noce Biondo
AWC Avant Cherry	NGL Noce Grigio
AWH Avant Honey	NEL Noce Leggero
BLK Black	NML Noce Medio
BZD Blizzard	QTM Quartered Mahogany
BRC Brushed Cobalt	SBY Sheer Beauty
CMB Clear Maple	SDT Stonedust
CGY Custom Grey	SOG Storm Grey
DES Dark Espresso	WHE Walnut Heights
DWT Designer White	WHC White Chocolate
FAS Fashionista	WCR Winter Cherry

Edge:

BB	Bungee bubble edge with Black trim
BS	Bungee bubble edge with Silver trim
AB	Split color edge with Black trim
AS	Split color edge with Silver trim
A3	Matching 2mm flat edge
AR	Matching bicut edge

Legs:

TBL	Black
TTU	Tungsten

3. SPECIFY OPTIONS

GROMMETS

- Optional grommets available in standard worksurface locations (left, center or right) for **rectangular tops 48" and up**. Order as: **FOG1, FOG2** or **FOG3**. **Add \$91**.
- Optional grommet is available in **center position only for rectangular tops (36" and 42")**, **keystone, half moon and wedge tops**. Order as **FOG2**. **Add \$91**.
- Grommet hole dimensions are 3.25" wide x 1.875" deep.
- Grommets may be placed at non-standard locations. Order as: **CSG**. **Add \$132**. A drawing must be supplied with vertical and horizontal dimensions to the center of the cut-out (as in drawing below). Please refer to the **custom grommet location form** in the back reference section.

Grommet hole dimensions

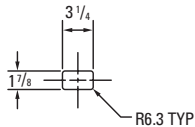

Grommet

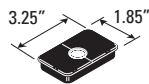

Keystone

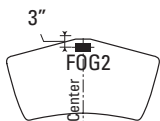

Half Moon

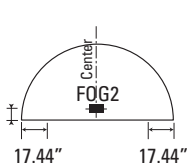

Wedge

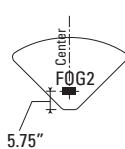

Rectangular Tops

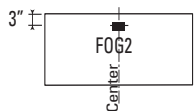

For **36" and 42"** wide units

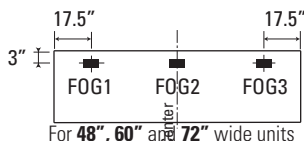

For **48", 60" and 72"** wide units

POWER BLOCK

- An individual corded power block is a rectangular worksurface power/data module with one electrical duplex receptacle and two data (RJ45) receptacles. 9' Black cord included. Power block dimensions are 6.5"W x 3.5"D x 2.75"H. Power block cut-out dimensions are 2.75" deep x 6" wide. Units cannot be daisy-chained.
- A power block cut-out (model **PMSPPDM**) may be ordered for **rectangular tops (60" and up)** in place of standard grommets. Order as **E1, E2** or **E3**. **Add \$91**.
- A power block cut-out (model **PMSPPDM**) may be ordered in the **center position only for rectangular tops (36", 42" and 48")**, **keystone and half moon tops**. Order as **E2**. **Add \$91**.
- To purchase a power block, you must specify both the power block cut-out location and the power block model #. Order power block separately as **PMSPPDM**. **Add \$268**.

Keystone

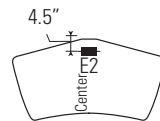

Half moon

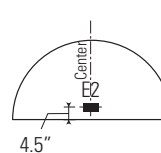

Power block

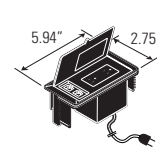

Rectangular tops

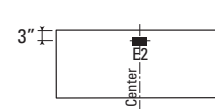

For **36", 42" and 48"** wide units

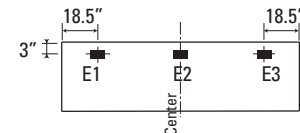

For **60" and 72"** wide units

MODPOWER DAISY-CHAIN SOLUTION

- Add flexible power and USB charging to Bungee SL rectangular tables. Connect up to four units with a single corded infeed with NEMA plug.
- ModPower units are sold separately, refer to Productivity Solutions page 473.
- Begin run with a starter unit which includes a corded infeed. Add additional middle or end units as required. Middle and end units are equipped with connecting cables.
- On-surface modules clamp on or screw mount to the table tops.
- In-surface modules require table top cut-outs for mounting. Specify cut-out option:
 - **MPS** for a single cut-out to accommodate one ModPower in-surface unit (cut-out will be centered on the approach side) for **42" to 72" wide rectangular tables**. **Add \$91**.
 - **MPD** for two cut-outs in the left and right positions, 18.25" from ends to center of unit on approach side for **60" and 72" wide rectangular tables**. **Add \$183**.

Square corner

AB/AS/A3 or AR edge only

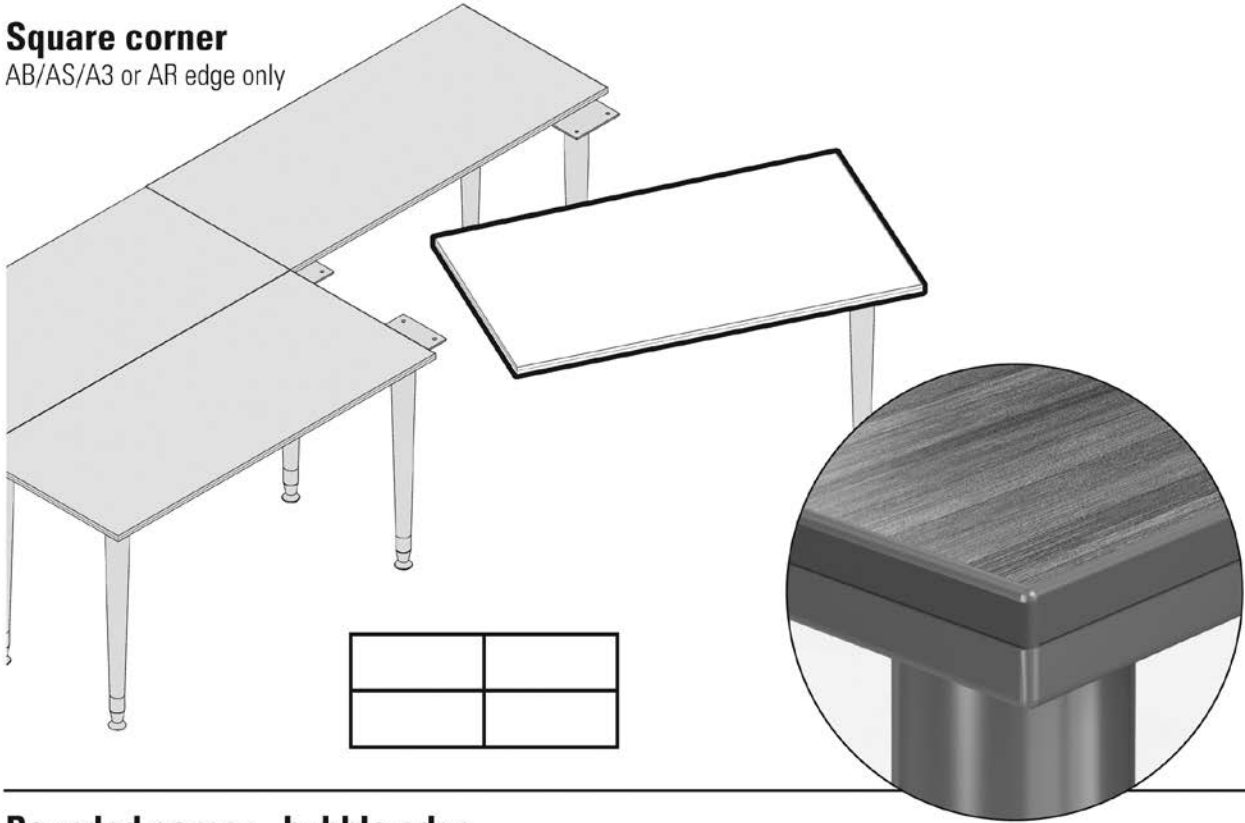
**Rounded corner - bubble edge**

BB/BS edge only

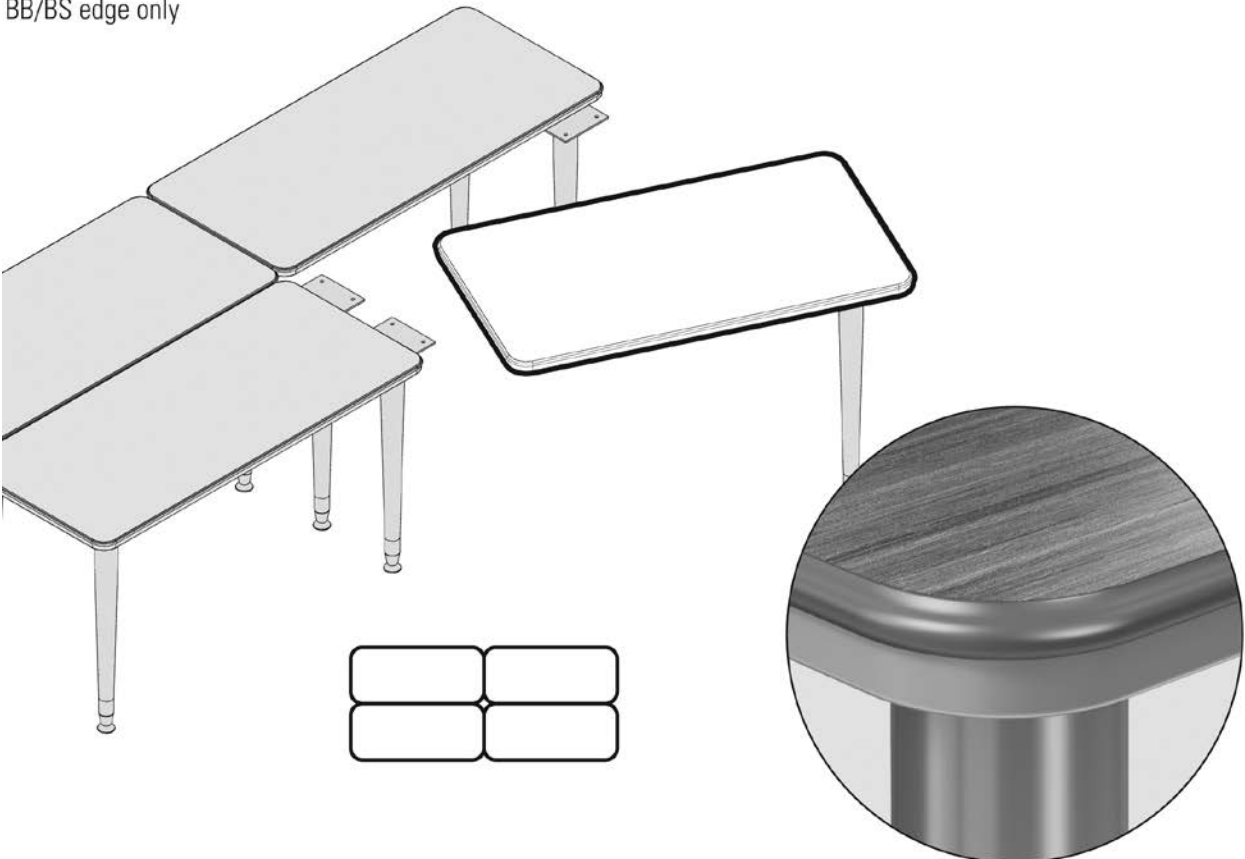

Tops with Legs and Plates Condition

Rectangular Tops

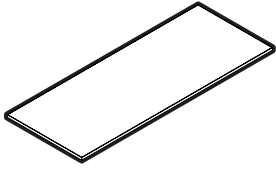

- Legs not included
- Support bar included for units with 60" and 72" width

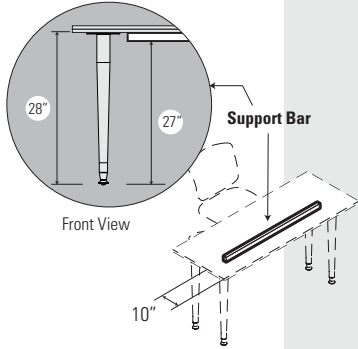

Tapered Legs

Single Straight Running Applications

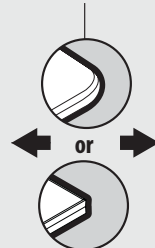
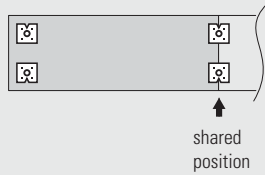

Square or Rounded Corner

Back-to-Back Applications

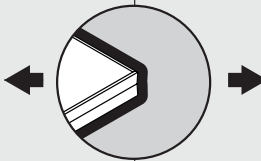
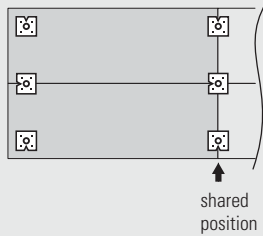

Square Corner

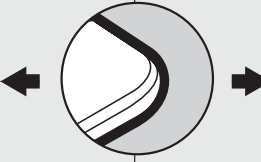
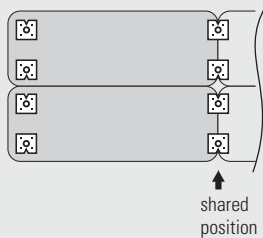

Rounded Corner

Spider Legs

Single Straight Running Applications

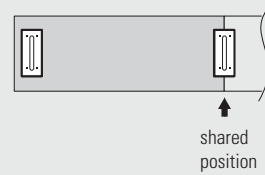

Back-to-Back Applications

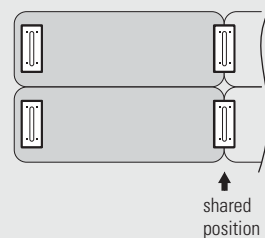
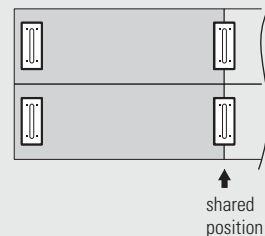

Rectangular Return Tops

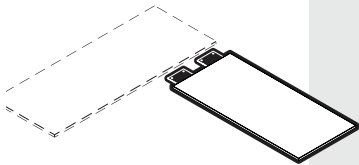

- 2 flat brackets included
- Legs not included
- Maximum width: 54"

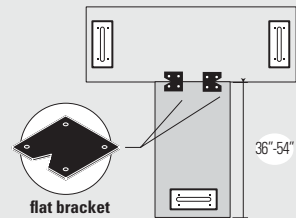
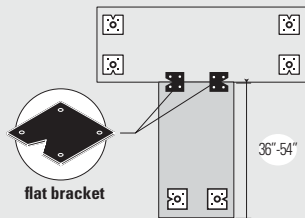
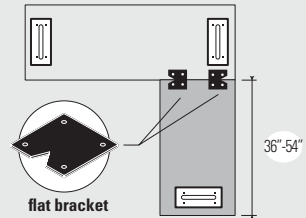
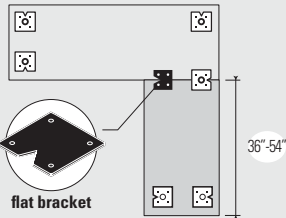

Legend:

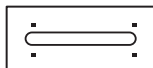

spider leg



tapered leg



flat bracket

Tops with Legs and Plates Condition

Half Moon Tops

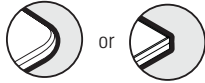
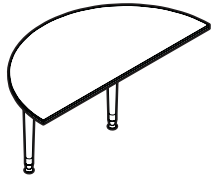

- 2 tapered legs with levelers included
- 1 flat bracket included
- Not available with spider legs
- Does not connect with spider leg tables

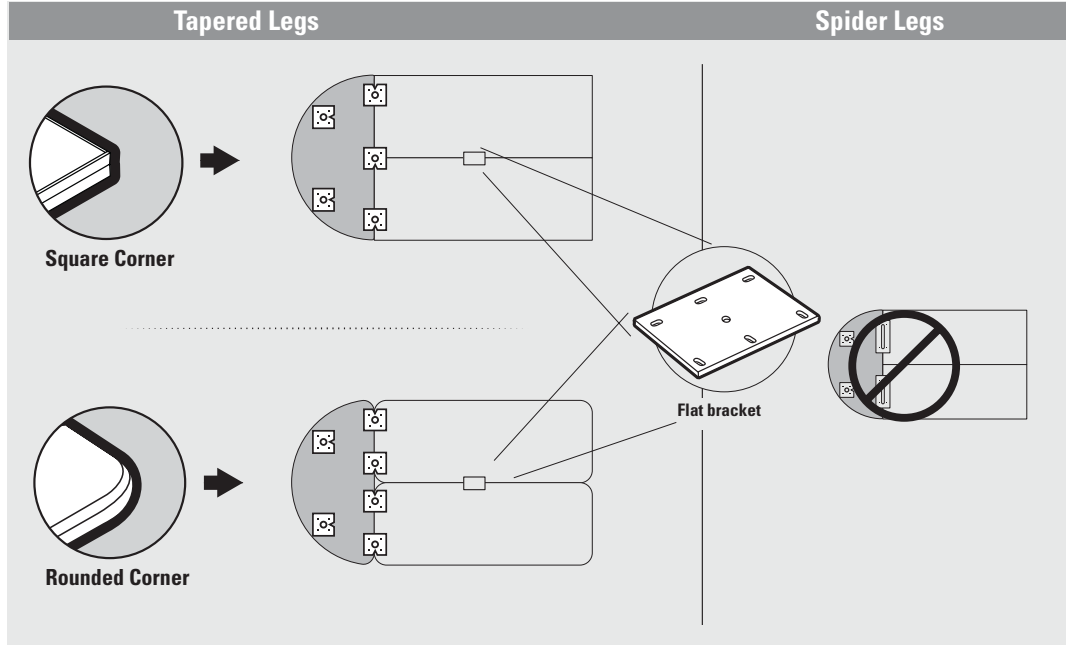

Keystone Tops

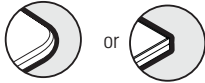
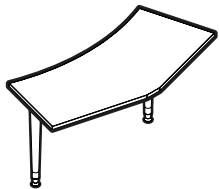

- 2 tapered legs with levelers included
- Not available with spider legs
- Does not connect with spider leg tables

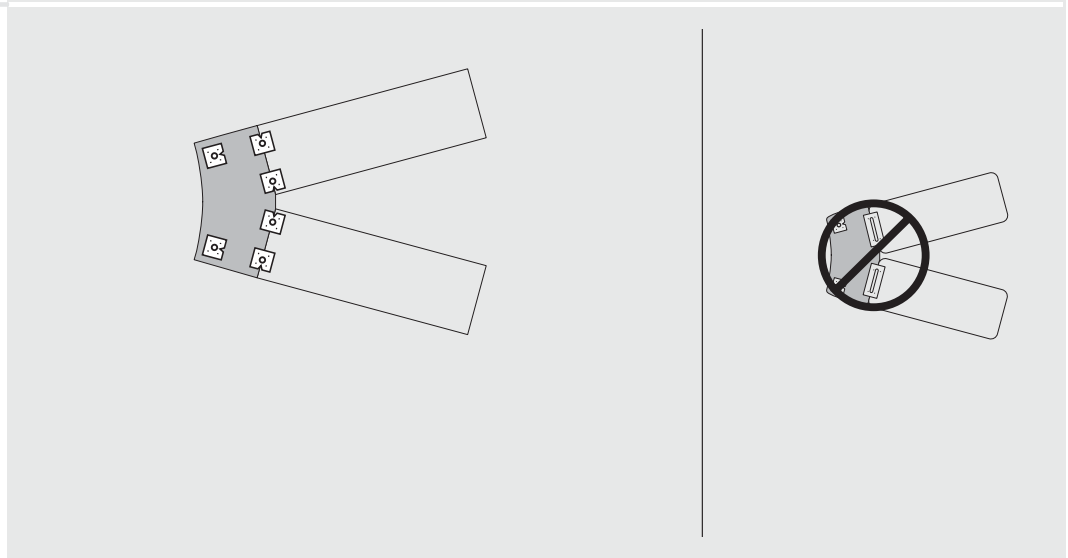

90° Wedge Tops

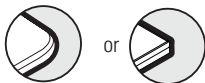

- Legs not included
- Connect to 20" or 24" deep rectangular table

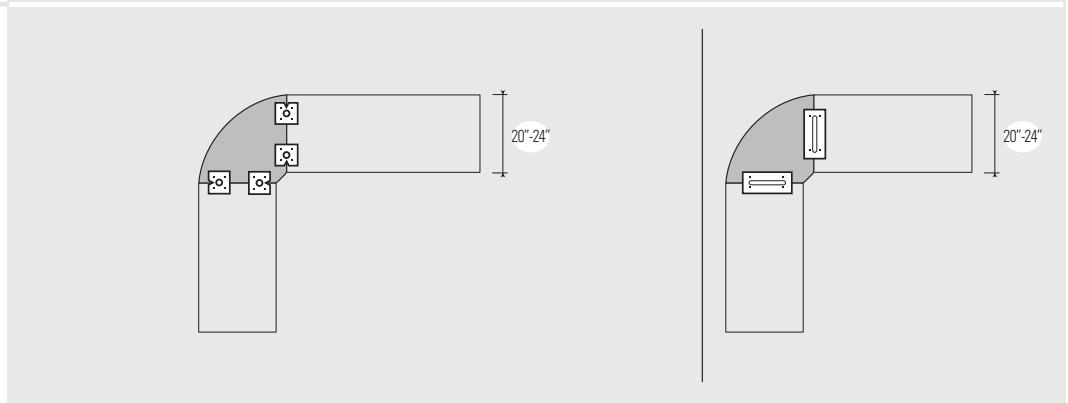

Legend:

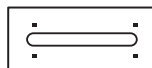

spider leg



tapered leg



plate

TOPS WITH SQUARE CORNERS

MODEL #	DIMENSIONS	WT/LB.	CUBIC FT.	LIST PRICE	HP ADD
---------	------------	--------	-----------	------------	--------

W x D x H

BS3072REC	72 x 30 x 1	60	4	\$499	\$463
BS3060REC	60 x 30 x 1	53	3.4	\$417	\$383
BS3048REC	48 x 30 x 1	46	2.7	\$253	\$309
BS3042REC	42 x 30 x 1	42	2.4	\$249	\$268
BS3036REC	36 x 30 x 1	38	2.1	\$199	\$231
BS2472REC	72 x 24 x 1	51	3.3	\$437	\$371
BS2460REC	60 x 24 x 1	44	2.8	\$380	\$309
BS2448REC	48 x 24 x 1	37	2.3	\$215	\$246
BS2442REC	42 x 24 x 1	33	2	\$206	\$215
BS2436REC	36 x 24 x 1	29	1.8	\$194	\$185
BS2072REC	72 x 20 x 1	43	2.9	\$404	\$309
BS2060REC	60 x 20 x 1	37	2.4	\$342	\$257
BS2048REC	48 x 20 x 1	30	2	\$202	\$215
BS2042REC	42 x 20 x 1	27	1.8	\$186	\$185
BS2036REC	36 x 20 x 1	24	1.5	\$173	\$185

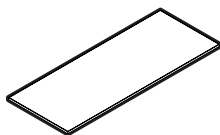

Rectangular Top - Square Corners

Rectangular 1" thick worksurface with **square corners**. Can accept tapered (B29TPLEG) or spider legs (B2XSPLEG / B30SPLEG) in "end of run" or shared leg positions. Tops 60" and up include a built-in support bar. Compatible with **power and data management troughs**, see page 391 or standard modesty panels, see page 370. Shipped easy to assemble in 1 carton.

- Do not use as return top.
- Legs sold separately.

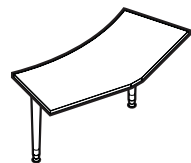

Keystone Table - Square Corners*

BS30KSF	62.75 x 30.5 x 28.7	58	4	\$887	\$463
BS24KSF	52 x 28.75 x 28.7	50	3.7	\$801	\$339
BS20KSF	44 x 27.75 x 28.7	46	3	\$732	\$278

1" thick worksurface with **square corners**. Includes **two** tapered legs. *Not available with spider legs*. Connects to other tops of 20", 24" or 30" depths. Modesty panels or filler panels are NOT available. Shipped easy to assemble in 2 cartons.

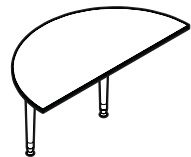

Half Moon Table - Square Corners*

BS3060HMF	59.4 x 29.75 x 28.7	57	4	\$837	\$383
BS2448HMF	48.2 x 24 x 28.7	45	3	\$785	\$246

1" thick worksurface with **square corners**. Includes **two** tapered legs. *Not available with spider legs*. Connects to other tables equaling the same length. Modesty panels or filler panels are NOT available. Shipped easy to assemble in 2 cartons.

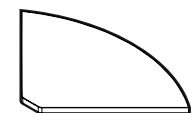

90° Wedge Top - Square Corners

BS24WE	26.8 x 26.8 x 1	15	1.5	\$240	\$215
BS20WE	22.8 x 22.8 x 1	10	1.2	\$173	\$185

1" thick worksurface with **square corners**. Can accept tapered (B29TPLEG) or spider legs (B2XSPLEG / B30SPLEG) in shared positions only. Accepts filler modesty panels. Shipped easy to assemble in 1 carton.

- Legs sold separately.

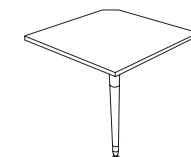

90° Corner Table - Square Corners*

BS30CN	33.2 x 33.2 x 28.7	36	2.5	\$542	\$193
--------	--------------------	----	-----	--------------	--------------

Connects to 30" deep rectangular tables. Includes **one** tapered leg. *Not available with spider legs*. Shipped easy to assemble in 1 carton.

Required specifications

Top finish
Edge detail
Leg finish*

Optional specifications

HP laminate
Grommet position or power block cut-out

Accessories

Power block
Power/data management troughs
Modesty panel

RECTANGULAR RETURN TOPS **MODEL #** **DIMENSIONS** **WT/LB.** **CUBIC FT.** **LIST PRICE** **HP ADD**

W x D x H

BS3054RRE	54 x 30 x 1	50	3.1	\$271	\$347
BS3048RRE	48 x 30 x 1	46	2.7	\$253	\$309
BS3042RRE	42 x 30 x 1	42	2.4	\$249	\$268
BS3036RRE	36 x 30 x 1	38	2.1	\$199	\$231
BS2454RRE	54 x 24 x 1	40	2.5	\$233	\$278
BS2448RRE	48 x 24 x 1	37	2.3	\$215	\$246
BS2442RRE	42 x 24 x 1	33	2	\$206	\$215
BS2436RRE	36 x 24 x 1	29	1.8	\$194	\$185
BS2054RRE	54 x 20 x 1	33	2.2	\$220	\$231
BS2048RRE	48 x 20 x 1	30	2	\$202	\$207
BS2042RRE	42 x 20 x 1	27	1.8	\$186	\$185
BS2036RRE	36 x 20 x 1	24	1.5	\$173	\$154

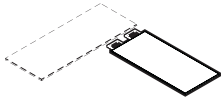

Rectangular Return Tops - Square Corners*

Rectangular 1" thick worksurface with **square corners**. Includes two flat brackets to attach to another worksurface on one end. Can accept tapered (B29TPLEG) or spider legs (B2XSPLEG / B30SPLEG) on the other end. 54" tops include a built-in support bar. Compatible with standard modesty panels, see page 370. Shipped easy to assemble in 1 carton.

- For worksurfaces to be used as a main surface, please see rectangular tops.
- Legs sold separately.

TOPS WITH ROUNDED CORNERS

BB3072REC	72 x 30 x 1	59	4	\$641	\$463
BB3060REC	60 x 30 x 1	52	3.4	\$535	\$383
BB3048REC	48 x 30 x 1	45	2.7	\$326	\$309
BB3042REC	42 x 30 x 1	41	2.4	\$318	\$268
BB3036REC	36 x 30 x 1	37	2.1	\$254	\$231
BB2472REC	72 x 24 x 1	50	3.3	\$562	\$371
BB2460REC	60 x 24 x 1	43	2.8	\$487	\$309
BB2448REC	48 x 24 x 1	36	2.3	\$276	\$246
BB2442REC	42 x 24 x 1	32	2	\$262	\$215
BB2436REC	36 x 24 x 1	28	1.8	\$249	\$185
BB2072REC	72 x 20 x 1	42	2.9	\$518	\$309
BB2060REC	60 x 20 x 1	36	2.4	\$438	\$257
BB2048REC	48 x 20 x 1	29	2	\$260	\$215
BB2042REC	42 x 20 x 1	26	1.8	\$239	\$185
BB2036REC	36 x 20 x 1	23	1.5	\$223	\$185



Rectangular Top - Rounded Corners*

Rectangular 1" thick worksurface with **rounded corners**. Can accept tapered (B29TPLEG) or spider legs (B2XSPLEG / B30SPLEG) in "end of run" or shared leg positions. Tops 60" and up include a built-in support bar. Compatible with **power and data management troughs**, see page 391 or standard modesty panels, see page 370.

Shipped easy to assemble in 1 carton.

- For worksurfaces to be used as a return, please see return tops.
- Legs sold separately.

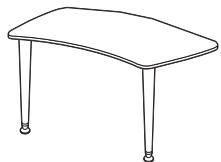

Keystone Table - Rounded Corners

BB30KSF	62.75 x 30.5 x 28.7	57	4	\$1058	\$463
BB24KSF	52 x 28.75 x 28.7	49	3	\$950	\$339
BB20KSF	44 x 27.75 x 28.7	45	3	\$860	\$278

1" thick worksurface with **rounded corners**. Includes **two** tapered legs. *Not available with spider legs*. Connects to other tops of 20", 24" or 30" depths. Modesty panels or filler panels are NOT available. Shipped easy to assemble in 2 cartons.

Required specifications

Top finish
Edge detail
Leg finish (only BBxxKSF)

Optional specifications

HP laminate
Grommet position or power block cut-out*

Accessories

Power block
Modesty panel*
Power/data management troughs*

B BUNGEE SL™

TOPS WITH ROUNDED CORNERS

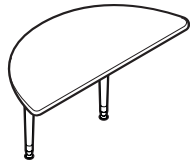

Half Moon Table - Rounded Corners*

MODEL #	DIMENSIONS W x D x H	WT/LB.	CUBIC FT.	LIST PRICE	HP ADD
BB3060HMF	59.4 x 29.75 x 28.7	56	4	\$999	\$383
BB2448HMF	48.2 x 24 x 28.7	44	3.1	\$930	\$246

1" thick worksurface with **rounded corners**. Includes **two** tapered legs. *Not available with spider legs.* Connects to other tables equaling the same length. Modesty panels or filler panels are NOT available. Shipped easy to assemble in 2 cartons.



90° Wedge Top - Rounded Corners

BB24WE	26.8 x 26.8 x 1	14	1.5	\$308	\$215
BB20WE	22.8 x 22.8 x 1	9	1.2	\$223	\$185

1" thick worksurface with **rounded corners**. Can accept tapered (B29TPLEG) or spider legs (B2XSPLEG / B30SPLEG) in shared positions only. Accepts filler modesty panels. Shipped easy to assemble in 1 carton.

- Legs sold separately.

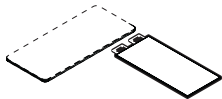

Rectangular Return Tops - Rounded Corners

BB3054RRE	54 x 30 x 1	50	3.1	\$349	\$347
BB3048RRE	48 x 30 x 1	46	2.7	\$326	\$309
BB3042RRE	42 x 30 x 1	42	2.4	\$318	\$268
BB3036RRE	36 x 30 x 1	38	2.1	\$254	\$231
BB2454RRE	54 x 24 x 1	40	2.5	\$299	\$278
BB2448RRE	48 x 24 x 1	37	2.3	\$276	\$246
BB2442RRE	42 x 24 x 1	33	2	\$262	\$215
BB2436RRE	36 x 24 x 1	29	1.8	\$249	\$185
BB2054RRE	54 x 20 x 1	33	2.2	\$286	\$231
BB2048RRE	48 x 20 x 1	30	2	\$260	\$207
BB2042RRE	42 x 20 x 1	27	1.8	\$239	\$185
BB2036RRE	36 x 20 x 1	24	1.5	\$223	\$154

Rectangular 1" thick worksurface with **rounded corners**. Includes two flat brackets to attach to another worksurface on one end. Can accept tapered (B29TPLEG) or spider legs (B2XSPLEG / B30SPLEG) on the other end. 54" tops include a built-in support bar. Compatible with standard modesty panels, see page 370. Shipped easy to assemble in 1 carton.

- For worksurfaces to be used as a main surface, please see rectangular tops.
- Legs sold separately.

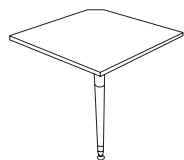

90° Corner Table - Rounded Corners*

BB30CN	33.17 x 33.17 x 28.7	36	2.5	\$578	\$193
--------	----------------------	----	-----	--------------	--------------

Connects to 30" deep rectangular tables. Includes **one** tapered leg. *Not available with spider legs.* Shipped easy to assemble in 1 carton.

Required specifications



Top finish
Edge detail
Leg finish*

Optional specifications

Grommet
HP laminate

Accessories

Power block (rectangular return tops)
Modesty panel (rectangular return tops)

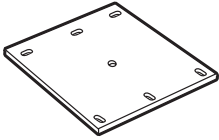
LEGS	MODEL #	DIMENSIONS W x D x H	WT/LB.	CUBIC FT.	LIST PRICE	HP ADD
 <p>Spider Legs for 30" D Tables</p>	B30SPLEG	6 x 25 x 27.7	16	2.9	\$349	N/A
<p>Spider leg with levelers. Shipped 1 per carton. Tops sold separately.</p> <ul style="list-style-type: none"> • Available in Black (TBL) or Tungsten (TTU), please specify. • To be used with 30" deep tops only. 						
 <p>Spider Legs for 20" & 24" D Tables</p>	B2XSPLEG	6 x 20 x 27.7	14	2.2	\$299	N/A
<p>Spider leg with levelers. Shipped 1 per carton. Tops sold separately.</p> <ul style="list-style-type: none"> • Available in Black (TBL) or Tungsten (TTU), please specify. • To be used with 24" & 24" deep tops only. 						
 <p>Tapered Leg</p>	B29TPLEG	6 x 6 x 27.7	11	0.75	\$139	N/A
<p>Tapered leg with levelers for tables of all depths. Shipped 1 per carton. Tops sold separately.</p> <ul style="list-style-type: none"> • Available in Black (TBL) or Tungsten (TTU), please specify. 						
 <p>Flat Bracket</p>	B6PLT	6 x 6 x 0.25	2	0.1	\$45	N/A
<p>To be used as a mending plate for Bungee SL. Black only. Shipped/sold 1 per pack. There are no specifications for Flat Bracket.</p>						

Required specifications
Leg finish

B BUNGEE SL™ POWER/DATA MANAGEMENT TROUGHS - NOTES

GENERAL INFORMATION

- Power and data management troughs for the Bungee SL table series. Add Global's proprietary 4-wire power kits and create cost effective and versatile training, benching, academic and meeting areas.
- Front panels are available in laminate or aluminum. A center spine version allows for inexpensive double-sided applications.
- **POWER AND DATA MANAGEMENT TROUGHS** are sold separately and are meant to be used on **Bungee SL only**.
- **POWER AND DATA MANAGEMENT TROUGHS** accept Global's 4-wire power kit in addition to numerous data, phone and other multimedia wires.
- Filler modesty panels conceal wiring in spaces not covered by troughs.
- For environmental certifications, please visit globalfurnituregroup.com.

FINISHES

Laminate:

ACJ Absolute Acajou	FCL First Class
ASN Asian Night	NBL Noce Biondo
AWC Avant Cherry	NGL Noce Grigio
AWH Avant Honey	NEL Noce Leggero
BLK Black	NML Noce Medio
BZD Blizzard	QTM Quartered Mahogany
BRC Brushed Cobalt	SBY Sheer Beauty
CMB Clear Maple	SDT Stonedust
CGY Custom Grey	SOG Storm Grey
DES Dark Espresso	WHE Walnut Heights
DWT Designer White	WHC White Chocolate
FAS Fashionista	WCR Winter Cherry

Aluminum Face Panel, Trough, Filler Panels and End Caps:

Black (**BLK**) Tungsten (**TUN**)

LAMINATE FACE PANEL (LFP)

- Laminate face panel (LFP) on the approach side is 11/16" thick. LFP height is 13".
- Rear access panel is 0.25" thick laminate. Rear panel height is 7.25".
- LFP and rear panel swing up to allow wire access and feature a flexible sweep at the top.
- All laminate components are made of 45 lb. commercial density particle board, covered on both sides with high performance, thermally fused laminate.
- The trough portion of the unit is made of a heavy duty aluminum extrusion to allow wire systems (including Global's 4-Wire System) to lie within the bottom.
- LFP is available in all standard laminates, aluminum trough available in Black (**BLK**) or Tungsten (**TUN**) finish, please specify (rear access panel is finished in Brushed Cobalt (**BRC**) laminate when TUN is specified, or Black (**BLK**) laminate when BLK is specified).
- End caps (JBEC) sold separately.

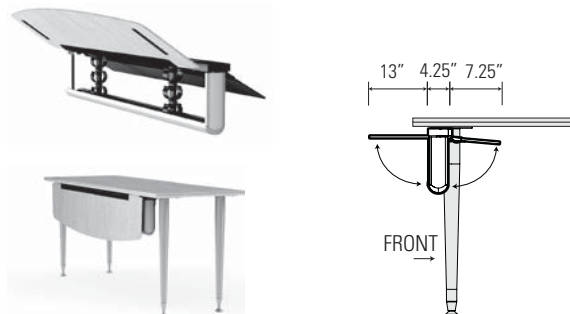

Tops, legs and end caps not included.

ALUMINUM FACE PANEL (AFP)

- Aluminum face panel (AFP) is an aluminum extrusion. AFP height is 8.25".
- AFP swings down to allow wire access and features a flexible sweep at the top.
- Rear access panel is 0.25" thick laminate. Rear panel height is 7.25".
- Rear panel swings up to allow wire access and features a flexible sweep at the top.
- The trough portion of the unit is made of a heavy duty aluminum extrusion to allow wire systems (including Global's 4-Wire System) to lie within the bottom.
- AFP and aluminum trough available in Black (**BLK**) or Tungsten (**TUN**) finish, please specify (rear access panel is finished in Brushed Cobalt (**BRC**) laminate when TUN is specified, or Black (**BLK**) laminate when BLK is specified).
- End caps (JBEC) sold separately.

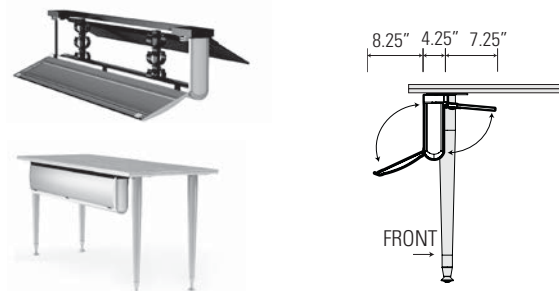

Tops, legs and end caps not included.

CENTER SPINE (CS)

- 0.25" thick laminate panels on both sides of the unit. Panel height is 7.25".
- Both panels swing up to allow wire access and feature a flexible sweep at the top.
- All laminate components are made of 45 lb. commercial density particle board, covered on both sides with high performance, thermally fused laminate.
- The trough portion of the unit is made of a heavy duty aluminum extrusion to allow wire systems (like Global's 4-Wire System) to lie within the bottom.
- Aluminum trough available in Black (**BLK**) or Tungsten (**TUN**) finish, please specify (rear access panel is finished in Brushed Cobalt (**BRC**) laminate when TUN is specified, or both access panels are finished in Black (**BLK**) laminate when BLK is specified).
- End caps (JBEC) sold separately.



Tops, legs and end caps not included.

FILLER MODESTY PANELS

- Used to fill the space between two power and data management troughs and conceal wiring from the approach side.
- Straight filler allows for use in straight configurations between two rectangular tables with power and data management troughs.
- Curved filler allows for use at curve with 90° wedge tables between two rectangular tables with power and data management troughs.
- Available in Silver (**SI**) or Black (**BK**) finish, please specify.

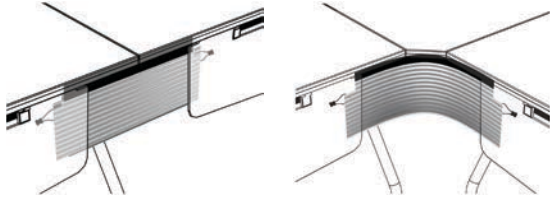

Straight filler modesty panel

Curved filler modesty panel

END CAPS

- Plastic end caps with decorative insert. Required for beginning and end of runs.
- Cap can be notched in field to allow wire infeed pass-through.
- Available in Black (**BLK**) or Tungsten (**TUN**) finish, please specify.



WIRE MANAGEMENT

- Two wire manager clamps are included within all power and data management troughs.
- Attached to the unit, they can slide from side-to-side to accommodate wiring systems.
- Data, voice, multimedia and power can be routed separately using channels on each wire manager.
- Additional wire manager clamps are available to retrofit.
- Available in Black only.

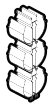

POWER SNAKE

- Attaches to underside of worksurface to organize and manage wires from the power trough to the floor in-feed.
- Black finish only.

GLOBAL 4-WIRE POWER SYSTEM

- Global's proprietary power system comes with everything you need to power your **Bungee SL** layouts. Kits coordinate to the size of the table being used and fit snugly into the bottom of the power and data management trough.
- Single duplex kits come with one duplex - centered on the wiring harness. Duplexes are 6" wide.
- Double duplex kits come with two duplexes - 11" of wiring on each side of the harness allows for flexibility between connections. Duplexes are 6" wide.
- One end of the harness kit features a female connection, while the opposite end features a male connection for a quick and easy connect/disconnect.
- Actual kit length is 1" longer than nominal.
- Must be hardwired using infeeds (specified separately) by a licensed electrician.
- All conduits are enclosed in a Black nylon sleeve to reduce visibility.
- All duplexes and connectors are plastic. Black only.
- **8 DUPLEXES PER CIRCUIT MAXIMUM** - maximums are to national electric code (NEC) - some local codes vary from NEC code - it is the customer's responsibility to follow all applicable local codes and guidelines.

ELECTRICAL SYSTEM

4-2 Wiring Schematic

4-Wire Shared Neutral

Complies with National Electric Code

UL Listed

All circuits rated for 20 AMP

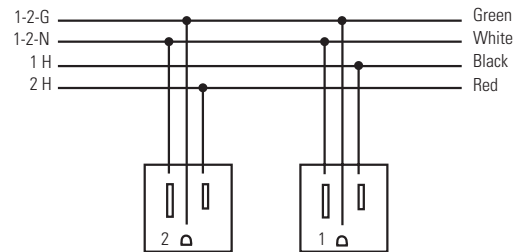

PRODUCT

MAX UNITS PER CIRCUIT

P42S	8 units per circuit
P42D	4 units per circuit

B BUNGEE SL™ POWER/DATA MANAGEMENT TROUGHS - NOTES

POWER/DATA MANAGEMENT TROUGH PLACEMENT

Single Table - AFP or LFP

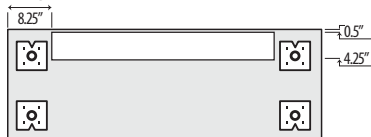

Shared Leg Tables - AFP or LFP

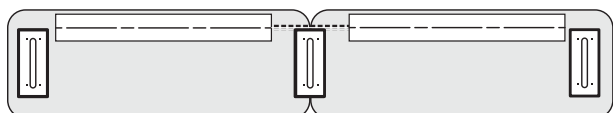
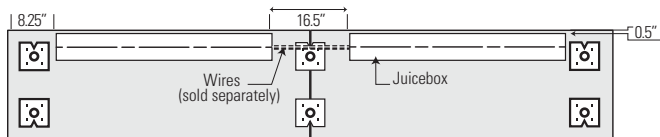

CS

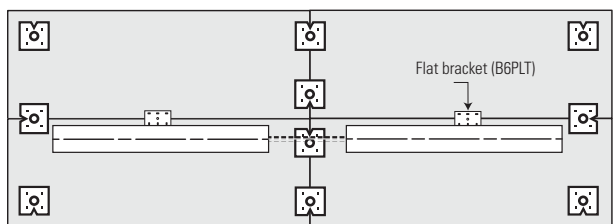

CS

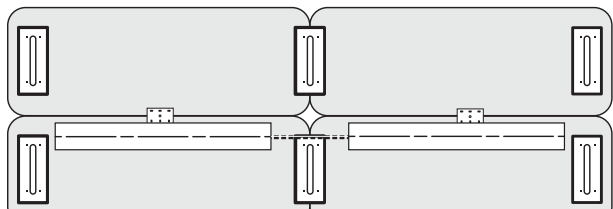

GLOBAL 4-WIRE POWER TO POWER/DATA MANAGEMENT TROUGH:

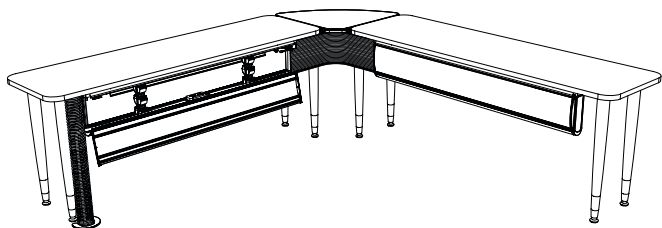

Bungee SL with AFP Power/Data Management Trough - 90° Corner Application

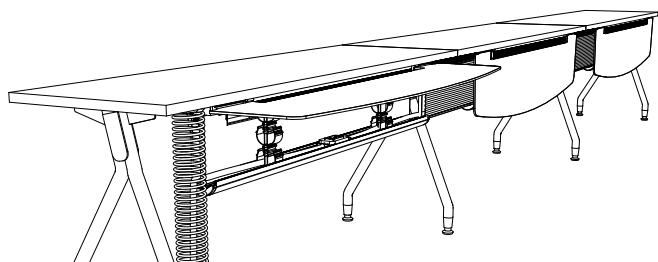

Bungee SL with LFP Power/Data Management Trough - Single Sided Straight Run
(available in Black finish only)



Bungee SL with CS Power/Data Management Trough - Back to Back Application
(shown with power snake)

UTILIZING POWER BLOCKS AND GROMMETS WITH POWER/DATA MANAGEMENT TROUGH

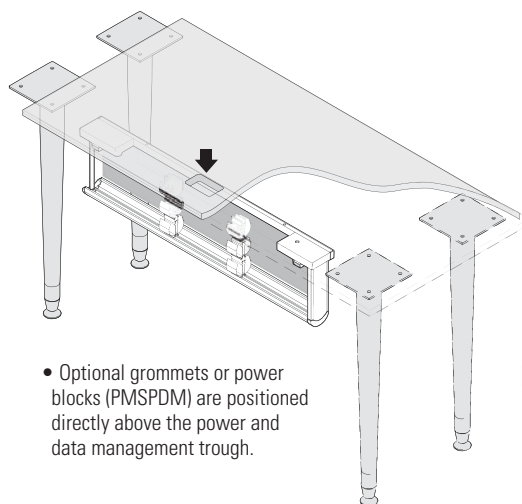

Grommet

Power block

- Optional grommets or power blocks (PMSPDM) are positioned directly above the power and data management trough.

TROUGHS	MODEL #	DIMENSIONS	WT/LB.	CUBIC FT.	LIST PRICE
---------	---------	------------	--------	-----------	------------



Trough w/Laminate Face Panel (LFP)

	W x D x H				
JB72L	55.75 x 4.33 x 13	23	2.9	\$710	
JB60L	43.75 x 4.33 x 13	18	2.3	\$635	
JB48L	31.75 x 4.33 x 13	14	1.7	\$550	
JB42L	25.75 x 4.33 x 13	12	1.5	\$510	
JB36L	19.75 x 4.33 x 13	10	1.2	\$467	

For use on rectangular Bungee SL surfaces only. Out-facing laminate panel swings up to allow wire access and features flexible sweep at the top. In-facing laminate panel swings up to allow wire access and features flexible sweep at the top. **Black finish only.** Black wire management clamps included.

- To fill the gap between two power/data management trough (LFP) modules in a straight run, a single filler modesty panel (JBSFM) is recommended.
- To fill the gap between two power/data management trough (LFP) modules at 90°, a corner filler modesty panel (JBCFM) is recommended.
- Model # corresponds to the size of table the power/data management trough will fit on (i.e. JB72L will fit a 72" wide table).



Trough w/Center Spine (CS)

JB72C	55.75 x 4.33 x 10	19	2.2	\$640	
JB60C	43.75 x 4.33 x 10	15	1.8	\$601	
JB48C	31.75 x 4.33 x 10	12	1.3	\$510	
JB42C	25.75 x 4.33 x 10	10	1.1	\$473	
JB36C	19.75 x 4.33 x 10	8	0.8	\$439	





For use on rectangular Bungee SL surfaces only in back-to-back applications only. Two laminate panels swing up to allow wire access and feature flexible sweep at the top. Black wire management clamps included.

- To fill the gap between two power/data management trough (CS) modules in a straight run, two filler modesty panels (JBSFM) are recommended to conceal wiring from both sides.
- Model # corresponds to the size of table the power/data management trough will fit on (i.e. JB72C will fit a 72" wide table).

Required specifications
 Aluminum face panel finish (AFP)
 Power/data trough finish
 Trough finish, laminate face panel (LFP)

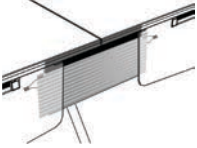
Accessories
 4-wire power system
 End cap
 Power snake

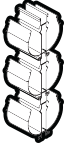
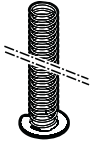
B BUNGEE SL™ POWER/DATA MANAGEMENT TROUGHS

ACCESSORIES	MODEL #	DIMENSIONS W x D x H	WT/LB.	CUBIC FT.	LIST PRICE
 <p>Straight Filler Modesty Panel</p>	JBSFM	22.5 x 0.25 x 9	1.6	0.4	\$153
<p>Straight filler modesty is used to fill the space between two power/data management trough modules where tables are linked in a straight configuration.</p> <ul style="list-style-type: none"> In center spine applications, two straight filler modesty panels should be specified to cover cabling and wires from both sides. 					
 <p>Curved Filler Modesty Panel</p>	JBCFM	28.5 x 0.25 x 9	1.8	0.5	\$183
<p>Curved filler modesty is used to fill the space between two power/data management troughs where tables are linked at a 90° curve.</p> <ul style="list-style-type: none"> For interior curves only. 					
 <p>End Cap</p>	JBEC	8 x 3 x 1	1	0.15	\$35
<p>Plastic end cap to be snapped into place at the end of power/data management troughs. To be specified for the beginning and end of runs for a finished look. Charcoal finish only.</p> <ul style="list-style-type: none"> Plastic cap can be notched in the field to allow infeed or data cable pass-through. 					
 <p>Wire Management Clamp</p>	JBWM2	8.5 x 3 x 2	1	0.1	\$138
<p>Wire management track with double wire clamp - triple height. Can be affixed to the underside of worksurface using double-sided tape (supplied) or retrofit into power/data management trough modules. Black finish only.</p> <ul style="list-style-type: none"> Recommended for use at 90° corners. Retrofitting requires disassembly of power/data management trough modules. 					
 <p>Power Snake</p>	JBPS	4 x 4 x 34	2	0.25	\$151
<p>Attaches to the underside of worksurface with supplied wood screws. Used to organize and channel wires from the power/data management trough down to the floor infeed. Black finish only.</p>					
 <p>Cable Terminator Mount</p>	JBCTM	7 x 6.5 x -	1	0.1	\$69
<p>Secures terminated data or telephone cables. Attaches with two screws to aluminum trough, inside power trough. Designed to hold multiple data solutions. Inserts not included. Black finish only.</p>					

4-WIRE POWER SYSTEM

MODEL # DIMENSIONS WT/LB. CUBIC FT. LIST PRICE

W x D x H

Circuit 1

PP42SO721	72 x - x -	3.2	0.1	\$167
PP42SO661	66 x - x -	3	0.09	\$160
PP42SO601	60 x - x -	2.8	0.09	\$154
PP42SO541	54 x - x -	2.6	0.08	\$148
PP42SO481	48 x - x -	2.4	0.08	\$141
PP42SO421	42 x - x -	2.3	0.07	\$133
PP42SO361	36 x - x -	2.1	0.06	\$127
PP42SO301	30 x - x -	1.9	0.06	\$120
PP42SO241	24 x - x -	1.7	0.05	\$110

Circuit 2

PP42SO722	72 x - x -	3.2	0.1	\$167
PP42SO662	66 x - x -	3	0.09	\$160
PP42SO602	60 x - x -	2.8	0.09	\$154
PP42SO542	54 x - x -	2.6	0.08	\$148
PP42SO482	48 x - x -	2.4	0.08	\$141
PP42SO422	42 x - x -	2.3	0.07	\$133
PP42SO362	36 x - x -	2.1	0.06	\$127
PP42SO302	30 x - x -	1.9	0.06	\$120
PP42SO242	24 x - x -	1.7	0.05	\$110

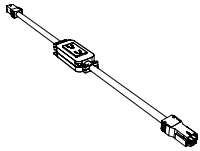

Single Duplex Kit

Single duplex kit includes one Black plastic duplex connected to harnesses. Male connection (IN) on one side with female connection (OUT) on the opposite for easy connect and disconnect. Conduit is wrapped in Black nylon sleeve. Actual length is 1" longer than nominal.

- Please specify Circuit 1 or Circuit 2.
- Model # corresponds to the size of table the power/data management trough will fit on (i.e. PP42SO481 will fit a JB48A, JB48L or JB48C module).
- Infeed required for connection to building power. Sold separately, see page 394.

Circuit 1

PP42DO721	72 x - x -	3	0.1	\$193
PP42DO661	66 x - x -	2.8	0.09	\$187
PP42DO601	60 x - x -	2.6	0.09	\$180
PP42DO541	54 x - x -	2.4	0.08	\$173
PP42DO481	48 x - x -	2.3	0.08	\$166
PP42DO421	42 x - x -	2.1	0.07	\$158
PP42DO361	36 x - x -	1.9	0.06	\$153

Circuit 2

PP42DO722	72 x - x -	3	0.1	\$193
PP42DO662	66 x - x -	2.8	0.09	\$187
PP42DO602	60 x - x -	2.6	0.09	\$180
PP42DO542	54 x - x -	2.4	0.08	\$173
PP42DO482	48 x - x -	2.3	0.08	\$166
PP42DO422	42 x - x -	2.1	0.07	\$158
PP42DO362	36 x - x -	1.9	0.06	\$153

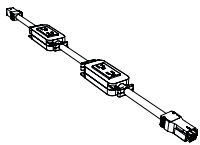

Double Duplex Kit

Double duplex kit includes two Black plastic duplexes connected to harnesses. Male connection (IN) on one side with female connection (OUT) on the opposite for easy connect and disconnect. Conduit is wrapped in Black nylon sleeve. Actual length is 1" longer than nominal.

- Please specify Circuit 1 or Circuit 2. Both duplexes on the kit will be assigned to the same circuit.
- Model # corresponds to the size of table the power/data management trough will fit on (i.e. PP42DO481 will fit a JB48A, JB48L or JB48C module).
- Infeed required for connection to building power. Sold separately, see page 394.

B BUNGEE SL™ POWER/DATA MANAGEMENT TROUGHS

4-WIRE POWER SYSTEM



Power Harness Jumper

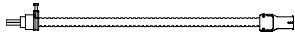

72" Multi-Circuit Hardwire Infeed

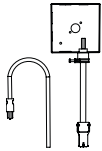

Single-Circuit 3-Prong Infeed

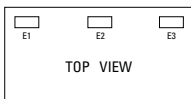
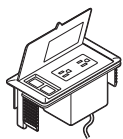

Power/Data Block

MODEL #	DIMENSIONS	WT/LB.	CUBIC FT.	LIST PRICE
---------	------------	--------	-----------	------------

W x D x H

PP42J72	73 x - x -	3	0.1	\$146
PP42J66	67 x - x -	2.91	0.09	\$141
PP42J60	61 x - x -	2.73	0.09	\$137
PP42J54	55 x - x -	2.54	0.08	\$132
PP42J48	49 x - x -	2.35	0.08	\$127
PP42J42	43 x - x -	2.16	0.07	\$122
PP42J36	37 x - x -	1.98	0.06	\$117
PP42J30	31 x - x -	1.79	0.06	\$113
PP42J24	25 x - x -	1.6	0.05	\$109
PP42J18	19 x - x -	1.41	0.04	\$102

Male connection (IN) on one side with female connection (OUT) on the opposite for easy connect and disconnect. Conduit is wrapped in Black nylon sleeve. Actual length is 1" longer than nominal.

- Use PP42J18 between two power/data management troughs separated by Bungee SL wedge, keystone or half moon tables
- Use all other sizes to jump between power kits on power/data management troughs that are NOT powered (i.e. use a PP42J60 as a pass-through on a 60" wide non-powered table between POWERED power/data management trough modules.

PP42HW72	72 x - x -	6.5	0.3	\$165
----------	------------	-----	-----	--------------

72" multi-circuit hardwire infeed (up to 20 AMPS per circuit), two circuits. Provides single power entry from floor or wall located building power supply. Conduit is wrapped in Black nylon sleeve.

- Connects P42S or P42D kits.
- **TO BE HARDWIRED BY LICENSED ELECTRICIAN.** UL listed.
- Where liquid tight conduit is required, specify P42HW-72L.

PP42TP120	4 x 8 x 2	6.1	0.3	\$173
PP42TP72	4 x 8 x 4	4.5	0.15	\$155

Hardwire junction box included (to be mounted on underside of table). Provides single power entry from floor or wall located building power supply. Conduit is wrapped in Black nylon sleeve. Allows for quick and easy disconnection from the wall. Available in 72" or 120" overall lengths.

- Connects P42S or P42D kits. **Power Circuit 1 only.**
- **TO BE HARDWIRED BY LICENSED ELECTRICIAN.** UL listed.

PMSPPDM	6.5 x 3.5 x 2.75	2	0.1	\$268
---------	------------------	---	-----	--------------

Worksurface power and data module. Two power receptacles and two data receptacles. 9' Black cord. Specify position and **Add \$91** for cut-out in worksurface. See page 394 for required locations. Black only.



ConnecTABLES provides solutions for a variety of day-to-day work environments. Designed as easy-to-use linking or freestanding tables, ConnecTABLES is limited only by your imagination.

Open Conference

Many ConnecTABLES tops can be assembled to be freestanding. When combined with locking casters and the flip-top T-leg, the result is easy storage and complete portability.

Meeting Rooms

ConnecTABLES modular units provide quick and affordable answers for all sizes and shapes of rooms and applications.

Educational and Training Rooms

ConnecTABLES table tops configure easily into temporary or permanent educational applications.



T-leg with leveling glides.



Modesty panel.

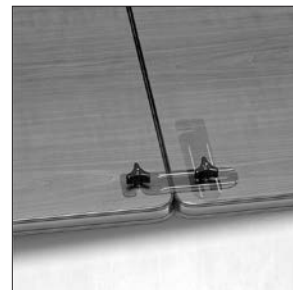

Optional ganging connector.

Features and Benefits

- Optional, easy-to-use thumbscrews allow installation without tools.
- Optional zinc-plated steel ganging hardware connects freestanding tops without moving T-leg position.
- Optional modesty panel wire management unit available.
- Casters will not affect table height when used in conjunction with or in place of glides.
- Optional Black grommets for convenient wire management can be ordered "factory installed".
- Tops are 1" thick and constructed of 45 lb. density particle board.
- Optional casters available with or without manual locks provide mobility.
- ConnecTABLES tops are available in all Global laminate finishes with three leg and two edge color options.

GENERAL INFORMATION

- ConnecTABLES is an affordable and highly flexible system of modular tables. Designed as easy-to-use linking or freestanding tables, ConnecTABLES adapts to every requirement: seminar or training room, meeting room, personal workstations, educational, conferencing and team cluster workgroups.
- ConnecTABLES have eight basic top shapes available in various sizes.
- ConnecTABLES edges **do not match** any other Global product in either color or style.
- For environmental certifications, please visit globalfurnituregroup.com.

WORKSURFACES

- Tops are 1" thick, made of 45 lb. density particle board covered on both sides with high performance thermally fused laminate.
- Laminate finishes are available in high pressure. Contact your Customer Service representative for a quote.
- If other than a Global standard laminate finish is preferred, contact your Customer Service representative. Information needed includes the name of the laminate manufacturer, color name, number and model of table. You will then be given a quote for this special order.
- **ConnecTABLES edges do not match any other Global product in either color or style.**

CONSTRUCTION

- Some components can stand-alone when the "T" base is set in the freestanding position. When the "T" base is in the linking position, all the components can be used in grouping configurations (clusters).
- Optional wire grommets not available on 45° wedge and the 60° triangle.
- Rectangular tops 54" in length and longer are supplied with a 16" gauge steel support channel. Top is predrilled for placement.
- Shipped easy to assemble.
- Special width tops are available. Use next size up.
- Adjustable levelers offer up to 1" adjustability.
- Elliptical column cover, glides, casters, thumbscrews and endcaps available in Black only.
- MUST specify top, edge, and "T" base color with each order.

LEGS

- T-leg is coated with environmentally friendly, recyclable paint electrostatically applied epoxy powder coating for a very durable finish in three colors as specified below. Only the bottom horizontal portion of the painted leg is visible.
- Black plastic leveling glides offer 1" adjustability.
- Two Black plastic elliptical column caps cover each leg column.
- Casters will not affect table height when used in conjunction with or in place of glides.
- Casters can facilitate mobility in installations which need to be moved frequently.
- Legs when used with casters have no adjustability for leveling.

LAMINATE FINISHES

ACJ Absolute Acajou	FCL First Class
ASN Asian Night	NBL Noce Biondo
AWC Avant Cherry	NGL Noce Grigio
AWH Avant Honey	NEL Noce Leggero
BLK Black	NML Noce Medio
BZD Blizzard	QTM Quartered Mahogany
BRC Brushed Cobalt	SBY Sheer Beauty
CMB Clear Maple	SDT Stonedust
CGY Custom Grey	SOG Storm Grey
DES Dark Espresso	WHE Walnut Heights
DWT Designer White	WHC White Chocolate
FAS Fashionista	WCR Winter Cherry

EDGE COLORS

Black (BLK)

LEG COLORS

Black (TBL) Shadow (TSH)
 Chrome (CHM)* Tungsten (TTU)
 *optional on foot only

GROMMETS

- Optional grommets are available in standard worksurface locations (left, center or right) **for rectangular tables**. Order as: **FOG1, FOG2 or FOG3. Add \$91.**
- Grommet hole dimensions are 3.25" wide x 1.875" deep.

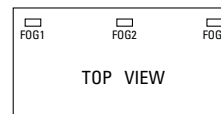
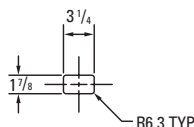

- Grommets may be placed at non-standard locations. Order as: **CSG. Add \$132.** A drawing must be supplied with vertical and horizontal dimensions to the center of the cut-out (as in drawing above). Please refer to the **custom grommet location form** in the back reference section.
- If adding **Cove mini power block** to FOG cut-out, cannot use with modesties.

POWER BLOCK

- An individual corded power block (model **PMSPDM**) may be ordered on all worksurfaces.
- Power block is a configured with one electrical duplex receptacle and two data (RJ45) receptacles. 9' Black cord included. Power block dimensions are 6.5"W x 3.5"D x 2.75"H. Units cannot be daisy-chained and cannot be used with modesties.
- To purchase a power block, you must specify both the power block cut-out location and the power block model #. Order power block as **PMSPDM. Add \$268.** Power blocks are available in standard worksurface locations (left, center or right). Order as **E1, E2 or E3. Add \$91.**

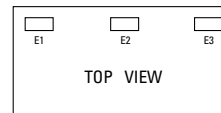
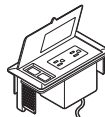

Power block **PMSPDM. Add \$268.** Specify location **E1, E2 or E3. Add \$91.**

EXAMPLES OF POWER BLOCK POSITIONS

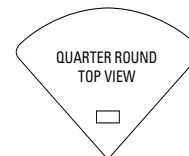
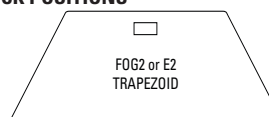
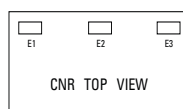

MODPOWER DAISY-CHAIN SOLUTION

- Add flexible power and USB charging to ConnecTables rectangular tables. Connect up to four units with a single corded infeed with NEMA plug.
- ModPower units are sold separately, refer to Productivity Solutions page 473.
- Begin run with a starter unit which includes a corded infeed. Add additional middle or end units as required. Middle and end units are equipped with connecting cables.
- On-surface modules clamp on or screw mount to the table tops.
- In-surface modules require table top cut-outs for mounting (cannot be used with modesties):
 - Specify cut-out option **MPS** for a single cut-out to accommodate one ModPower in-surface unit (cut-out will be centered on the approach side) for **30" to 72" wide rectangular tables. Add \$91.**
 - Specify cut-out option **MPD** for two cut-outs in the left and right positions, 15" from ends to center of unit on approach side for **60", 66" and 72" wide rectangular tables. Add \$183.**

SPECIFICATIONS

- Specifications marked with an * are applicable to only those products which have the * symbol beside the product name.

TOP & EDGE OPTIONS

- ConnectTABLES have nine basic top shapes available in various sizes. All top shapes have a variety of straight or curved edges which are referred to as **Working (W)**, **Connecting (C) or End (E) edges**. Edges can also have a combination of edge types as shown.

*cannot freestand

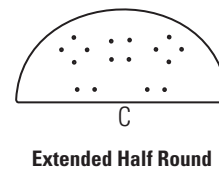
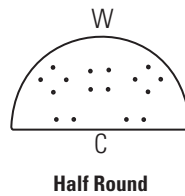
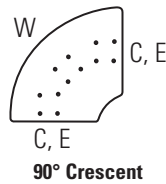
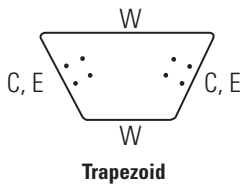
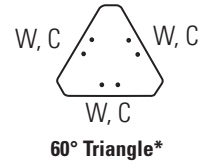
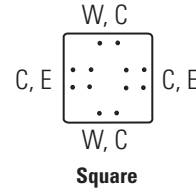
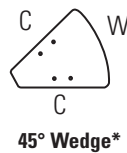
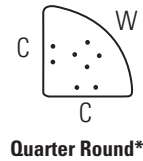
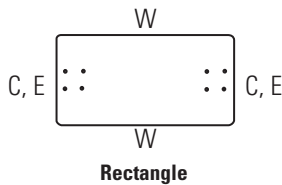

Working edge (1) - Edges designated with the letter "W" indicate that this is a **working** or sitting edge. These edges can be connected with optional ganging hardware in freestanding applications.

Connecting edge (2) - Edges designated with the letter "C" indicate that this is a **connecting** edge. These edges can be connected to any other connecting edge of equal width, regardless of the top shape or size.

End edge (3) - Edges designated with the letter "E" indicate that this is an **end** edge or an edge that can finish a run of tops. If a top has two end edges it can be freestanding. 90° crescent tops can be freestanding if the optional center leg is added.

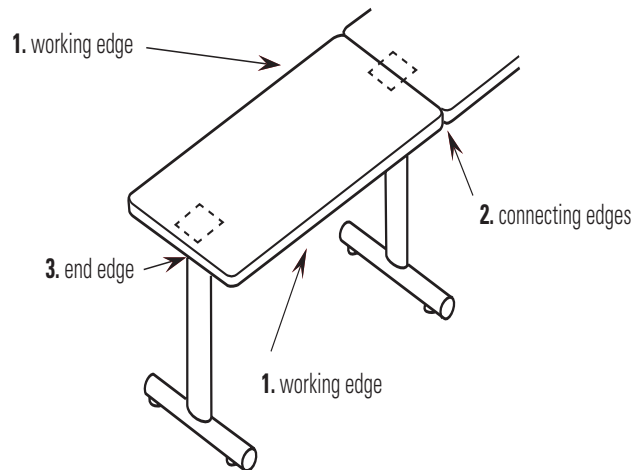

FREESTANDING AND CONNECTING CONDITIONS

Freestanding tables are defined as any one worksurface supported by two or more legs; **connecting tables** are defined as more than one worksurface supported by a single leg at each point of connection. The rule to determine the quantity of legs of an open configuration is the number of worksurfaces plus one (See Figure 1).

On closed configurations, the number of legs is equal to the number of worksurfaces (See Figure 2). There are some exceptions, such as when optional third legs are used on quarter round or 90° crescent shapes.

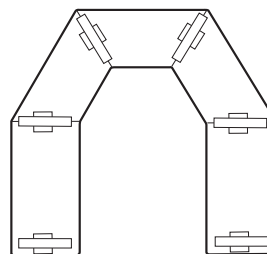

Figure 1.
Open Configuration
Number of surfaces = 5
Number of legs = 6

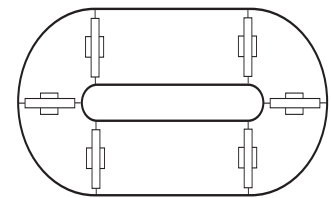

Figure 2.
Closed Configuration
Number of surfaces = 6
Number of legs = 6

C CONNECTABLES® - NOTES

FREESTANDING CONDITIONS

- All square, rectangle and trapezoid shapes are able to act as freestanding tables (**Figure 3**).
- When trapezoid tops are freestanding, legs must be on the outer left and right sides (**Figure 4**).
- 90° crescent worksurfaces have provision for an optional third center leg for additional stability when heavy loads are applied to the outside edge. They can also be used as freestanding tables when a third leg is added (**Figure 5**).
- All freestanding tables can be connected with optional ganging hardware.
- Freestanding tables can be ganged with connected tables in some cases, providing that the number and size of connected tables is easily movable (**Figure 6**).

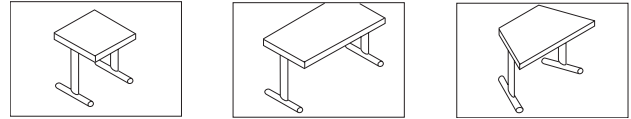
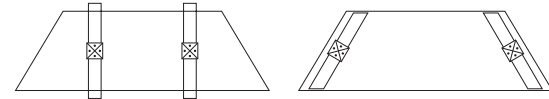

Figure 3 - Freestanding Tables



Incorrect Correct
Figure 4 - Trapezoid Tops

• DO NOT DRAG TABLES WHEN RE-CONFIGURING.

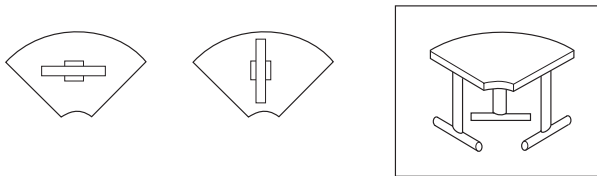

Figure 5 - Adding a Third Leg

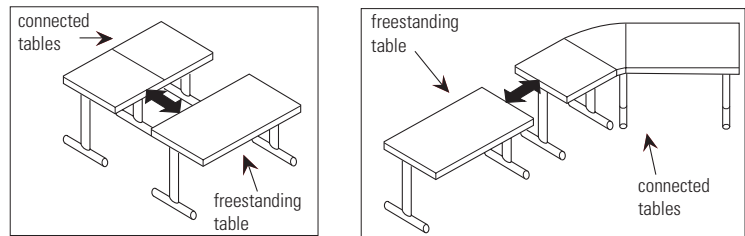

Figure 6 - Ganging with Connected Tables

CONNECTING CONDITIONS

- Any two worksurfaces of equal depth (24"D, 30"D or 36"D) can be connected with one leg, at the connecting or end edges (**Figure 8**).
- Half round worksurfaces can be used in the following ways: They must be of equal width when connected to each other (**Figure 7**) or the connecting shapes must be equal to half the width of the connecting half round (**Figure 8**).
- ConnectABLES is designed with the leg to be fastened parallel to connecting edges, but in some cases you may wish to fasten legs at 90° to connecting edges. This could allow for increased leg or knee clearance, depending on the intended use (**Figure 9**).
- Quarter round and 90° crescent worksurfaces have provision for an optional third leg for additional stability when heavy loads are applied to the outside edge. For quarter round worksurfaces, it is recommended that configuration "A" be used since the outside end of the center leg in configuration "B" is almost flush with the outside edge of the worksurface. If configuration "B" is installed against a wall or where there will be no traffic flow, then configuration "B" can be used.

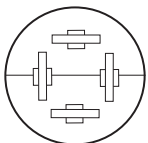

Figure 7

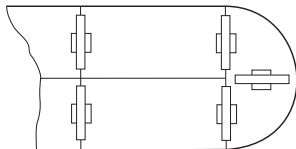

Figure 8

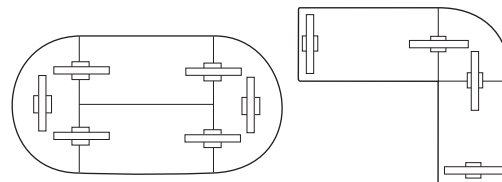
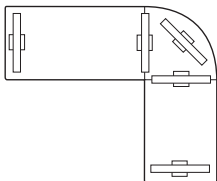
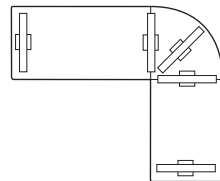

Figure 9 - 90° Leg Connections



Configuration A



Configuration B

Legs are fastened to worksurfaces utilizing a steel-to-steel connection. Each leg comes equipped with four 0.25" x 0.875" screws. machine screws. Screws are inserted through the four oval shaped holes only. **Do not use wood screws.** When fastening legs to worksurfaces, hand thread screws into position to prevent any cross threading. When all screws have been hand threaded, tighten firmly with screwdriver to secure. Optional thumbscrews can be used in place of machine screws. Thumbscrews eliminate the need for a screwdriver, whether assembling or disassembling tables. **Do not use power tools for assembly of legs.**

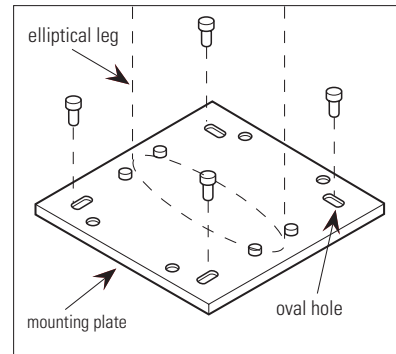

FREESTANDING TABLES

1. Turn worksurface upside-down on clean floor. (You may want to use carton from packaging as a protective assembly surface to protect the top from scratching.)
2. Position leg mounting plate holes over threaded steel inserts in top.
3. Fasten each leg to top with four 0.25" x 0.875" screws.
4. Turn table right-side up.
5. Level table by adjusting glides.

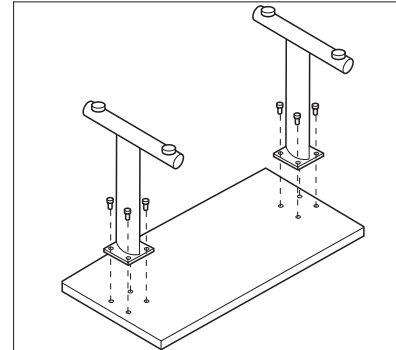

CONNECTING TABLES

1. Determine approximate location of desired configuration in room and turn worksurfaces upside down on floor. (Remember you are working in reverse.)
2. Position leg mounting plate so it is centered over the connecting edge of the first worksurface. Fasten leg with two 0.25" x 0.875" screws.
3. Repeat step 2 and 3 on the opposite edge of the first worksurface.
4. Turn table right side up.
5. Turn table right side up and fasten to the previous top from the underside.
6. To add additional worksurfaces repeat step 5.
7. When all the tops have been connected, level complete configuration by adjusting glides.

Note: Use the same procedures as above when using optional thumb screws.

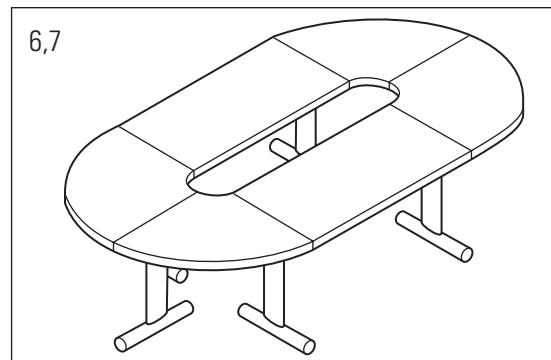
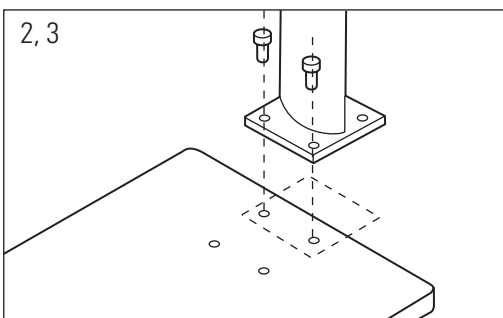
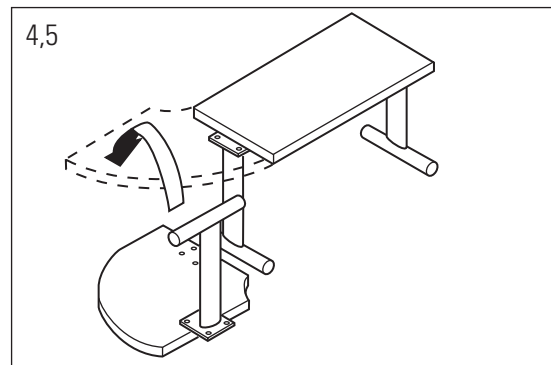
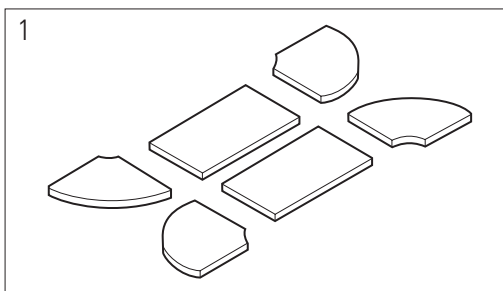

C CONNECTABLES® - PUTTING IT ALL TOGETHER

OPTIONAL CASTERS

1. Turn worksurface upside down on floor.
2. Remove existing glide if previously installed.
3. Fasten caster to T-leg by threading caster stem into base of T-leg and secure by tightening lock nut.
4. If casters are used in combination with glides, level table by adjusting glides.

Note: Casters are available in locking or non-locking styles.

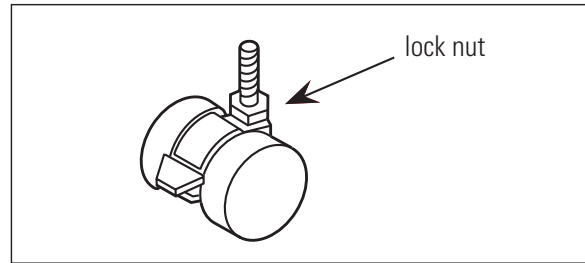

OPTIONAL GANGING HARDWARE

1. Optional ganging hardware should be used when quick and frequent reconfigurations are required.
2. Turn worksurfaces to be ganged upside-down on floor.
3. Remove ganging hardware from package. Holes with steel inserts are located in the corner of tops.
4. Fasten ganging hardware to each worksurface with supplied thumb screws.
5. Projected arm from ganging hardware can pivot out of the way when not in use.

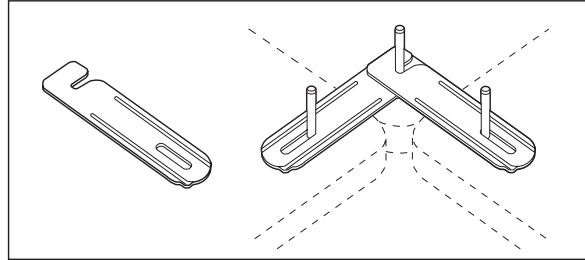

SQUARE TOPS **MODEL #** **DIMENSIONS** **WT/LB.** **CUBIC FT.** **LIST PRICE**

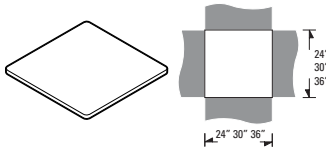

Square Top

	W x D x H			
CNS2424	24 x 24 x 1	18	1	\$266
CNS3030	30 x 30 x 1	27	1.56	\$324
CNS3636	36 x 36 x 1	39	2	\$330

T-mold edging. Predrilled with threaded steel inserts for freestanding and linking installations.

RECTANGULAR TOPS

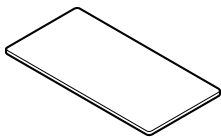
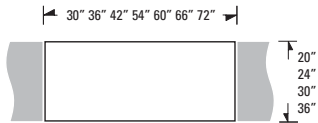

Rectangle Top

CNR2030	30 x 20 x 1	22	1.25	\$183
CNR2036	20 x 36 x 1	22.5	0.46	\$198
CNR2042	42 x 20 x 1	31	1.75	\$224
CNR2048	48 x 20 x 1	35	2	\$244
CNRU2054	54 x 20 x 1	33.75	0.69	\$323
CNRU2060	60 x 20 x 1	37.5	1.4	\$343
CNRU2066	66 x 20 x 1	41.25	0.84	\$376
CNRU2072	72 x 20 x 1	45	1	\$397
CNR2430	30 x 24 x 1	22	1.25	\$193
CNR2436	36 x 24 x 1	26	1.5	\$211
CNR2442	42 x 24 x 1	31	1.75	\$234
CNR2448	48 x 24 x 1	35	2	\$255
CNRU2454	54 x 24 x 1	42	2.34	\$338
CNRU2460	60 x 24 x 1	47	2.5	\$358
CNRU2466	66 x 24 x 1	52	2.8	\$390
CNRU2472	72 x 24 x 1	57	3	\$415
CNR3036	36 x 30 x 1	33	1.88	\$255
CNR3042	42 x 30 x 1	38	2.19	\$279
CNR3048	48 x 30 x 1	44	2.5	\$302
CNRU3054	54 x 30 x 1	52	2.8	\$387
CNRU3060	60 x 30 x 1	59	3.13	\$411
CNRU3066	66 x 30 x 1	64	3.44	\$439
CNRU3072	72 x 30 x 1	70	3.75	\$466
CNR3642	42 x 36 x 1	52.5	1.6	\$354
CNR3648	48 x 36 x 1	60	1.8	\$387
CNRU3654	54 x 36 x 1	70	2	\$495
CNRU3660	60 x 36 x 1	78	2.2	\$538
CNRU3666	66 x 36 x 1	87	2.4	\$592
CNRU3672	72 x 36 x 1	94	2.6	\$647

T-mold edging. Predrilled with threaded steel inserts for freestanding and linking installations. **Tops 54" and longer are standard with a 16 gauge steel support channel.**

TRAPEZOID TOPS

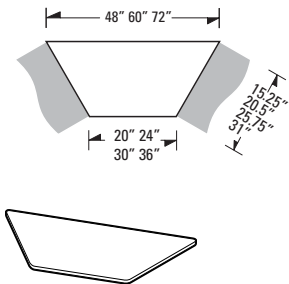

Trapezoid Top

CNT2048	48 x 17.5 x 1	26.25	0.55	\$252
CNT2060	60 x 17.5 x 1	44	1.85	\$307
CNT2448	48 x 20.5 x 1	21	2	\$268
CNT2460	60 x 20.5 x 1	44	1.85	\$324
CNT3060	60 x 25.75 x 1	35	3.13	\$353
CNT3072	72 x 25.75 x 1	66	2.2	\$397
CNT3660	60 x 31 x 1	66	2.2	\$482
CNT3672	72 x 31 x 1	79.2	3.5	\$578

T-mold edging. Predrilled with threaded steel inserts for freestanding and linking installations.

Required specifications

Top finish
Edge finish

Optional specifications

Grommet

Accessories

Power block

C CONNECTABLES®

90° CRESCENT TOPS

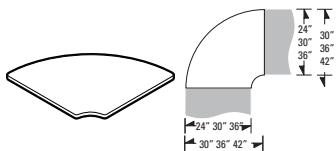

90° Crescent Top*

MODEL #	DIMENSIONS	WT/LB.	CUBIC FT.	LIST PRICE
W x D x H				
CNC2430	30 x 30 x 1	20	1.56	\$280
CNC3036	36 x 36 x 1	30	2.25	\$403
CNC3642	42 x 42 x 1	50	3.15	\$556

T-mold edging. Predrilled with threaded steel inserts for freestanding and linking installations.

- **CNC2430** for use with 24" deep tops.
- **CNC3036** for use with 30" deep tops.
- **CNC3642** for use with 36" deep tops.
- **CNC2430** does not require a center leg.

QUARTER ROUND TOPS

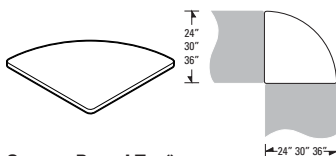

Quarter Round Top*

CNQ2424	24 x 24 x 1	14	1	\$172
CNQ3030	30 x 30 x 1	21	1.56	\$213
CNQ3636	36 x 36 x 1	45	1.3	\$351

T-mold edging. Predrilled with threaded steel inserts for **linking installations only**.

45° WEDGE TOPS

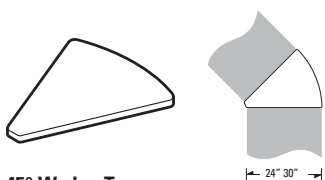

45° Wedge Top

CNW2424	24 x 24 x 1	10	1	\$190
CNW3030	30 x 30 x 1	14	1.56	\$231

T-mold edging. Predrilled with threaded steel inserts for **linking installations only**.

THREE WAY CONNECTOR TOPS

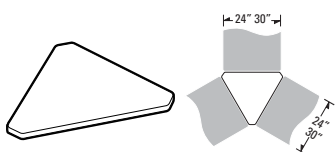

Three Way Connector Top

CNY2424	24 x 24 x 1	13	1	\$172
CNY3030	30 x 30 x 1	18	1.56	\$210

T-mold edging. Predrilled with threaded steel inserts for **linking installations only**.

HALF ROUND TOPS

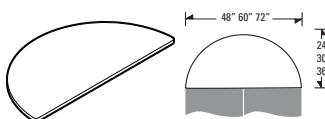

Half Round Top*

CNHFS2448	48 x 24 x 1	36	2	\$274
CNHFS3060	60 x 30 x 1	56	3.13	\$360
CNHFS3672	72 x 36 x 1	81	3.3	\$624

T-mold edging. Predrilled with threaded steel inserts for freestanding and linking installations.

- *Requires three legs for freestanding.*

EXTENDED HALF ROUND TOPS

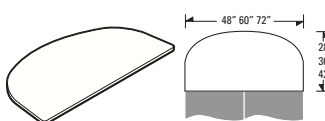

Extended Half Round Top

CNHE24	48 x 28 x 1	50	1.88	\$311
CNHE30	60 x 36 x 1	75	2.87	\$442
CNHE36	72 x 42 x 1	102	3.88	\$706

T-mold edging. Predrilled with threaded steel inserts for **linking installations ONLY**.

Required specifications

Top finish
Edge finish

Optional specifications

Grommet*

Accessories

Power block

MODESTY PANELS **MODEL #** **DIMENSIONS** **WT/LB.** **CUBIC FT.** **LIST PRICE**

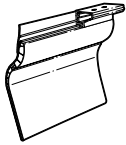

Modesty Panel

	W x D x H				
CNCA2430	35 x 2.75 x 11.75	2.8	0.5		\$145
CNCA3036	43 x 2.75 x 11.75	3.3	0.6		\$172
CNCA3642	53 x 2.75 x 11.75	3.9	0.7		\$230

For use with **CNC crescent tops**. 11.75" high, Black plastic, attractive ribbed design. Includes two fold-away installation clips and flexible privacy strips. Connects to predrilled holes in table top.

- *Cannot be used when worksurface tops are attached to flip-top legs.*

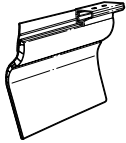

Modesty Panel

CNQA2424	27 x 2.75 x 11.75	2.2	0.4		\$123
CNQA3030	35 x 2.75 x 11.75	2.8	0.5		\$145
CNQA3636	44 x 2.75 x 11.75	3.3	0.6		\$172

For use with **CNQ quarter round tops**. 11.75" high, Black plastic, attractive ribbed design. Includes two fold-away installation clips and flexible privacy strips. Connects to predrilled holes in table top.

- *Cannot be used when worksurface tops are attached to flip-top legs.*

CNRA2030	29.5 x 3 x 10.5	2.5	0.54		\$123
CNRA2036	35.5 x 3 x 10.5	2.65	0.65		\$145
CNRA2042	41.5 x 3 x 10.5	2.9	0.76		\$172
CNRA2048	47.5 x 3 x 10.5	3.1	0.86		\$196
CNRA2054	53.5 x 3 x 10.5	3.25	0.98		\$230
CNRA2060	59.5 x 3 x 10.5	3.4	1.1		\$245
CNRA2066	65.5 x 3 x 10.5	3.6	1.2		\$270
CNRA2072	71.5 x 3 x 10.5	3.8	1.3		\$299

CNRA2430	29 x 2.75 x 11.75	2.8	0.5		\$123
CNRA2436	35 x 2.75 x 11.75	3.3	0.6		\$145
CNRA2442	41 x 2.75 x 11.75	3.9	0.7		\$172
CNRA2448	47 x 2.75 x 11.75	4.4	0.8		\$196
CNRA2454	53 x 2.75 x 11.75	5	0.9		\$230
CNRA2460	59 x 2.75 x 11.75	5.5	1		\$245
CNRA2466	65 x 2.75 x 11.75	6.1	1.1		\$270
CNRA2472	71 x 2.75 x 11.75	6.6	1.2		\$299

CNRA3036	35 x 2.75 x 11.75	3.3	0.6		\$145
CNRA3042	41 x 2.75 x 11.75	3.9	0.7		\$172
CNRA3048	47 x 2.75 x 11.75	4.4	0.8		\$196
CNRA3054	53 x 2.75 x 11.75	5	0.9		\$230
CNRA3060	59 x 2.75 x 11.75	5.5	1		\$245
CNRA3066	65 x 2.75 x 11.75	6.1	1.1		\$270
CNRA3072	71 x 2.75 x 11.75	6.6	1.2		\$299

CNRA3642	41 x 2.75 x 11.75	3.9	0.7		\$172
CNRA3648	47 x 2.75 x 11.75	4.4	0.8		\$196
CNRA3654	53 x 2.75 x 11.75	5	0.9		\$230
CNRA3660	59 x 2.75 x 11.75	5.5	1		\$245
CNRA3666	65 x 2.75 x 11.75	6.1	1.1		\$270
CNRA3672	71 x 2.75 x 11.75	6.6	1.2		\$299

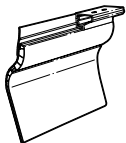

Modesty Panel

For use with **CNR/CNRU rectangular tops**. 11.75" high, Black plastic, attractive ribbed design. Includes two fold-away installation clips and flexible privacy strips. Connects to predrilled holes in table top.

- *Cannot be used when worksurface tops are attached to flip-top legs.*

MODESTY PANELS

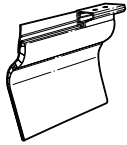

Modesty Panel

MODEL #	DIMENSIONS W x D x H	WT/LB.	CUBIC FT.	LIST PRICE
CNSA2424	23 x 2.75 x 11.75	2.2	0.4	\$96
CNSA3030	29 x 2.75 x 11.75	2.8	0.5	\$123
CNSA3636	35 x 2.75 x 11.75	3.3	0.6	\$145

For use with **long side of CNS square tops**. 11.75" high, Black plastic, attractive ribbed design. Includes two fold-away installation clips and flexible privacy strips. Connects to predrilled holes in table top.

- *Cannot be used when worksurface tops are attached to flip-top legs.*

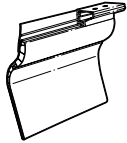

Modesty Panel

CNTA2448L	43 x 2.75 x 11.75	4.4	0.8	\$172
CNTA2460L	55 x 2.75 x 11.75	5.5	1.2	\$230
CNTA3060L	55 x 2.75 x 11.75	5.5	1.2	\$230
CNTA3072L	67 x 2.75 x 11.75	6.6	1.4	\$270
CNTA3660L	55 x 2.75 x 11.75	5.5	1.2	\$230
CNTA3672L	67 x 2.75 x 11.75	6.6	1.4	\$270

For use with **long side of CNT trapezoid tops**. 11.75" high, Black plastic, attractive ribbed design. Includes two fold-away installation clips and flexible privacy strips. Connects to predrilled holes in table top.

- *Cannot be used when worksurface tops are attached to flip-top legs.*

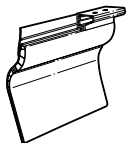

Modesty Panel

CNTA2448S	23 x 2.75 x 11.75	2.2	0.4	\$96
CNTA2460S	35 x 2.75 x 11.75	2.2	0.4	\$145
CNTA3060S	29 x 2.75 x 11.75	2.8	0.5	\$123
CNTA3072S	41 x 2.75 x 11.75	2.8	0.5	\$172
CNTA3660S	23 x 2.75 x 11.75	3.3	0.6	\$96
CNTA3672S	35 x 2.75 x 11.75	3.3	0.6	\$145

For use with **short side of CNT trapezoid tops**. 11.75" high, Black plastic, attractive ribbed design. Includes two fold-away installation clips and flexible privacy strips. Connects to predrilled holes in table top.

- *Cannot be used when worksurface tops are attached to flip-top legs.*

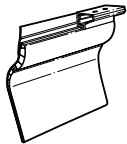

Modesty Panel

CNWA2424	17 x 2.75 x 11.75	2.2	0.4	\$75
CNWA3030	22 x 2.75 x 11.75	2.8	0.5	\$96

For use with **CNW wedge tops**. 11.75" high, Black plastic, attractive ribbed design. Includes two fold-away installation clips and flexible privacy strips. Connects to predrilled holes in table top.

- *Cannot be used when worksurface tops are attached to flip-top legs.*

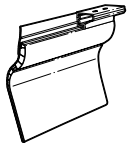

Modesty Panel

CNYA2424	22 x 2.75 x 11.75	2.2	0.4	\$96
CNYA3030	27 x 2.75 x 11.75	2.8	0.5	\$123

For use with **CNY triangle tops**. 11.75" high, Black plastic, attractive ribbed design. Includes two fold-away installation clips and flexible privacy strips. Connects to predrilled holes in table top.

- *Cannot be used when worksurface tops are attached to flip-top legs.*

WIRE MANAGEMENT UNITS

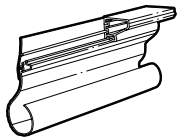

Wire Management Unit

MODEL #	DIMENSIONS	WT/LB.	CUBIC FT.	LIST PRICE
	W x D x H			
CNCB2430	35 x 2.75 x 6	1.5	0.5	\$108
CNCB3036	43 x 2.75 x 6	1.8	0.6	\$120
CNCB3642	53 x 2.75 x 6	2.1	0.7	\$161

For use with **CNC crescent tops**. 6" high, Black plastic, attractive ribbed design. Includes two fold-away installation clips and flexible privacy strips. Connects to predrilled holes in table top. Can be used with or without wire management grommet.

- *Cannot be used when worksurface tops are attached to flip-top legs.*

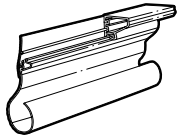

Wire Management Unit

CNOB2424	27 x 2.75 x 6	1.2	0.4	\$88
CNOB3030	35 x 2.75 x 6	1.5	0.5	\$108
CNOB3636	44 x 2.75 x 6	1.8	0.6	\$120

For use with **CNO quarter round tops**. 6" high, Black plastic, attractive ribbed design. Includes two fold-away installation clips and flexible privacy strips. Connects to predrilled holes in table top. Can be used with or without wire management grommet.

- *Cannot be used when worksurface tops are attached to flip-top legs.*

CNRB2430	29 x 2.75 x 6	1.5	0.5	\$88
CNRB2436	35 x 2.75 x 6	1.8	0.6	\$108
CNRB2442	41 x 2.75 x 6	2.1	0.7	\$120
CNRB2448	47 x 2.75 x 6	2.4	0.8	\$142
CNRB2454	53 x 2.75 x 6	2.7	0.9	\$161
CNRB2460	59 x 2.75 x 6	3	1	\$177
CNRB2466	65 x 2.75 x 6	3.3	1.1	\$177
CNRB2472	71 x 2.75 x 6	3.6	1.2	\$245

CNRB3036	35 x 2.75 x 6	1.8	0.6	\$108
CNRB3042	41 x 2.75 x 6	2.1	0.7	\$120
CNRB3048	47 x 2.75 x 6	2.4	0.8	\$142
CNRB3054	53 x 2.75 x 6	2.7	0.9	\$161
CNRB3060	59 x 2.75 x 6	3	1	\$177
CNRB3066	65 x 2.75 x 6	3.3	1.1	\$177
CNRB3072	71 x 2.75 x 6	3.6	1.2	\$245

CNRB3642	41 x 2.75 x 6	2.1	0.7	\$120
CNRB3648	47 x 2.75 x 6	2.4	0.8	\$142
CNRB3654	53 x 2.75 x 6	2.7	0.9	\$161
CNRB3660	59 x 2.75 x 6	3	1	\$177
CNRB3666	65 x 2.75 x 6	3.3	1.1	\$177
CNRB3672	71 x 2.75 x 6	3.6	1.2	\$245

For use with **CNR/CNRU rectangular tops**. 6" high, Black plastic, attractive ribbed design. Includes two fold-away installation clips and flexible privacy strips. Connects to predrilled holes in table top. Can be used with or without wire management grommet.

- *Cannot be used when worksurface tops are attached to flip-top legs.*

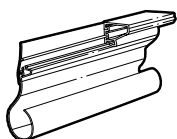

Wire Management Unit

C CONNECTABLES®

WIRE MANAGEMENT UNITS

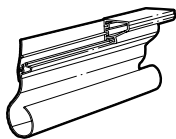

Wire Management Unit

MODEL #	DIMENSIONS W x D x H	WT/LB.	CUBIC FT.	LIST PRICE
CNSB2424	23 x 2.75 x 6	1.8	0.4	\$72
CNSB3030	29 x 2.75 x 6	1.5	0.5	\$88
CNSB3636	35 x 2.75 x 6	1.8	0.6	\$108

For use with **CNS square tops**. 6" high, Black plastic, attractive ribbed design. Includes two fold-away installation clips and flexible privacy strips. Connects to predrilled holes in table top. Can be used with or without wire management grommet.

- *Cannot be used when worksurface tops are attached to flip-top legs.*

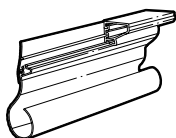

Wire Management Unit

CNTB2448L	43 x 2.75 x 6	2.4	0.8	\$120
CNTB2460L	55 x 2.75 x 6	3	1	\$161
CNTB3060L	55 x 2.75 x 6	3	1	\$161
CNTB3072L	67 x 2.75 x 6	3.6	1.2	\$230
CNTB3660L	55 x 2.75 x 6	3	1	\$161
CNTB3672L	67 x 2.75 x 6	3.6	1.2	\$230

For use with **long side of CNT trapezoid tops**. 6" high, Black plastic, attractive ribbed design. Includes two fold-away installation clips and flexible privacy strips. Connects to predrilled holes in table top. Can be used with or without wire management grommet.

- *Cannot be used when worksurface tops are attached to flip-top legs.*

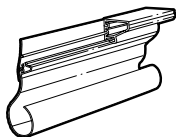

Wire Management Unit

CNTB2448S	23 x 2.75 x 6	1.2	0.4	\$72
CNTB2460S	35 x 2.75 x 6	1.2	0.4	\$108
CNTB3060S	29 x 2.75 x 6	1.5	0.5	\$88
CNTB3072S	41 x 2.75 x 6	1.5	0.5	\$120
CNTB3660S	23 x 2.75 x 6	1.8	0.6	\$72
CNTB3672S	35 x 2.75 x 6	1.8	0.6	\$108

For use with **short side of CNT trapezoid tops**. 6" high, Black plastic, attractive ribbed design. Includes two fold-away installation clips and flexible privacy strips. Connects to predrilled holes in table top. Can be used with or without wire management grommet.

- *Cannot be used when worksurface tops are attached to flip-top legs.*

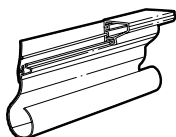

Wire Management Unit

CNWB2424	17 x 2.75 x 6	1.2	0.4	\$57
CNWB3030	22 x 2.75 x 6	1.5	0.5	\$72

For use with **CNW wedge tops**. 6" high, Black plastic, attractive ribbed design. Includes two fold-away installation clips and flexible privacy strips. Connects to predrilled holes in table top. Can be used with or without wire management grommet.

- *Cannot be used when worksurface tops are attached to flip-top legs.*

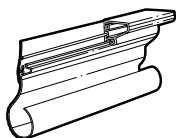

Wire Management Unit

CNYB2424	22 x 2.75 x 6	1.2	0.4	\$72
CNYB3030	27 x 2.75 x 6	1.5	0.5	\$88

For use with **CNY triangle tops**. 6" high, Black plastic, attractive ribbed design. Includes two fold-away installation clips and flexible privacy strips. Connects to predrilled holes in table top. Can be used with or without wire management grommet.

- *Cannot be used when worksurface tops are attached to flip-top legs.*

MODESTY PANELS W/WIRE MANAGEMENT MODEL # DIMENSIONS WT/LB. CUBIC FT. LIST PRICE

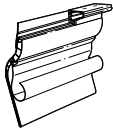

Modesty Panel w/Wire Management

	W x D x H			
CNCC2430	35 x 2.75 x 11.75	4.3	0.5	\$161
CNCC3036	43 x 2.75 x 11.75	5.1	0.6	\$184
CNCC3642	53 x 2.75 x 11.75	6	0.7	\$238

For use with **CNC crescent tops**. 11.75" high, Black plastic, attractive ribbed design. Includes two fold-away installation clips and flexible privacy strips. Connects to predrilled holes in table top. Can be used with or without wire management grommet.

- *Cannot be used when worksurface tops are attached to flip-top legs.*

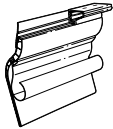

Modesty Panel w/ Wire Management

CNQC2424	27 x 2.75 x 11.75	3.4	0.4	\$133
CNQC3030	35 x 2.75 x 11.75	4.3	0.5	\$161
CNQC3636	44 x 2.75 x 11.75	5.1	0.6	\$184

For use with **CNC quarter round tops**. 11.75" high, Black plastic, attractive ribbed design. Includes two fold-away installation clips and flexible privacy strips. Connects to predrilled holes in table top. Can be used with or without wire management grommet.

- *Cannot be used when worksurface tops are attached to flip-top legs.*

CNRC2030	29.5 x 3 x 10.5	3.75	0.54	\$133
CNRC2036	35.5 x 3 x 10.5	4	0.65	\$161
CNRC2042	41.5 x 3 x 10.5	4.25	0.76	\$184
CNRC2048	47.5 x 3 x 10.5	4.5	0.86	\$213
CNRC2054	53.5 x 3 x 10.5	7.7	0.9	\$238
CNRC2060	59.5 x 3 x 10.5	8.5	1	\$268
CNRC2066	65.5 x 3 x 10.5	5.25	1.2	\$291
CNRC2072	71.5 x 3 x 10.5	5.5	1.3	\$307

CNRC2430	29 x 2.75 x 11.75	4.3	0.5	\$133
CNRC2436	35 x 2.75 x 11.75	5.1	0.6	\$161
CNRC2442	41 x 2.75 x 11.75	6	0.7	\$184
CNRC2448	47 x 2.75 x 11.75	6.8	0.8	\$213
CNRC2454	53 x 2.75 x 11.75	7.7	0.9	\$238
CNRC2460	59 x 2.75 x 11.75	8.5	1	\$268
CNRC2466	65 x 2.75 x 11.75	9.4	1.1	\$291
CNRC2472	71 x 2.75 x 11.75	10.2	1.2	\$307

CNRC3036	35 x 2.75 x 11.75	5.1	0.6	\$161
CNRC3042	41 x 2.75 x 11.75	6	0.7	\$184
CNRC3048	47 x 2.75 x 11.75	6.8	0.8	\$213
CNRC3054	53 x 2.75 x 11.75	7.7	0.9	\$238
CNRC3060	59 x 2.75 x 11.75	8.5	1	\$268
CNRC3066	65 x 2.75 x 11.75	9.4	1.1	\$291
CNRC3072	71 x 2.75 x 11.75	10.2	1.2	\$307

CNRC3642	41 x 2.75 x 11.75	6	0.7	\$184
CNRC3648	47 x 2.75 x 11.75	6.8	0.8	\$213
CNRC3654	53 x 2.75 x 11.75	7.7	0.9	\$238
CNRC3660	59 x 2.75 x 11.75	8.5	1	\$268
CNRC3666	65 x 2.75 x 11.75	9.4	1.1	\$291
CNRC3672	71 x 2.75 x 11.75	10.2	1.2	\$307

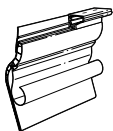

Modesty Panel w/Wire Management

For use with **CNR/CNRU rectangular tops**. 11.75" high, Black plastic, attractive ribbed design. Includes two fold-away installation clips and flexible privacy strips. Connects to predrilled holes in table top. Can be used with or without wire management grommet.

- *Cannot be used when worksurface tops are attached to flip-top legs.*

C CONNECTABLES®

MODESTY PANEL w/WIRE MANAGEMENT

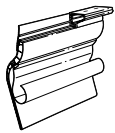

Modesty Panel w/Wire Management

MODEL #	DIMENSIONS W x D x H	WT/LB.	CUBIC FT.	LIST PRICE
CNSC2424	23 x 2.75 x 11.75	3.5	0.4	\$108
CNSC3030	29 x 2.75 x 11.75	4.3	0.5	\$133
CNSC3636	35 x 2.75 x 11.75	5.1	0.6	\$161

For use with **CNC square tops**. 11.75" high, Black plastic, attractive ribbed design. Includes two fold-away installation clips and flexible privacy strips. Connects to predrilled holes in table top. Can be used with or without wire management grommet.

- *Cannot be used when worksurface tops are attached to flip-top legs.*

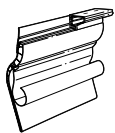

Modesty Panel w/Wire Management

CNTC2048L	43 x 2.75 x 11.75	6.8	0.8	\$184
CNTC2060L	55 x 2.75 x 11.75	8.5	1	\$238
CNTC2448L	43 x 2.75 x 11.75	6.8	0.8	\$184
CNTC2460L	55 x 2.75 x 11.75	8.5	1	\$238
CNTC3060L	55 x 2.75 x 11.75	8.5	1	\$238
CNTC3072L	67 x 2.75 x 11.75	10.2	1.2	\$291
CNTC3660L	55 x 2.75 x 11.75	8.5	1	\$238
CNTC3672L	67 x 2.75 x 11.75	10.2	1.2	\$291

For use with **long side of CNT trapezoid tops**. 11.75" high, Black plastic, attractive ribbed design. Includes two fold-away installation clips and flexible privacy strips. Connects to predrilled holes in table top. Can be used with or without wire management grommet.

- *Cannot be used when worksurface tops are attached to flip-top legs.*

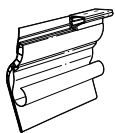

Modesty Panel w/Wire Management

CNTC2048S	23 x 2.75 x 11.75	3.4	0.4	\$108
CNTC2060S	35 x 2.75 x 11.75	3.5	0.5	\$161
CNTC2448S	23 x 2.75 x 11.75	3.4	0.4	\$108
CNTC2460S	35 x 2.75 x 11.75	3.4	0.4	\$161
CNTC3060S	29 x 2.75 x 11.75	4.3	0.5	\$133
CNTC3072S	41 x 2.75 x 11.75	4.3	0.5	\$184
CNTC3660S	23 x 2.75 x 11.75	5.1	0.6	\$108
CNTC3672S	35 x 2.75 x 11.75	5.1	0.6	\$161

For use with **short side of CNT trapezoid tops**. 11.75" high, Black plastic, attractive ribbed design. Includes two fold-away installation clips and flexible privacy strips. Connects to predrilled holes in table top. Can be used with or without wire management grommet.

- *Cannot be used when worksurface tops are attached to flip-top legs.*

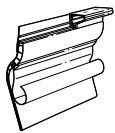

Modesty Panel w/Wire Management

CNWC2424	17 x 2.75 x 11.75	3.4	0.4	\$84
CNWC3030	22 x 2.75 x 11.75	4.3	0.5	\$108

For use with **CNW wedge tops**. 11.75" high, Black plastic, attractive ribbed design. Includes two fold-away installation clips and flexible privacy strips. Connects to predrilled holes in table top. Can be used with or without wire management grommet.

- *Cannot be used when worksurface tops are attached to flip-top legs.*

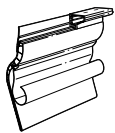



Modesty Panel w/Wire Management

CNYC2424	22 x 2.75 x 11.75	3.4	0.4	\$108
CNYC3030	27 x 2.75 x 11.75	4.3	0.5	\$133

For use with **CNY triangle tops**. 11.75" high, Black plastic, attractive ribbed design. Includes two fold-away installation clips and flexible privacy strips. Connects to predrilled holes in table top. Can be used with or without wire management grommet.

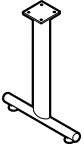
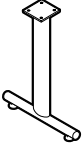
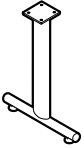
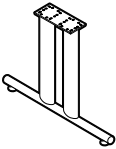
- *Cannot be used when worksurface tops are attached to flip-top legs.*

T-LEGS	MODEL #	DIMENSIONS W x D x H	WT/LB.	CUBIC FT.	LIST PRICE
 T-leg	CNTLEG18	18 x 1.75 x 27.8	9	2.1	\$176
	CNTLEG18P	18 x 1.75 x 27.8	13	2.4	\$354
<p>18" long with plastic elliptical column cover, leveling glides and end caps. For assembly with 20" tops.</p> <ul style="list-style-type: none"> • For a single leg, order CNTLEG18. For a pair of legs (set of 2), order CNTLEG18P. • Chrome (CHM) is available (on foot only). Add \$74 list for model CNTLEG18. Add \$148 list for model CNTLEG18P. • Depth dimension reflects the T-leg bottom tube diameter. 					
 T-leg	CNTLEG24	20 x 1.75 x 27.8	9	2.1	\$176
	CNTLEG24P	20 x 1.75 x 27.8	17	2.4	\$354
<p>20" long with plastic elliptical column cover, leveling glides and end caps. For assembly with 24" tops.</p> <ul style="list-style-type: none"> • For a single leg, order CNTLEG24. For a pair of legs (set of 2), order CNTLEG24P. • Chrome (CHM) is available (on foot only). Add \$74 list for model CNTLEG24. Add \$148 list for model CNTLEG24P. • Depth dimension reflects the T-leg bottom tube diameter. 					
 T-leg	CNTLEG30	26 x 1.75 x 27.8	10	2.6	\$195
	CNTLEG30P	26 x 1.75 x 27.8	19	3	\$388
<p>26" long with plastic elliptical column cover, leveling glides and end caps. For assembly with 30" tops.</p> <ul style="list-style-type: none"> • For a single leg, order CNTLEG30. For a pair of legs (set of 2), order CNTLEG30P. • Chrome (CHM) is available (on foot only). Add \$74 list for model CNTLEG30. Add \$148 list for model CNTLEG30P. • Depth dimension reflects the T-leg bottom tube diameter. 					
 Dual Post T-leg	CNTLEG36	32 x 1.75 x 27.8	14	3.3	\$376
<p>32" long with double post plastic elliptical column cover, leveling glides and end caps. For assembly with 36" tops.</p> <ul style="list-style-type: none"> • For a single leg. • Chrome (CHM) is available (on foot only). Add \$74 list. • Depth dimension reflects the T-leg bottom tube diameter. 					
 Flip-Top T-leg*	CNTFLEG24	20 x 1.75 x 28	10	2.4	\$311
	CNTFLG24P	20 x 1.75 x 28	20	2.1	\$621
<p>20" long with plastic elliptical column cover, leveling glides and end caps. For assembly with 24" deep rectangular and square tops only. Hinged plate with locking mechanism to lock in open or closed position. Cannot be installed with thumbscrews.</p> <ul style="list-style-type: none"> • Cannot be used when modesty panels and wire management are attached to worksurface tops. • For a single leg, order CNTFLEG24. For a pair of legs (set of 2), order CNTFLG24P. • Chrome (CHM) is available (on foot only). Add \$74 list for model CNTFLEG24. Add \$148 list for model CNTFLG24P. • Depth dimension reflects the T-leg bottom tube diameter. 					

Required specifications

Leg finish

C CONNECTABLES®

ACCESSORIES	MODEL #	DIMENSIONS	WT/LB.	CUBIC FT.	LIST PRICE
-------------	---------	------------	--------	-----------	------------



Flip-Top T-leg*

	W x D x H			
CNTFLEG30	26 x 1.75 x 28	14	3	\$323
CNTFLG30P	26 x 1.75 x 28	28	6	\$647

26" long with plastic elliptical column cover, leveling glides and end caps. **For assembly with 30" deep rectangular and square tops only.** Hinged plate with locking mechanism to lock in open or closed position. Cannot be installed with thumbscrews.

- Cannot be used when modesty panels and wire management are attached to worksurface tops.
- For a single leg, order **CNTFLEG30**. For a pair of legs (set of 2), order **CNTFLG30P**.
- Chrome (**CHM**) is available (on foot only). **Add \$74** list for model CNTFLEG30. **Add \$148** list for model CNTFLG30P.
- Depth dimension reflects the T-leg bottom tube diameter

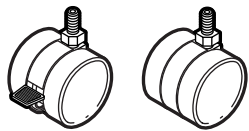

Casters

CNCP	- x - x 1.5	-	-	\$30
------	-------------	---	---	-------------

Set of 2 - 1.5" dual wheel casters, one locking. Suggested for hard floor surfaces and industrial carpeting. Not suitable for hardwood floors. Casters are fully interchangeable with glides. Black only.

- For use with *ConnectTABLES* units only.
- Casters **DO NOT** affect table height.



Thumbscrews

CNTS	1.25 x 1.25 x 1.5	0.04	0.02	\$20
------	-------------------	------	------	-------------

Triangular thumbscrew with 0.75" steel thread. **Set of 4.** Can be used in place of factory supplied screws to allow installation of T-legs to tops without tools. Black only.

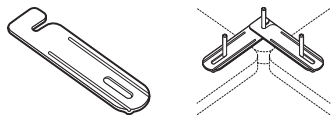

Ganging Connector

CNGFP	2.5 x 5 x 1.13	0.2	0.1	\$33
-------	----------------	-----	-----	-------------

Black epoxy coated 13 gauge steel with two thumbscrews included. Used to connect table tops together for additional stability or for connecting freestanding tops together. Holes with steel inserts are located in the corner of all tops to accommodate this plate. **Sold individually.**

Required specifications

Leg finish*

DUET™ STACKING TABLES



Duet tables are multi-purpose high density stacking tables that offer optimum space utilization and flexibility. Their personality and simple design make them ideal for use in any learning or training environment at post-secondary and adult levels. Temporarily and easily convert auditoriums and other spaces into examination and seminar spaces. They can be partnered with stacking chairs such as Duet or Popcorn in matching or complementary colors (stacking chairs can be found in the Multi-Purpose section of the Seating price list).

The one-piece molded top and modesty are gently contoured providing an eased edge with an elegant waterfall transition from top to modesty.

Tops are available in a wide array of colors in 0.5" thick polypropylene. Polypropylene material offers strength and ease of cleaning with a slightly textured surface to offer scratch resistance.

Features and Benefits

- One-piece molded top and modesty are 0.5" thick polypropylene.
- Tables are rated 250 lbs. capacity.
- Surface includes factory installed metal inserts for solid and secure connection to the sled base.
- 0.5" diameter solid steel rod sled base frame.
- Bumpers on the underside for protection when stacking.
- Model with ADA width compliant base is available.
- Shipped fully assembled.



One-piece top and modesty.



Stacks 5 high on floor or 20 high on dolly.



Ganging base to keep tables evenly aligned.

GENERAL INFORMATION

- Duet tables are high density multi-purpose stacking tables ideal for auditoriums, seminars or any learning or training environment.
- Lightweight and easy to handle whether stacking for storage or setting up a room.
- Made of durable materials to withstand more demanding environments.
- Shipped fully assembled. Packaged 4 per carton.
- For environmental certifications, please visit globalfurnituregroup.com.
- Covered by Global's Lifetime Warranty.

WORKSURFACES

- Top and modesty are a one-piece injection molded design in 0.5" thick polypropylene.
- Available in a wide array of colors (see right column "FINISHES") to complement any space or to define sections by color.
- One-piece molded top and modesty are contoured providing an eased user edge, with an elegant waterfall transition from top to modesty.

26"W x 18"D x 9.75"H

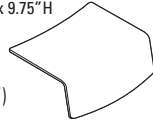

CONSTRUCTION

- Surface includes molded in threaded inserts to provide a secure metal-to-metal connection to the sled base.
- Bumpers are included on the underside of top and inside modesty to protect surfaces when stacking.

BASE

- 0.5" diameter solid steel rod sled base frame.
- Available in a durable Chrome finish.
- Model with ganging frame keeps tables evenly positioned and aligned. No tools or fasteners required for ganging; the bases simply interlock.
- Model with ADA compliant base is also available. The frame is 33" wide and the polypropylene top/modesty remain a constant size.
- Tables are standard without glides and are suitable for carpet, rubber or cork flooring.
- Glide options are available (see right column "GLIDES"). Glides must be chosen to best suit flooring type and site conditions. Upcharges apply.

DOLLY

- For space saving storage and transport.
- Constructed from 1.5" x 0.5" steel tubing with heavy duty casters (two locking) and a removable handle.
- Dolly can stack up to 20 tables.
- Stacking height on dolly is up to 68".

FINISHES

BZB	Buzz Blue	FRO	Frost
CCT	Cactus	INK	Ink
CRO	Carrot	LAB	Latte
IVC	Cloud	BLK	Night
DJN	Dijon	SND	Sand
EGP	Eggplant	SAR	Scarlet
FOG	Fog	SHW	Shadow

GLIDES

CG	Clear polycarbonate (for carpet, rubber or concrete flooring). Height added to table: 0.18". Add \$9/set.
SG	Glides with stainless steel pads (for carpet or rubber flooring). Height added to table: 0.17". Add \$19/set.
FG	Glides with felt pads (for vinyl, cork or laminate flooring). Height added to table: 0.24". Add \$19/set.
RG	Glides with rubber pads (for vinyl, hardwood, laminate, stone or ceramic flooring). Height added to table: 0.16". Add \$19/set.

SPECIFICATIONS

- Specifications marked with an * are applicable to only those products which have the* symbol beside the product name.

EXAMPLE DUET TABLE ORDER CODE:

Duet stacking table, polypropylene surface in Shadow, clear polycarbonate glides

DTS1828P	-SHW	-CG
Model #	Surface finish	Glides

STACKING TABLES **MODEL #** **DIMENSIONS** **WT/LB.** **CUBIC FT.** **LIST PRICE**

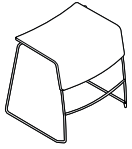

Stacking Table*

	W x D x H			
DTS1828P	29 x 25 x 28	23	23	\$469

One-piece polypropylene top and modesty with Chrome base. Dimensions listed include frame footprint, 26"W x 18"D top and 9.75'H modesty. Shipped fully assembled, 4 per carton.

- Price shown is per table. It is recommended to order in multiples of 4.

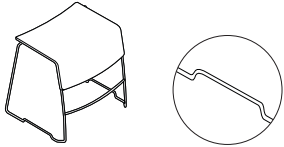

Stacking Table, Ganging Frame*

DTS1828PG	30.75 x 25 x 28	23	23	\$494
-----------	-----------------	----	----	--------------

One-piece polypropylene top and modesty with Chrome ganging base. Dimensions listed include frame footprint, 26"W x 18"D top and 9.75'H modesty. Shipped fully assembled, 4 per carton.

- Price shown is per table. It is recommended to order in multiples of 4.

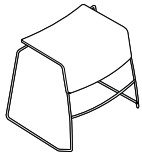

Stacking Table, 32" Wide

DTA1832P	33 x 25 x 28	24	23	\$532
----------	--------------	----	----	--------------

ADA (American with Disabilities Act) compliant. 33" wide. One-piece polypropylene top and modesty with Chrome base. Dimensions listed include frame footprint, 26"W x 18"D top and 9.75'H modesty. Underside clearance is 27.1"H (extra height if glides are selected). Stacks up to 5 high on floor only; dolly does not accommodate. Shipped fully assembled, 4 per carton.

- Price shown is per table. It is recommended to order in multiples of 4.

DOLLY

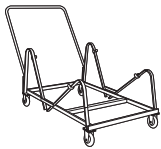

Dolly

DTD20	29.5 x 63 x 38.5	50	21	\$734
-------	------------------	----	----	--------------

For use with tables DTS1828P and DTS1828PG. Can stack up to 20 tables. Black only. Removable handle for storage. Shipped fully assembled in 1 carton.

Required specifications
Surface finish (not DTD20)

Optional specifications
Glides (not DTD20)

Accessories
Dolly*



Edventure is a value series collection that offers a range of teacher desks, student desks, study carrels and lecterns for more traditional learning environments. Designed to withstand daily rigorous use, traditional style meets modern performance.

Tops are available in a wide array of finishes in 1" thick thermally fused laminate or 1 1/16" high pressure laminate with matching or complementary 2mm PVC edgebanding.

Mobile lecterns and teacher desks offer versatility with storage options for educators on the move.

Single and connecting study carrels create quiet work areas with optional power and data to stay connected.

Features and Benefits

- Tops are 1" thick thermally fused laminate or 1 1/16" high pressure laminate.
- Tops are constructed of 45 lb. density particle board.
- Matching or complementary 2mm PVC edgebanding.
- Surfaces include factory installed metal inserts for solid and secure leg connections.
- H-leg design on teacher and student desks.
- Teacher desk includes modesty panel and is available with or without casters.
- Teacher desk with left or right hand box/box/file pedestal available on casters only.
- Study carrel features curved side panels for seated privacy with a 29"H worksurface.
- Easy to assemble.



H-legs with cross bar.



Mobile teacher desk with modesty panel.



Freestanding and add-on study carrels.

GENERAL INFORMATION

- Edventure series is an affordable collection of teacher desks, student desks, study carrels and lecterns with personal storage options, that bring a traditional element to the classroom.
- Simple and elegant design respects space requirements to accommodate various teaching styles.
- Edventure series is a high achiever, built to withstand the most demanding environments.
- Shipped easy to assemble.
- For environmental certifications, please visit globalfurnituregroup.com.

WORKSURFACES

- Tops are available in 1" thick thermally fused laminate or 1 1/16" thick high pressure laminate.
- Available in an array of finishes (see page 479) in both thermally fused laminate or high pressure laminate. Color palette also includes nine new bold finishes available for high pressure laminate only, a complementary edge finish must be selected.
- Teacher desks are optional with grommets FOG1, FOG2 or FOG3 or cut-outs E1, E2 or E3 for power block PMSDPM ordered separately.
- Teacher desks with box/box/file pedestal are predrilled with pilot holes on the underside for accepting a lectern shelf ENLS182 ordered separately.

CONSTRUCTION

- Top core is made of 45 lb. density particle board.
- Surfaces include factory installed metal inserts for solid and secure leg connections.

EDGE DETAIL

- Global's preferred 2mm PVC edgebanding is standard.
- Edgebanding may be specified in a matching or a complementary finish for tops in standard Global laminates.

LEGS

- H-legs are 28" high and constructed from 2" x 2" square tubing with a 1" x 2" rectangular cross bar and adjustable leveling glides.
- Available in Black (TBL), Buzz Blue (TBZ), Cactus (TCC), Carrot (TCR), Cloud (TIV), Designer White (TDW), Dijon (TDJ), Eggplant (TEG), Fog (TFO), Frost (TFR), Ink (TIN), Kalua (TKA), Latte (TLA), Mocha (TMO), Nevada (TNE), Sand (TSN), Scarlet (TSR), Shadow (TSH), Toast (TOA) or Tungsten (TTU) paint finishes, Sandtex finish applied.

CASTERS

- Teacher desks and lecterns are available with locking casters. See models ending in C.
- Casters are 3 1/2" high overall.

MODESTY PANELS

- 12"H modesty panel is included with teacher desks.
- Available in an array of finishes (see page 477) in thermally fused laminate with matching edge only.

STORAGE LECTERNS

- The steel storage lectern features integrated full pulls and a full welded seamless top for added strength and crisp appearance.
- Drawer and door fronts have welded reinforcements for additional strength.
- Available in three configurations, offering multiple storage options for storing personal items or keeping active files and resource materials close at hand.
- Removable cam locks are standard.
- Storage lecterns are supported by 2" x 2" x 3 1/2"H square tube legs on leveling glides or 3 1/2"H industrial size casters.
- Finished laminate tops to complement desking are available. See model ENMST1824.
- An optional lectern shelf offers a perfect platform for keeping presentation materials organized and at the presenter's fingertips. See model ENLS182.

SPECIFICATIONS

- Specifications marked with an * are applicable to only those products which have the* symbol beside the product name.

STUDY CARRELS

- The study carrel features a 29" high worksurface and curved side panels for privacy.
- Freestanding (starter) and add-on models are available. Legs and privacy panels are shared between adjoining add-on carrels.
- The back panel is inset to hide connecting fasteners from user's view. The inset back also creates a wire drop for the optional LED task light cord.
- Carrels with an optional shelf are available. See models ending in S.
- Optional LED task light is available for carrel with shelf, see page 421
- Optional Cove Daisylink system is available to bring power, USB charging or data to the carrel surface for desktop access, see pages 422-423

COVE DAISYLINK COMPONENTS

- A daisy-chainable power solution with a unique "no particular order" feature, making installation or reconfiguration easy.
- Cove Daisylink modules must be ordered separately and are available for study carrels only.
- You must specify the cut-out for Cove Daisylink modules when ordering the study carrels. Specify (CV). Order the Cove kits (modules and jumpers) and infeed separately.
- 29", 30", 35" and 36" study carrels have **one** optional cut-out. **Add \$91.**
- 59", 60", 71" and 72" study carrels have **two** optional cut-outs. **Add \$185.**
- For Cove Daisylink components, see pages 422-423.
- Maximum of 9 Cove modules per each infeed.

GROMMETS

- Optional grommets are available in standard worksurface locations (left, center or right) **for teacher desks**.
Order as: **FOG1, FOG2 or FOG3. Add \$91.**
- Grommet hole dimensions are 3.25" wide x 1.875" deep.



POWER BLOCK

- An individual corded power block is a rectangular worksurface power/data module with one electrical duplex receptacle and two data (RJ45) receptacles. 9' Black cord included. Power block dimensions are 6.5"W x 3.5"D x 2.75"H. Units cannot be daisy-chained.

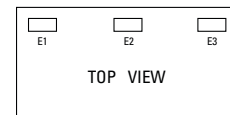
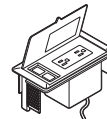

Power block **PMSDPM. Add \$268.** Specify location **E1, E2 or E3. Add \$91.**

MODPOWER DAISY-CHAIN SOLUTION

- Add flexible power and USB charging to Edventure study carrels. Connect up to four units with a single corded infeed with NEMA plug.
- ModPower units are sold separately, refer to Productivity Solutions page 473.
- Begin run with a starter unit which includes a corded infeed. Add additional middle or end units as required. Middle and end units are equipped with connecting cables.
- On-surface modules clamp on or screw mount to the table tops.
- In-surface modules require table top cut-outs for mounting:
 - Specify cut-out option **MPS** for a single cut-out to accommodate one ModPower in-surface unit (cut-out will be centered on the back edge of surface) for **29" to 72" wide study carrels. Add \$91.**
 - Specify cut-out option **MPD** for two cut-outs in the left and right positions, 15" from ends to center of unit on the back edge of surface for **59" to 72" wide study carrels. Add \$183.**

FINISHES

Thermally Fused or High Pressure Laminate Tops

ACJ Absolute Acajou	FCL First Class
ASN Asian Night	NBL Noce Biondo
AWC Avant Cherry	NGL Noce Grigio
AWH Avant Honey	NEL Noce Leggero
BLK Black	NML Noce Medio
BZD Blizzard	QTM Quartered Mahogany
BRC Brushed Cobalt	SBY Sheer Beauty
CMB Clear Maple	SDT Stonedust
CGY Custom Grey	SOG Storm Grey
DES Dark Espresso	WHE Walnut Heights
DWT Designer White	WHC White Chocolate
FAS Fashionista	WCR Winter Cherry

2mm Thick Edgebanding

AAE Absolute Acajou	FCL First Class
ASE Asian Night	FOG Fog
ACE Avant Cherry	LAB Latte
AHE Avant Honey	NBL Noce Biondo
BLK Black	NGL Noce Grigio
BZD Blizzard	NEL Noce Leggero
BRC Brushed Cobalt	NML Noce Medio
BZB Buzz Blue	QTM Quarter Mahogany
CCT Cactus	SAR Scarlet
CRO Carrot	SHW Shadow
CME Clear Maple	SBY Sheer Beauty
CGY Custom Grey	SDT Stonedust
DEE Dark Espresso	SOG Storm Grey
DWE Designer White	WHE Walnut Heights
DJN Dijo	CBE White Chocolate
FAS Fashionista	WCE Winter Cherry

Leg finishes

TBL Black	TIN Ink
TBZ Buzz Blue	TKA Kalua
TCC Cactus	TLA Latte
TCR Carrot	TMO Mocha
TIV Cloud	TNE Nevada
TDW Designer White	TSN Sand
TDJ Dijon	TSR Scarlet
TEG Eggplant	TSH Shadow
TFO Fog	TOA Toast
TFR Frost	TTU Tungsten

Paint Finishes for Metal Storage Lecterns

BLK Black	MET Metro
BKC Black Coffee*	MCH Mocha*
BZD Blizzard*	MOS Moss
BNE Bone	NVY Navy
BGR Business Grey	NEV Nevada
CHR Charcoal	OYS Oyster
CLT Claret	SKY Sky
DCH Dark Chocolate*	SIL Silver
DPT Desert Putty	STN Stone
DWT Designer White	SDT Stonedust*
FOG Fog	SGR Storm Grey
GRY Grey	TSA Tahiti Sand
ICE Ice	TPE Taupe
IVR Ivory	TUN Tungsten (add 10% upcharge)
LGR Light Grey	

*textured finishes

Note: Modesty panel and lectern shelf are available in thermally fused laminate finishes only. Modesty panel and pedestal edging will match thermally fused laminate finish specified.

TO SPECIFY:

1. SPECIFY MODEL NUMBER

2. SPECIFY THE FOLLOWING:

FOR TEACHER AND STUDENT DESKS:

- Top finish
- Optional HP laminate
- Edge finish (top only)
- Modesty finish if applicable
- Pedestal finish if applicable
- Leg finish
- Optional FOG grommet or cut-out for PMSDPM, if applicable
- Optional key alike or select number (#100-120) applicable on teacher desks with pedestal

FOR STORAGE LECTERNS:

- Case paint finish
- Optional key alike

FOR STUDY CARRELS:

- Top surface finish (shelf, if applicable, will be in the same finish)
- Optional HP laminate
- Edge finish
- Leg finish
- Surround finish (side and back panels)
- Optional cut-out(s) for Cove Daisylink components

EXAMPLE EDVENTURE ORDER CODES:

Teacher desk

ENTD7230	-ACJ	-HPL	-AAE	-TTU	-DWT
Model #	Top finish	High pressure laminate	Edge finish	Leg finish	Modesty panel finish

Storage lectern

EL18LPBF	-DWT	-KA
Model #	Case finish	Key alike

Study carrel

ENFC3024	-ACJ	-HPL	-AAE	-TTU	-DWT	-CV
Model #	Top finish	High pressure laminate	Top edge finish	Leg finish	Surround finish	Cut-out for Cove

TEACHER DESKS **MODEL #** **DIMENSIONS** **WT/LB.** **CUBIC FT.** **LIST PRICE** **HP ADD**

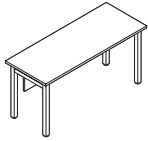

Teacher Desk, 24" Deep*

W x D x H						
ENTD4824	48 x 24 x 29	74	4.6	\$912	\$152	
ENTD5424	54 x 24 x 29	80	4.7	\$922	\$173	
ENTD6024	60 x 24 x 29	86	4.9	\$935	\$186	

12"H modesty panel included. Shipped easy to assemble in 2 cartons.

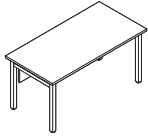

Teacher Desk, 30" Deep*

ENTD6030	60 x 30 x 29	96	6.4	\$993	\$202
ENTD6630	66 x 30 x 29	103	6.6	\$1032	\$249
ENTD7230	72 x 30 x 29	110	6.8	\$1064	\$263

12"H modesty panel included. Shipped easy to assemble in 2 cartons.

MOBILE TEACHER DESKS

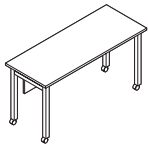

Mobile Teacher Desk, 24" Deep*

ENTD4824C	48 x 24 x 29	75	4.6	\$1059	\$152
ENTD5424C	54 x 24 x 29	81	4.7	\$1069	\$173
ENTD6024C	60 x 24 x 29	87	4.9	\$1082	\$186

12"H modesty panel included. Shipped easy to assemble in 2 cartons.

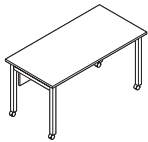

Mobile Teacher Desk, 30" Deep*

ENTD6030C	60 x 30 x 29	98	5.4	\$1142	\$202
-----------	--------------	----	-----	---------------	--------------

12"H modesty panel included. Shipped easy to assemble in 2 cartons.

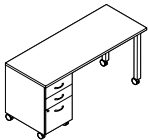

Mobile Teacher Desk w/Single Pedestal, 24" Deep - LEFT*

ET6024BBFLC	60 x 24 x 29	155	12.4	\$1872	\$186
ET6624BBFLC	66 x 24 x 29	161	12.6	\$1909	\$215
ET7224BBFLC	72 x 24 x 29	167	12.8	\$1943	\$244

Flush **left** hand locking box/box/file pedestal (top box drawer is non-locking) and 12"H modesty panel included. Top is predrilled above the pedestal on the underside for the addition of lectern shelf ENLS182 (sold separately). Shipped easy to assemble in 3 cartons (pedestal is fully assembled).

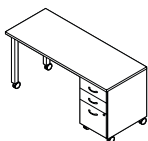

Mobile Teacher Desk w/Single Pedestal, 24" Deep - RIGHT*

ET6024BBFRC	60 x 24 x 29	155	12.4	\$1872	\$186
ET6624BBFRC	66 x 24 x 29	161	12.6	\$1909	\$215
ET7224BBFRC	72 x 24 x 29	167	12.8	\$1943	\$244

Flush **right** hand locking box/box/file pedestal (top box drawer is non-locking) and 12"H modesty panel included. Top is predrilled above the pedestal on the underside for the addition of lectern shelf ENLS182 (sold separately). Shipped easy to assemble in 3 cartons (pedestal is fully assembled).

Required specifications

Top finish Modesty finish
Leg finish Pedestal finish*
Edge finish

Optional specifications

HP laminate
FOG grommet or cut-out for PMSPDM
Key alike/Key #*

Accessories

Lectern shelf*

MOBILE TEACHER DESKS

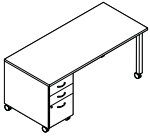

Mobile Teacher Desk w/Single Pedestal, 30" Deep - LEFT*

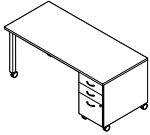

Mobile Teacher Desk w/Single Pedestal, 30" Deep - RIGHT*

MODEL #	DIMENSIONS W x D x H	WT/LB.	CUBIC FT.	LIST PRICE	HP ADD
ET6030BBFLC	60 x 30 x 29	193	14.7	\$1980	\$202
ET6630BBFLC	66 x 30 x 29	201	14.9	\$2017	\$249
ET7230BBFLC	72 x 30 x 29	210	15.1	\$2050	\$263

Flush **left** hand locking box/box/file pedestal (top box drawer is non-locking) and 12"H modesty panel included. Top is predrilled above the pedestal on the underside for the addition of lectern shelf ENLS182 (sold separately). Shipped easy to assemble in 3 cartons (pedestal is fully assembled).

ET6030BBFRC	60 x 30 x 29	193	14.7	\$1980	\$202
ET6630BBFRC	66 x 30 x 29	201	14.9	\$2017	\$249
ET7230BBFRC	72 x 30 x 29	210	15.1	\$2050	\$263

Flush **right** hand locking box/box/file pedestal (top box drawer is non-locking) and 12"H modesty panel included. Top is predrilled above the pedestal on the underside for the addition of lectern shelf ENLS182 (sold separately). Shipped easy to assemble in 3 cartons (pedestal is fully assembled).

STUDENT DESKS

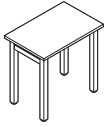

Student Desk**

ENST3020	30 x 20 x 29	49	3.9	\$461	\$106
----------	--------------	----	-----	--------------	--------------

Shipped easy to assemble in 2 cartons.

Required specifications





Top finish Modesty finish*
Leg finish Pedestal finish*
Edge finish

Optional specifications

HP laminate (teacher and student desks)
FOG grommet or cut-out for PMSPDM*
Key alike/Key #*

Accessories

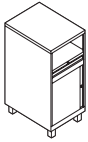
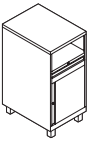
Lectern shelf*
Book box**

STORAGE LECTERNS		MODEL #	DIMENSIONS	WT/LB.	CUBIC FT.	LIST PRICE
 <p>Storage Lectern w/Laptop Drawer*</p>			W x D x H			
		EL18LPBF	18 x 24 x 38	148	11.7	\$3138
		Locking laptop drawer, open shelf, locking personal drawer, box drawer and file drawer. Cord escape on backside for laptop charging. 3 1/2" high metal legs with leveling glides. Shipped assembled in 1 carton.				
 <p>Storage Lectern - Box/File*</p>		EL18PBF	18 x 24 x 38	145	11.7	\$2654
		Open shelf, locking personal drawer, box drawer and file drawer. 3 1/2" high metal legs with leveling glides. Shipped assembled in 1 carton.				
 <p>Storage Lectern*</p>		EL18PHDL	18 x 24 x 38	128	11.7	\$2654
		Open shelf, locking personal drawer and left side hinged locking door with shelf inside. 3 1/2" high metal legs with leveling glides. Shipped assembled in 1 carton.				
 <p>Storage Lectern*</p>		EL18PHDR	18 x 24 x 38	128	11.7	\$2654
		Open shelf, locking personal drawer and right side hinged locking door with shelf inside. 3 1/2" high metal legs with leveling glides. Shipped assembled in 1 carton.				
MOBILE STORAGE LECTERNS						
 <p>Mobile Storage Lectern w/Laptop Drawer</p>		EL18LPBFC	18 x 24 x 38	148	11.7	\$3273
		Mobile, locking laptop drawer, open shelf, locking personal drawer, box drawer, file drawer, on four locking casters. Cord escape on back side for laptop charging. Shipped assembled in 1 carton.				
 <p>Mobile Storage Lectern - Box/File</p>		EL18PBFC	18 x 24 x 38	145	11.7	\$2787
		Mobile, open shelf, locking personal drawer, box drawer, file drawer, on four locking casters. Shipped assembled in 1 carton.				

Required specifications

Paint finish, case
Trim finish, feet*

Optional specifications

Key alike

Accessories

Laminate top
Lectern shelf

MOBILE STORAGE LECTERNS

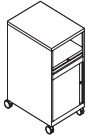

Mobile Storage Lectern*



Mobile Storage Lectern*

MODEL #	DIMENSIONS W x D x H	WT/LB.	CUBIC FT.	LIST PRICE	HP ADD
EL18PHDLC	18 x 24 x 38	128	11.7	\$2787	N/A

Mobile, open shelf, locking personal drawer, **left** side hinged locking door with shelf inside, on four locking casters. Shipped assembled in 1 carton.

EL18PHDRC	18 x 24 x 38	128	11.7	\$2787	N/A
-----------	--------------	-----	------	---------------	-----

Mobile, open shelf, locking personal drawer, **right** side hinged locking door with shelf inside, on four locking casters. Shipped assembled in 1 carton.

ACCESSORIES

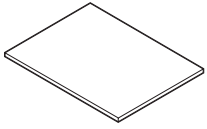

Top for Storage Lectern**

ENMST1824	18 x 24 x 1	10.5	0.27	\$183	\$84
-----------	-------------	------	------	--------------	-------------

Finished laminate top for storage lecterns. Available in an array of thermally fused laminate or high pressure laminate finishes to complement deskings, see page 479. Shipped in 1 carton.

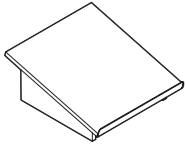

Lectern Shelf**

ENLS182	18 x 21 x 3.25-8.25	19	2.55	\$352	N/A
---------	---------------------	----	------	--------------	-----

Offers the perfect platform for keeping lectern materials at the facilitator's fingertips. May be secured to finished top or left unattached to use elsewhere. Screws provided to secure to finished top from the underside. Shipped assembled in 1 carton.

Required specifications

Painte finish, case*
Laminate finish**
Edge finish (ENMST1824 only)
Trim finish (ENLS182 only)

Optional specifications

Key alike*
HP laminate (ENMST1824 only)

FREESTANDING OR STARTER STUDY CARRELS

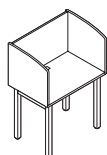

Freestanding/Starter Study Carrel*

MODEL #	DIMENSIONS W x D x H	WT/LB.	CUBIC FT.	LIST PRICE	HP ADD	CUT-OUT ADD
ENFC3024	30 x 24 x 50	89	4.44	\$890	\$107	\$91
ENFC3624	36 x 24 x 50	97.5	4.72	\$942	\$107	\$91
ENFC6024	60 x 24 x 50	115	5.8	\$1097	\$186	\$185
ENFC7224	72 x 24 x 50	123.5	6.34	\$1172	\$213	\$185

Features a 29" high worksurface with curved side privacy panels. Shown with optional cut-out. Bring power and USB charging to the user with Cove Daisylink components, see pages 422-423. Shipped easy to assemble in 2 cartons.

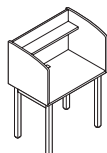

Freestanding/Starter Study Carrel w/Shelf*

ENFC3024S	30 x 24 x 50	93	4.44	\$947	\$107	\$91
ENFC3624S	36 x 24 x 50	102.5	4.72	\$991	\$107	\$91
ENFC6024S	60 x 24 x 50	122	5.8	\$1175	\$186	\$185
ENFC7224S	72 x 24 x 50	131.5	6.34	\$1261	\$186	\$185

Features a 29" high worksurface with curved side privacy panels. Shown with optional cut-out. Shelf is 6" deep and accepts optional LED task light. Bring power and USB charging to the user with Cove Daisylink components, see pages 422-423. Shipped easy to assemble in 2 cartons.

ADD-ON STUDY CARRELS

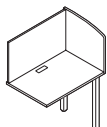

Add-On Study Carrel*

ENAC2924	29 x 24 x 50	63	4.4	\$677	\$107	\$91
ENAC3524	35 x 24 x 50	71.5	4.67	\$704	\$122	\$91
ENAC5924	59 x 24 x 50	89	5.75	\$865	\$186	\$185
ENAC7124	71 x 24 x 50	97.5	6.3	\$939	\$186	\$185

Features a 29" high worksurface with curved side privacy panels. Shown with optional cut-out. Bring power and USB charging to the user with Cove Daisylink components, see pages 422-423. Shipped easy to assemble in 2 cartons.

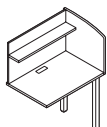

Add-On Study Carrel w/Shelf*

ENAC2924S	29 x 24 x 50	67	4.4	\$710	\$107	\$91
ENAC3524S	35 x 24 x 50	76.5	4.67	\$755	\$107	\$91
ENAC5924S	59 x 24 x 50	96	5.75	\$944	\$186	\$185
ENAC7124S	71 x 24 x 50	105.5	6.3	\$1029	\$186	\$185

Features a 29" high worksurface with curved side privacy panels. Shown with optional cut-out. Shelf is 6" deep and accepts optional LED task light. Bring power and USB charging to the user with Cove Daisylink components, see pages 422-423. Shipped easy to assemble in 2 cartons.

LED TASK LIGHTS

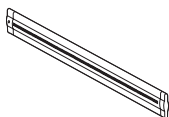

LED Task Light

PLED30	15.5 x 1.5 x 0.5	2	0.5	\$344	N/A	N/A
PLED100	43.5 x 1.5 x 0.5	3	0.5	\$461	N/A	N/A

Energy efficient LED. Ultra slim design. Suitable for mounting on the underside of the shelf of a study carrel. 6' power cord.

Required specifications

- Top finish*
- Edge finish*
- Leg finish*
- Surround finish*

Optional specifications

- HP laminate*
- Cut-out for Cove Daisylink modules*

Accessories

- Cove Daisylink modules*
- LED task lights*

COVE DAISYLINK COMPONENTS

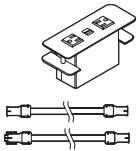

Single Power/USB for 29"/30" Carrels

MODEL #	DIMENSIONS W x D x H	WT/LB.	CUBIC FT.	LIST PRICE
ECV2PU30B	30 x 2 x -	4.5	0.5	\$1010
ECV2PU30S	30 x 2 x -	4.5	0.5	\$1010

Cove single desktop module with two power outlets and two 2.1A USB charging ports. Includes four cable clamps, one 14" female/male connecting cable and one 14" female/female connecting cable. Connecting cables will daisy-chain modules between two 30" wide starter carrels, one 30" wide starter carrel and one 29" wide add-on carrel, or two 29" wide add-on carrels. Available in Black (B) or Silver (S) - indicated by last letter of the model number. Infeed to be ordered separately.

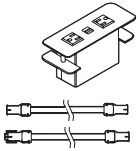

Single Power/USB for 35"/36" Carrels

ECV2PU36B	36 x 2 x -	4.6	0.5	\$1022
ECV2PU36S	36 x 2 x -	4.6	0.5	\$1022

Cove single desktop module includes two power outlets and two 2.1A USB charging ports. Includes four cable clamps, one 17" female/male connecting cable and one 17" female/female connecting cable. Connecting cables will daisy-chain modules between two 36" wide starter carrels, one 36" wide starter carrel and one 35" wide add-on carrel, or two 35" wide add-on carrels. Available in Black (B) or Silver (S) - indicated by last letter of the model number. Infeed to be ordered separately.

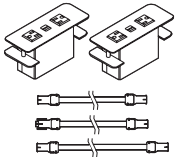

Double Power/USB for 59"/60" Carrels

ECV2PU60B	60 x 2 x -	4.6	0.5	\$1880
ECV2PU60S	60 x 2 x -	4.6	0.5	\$1880

Cove double desktop modules - each module includes two power outlets and two 2.1A USB charging ports. Includes four cable clamps, one 12" female/male connecting cable, one 12" female/female connecting cable and one 26" female/female interconnecting cable. Connecting cables will daisy-chain modules between two 60" wide starter carrels, one 60" wide starter carrel and one 59" wide add-on carrel, or two 59" wide add-on carrels. Available in Black (B) or Silver (S) - indicated by last letter of the model number.

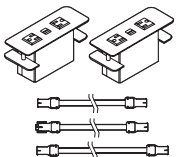

Double Power/USB for 71"/72" Carrels

ECV2PU72B	72 x 2 x -	4.6	0.5	\$1901
ECV2PU72S	72 x 2 x -	4.6	0.5	\$1901

Cove double desktop modules - each module includes two power outlets and two 2.1A USB charging ports. Includes four cable clamps, one 15" female/male connecting cable, one 15" female/female connecting cable and one 31" female/female interconnecting cable. Connecting cables will daisy-chain modules between two 72" wide starter carrels, one 72" wide starter carrel and one 71" wide add-on carrel, or two 71" wide add-on carrels. Available in Black (B) or Silver (S) - indicated by last letter of the model number.

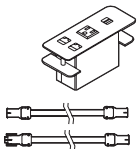

Single Power/Data/USB for 29"/30" Carrels

ECVPUD30B	30 x 2 x -	4.6	0.5	\$955
ECVPUD30S	30 x 2 x -	4.6	0.5	\$955

Cove single desktop module includes one power outlet, two data knockouts and two 2.1A USB charging ports. Includes four cable clamps, one 14" female/male connecting cable and one 14" female/female connecting cable. Data/telecom options to be ordered separately. Connecting cables will daisy-chain modules between two 30" wide starter carrels, one 30" wide starter carrel and one 29" wide add-on carrel, or two 29" wide add-on carrels. Available in Black (B) or Silver (S) - indicated by last letter of the model number. Infeed to be ordered separately.

COVE DAISYLINK COMPONENTS **MODEL #** **DIMENSIONS** **WT/LB.** **CUBIC FT.** **LIST PRICE**

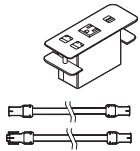

Single Power/Data/USB for 35"/36" Carrels

	W x D x H			
ECVPUD36B	36 x 2 x -	4.6	0.5	\$967
ECVPUD36S	36 x 2 x -	4.6	0.5	\$967

Cove single desktop module includes one power outlet, two data knockouts and two 2.1A USB charging ports. Includes four cable clamps, one 17" female/male connecting cable and one 17" female/female connecting cable. Data/telecom options to be ordered separately. Connecting cables will daisy-chain modules between two 36" wide starter carrels, one 36" wide starter carrel and one 35" wide add-on carrel, or two 35" wide add-on carrels. Available in Black (B) or Silver (S) - indicated by last letter of the model number. Infeed to be ordered separately.

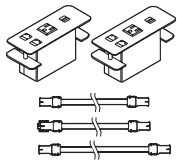

Double Power/Data/USB for 59"/60" Carrels

ECVPUD60B	60 x 2 x -	4.6	0.5	\$1769
ECVPUD60S	60 x 2 x -	4.6	0.5	\$1769

Cove double desktop modules - each module includes one power outlet, two data knockouts and two 2.1A USB charging ports. Includes four cable clamps, one 12" female/male connecting cable, one 12" female/female connecting cable and one 26" female/female interconnecting cable. Data/telecom options to be ordered separately. Connecting cables will daisy-chain modules between two 60" wide starter carrels, one 60" wide starter carrel and one 59" wide add-on carrel, or two 59" wide add-on carrels. Available in Black (B) or Silver (S) - indicated by last letter of the model number. Infeed to be ordered separately.

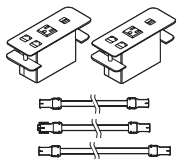

Double Power/Data/USB for 71"/72" Carrels

ECVPUD72B	72 x 2 x -	4.6	0.5	\$1790
ECVPUD72S	72 x 2 x -	4.6	0.5	\$1790

Cove double desktop modules - each module includes one power outlet, two data knockouts and two 2.1A USB charging ports. Includes four cable clamps, one 15" female/male connecting cable, one 15" female/female connecting cable and one 31" female/female interconnecting cable. Data/telecom options to be ordered separately. Connecting cables will daisy-chain modules between two 72" wide starter carrels, one 72" wide starter carrel and one 71" wide add-on carrel, or two 71" wide add-on carrels. Available in Black (B) or Silver (S) - indicated by last letter of the model number. Infeed to be ordered separately.



Single-Circuit Corded Infeed, 72"

ENCOVC1	72"W	3	0.5	\$369
---------	------	---	-----	--------------

72" corded infeed to start a run of Cove Daisylink modules. Maximum of 9 Cove modules per each infeed (Cove double counts as two modules).

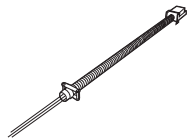

Multi-Circuit Power Hardware Infeed, 72"

ENCOVHW1	72"W	2.75	0.5	\$238
----------	------	------	-----	--------------

Hardware infeed to start a run of Cove Daisylink modules. Maximum of 9 Cove modules per each infeed (Cove double counts as two modules). Certified electrician required for installation.

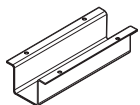

Jumper Guards - Set of 4

ENCVG12	12 x 5 x 3.1	14	1.1	\$143
---------	--------------	----	-----	--------------

Metal channel to protect jumper connection to Cove Daisylink module. Black only. Mounts directly to the underside of surface.



Designed by Zoey Chu, Junction provides an affordable solution for your table applications. Choose from a variety of table top designs: rectangular, half round, trapezoid and keystone to create a unique table for your boardroom, classroom or presentation room application.

A freestanding or shared leg configuration with the unique “Y” leg allows you to either create a permanent table or one that can be reconfigured quickly and easily. A straight leg is available for use with half round and keystone tops.

Shared leg configurations allow more legroom and can also decrease cost because they use fewer components. Freestanding configurations provide more flexibility for changing environments.

Features and Benefits

- Tops are 1” thick and constructed of 45 lb. density particle board.
- 2mm matching edge is standard.
- Optional radius corners (**RM**) available at no upcharge.
- Optional modesty panel with integrated wire trough available.
- Casters available with or without manual locks provide mobility.
- Black grommets for convenient wire management can be ordered factory installed.
- Optional, easy-to-use thumbscrews allow installation without tools.
- Junction tops are available in Global laminate finishes with two leg options.



Y leg design.



Modesty panel.



Shared leg configuration provides more legroom and decreases the overall costs.

GENERAL INFORMATION

- Junction is a series of multi-purpose tables for classroom, training room and boardroom applications.
- Ability for tables to be set up as freestanding or shared leg configuration.
- Unique design by Zooey Chu.
- Half round, trapezoid and keystone tops are available to create a variety of package configurations.
- Rectangular tops are available in 20", 24" and 30" depths.
- Optional modesty panels with integrated wire troughs are available.
- Optional large electrical manager provides a safe environment for equipment wires.
- Special width tops are available. Use next size up.
- Shipped easy to assemble. Each component is packaged individually; legs are shipped 1 per carton.
- For environmental certifications, please visit globalfurnituregroup.com.

WORKSURFACES

- Tops are 1" thick, made of 45 lb. density particle board covered on both sides with high performance thermally fused melamine.
- Laminate finishes are available in high pressure. Contact your Customer Service representative for a quote.
- If other than a Global standard laminate finish is preferred, contact your Customer Service representative. Information needed includes the name of the laminate manufacturer, color name, number and model of table. You will then be given a quote for this special order.

CONSTRUCTION

- Rectangular tops 54" in length and longer include a steel support channel for structural rigidity.
- Tops are predrilled with threaded steel inserts.
- Special width tops are available. Use next size up (add 10% upcharge).
- Adjustable levelers offer up to 1" adjustability.

EDGE DETAIL

- Global's preferred matching edge is standard.
- Optional radius corners (**RM**) are available on rectangular tops at no upcharge.

LEGS

- Unique Y design.
- Straight leg available for assembly with half round tops and keystone tops.
- Heavy duty steel construction.
- Coated with environmentally friendly recycled paint that provides a durable finish.
- Black plastic leveling glides offer $\frac{5}{8}$ " adjustability.
- Available in Black (**TBL**), Cloud (**TIV**), Designer White (**TDW**), Fog (**TFO**), Frost (**TFR**), Kalua (**TKA**), Latte (**TLA**), Mocha (**TMO**), Nevada (**TNE**), Sand (**TSN**), Shadow (**TSH**), Toast (**TOA**) or Tungsten (**TTU**) finish.
- Y legs: 17.5" leg span - 20"D top, 21.5" leg span - 24"D top, 24.5" leg span - 30"D top.

CASTERS

- Optional casters are available.
- 1.5" dual wheel casters with or without manual lock. Full 360° swivel.
- Can be used in any combination with or without standard glides.
- Suggested for carpeted surfaces.
- Available in Black only.
- Sold in packages of two.

GANGING

- Ganging plates are available for ganging workstations together.
- Ganging plates are Black epoxy coated steel plates with two thumbscrews.
- Provides maximum stability and torque reduction.

FLUSH PLATE

- Suggested for top clusters (fixed configurations for additional stability).
- Sold individually and shipped with two thumbscrews for mounting.
- No tools required.
- Flush plate allows for ganging together of two or more tops.

WIRE MANAGEMENT

- Available for managing additional larger wires and power connectors.
- 3.5" high x 4.25" deep Black PVC channel attaches to the underside of top.

SPECIFICATIONS

- Specifications marked with an * are applicable to only those products which have the* symbol beside the product name.

1. SPECIFY MODEL NUMBER

2. SPECIFY FINISH

Laminate Finishes:

ACJ Absolute Acajou	FCL First Class
ASN Asian Night	NBL Noce Biondo
AWC Avant Cherry	NGL Noce Grigio
AWH Avant Honey	NEL Noce Leggero
BLK Black	NML Noce Medio
BZD Blizzard	QTM Quartered Mahogany
BRC Brushed Cobalt	SBY Sheer Beauty
CMB Clear Maple	SDT Stonedust
CGY Custom Grey	SOG Storm Grey
DES Dark Espresso	WHE Walnut Heights
DWT Designer White	WHC White Chocolate
FAS Fashionista	WCR Winter Cherry

Legs:

TBL Black	TMO Mocha
TIV Cloud	TNE Nevada
TDW Designer White	TSN Sand
TFO Fog	TSH Shadow
TFR Frost	TOA Toast
TKA Kalua	TTU Tungsten
TLA Latte	

3. SPECIFY OPTIONS

MODESTY PANELS

- 11.25" high panel attaches to the underside of worksurface top.
- Standard with integrated wire trough.
- Available in Black PVC.

GROMMETS

- Grommets are available in **rectangular and trapezoid** tops (left, center or right). See below for available locations. Order as: **FOG1, FOG2 or FOG3**. Add \$91. For **keystone** worksurface locations, order as **FOG2**. Add \$91.
- Grommet hole dimensions are 3.25" wide x 1.875" deep.

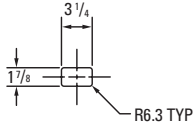

- Grommets may be placed at non-standard locations. Order as: **CSG**. Add \$132. A drawing must be supplied with vertical and horizontal dimensions to the center of the cut-out (as in drawing above). Please refer to the **custom grommet location form** in the back reference section.

POWER BLOCK

- A power block (model **PMSPDM**) may be ordered on all worksurfaces.
- A power block is a rectangular worksurface power/data module with one electrical duplex receptacle and two data (RJ45) receptacles. 9' Black cord included. Power block dimensions are 6.5"W x 3.5"D x 2.75"H.
- To purchase a power block, you must specify both the power block cut-out location and the power block model #. Order power block as **PMSPDM**. Add \$268. Power blocks are available in standard worksurface locations (left, center or right). Order as **E1, E2 or E3**. Add \$91.

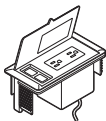

Power block **PMSPDM**. Add \$268.

EXAMPLES OF GROMMET AND POWER BLOCK POSITIONS

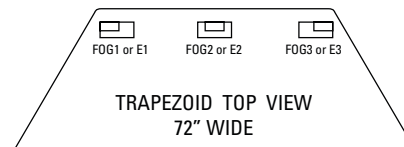
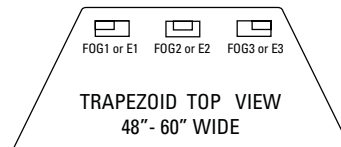
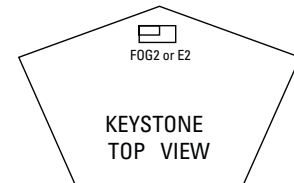
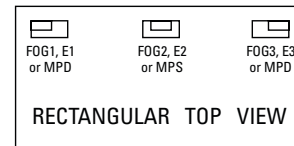

MODPOWER DAISY CHAIN SOLUTION

- Add flexible power and USB charging to Junction **rectangular tables** only. Connect up to four units with a single corded infeed with NEMA plug.
- ModPower units are sold separately, refer to Productivity Solutions page 473.
- Begin run with a starter unit which includes a corded infeed. Add additional middle or end units as required. Middle and end units are equipped with connecting cables.
- On-surface modules clamp on or screw mount to the table tops.
- In-surface modules require table top cut-outs for mounting (cannot be used with modesties). Specify cut-out option:
 - **MPS** for a single cut-out to accommodate one ModPower in-surface unit (cut-out will be centered on the approach side) for **30" to 72" wide rectangular tables**. Add \$91.
 - **MPD** for two cut-outs in the left and right positions, 15" from ends to center of unit on approach side for 60", 66" and 72" wide rectangular tables. Add \$183.

RECTANGULAR TOPS **MODEL #** **DIMENSIONS** **WT/LB.** **CUBIC FT.** **LIST PRICE** **HP ADD**

W x D x H

JNR2042	42 x 20 x 1	26	1.1	\$190	\$95	
JNR2048	48 x 20 x 1	29	1.15	\$199	\$99.50	
JNRU2054	54 x 20 x 1	33	1.3	\$279	\$139.50	
JNRU2060	60 x 20 x 1	37	1.4	\$295	\$147.50	
JNRU2066	66 x 20 x 1	41	1.55	\$320	\$160	
JNRU2072	72 x 20 x 1	45	1.66	\$344	\$172	
JNR2442	42 x 24 x 1	31	1.25	\$210	\$105	
JNR2448	48 x 24 x 1	35	1.4	\$227	\$113.5	
JNRU2454	54 x 24 x 1	42	1.52	\$317	\$158.50	
JNRU2460	60 x 24 x 1	47	1.67	\$337	\$168.50	
JNRU2466	66 x 24 x 1	52	1.82	\$365	\$182.50	
JNRU2472	72 x 24 x 1	57	2	\$390	\$195	
JNR3042	42 x 30 x 1	38	1.51	\$248	\$124	
JNR3048	48 x 30 x 1	44	1.7	\$270	\$135	
JNRU3054	54 x 30 x 1	52	1.9	\$362	\$181	
JNRU3060	60 x 30 x 1	59	2.1	\$386	\$193	
JNRU3066	66 x 30 x 1	64	2.26	\$415	\$207.50	
JNRU3072	72 x 30 x 1	70	2.5	\$442	\$221	

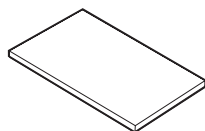

Rectangular Top*

Predrilled with threaded steel inserts for freestanding and linking installations. **Tops 54" and longer are standard with a 16 gauge steel support channel.**

HALF ROUND TOPS

JNHFS2040	40 x 20 x 1	23	1.05	\$227	\$113.50
JNHFS2048	48 x 20 x 1	27.5	1.15	\$236	\$118
JNHFS2448	48 x 24 x 1	34	1.4	\$250	\$125
JNHFS2454	54 x 27 x 1	38.25	1.52	\$315	\$157.50
JNHFS3060	60 x 30 x 1	53	1.67	\$335	\$167.50
JNHFS3066	66 x 33 x 1	58.3	1.82	\$431	\$215.50

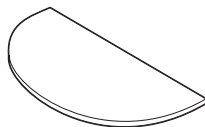

Half Round Top

Predrilled with threaded steel inserts for freestanding and linking installations. Four legs are required for freestanding configurations.

- **JNHFS2040/JNHFS2048** for use with 20" deep joining edge.
- **JNHFS2448/JNHFS2454** for use with 24" deep joining edge.
- **JNHFS3060/JNHFS3066** for use with 30" deep joining edge.

TRAPEZOID TOPS

JNTT2048	48 x 15.25 x 1	27.5	1.15	\$222	\$111
JNTT2060	60 x 15.25 x 1	34	1.4	\$265	\$132.50
JNTT2448	48 x 20.5 x 1	33	1.4	\$239	\$119.50
JNTT2460	60 x 20.5 x 1	41.25	1.67	\$290	\$145
JNTT3060	60 x 25.75 x 1	50.5	2.1	\$314	\$157
JNTT3072	72 x 25.75 x 1	61	2.5	\$358	\$179

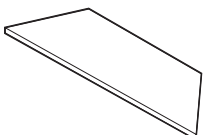

Trapezoid Top

Predrilled with threaded steel inserts for freestanding and linking installations.

- **JNTT2040/JNTT2048** for use with 20" deep joining edge.
- **JNTT2448/JNTT2454** for use with 24" deep joining edge.
- **JNTT3060/JNTT3066** for use with 30" deep joining edge.

Required specifications
Finish

Optional specifications
Grommet*

Accessories
Power block*

KEYSTONE TOPS

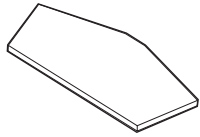

Keystone Tops

MODEL #	DIMENSIONS W x D x H	WT/LB.	CUBIC FT.	LIST PRICE	HD ADD
JN5S2424	42 x 24 x 1	35	1.4	\$270	\$135
JN5S3030	54 x 30 x 1	53	2.1	\$345	\$172.50

Predrilled with threaded steel inserts for freestanding and linking installations. Three legs are required for freestanding configurations.

- **JN5S2424** for use with 24" deep joining edge.
- **JN5S3030** for use with 30" deep joining edge.

MODESTY PANELS



Modesty Panel

JNMP42	29.19 x 6.92 x 11.25	3.7	1.5	\$186	N/A
JNMP48	35.19 x 6.92 x 11.25	4.5	1.75	\$210	N/A
JNMP54	41.19 x 6.92 x 11.25	5	2	\$234	N/A
JNMP60	47.19 x 6.92 x 11.25	5.9	2.25	\$260	N/A
JNMP66	53.19 x 6.92 x 11.25	6.6	2.5	\$274	N/A
JNMP72	59.19 x 6.92 x 11.25	7.4	2.75	\$300	N/A

For use with **JNR rectangular tops**. 11.25" high, Black plastic, attractive ribbed design. Includes integrated wire trough. Connects to predrilled holes in table top.

WIRE MANAGEMENT

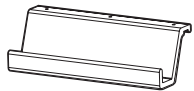

Wire Manager

JNEC5S	12.5 x 4.14 x 3.63	1	0.1	\$46	N/A
--------	--------------------	---	-----	-------------	-----

For use with **JN5S keystone**. For managing additional wires and power connectors. 3.5" high Black PVC channel connects to predrilled holes in table top.



Wire Manager

JNEC42	41.75 x 4.14 x 3.63	2.52	0.33	\$117	N/A
JNEC48	47.75 x 4.14 x 3.63	2.88	0.38	\$139	N/A
JNEC54	53.75 x 4.14 x 3.63	3.24	0.43	\$153	N/A
JNEC60	59.75 x 4.14 x 3.63	3.6	0.48	\$172	N/A
JNEC66	65.75 x 4.14 x 3.63	3.96	0.53	\$172	N/A
JNEC72	71.75 x 4.14 x 3.63	4.32	0.58	\$234	N/A

For use with **JNR rectangular tops**. For managing additional wires and power connectors. 3.5" high Black PVC channel connects to predrilled holes in the table top.

Required specifications
Finish (keystone)

Optional specifications
Grommet (keystone)

Accessories
Power block (keystone)

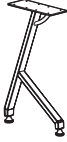
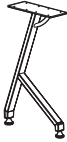
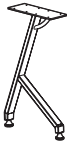
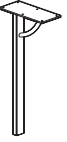
LEGS	MODEL #	DIMENSIONS	WT/LB.	CUBIC FT.	LIST PRICE
 <p>"Y" Leg</p>	JNLEG20	2 x 17.4 x 27.3	8.5	2	\$170
	<p>Leg span is 17.5". Leveling glides are standard. For assembly with 20" deep tops.</p> <ul style="list-style-type: none"> List price is per each leg. See page 426 for available finishes. 				
	JNLEG24	2 x 21.5 x 27.3	10	2.5	\$170
	<p>Leg span is 21.5". Leveling glides are standard. For assembly with 24" deep tops.</p> <ul style="list-style-type: none"> List price is per each leg. See page 426 for available finishes. 				
 <p>"Y" Leg</p>	JNLEG30	2 x 24.5 x 27.3	11	2.85	\$187
	<p>Leg span is 24.5". Leveling glides are standard. For assembly with 30" deep tops.</p> <ul style="list-style-type: none"> List price is per each leg. See page 426 for available finishes. 				
 <p>"Y" Leg</p>	JNLEG	2 x 1 x 27.3	6	1.3	\$155
	<p>Leveling glides are standard. For assembly with half round and keystone tops. Mounting plate is 11" deep by 5" wide.</p> <ul style="list-style-type: none"> List price is per each leg. See page 426 for available finishes. 				
 <p>Straight Leg</p>					

Required specifications
Finish (not JNECTxxxx)

J JUNCTION™

CASTERS

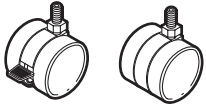

Casters

MODEL #	DIMENSIONS W x D x H	WT/LB.	CUBIC FT.	LIST PRICE
JNCP	- x - x 1.5	-	-	\$30

Set of 2 - 1.5" dual wheel casters, one locking. Suggested for carpeted surfaces. Casters are fully interchangeable with glides. Black only.

- For use with Junction units only.
- Casters DO NOT affect table height.

ACCESSORIES



Thumbscrews

JNTS	1.25 x 1.25 x 1.5	-	-	\$17
------	-------------------	---	---	-------------

Triangular thumbscrew with 0.75" steel thread. Set of 4. Can be used in place of factory supplied screws to allow installation of "Y" legs to tops without tools. Black only.

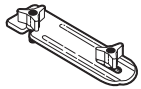

Ganging Flush Plate

JNGFP	2.5 x 5 x 1.13	0.2	0.1	\$28
-------	----------------	-----	-----	-------------

Black epoxy coated steel plates with 2 thumbscrews included. Used to connect table tops together for additional stability or for connecting freestanding tops together. Holes with steel inserts are located in the corner of the tops to accommodate this plate. Sold individually.



Flush Plate

JNFP1	5.25 x 5.25 x 0.37	1.3	0.02	\$5
JNFP4	5.25 x 5.25 x 0.37	5.2	0.2	\$20

Assures alignment on adjoining worksurfaces of the same height. Bolts included. Available in Black only.
JNFP1 - 1 per carton.
JNFP4 - 4 per carton.



Zook was designed for today's dynamic and diverse learning environments. The tables are lightweight and can be reconfigured easily to create interactive environments and support collaboration.

Choose from a variety of organic and geometric shaped table tops to optimize flexibility. They are available in a wide array of sizes and finishes in both thermally fused laminate and high pressure laminate with matching or complementary edgeband and an array of painted finishes for metal legs.

Tops are available in 1" thick thermally fused laminate or 1 1/16" high pressure laminate with 2mm PVC edgebanding or a new optional ergo friendly edge.

Features and Benefits

- Tops are 1" thick thermally fused laminate or 1 1/16" high pressure laminate.
- Tops are constructed of 45 lb. density particle board.
- 2mm PVC edgebanding or optional ergo friendly edge (with some exceptions).
- Tops are available in organic and geometric shapes.
- Surfaces include factory installed metal inserts for solid and secure leg connections.
- Cable tower on group tables is constructed from thermally fused laminate with a removable access panel and inside clearance of 8" x 8.6". Available on group tables ZK44848P, ZK45959P and ZK65990 only.
- Easy to assemble.



Variety of organic and geometric shapes.



Multiple table configurations. Ideal for group study and encouraging collaboration.



Optional ergo friendly edge.

GENERAL INFORMATION

- Zook is a series of tables designed for classrooms and diverse learning environments.
- Organic shapes and rectangular tops are available to create a variety of configurations that naturally bring people together.
- Choose from Zook group tables for groups of 4 to 6 people, pod tables for individuals, activity tables or flip-top tables.
- Create spaces that encourage discussion and the sharing of ideas.
- Supports multi-use, active learning spaces and a variety of teaching styles.
- Materials and workmanship stand up to the rigorous demands of today's learning environments.
- Shipped easy to assemble. Tops include factory installed metal inserts to accept leg attachment.
- For environmental certification, please visit globalfurnituregroup.com.

ZOOK GROUP TABLES

- Organic shaped tops available in three sizes: 48" x 48", 59" x 59" or 59" x 90".
- Tops supported by 3" diameter fixed height post legs.
- Select models available with cut-out options for power modules; these select models also include a cable tower for managing cables to floor monuments.

ZOOK POD TABLES

- Available in four geometric shapes; three that when used adjacent to one another, can create various pod configurations as well as rectangular tables in a number of sizes.
- ADA compliant heights available for select models.
- 1.5" diameter fixed height post legs.
- Tables may be specified on levelers or with casters for greater mobility and flexibility.

ZOOK ACTIVITY TABLES

- Available in three shapes, all based on a 54" wide footprint.
- Tops are available with two types of mating edges: curved or straight. When planning to mate tables, do not mix mating edge styles.
- 2" diameter tapered legs on levelers or casters.

ZOOK FLIP-TOP TABLES

- Available in three sizes: 30"W x 22"D with concave shaped top; 30"W x 24"D and 60" W x 24"D rectangular top with radiused corners.
- Supported by Y-legs equipped with smooth glide casters (two locking). H-legs are in Tungsten (TTU) finish only.
- 60" wide table tops optional with FOG1, FOG2 or FOG3 grommet. **Add \$91.**
- Modesty panels are available separately in Tungsten (TUN) finish only.

WORKSURFACES

- Tops are available in 1" thick thermally fused laminate or 1 1/16" thick high pressure laminate.
- See page 479 for a list of thermally fused and high pressure laminate finishes available, including nine bold finishes in high pressure laminate only.
- Worksurface cores are 45 lb. density particle board.
- All surfaces include factory installed metal inserts for solid and secure leg connections.

WRITABLE SURFACE OPTION

- Available on group, pod, activity, flip-top and rectangular tables.
- High gloss White, non-magnetic dry-erase surface.
- Complementary or contrasting edge to be specified, darker edge finish recommended.
- Specify (WRW) for top finish. For upcharge, refer to finish option per product.

EDGE DETAIL

- Global's preferred (2mm flat edge) matching edge is standard.
- Optional ergo friendly edge is available at an upcharge (varies by item; see product for details).
- Rectangular tops feature rounded 2.5" radius corners.



Ergo friendly edge



2mm flat edge

LEGS

- **Group tables:** 3" diameter steel post legs and are 28" high with adjustable 3" diameter plastic glides. Each leg includes a 6" x 6" metal top plate and ships with truss head screws to connect to tops. See page 433 for available finishes.
- **Pod tables:** 1.5" diameter tube steel legs are available with adjustable levelers or dual wheel locking casters. Each leg includes top plate and hardware for mounting. See page 433 for available finishes. Optional Chrome (CHM) finish is available, upcharge applies. **Add \$79** for three-legged models or **add \$106** for four-legged models.
- **Activity tables:** 2" diameter tapered legs are available with adjustable levelers or optional locking casters. Each leg includes top plate and hardware for mounting. See page 433 for available finishes. Optional Chrome (CHM) finish is available, upcharge applies. **Add \$147.**

Group tables



3" leg dia

Pod tables

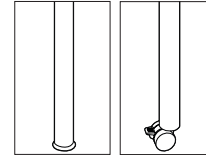

1.5" leg dia
1.5" leg dia
with caster

Activity tables

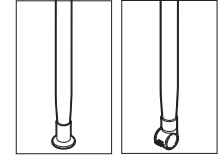

Tapered leg
with leveler
Tapered leg
with caster

CASTERS

- Pod table models ending in C, indicate legs equipped with casters. 1.5" dual wheel locking casters, available in black only.
- Activity table models ending in C, indicate legs equipped with 2" dia locking casters. Casters are black only.

GROUP TABLE with CABLE TOWER

- Constructed from thermally fused laminate with a removable access panel.
- Inside clearance of 8" x 8.6" will conceal most floor monuments but still provide easy access.
- Available on group tables ZK44848P, ZK45959P and ZK65990P only.
- Must specify cut-out option when ordering group tables to accommodate select power module. Power modules sold separately.
- Available in Black (BLK), Brushed Cobalt (BRC) or Designer White (DWT) finish.

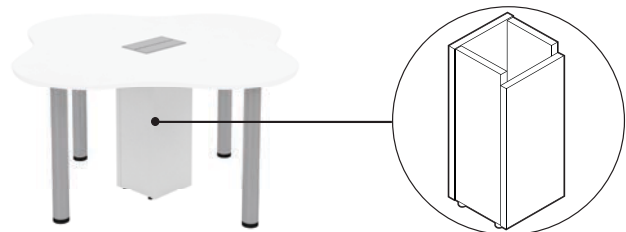

Cable tower

1. SPECIFY MODEL NUMBER

2. SPECIFY TOP FINISH

Thermally Fused and High Pressure Laminate Finishes

ACJ Absolute Acajou	CMB Clear Maple	NGL Noce Grigio	WHE Walnut Heights
ASN Asian Night	CGY Custom Grey	NEL Noce Leggero	WHC White Chocolate
AWC Avant Cherry	DES Dark Espresso	NML Noce Medio	WCR Winter Cherry
AWH Avant Honey	DWT Designer White	OTM Quartered Mahogany	WRW Writable surface*
BLK Black	FAS Fashionista	SBY Sheer Beauty	
BZD Blizzard	FCL First Class	SDT Stonedust	
BRC Brushed Cobalt	NBL Noce Biondo	SOG Storm Grey	

*Upcharge varies by product as noted on the individual product pages.
 **Select edge finish separately from above (see step #3).

Upcharge varies for high pressure laminate by product. Refer to products for details.

3. SPECIFY EDGE FINISH

2mm Thick Edgebanding

AAE Absolute Acajou	CME Clear Maple	NGL Noce Grigio
ASE Asian Night	CGY Custom Grey	NEL Noce Leggero
ACE Avant Cherry	DEE Dark Espresso	NML Noce Medio
AHE Avant Honey	DWE Designer White	OTM Quarter Mahogany
BLK Black	DJN Dijon	SAR Scarlet
BZD Blizzard	FAS Fashionista	SHW Shadow
BRC Brushed Cobalt	FCL First Class	SBY Sheer Beauty
BZB Buzz Blue	FOG Fog	SDT Stonedust
CCT Cactus	LAB Latte	SOG Storm Grey
CRO Carrot	NBL Noce Biondo	WHE Walnut Heights

**Ergo Friendly Edge Finishes
(optional - upcharge applies)**

EBL Black
ECF Latte
ECG Charcoal Grey
EDW Designer White
EGR Grey

4. SPECIFY LEG FINISH

Legs

Table type	TBL	TBZ	TCC	TCR	TIV	TDW	TDJ	TEG	TFO	TFR	TIN	TKA	TLA	TMO	TNE	TSN	TSR	TSH	TOA	TTU	CHM	
Pod	•	•	•	•	•	•	•	•	•	•	•	•	•	•	•	•	•	•	•	•	•	•
Group	•	•	•	•	•	•	•	•	•	•	•	•	•	•	•	•	•	•	•	•	•	N/A
Activity	•	•	•	•	•	•	•	•	•	•	•	•	•	•	•	•	•	•	•	•	•	•
Flip-top	N/A	N/A	N/A	N/A	N/A	N/A	N/A	N/A	N/A	N/A	N/A	N/A	N/A	N/A	N/A	N/A	N/A	N/A	N/A	N/A	•	N/A

Note: Leg finish is not optional on flip-top tables, available in Tungsten (TTU) only.

N/A = not available

5. SPECIFY CABLE TOWER FINISH - ZK44848P, ZK45959P and ZK65990P only

Cable Tower Finishes

BLK Black	BRC Brushed Cobalt	DWT Designer White
------------------	---------------------------	---------------------------

6. SPECIFY CUT-OUT OPTION - remember to order power module separately

POWER BLOCK AND CUT-OUT OPTIONS

- A power block delivers power/data to the table surface.
- Power block modules must be ordered separately and available for models ZK44848P, ZK45959P and ZK65990P only.
- Must specify the power block cut-out option when ordering the table.
- Optional cut-out available in the **center position** only and corresponds to select power modules. Order as **R2** or **T2**, depending on the power module ordered.
- For a custom size cut-out (must be in center position), please contact Customer Service.
- Select power block option on pages 469-470.

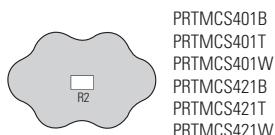

PRTMCS401B
 PRTMCS401T
 PRTMCS401W
 PRTMCS421B
 PRTMCS421T
 PRTMCS421W



PRTMCD602B
 PRTMCD602T
 PRTMCD602W
 PRTMCD622B
 PRTMCD622T
 PRTMCD622W
 PRTMCD642B
 PRTMCD642T
 PRTMCD642W

- Match power block desired with cut-out code and location from above grid.
- Example: For power block module # PRTMCS401B, specify cut-out option R2.

MODPOWER DAISY-CHAIN SOLUTION

- Add flexible power and USB charging to select Zook tables. Connect up to four units with a single corded infeed with NEMA plug.
- ModPower units are sold separately, refer to Productivity Solutions page 473.
- Begin run with a starter unit which includes a corded infeed. Add additional middle or end units as required. Middle and end units are equipped with connecting cables.
- On-surface modules clamp on or screw mount to the table tops.
- In-surface modules require table top cut-outs for mounting:
 - Specify cut-out option **MPS** for a single cut-out to accommodate one ModPower in-surface unit (cut-out will be centered on the approach side) for **ZKRxxxx(L/C)**, **ZKFR3024*** and **ZKFR6024***. Add **\$91**.
 - Specify cut-out option **MPD** for two cut-outs in the left and right positions, 15" from ends to center of unit on the approach side for **ZKR54xx(L/C)**, **ZKR60xx(L/C)**, **ZKR72xx(L/C)** and **ZKFR6024***. Add **\$183**.

*Note: not for use with Zook flip-top tables if optional modesty panel is specified.

4 TO 6-PERSON GROUP TABLES

MODEL #	DIMENSIONS	WT/LB.	CUBIC FT.	LIST PRICE	HP ADD	ERGO EDGE ADD	WRW
---------	------------	--------	-----------	------------	--------	---------------	-----

W x D x H

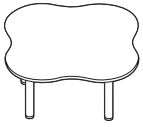

4-Person Table, 20”H

ZK4484820	48 x 48 x 20	92	7.1	\$1015	\$285	\$147	\$296
ZK4595920	59 x 59 x 20	123	9	\$1059	\$355	\$181	\$459

4-person table includes top and four steel post legs. Top includes factory installed metal inserts for solid and secure leg connections. Legs are 3” in diameter x 19” high each with an adjustable 3” diameter plastic glide and a 6” x 6” metal top plate. Shipped easy to assemble in 5 cartons.



4-Person Table, 29”H

ZK44848	48 x 48 x 29	215	7.1	\$1053	\$279	\$132	\$312
ZK45959	59 x 59 x 29	220	9.2	\$1079	\$339	\$173	\$471

4-person table includes top and four steel post legs. Top includes factory installed metal inserts for solid and secure leg connections. Legs are 3” in diameter x 28” high each with an adjustable 3” diameter plastic glide and a 6” x 6” metal top plate. Shipped easy to assemble in 5 cartons.

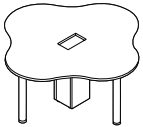

4-Person Table w/Cable Tower, 29”H*

ZK44848P	48 x 48 x 29	265	8.9	\$1437	\$279	\$132	\$312
ZK45959P	59 x 59 x 29	270	11	\$1461	\$339	\$173	\$471

4-person table includes top, four steel post legs and cable tower. Top includes factory installed metal inserts for solid and secure leg connections. Legs are 3” in diameter x 28” high each with an adjustable 3” diameter plastic glide and a 6” x 6” metal top plate. Shipped easy to assemble in 6 cartons. For power block options, see pages 469-470.

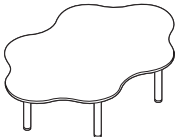

6-Person Table, 20”H

ZK6599020	90 x 59 x 20	247.5	14	\$1630	\$624	\$229	\$741
-----------	--------------	-------	----	---------------	--------------	--------------	--------------

6-person table includes top and seven steel post legs. Top includes factory installed metal inserts for solid and secure leg connections. Legs are 3” in diameter x 19” high each with an adjustable 3” diameter plastic glide and a 6” x 6” metal top plate. Shipped easy to assemble in 8 cartons.

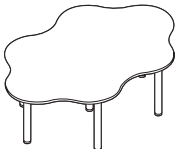

6-Person Table, 29”H

ZK65990	90 x 59 x 29	245	13.5	\$1668	\$595	\$252	\$781
---------	--------------	-----	------	---------------	--------------	--------------	--------------

6-person table includes top and seven steel post legs. Top includes factory installed metal inserts for solid and secure leg connections. Legs are 3” in diameter x 28” high each with an adjustable 3” diameter plastic glide and a 6” x 6” metal top plate. Shipped easy to assemble in 8 cartons.

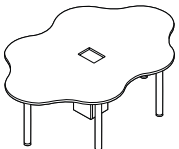

6-Person Table w/Cable Tower, 29”H*

ZK65990P	90 x 59 x 29	295	15.3	\$1976	\$595	\$252	\$781
----------	--------------	-----	------	---------------	--------------	--------------	--------------

6-person table includes top, six steel post legs and cable tower. Top includes factory installed metal inserts for solid and secure leg connections. Legs are 3” in diameter x 28” high with an adjustable 3” diameter plastic glide and a 6” x 6” metal top plate. Shipped easy to assemble in 8 cartons. For power block options, see pages 469-470.

Required specifications

Top finish
Edge finish
Leg finish

Optional specifications

HP laminate
Ergo friendly edge and finish
Power block cut-out*

Accessories

Power block*

POD TABLES

Sample pod table configurations

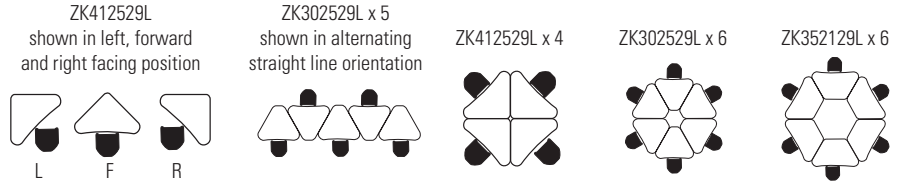

POD TABLES - 29" HIGH



Small Pod Table w/3 Legs

MODEL #	DIMENSIONS W x D x H	WT/LB.	CUBIC FT.	LIST PRICE	HP ADD	ERGO EDGE ADD	WRW
ZK302529L	30 x 24.6 x 29	37	2.01	\$344	\$61	\$62	\$143

Triangular table with three round tube 18 gauge steel legs. Can be used individually, can alternate front-to-back in a straight row, or can be arranged in groups of six to create a round table effect. Top includes factory installed metal inserts for solid and secure leg connections. Legs are 1.5" in diameter x 28" high with adjustable levelers. Shipped easy to assemble in 4 cartons, top separate from legs (legs individually packed).



Medium Pod Table w/4 Legs

ZK352129L	35 x 20.9 x 29	41	2.43	\$433	\$75	\$68	\$142
-----------	----------------	----	------	-------	------	------	-------

Trapezoid table with four round tube 18 gauge steel legs. Can be used individually or can be arranged in groups of six to create a round table effect. Top includes factory installed metal inserts for solid and secure leg connections. Legs are 1.5" in diameter x 28" high with adjustable levelers. Shipped easy to assemble in 5 cartons, top separate from legs (legs individually packed).



Large Pod Table w/3 Legs

ZK412529L	41 x 25.7 x 29	48	2.26	\$444	\$92	\$85	\$164
-----------	----------------	----	------	-------	------	------	-------

Triangular table with three round tube 18 gauge steel legs. Can be used individually or can be arranged in groups of four to create a square table effect. Top includes factory installed metal inserts for solid and secure leg connections. Legs are 1.5" in diameter x 28" high with adjustable levelers. Shipped easy to assemble in 4 cartons, top separate from legs (legs individually packed).

POD TABLES - 32" HIGH



Medium Pod Table w/4 Legs

ZK352132L	35 x 20.9 x 32	41	2.59	\$440	\$75	\$68	\$142
-----------	----------------	----	------	-------	------	------	-------

ADA compliant table with four round tube 18 gauge steel legs. Can be used individually or can be arranged in groups of six to create a round table effect. Top includes factory installed metal inserts for solid and secure leg connections. Legs are 1.5" in diameter x 31" high with adjustable levelers. Shipped easy to assemble in 5 cartons, top separate from legs (legs individually packed).

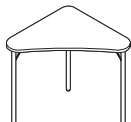

Large Pod Table w/3 Legs

ZK412532L	41 x 25.7 x 32	48	2.38	\$450	\$92	\$85	\$164
-----------	----------------	----	------	-------	------	------	-------

ADA compliant table with three round tube 18 gauge steel legs. Can be used individually or can be arranged in groups of four to create a square table effect. Top includes factory installed metal inserts for solid and secure leg connections. Legs are 1.5" in diameter x 31" high with adjustable levelers. Shipped easy to assemble in 4 cartons, top separate from legs (legs individually packed).

Required specifications

Top finish
Edge finish
Leg finish

Optional specifications

HP laminate
Ergo friendly edge and finish

MOBILE POD TABLES - 29" HIGH

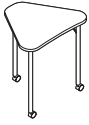

Small Mobile Pod Table w/3 Legs

MODEL #	DIMENSIONS W x D x H	WT/LB.	CUBIC FT.	LIST PRICE	HP ADD	ERGO EDGE ADD	WRW
ZK302529C	30 x 24.6 x 29	37	2.01	\$374	\$61	\$62	\$143

Triangular table with three round tube 18 gauge steel legs. Can be used individually, can alternate front-to-back in a straight row, or can be arranged in groups of six to create a round table effect. Top includes factory installed metal inserts for solid and secure leg connections. Legs are 1.5" in diameter x 28" high with 1.5" dual wheel locking casters. Shipped easy to assemble in 4 cartons, top separate from legs (legs individually packed).



Medium Mobile Pod Table w/4 Legs

ZK352129C	35 x 20.9 x 29	41	2.43	\$470	\$75	\$68	\$142
-----------	----------------	----	------	--------------	-------------	-------------	--------------

Trapezoid table with four round tube 18 gauge steel legs. Can be used individually or can be arranged in groups of six to create a round table effect. Top includes factory installed metal inserts for solid and secure leg connections. Legs are 1.5" in diameter x 28" high with 1.5" dual wheel locking casters. Shipped easy to assemble in 5 cartons, top separate from legs (legs individually packed).



Large Mobile Pod Table w/3 Legs

ZK412529C	41 x 25.7 x 29	48	2.26	\$474	\$92	\$85	\$164
-----------	----------------	----	------	--------------	-------------	-------------	--------------

Triangular table with three round tube 18 gauge steel legs. Can be used individually or can be arranged in groups of four to create a square table effect. Top includes factory installed metal inserts for solid and secure leg connections. Legs are 1.5" in diameter x 28" high with 1.5" dual wheel locking casters. Shipped easy to assemble in 4 cartons, top separate from legs (legs individually packed).

RECTANGULAR TABLES - 29" HIGH

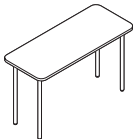

Rectangular Table, 20" Deep

ZKR3020L	30 x 20 x 29	49	2.56	\$419	\$97	\$69	\$131
ZKR3620L	36 x 20 x 29	50	2.68	\$433	\$113	\$77	\$141
ZKR4820L	48 x 20 x 29	57	2.98	\$477	\$153	\$94	\$160
ZKR5420L	54 x 20 x 29	63	3.18	\$557	\$172	\$103	\$168
ZKR6020L	60 x 20 x 29	69	3.28	\$576	\$191	\$110	\$177
ZKR7220L	72 x 20 x 29	84	3.58	\$633	\$230	\$127	\$196

Table with four round tube 18 gauge steel legs. Legs are 1.5" in diameter x 28" high with adjustable levelers. Top features 2.5" radius rounded corners and includes factory installed metal inserts for solid and secure leg connections. Tables 54" and wider include support channel. Shipped easy to assemble in 5 cartons, top separate from legs (legs individually packed).

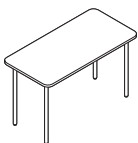

Rectangular Table, 24" Deep

ZKR3024L	30 x 24 x 29	50	2.78	\$424	\$113	\$75	\$141
ZKR3624L	36 x 24 x 29	52	2.88	\$457	\$140	\$83	\$151
ZKR4824L	48 x 24 x 29	58	3.28	\$508	\$184	\$99	\$174
ZKR5424L	54 x 24 x 29	64	3.38	\$591	\$207	\$108	\$185
ZKR6024L	60 x 24 x 29	70	3.58	\$615	\$230	\$116	\$196
ZKR7224L	72 x 24 x 29	85	3.98	\$675	\$275	\$132	\$218

Table with four round tube 18 gauge steel legs. Legs are 1.5" in diameter x 28" high with adjustable levelers. Top features 2.5" radius rounded corners and includes factory installed metal inserts for solid and secure leg connections. Tables 54" and wider include support channel. Shipped easy to assemble in 5 cartons, top separate from legs (legs individually packed).

Required specifications

Top finish
Edge finish
Leg finish

Optional specifications

HP laminate
Ergo friendly edge and finish

MOBILE RECTANGULAR TABLES - 29" HIGH

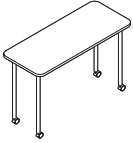

Mobile Rectangular Table, 20" Deep

MODEL #	DIMENSIONS W x D x H	WT/LB.	CUBIC FT.	LIST PRICE	HP ADD	ERGO EDGE ADD	WRW
ZKR3020C	30 x 20 x 29	50	2.56	\$458	\$97	\$69	\$131
ZKR3620C	36 x 20 x 29	51	2.68	\$470	\$113	\$77	\$141
ZKR4820C	48 x 20 x 29	58	2.98	\$515	\$153	\$94	\$160
ZKR5420C	54 x 20 x 29	64	3.18	\$594	\$172	\$103	\$168
ZKR6020C	60 x 20 x 29	70	3.28	\$615	\$191	\$110	\$177
ZKR7220C	72 x 20 x 29	85	3.58	\$672	\$230	\$127	\$196

Table with four round tube 18 gauge steel legs. Legs are 1.5" in diameter x 28" high with 1.5" dual wheel locking casters. Top features 2.5" radius rounded corners and includes factory installed metal inserts for solid and secure leg connections. Tables 54" and wider include support channel. Shipped easy to assemble in 5 cartons, top separate from legs (legs individually packed).

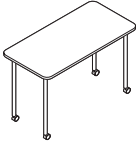

Mobile Rectangular Table, 24" Deep

ZKR3024C	30 x 24 x 29	51	2.78	\$461	\$113	\$75	\$141
ZKR3624C	36 x 24 x 29	53	2.88	\$492	\$140	\$83	\$151
ZKR4824C	48 x 24 x 29	59	3.28	\$547	\$184	\$99	\$174
ZKR5424C	54 x 24 x 29	65	3.38	\$628	\$207	\$108	\$185
ZKR6024C	60 x 24 x 29	71	3.58	\$653	\$230	\$116	\$196
ZKR7224C	72 x 24 x 29	86	3.98	\$714	\$275	\$132	\$218

Table with four round tube 18 gauge steel legs. Legs are 1.5" in diameter x 28" high with 1.5" dual wheel locking casters. Top features 2.5" radius rounded corners and includes factory installed metal inserts for solid and secure leg connections. Tables 54" and wider include support channel. Shipped easy to assemble in 5 cartons, top separate from legs (legs individually packed).

Required specifications

- Top finish
- Edge finish
- Leg finish

Optional specifications

- HP laminate
- Ergo friendly edge and finish

ACTIVITY TABLES

Sample activity table configurations

Straight mating edges



Curved mating edges

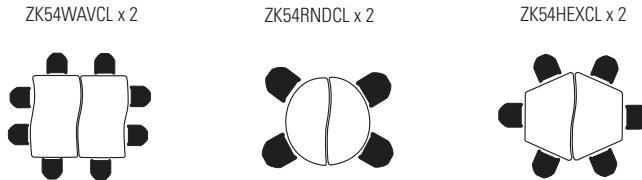

Mixed shapes
Curved mating edges shown.
Can also do the same with straight mating edge tables.

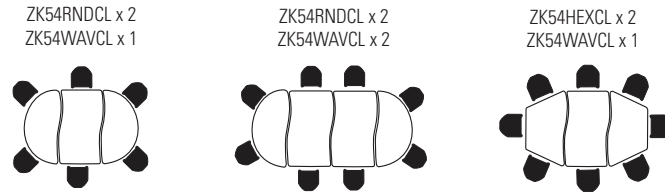

ACTIVITY TABLES - 29" HIGH, CURVED

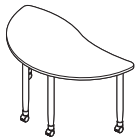

Curved Half Round Table w/Casters

MODEL #	DIMENSIONS W x D x H	WT/LB.	CUBIC FT.	LIST PRICE	HP ADD	ERGO EDGE ADD	WRW
---------	-------------------------	--------	-----------	------------	--------	---------------	-----

ZK54RNDCC	54 x 28.4 x 28.75	67.4	2.8	\$821	\$188	\$114	\$185
-----------	-------------------	------	-----	-------	-------	-------	-------

44.3" inside clearance between legs on curved edge, 22.9" on narrow depth side and 24" on other side. Dual leg position on front interferes with users sitting on ends in a racetrack configuration, oriented to seat two one either side. Top includes factory installed inserts for metal-to-metal leg connection. Shipped easy to assemble in 2 cartons, top separate from legs.

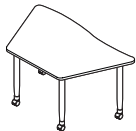

Curved Half Hex Table w/Casters

ZK54HEXCC	54 x 32.4 x 28.75	76.4	2.99	\$887	\$219	\$119	\$185
-----------	-------------------	------	------	-------	-------	-------	-------

42.9" inside clearance between legs on curved edge, 22.3" on narrow depth side and 24" on other side, 22.8" on straight end. Top includes factory installed inserts for metal-to-metal leg connection. Shipped easy to assemble in 2 cartons, top separate from legs.



Wave Table w/Casters

ZK54WAVCC	54 x 33.8 x 28.75	77.4	3.04	\$912	\$232	\$121	\$185
-----------	-------------------	------	------	-------	-------	-------	-------

44.9" inside clearance between legs on curved edges and 21.9" on sides. Top includes factory installed inserts for metal-to-metal leg connection. Shipped easy to assemble in 2 cartons, top separate from leg.

Required specifications

- Top finish
- Edge finish
- Leg finish

Optional specifications

- HP laminate
- Ergo friendly edge and finish

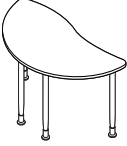
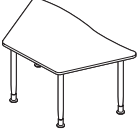
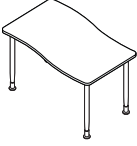
ACTIVITY TABLES - 29" HIGH, CURVED		MODEL #	DIMENSIONS	WT/LB.	CUBIC FT.	LIST PRICE	HP ADD	ERGO EDGE ADD	WRW
			W x D x H						
	Curved Half Round Table w/Levelers	ZK54RNDCL	54 x 28.4 x 28.25	67.4	2.8	\$821	\$188	\$114	\$185
44.3" inside clearance between legs on curved edge, 22.9" on narrow depth side and 24" on other side. Dual leg position on front interferes with users sitting on ends in a racetrack configuration, oriented to seat two one either side. Top includes factory installed inserts for metal-to-metal leg connection. Shipped easy to assemble in 2 cartons, top separate from leg.									
	Curved Half Hex Table w/Levelers*	ZK54HEXCL	54 x 32.4 x 28.25	76.4	2.99	\$887	\$219	\$119	\$185
42.9" inside clearance between legs on curved edge, 22.3" on narrow depth side and 24" on other side, 22.8" on straight end. Top includes factory installed inserts for metal-to-metal leg connection. Shipped easy to assemble in 2 cartons, top separate from leg.									
	Wave Table w/Levelers*	ZK54WAVCL	54 x 33.8 x 28.25	77.4	3.04	\$912	\$232	\$121	\$185
44.9" inside clearance between legs on curved edges and 21.9" on sides. Top includes factory installed inserts for metal-to-metal leg connection. Shipped easy to assemble in 2 cartons, top separate from leg.									

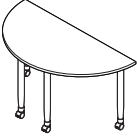
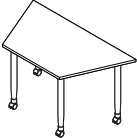
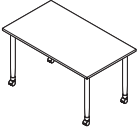
ACTIVITY TABLES - 29" HIGH, STRAIGHT		MODEL #	DIMENSIONS	WT/LB.	CUBIC FT.	LIST PRICE	HP ADD	ERGO EDGE ADD	WRW
	Straight Half Round Table w/Casters	ZK54RNDSC	54 x 28 x 28.75	67.4	2.8	\$777	\$168	N/A	\$185
44.2" inside clearance between legs on long side, 23.7" on the sides. Dual leg position at front interferes with users sitting on ends in a racetrack configuration, oriented to seat two one on either side. Top includes factory installed inserts for metal-to-metal leg connection. Shipped easy to assemble in 2 cartons, top separate from leg.									
	Straight Half Hex Table w/Casters	ZK54HEXSC	54 x 34 x 28.75	73.4	2.99	\$802	\$178	N/A	\$185
40.6" inside clearance between legs on long side, 21.4" on sides and 22.3" on short side. Top includes factory installed inserts for metal-to-metal leg connection. Shipped easy to assemble in 2 cartons, top separate from leg.									
	Rectangular Table w/Casters	ZK54RECTC	54 x 34 x 28.75	73.4	3.04	\$847	\$201	N/A	\$185
45.3" inside clearance between legs on long sides and 22.3" on short sides. Top includes factory installed inserts for metal-to-metal leg connection. Shipped easy to assemble in 2 cartons, top separate from leg.									

Required specifications

Top finish
Edge finish
Leg finish

Optional specifications

HP laminate
Ergo friendly edge and finish*

ACTIVITY TABLES - 29" HIGH, STRAIGHT



Straight Half Round Table w/Levelers

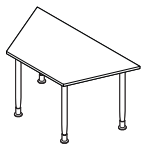

Straight Half Hex Table w/Levelers

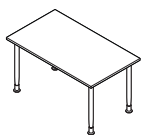

Rectangular Table w/Levelers

MODEL #	DIMENSIONS W x D x H	WT/LB.	CUBIC FT.	LIST PRICE	HP ADD	ERGO EDGE ADD	WRW
ZK54RNDSL	54 x 28 x 28.25	67.4	2.8	\$777	\$168	N/A	\$185
44.2" inside clearance between legs on long side, 23.7" on the sides. Dual leg position at front interferes with users sitting on ends in a racetrack configuration, oriented to seat two one on either side. Top includes factory installed inserts for metal-to-metal leg connection. Shipped easy to assemble in 2 cartons, top separate from leg.							
ZK54HEXSL	54 x 34 x 28.25	73.4	2.99	\$802	\$178	N/A	\$185
40.6" inside clearance between legs on long side, 21.4" on sides and 22.3" on short side. Top includes factory installed inserts for metal-to-metal leg connection. Shipped easy to assemble in 2 cartons, top separate from leg.							
ZK54RECTL	54 x 34 x 28.25	73.4	3.04	\$847	\$201	N/A	\$185
45.3" inside clearance between legs on long sides and 22.3" on short sides. Top includes factory installed inserts for metal-to-metal leg connection. Shipped easy to assemble in 2 cartons, top separate from leg.							

Required specifications

Top finish
Edge finish
Leg finish

Optional specifications

HP laminate

FLIP-TOP TABLES - 29.5" HIGH **MODEL #** **DIMENSIONS** **WT/LB.** **CUBIC FT.** **LIST PRICE** **HP ADD** **ERGO EDGE ADD** **WRW**

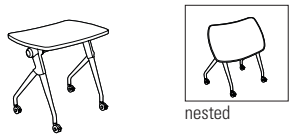

Flip-Top Table, Contoured Top

	W x D x H							
ZKFC3022	30 x 22 x 29.5	47.1	4.07	\$757	\$113	\$72	\$135	

Mobile flip-top table with smooth glide locking casters. Easy to operate twist knob with integrated thumb tab. Top includes factory installed inserts for metal-to-metal leg connection. When nested each additional table adds 5.25" to footprint needed for storage. Optional modesty (ZKFTM30) available separately. Shipped easy to assemble in 2 cartons, top and base shipped separately.

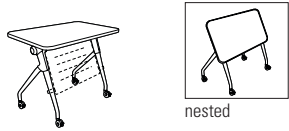

Flip-Top Table, Rectangular Top**

ZKFR3024	30 x 24 x 29.5	48	4.15	\$765	\$125	\$74	\$141	
----------	----------------	----	------	--------------	--------------	-------------	--------------	--

Mobile flip-top table with smooth glide locking casters. Easy to operate twist knob with integrated thumb tab. Top includes factory installed inserts for metal-to-metal leg connection. When nested each additional table adds 5.25" to footprint needed for storage. Optional modesty (ZKFTM30) available separately. Shipped easy to assemble in 2 cartons, top and base shipped separately.

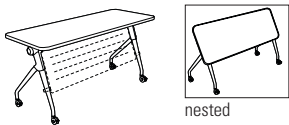

Flip-Top Table, Rectangular Top*

ZKFR6024	60 x 24 x 29.5	73.9	5.28	\$956	\$187	\$116	\$196	
----------	----------------	------	------	--------------	--------------	--------------	--------------	--

Mobile flip-top table with smooth glide locking casters. Easy to operate twist knob with integrated thumb tab. Top includes factory installed inserts for metal-to-metal leg connection. When nested each additional table adds 5.25" to footprint needed for storage. Optional modesty (ZKFTM60) available separately. Shipped easy to assemble in 3 cartons, top and base shipped separately.



Modesty Panel for ZKFC3022 / ZKFC3024

ZKFTM30	17.75 x 0.5 x 13.75	6.6	0.22	\$37	N/A	N/A	N/A	
---------	---------------------	-----	------	-------------	-----	-----	-----	--

Hardware included to attach to ZKFC3022 or ZKFR3024. Tungsten finish only. Shipped in 1 carton.

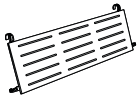

Modesty Panel for ZKFR6024

ZKFTM60	47.25 x 0.5 x 13.75	14.3	0.57	\$83	N/A	N/A	N/A	
---------	---------------------	------	------	-------------	-----	-----	-----	--

Hardware included to attach to ZKFR6024. Tungsten finish only. Shipped in 1 carton.

Required specifications

Top finish
Edge finish

Optional specifications

HP laminate
Ergo friendly edge and finish
Grommet* (FOG1, FOG2 or FOG3)
Grommet** (FOG2 only)

tables

reception and occasional



Citi 443

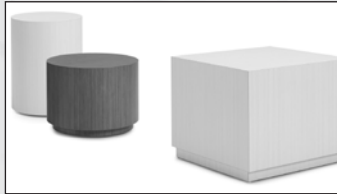

Occasional tables 445



River+ 447



Sirena 449



Wind 450





Work tables 452

CITI TABLES

Notes:

- Citi tables complement the contemporary timeless decor of many offices.
- Legs are **standard** in Tungsten (**TTU**) and also available in Black (**TBL**) finish at no upcharge. A Chrome (**CHM**) finish is available. **Add \$68.**
- Table tops are available in either tempered glass or laminate.
- Citi tables are offered in the following finishes to coordinate with Global casegoods and wood seating:

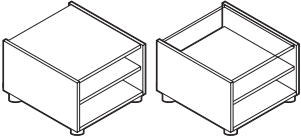
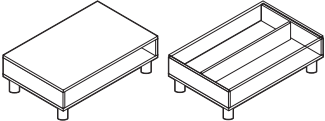
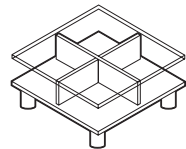
ACJ Absolute Acajou	FCL First Class
ASN Asian Night	NBL Noce Biondo
AWC Avant Cherry	NGL Noce Grigio
AWH Avant Honey	NEL Noce Leggero
BLK Black	NML Noce Medio
BZD Blizzard	QTM Quartered Mahogany
BRC Brushed Cobalt	SBY Sheer Beauty
CMB Clear Maple	SDT Stonedust
CGY Custom Grey	SOG Storm Grey
DES Dark Espresso	WHE Walnut Heights
DWT Designer White	WHC White Chocolate
FAS Fashionista	WCR Winter Cherry

CITI TABLES	MODEL #	DIMENSIONS	WT/LB.	CUBIC FT.	LIST PRICE
W x D x H					
 <p>End Table</p>	7885	20 x 24 x 20	45	6	\$715
	(laminate top)				
 <p>Coffee Table - Rectangular</p>	7886	20 x 24 x 20	52	6	\$934
	(glass top)				
Metal tubular legs. Laminate or tempered glass tops available. Shipped assembled in 1 carton.					
 <p>Coffee Table - Square</p>	7887	40 x 20 x 15	50	6.5	\$747
	(laminate top)				
	7888	40 x 20 x 15	65	6.5	\$1079
	(glass top)				
Metal tubular legs. Laminate or tempered glass tops available. Shipped assembled in 1 carton.					
	7889	33 x 33 x 15	80	8.75	\$1283
	(glass top)				
Metal tubular legs. Tempered glass top. Shipped assembled in 1 carton.					

Required specifications
 Top finish _____
 Leg finish _____

C COAT TREES

COAT TREES	MODEL #	DIMENSIONS	WT/LB.	CUBIC FT.	LIST PRICE
------------	---------	------------	--------	-----------	------------



Coat Tree

	W x D x H				
PCOS2	25 x 25 x 60	8	14.21		\$186
PCOS3	25 x 25 x 60	8	14.21		\$186

Square tube metal frame. Four Chrome double hooks. Adjustable glides. 60" high. 3 per carton (pricing and specifications are for one coat tree).

Shipped assembled in 1 carton.

- PCOS2 is finished in **Black (BLK)**.
- PCOS3 is finished in **Chrome (CHM)**.



Coat Tree

PCT	25 x 25 x 65	6	3		\$228
-----	--------------	---	---	--	--------------

Square tube wood frame. Complete with four satin brass double hooks. 65" high. Available in the following finishes: Absolute (AAM), Black (BKM), Cherry (ACM), English Oak (EOM), Espresso Cafe (ECM), Gray (HGM), Honey (AHM), Maple (AVM), Medium Walnut (MWM), Night (ASM), Sandy Beach (SBM), Shaker Cherry (SKM), Tiger Fruitwood (TFM), Tiger Mahogany (TMM), Tiger Walnut (TWM), WC Cream (WTM), White (WHM) and Winter Cherry (WCM).

1 per carton. Shipped assembled in 1 carton.

Required specifications

Finish

CYLINDER AND CUBE OCCASIONAL TABLES

Notes:

- High pressure laminate exterior with adjustable plastic glides.
- Premium cylinder tables have a flexible plywood core construction ideal for institutional and high traffic environments.
- Ideal for reception areas - colors coordinate with all Global desks, conference tables and accessories.
- Shipped assembled in 1 carton.
- WT/LB. are shipping weights.
- Available to either match or coordinate with most Global laminate desk series. Available finishes:

ACJ Absolute Acajou	FCL First Class
ASN Asian Night	NBL Noce Biondo
AWC Avant Cherry	NGL Noce Grigio
AWH Avant Honey	NEL Noce Leggero
BLK Black	NML Noce Medio
BZD Blizzard	QTM Quartered Mahogany
BRC Brushed Cobalt	SBY Sheer Beauty
CMB Clear Maple	SDT Stonedust
CGY Custom Grey	SGG Storm Grey
DES Dark Espresso	WHE Walnut Heights
DWT Designer White	WHC White Chocolate
FAS Fashionista	WCR Winter Cherry

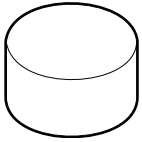
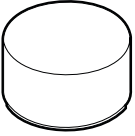
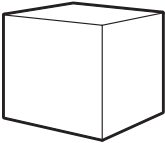
CYLINDER AND CUBE OCCASIONAL TABLES	MODEL #	DIMENSIONS	WT/LB.	CUBIC FT.	LIST PRICE
 <p>Premium Cylinder Tables</p>	W x D x H				
	CPFD1816	18 x - x 16	23	6.5	\$832
	CPFD1821	18 x - x 21	26.5	8	\$856
	CPFD2416	24 x - x 16	32.5	11	\$865
	CPFD2421	24 x - x 21	35	12.5	\$886
	CPFD3016	30 x - x 16	45.5	15.5	\$1024
	CPFD3021	30 x - x 21	48	17	\$1079
¹¹ / ₃₂ " thick flexible plywood covered in high pressure laminate. Adjustable plastic glides. Flush base.					
 <p>Premium Plinth Cylinder Tables</p>	CPPD1816	18 x - x 16	27.5	6.5	\$877
	CPPD1821	18 x - x 21	31	8	\$898
	CPPD2416	24 x - x 16	38.7	11	\$908
	CPPD2421	24 x - x 21	41.2	12.5	\$931
	CPPD3016	30 x - x 16	54.5	15.5	\$1038
	CPPD3021	30 x - x 21	57	17	\$1138
¹¹ / ₃₂ " thick flexible plywood covered in high pressure laminate. Adjustable plastic glides. Recessed base.					
 <p>Cube Table</p>	CU1816	18 x 18 x 16	26	3.3	\$502
	CU1821	18 x 18 x 21	30	4	\$544
	CU2416	24 x 24 x 16	38	6	\$526
	CU2421	24 x 24 x 21	43.5	7	\$569
	CU3016	30 x 30 x 16	50.8	6.5	\$553
	CU3021	30 x 30 x 21	57.5	8	\$595
0.75" thick plywood covered in high pressure laminate. Adjustable plastic glides. Flush base.					

Required specifications

Finish

0 OCCASIONAL TABLES

CYLINDER AND CUBE OCCASIONAL TABLES

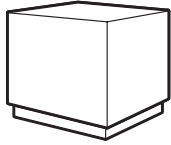

Plinth Cube Table

MODEL #	DIMENSIONS W x D x H	WT/LB.	CUBIC FT.	LIST PRICE
CUP1816	18 x 18 x 16	28	3	\$545
CUP1821	18 x 18 x 21	33.5	4	\$586
CUP2416	24 x 24 x 16	41.5	6	\$573
CUP2421	24 x 24 x 21	48	7	\$615
CUP3016	30 x 30 x 16	53.8	6.5	\$638
CUP3021	30 x 30 x 21	62.3	8	\$695

0.75" thick plywood covered in high pressure laminate. Adjustable plastic glides. **Recessed base.**

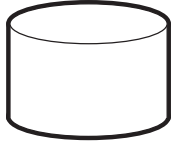

Cylinder Table

CY1816	18 x - x 16	21	3.3	\$465
CY1821	18 x - x 21	27	4.3	\$512
CY2416	24 x - x 16	33	6	\$485
CY2421	24 x - x 21	39	7	\$526
CY3016	30 x - x 16	44.5	8	\$573
CY3021	30 x - x 21	52.7	11	\$616

0.375" thick foundation board covered in high pressure laminate. Adjustable plastic glides. **Flush base.**

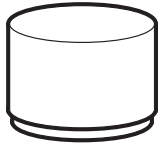

Plinth Cylinder Table

CYP1816	18 x - x 16	26.5	3.3	\$502
CYP1821	18 x - x 21	32	4.3	\$545
CYP2416	24 x - x 16	40	6	\$522
CYP2421	24 x - x 21	46	7	\$564
CYP3016	30 x - x 16	52.3	8	\$614
CYP3021	30 x - x 21	60.5	11	\$654

0.375" thick foundation board covered in high pressure laminate. Adjustable plastic glides. **Recessed base.**

Required specifications

Finish

RIVER+ TABLES

Notes:

- River+ tables are made with high pressure laminate and are offered in following finishes to coordinate with Global casegoods and wood seating:

ACJ Absolute Acajou	FCL First Class
ASN Asian Night	NBL Noce Biondo
AWC Avant Cherry	NGL Noce Grigio
AWH Avant Honey	NEL Noce Leggero
BLK Black	NML Noce Medio
BZD Blizzard	QTM Quartered Mahogany
BRC Brushed Cobalt	SBY Sheer Beauty
CMB Clear Maple	SDT Stonedust
CGY Custom Grey	SOG Storm Grey
DES Dark Espresso	WHE Walnut Heights
DWT Designer White	WHC White Chocolate
FAS Fashionista	WCR Winter Cherry

- Custom high pressure laminate finishes will be considered upon request.
- Legs are straight as standard in Chrome (**CHM**) with Black non-marking height adjustable glides.
- Legs are also available in the following finishes: Black (**TBL**), Cloud (**TIV**), Designer White (**TDW**), Fog (**TFO**), Frost (**TFR**), Kalua (**TKA**), Latte (**TLA**), Mocha (**TMO**), Nevada (**TNE**), Sand (**TSN**), Shadow (**TSH**), Toast (**TOA**) and Tungsten (**TTU**). No upcharge. Please specify.
- The unique tapered legs are made of welded steel, with each leg bolted directly to the unit frame. All units have the same standard leg height of 6.5". The leg height makes it easier to clean under the product. Legs are also available in 3" and 8" heights. All heights are available with fixed-to-floor option. Please specify:
(S6) Standard height (6.5") w/adjustable glides. No upcharge. **(F6)** Standard height (6.5"), fixed to floor. **Add \$90.**
(S3) Low (3") w/adjustable glides. No upcharge. **(F3)** Low (3"), fixed to floor. **Add \$90.**
(S8) High (8") w/adjustable glides. No upcharge. **(F8)** High (8"), fixed to floor. **Add \$90.**
- Products can be weighted to reduce the ease of movement. For additional weight options, please specify (**CW**) - see each model for available additional weight and upcharge.
- Tables can be specified with power/USB units, which include one power outlets, one double USB terminals and a Black 120" 3-prong power cord in predetermined locations - **E1**, **E2**, **F3** or **T1** as shown in the electrical illustrations below. Electrical units must be factory installed. **Add \$881** per unit.
- Power/USB units are available with either Jet Black (**J**) face plate with Black power/USB receptacles or with a White (**W**) face plate with White power/USB receptacles.
- Tamperproof fasteners (**TP**) are available. Please specify. **Add \$119.**
- Refer to the Seating price list, under lounge seating for the full range of River+ products available.

ELECTRICAL PLACEMENT

Coffee Tables

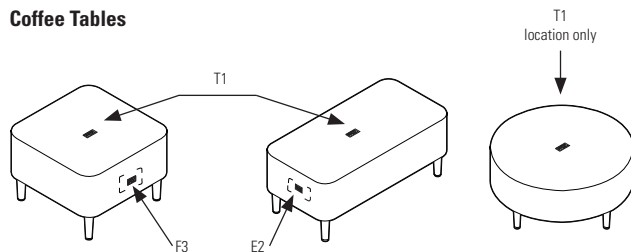

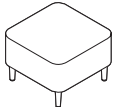
RIVER+ TABLES	MODEL#	DIMENSIONS W x D x H	WT/LB.	CUBIC FT.	LIST PRICE
 24" Square Laminate Coffee Table	R27855	24 x 24 x 17	40	10.7	\$1329
	Freestanding unit only. For additional weight, please specify (CW). Add \$533 for 36 lbs. Power/USB units can be specified in position F3 or T1 only. Add \$881.				

Required specifications

Top finish
Leg finish/height

Optional specifications

Power/USB finish
Power/USB location
Tamperproof

R RIVER+ TABLES

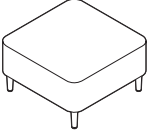
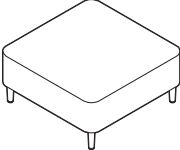
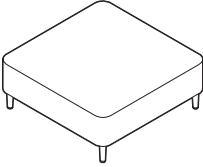
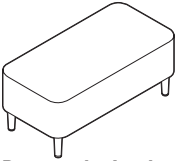
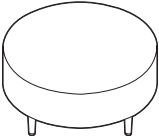
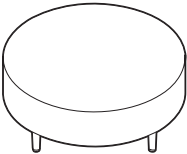
RIVER+ TABLES	MODEL #	DIMENSIONS W x D x H	WT/LB.	CUBIC FT.	LIST PRICE
 <p>30" Square Laminate Coffee Table</p>	R27856	30 x 30 x 17	53	15.3	\$1392
<p>Freestanding unit only. For additional weight, please specify (CW). Add \$400 for 27 lbs. Power/USB units can be specified in position F3 or T1 only. Add \$881.</p>					
 <p>36" Square Laminate Coffee Table</p>	R27857	36 x 36 x 17	75	20.6	\$1541
<p>Freestanding unit only. No additional weight is required. Power/USB units can be specified in position F3 or T1 only. Add \$881.</p>					
 <p>42" Square Laminate Coffee Table</p>	R27858	42 x 42 x 17	115	26.7	\$1706
<p>Freestanding unit only. No additional weight is required. Power/USB units can be specified in position F3 or T1 only. Add \$881.</p>					
 <p>Rectangular Laminate Coffee Table</p>	R27859	40 x 20 x 17	55	14.2	\$1400
<p>Freestanding unit only. For additional weight, please specify (CW). Add \$267 for 18 lbs. Power/USB units can be specified in position E1, E2 or T1 only. Add \$881.</p>					
 <p>36" Dia. Round Laminate Coffee Table</p>	R27860	36 x 36 x 17	63	15.3	\$1729
<p>Freestanding unit only. For additional weight, please specify (CW). Add \$267 for 18 lbs. Power/USB units can be specified in position T1 only. Add \$881.</p>					
 <p>42" Dia. Round Laminate Coffee Table</p>	R27861	42 x 42 x 17	85	20.6	\$1889
<p>Freestanding unit only. No additional weight is required. Power/USB units can be specified in position T1 only. Add \$881.</p>					

Required specifications

Top finish
Leg finish/height

Optional specifications

Power/USB finish
Power/USB location
Tamperproof



SIRENA TABLES

Notes:

- Modern tables for reception areas, meeting rooms, and private office use.
- Sirena tables are offered in the following finishes to coordinate with Global casegoods and wood seating:

ACJ Absolute Acajou	FCL First Class
ASN Asian Night	NBL Noce Biondo
AWC Avant Cherry	NGL Noce Grigio
AWH Avant Honey	NEL Noce Leggero
BLK Black	NML Noce Medio
BZD Blizzard	QTM Quartered Mahogany
CMB Clear Maple	SBY Sheer Beauty
CGY Custom Grey	SDT Stonedust
DES Dark Espresso	WHE Walnut Heights
DWT Designer White	WHC White Chocolate
FAS Fashionista	WCR Winter Cherry

- Laminate tops are 1" thick to coordinate with Global casegoods and wood seating.
- Table legs are available in Black (TBL) or Tungsten (TTU) at no upcharge. Not available in Chrome.
- Legs are 1.5" steel tubing, tapered toward the bottom of the leg to 0.875", equipped with self-leveling pivoting steel glide.

SIRENA TABLES	MODEL#	DIMENSIONS	WT/LB.	CUBIC FT.	LIST PRICE
 <p>Coffee Table</p>  <p>Coffee Table</p>  <p>End Table</p>		W x D x H			
	3400 (laminated top)	48 x 22 x 14.5	44	17.25	\$1214
	Rectangle coffee table.				
	3401 (laminated top)	56 x 22 x 14.5	50	19	\$1346
	Rectangle coffee table.				
	3402 (laminated top)	17 x 22 x 14.5	20	7.75	\$1007
	Rectangle end table.				

Required specifications

- Top finish
- Leg finish

W WIND TABLES





WIND TABLES

Notes:

- Wind tables complement the modern decor of many offices.
- Legs are standard in Chrome (**CHM**). Also available in Black (**TBL**), Shadow (**TSH**) or Tungsten (**TTU**) finish at no upcharge.
- 1" laminate tops are offered in the following finishes to coordinate with Global casegoods and wood seating:

ACJ Absolute Acajou	FCL First Class
ASN Asian Night	NBL Noce Biondo
AWC Avant Cherry	NGL Noce Grigio
AWH Avant Honey	NEL Noce Leggero
BLK Black	NML Noce Medio
BZD Blizzard	OTM Quartered Mahogany
BRC Brushed Cobalt	SBY Sheer Beauty
CMB Clear Maple	SDT Stonedust
CGY Custom Grey	SOG Storm Grey
DES Dark Espresso	WHE Walnut Heights
DWT Designer White	WHC White Chocolate
FAS Fashionista	WCR Winter Cherry

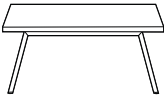
- High pressure laminate (**HPL**) tops are available at a 20% upcharge for models 3366, 3367, 3368, 3870 and 3871. Please specify HPL in addition to the finish. HPL not available for models 3878, 3879 and 3880.

WIND TABLES	MODEL #	DIMENSIONS	WT/LB.	CUBIC FT.	LIST PRICE
 End Table  Rectangular Coffee Table  Square Coffee Table  Round Table  Round Coffee Table		W x D x H			
	3366 (laminate top)	24 x 24 x 17	24	11.5	\$661
	Steel tubular base. Tops are available with a laminate finish. Shipped assembled in 1 carton.				
	3367 (laminate top)	48 x 20 x 15	39	16	\$886
	Steel tubular base. Tops are available with a laminate finish. Shipped assembled in 1 carton.				
3368 (laminate top)	36 x 36 x 15	50	22	\$1214	
Steel tubular base. Tops are available with a laminate finish. Shipped assembled in 1 carton.					
3870 (laminate top)	24 x 24 x 17	30	11.5	\$721	
Steel tubular base. Tops are available with a laminate finish. Shipped assembled in 1 carton.					
3871 (laminate top)	36 x 36 x 15	50	22	\$1115	
Steel tubular base. Tops are available with a laminate finish. Shipped assembled in 1 carton.					

Required specifications
Top finish

Optional specifications
Edge detail
Leg finish

WIND TABLES **MODEL #** **DIMENSIONS** **WT/LB.** **CUBIC FT.** **LIST PRICE**

W x D x H

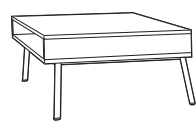

Freestanding Rectangular End Table

3878	20 x 25 x 16	30	11.5	\$1112
------	--------------	----	------	---------------

Steel tubular base. Laminate top is 5" thick with opening on front for storage and visual recess at rear. Shipped assembled in 1 carton.

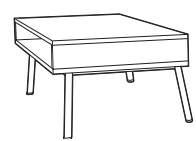

Freestanding Corner Table

3879	25 x 25 x 16	32	11.5	\$1241
------	--------------	----	------	---------------

Steel tubular base. Laminate top is 5" thick with opening on front for storage and visual recess at rear. Shipped assembled in 1 carton.

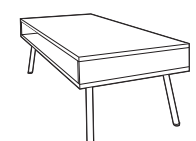

Freestanding Coffee Table

3880	54 x 20 x 15	39	16	\$1393
------	--------------	----	----	---------------

Steel tubular base. Laminate top is 5" thick with opening on front for storage and visual recess at rear. Shipped assembled in 1 carton.

Required specifications

Top finish

Optional specifications

Edge detail

Leg finish

W WORK TABLES

WORK TABLES

Notes:

- Work tables are offered in the following top finishes to coordinate with Global casegoods and wood seating:

ACJ Absolute Acajou	FCL First Class
ASN Asian Night	NBL Noce Biondo
AWC Avant Cherry	NGL Noce Grigio
AWH Avant Honey	NEL Noce Leggero
BLK Black	NML Noce Medio
BZD Blizzard	QTM Quartered Mahogany
BRC Brushed Cobalt	SBY Sheer Beauty
CMB Clear Maple	SDT Stonedust
CGY Custom Grey	SOG Storm Grey
DES Dark Espresso	WHE Walnut Heights
DWT Designer White	WHC White Chocolate
FAS Fashionista	WCR Winter Cherry

- T-mold (**TM**) edging available in Black (**BLK**), please specify. No upcharge.
- Legs are available in Chrome (**CHM**) or Black (**TBL**).

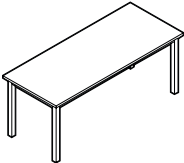
WORK TABLES	MODEL #	DIMENSIONS	WT/LB.	CUBIC FT.	LIST PRICE
		W x D x H			
 <p>Work Tables</p>	AT7236	72 x 36 x 29	110	6	\$784
	AT7230	72 x 30 x 29	100	5	\$616
	AT6030	60 x 30 x 29	90	5	\$540
<p>1" high performance thermally fused laminate with self edge top. Black metal skirt. Rectangle top with metal legs and leveling glides. Self edge is standard. Black legs are optional, no upcharge. Shipped easy to assemble in 1 carton.</p>					

Required specifications

Top finish
Leg finish

Optional specifications

HP laminate

productivity solutions



Productivity Solutions 454





Productivity Solutions by Global is a comprehensive series of ergonomically sound products, naturally connecting people with technology to enhance comfort and productivity. Designed to fit you and your technology and fully integrate with Global products to create complete office solutions that meet the needs of today's diverse workplaces.

Designed with human capabilities and comfort in mind, Productivity Solutions by Global provide a good fit for today's workers and meet or exceed ergonomics standards, guidelines and ANSI/BIFMA standards for performance, durability and safety.

FIT = move + match + support

Features and Benefits

- Electric height adjustable table with 18.51" height range.
- Manual height adjustable table has counterbalanced spring mechanism.
- Five keyboard support mechanisms.
- Four keyboard trays.
- New monitor arm options.
- Wire management and power/data options.
- For environmental certifications, please visit globalfurnituregroup.com.



Monitor arm



Power/data module



Lift-N-lock keyboard mechanism



Electric height adjustable desk



Manual height adjustable desk

MANUAL HEIGHT ADJUSTABLE TABLES

- Manually operated height adjustable tables with counterbalanced spring mechanism.
- Exceptional ergonomic alternative to traditional desking.
- Sit-stand design promotes increased circulation, improving performance and comfort.
- Can be used alone or in conjunction with Global desking products.
- Tops and bases sold separately.

Please note: Global desk tops are 1" or 1.5" thick.

TOP FINISHES

ACJ Absolute Acajou	FCL First Class
ASN Asian Night	NBL Noce Biondo
AWC Avant Cherry	NGL Noce Grigio
AWH Avant Honey	NEL Noce Leggero
BLK Black	NML Noce Medio
BZD Blizzard	QTM Quartered Mahogany
BRC Brushed Cobalt	SBY Sheer Beauty
CMB Clear Maple	SDT Stonedust
CGY Custom Grey	SOG Storm Grey
DES Dark Espresso	WHE Walnut Heights
DWT Designer White	WHC White Chocolate
FAS Fashionista	WCR Winter Cherry

CONSTRUCTION

- 1" thick tops constructed of 45 lb. density particle board with high performance thermally fused laminate and Global's preferred matching edging.

DIMENSIONS

- When designing workstations, leave 1" clearance on either side to prevent finger pinch.

EDGE

- 2mm edge in matching color.

BASE

- Heavy duty steel formed legs with radius detail are available in Black only.
- Easy to reach tension control supports loads up to 100 lbs.
- Environmentally friendly, recyclable epoxy powder coating provides a durable finish. Black only.
- Black plastic leveling glides offer 0.5" adjustability.

MECHANISM

- Counterbalanced height adjustable base supports weights up to 100 lbs.
- Height range from floor to underside of modesty shroud is 17" when surface height is 26".
- 7 year warranty.

SHIPPING

- Easy to assemble with Phillips or Robertson screwdriver.

GROMMETS

- Additional grommets available in standard worksurface locations (left, center or right).
- Order as: **FOG1, FOG2 or FOG3. Add \$91.**
- Grommet hole dimensions are 3.25" wide x 1.875" deep.

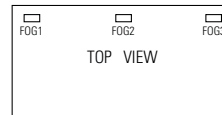

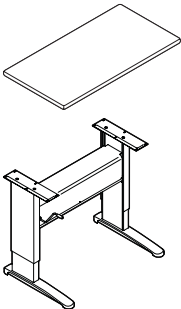
MANUAL HEIGHT ADJUSTABLE TABLES	MODEL #	DIMENSIONS	WT/LB.	CUBIC FT.	LIST PRICE	HP ADD	
 <p>Rectangular Table</p>	W x D x H						
	Tops						
	HTM2446T	46 x 24 x 1	32	1.5	\$210	\$68	
	HTM2458T	58 x 24 x 1	40	2	\$238	\$110	
	HTM3046T	46 x 30 x 1	40	2	\$238	\$99	
HTM3058T	58 x 30 x 1	50	2.5	\$294	\$131		
Base							
KEZLIFT	35.93 x 24 x 25.53	88	5.4	\$1708	N/A		
Tops (HTMXXXXT) sold separately from base (KEZLIFT). Paddle activated height adjustable base. Height adjustable from 26" to 46". Keyboard tray and mechanism not necessary. Easy to assemble.							
KEZLCSTR	2 x 2 x 2.5	3	0.17	\$20	N/A		
Pack of four locking casters. Interchangeable on site with levelers on KEZLIFT base. Suitable for hard floors.							

Required specifications
Finish

Optional specifications
HP laminate (tops)
Grommet

PET FELT PRIVACY SCREEN AND MODESTY PANELS

- PET Felt privacy screens and modesty panels add seated privacy to open plan deskings or tables.
- 9mm thick PET Felt offered in 9 finishes: Black (**BLK**), Brick (**BRI**), Denim (**DEN**), Harvest (**HVT**), Graphite (**GPH**), Mist (**MTS**), Pewter (**PWT**), Shamrock (**SHR**) and White (**WHT**).
- Made from 100% PET (polyester) fiber with a high content of post-recycled material (50%), free of added chemicals, binders and adhesives.
- Lightweight material is tackable, impact and tear resistant, bacteria resistant, moisture resistant, and installation friendly.
- Variation in fiber mix and color are inherent to the character of the product.
- Requires a free clear edge of 1.5"D x length of privacy screen or modesty panel for mounting.
- Privacy screen upmount brackets adapt to 1" thick TFL or 1¹/₁₆" thick HPL tops and do not mar the top surface.

PET FELT PRIVACY SCREEN

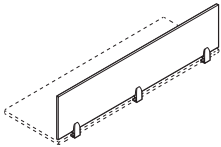

PET Felt Privacy Screen - 1pk.

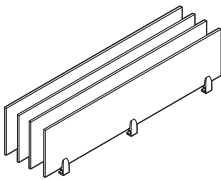

PET Felt Privacy Screen - 4pk.

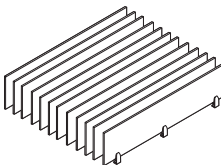

PET Felt Privacy Screen - 12pk.

MODEL #	DIMENSIONS	WT/LB.	CUBIC FT.	LIST PRICE
---------	------------	--------	-----------	------------

W x D x H

PT9PP3013-1	30 x 0.36 x 12.5	2.1	0.6	\$184
PT9PP3613-1	36 x 0.36 x 12.5	2.4	0.7	\$195
PT9PP4213-1	42 x 0.36 x 12.5	2.6	0.8	\$261
PT9PP4813-1	48 x 0.36 x 12.5	3.3	0.9	\$272
PT9PP5413-1	54 x 0.36 x 12.5	3.6	1	\$340
PT9PP6013-1	60 x 0.36 x 12.5	3.8	1.1	\$350
PT9PP6613-1	66 x 0.36 x 12.5	4.5	1.3	\$416
PT9PP7213-1	72 x 0.36 x 12.5	4.8	1.4	\$426
PT9PP7813-1	78 x 0.36 x 12.5	5	1.5	\$437

PET Felt Privacy Screen available in nine finishes, please specify finish. 2, 3 or 4 clamps are included depending on width. Clamps available in satin anodized finish only.

- Up to 42" w - 2 clamps per
- 48"-60" w - 3 clamps per
- 66"-78" w - 4 clamps per

PT9PP3013-4	30 x 0.36 x 12.5	7.6	0.6	\$701
PT9PP3613-4	36 x 0.36 x 12.5	8.6	0.7	\$741
PT9PP4213-4	42 x 0.36 x 12.5	9.5	0.8	\$1001
PT9PP4813-4	48 x 0.36 x 12.5	11.9	1	\$1041
PT9PP5413-4	54 x 0.36 x 12.5	12.8	1.1	\$1305
PT9PP6013-4	60 x 0.36 x 12.5	13.8	1.2	\$1340
PT9PP6613-4	66 x 0.36 x 12.5	16.2	1.3	\$1600
PT9PP7213-4	72 x 0.36 x 12.5	17.1	1.4	\$1636
PT9PP7813-4	78 x 0.36 x 12.5	18	1.5	\$1669

Pack of four PET Felt Privacy Screens available in nine finishes, please specify finish. 2, 3 or 4 clamps are included depending on width. Clamps available in satin anodized finish only.

- Up to 42" w - 2 clamps per
- 48"-60" w - 3 clamps per
- 66"-78" w - 4 clamps per

PT9PP3013-12	30 x 0.36 x 12.5	21.6	1.9	\$2060
PT9PP3613-12	36 x 0.36 x 12.5	24.3	2.3	\$2171
PT9PP4213-12	42 x 0.36 x 12.5	26.9	2.6	\$2945
PT9PP4813-12	48 x 0.36 x 12.5	33.8	3	\$3052
PT9PP5413-12	54 x 0.36 x 12.5	36.4	3.4	\$3837
PT9PP6013-12	60 x 0.36 x 12.5	39	3.7	\$3933
PT9PP6613-12	66 x 0.36 x 12.5	45.9	4.2	\$4706
PT9PP7213-12	72 x 0.36 x 12.5	48.5	4.5	\$4801
PT9PP7813-12	78 x 0.36 x 12.5	51.1	4.9	\$4897

Pack of twelve PET Felt Privacy Screens available in nine finishes, please specify finish. 2, 3 or 4 clamps are included depending on width. Clamps available in satin anodized finish only.

- Up to 42" w - 2 clamps per
- 48"-60" w - 3 clamps per
- 66"-78" w - 4 clamps per

Required specifications

Finish

PET FELT MODESTY PANEL **MODEL #** **DIMENSIONS** **WT/LB.** **CUBIC FT.** **LIST PRICE**

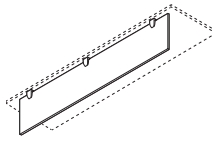

PET Felt Modesty Panel - 1 pk.

	W x D x H			
PT9MP3013-1	30 x 0.36 x 12.5	2.1	0.6	\$160
PT9MP3613-1	36 x 0.36 x 12.5	2.4	0.7	\$172
PT9MP4213-1	42 x 0.36 x 12.5	2.6	0.8	\$227
PT9MP4813-1	48 x 0.36 x 12.5	3.3	0.9	\$238
PT9MP5413-1	54 x 0.36 x 12.5	3.6	1.03	\$305
PT9MP6013-1	60 x 0.36 x 12.5	3.8	1.1	\$315
PT9MP6613-1	66 x 0.36 x 12.5	4.5	1.3	\$371
PT9MP7213-1	72 x 0.36 x 12.5	4.8	1.4	\$381
PT9MP7813-1	78 x 0.36 x 12.5	5	1.5	\$390

PET Felt Modesty Panel available in nine finishes, please specify finish. 2, 3 or 4 clamps are included depending on width. Clamps available in satin anodized finish only. **Specify a nominal size 6" shorter than worksurface size.**

- Up to 42"w - 2 clamps per
- 48"-60"w - 3 clamps per
- 66"-78"w - 4 clamps per

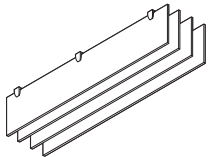

PET Felt Modesty Panel - 4 pk.

PT9MP3013-4	30 x 0.36 x 12.5	7.6	0.6	\$611
PT9MP3613-4	36 x 0.36 x 12.5	8.6	0.7	\$651
PT9MP4213-4	42 x 0.36 x 12.5	9.5	0.8	\$866
PT9MP4813-4	48 x 0.36 x 12.5	11.9	1	\$906
PT9MP5413-4	54 x 0.36 x 12.5	12.8	1.1	\$1169
PT9MP6013-4	60 x 0.36 x 12.5	13.8	1.2	\$1205
PT9MP6613-4	66 x 0.36 x 12.5	16.2	1.3	\$1420
PT9MP7213-4	72 x 0.36 x 12.5	17.1	1.4	\$1455
PT9MP7813-4	78 x 0.36 x 12.5	18	1.5	\$1490

Pack of four PET Felt Modesty Panels available in nine finishes, please specify finish. 2, 3 or 4 clamps are included depending on width. Clamps available in satin anodized finish only. **Specify a nominal size 6" shorter than worksurface size.**

- Up to 42"w - 2 clamps per
- 48"-60"w - 3 clamps per
- 66"-78"w - 4 clamps per

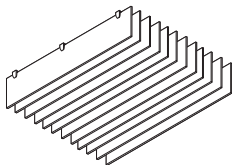

PET Felt Modesty Panel - 12 pk.

PT9MP3013-12	30 x 0.36 x 12.5	21.6	1.9	\$1790
PT9MP3613-12	36 x 0.36 x 12.5	24.3	2.3	\$1902
PT9MP4213-12	42 x 0.36 x 12.5	26.9	2.6	\$2538
PT9MP4813-12	48 x 0.36 x 12.5	33.8	3	\$2646
PT9MP5413-12	54 x 0.36 x 12.5	36.4	3.4	\$3432
PT9MP6013-12	60 x 0.36 x 12.5	39	3.7	\$3527
PT9MP6613-12	66 x 0.36 x 12.5	45.9	4.2	\$4164
PT9MP7213-12	72 x 0.36 x 12.5	48.5	4.5	\$4260
PT9MP7813-12	78 x 0.36 x 12.5	51.1	4.9	\$4356

Pack of twelve PET Felt Modesty Panels available in nine finishes, please specify finish. 2, 3 or 4 clamps are included depending on width. Clamps available in satin anodized finish only. **Specify a nominal size 6" shorter than worksurface size.**

- Up to 42"w - 2 clamps per
- 48"-60"w - 3 clamps per
- 66"-78"w - 4 clamps per

Required specifications

Finish

MONITOR ARMS

- Free up valuable space on surfaces.
- Attach to any standard 1" to 1.5" thick surface with flush edge by a desk clamp or through a grommet. Mounting hardware included.
- Clamps on worksurfaces 0.5" to 2.625" thick.
- For use in grommets up to 3.5" wide.
- Built-in cable management.
- Quick connect option is standard with hole patterns to meet Video Electronics Standards Association (VESA) standards (75mm x 75mm or 100mm x 100mm).
- Monitor arm components are 100% recycled aluminum die cast material, providing stability and durability.
- Available finishes: Silver (**SIL**) standard (except where noted otherwise).

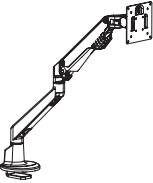
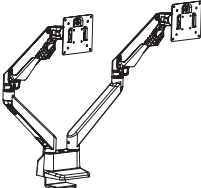
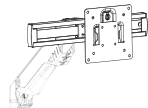
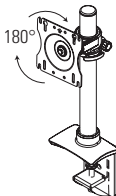
MONITOR ARMS	MODEL #	DIMENSIONS	WT/LB.	CUBIC FT.	LIST PRICE
 <p>G7 Single Monitor Arm</p>		W x D x H			
	PSMA1	- x 5.5 x 21	6.6	0.4	\$418
<p>For use with a monitor weighing 4.4 to 19.8 lbs. Adjustable counterbalance provides free floating fingertip control. Maximum of 20.5" extension from rear of desk to back of monitor, folds to 4.5". Monitor can rotate for portrait or landscape viewing with -90° to 45° tilt adjustment. 180° lockout function. Maximum monitor width of 34". Some assembly required. Tungsten finish only. Also accommodates mini slide arm PSMS.</p>					
 <p>G7 Double Monitor Arm</p>		W x D x H			
	PSMA2	- x 5.5 x 21	12.8	1	\$734
<p>For use with monitors weighing 4.4 to 19.8 lbs. Adjustable counterbalance provides free floating fingertip control. Maximum of 20.5" extension from rear of desk to back of monitor, folds to 4.5". Monitor can rotate for portrait or landscape viewing with -90° to 45° tilt adjustment. 180° lockout function. Maximum monitor width of 34" (per arm). Some assembly required. Tungsten finish only. Also accommodates mini slide arm PSMS.</p>					
 <p>G7 Mini Slide Monitor Arm</p>		W x D x H			
	PSMS	11 x 6 x 4.5	3.3	0.3	\$145
<p>The mini slide is for use with PSMA1 and PSMA2 monitor arms only. Provides 9" of lateral adjustment for the monitor and allows for better positioning of monitors when used side by side. Some assembly required. Tungsten finish only.</p> <ul style="list-style-type: none"> • If for PSMA1, order one (1) • If for PSMA2, order two (2) 					
 <p>Single Screen Pole Position</p>		W x D x H			
	MON1SPP	- x - x 13	5.8	1.2	\$263
<p>No extension arms. Supports a 20 lb. load capacity. No maximum monitor width. Minor assembly required.</p>					

Required specifications

Finish

MONITOR ARMS	MODEL #	DIMENSIONS	WT/LB.	CUBIC FT.	LIST PRICE
--------------	---------	------------	--------	-----------	------------

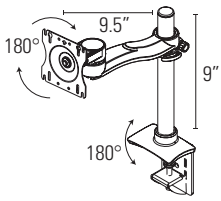

Single Screen Single Extension Arm

W x D x H					
MON1SSE	- x - x 13	6.2	1.2	\$352	

9.5" horizontal reach from center of pole to front of monitor mounting plate. Displays are able to tilt 180°, swing 180° side-to-side and rotate from landscape to portrait. Supports a 20 lb. load capacity. No maximum monitor width. Minor assembly required.

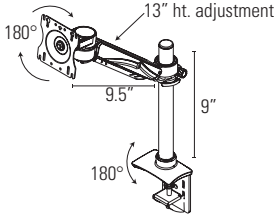

Single Screen Single Extension Arm with Height Adjustment

MON1SSEH	- x - x 6.8	7.2	1.1	\$454	
----------	-------------	-----	-----	--------------	--

Counterbalanced arm provides an additional 13" of height adjustment. Easy to use Allen wrench allows user to adjust the counterbalance mechanism for easy movement of the monitor. 9.5" horizontal reach from center of pole to front of monitor mounting plate. Displays are able to tilt 180°, swing 180° side-to-side and rotate from landscape to portrait. Supports a 20 lb. load capacity. No maximum monitor width. Minor assembly required.

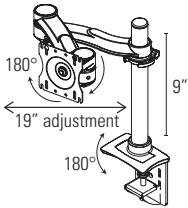

Single Screen Double Extension Arm

MON1SDE	- x - 13-24	7.5	1.2	\$442	
---------	-------------	-----	-----	--------------	--

Double extension allows 19" of horizontal back and forth movement. Arm folds back to post for more desk space. Displays are able to tilt 180°, swing 180° side-to-side and rotate from landscape to portrait. Supports a 20 lb. load capacity. No maximum monitor width. Minor assembly required.

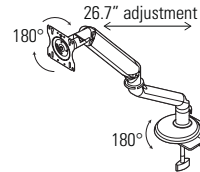

Single Screen Double Extension Arm - Light Duty

M775OLD	5.5 x 4.5-22.7 x 24.4	7.5	1.12	\$512	
---------	-----------------------	-----	------	--------------	--

For use with monitors weighing 5 to 20 lbs. Adjustable counterbalance provides free floating fingertip control. Maximum of 26.7" extension from rear of desk to back of monitor; folds to 4.5". Monitor can rotate 180° for portrait or landscape viewing with -90° to 45° tilt adjustment. Integral monitor weight adjustment gauge. Aluminum die cast construction. VESA plate edge clamp and grommet mount included. Silver finish. Some assembly required.
 • Also available in **Black finish** #M7750LDB or **White finish** #M7750LDW.

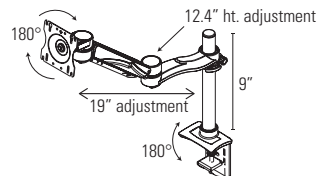

Single Screen Double Extension Arm with Height Adjustment

MON1SDEH	29.3 x 9.5 x 12.5	8.2	1.1	\$533	
----------	-------------------	-----	-----	--------------	--

Counterbalanced arm provides an additional 12.4" of height adjustment. Double extension allows 19" of horizontal back and forth movement. Easy to use Allen wrench allows user to adjust the counterbalance mechanism for easy movement of the monitor. Displays are able to tilt 180°, swing 180° side-to-side and rotate from landscape to portrait. Cable manager comes on extension arm and hides all cables. Supports a 20 lb. load capacity. No maximum monitor width. Minor assembly required.

Required specifications
 Finish

MONITOR ARMS	MODEL #	DIMENSIONS	WT/LB.	CUBIC FT.	LIST PRICE
--------------	---------	------------	--------	-----------	------------

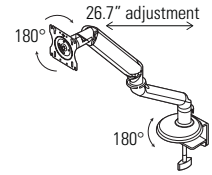

Single Screen Double Extension Arm - Medium Duty

	W x D x H				
M7755MD	5.5 x 4.5-22.7 x 24.4	7.5	1.12		\$548

For use with monitors weighing 10 to 30 lbs. Adjustable counterbalance provides free floating fingertip control. Maximum of 26.7" extension from rear of desk to back of monitor; folds to 4.5". Monitor can rotate 180° for portrait or landscape viewing with -90° to 45° tilt adjustment. Integral monitor weight adjustment gauge. Aluminum die cast construction. VESA plate edge clamp and grommet mount included. Silver finish. Some assembly required.

- Also available in **Black finish** #M7755MDB or **White finish** #M7755MDW.

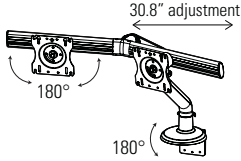

Dual Screen Double Extension Arm

M7760DSS	26 x 8.4-30.75 x 24.4	7.5	1.3		\$707
----------	-----------------------	-----	-----	--	--------------

For use with monitors weighing 6 to 28 lbs. total and maximum width of 24" diagonal. Adjustable counterbalance provides free floating fingertip control. Maximum of 30.8" extension from rear of desk to back of monitor; folds to 8.4". Monitor can rotate 180° for portrait or landscape viewing with -90° to 45° tilt adjustment. Integral monitor weight adjustment gauge. Aluminum die cast construction. VESA plate edge clamp and grommet mount included. Silver finish. Some assembly required.

- Also available in **Black finish** #M7760DSB or **White finish** #M7760DSW.

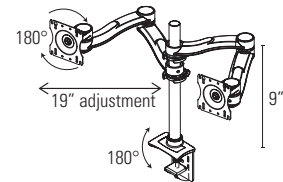

Dual Screen Double Extension Arms

MON2SDE	- x - x 12.5	10.7	1.2		\$782
---------	--------------	------	-----	--	--------------

For dual monitor applications. 32" maximum monitor width. Supports a 20 lb. load capacity per screen. Double extension arms reach out up to 19". Top of mounting pole is 12.5"H from worksurface. Easy to use Allen wrench allows user to adjust the counterbalance mechanism for easy movement of the monitor. Displays are able to tilt 180°, swing 180° side-to-side and rotate from landscape to portrait. Minor assembly required.

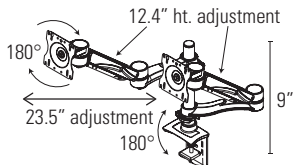

Dual Screen Double Extension Arms with Height Adjustment

MON2SDEH	- x - x 12.5	12.25	1.2		\$971
----------	--------------	-------	-----	--	--------------

For dual monitor applications. 35" maximum monitor width. Supports a 20 lb. load capacity per screen. Counterbalanced arms provide an additional 12.4" of height adjustment. Double extension arms reach out up to 23.5". Easy to use Allen wrench allows user to adjust the counterbalance mechanism for easy movement of the monitor. Both arms can be set at the same height. Displays are able to tilt 180°, swing 180° side-to-side and rotate from landscape to portrait. Cable manager comes on extension arm and hides all cables. Minor assembly required.

Required specifications
Finish

KEYBOARD TRAYS **MODEL #** **DIMENSIONS** **WT/LB.** **CUBIC FT.** **LIST PRICE**

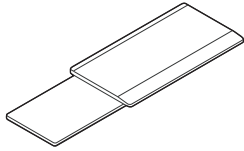

Tray with Sliding Mouse Support

	W x D x H			
KT01	21.3 x 10.5 x 2	7	0.4	\$204

Mouse surface slides below support for left or right mouse positioning. Keyboard surface is 21"W x 11"D. Mouse surface extends 9" beyond the side of the tray. Compatible with all Global keyboard mechanisms. ABS plastic tray and sliding mouse tray.

- Specify mechanism separately, see pages 462-463.

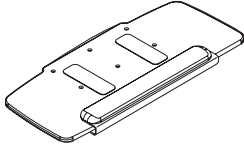

27" HDPE Tray

KT27M02	27.5 x 11.5 x 0.38	6	0.4	\$263
---------	--------------------	---	-----	--------------

Allows mouse to be easily positioned at the same height as, and to the left or right of the keyboard. Palm rest is easily removable. Includes anti-slip strips. High density polyethylene (HDPE) surface material. Self-skinned urethane (SSU) palm rest. Compatible with all Global keyboard mechanisms.

- Specify mechanism separately, see pages 462-463.

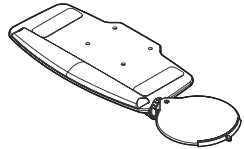

Tray with Height Adjustable Mouse Support - Black

KTMT03	23 x 11.5 x 2.8	5.8	0.6	\$284
--------	-----------------	-----	-----	--------------

Low profile tray with highly adjustable mouse support that allows the user to position the mouse surface according to their needs and preferences. Mouse support features include: height adjustment, swivel and tilt. User can easily mount on left or right side of keyboard tray, easily swivel and adjust the height position to maintain neutral postures, and independently adjust the mouse surface tilt so mouse stays on the support when the keyboard tray is tilted. Compatible with all Global keyboard mechanisms. Palm rest is easily removable. Includes mouse fence with cable manager and anti-slip strips. Keyboard tray is 23"W x 11.5"D and mouse support is 11" in diameter. Tray support material a compact phenolic panel, mouse tray in ABS plastic. Plug-in gel-feel foam palm rest.

- Specify mechanism separately, see pages 462-463.

KEYBOARD TRAYS / MECHANISMS

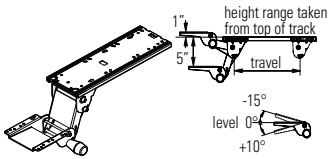

Soft Touch Keyboard Support Mechanism

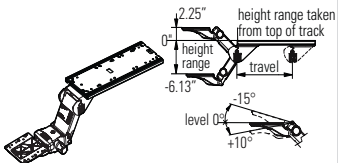

Lift-N-Lock Keyboard Support Mechanism

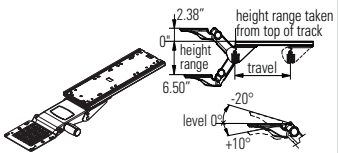

Slim Fit Keyboard Support Mechanism

MODEL #	DIMENSIONS			WT/LB.	CUBIC FT.	LIST PRICE
	W x D x H					
KSM01-21	9 x 23.8 x 4.3			9.2	0.7	\$203
KSM01-18	7.4 x 19.7 x 3.6			7.6	0.6	\$203
KSM01-12	5 x 13.1 x 2.4			5.1	0.4	\$203

Soft touch knob for simultaneous height and tilt adjustment. Spring-assist mechanism. Positive tilt lockout available by special order with extended lead time. Compatible with all Global keyboard mechanisms.

Good for single users who do not adjust their keyboard often.

- KSM01-21 requires 21.75" of depth clearance under the surface for installation.
- KSM01-18 requires 18" of depth clearance under the surface for installation.
- KSM01-12 requires 12" of depth clearance under the surface for installation.
- *Specify keyboard tray separately, see page 461.*

KSM02-21	9 x 23.8 x 9.7			9.7	0.7	\$266
KSM02-18	7.4 x 19.7 x 8.2			8	0.6	\$266
KSM02-12	5 x 13.1 x 5.4			5.4	0.4	\$266

Knobless height adjustment and independent tilt adjustment. Locks automatically into position with release of tray. Positive tilt lockout available by special order with extended lead time. Compatible with all Global keyboard mechanisms. Good for single users who frequently change positions and for multiple users. Swivels 360°.

- KSM02-21 requires 21.75" of depth clearance under the surface for installation.
- KSM02-18 requires 18" of depth clearance under the surface for installation.
- KSM02-12 requires 12" of depth clearance under the surface for installation.
- *Specify keyboard tray separately, see page 461.*

Black

KSFK-21	7.5 x 23.8 x 4.75			5.4	0.6	\$266
KSFK-18	7.5 x 19.7 x 4.75			5.4	0.5	\$266
KSFK-12	7.5 x 13.1 x 4.75			5.4	0.5	\$266

Warm White

KSFK-21-W	7.5 x 23.8 x 4.75			5.4	0.7	\$274
-----------	-------------------	--	--	-----	-----	--------------

Super slim profile accommodates leg clearance requirements of more users. Knobless height adjustment and independent tilt adjustment. Positive tilt lockout available by special order with extended lead time. Height and depth indicators together in dashboard. Compatible with all Global keyboard mechanisms. Good for single users who frequently change positions and for multiple users. Swivels 360°.

- KSFK-21 requires 21.75" of depth clearance under the surface for installation.
- KSFK-18 requires 18" of depth clearance under the surface for installation.
- KSFK-12 requires 12" of depth clearance under the surface for installation.
- *Specify keyboard tray separately, see page 461.*

KEYBOARD MECHANISMS **MODEL #** **DIMENSIONS** **WT/LB.** **CUBIC FT.** **LIST PRICE**

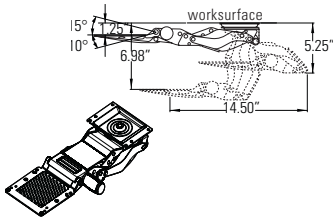

Trackless Keyboard Support Mechanism

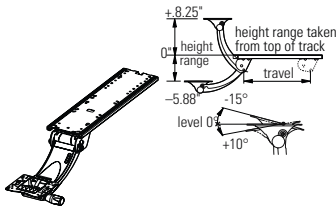

Lift-N-Lock Sit-Stand Mechanism

W x D x H

Black

KSTRKLS-B	7.5 x 14.5 x 5.25	5.4	0.3	\$325
-----------	-------------------	-----	-----	--------------

Warm White

KSTRKLS-W	7.5 x 14.5 x 5.25	5.4	0.3	\$325
-----------	-------------------	-----	-----	--------------

Super slim profile trackless keyboard mechanism designed to fit worksurfaces such as height adjustable tables and benching systems, where space is limited and conventional track mounted keyboard mechanisms will not fit. Knobless height adjustment and independent tilt adjustment. Positive tilt lockout available by special order with extended lead time. Compatible with all Global keyboard trays.



- Specify keyboard tray separately, see page 461.

KSM03-21	9 x 23.8 x 9.7	11.8	0.9	\$428
KSM03-18	7.4 x 19.7 x 8	9.7	0.7	\$428
KSM03-12	5 x 13.1 x 5.3	6.5	0.5	\$428

Ergonomic support for both seated and standing positions. Curved neck allows user closer access to the desk. Positive tilt lockout available by special order with extended lead time. Compatible with all Global keyboard mechanisms. Recommended for single users who alternate between sitting and standing. Swivels 360°.

- KSM03-21 requires 21.75" of depth clearance under the surface for installation.
- KSM03-18 requires 18" of depth clearance under the surface for installation.
- KSM03-12 requires 12" of depth clearance under the surface for installation.
- Specify keyboard tray separately, see page 461.

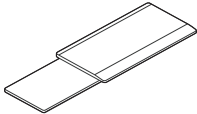
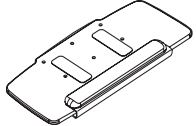
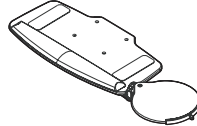
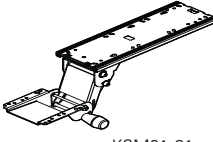
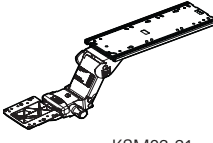
KEYBOARD SUPPORT PACKAGES

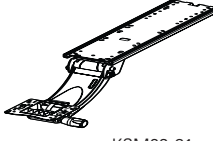
<p>Packages consist of a keyboard tray with mouse support, keyboard mechanism and a 21.75" glide track which requires 21.75" of depth clearance under the surface for installation.</p> <p>Contact Customer Service for 18" and 12" glide track package pricing.</p>	 <p>KT01</p>	 <p>KT27M02</p>	 <p>KTMT03</p>
 <p>KSM01-21</p>	<p>KP0101 \$407</p>	<p>KP0102 \$466</p>	<p>KP0103 \$487</p>
 <p>KSM02-21</p>	<p>KP0201 \$470</p>	<p>KP0202 \$529</p>	<p>KP0203 \$550</p>
 <p>KSF01</p>	<p>KPSF01 \$470</p>	<p>KPSF02 \$529</p>	<p>KPSF03 \$550</p>
 <p>KSM03-21</p>	<p>KP0301 \$632</p>	<p>KP0302 \$691</p>	<p>KP0303 \$712</p>

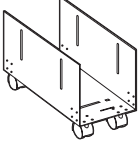
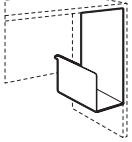
CPU HOLDERS	MODEL #	DIMENSIONS	WT/LB.	CUBIC FT.	LIST PRICE
		W x D x H			
 <p>CPU Holder on Casters</p>	PCPU-HC	5.5-9 x 15 x 9.25	8	0.45	\$149
<p>Adjusts 5.5" - 9." in width. Front locking casters. Assembly hardware included. Height without CPU is 9.25". Depth without CPU is 15". Black only.</p>					
 <p>Power Park CPU Holder</p>	PCPU-HO	5-11 x 15 x 18	11.5	1	\$123
<p>Desk mounted CPU holder. Adjusts 5" - 11" in width. Mounting hardware included. Height without CPU is 18". Depth without CPU is 15". Black only.</p>					

CPU HOLDER MODEL # DIMENSIONS WT/LB. CUBIC FT. LIST PRICE



CPU Holder on Glide Track

	W x D x H			
PCPU-GT	3.5 x 9.3 x 13.5	12.6	1.4	\$281

Accepts tower CPUs with widths from 3.5" to 9.3" and heights from 12.5" to 22.5". 17" glide track and 360° swivel for easy access to rear of CPU. Steel and engineered resin construction.

LIGHTING **MODEL #** **DIMENSIONS** **WT/LB.** **CUBIC FT.** **LIST PRICE**

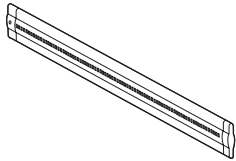

LED Task Light

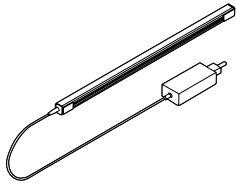

Starter LED Task Light

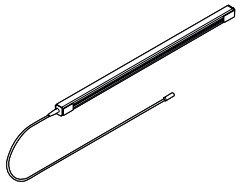

Add-On LED Task Light

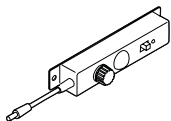

Occupancy Sensor

	W x D x H			
PLED30	15.5 x 1.5 x 0.5	2	0.5	\$344
PLED50	23.5 x 1.5 x 0.5	2	0.5	\$396
PLED100	43.5 x 1.5 x 0.5	3	0.5	\$461

Energy efficient LED. Ultra slim design. Suitable for hanging under hutch or wallhung units. 6' power cord.

PLEDS240	22.9 x 0.94 x 0.79	3	0.13	\$145
PLEDS360	33.5 x 0.94 x 0.79	3	0.16	\$167
PLEDS480	45.5 x 0.94 x 0.79	3	0.21	\$186

Undercabinet slim profile LED linear light fixture with lens and On/Off switch. May be used as stand-alone or extended with add-on section below (PLEDAxxx). Plug-in power supply with 72" cord length plus 78" DC cable. Magnetic attachment integral to light for mounting to steel units; for mounting to laminate units, additional steel mounting plates are required and included. Light enclosure in clear anodizing finish. Color temperature cool White 4000K. Lifespan rate 30,000 hours.

	PLEDS240	PLEDS360	PLEDS480
Nominal size	24"W	36"W	48"W
Number of LEDs	36	54	72
Total light output (lumens)	580	780	1150
Power input per light (watts)	9	13.5	18

PLEDA240	22.9 x 0.94 x 0.79	3	0.13	\$118
PLEDA360	33.5 x 0.94 x 0.79	3	0.16	\$140
PLEDA480	45.5 x 0.94 x 0.79	3	0.21	\$158

Undercabinet slim profile LED linear add-on light fixture with lens. Daisy chain unit with 39" linking cable, no power supply. Add-on units can only be linked up to a total of 48 watts per power supply; this is equivalent to 10 feet of nominal length of light per power supply. Magnetic attachment integral to light for mounting to steel units; for mounting to laminate units, additional steel mounting plates are required and included. Light enclosure in clear anodizing finish. Color temperature cool White 4000K.

	PLEDA240	PLEDA360	PLEDA480
Nominal size	24"W	36"W	48"W
Number of LEDs	36	54	72
Total light output (lumens)	580	780	1150
Power input per light (watts)	9	13.5	18

PLEDOS	4.4 x 0.93 x 1.3	3	0.02	\$59
--------	------------------	---	------	-------------

Inline add-on controller for dimming and occupancy sensor.

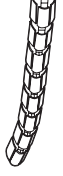
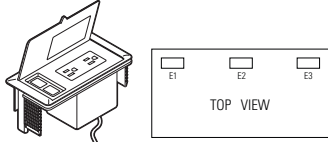
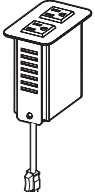
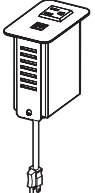
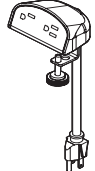
POWER / DATA	MODEL #	DIMENSIONS W x D x H	WT/LB.	CUBIC FT.	LIST PRICE
 <p>Cable Snake</p>	PCSN01	3 x 2 x 31.25	2.1	0.2	\$115
Flexible cable management. Provides access to power/data from floor to underside of worksurface where it attaches. Two pathways within cable snake. Length under desk is 31.25". Silver plastic only.					
 <p>Cable Snake Extension</p>	PCSN01E	3 x 2 x 18	2.1	0.2	\$92
Extension kit to use with cable snake PCSN01. Additional 8 links extend cable snake up to 49" in length. Ideal for height adjustable tables. Silver plastic only.					
 <p>Power/Data Block</p>	PMSPPDM	6.5 x 3.5 x 2.75	2	0.1	\$268
Worksurface power and data module. Two power receptacles and two data receptacles. Specify position and Add \$91 for cut-out in worksurface. Corresponding cut-out options are E1, E2 or E3. Black only. 9' cord. Cut-out dimensions: 5.95" x 2.75".					
 <p>Cove Mini Power Block</p>	PSCOVSM2B	2.25 x 3.75 x 3.12	2.35	0.5	\$313
	PSCOVSM2S	2.25 x 3.75 x 3.12	2.35	0.5	\$313
Designed to retrofit into an existing grommet cut-out to bring power to the desktop. Fits in 3.27" x 1.9" cut-out (FOG, POG) and mounts to 0.5" to 2" thick surface; must remove grommet cap and sleeve. Includes two 12A, 120 VAC spill resistant power receptacles. 9' power cord with 90° flat plug with 45° rotation. ETL listed. Available in Black (B) or Silver (S) as indicated by last character of model number.					
 <p>Cove Mini Power/USB Block</p>	PSCOVS1UB	2.25 x 3.75 x 3.12	2.35	0.5	\$494
	PSCOVS1US	2.25 x 3.75 x 3.12	2.35	0.5	\$494
Designed to retrofit into an existing grommet cut-out to bring power to the desktop. Fits in 3.27" x 1.9" cut-out (FOG, POG) and mounts to 0.5" to 2" thick surface; must remove grommet cap and sleeve. Includes one 12A, 120 VAC spill resistant power receptacle and two 2.1A (11W) USB charging ports. 9' power cord with 90° flat plug with 45° rotation. ETL listed. Available in Black (B) or Silver (S) as indicated by last character of model number.					
 <p>Mini Adapt Power Module</p>	PEUTEM	3.8 x 3 x 2	1	0.18	\$158
Two power receptacles. Attaches to edge of table or desk through grommet hole. 6' Black cord. Black only.					

POWER / DATA	MODEL #	DIMENSIONS	WT/LB.	CUBIC FT.	LIST PRICE
--------------	---------	------------	--------	-----------	------------



DPC Slim Desktop 2 Power/USB-A and -C

		W x D x H			
PSDPC22W		4.88 x 2.25 x 2.25	2.5	0.5	\$449

Desktop power center with two 15A tamper resistant power receptacles, one USB-A port and one USB-C port (provides 3.1A). 10' cord with molded plug. Includes three mounting options: a screw-in mounting plate for forward facing outlets; under surface mount bracket; or a clamp mounting kit for 0.5"-1.5" thick surfaces. Gloss White body with Grey face.



DPC Slim Desktop 3 Power/USB-A and -C

PSDPC32W		6 x 2.25 x 2.25	2.6	0.5	\$586
----------	--	-----------------	-----	-----	--------------

Desktop power center with three 15A tamper resistant power receptacles, one USB-A port and one USB-C port (provides 3.1A). 10' cord with molded plug. Includes three mounting options: a screw-in mounting plate for forward facing outlets; under surface mount bracket; or a clamp mounting kit for 0.5"-1.5" thick surfaces. Gloss White body with Grey face.

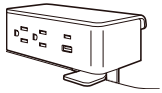

Clamp Mount 2 Power/USB-A and -C

PS3525057		5.5 x 3.2 x 3	3	0.2	\$695
PS3525002		5.5 x 3.2 x 3	3	0.2	\$695

Ashley Duo clamp mount module with two 15 amp 120 volt AC receptables; 2.4 amp USB-A port and 60 watt USB-C power delivery port. 10' cord with molded plug. UL listed. Clamp accommodates worksurfaces 0.5" to 1.5" thick; fastened with thumb screws.

PS3525057 - White module with Silver bracket. PS3525002 - Black module with Silver bracket.

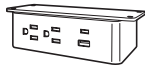

Under Mount 2 Power/USB-A and -C

PS3526057		5.5 x 2.8 x 1.8	3.2	0.2	\$695
PS3526002		5.5 x 2.8 x 1.8	3.2	0.2	\$695

Ashley Duo under mount module with two 15 amp 120 volt AC receptables; 2.4 amp USB-A port and 60 watt USB-C power delivery port. 10' cord with molded plug. UL listed. Mountable under most worksurfaces.

PS3526057 - White module with Silver bracket. PS3526002 - Black module with Silver bracket.

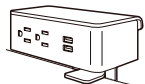

Clamp Mount 2 Power/2 USB-A

PS305057		5.5 x 3.2 x 3	3.01	0.05	\$537
PS305002		5.5 x 3.2 x 3	3.01	0.05	\$537

Ashley Duo clamp mount power module with two 15 amp 120 volt AC receptables and two 2.1 amp USB-A ports. Includes 10' power cord with molded plug. Edge clamp accommodates worksurfaces 0.5" to 1.5" thick; fastened with thumb screws.

PS305057 - White module with Silver bracket. PS305002 - Black module with Silver bracket.



Under Mount 2 Power/2 USB-A

PS305157		5.5 x 2.8 x 1.8	3.2	0.05	\$468
PS305102		5.5 x 2.8 x 1.8	3.2	0.05	\$468

Ashley Duo under mount power module with two 15 amp 120 volt AC receptables and two 2.1 amp USB-A ports. Includes 10' power cord with molded plug. Mountable under most worksurfaces. Installation template provided.

PS305157 - White module with Silver bracket. PS305102 - Black module with Silver bracket.

POWER / DATA	MODEL #	DIMENSIONS	WT/LB.	CUBIC FT.	LIST PRICE
--------------	---------	------------	--------	-----------	------------

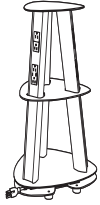

Isle Power Tower

	W x D x H				
PTISL96GB	18 x 18 x 25.5	28	6.5	\$3573	
PTISL96GW	18 x 18 x 25.5	28	6.5	\$3573	
PTISL96SP	18 x 18 x 25.5	28	6.5	\$3573	

Includes three (3) standard duplexes each with two (2) 110V power outlets; and three (3) USB-A + USB-C duplexes each with two (2) 110V power outlets, one (1) 55W USB-C power delivery port and one (1) 1.5A, 5V USB-A port. Total of twelve (12) 110V power outlets, three (3) USB-A and three (3) USB-C ports. 9' cord with molded plug.
Available in Gloss Black (**GB**), Gloss White (**GW**) and Silver Pearl (**SP**) as indicated by last letter of model number.

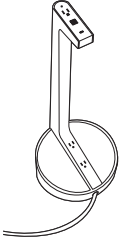

Vesta Portable Power Tower

PPVST3WF	12 x 12 x 28.25	10	4.3	\$2113	
----------	-----------------	----	-----	---------------	--

Includes three 110V power outlets (one on top, two on base), two USB-A and one USB-C charging ports. 10' cord with plug. Matte White finish with Fog inserts.



Oasis Mini A Power Block

OAM-A-PC-B	15 x 9 x 5.25	16	1.53	\$2572	
OAM-A-PC-S	15 x 9 x 5.25	16	1.53	\$2572	

15" trough with six power receptacles, two telecom plate cut-outs (telecom plates sold separately - see page 471) and two 9' 3-prong plugs. **M1, M2 or M3 cut-out(s) must be specified on conference table** (see product notes section for more details and cut-out upcharge). Available in Black (**B**) or Silver Pearl (**S**) as indicated by last character of model number. Cut-out dimensions: 14.12" x 8.25".

- *Cannot be daisy-chained.*



Single Sided Recessed Power Block

PRTMCS401B	10.78 x 4.22 x 4.86	4.3	0.51	\$578	
PRTMCS401T	10.78 x 4.22 x 4.86	4.3	0.51	\$578	
PRTMCS401W	10.78 x 4.22 x 4.86	4.3	0.51	\$578	

Single sided recessed power block with **one regular power duplex and one data knockout on top; one power duplex on bottom**. 10' power cord with straight plug. Specify telecom options separately, see page 471.

Available in Black (**B**), Tungsten (**T**) or White (**W**) as indicated by last letter of model number. Duplexes always Grey. Corresponding cut-out options are R1, R2, R3 or RS.

- *Cannot be daisy-chained.*

POWER / DATA MODEL # DIMENSIONS WT/LB. CUBIC FT. LIST PRICE



Single Sided Recessed Power Block - USB-A + USB-C

	W x D x H					
PRTMCS421B	10.78	x 4.22	x 4.86	4.5	0.51	\$759
PRTMCS421T	10.78	x 4.22	x 4.86	4.5	0.51	\$759
PRTMCS421W	10.78	x 4.22	x 4.86	4.5	0.51	\$759

Single sided recessed power block with **one power/USB-A/USB-C duplex and one data knockout on top; one power duplex on bottom.** USB -A port charges max 2.4 amps at 5V and USB-C port charges max 3 amps at 5V. 10' power cord with straight plug. Specify telecom options separately, see page 471. Available in Black (**B**), Tungsten (**T**) or White (**W**) as indicated by last letter of model number. Duplexes always Grey (duplex with USB ports is glossy finish). Corresponding cut-out options are R1, R2, R3 or RS.

- *Cannot be daisy-chained.*



Double Sided Recessed Power Block

PRTMCD602B	10.78	x 6.22	x 4.86	5.9	0.51	\$660
PRTMCD602T	10.78	x 6.22	x 4.86	5.9	0.51	\$660
PRTMCD602W	10.78	x 6.22	x 4.86	5.9	0.51	\$660

Double sided recessed power block with **two regular power duplexes and two data knockouts on top; one power duplex on bottom.** 10' power cord with straight plug. Specify telecom options separately, see page 471. Available in Black (**B**), Tungsten (**T**) or White (**W**) as indicated by last letter of model number. Duplexes always Grey. Corresponding cut-out options are T1, T2, T3 or TS.

- *Cannot be daisy-chained.*



Double Sided Recessed Power Block - USB-A + USB-C

PRTMCD622B	10.78	x 6.22	x 4.86	6.1	0.51	\$831
PRTMCD622T	10.78	x 6.22	x 4.86	6.1	0.51	\$831
PRTMCD622W	10.78	x 6.22	x 4.86	6.1	0.51	\$831

Double sided recessed power block with **one regular power duplex, one power/USB-A/USB-C duplex and two data knockouts on top; one power duplex on bottom.** USB -A port charges max 2.4 amps at 5V and USB-C port charges max 3 amps at 5V. 10' power cord with straight plug. Specify telecom options separately, see page 471. Available in Black (**B**), Tungsten (**T**) or White (**W**) as indicated by last letter of model number. Duplexes always Grey (duplex with USB ports is glossy finish). Corresponding cut-out options are T1, T2, T3 or TS.

- *Cannot be daisy-chained.*







Double Sided Recessed Power Block - USB-A + USB-C

PRTMCD642B	10.78	x 6.22	x 4.86	6.3	0.51	\$1001
PRTMCD642T	10.78	x 6.22	x 4.86	6.3	0.51	\$1001
PRTMCD642W	10.78	x 6.22	x 4.86	6.3	0.51	\$1001

Double sided recessed power block with **two power/USB-A/USB-C duplexes and two data knockouts on top; one power duplex on bottom.** USB -A port charges max 2.4 amps at 5V and USB-C port charges max 3 amps at 5V. 10' power cord with straight plug. Specify telecom options separately, see page 471. Available in Black (**B**), Tungsten (**T**) or White (**W**) as indicated by last letter of model number. Duplexes always Grey (duplex with USB ports is glossy finish). Corresponding cut-out options are T1, T2, T3 or TS.

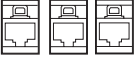
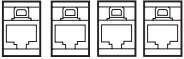
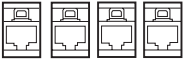
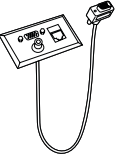
- *Cannot be daisy-chained.*

POWER / DATA	MODEL #	DIMENSIONS	WT/LB.	CUBIC FT.	LIST PRICE
		W x D x H			
	PTELO1	3.25 x 2 x -	0.01	0.05	\$319
Telecom Plate - 2 x 6	Includes 2 x RJ45 cat 6 data jacks. Black telecom plate. To be hardwired by data contractor.				
					
	PTEL12	3.25 x 2 x -	1	0.1	\$319
Telecom Plate - 2 x 6	Includes 2 x RJ45 cat 6 data jacks. Grey telecom plate. To be hardwired by data contractor.				
					
	PTELO2	3.25 x 2 x -	0.01	0.05	\$314
Telecom Plate - 3 x 6	Includes 1 x RJ11 cat 3 phone jack and 2 x RJ45 cat 6 data jacks. Black telecom plate. To be hardwired by data contractor.				
					
	PTELO3	3.25 x 2 x -	0.01	0.05	\$578
Telecom Plate - 4 x 6	Includes 4 x RJ45 cat 6 data jacks. Black telecom plate. To be hardwired by data contractor.				
					
	PTEL13	3.25 x 2 x -	0.01	0.03	\$578
Telecom Plate - 4 x 6	Includes 4 x RJ45 cat 6 data jacks. Grey telecom plate. To be hardwired by data contractor.				
					
	PTEL04	3.25 x 2 x -	0.01	0.05	\$400
Telecom Plate - 3TSV	Includes 1 x RJ45 cat 6 data jack, mini stereo and 15 pin HD VGA with female to male connector cable. Black telecom plate. To be hardwired by data contractor.				
					
	PTEL05	3.25 x 2 x -	0.01	0.05	\$745
Telecom Plate - 3SVH	Includes mini stereo, 15 pin HD VGA with female to male connector cable and HDMI with female to female connector cable. Black telecom plate.				
					
	PTEL14	3.25 x 2 x -	1	0.1	\$745
Telecom Plate - 3SVH	Includes mini stereo, 15 pin HD VGA with female to male connector cable and HDMI with female to female connector cable. Grey telecom plate.				

POWER / DATA MODEL # DIMENSIONS WT/LB. CUBIC FT. LIST PRICE



Telecom Plate - 1 USB-C and 1 USB-A

		W x D x H			
PTEL08	3.25 x 2 x -	1	0.1	\$277	

Includes one USB-C port with 20" male pigtail and one USB-A port with 72" pigtail. Requires powered USB transformer (model PUSBTRSF), to be ordered separately. Grey telecom plate.

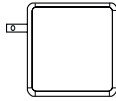

Powered USB Transformer

PUSBTRSF	3.25 x 2 x -	1	0.03	\$183
----------	--------------	---	------	--------------

Provides power for PTEL08 - 25w, 100-240 VAC, 5-9VDC one USB-C and two USB-A female ports.



Telecom Plate - 2 USB-A

PTEL09	3.25 x 2 x -	1	0.1	\$372
--------	--------------	---	-----	--------------

Includes two USB-A ports each with 72" patchcord. Grey telecom plate.



Telecom Plate - 2 RJ45 and 1 HDMI

PTEL10	3.25 x 2 x -	1	0.1	\$765
--------	--------------	---	-----	--------------

Includes two RJ45 Cat 6 data jacks and one HDMI with 36" male pigtail; female/female gender changer. Grey telecom plate.



Telecom Plate - 1 HDMI and 1 USB-A

PTEL11	3.25 x 2 x -	1	0.1	\$609
--------	--------------	---	-----	--------------

Includes one HDMI female/female with 36" patchcord and one USB-A with 72" patchcord. Grey telecom plate.

POWER SOLUTIONS FOR FLEXIBLE SPACES

- Perfect for training areas, meeting rooms, in-office workstations and more; Code compliant that allows users to optimize any space providing convenient power access.
- Connect up to four units from a single infeed, delivering AC power and USB charging to the table tops.
- Two styles are available: in-surface modules or on-surface modules.
- Starter modules include 10' corded infeed with 3-prong NEMA plug.
- Touch safe easy to use connectors from module to module with added latch to prevent unintended separation.
- Each module features three tamper-resistant receptacles, USB-A and USB-C charging ports.
- Overall maximum length joined together not to exceed 48.5 feet per infeed.
- UL listed to **UL962A SD**, the standard for furniture power distribution units on portable/movable workspace tables.
- Certified to CSA standard **C22.2 No. 203-16**.
- When ordering in-surface modules be sure to select corresponding cut-out options when specifying tables. Specify **MPS** for a single centered cut-out on the approach side of the table or **MPD** for two cut-outs in the left and right hand positions. Upcharge will apply per cut-out. Cut-outs are available on the following series: **2gether tables, Bungee rectangular fixed and flip-top tables, Bungee SL tables, ConnecTables, Edventure study carrels and Zook rectangular and flip-top tables**. Surface must be a minimum of 1/2" to a maximum of 1 1/2" thick for proper mounting of the units.
- On-surface modules come with a clamp mount that will accommodate any material from 1/2" to 1 1/2" thick; additional brackets are also included for alternate screw in mounting options that can accommodate vertical or horizontal positions.
- In-surface cut-out dimensions: 7.15" x 2.25".

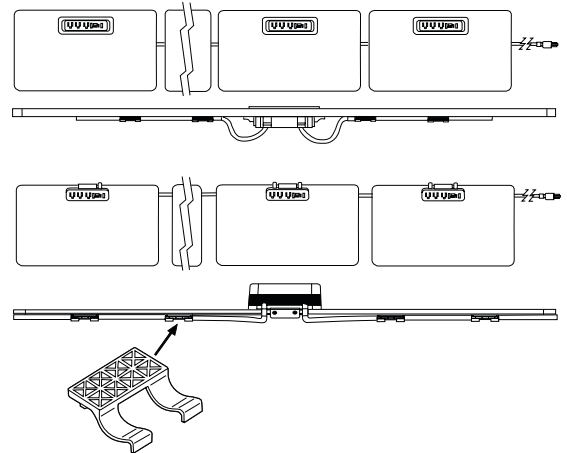

MODPOWER DAISY-CHAIN SOLUTION



ModPower In-Surface Starter Unit



ModPower In-Surface Middle Unit



ModPower In-Surface End Unit

	W x D x H				
PMDSF10MG	7.63 x 2.75 x 2.63	3.44	1		\$597
PMDSF10WH	7.63 x 2.75 x 2.63	3.44	1		\$597

Includes infeed, one 10' cord with NEMA plug and one 3' connector cord. Unit is equipped with three 15A tamper-resistant receptacles, one USB-A and one USB-C charging ports, and a circuit breaker. Four cable management cord clips included. Specify corresponding cut-out code when ordering table: single centered cut-out (**MPS**) or two cut-outs in left and right positions (**MPD**). Available in Magnesium (**MG**) or White (**WH**) finish as indicated by last characters of model number.

PMDCF3MG	7.63 x 2.75 x 2.63	2.44	2.44		\$562
PMDCF3WH	7.63 x 2.75 x 2.63	2.44	1		\$562

Includes two 3' connector cords. Unit is equipped with three 15A rated 12A tamper-resistant receptacles, one USB-A and one USB-C charging ports, and a circuit breaker. Four cable management cord clips included. Specify corresponding cut-out code when ordering table: single centered cut-out (**MPS**) or two cut-outs in left and right positions (**MPD**). Available in Magnesium (**MG**) or White (**WH**) finish as indicated by last characters of model number.

PMDEF3MG	7.63 x 2.75 x 2.63	1.85	1		\$494
PMDEF3WH	7.63 x 2.75 x 2.63	1.85	1		\$494

Includes one 3' connector cord. Unit is equipped with three 15A rated 12A tamper-resistant receptacles, one USB-A and one USB-C charging ports, and a circuit breaker. Two cable management cord clips included. Specify corresponding cut-out code when ordering table: single centered cut-out (**MPS**) or two cut-outs in left and right positions (**MPD**). Available in Magnesium (**MG**) or White (**WH**) finish as indicated by last characters of model number.

MODPOWER MODULES **MODEL #** **DIMENSIONS** **WT/LB.** **CUBIC FT.** **LIST PRICE**



ModPower On Surface Starter Unit

	W x D x H			
PMDSA10MG	6.13 x 1.75 x 2.5	4.33	1	\$631
PMDSA10WH	6.13 x 1.75 x 2.5	4.33	1	\$631

Includes infeed, one 10' cord with NEMA plug and one 3' connector cord. Unit is equipped with three 15A tamper-resistant receptables, one USB-A and one USB-C charging ports, and a circuit breaker. Includes edge clamp and three other mounting methods. Four cable management cord clips included. Available in Magnesium (**MG**) or White (**WH**) finish as indicated by last characters of model number.



ModPower On Surface Middle Unit

PMDEA3MG	6.13 x 1.75 x 2.5	3.3	1	\$597
PMDEA3WH	6.13 x 1.75 x 2.5	3.33	1	\$597

Includes two 3' connector cords. Unit is equipped with three 15A rated 12A tamper-resistant receptables, one USB-A and one USB-C charging ports, and a circuit breaker. Includes edge clamp and three other mounting methods. Four cable management cord clips included. Available in Magnesium (**MG**) or White (**WH**) finish as indicated by last characters of model number.



ModPower On Surface End Unit

PMDEA3MG	6.13 x 1.75 x 2.5	2.75	1	\$528
PMDEA3WH	6.13 x 1.75 x 2.5	2.75	1	\$528

Includes one 3' connector cord. Unit is equipped with three 15A rated 12A tamper-resistant receptables, one USB-A and one USB-C charging ports, and a circuit breaker. Includes edge clamp and three other mounting methods. Two cable management cord clips included. Available in Magnesium (**MG**) or White (**WH**) finish as indicated by last characters of model number.

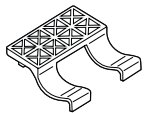

ModPower Cable Management Clips

PMDCLIPS	2.6 x 2.5 x 0.6	0.3	0.2	\$102
----------	-----------------	-----	-----	--------------

Package of 10 clips.



ModPower Interconnecting Jumper

PMDJ36BK	36 x - x -	1.38	0.9	\$329
----------	------------	------	-----	--------------

Interconnection jumper cord to add an additional 3' of cord length between in-surface and on-surface ModPower units. 3' cord with male and female connector. Package of 2 jumpers.

OFFICE ACCESSORIES MODEL # DIMENSIONS WT/LB. CUBIC FT. LIST PRICE

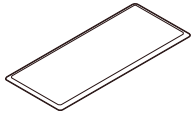

Anti-Fatigue Mat

	W x D x H			
PAFM3018	29.4 x 17.63 x 0.75	4.4	0.3	\$136
PAFM4820	48 x 20.5 x 0.75	7.7	0.59	\$210

Polyurethane anti-fatigue mat offers increased comfort and help reduce strain when standing. Tapered no-curl edges prevent tripping hazards. Anti-slip backing suitable for low pile carpets or hard flooring. Black only.

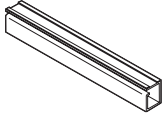

Wire Manager

PEWM5.5	66 x 2 x 2	0.6	0.1	\$136
PEWM5	60 x 2 x 2	0.6	0.1	\$114
PEWM4.5	54 x 2 x 2	0.5	0.1	\$103
PEWM4	48 x 2 x 2	0.5	0.1	\$89
PEWM3.5	42 x 2 x 2	0.4	0.1	\$80
PEWM3	36 x 2 x 2	0.4	0.1	\$70
PEWM2.5	30 x 2 x 2	0.3	0.1	\$55
PEWM2	24 x 2 x 2	0.3	0.1	\$46
PEWM1.5	18 x 2 x 2	0.2	0.1	\$34
PEWM1	12 x 2 x 2	0.2	0.1	\$25

Plastic tray flexes to receive and hold electrical and data wires. Quickly attaches with two strips of double-sided tape. Black only.



Vertical Wire Manager

PEVWM	22 x 2 x 2	0.3	0.1	\$46
-------	------------	-----	-----	-------------

From underside of worksurface to bottom panel. Capable of holding electrical and data wires in a vertical position. Black only. Attaches with two strips of double-sided tape.



Metal Coat Tree

PCOS3	25 x 25 x 60	8	14.21	\$186
PCOS2	25 x 25 x 60	8	14.21	\$186

Square tube metal frame. Four Chrome double hooks. Adjustable glides.

- PCOS2 is finished in **Black**.
- PCOS3 is finished in **Chrome**.



Solid Wood Coat Tree*

PCT	25 x 25 x 65	6	3	\$228
-----	--------------	---	---	--------------

Four satin brass double hooks. Available in the following finishes: Absolute (AAM), Black (BKM), Cherry (ACM), English Oak (EOM), Espresso Cafe (ECM), Gray (HGM), Honey (AHM), Maple (AVM), Medium Walnut (MWM), Night (ASM), Sandy Beach (SBM), Shaker Cherry (SKM), Tiger Fruitwood (TFM), Tiger Mahogany (TMM), Tiger Walnut (TWM), WC Cream (WTM), White (WHM) and Winter Cherry (WCM).

Required specifications

Finish*

P PRODUCTIVITY SOLUTIONS™ BY GLOBAL

OFFICE ACCESSORIES

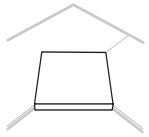

Corner Keyboard Plate*

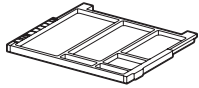

Pencil Drawer

MODEL #	DIMENSIONS W x D x H	WT/LB.	CUBIC FT.	LIST PRICE
PEEOCKS	18 x 18 x 1.12	6	0.3	\$79

Converts two 1" thick worksurfaces at 90° into a keyboard support corner. Finished in Black (**BLK**) or Tungsten (**TUN**) epoxy coating.

PEEPD	22.5 x 15 x 1.5	2	0.7	\$145
-------	-----------------	---	-----	--------------

Black ABS plastic. Provides space for writing instruments and small items at the workspace. Attaches to underside of any 24"D and 30"D worksurface with included roller slides. There are no specifications for Pencil Drawer.

- May be used with all Caseloads.

CENTER DRAWERS

NOTES:

- Center drawers must be dealer or end user installed. Drawers do not fill entire center space opening.
- Approximate kneespace widths are:

30" x 60" DP	25.5"	30" x 66" DP	31.5"
30" x 72" DP	37.5"	30" x 66"/20" x 40" L	22.5"
30" x 66"/24" x 48" L	24.5"	36" x 72"/24" x 48" L	30.5"

CENTER DRAWERS

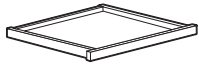

Center Drawer*



Flat Bracket

MODEL #	DIMENSIONS W x D x H	WT/LB.	CUBIC FT.	LIST PRICE
CD28	28 x 18 x 3	5	1	\$248

Laminate drawer front is attached to a 4-sided frame. Recommended for use on 36" x 72" desks. Specify finish from list available in each series.

M393	4.5 x 3.12 x 0.25	1	1	\$16
------	-------------------	---	---	-------------

Used as a mending plate to give additional worksurface support.

Required specifications

Finish*

textiles and finishes

Care and Cleaning

Textiles

Fabrics: To extend the life of your seating upholstered in fabric, regularly dust the chair to prevent airborne particles from penetrating the fabric surface.

For light soiling, use a damp cloth and blot the spot with very light pressure, taking care never to soak the fabric. Dry with a clean cloth by blotting - never rub fabric. More intense stains can be treated the same way, but with a mild detergent. Always test fabric first in an unseen area before using any cleaning method.

Leather: For regular cleaning, simply use a soft damp cloth, taking care not to soak the leather. For more thorough treatment, soak a soft cloth in a mild soap solution and wipe surface in a light circular motion. Repeat with clean water. Allow to dry and polish with a soft dry cloth. Do not use detergents, aerosol sprays or other polishes.

Hard Surfaces

Laminate & painted metal finishes: Wipe the surface with a clean soft damp cloth; if needed, a mild soap solution (i.e. Ivory dishwashing liquid) can be used. To prevent streaks, dry the surface with a clean dry soft cloth moving in a circular motion.

Textiles

- **Water-based cleaner (W):** Spot clean, using the foam only from a water-based cleaning agent, such as a mild detergent or non-solvent upholstery shampoo product. Apply foam with a soft brush in a circular motion. Vacuum when dry. Pretest small area before proceeding.
- **Solvent cleaner (S):** Spot clean, using a mild water-free solvent or dry cleaning product. Clean only in a well-ventilated room and avoid any product containing carbon tetrachloride or other toxic materials. Pretest a small area before proceeding.
- **Water/solvent cleaner (WS):** Spot clean with a mild solvent, an upholstery shampoo, or the foam from a mild detergent. When using a solvent or dry cleaning product, follow instructions carefully and clean only in a well-ventilated room. Avoid any product that contains carbon tetrachloride or other toxic materials. With either method, pretest a small area before proceeding.
- **Vacuum only (X):** Clean this fabric only by vacuuming or light brushing to prevent accumulation of dust and grime. Water-based foam cleaning agents of any kind may cause excessive shrinking, staining, or distortion of the surface pile and therefore, should not be used.
- **Crypton cleaning (C):** Generally stains are removed with plain water and powdered enzyme detergent. Upholstery foam shampoo, water-based cleaning products and germicidal detergents can be used. Be sure to remove all residue from cleaning products with clean water. Do not use solvent-based cleaners or dry cleaning products.
- These recommendations and codes were developed by fabric specialists. However, because of the various ways fabric can be stained or damaged, there is no guarantee that the results will be completely successful. Use suggested methods on your own responsibility. To help prevent overall soil, frequent vacuuming or light brushing to remove dust and grime is recommended. Use professional furniture cleaning service when overall soiled condition has been reached.



Carded Textiles

Grade 1	Bantam, Carrera, Dobby, Fusion, Hudson, Illusion, Jenny, Quilt, Terrace, Trak, Urban, Waterfall, Wavelength
Grade 2	Allante FRee, Arc, Aristo, Couture, Elevate, Etch, Imprint, Luxhide, Match, Release, Replay, Silhouette, Verve, Vitality
Grade 3	Bobby, Canter EPU, Grid, Guild, Nomad, Pure, Vital
Grade 4	Abbey, Align, Beeline EPU, California, Continuum, Fedora, Graph, Gridley, Manner, Merit, Messenger, Metric, Mode, Montana, Murmur, Optic, Rocket, Sierra GC, Ulster, Woolish
Grade 5	Beta, Cinema, Cosmopolitan, Cover Cloth, Cross Dye, Digi Tweed, Endurance EPU, Eon EPU, Groove EPU, Keynote, Lavish, Lens, Magnify, Mark, Otto, Percept, Pip, Solitaire, Stimuli, Whit EPU
Grade 6	Faux Felt, Flock, Isabella, Novaro (leather), Pause, Sherlock, Stroll
Grade 7	Affinity, Brisa, Brisa Distressed, Channel, Everywhere Texture, Hush, Kit, Linnen, Luster, Lyre, Moon Beam 2, Odyssey, Oath, Palatine 2, Pleat, Synergy, Ultraleather
Grade 8	Dapple, Flexagon, Katano, Rainwater, Reflector, Silica, Silica Etch, Silica Leather, Silicone Element, Ultraleather Pro, Ultraleather Reef Pro, Viewpoint
Grade 9	Birch Bark Plaid, Grid, Inkling, Itajime, Motif, Metal Strips, Silica Andy, Silica Stride
Grade 10	Net, Prescott Leather, Silica Cusp, Silica Hiatus, Spokes
Grade 11	Lena (leather), Lumi, Sierra (leather), Silica Deflect, Silica Reach, Subdivide
Grade 12	No standard Global textiles - provided for grading GPM (Global purchased material, customer specified) textiles
Grade 13	Sail (Designtex) pricing available on website (Build-It tool) or price list calculator

Two Grade Combination Chart

FIRST TEXTILE SELECTED

	1	2	3	4	5	6	7	8	9	10	11	12	13	14
1	1													
2	2	2												
3	3	3	3											
4	3	4	4	4										
5	4	4	5	5	5									
6	5	5	5	6	6	6								
7	5	6	6	6	7	7	7							
8	6	6	7	7	7	8	8	8						
9	7	7	7	8	8	8	9	9	9					
10	8	8	8	8	9	9	9	10	10	10				
11	9	9	9	9	9	10	10	10	11	11	11			
12	10	10	10	10	10	10	11	11	11	12	12	12		
13	11	11	11	11	11	11	12	12	12	12	13	13	13	
14	11	12	12	12	12	12	12	13	13	13	13	14	14	14

Combining two textile grades on Global seating will result in the revised grade shown above.

- Assumptions: Two or more chairs are being ordered, there are no textile pattern repeats larger than 15" and the textile is at least 54" wide.
- A picture or sketch of where the two textiles are to be applied must be provided at time of order.
- This chart cannot be used for combining more than two textiles, a special quotation will be required for combining three or more textiles.

TEXTILES AND FINISHES

Tackboard Textiles

Anchorage	Lola	Merge	Global seating textiles (contact Customer Service for pricing)		
-----------	------	-------	--	--	--

FINISHES

Seating Finishes - Metal *For available leg frame finishes for each seating series, please see Seating price list page 381*

Antique Copper (ACO)	Black (TBL)	Brushed Chrome (BCH)	Buzz Blue (TBZ)	Cactus (TCC)	Carrot (TCR)
Cloud (TIV)	Chrome (CHM)	Designer White (TDW)	Dijon (TDJ)	Eggplant (TEG)	Fog (TFO)
Frost (TFR)	Ink (TIN)	Kalua (TKA)	Latte (TLA)	Mocha (TMO)	Nevada (TNE)
Sand (TSN)	Satin Brass (SBR)	Scarlet (TSR)	Shadow (TSH)	Toast (TOA)	Tungsten (TTU)

Seating Finishes - Plastic *(Bakhita*, Duet, Popcorn, Sonic and Stream*)*

Alloy (ALY)*	Buzz Blue (BZB)	Cactus (CCT)	Carrot (CRO)	Char (CHA)*	Cloud (IVC)
Dijon (DJN)	Eggplant (EGP)	Fog (FOG)	Frost (FRO)	Ink (INK)	Latte (LAB)
Milk (MLK)*	Night (BLK)	Sand (SND)	Scarlet (SAR)	Shadow (SHW)	

Seating Finishes - Wood

Seating finishes will not necessarily match Casegoods finishes; Seating and Casegoods finishes use different wood species and are manufactured at multiple locations.

Absolute (AAM)	Black (BKM)	Cherry (ACM)	Charcoal Java (CJM)*	Empire Mahogany (EMM)*	English Oak (EOM)
Espresso Cafe (ECM)	Fruitwood (TFM)	Gray (HGM)	Harvest Oak (HOM)*	Honey (AHM)	Jet Onyx (JOM)*
Light Honey (LHM)*	Mahogany (TMM)	Maple (AVM)	Medium Walnut (MWM)	Natural Walnut (NLW)	Night (ASM)
Noce Biondo (NBM)	Noce Grigio (NGM)	Noce Leggero (NEM)	Noce Medio (NMM)	Sandy Beach (SBM)*	Shaker Cherry (SKM)
Silver Oak (SOM)*	Walnut (TWM)	WC Cream (WTM)	White (WHM)	Winter Cherry (WCM)	

*Available on Calidon series only.

Desks, Workstations, Tables and Accessories - Laminate

Absolute Acajou (ACJ)	Asian Night (ASN)	Avant Cherry (AWC)	Avant Honey (AWH)	Black (BLK)	Blizzard (BZD)
Brushed Cobalt (BRC)	Clear Maple (CMB)	Custom Grey (CGY)	Dark Espresso (DES)	Designer White (DWT)	Fashionista (FAS)
First Class (FCL)	Noce Biondo (NBL)	Noce Grigio (NGL)	Noce Leggero (NEL)	Noce Medio (NML)	Quartered Mahogany (QTM)
Sheer Beauty (SBY)	Stonedust (SDT)	Storm Grey (SOG)	Walnut Heights (WHE)	White Chocolate (WHC)	Winter Cherry (WCR)

Writable surface (WRW)*

*Available on Zook series only

Solid Wood and Laminate Coordinating Colors

Solid Wood Colors

Absolute (AAM)
Black (BKM)
Cherry (ACM)
Espresso Cafe (ECM)
Fruitwood (TFM)
Gray (HGM)
Honey (AHM)
Mahogany (TMM)
Maple (AVM)
Medium Walnut (MWM)
Night (ASM)
Noce Biondo (NBM)
Noce Grigio (NGM)
Noce Leggero (NEM)
Noce Medio (NMM)
Walnut (TWM)
WC Cream (WTM)
White (WHM)
Winter Cherry (WCM)

Laminate Colors

Absolute Acajou (ACJ)
Black (BLK)
Avant Cherry (AWC)
Dark Espresso (DES)
-
-
Avant Honey (AWH)
Quartered Mahogany (QTM)
Clear Maple (CMB)
-
Asian Night (ASN)
Noce Biondo (NBL)
Noce Grigio (NGL)
Noce Leggero (NEL)
Noce Medio (NML)
-
White Chocolate (WHC)
Designer White (DWT)
Winter Cherry (WCR)

Metal Leg Finishes *(check series for applicable finishes)*

Antique Copper (ACO)	Black (TBL)	Brushed Chrome (BCH)	Buzz Blue (TBZ)	Cactus (TCC)	Carrot (TCR)
Cloud (TIV)	Chrome (CHM)	Designer White (TDW)	Dijon (TDJ)	Eggplant (TEG)	Fog (TFO)
Frost (TFR)	Ink (TIN)	Kalua (TKA)	Latte (TLA)	Mocha (TMO)	Nevada (TNE)
Sand (TSN)	Satin Brass (SBR)	Scarlet (TSR)	Shadow (TSH)	Toast (TOA)	Tungsten (TTU)

File Finishes - Standard

Black (BLK)	Bone (BNE)	Business Grey (BGR)	Charcoal (CHR)	Claret (CLT)	Desert Putty (DPT)
Designer White (DWT)	Fog (FOG)	Grey (GRY)	Ice (ICE)	Ivory (IVR)	Light Grey (LGR)
Metro (MET)	Moss (MOS)	Navy (NVY)	Nevada (NEV)	Oyster (OYS)	Sky (SKY)
Silver (SIL)	Stone (STN)	Storm Grey (SGR)	Tahiti Sand (TSA)	Taupe (TPE)	Tungsten (TUN)*
Willow (WIL)					*10% upcharge applies

File Finishes - Textured

Black Coffee (BKC)	Blizzard (BZD)	Dark Chocolate (T19)	Mocha (MCH)	Stonedust (SDT)
--------------------	----------------	----------------------	-------------	-----------------

FINISH CODE	ACJ	ASN	AWC	AWH	BLK	BZD	BRC	CMB	CGY	DES	DWT	FAS	FCL	NBL	NGL	NEL	NML	QTM	SBY	SDT	SOG	WHE	WHC	WCR	
LAMINATE DESKING																									
Adaptabilities	•	•	•	•	•	•	•	•	•	•	•	•	•	•	•	•	•	•	•	•	•	•	•	•	•
Genoa	•	•	•	•	•			•		•	•	•	•	•	•	•	•	•	•	•		•	•	•	•
Princeton	•	•	•	•		•		•	•	•	•	•	•	•	•	•	•		•	•		•	•	•	•
Zira	•	•	•	•	•	•	•	•	•	•	•	•	•	•	•	•	•	•	•	•	•	•	•	•	•
PANELS + COMPONENTS																									
Divide	•	•	•	•	•	•	•	•	•	•	•	•	•	•	•	•	•	•	•	•	•	•	•	•	•
TABLES - CAFÉ, MEETING & CONFERENCE																									
Alba	•	•	•	•	•	•	•	•	•	•	•			•	•	•	•	•		•	•	•	•	•	•
Boardroom	•	•	•	•	•	•	•	•	•	•	•	•	•	•	•	•	•	•	•	•	•	•	•	•	•
Swap	•	•	•	•	•	•	•	•	•	•	•	•	•	•	•	•	•	•	•	•	•	•	•	•	•
Zira boardroom	•	•	•	•	•	•	•	•	•	•	•	•	•	•	•	•	•	•	•	•	•	•	•	•	•
TABLES - TRAINING																									
2gether	•	•	•	•	•	•	•	•	•	•	•	•	•	•	•	•	•	•	•	•	•	•	•	•	•
Bungee	•	•	•	•	•	•	•	•	•	•	•	•	•	•	•	•	•	•	•	•	•	•	•	•	•
ConneCTABLES	•	•	•	•	•	•	•	•	•	•	•	•	•	•	•	•	•	•	•	•	•	•	•	•	•
Junction	•	•	•	•	•	•	•	•	•	•	•	•	•	•	•	•	•	•	•	•	•	•	•	•	•
Zook	•	•	•	•	•	•	•	•	•	•	•	•	•	•	•	•	•	•	•	•	•	•	•	•	•
TABLES - RECEPTION & OCCASIONAL																									
Citi	•	•	•	•	•	•	•	•	•	•	•	•	•	•	•	•	•	•	•	•	•	•	•	•	•
Occasional Tables	•	•	•	•	•	•	•	•	•	•	•	•	•	•	•	•	•	•	•	•	•	•	•	•	•
Sirena Tables	•	•	•	•	•	•		•	•	•	•	•	•	•	•	•	•	•	•		•	•	•	•	
Wind Tables	•	•	•	•	•	•	•	•	•	•	•	•	•	•	•	•	•	•	•	•	•	•	•	•	•
Work Tables	•	•	•	•	•	•	•	•	•	•	•	•	•	•	•	•	•	•	•	•	•	•	•	•	•
PRODUCTIVITY SOLUTIONS																									
Height Adjustable Tables	•	•	•	•	•	•	•	•	•	•	•	•	•	•	•	•	•	•	•	•	•	•	•	•	•
FILING & STORAGE																									
Lateral File Tops	•	•	•	•	•	•	•	•	•	•	•	•	•	•	•	•	•	•	•	•	•	•	•	•	•

CUSTOM GROMMET LOCATION FORM

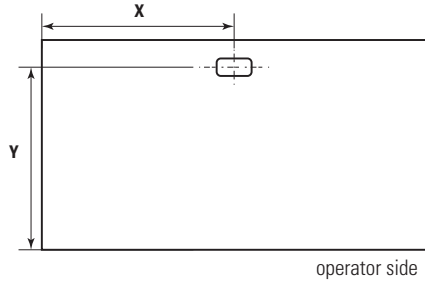

Template for tops

X = _____

Y = _____

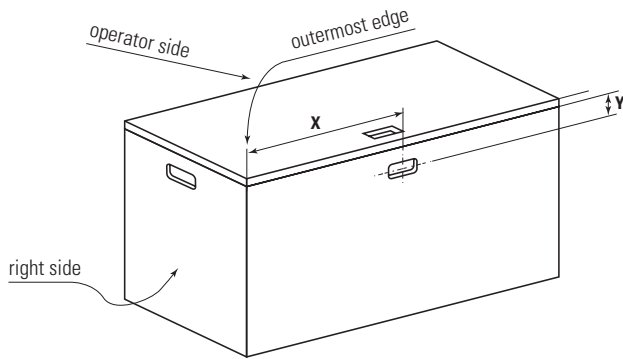
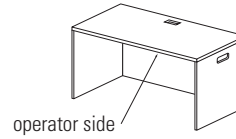

Template for modesty panels

X = _____

Y = _____

Note: X = taken from outermost edge

Note: Y = taken from underside of top

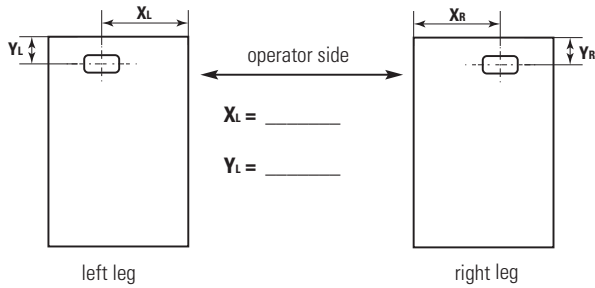

Template for legs

X_R = _____

Y_R = _____

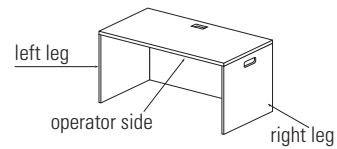

This illustrated list price book has been designed to facilitate fast reference and easy use. Products are categorized into “seating”, “desks”, “files”, “panels” or “tables” and are listed numerically within their categories. The line drawings match actual photographs (where possible) to aid in instant recognition of the total range within a series.

Sales of Global Furniture Group (“Global”) products are made only on Global’s standard Terms and Conditions of sale which are contained in this list price book. The “Purchaser” in these Terms and Conditions shall refer to Dealers and those who originally purchase directly from Global for use or re-sale. These standard Terms and Conditions may be modified or supplemented only by a separately written document signed by Global’s authorized personnel at its head office in Toronto, Ontario, Canada. Any term or condition contained in any purchase order or other form used by the Purchaser to order goods (including standard, printed language) which is different from, in addition to, or in any way inconsistent with Global’s standard Terms and Conditions shall be of no force or effect whatsoever.

All illustrations, specifications and prices in this list price book are based on the latest product information available at time of publication. Global reserves the right to make changes at any time and without prior notice to prices, colors, materials, specifications and models offered.

Description

Each product shown or described in this list price book is standard Global product. Available options are noted at the beginning of each series. Available options may require additional delivery time and cost, and may affect the warranty given. Sizes and weights shown are approximate and are subject to slight changes from time to time.

Prices and Payment

The prices shown in this list price book as well as those quoted by Global, are in Canadian dollars for orders shipped to destinations in Canada.

If shipping date requested is more than 90 days from date of order, Global shall reserve the right to use published list prices effective at time of shipment.

Orders are invoiced at time of shipment. Terms of payment are net 30 days from date of invoice unless otherwise stated. The Purchaser agrees that Global shall reserve the right to enforce a charge amounting to 1.5% per month (18% per year) on invoices outstanding more than 30 days.

If the Purchaser’s most recent annual net volume is less than \$5,000, Global may suggest payment be made in advance.

All orders are subject to the Purchaser complying with Global’s prevailing credit policy.

Any products sold by Global shall remain the property of Global until fully paid.

Prices are suggested list prices only and are subject to change without notice. Global will, however, attempt to keep the Purchasers up-to-date on all developments including price changes.

Taxes

All prices shown in this list price book are exclusive of sales, use, excise, HST and other applicable taxes and duties which may be the Purchaser’s responsibility as per the invoice issued by Global. If the Purchaser claims an exemption from such taxes, it shall be the Purchaser’s responsibility to furnish Global with an appropriate exemption certificate at time of order.

Ordering Information

Global requires that all orders be submitted in writing and will be acknowledged on Global’s acknowledgement forms governing the transaction.

The details appearing on this acknowledgement will describe the items to be shipped and the approximate shipping date. It is the Purchaser’s responsibility to determine that the information in the acknowledgment is correct. In the event of an error, the Purchaser must notify their Global Customer Service representative immediately by telephone followed by written confirmation. Shipping dates are assigned to orders based on the items having the longest manufacturing lead time (unless instructed to partial ship).

At time of order, please provide the following information:

1. Account number (if possible)
2. PO number
3. “Bill to” and/or “Ship to” and name and address
4. Complete model number and selected options including textiles/finishes
5. Special instructions and tag information
6. Shipping instructions, please indicate:
 - a. pick up
 - b. Global trailer program
 - c. common carrier, provide name of carrier, your account number
7. Special quote (SQ) # or MTM # (if applicable)
8. Customer’s Own Material (COM), Global Purchased Material (GPM), Customer’s Own Leather (COL), see below.
9. For specials and custom quoted product, please indicate the custom quote # on your PO. If changes are made to the quote a new quote must be issued prior to submitting the order. It is the Purchaser’s responsibility to determine that the information on the quote is correct. Global will not be responsible for wrong product due to errors in the quote.

The above points will be checked by Global for accuracy. Global will process orders using the codes provided by the Purchaser. Price discrepancy is the responsibility of the Purchaser. The Purchaser must notify Global prior to invoicing.

The Purchaser is responsible for providing correct information at time of order. If no option(s) are selected the system will default to standard feature(s). Orders with missing/incorrect information (finish, etc.) will be put on hold until all information is complete. Orders will be scheduled for manufacturing upon receipt of complete information.

Changes and Cancellations

After the date of Global’s acknowledgment of the Purchaser’s order, the order may not be changed or cancelled by the Purchaser without the written consent of Global. Orders for products upholstered in “special order textiles” (GPM) cannot be cancelled once material has been purchased. Special order items, COM and textile-covered items already in production are not subject to change or cancellation under any circumstances. Textile-covered items are considered to be in production once the textile is scheduled for cutting. Other standard items already in production are subject to a minimum 35% cancellation charge.

Errors and Omissions

All quotations, acknowledgements and invoices are subject to corrections for any errors and omissions.

Casters

The list price book specifies the caster which comes standard with each chair model. Most chairs are equipped with C1 or C65 casters which are best used on carpeted surfaces. If it is intended to use the product on hard surfaces such as ceramics, concrete, linoleum or hardwood, it is recommended to use different casters. It is the responsibility of the customer to determine the standard caster for a particular product and whether such caster is appropriate for the given application. The Arm and Caster section illustrates the caster options offered by Global and their suggested uses.

FINISHES

Seating Finishes - Painted

Where painted frames are not a standard color, a special quote is required.

Seating Finishes - Wood Stains

A one time setup fee of \$250 net will be applied per order for custom wood staining/color matching requests. This payment will be valid for 5 years from the date it is set up. After 5 years, the \$250 setup fee will apply again. Restrictions may apply. The customer must provide a 3” x 3” color chip/sample.

For application of customer’s own wood stain, there will be an upcharge of 10% list price, per unit (in addition to the option upcharge, when applicable). For orders with custom stain unit quantities of 30 or more, the upcharge may be reduced or eliminated. A [Special Product Request](#) must be submitted for a quotation.

Custom Wood Staining

Custom wood staining procedure for wood seating is as follows. Customer provides a sample of the desired wood finish. That sample is sent to Specials department. Several finished samples will be sent back. The customer/end user will sign off on the samples (keeping one for their records) and return the rest of the samples. Global will not necessarily match the wood species but rather will generate a color that will coordinate with the sample when it is applied to the wood species used in the seating frame.

File Finishes

There is no upcharge on any standard file finish. Any non-standard file finish must be approved by Global prior to acceptance of order and may be subject to an upcharge.

9100 Series, 9100 Plus Series, 9300 Series, 9300 Plus Series, 9700 Series, G Series Pedestals, and E Series Pedestals can be ordered in non-standard finishes with a 10% upcharge on orders up to and including 10 units. There is no upcharge on orders of 11 units or more.

Please note:

- You can only combine 9100 Series files and 9100 Plus Series files to meet the 11 unit minimum.
- You can only combine 9300 Series, 9300 Plus Series, and 9700 series to meet the 11 unit minimum.

An upcharge of 10% will apply to Metallic, Mica, Tungsten and any non-standard White finishes regardless of the number of units ordered.

Wood Veneer Finishes

Because the distinctive characteristics and the nature of wood products cause variations, exact matches are not always possible. Global will not be held responsible if the finishes cannot be matched.

Customer's Own Material (COM)

Use of COM must be approved by Global prior to acceptance of order. Please submit the Authorization Request Form. Photocopy and use this form as often as necessary. The customer must provide a 12" x 12" textile sample and advise how the textile is to be applied and quantity of textile being sent. **Textile yardage requirement will be advised by the factory, and additional yardage may be required if pattern requires matching.** Upon approval from Global, send textile to the COM Department at: 596 Supertest Road, Toronto ON, M3J 2M5. Send to the address provided on shipping document upon approval from Global. If COM is difficult to apply or if product is required to be modified, extra charges will apply. Global reserves the right to cancel an order at any time if COM is inadequate for any reason. COM must be shipped freight and duties paid if applicable to our factory. Such shipment must be fully identified with the Purchaser's order number, and the item for which the material is intended. Performance of COM when applied to product is the sole responsibility of the Purchaser. Global's standard product warranty shall not apply to COM.

COM price is the lowest published price/grade for the series. The published yardage requirement for COM orders is approximate and shown beside each item in the list price book. The yardage shown there is based on the textile requirements for cutting and sewing a single chair in a plain patterned textile. For textiles with a pattern repeat or for COM orders involving 10 or more chairs, please consult with Customer Service for recalculation of the yardage requirements as this may significantly change the textile requirement.

Textile Grading

All products are priced according to their standard textile grade. Lower grade textiles may be available but at the same price as standard textile grade. See Textiles and Finishes section for graded textiles.

Combining two grades of textiles may result in a revised grade. Please refer to "Two Grades Combination Chart" in the Textiles and Finishes section. For more than two textiles a special quotation is required.

Global Purchased Material, Customer Specified (GPM)

Global may purchase material specified by the customer. Use of GPM must be approved by Global prior to acceptance of order. If it is difficult to apply or if product is required to be modified, extra charges will apply. Global reserves the right to cancel an order at any time if GPM is inadequate for any reason. Performance of GPM when applied to product is the sole responsibility of the textile vendor. Global's standard warranty will not apply to GPM materials.

Customer's Own Leather (COL)

Not all seating can be upholstered in leather. Please consult service notes for availability. COL price is the lowest published grade for the series (leather or fabric).

Upholstery Coverings

Slight variations in color may occur between dye lots. Although Global attempts to minimize these variances, they do occur and must be accepted as normal and will not be considered defects.

Leather is a Natural Product

Natural variations occur in the color, grain and texture of leather. As a result, a degree of variation should be expected. As leather is used it develops a patina. Its color changes slightly, it will get marked and it will stretch and pull, these are the hallmarks of genuine leather and are not considered defects.

Yardage

Required yardage (yd) is based on unmatched materials with widths of 54" for seating, 63" for panels.

Arms

A wide selection of arms are available for some series. See Arm Chart in the Seating list price book.

Weight

In the Seating list price book, weight is provided for both unit weight and carton weight. In the Desking + Tables and Metal Filing + Storage list price books, carton weight is provided.

Delays

Global's order acknowledgment will state a shipping date which is Global's best estimate at the time the order is acknowledged. However, Global shall not incur any obligation or liability to the Purchaser for failure to ship by specified date unless Global has agreed to an unequivocal shipping date in a separately signed written document executed by its authorized personnel at its head office. In addition, Global will not be liable for any loss or damage resulting from any delay or failure in shipment or other failure to perform all or any part of the agreement between the parties with respect to the goods shown on the face of the order acknowledgement where such delay, failure, loss or damage is the proximate result of any act of any governmental authority or political subdivision thereof, revolution, riot, civil disorder or disturbance, delay or default in transportation, strike disputes among or between labor unions or other labor disputes, delay or inability in obtaining materials and facilities, fire, flood, act of God or any cause not within the reasonable control of Global.

Free on Board (FOB)

FOB point is Global's Factory, Toronto, Ontario, Canada.

Courier Type Shipments

This symbol is used to indicate that the adjacent product can be sent by courier type shipments, such as Federal Express, Purolator, CanPar and UPS.

Shipping

The Purchaser must select, at time of order, one of two methods of freight payment. Global will make no end-user shipments unless special arrangements have been made.

1. FOB point of shipment, freight collect - pick up and common carrier.
2. FOB point of shipment, freight prepaid and invoiced to the Purchaser - Global Trailer Program.

All deliveries are dock to dock.

Service

Service requests are normally the responsibility of Global's authorized Dealers. Where this cannot be accomplished on a local level, service problems should be referred to Global's Customer Service Department.

Global/Express (Canada)
Tel: (905) 660-5101 or 1-800-567-8901
Fax: (905) 660-4759 or 1-800-375-5134

Global International
Tel: (416) 661-3660
Fax: (416) 661-661-0983 or 1-877-585-5579

Returns

No returns of goods will be accepted without written consent and shipping instruction from Global. A minimum re-stocking charge of 35% is made on all authorized returns for credit or refund, provided goods are received by Global in the condition in which they left the factory. This may increase depending on the type of product. Global's Return Goods Authorization (RGA) numbers must appear prominently on all authorized returns. Global will not be responsible

for return freight costs. No credit will be given if goods cannot be reused as new. Special order items, non-stock items and COM products are in no event subject to return. All returns must be approved and authorized in writing by Global Customer Service. Global reserves the right to refuse delivery of any unauthorized returns.

Claims

All goods are sold FOB plant or Global Distribution Center. Global is not responsible for damage which occurs in transit (or in storage). The carrier signs for all goods received in apparently good order. It is the Purchaser's responsibility to examine goods upon receipt and to file any claims with the carrier for losses or damage to the product occurring during transit, including concealed damage.

Any claims made against Global for apparent defects, errors or shortages must be made by the Purchaser, in writing, within 15 working days after any delivery. Failure by the Purchaser to make any claim against Global within 15 days shall constitute acceptance of the goods and a waiver of any apparent defects, errors or shortages.

Suspension

In the event that the Purchaser defaults in the payment of any sum due to Global, or in the event the Purchaser's financial condition becomes unsatisfactory to Global, Global shall have the right to defer or discontinue shipment of any goods until such time as the default is cured or the Purchaser provides assurance of payment to Global.

Copyright

All catalogs, photographs, drawings, list price books and other printed materials are protected by copyright. All rights reserved.

Trademarks

All trademarks are owned by Global Furniture Group other than OBUSFORME™ which is owned by OBUSFORME LTD CO., a division of Homematics Inc., MOR-CARE which is owned by MORBERN INC, Perma-Mesh which is the property of J.B. Research Inc. SCHUKRA™ which is owned by SCHUKRA MANUFACTURING INC. OBUSFORME® and the distinctive backrest design are registered trademarks of OBUSFORME LTD CO.

Designs and Patents

Many of the products produced by Global are protected by design registrations, design patents and/or patents. Design and specifications are subject to change, discontinuance or additions without notice.

For a full listing of issued trademarks, please visit globalfurnituregroup.com.

Cubic Measure

The stated volume is an approximate cubic foot measure that may be used to calculate freight costs. The figure shown is the total shipping volume of a unit (e.g. if a part is sent in 2 cartons the volume indicated reflects both cartons together) and is subject to change without notice. It is most economical to purchase the specified number per carton.

Combined Shipments

Global will make every effort to combine shipments and orders on written request. However, Global cannot be held responsible where such requests are not complied with.

Offer of Sale

Possession of this list price book or any other literature shall not imply the company's willingness to sell to the holder and shall not be construed as a direct offer of sale.

If a conflict arises between: (i) prices found in software support packages furnished to the customer by Global or by any other source on behalf of Global; and (ii) Global's current pricing found on Global's website, then the most current shall prevail.

Testing Qualifications

Many Global products pass or exceed the most stringent industry testing standards.

Disclaimer

Metric dimensions are provided for seating products for reference only. In the event that there is a discrepancy between imperial measurements and metric measurements, imperial measurements shall prevail. Prices shown are current manufacturer's suggested list prices at time of printing. Updated pricing is available on Global's website. All applicable taxes are extra. Descriptions, specifications and prices are subject to change without notice. Errors and omissions are subject to correction.

Fire Codes

Flame resistant components are most often requested to be tested to comply with California Technical Bulletin 11, often referred to as CAL117. The foam used in Global chairs meets the requirements of California TB117 and all of the upholstery fabrics Global offers meet this requirement. In addition, most Global seating models can be certified to California TB133. This available certification can be done when selected seating models are upholstered in specific textiles. The list of certifiable seating models and available textiles changes from time to time. Please contact Customer Service for a list of certifiable models and upholstery materials. There are other fire codes that are not commonly specified. Global Upholstery Ltd. can usually provide test results for any North American code. Please contact Customer Service. Please see chart below for CAL TB 133 upcharges and for complete CAL TB 133 information refer to the Global Dealer Centre.

**WARNING - SEATING PRODUCTS
TO PREVENT PRODUCT FAILURE AND POSSIBLE INJURY:**

Ensure that the appropriate selection is made for the intended use of the chair including user's weight. Some chairs are not recommended for users above a certain weight. Frequently inspect the chair for visible cracks and tighten all screws, bolts and adjustable knobs. If the chair is damaged or unstable, immediately remove it from service.

Any information or suggestions concerning applications, specifications or compliances with codes and standards is provided solely for your convenient reference and without any representation as to accuracy or suitability. Global disclaims any legal responsibility. The user must verify and test the suitability of any information or products for his specific application. Global reserves the right to change the Terms and Conditions in the list price book without notice.

This list price book is effective as of January 1, 2023.

For periodic updates, please check the PDF at globalfurnituregroup.com. After login, select Resources then Price Lists. From here you will have the option to select either the Seating, Desking + Tables or Metal Filing + Storage price list books. Global warrants that all commercial products are free from defects in material and workmanship, for the life of the product, to the original Purchaser.

Global warrants that all commercial products are free from defects in material and workmanship, for the life of the product, to the original Purchaser.

Global will repair or replace, at Global’s option, as the sole remedy for any defect covered by the warranty. The warranty applies to products manufactured after March 22, 2016.

Global makes no warranty that any of its products are suitable for any particular purpose and makes no other warranties, express or implied, other than those set out here. As codes and standards vary from one jurisdiction to another, references to compliance are solely for convenience and without any representation as to accuracy or suitability. Users must verify the suitability of such information or product for their specific application. In no event shall Global be liable in either tort or contract for any loss or direct, special, incidental, consequential, or exemplary damages.

Files, Desks, Modular Furniture, Tables, Panels & Accessories

Global warrants all components of metal storage and filing, laminate and wood veneer desks, laminate and wood veneer tables, metal leg components and panels for the lifetime of the product to the original Purchaser.

The warranty applies to single shift, standard commercial usage, defined as a standard eight (8) hour day, forty (40) hour week. Load restrictions apply, refer to individual product descriptions.

Exceptions to the warranty for files/desks/tables and panels are as follows:

- Electrical devices, panel and tackboard textiles, adjustable keyboard mechanisms, non-electrical table mechanisms, monitor arms, lecterns, coat trees and task lights - five (5) years
- Laminate folding tables - one (1) year
- Motorized electrical components - two (2) years
- Keyless lock options - two (2) years

Files, Desks, Modular Furniture, Tables, Panels & Accessories Warranty Summary

Product Type	Components Warranty For Original Purchaser	Exceptions
Metal storage and filing	lifetime	keyless lock options - 2 years
Laminate/wood veneer desks and modular furniture	lifetime	tackboard textiles, electrical devices, task lights - 5 years
Boardroom, conference and training tables	lifetime	electrical devices - 5 years moving parts - 5 years
Panels	lifetime	panel textiles, electrical devices, task lights - 5 years
Coat racks and lecterns	5 years	none
Folding tables (laminate & molded)	1 year	none
Height adjustable tables	5 years	motorized parts (on electrical tables) - 2 years

Global’s warranty does not apply (for any product category) to the following:

- Nominal or normal amount of wear and tear that can occur over time
- Failures which result from negligence, abuse, accident or misuse
- Failure to apply, install or maintain products according to Global’s written instructions and warnings
- Modifications, attachments or repair methods not approved by Global
- Damage caused by a carrier in transit, or delivery/installation contractors
- The matching of colors, grains or textures (wood, leather, etc.) of natural materials
- Products exposed to extreme hot or cold temperatures or excessively dry or humid environments
- Color fastness or the matching of color of textiles, dye lots of textile can vary
- Damage by markings or staining; damage by sharp objects or imprinting from instruments
- Damage to textiles or laminate and wood surfaces/edges from exposure to sunlight (including UV rays)
- Products not purchased directly from authorized Global resellers
- Products used for rental purposes
- Purchased parts are warranted for one (1) year
- Failure to follow specific cleaning and disinfecting instructions posted on globalfurnituregroup.com

Global’s warranty does not cover the costs of transportation or labor. Repair or replacement will be at Global’s discretion.

Textiles and Finishes

Global textiles and finishes are updated periodically to meet the demand and trends of the market. As a result, some textiles and finishes may be discontinued by Global or the manufacturer. In the event that a textile or finish is discontinued, Global will make every reasonable effort to provide an alternative product(s) of comparable function.

INDEX

42CX	313	A2036SC	39	A2430N	24	A2465ESHL	43	A3036T	22	A3072SPR	12
42CZ	312	A2036SCS	39	A2430PT	41	A2465ESHR	43	A3042L	23	A3072T	22
42SH	313	A2036SK	47	A2430R	23	A2466CK	16	A3042LK	24	A3072URB	30
42SZ	313	A2037ESHL	44	A2430RK	25	A2466CSL	16	A3042LN	25	A3072URD	30
48C	312	A2037ESHR	44	A2430RN	26	A2466CSR	16	A3042N	24	A3636TBC	43
48CX	313	A2042EL	14	A2430T	22	A2466D4	16	A3042R	23	A3660FPL	28
48CZ	312	A2042ER	14	A2436AV	47	A2466FFL	19	A3042RK	25	A3660FPPR	28
48SH	313	A2042FB	15	A2436DI	41	A2466FFR	20	A3042RN	26	A3660IPL	28
48SZ	313	A2042FL	14	A2436FB	15	A2466FI	26	A3042T	22	A3660IPR	28
60C	312	A2042FR	14	A2436L	23	A2466FNL	19	A3048FSL	15	A3660PL	28
60CX	313	A2042L4	14	A2436LK	24	A2466FNR	21	A3048FSR	15	A3660PPR	28
60CZ	312	A2042R4	14	A2436LN	25	A2466I	27	A3048L	23	A3665DI	41
60RC	312	A2048EL	14	A2436MDL	37	A2466L	23	A3048LK	24	A3665ROD	41
60SH	313	A2048ER	14	A2436MDLS	38	A2466LK	24	A3048LN	25	A3665SH	41
60SZ	313	A2048FB	15	A2436MDR	37	A2466LN	25	A3048N	24	A3665VSL	41
3366	450	A2048FL	14	A2436MDRS	38	A2466N	24	A3048P4L	15	A3666CHL	33
3367	450	A2048FR	14	A2436MSC	38	A2466NFL	19	A3048P4R	15	A3666CHR	33
3368	450	A2048L4	14	A2436N	24	A2466NFR	21	A3048R	23	A3666FPL	28
3400	449	A2048R4	14	A2436R	23	A2466NNL	20	A3048RK	25	A3666FPPR	28
3401	449	A2049ESHL	43	A2436RK	25	A2466NNR	22	A3048RN	26	A3666IPL	28
3402	449	A2049ESHR	43	A2436RN	26	A2466R	23	A3048S4L	13	A3666IPR	28
3870	450	A2060CK	16	A2436ROD	41	A2466RK	25	A3048S4R	13	A3666PL	28
3871	450	A2060CSL	16	A2436S2	38	A2466RNL	26	A3048SPL	12	A3666PR	28
3878	451	A2060CSR	16	A2436SCS	39	A2466S2L	17	A3048SPR	12	A3666PRL	28
3879	451	A2060D4	16	A2436SH	41	A2466S2R	17	A3048T	22	A3672CHL	33
3880	451	A2060S2L	17	A2436T	22	A2466S4L	16	A3060D4	12	A3672D4	12
7885	443	A2060S2R	17	A2442EL	14	A2466S4R	16	A3060DP	12	A3672DB4	12
7886	443	A2060S4L	16	A2442ER	14	A2466T	22	A3060FI	26	A3672DIP	12
7887	443	A2060S4R	16	A2442FB	15	A2472CK	16	A3060FIC	27	A3672DPB	12
7888	443	A2065ESHL	43	A2442FL	14	A2472CSL	16	A3060FIL	26	A3672FI	26
7889	443	A2065ESHR	43	A2442FR	14	A2472CSR	16	A3060FIR	27	A3672FIC	27
	A	A2066CK	16	A2442KRL	30	A2472CT	40	A3060I	27	A3672FIL	26
A5L	46	A2066CSL	16	A2442KRR	30	A2472D4	16	A3060L	23	A3672FIR	27
A18Z	46	A2066CSR	16	A2442L	23	A2472FL	19	A3060LK	24	A3672FPL	28
A20FL	40	A2066D4	16	A2442L4	14	A2472FFR	20	A3060LN	25	A3672FPPR	28
A20PTBBF	41	A2066FFL	19	A2442LK	24	A2472FNL	19	A3060N	24	A3672I	27
A20PTFF	40	A2066FFR	21	A2442LN	25	A2472FNR	21	A3060R	23	A3672IPL	28
A24FL	40	A2066FNL	19	A2442N	24	A2472L	23	A3060RK	25	A3672IPR	28
A24PTBBF	41	A2066FNR	21	A2442R	23	A2472LF2	17	A3060RN	26	A3672IPL	28
A24PTFF	40	A2066NFL	20	A2442R4	14	A2472LF	17	A3060S4L	13	A3672PL	28
A30HOCB	32	A2066NFR	21	A2442RK	25	A2472LKL	17	A3060S4R	13	A3672PR	28
A36CH	32	A2066NNL	20	A2442RN	26	A2472LKR	18	A3060SPL	12	A3672RE	45
A36HOCB	32	A2066NNR	22	A2442RRL	30	A2472LNR	25	A3060SPR	12	A3672RT	46
A36R	45	A2066S2L	17	A2442RRR	30	A2472LS	17	A3660T	22	A3672S4L	13
A40RS	29	A2066S2R	17	A2442T	22	A2472N	24	A3066D4	12	A3672S4LB	13
A42CH	32	A2066S4L	16	A2442URL	31	A2472NFI	19	A3066DP	12	A3672S4R	13
A42HOCB	32	A2066S4R	16	A2442URR	31	A2472NFR	21	A3066DP	12	A3672S4RB	13
A42R	45	A2072C	15	A2445PB	46	A2472NLR	20	A3066FI	26	A3672SLB	13
A42RS	29	A2072CK	16	A2448EL	14	A2472NNL	20	A3066FIC	27	A3672SPL	12
A48HOCB	32	A2072CSL	16	A2448ER	14	A2472NNR	22	A3066FIL	26	A3672SPR	12
A48R	45	A2072CSR	16	A2448FB	15	A2472R	23	A3066FIR	27	A3672SRB	13
A48RS	29	A2072CT	40	A2448FI	26	A2472RK	25	A3066I	27	A427EIL	27
A50RS	29	A2072D4	16	A2448FL	14	A2472RN	26	A3066L	23	A427EIR	27
A60HOCB	32	A2072DF	19	A2448FR	14	A2472S2L	17	A3066LK	24	A4896B	45
A60RS	29	A2072FFR	21	A2448I	27	A2472S2R	17	A3066LN	25	A4896RE	45
A62RS	29	A2072FNL	19	A2448L	23	A2472S4L	16	A3066N	24	A4896RT	46
A66HOCB	32	A2072FNR	21	A2448L4	14	A2472S4R	16	A3066R	23	A36205C	18
A71HOCB	32	A2072LF2	17	A2448L4	14	A2472SKL	18	A3066RK	25	A42205C	18
A72HOCB	32	A2072LKL	17	A2448LK	24	A2472SKR	18	A3066RN	26	A42245C	18
A1172ORD	31	A2072LKR	18	A2448LN	25	A2472T	22	A3066S4L	13	A48120B	45
A1536ESHL	43	A2072LS	17	A2448N	24	A2472TB	40	A3066S4R	13	A48120RE	45
A1536ESHR	43	A2072NFI	20	A2448R	23	A2488PB	46	A3066SPL	12	A48120RT	46
A1616V	46	A2072NFL	20	A2448R4	14	A2727XB	46	A3066SPR	12	A48144B	45
A1616V2	46	A2072NFR	21	A2448RK	25	A3029ESHL	43	A3066T	22	A48144RT	46
A1844LC	47	A2072NNL	20	A2448RNL	26	A3029ESHR	43	A3072D4	12	ABC48	42
A2020SK	47	A2072NNR	22	A2448S4L	13	A3030L	23	A3072DIP	12	ABC65	42
A2029ESHL	43	A2072S2L	17	A2448S4R	13	A3030LK	24	A3072FI	26	ABC72	42
A2029ESHR	43	A2072S2R	17	A2448SPL	12	A3030LN	25	A3072L	23	ABCSHELF	42
A2029ESHL	43	A2072S4L	16	A2448SPR	12	A3030N	24	A3072LK	24	ADDOOR30	33
A2036FB	15	A2072S4R	16	A2448T	22	A3030R	23	A3072LN	25	ADDOOR36	33
A2036KM	40	A2072SKL	18	A2460FI	26	A3030RK	25	A3072N	24	ADDOOR36C	33
A2036LF	38	A2072SKR	18	A2460I	27	A3030RN	26	A3072R	23	ADDOOR42	33
A2036MDL	37	A2072TB	40	A2460L	23	A3030T	22	A3072RD	29	ADDOOR42C	33
A2036MDLS	38	A2222MT	42	A2460LK	24	A3036L	23	A3072RDL	29	ADDOOR48	33
A2036MDR	37	A2248MT	42	A2460LN	25	A3036LK	24	A3072RDR	29	ADDOOR60	33
A2036MDRS	38	A2429ESHL	43	A2460N	24	A3036LN	25	A3072RK	25	ADDOOR66	33
A2036MSC	38	A2429ESHR	43	A2460R	23	A3036N	24	A3072RNL	26	ADDOOR66C	33
A2036S2	38	A2430L	23	A2460RK	25	A3036R	23	A3072RN	26	ADDOOR71	33
A2036S3	39	A2430LK	24	A2460RN	26	A3036RK	25	A3072S4L	13	ADDOOR71	33
A2036S4	39	A2430LN	25	A2460T	22	A3036RNL	26	A3072S4R	13	ADDOOR72	33
								A3072SPL	12	ADDOOR72C	33

ADOOR3636.....	43	B30SPLEG.....	387	B3660REF.....	365	BS3072REC.....	384	CNQ3030.....	405	CNRC2448.....	407
AFPPBF19.....	44	B30WFEF.....	367	B3672HMF.....	368	BSFMS.....	370	CNQ3636.....	405	CNRC2454.....	407
AFPPBF22.....	44	B30WES.....	367	B3672REF.....	365	BSWFM.....	370	CNQ2424.....	407	CNRC2460.....	407
AFPPBF28.....	44	B36KSF.....	367	B3672TRF.....	366	BWMD22.....	371	CNQC3030.....	407	CNRC2466.....	407
AFPPF19.....	44	B36WEF.....	367	B249072AV.....	378	BWMS5.....	371	CNQC3636.....	407	CNRC2472.....	407
AFPPF22.....	44	B44LEC.....	378	BB20KSF.....	385	BX24KSS.....	374	CNR2030.....	401	CNRC3036.....	407
AFPPF28.....	44	B56S.....	371	BB20WE.....	386	BX24WES.....	374	CNR2036.....	401	CNRC3042.....	407
AHPBF18.....	44	B62S.....	371	BB24KSF.....	385	BX30KSS.....	374	CNR2042.....	401	CNRC3048.....	407
AHS36.....	32, 56	B71S.....	371	BB24WE.....	386	BX30WES.....	374	CNR2048.....	401	CNRC3054.....	407
AHS42.....	32, 56	B2030FRF.....	369	BB30CN.....	386	BX36QMP.....	370, 375	CNR2430.....	401	CNRC3060.....	407
AHS48.....	32, 56	B2036FRF.....	369	BB30KSF.....	385	BX42QMP.....	370, 375	CNR2436.....	401	CNRC3066.....	407
AHS60.....	32, 56	B2036REF.....	365	BB2036REC.....	385	BX48QMP.....	370, 375	CNR2442.....	401	CNRC3072.....	407
AHS66.....	32, 56	B2036RES.....	365	BB2036RRE.....	386	BX60QMP.....	370, 375	CNR2448.....	401	CNRC3648.....	407
AHS71.....	32, 56	B2036TRF.....	369	BB2042REC.....	385	BX66QMP.....	370, 375	CNR3036.....	401	CNRC3642.....	407
AHS72.....	32, 56	B2040HMF.....	368	BB2042RRE.....	386	BX72QMP.....	370, 375	CNR3042.....	401	CNRC3654.....	407
ALF20TB.....	39	B2042REF.....	365	BB2048REC.....	385	BX2442RES.....	374	CNR3048.....	401	CNRC3660.....	407
ALF24TB.....	39	B2042RES.....	365	BB2048RRE.....	386	BX2448RES.....	374	CNR3642.....	401	CNRC3666.....	407
AMPBBF19.....	44	B2042RWF.....	369	BB2054RRE.....	386	BX2460RES.....	374	CNR3648.....	401	CNRC3672.....	407
AMPBBF22.....	44	B2048REF.....	365	BB2060REC.....	385	BX2460TRS.....	374	CNRA2030.....	403	CNRU2054.....	401
AMPBBF28.....	44	B2048RES.....	365	BB2072REC.....	385	BX2466RES.....	374	CNRA2036.....	403	CNRU2060.....	401
AMPBF19.....	45	B2060REF.....	365	BB2436REC.....	385	BX2466TRS.....	374	CNRA2042.....	403	CNRU2066.....	401
AMPBF22.....	45	B2060RES.....	365	BB2436RRE.....	386	BX2472RES.....	374	CNRA2048.....	403	CNRU2072.....	401
AMPBF28.....	45	B2060TRS.....	366	BB2442REC.....	385	BX2472TRS.....	374	CNRA2054.....	403	CNRU2454.....	401
AMPFF19.....	45	B2066TRS.....	366	BB2442RRE.....	386	BX3042RES.....	374	CNRA2060.....	403	CNRU2460.....	401
AMPFF22.....	45	B2072BUF.....	378	BB2448HMF.....	386	BX3048RES.....	374	CNRA2066.....	403	CNRU2466.....	401
AMPFF28.....	45	B2072REF.....	365	BB2448REC.....	385	BX3060RES.....	374	CNRA2072.....	403	CNRU2472.....	401
AOOS30.....	31	B2072RES.....	365	BB2448RRE.....	386	BX3060TRS.....	374	CNRA2430.....	403	CNRU3054.....	401
AOOS36.....	31	B2072TRS.....	366	BB2454RRE.....	386	BX3066RES.....	374	CNRA2436.....	403	CNRU3060.....	401
AOOS42.....	31	B2424SQF.....	368	BB2460REC.....	385	BX3066TRS.....	374	CNRA2442.....	403	CNRU3066.....	401
AOOS48.....	31	B2436FRF.....	369	BB2472REC.....	385	BX3072RES.....	374	CNRA2448.....	403	CNRU3072.....	401
AOOS60.....	31	B2436REF.....	365	BB3036REC.....	385	BX3072TRS.....	374	CNRA2454.....	403	CNRU3654.....	401
APOKL22.....	42, 58, 265	B2436RES.....	365	BB3036RRE.....	386	BXK132QMP.....	372, 376	CNRA2460.....	403	CNRU3660.....	401
APOKL28.....	42, 58, 265	B2442FRF.....	369	BB3042REC.....	385	BXK132S.....	376	CNRA2466.....	403	CNRU3666.....	401
ASC20TB.....	39	B2442REF.....	365	BB3042RRE.....	386	BXK156QMP.....	373, 377	CNRA2472.....	403	CNRU3672.....	401
ASC24TB.....	39	B2442RES.....	365	BB3048REC.....	385	BXK180QMP.....	373, 377	CNRA3036.....	403	CNS2424.....	401
AT6030.....	452	B2442TRF.....	369	BB3048RRE.....	386	BXL60QMP.....	370, 375	CNRA3042.....	403	CNS3030.....	401
AT7230.....	452	B2448HMF.....	368	BB3054RRE.....	386	BXL66QMP.....	370, 375	CNRA3048.....	403	CNS3636.....	401
AT7236.....	452	B2448HMS.....	368	BB3060HMF.....	386	BXL72QMP.....	370, 375	CNRA3054.....	403	CNSA2424.....	404
ATB36CH.....	35	B2448REF.....	365	BB3060REC.....	385	BXM60QMP.....	370, 375	CNRA3060.....	403	CNSA3030.....	404
ATB42CH.....	35	B2448RES.....	365	BB3072REC.....	385	BXM66QMP.....	370, 375	CNRA3066.....	403	CNSA3636.....	404
ATB66CH.....	35	B2448RWF.....	369	BK132S.....	372	BXM72QMP.....	370, 375	CNRA3072.....	403	CNSA3648.....	406
ATB72CH.....	35	B2460REF.....	365	BK156F.....	373	BXWQMP.....	370, 375	CNRA3642.....	403	CNSB3030.....	406
ATB2816.....	35	B2460RES.....	365	BK156S.....	373			CNRA3648.....	403	CNSB3636.....	406
ATB3416.....	35	B2460TRF.....	366	BK180F.....	373			CNRA3654.....	403	CNSC2424.....	408
ATB4016.....	35	B2460TRS.....	366	BK180S.....	373			CNRA3660.....	403	CNSC3030.....	408
ATB4616.....	34	B2466TRF.....	366	BS20KSF.....	384			CNRA3666.....	403	CNSC3636.....	408
ATB5816.....	34	B2466TRS.....	366	BS20WE.....	384			CNRA3672.....	403	CNT2048.....	401
ATB6416.....	34	B2472REF.....	365	BS24KSF.....	384			CNRB2430.....	405	CNT2060.....	401
ATB6916.....	34	B2472RES.....	365	BS24WE.....	384			CNRB2436.....	405	CNT2448.....	401
ATB7016.....	34	B2472TRF.....	366	BS30CN.....	384			CNRB2442.....	405	CNT2460.....	401
ATBC36SH.....	43	B2472TRS.....	366	BS30KSF.....	384			CNRB2448.....	405	CNT3060.....	401
AVB4848.....	47	B3030SQF.....	368	BS2036REC.....	384			CNRB2454.....	405	CNT3072.....	401
AVS14.....	32, 56	B3036REF.....	365	BS2036RRE.....	385			CNRB2460.....	405	CNT3660.....	401
AWHT3019.....	36	B3036RES.....	365	BS2042REC.....	384			CNRB2466.....	405	CNT3672.....	401
AWHT3619.....	36	B3042FRF.....	369	BS2042RRE.....	385			CNRB2472.....	405	CNTA2448L.....	404
AWHT4219.....	36	B3042REF.....	365	BS2048REC.....	384			CNRB3036.....	405	CNTA2448S.....	404
AWHT4819.....	36	B3042RES.....	365	BS2048RRE.....	385			CNRB3042.....	405	CNTA2460L.....	404
AWHT6019.....	37	B3048FRF.....	369	BS2054RRE.....	385			CNRB3048.....	405	CNTA2460S.....	404
AWHT6619.....	37	B3048REF.....	365	BS2060REC.....	384			CNRB3054.....	405	CNTA3060L.....	404
AWHT7219.....	37	B3048RES.....	365	BS2072REC.....	384			CNRB3060.....	405	CNTA3060S.....	404
AWHT7819.....	37	B3048TRF.....	369	BS2436REC.....	384			CNRB3066.....	405	CNTA3072L.....	404
AWHT8419.....	37	B3057RWF.....	369	BS2436RRE.....	385			CNRB3072.....	405	CNTA3072S.....	404
		B3060HMF.....	368	BS2442REC.....	384			CNRB3642.....	405	CNTA3660L.....	404
	B	B3060HMS.....	368	BS2442RRE.....	385			CNRB3648.....	405	CNTA3660S.....	404
B2XSPLEG.....	387	B3060REF.....	365	BS2448HMF.....	384			CNRB3654.....	405	CNTA3672L.....	404
B6PLT.....	387	B3060RES.....	365	BS2448REC.....	384			CNRB3660.....	405	CNTA3672S.....	404
B20KSF.....	366	B3060TRF.....	366	BS2448RRE.....	385			CNRB3666.....	405	CNTB2448L.....	406
B20KSS.....	367	B3060TRS.....	366	BS2454RRE.....	385			CNRB3672.....	405	CNTB2448S.....	406
B20WEF.....	367	B3066TRF.....	366	BS2460REC.....	384			CNRC2030.....	407	CNTB2460L.....	406
B20WES.....	367	B3066TRS.....	366	BS2472REC.....	384			CNRC2036.....	407	CNTB2460S.....	406
B23IFMS.....	371	B3067REF.....	365	BS3036REC.....	384			CNRC2042.....	407	CNTB2460L.....	406
B24KSF.....	366	B3072RES.....	365	BS3036RRE.....	385			CNRC2048.....	407	CNTB3060S.....	406
B24KSS.....	367	B3072TRF.....	366	BS3042REC.....	384			CNRC2054.....	407	CNTB3072L.....	406
B24WFEF.....	367	B3072TRS.....	366	BS3042RRE.....	385			CNRC2060.....	407	CNTB3072S.....	406
B24WES.....	367	B3636SQF.....	368	BS3048REC.....	384			CNRC2066.....	407	CNTB3660L.....	406
B29IFMS.....	371	B3642REF.....	365	BS3048RRE.....	385			CNRC2072.....	407	CNTB3660S.....	406
B29TPLEG.....	387	B3648FRF.....	369	BS3054RRE.....	385			CNRC2430.....	407	CNTB3672L.....	406
B30IFMS.....	371	B3648REF.....	365	BS3060HMF.....	384			CNRC2436.....	407	CNTB3672S.....	406
B30KSF.....	366	B3652FRF.....	369	BS3060REC.....	384			CNRC2442.....	407	CNTC2048L.....	408
B30KSS.....	367										

INDEX

CNTC2048S	408	CT6RX	314	DATT24	301	DLP1230	298	DRGP3648	298	EL10A	319
CNTC2060L	408	CT6RZ	314	DATT29	301	DLP1236	298	DRGP3660	298	EL10R	320
CNTC2060S	408	CT8B	316	DATT30	301	DLP1242	298	DRGP3666	298	EL10W	319
CNTC2448L	408	CT8BA	316	DATT36	301	DLP1248	298	DRGP3672	298	EL10WA	319
CNTC2448S	408	CT8BX	315	DATT42	301	DLP1260	298	DTA1832P	413	EL10WR	320
CNTC2460L	408	CT8BZ	316	DATT48	301	DLP1266	298	DTB1220	294	EL10WX	318
CNTC2460S	408	CT8R	315	DATT54	301	DLP1272	298	DTB1224	294	EL10WZ	319
CNTC3060L	408	CT8RA	314	DATT60	301	DLP1820	298	DTB1229	294	EL10X	318
CNTC3060S	408	CT8RX	314	DATT66	301	DLP1824	298	DTB1230	294	EL10Z	319
CNTC3072L	408	CT8RZ	314	DATT72	301	DLP1829	298	DTB1236	294	EL12W	319
CNTC3072S	408	CT8WB	316	DC1GC36	302	DLP1830	298	DTB1242	294	EL12WA	319
CNTC3660L	408	CT8WBA	316	DC1GC42	302	DLP1836	298	DTB1248	294	EL12WR	320
CNTC3660S	408	CT8WBX	315	DC2GC36	303	DLP1842	298	DTB1260	294	EL12WX	318
CNTC3672L	408	CT8WBZ	316	DC2GC42	303	DLP1848	298	DTB1266	294	EL12WZ	319
CNTC3672S	408	CT8WR	315	DCTT2W	303	DLP1860	298	DTB1272	294	EL18LPBF	419
CNTFLEG24	409	CT8WRA	314	DCTT4W	304	DLP1866	298	DTB1820	294	EL18LPBFC	419
CNTFLEG30	410	CT8WRX	314	DCTT14	302	DLP1872	298	DTB1824	294	EL18PBF	419
CNTFLG24P	409	CT8WRZ	314	DCTT18	302	DLP2420	299	DTB1829	294	EL18PBF	419
CNTFLG30P	410	CT10B	316	DCTT20	302	DLP2424	299	DTB1830	294	EL18PHDL	419
CNTLEG24	409	CT10BA	316	DCTT23	302	DLP2429	299	DTB1836	294	EL18PHDLC	420
CNTLEG24P	409	CT10BX	315	DCTT24	302	DLP2430	299	DTB1842	294	EL18PHDR	419
CNTLEG30	409	CT10BZ	316	DCTT29	302	DLP2436	299	DTB1848	294	EL18PHDR	419
CNTLEG30P	409	CT10R	315	DCTT30	302	DLP2442	299	DTB1860	294	EL18PHDRC	420
CNTLEG36	409	CT10RA	314	DCTT36	302	DLP2448	299	DTB1866	294	ENAC2924	421
CNTS	410	CT10RX	314	DCTT42	302	DLP2460	299	DTB1872	294	ENAC2924S	421
CNW2424	402	CT10RZ	314	DCTT48	302	DLP2466	299	DTB2420	294	ENAC3524	421
CNW3030	402	CT10WB	316	DCTT54	302	DLP2472	299	DTB2424	294	ENAC3524S	421
CNWA2424	404	CT10WBA	316	DCTT60	302	DLP3620	299	DTB2429	294	ENAC5924	421
CNWA3030	404	CT10WBX	315	DCTT66	302	DLP3624	299	DTB2430	294	ENAC5924S	421
CNWB2424	406	CT10WBZ	316	DCTT72	302	DLP3629	299	DTB2436	294	ENAC7124	421
CNWB3030	406	CT10WR	315	DFS12	300	DLP3630	299	DTB2442	294	ENAC7124S	421
CNWC2424	408	CT10WRA	314	DFS18	300	DLP3636	299	DTB2448	294	ENCVC11	423
CNWC3030	408	CT10WRX	314	DFS24	300	DLP3642	299	DTB2460	294	ENCVOHW1	423
CNY2424	402	CT10WRZ	314	DFS30	300	DLP3648	299	DTB2466	294	ENCVG12	423
CNY3030	402	CT12WB	316	DFS36	300	DLP3660	299	DTB2472	294	ENFC3024	421
CNYA2424	404	CT12WBA	316	DFS42	300	DLP3666	299	DTB3620	295	ENFC3024S	421
CNYA3030	404	CT12WBX	315	DGP1220	295	DLP3672	299	DTB3624	295	ENFC3624	421
CNYB2424	406	CT12WBZ	316	DGP1224	295	DPOST12	300	DTB3629	295	ENFC3624S	421
CNYB3030	406	CT12WR	315	DGP1229	295	DPOST18	300	DTB3630	295	ENFC6024	421
CNYC2424	408	CT12WRA	314	DGP1230	295	DPOST24	300	DTB3636	295	ENFC6024S	421
CNYC3030	408	CT12WRX	314	DGP1236	295	DPOST30	300	DTB3642	295	ENFC7224	421
CPFD1816	445	CT12WRZ	314	DGP1242	295	DPOST36	300	DTB3648	295	ENFC7224S	421
CPFD1821	445	CU1816	445	DGP1248	295	DPOST42	300	DTB3660	295	ENLS182	420
CPFD2416	445	CU1821	445	DGP1260	295	DPOST48	300	DTB3666	295	ENMST1824	420
CPFD2421	445	CU2416	445	DGP1266	295	DRGP1220	296	DTB3672	295	ENST3020	418
CPFD3016	445	CU2421	445	DGP1272	295	DRGP1224	296	DTB3672	295	ENTD4824	417
CPFD3021	445	CU3016	445	DGP1820	295	DRGP1229	296	DTD20	413	ENTD4824C	417
CPPD1816	445	CU3021	445	DGP1824	295	DRGP1230	296	DTS1828P	413	ENTD5424	417
CPPD1821	445	CUP1816	446	DGP1829	295	DRGP1236	296	DTS1828PG	413	ENTD5424C	417
CPPD2416	445	CUP1821	446	DGP1830	295	DRGP1242	296	E		ENTD6024	417
CPPD2421	445	CUP2416	446	DGP1836	295	DRGP1248	296	ECV2PU30B	422	ENTD6024C	417
CPPD3016	445	CUP2421	446	DGP1842	295	DRGP1260	296	ECV2PU30S	422	ENTD6030	417
CPPD3021	445	CUP3016	446	DGP1848	295	DRGP1266	296	ECV2PU36B	422	ENTD6030C	417
CR6B	316	CUP3021	446	DGP1860	295	DRGP1272	296	ECV2PU36S	422	ENTD6630	417
CR6R	315	CY1816	446	DGP1866	295	DRGP1820	297	ECV2PU60B	422	ENTD7230	417
CR8B	316	CY1821	446	DGP1872	295	DRGP1824	297	ECV2PU60S	422	ET6024BBFLC	417
CR8R	315	CY2416	446	DGP2420	296	DRGP1829	297	ECVPUD30B	422	ET6024BBFRC	417
CR8WB	316	CY2421	446	DGP2424	296	DRGP1830	297	ECVPUD30S	422	ET6030BBFLC	418
CR8WR	315	CY3016	446	DGP2429	296	DRGP1836	297	ECVPUD36B	423	ET6030BBFRC	418
CR10B	317	CY3021	446	DGP2430	296	DRGP1842	297	ECVPUD36S	423	ET6624BBFLC	417
CR10R	315	CYP1816	446	DGP2436	296	DRGP1848	297	ECVPUD60B	423	ET6624BBFRC	417
CR10WB	317	CYP1821	446	DGP2442	296	DRGP1860	297	ECVPUD60S	423	ET6630BBFLC	418
CR10WR	315	CYP2416	446	DGP2448	296	DRGP1866	297	ECVPUD72B	423	ET6630BBFRC	418
CR12WB	317	CYP2421	446	DGP2460	296	DRGP1872	297	ECVPUD72S	423	ET7224BBFLC	417
CR12WR	315	CYP3016	446	DGP2466	296	DRGP2420	297	EL6	319	ET7224BBFRC	417
CRR24	313	CYP3021	446	DGP2472	296	DRGP2424	297	EL6A	319	ET7230BBFLC	418
CRR30	313	D		DGP3620	296	DRGP2429	297	EL6R	319	ET7230BBFRC	418
CRR36	313	DA1GC36	302	DGP3624	296	DRGP2430	297	EL6X	318	F	
CRR42	313	DA1GC42	302	DGP3629	296	DRGP2436	297	EL6Z	319	FBB	42
CRR48	313	DA2GC36	302	DGP3630	296	DRGP2442	297	EL8	319	FTZ52FLNL	127
CRS30	314	DA2GC42	302	DGP3636	296	DRGP2448	297	EL8A	319	FTZ52SFNL	127
CRS36	314	DA2GC66L	303	DGP3642	296	DRGP2460	297	EL8R	319	FTZ53FSLNL	127
CRS42	314	DA2GC66R	303	DGP3648	296	DRGP2466	297	EL8W	319	G	
CT6B	316	DATT2W	303	DGP3660	296	DRGP2472	297	EL8WA	319	G36HOCB	55
CT6BA	316	DATT4W	304	DGP3666	296	DRGP3620	298	EL8WR	319	G42HOCB	55
CT6BX	315	DATT14	301	DGP3672	296	DRGP3624	298	EL8WX	318	G48HOCB	55
CT6BZ	316	DATT18	301	DLP1220	298	DRGP3629	298	EL8WZ	319	G60HOCB	55
CT6R	315	DATT20	301	DLP1224	298	DRGP3630	298	EL8X	318	G66HOCB	55
CT6RA	314	DATT23	301	DLP1229	298	DRGP3636	298	EL8Z	319	G72HOCB	55
						DRGP3642	298	EL10	319	G2036LF	58

G2036SC.....	58	GBT6TPLK.....	343	GDH489641.....	350	GRBTP60SK.....	338	GRH364841.....	353	GRT7NTP.....	341
G2040FB.....	53	GBT6TPV.....	343	GDOOR36.....	56	GRBT60V.....	338	GRH366029.....	352	GRT7NTPLK.....	341
G2040FL.....	51	GBT7NTP.....	343	GDOOR42.....	56	GRC5HSTP.....	340	GRH366036.....	352	GRT7NTPSF.....	341
G2040FLK.....	53	GBT7NTPLK.....	343	GDOOR48.....	56	GRC5HSTPLK.....	340	GRH366041.....	353	GRT7NTPSK.....	341
G2040FR.....	51	GBT7NTPV.....	343	GDOOR60.....	56	GRC5HSTPV.....	340	GRH367229.....	352	GRT7NTPV.....	341
G2040FRK.....	53	GBT7TP.....	343	GDOOR66.....	56	GRC5HTP.....	342	GRH367236.....	352	GRT7STP.....	339
G2040SDL.....	51	GBT7TPLK.....	343	GDOOR72.....	56	GRC5HTPLK.....	342	GRH367241.....	353	GRT7STPLK.....	339
G2040SDR.....	51	GBT7TPV.....	343	GRB14H25.....	332	GRC5HTPV.....	342	GRH426029.....	352	GRT7STPSF.....	339
G2066CK.....	53	GBT8MTP.....	346	GRB22.....	335, 344	GRC5NHTP.....	342	GRH426036.....	352	GRT7STPSK.....	339
G2072C.....	53	GBT8MTPLK.....	346	GRB22H15.....	335	GRC5NHTPLK.....	342	GRH426041.....	353	GRT7STPV.....	339
G2072CK.....	53	GBT8MTPV.....	346	GRB22H21.....	335	GRC5NHTPV.....	342	GRH427229.....	352	GRT7TP.....	341
G2072CSL.....	54	GBT8NTP.....	343	GRB22H26.....	335, 344	GRC5NTP.....	342	GRH427236.....	352	GRT7TPLK.....	341
G2072CSR.....	54	GBT8NTPLK.....	343	GRB22H35.....	335, 344	GRC5NTPLK.....	342	GRH427241.....	353	GRT7TPSF.....	341
G2072LS.....	53	GBT8NTPV.....	343	GRB22H41.....	335, 344	GRC5NTPV.....	342	GRH428429.....	352	GRT7TPSK.....	341
G2436BL4.....	52	GBT8TP.....	343	GRB28.....	337, 346	GRC5STP.....	340	GRH428436.....	352	GRT7TPV.....	341
G2436BR4.....	52	GBT8TPLK.....	343	GRB34.....	338	GRC5STPLK.....	340	GRH428441.....	353	GRT8MTP.....	345
G2436FB.....	53	GBT8TPV.....	343	GRBOTP16.....	330	GRC5STPV.....	340	GRH429629.....	352	GRT8MTPLK.....	345
G2436L4.....	52	GBT8WTP.....	346	GRBOTP16LK.....	330	GRC5TP.....	342	GRH429636.....	352	GRT8MTPV.....	345
G2436R4.....	52	GBT8WTPLK.....	346	GRBOTP16SF.....	330	GRC5TPLK.....	342	GRH429641.....	353	GRT8NTP.....	341
G2442BL4.....	52	GBT8WTPV.....	346	GRBOTP16SK.....	330	GRC5TPV.....	342	GRH486029.....	352	GRT8NTPLK.....	341
G2442BR4.....	52	GBT10WTP.....	346	GRBOTP16V.....	330	GRC5TPV.....	342	GRH486036.....	352	GRT8NTPSF.....	341
G2442L4.....	52	GBT10WTPLK.....	346	GRBOTP20.....	330	GRC6NTPLK.....	342	GRH486041.....	353	GRT8NTPSK.....	341
G2442R4.....	52	GBT10WTPV.....	346	GRBOTP20LK.....	330	GRC6NTPV.....	342	GRH487229.....	352	GRT8NTPV.....	341
G2445SPL.....	50	GBT12WTP.....	346	GRBOTP20SF.....	330	GRC6STP.....	340	GRH487236.....	352	GRT8TP.....	339
G2445SPR.....	50	GBT12WTPLK.....	346	GRBOTP20SK.....	330	GRC6STPLK.....	340	GRH487241.....	353	GRT8STPLK.....	339
G2448BL4.....	52	GBT12WTPV.....	346	GRBOTP20V.....	330	GRC6STPV.....	340	GRH488429.....	352	GRT8STPSF.....	339
G2448BR4.....	52	GBTD5HMTP.....	348	GRBOTP22.....	330	GRC6TP.....	342	GRH488436.....	352	GRT8STPSK.....	339
G2448FB.....	53	GBTD5HMTPLK.....	348	GRBOTP22LK.....	330	GRC6TPLK.....	342	GRH488441.....	353	GRT8STPV.....	339
G2448FL.....	51	GBTD5HMTPV.....	348	GRBOTP22SF.....	330	GRC6TPV.....	342	GRH489629.....	352	GRT8TP.....	341
G2448FLK.....	53	GBTD5HTP.....	348	GRBOTP22SK.....	330	GRC7NTP.....	342	GRH489636.....	352	GRT8TPLK.....	341
G2448FR.....	51	GBTD5HTPLK.....	348	GRBOTP22V.....	330	GRC7NTPLK.....	342	GRH489641.....	353	GRT8TPSF.....	341
G2448FRK.....	53	GBTD5HTPV.....	348	GRBTP16.....	329	GRC7NTPV.....	342	GRHB22H28.....	356	GRT8TPSK.....	341
G2448L4.....	52	GBTD5MTP.....	348	GRBTP16LK.....	329	GRC7STP.....	340	GRHB22H35.....	356	GRT8TPV.....	341
G2448R4.....	52	GBTD5MTPLK.....	348	GRBTP16SF.....	329	GRC7STPLK.....	340	GRHB22H41.....	356	GRT8WTP.....	345
G2448SDL.....	51	GBTD5MTPV.....	348	GRBTP16SK.....	329	GRC7STPV.....	340	GRT5HSTP.....	339	GRT8WTPLK.....	345
G2448SDR.....	51	GBTD5TP.....	348	GRBTP16V.....	329	GRC7TP.....	342	GRT5HSTPLK.....	339	GRT8WTPV.....	345
G3048SPL.....	50	GBTD5TPLK.....	348	GRBTP20.....	329	GRC7TPLK.....	342	GRT5HSTPSF.....	339	GRT10WTP.....	345
G3048SPR.....	50	GBTD5TPV.....	348	GRBTP20LK.....	329	GRC7TPV.....	342	GRT5HSTPSK.....	339	GRT10WTPLK.....	345
G3060DP.....	50	GBTD6MTP.....	348	GRBTP20SF.....	329	GRC8MTP.....	345	GRT5HSTPV.....	339	GRT10WTPV.....	345
G3060FI.....	54	GBTD6MTPLK.....	348	GRBTP20SK.....	329	GRC8MTPLK.....	345	GRT5HTP.....	341	GRT12WTP.....	345
G3060I.....	54	GBTD6MTPV.....	348	GRBTP20V.....	329	GRC8MTPV.....	345	GRT5HTPLK.....	341	GRT12WTPLK.....	345
G3060SPL.....	50	GBTD6TP.....	348	GRBTP22.....	329	GRC8NTP.....	342	GRT5HTPSF.....	341	GRT12WTPV.....	345
G3060SPR.....	50	GBTD6TPLK.....	348	GRBTP22LK.....	329	GRC8NTPLK.....	342	GRT5HTPSK.....	341	GRTD5HMTP.....	347
G3066DP.....	50	GBTD6TPV.....	348	GRBTP22SF.....	329	GRC8NTPV.....	342	GRT5HTPV.....	341	GRTD5HMTPLK.....	347
G3066FI.....	54	GCNTLEG18.....	409	GRBTP22SK.....	329	GRC8STP.....	340	GRT5NHTP.....	341	GRTD5HMTPV.....	347
G3066I.....	54	GCNTLG18P.....	409	GRBTP22V.....	329	GRC8STPLK.....	340	GRT5NHTPLK.....	341	GRTD5HTP.....	347
G3066SPL.....	50	GDCB36H28.....	348	GRBTP24.....	333	GRC8STPV.....	340	GRT5NHTPSF.....	341	GRTD5HTPLK.....	347
G3066SPR.....	50	GDH364829.....	349	GRBTP24LK.....	333	GRC8TP.....	342	GRT5NHTPSK.....	341	GRTD5HTPV.....	347
G3072FI.....	54	GDH364836.....	349	GRBTP24SF.....	333	GRC8TPLK.....	342	GRT5NHTPV.....	341	GRTD5MTP.....	347
G3072FPL.....	55	GDH364841.....	350	GRBTP24SK.....	333	GRC8TPV.....	342	GRT5NTP.....	341	GRTD5MTPLK.....	347
G3072FPR.....	55	GDH366029.....	349	GRBTP24V.....	333	GRC8WTP.....	345	GRT5NTPLK.....	341	GRTD5MTPV.....	347
G3072I.....	54	GDH366036.....	349	GRBTP30.....	333	GRC8WTPLK.....	345	GRT5NTPSF.....	341	GRTD5TP.....	347
G3636CH.....	55	GDH366041.....	350	GRBTP30LK.....	333	GRC8WTPV.....	345	GRT5NTPSK.....	341	GRTD5TPLK.....	347
G3672DP.....	50	GDH367229.....	349	GRBTP30SF.....	333	GRC10WTP.....	345	GRT5NTPV.....	341	GRTD5TPV.....	347
G3672DPB.....	50	GDH367236.....	349	GRBTP30SK.....	333	GRC10WTPLK.....	345	GRT5STP.....	339	GRTD6MTP.....	347
G3672SPL.....	50	GDH367241.....	350	GRBTP30V.....	333	GRC10WTPV.....	345	GRT5STPLK.....	339	GRTD6MTPLK.....	347
G3672SPLB.....	50	GDH426029.....	349	GRBTP36.....	333	GRC12WTP.....	345	GRT5STPSF.....	339	GRTD6MTPV.....	347
G3672SPR.....	50	GDH426036.....	349	GRBTP36LK.....	333	GRC12WTPLK.....	345	GRT5STPSK.....	339	GRTD6TP.....	347
G3672SPRB.....	50	GDH426041.....	350	GRBTP36SF.....	333	GRC12WTPV.....	345	GRT5STPV.....	339	GRTD6TPLK.....	347
G4242CH.....	55	GDH427229.....	349	GRBTP36SK.....	333	GRC12WTPV.....	345	GRT5TP.....	341	GRTD6TPV.....	347
G36205C.....	54	GDH427236.....	349	GRBTP36V.....	333	GRC12WTPV.....	345	GRT5TPLK.....	341	GSB13H25.....	332
G42205C.....	54	GDH427241.....	350	GRBTP42.....	336	GRC12WTPLK.....	345	GRT5TPSF.....	341	GSB19.....	335, 344
G42245C.....	54	GDH428429.....	349	GRBTP42LK.....	336	GRC12WTPV.....	345	GRT5TPSK.....	341	GSB19H15.....	335
GBT5HTP.....	343	GDH428436.....	349	GRBTP42SF.....	336	GRC12WTPV.....	345	GRT5TPSK.....	341	GSB19H21.....	335
GBT5HTPLK.....	343	GDH428441.....	350	GRBTP42SK.....	336	GRC12WTPV.....	345	GRT5TPV.....	341	GSB19H25.....	335, 344
GBT5HTPV.....	343	GDH429629.....	349	GRBTP42V.....	336	GRC12WTPV.....	345	GRT6NTP.....	341	GSB19H35.....	335, 344
GBT5NHTP.....	343	GDH429636.....	349	GRBTP48.....	336	GRC12WTPV.....	345	GRT6NTPLK.....	341	GSB19H41.....	335, 344
GBT5NHTPLK.....	343	GDH429641.....	350	GRBTP48LK.....	336	GRC12WTPV.....	345	GRT6NTPSK.....	341	GSB23.....	337, 346
GBT5NHTPV.....	343	GDH486029.....	349	GRBTP48SF.....	336	GRC12WTPV.....	345	GRT6NTPV.....	341	GSB28.....	338
GBT5NTP.....	343	GDH486036.....	349	GRBTP48SK.....	336	GRC12WTPV.....	345	GRT6STP.....	339	GSBOT1620.....	331
GBT5NTPLK.....	343	GDH486041.....	350	GRBTP48V.....	336	GRC12WTPV.....	345	GRT6STPLK.....	339	GSBOT1620LK.....	331
GBT5NTPV.....	343	GDH487229.....	349	GRBTP54.....	338	GRC12WTPV.....	345	GRT6STPSF.....	339	GSBOT1620SF.....	331
GBT5TP.....	343	GDH487236.....	349	GRBTP54LK.....	338	GRC12WTPV.....	345	GRT6STPSK.....	339	GSBOT1620SK.....	331
GBT5TPLK.....	343	GDH487241.....	350	GRBTP54SF.....	338	GRC12WTPV.....	345	GRT6STPV.....	339	GSBOT1620V.....	331
GBT5TPV.....	343	GDH488429.....	349	GRBTP54SK.....	338	GRC12WTPV.....	345	GRT6TP.....	341	GSBOT1622.....	331
GBT6NTP.....	343	GDH488436.....	349	GRBTP54V.....	338	GRC12WTPV.....	345	GRT6TPLK.....	341	GSBOT1622LK.....	331
GBT6NTPLK.....	343	GDH488441.....	350	GRBTP60.....	338	GRC12WTPV.....	345	GRT6TPSF.....	341	GSBOT1622SF.....	331
GBT6NTPV.....	343	GDH489629.....	349	GRBTP60LK.....	338	GRC12WTPV.....	345	GRT6TPSK.....	341	GSBOT1622SK.....	331
GBT6TP.....	343	GDH489636.....	349	GRBTP60SF.....	338	GRC12WTPV.....	345	GRT6TPV.....	341	GSBOT1622V.....	331

INDEX

GSBOTP16.....	331	GSBTP3042V.....	336	JB42C.....	391	KP0302.....	464	PMDCF3MG.....	473	PN67TSBFL.....	95
GSBOTP16LK.....	331	GSBTP3642.....	336	JB42L.....	391	KP0303.....	464	PMDCF3WH.....	473	PN67TSBFR.....	95
GSBOTP16SF.....	331	GSBTP3642LK.....	336	JB48C.....	391	KPSF01.....	464	PMDECLIPS.....	474	PN69BBFTL.....	96
GSBOTP16SK.....	331	GSBTP3642SF.....	336	JB48L.....	391	KPSF02.....	464	PMDEA3MG.....	474	PN69BBFTR.....	96
GSBOTP16V.....	331	GSBTP3642SK.....	336	JB60C.....	391	KPSF03.....	464	PMDEA3WH.....	474	PN69CBBFL.....	93
GSBOTP20.....	331	GSBTP3642V.....	336	JB60L.....	391	KSFK-12.....	462	PMDEF3MG.....	473	PN69CBBFR.....	93
GSBOTP20LK.....	331	GSEH364829.....	354	JB72C.....	391	KSFK-18.....	462	PMDEF3WH.....	473	PN69CSBFL.....	93
GSBOTP20SF.....	331	GSEH364836.....	354	JB72L.....	391	KSFK-21.....	462	PMDJ36BK.....	474	PN69CSBFR.....	93
GSBOTP20SK.....	331	GSEH364841.....	355	JBFCM.....	392	KSFK-21-WV.....	462	PMDSA10MG.....	474	PN69DBBFL.....	94
GSBOTP20V.....	331	GSEH366029.....	354	JBCTM.....	392	KSM01-12.....	462	PMDSA10WH.....	474	PN69DBBFR.....	94
GSBOTP22.....	331	GSEH366036.....	354	JBEC.....	392	KSM01-18.....	462	PMDSF10MG.....	473	PN69DRCSL.....	94
GSBOTP22LK.....	331	GSEH366041.....	355	JBPS.....	392	KSM01-21.....	462	PMDSF10WH.....	473	PN69DRCSR.....	94
GSBOTP22SF.....	331	GSEH367229.....	354	JBSFM.....	392	KSM02-12.....	462	PMSPDM.....	394, 467	PN69DRDSL.....	96
GSBOTP22SK.....	331	GSEH367236.....	354	JBWM2.....	392	KSM02-18.....	462	PN22MBF.....	97	PN69DRTSR.....	96
GSBOTP22V.....	331	GSEH367241.....	355	JN5S2424.....	428	KSM02-21.....	462	PN22MLBF.....	98	PN69DSBFL.....	94
GSBTP16.....	329	GSEH426029.....	354	JN5S3030.....	428	KSM03-12.....	463	PN25MBBF.....	97	PN69DSBFR.....	94
GSBTP16LK.....	329	GSEH426036.....	354	JNCP.....	430	KSM03-18.....	463	PN25MLSBF.....	98	PN69RCSL.....	93
GSBTP16SF.....	329	GSEH426041.....	355	JNEC5S.....	428	KSM03-21.....	463	PN25MSBF.....	97	PN69RCSR.....	93
GSBTP16SK.....	329	GSEH427229.....	354	JNEC42.....	428	KSTRKLS.....	463	PN27MFF.....	97	PN69RTSL.....	95
GSBTP16V.....	329	GSEH427236.....	354	JNEC48.....	428	KT01.....	461	PN27MLFF.....	98	PN69RTSR.....	95
GSBTP20.....	329	GSEH427241.....	355	JNEC54.....	428	KT27M02.....	461	PN52TWBL.....	88	PN69SBFTL.....	96
GSBTP20LK.....	329	GSEH428429.....	354	JNEC60.....	428	KTMT03.....	461	PN52TWBR.....	88	PN69SBFTR.....	96
GSBTP20SF.....	329	GSEH428436.....	354	JNEC66.....	428	M.....		PN57CSBFL.....	88	PN69TBBFL.....	95
GSBTP20SK.....	329	GSEH428441.....	355	JNEC72.....	428	M393.....	476	PN57CSBFR.....	88	PN69TBBFR.....	95
GSBTP20V.....	329	GSEH429629.....	354	JNFP1.....	430	M7750LD.....	459	PN57DRCSL.....	90	PN69TSBFL.....	95
GSBTP22.....	329	GSEH429636.....	354	JNFP4.....	430	M7755MD.....	460	PN57DRCSR.....	90	PN69TSBFR.....	95
GSBTP22LK.....	329	GSEH429641.....	355	JNGFP.....	430	M7760DSS.....	460	PN57DRDSL.....	92	PN1160DS.....	101
GSBTP22SF.....	329	GSEH486029.....	354	JNHFS2040.....	427	MLB90.....	265	PN57DRTSR.....	92	PN1160LDS.....	101
GSBTP22SK.....	329	GSEH486036.....	354	JNHFS2048.....	427	MON1SDE.....	459	PN57DSBFL.....	89	PN1172DS.....	101
GSBTP22V.....	329	GSEH486041.....	355	JNHFS2448.....	427	MON1SDEH.....	459	PN57DSBFR.....	89	PN1172LDS.....	101
GSBTP24.....	333	GSEH487229.....	354	JNHFS2454.....	427	MON1SPP.....	458	PN57RCSL.....	89	PN1260LWH.....	103
GSBTP24LK.....	333	GSEH487236.....	354	JNHFS3060.....	427	MON1SSE.....	459	PN57RCSR.....	89	PN1260WH.....	103
GSBTP24SF.....	333	GSEH487241.....	355	JNHFS3066.....	427	MON1SSEH.....	459	PN57RTSL.....	91	PN1260WHO.....	103
GSBTP24SK.....	333	GSEH488429.....	354	JNLEG.....	429	MON2SDE.....	460	PN57RTSR.....	91	PN1260WHS.....	103
GSBTP24V.....	333	GSEH488436.....	354	JNLEG20.....	429	MON2SDEH.....	460	PN57SBFTL.....	91	PN1272LWH.....	103
GSBTP30.....	333	GSEH488441.....	355	JNLEG24.....	429	O.....		PN57SBFTR.....	91	PN1272WH.....	103
GSBTP30LK.....	333	GSEH489629.....	354	JNLEG30.....	429	OAM-A-PC-B.....	469	PN57TSBFL.....	90	PN1272WHO.....	103
GSBTP30SF.....	333	GSEH489636.....	354	JNMP42.....	428	OAM-A-PC-S.....	469	PN57TSBFR.....	90	PN1272WHS.....	103
GSBTP30SK.....	333	GSEH489641.....	355	JNMP48.....	428	P.....		PN59BBFTL.....	92	PN1284LWH.....	103
GSBTP30V.....	333	GSHB19H28.....	356	JNMP54.....	428	PAFM3018.....	475	PN59BBFTR.....	92	PN1284WH.....	103
GSBTP36.....	333	GSHB19H35.....	356	JNMP60.....	428	PAFM4820.....	475	PN59CBBFL.....	89	PN1284WHO.....	103
GSBTP36LK.....	333	GSHB19H41.....	356	JNMP66.....	428	PCOS2.....	444, 475	PN59CBBFR.....	89	PN1284WHS.....	103
GSBTP36SF.....	333	GSOB13H25.....	332	JNMP72.....	428	PCOS3.....	444, 475	PN59CSBFL.....	88	PN1566TBH.....	104
GSBTP36SK.....	333	GVB4848.....	59	JNR2042.....	427	PCPU-GT.....	465	PN59CSBFR.....	88	PN1566TBW.....	104
GSBTP36V.....	333	GWH486029.....	351	JNR2048.....	427	PCPU-HC.....	464	PN59DBBFL.....	90	PN1562TBH.....	104
GSBTP42.....	336	GWH486036.....	351	JNR2442.....	427	PCPU-HO.....	464	PN59DBBFR.....	90	PN1566TBW.....	104
GSBTP42LK.....	336	GWH486041.....	351	JNR2448.....	427	PCSNO.....	467	PN59DRCSL.....	90	PN1568TBH.....	104
GSBTP42SF.....	336	GWH487229.....	351	JNR3042.....	427	PCSNO1E.....	467	PN59DRCSR.....	90	PN1572TBW.....	104
GSBTP42SK.....	336	GWH487236.....	351	JNR3048.....	427	PCT.....	444, 475	PN59DRDSL.....	92	PN1574TBH.....	104
GSBTP42V.....	336	GWH487241.....	351	JNRU2054.....	427	PEEOCKS.....	476	PN59DRTSR.....	92	PN1578TBW.....	104
GSBTP1620.....	330	GWH488429.....	351	JNRU2060.....	427	PEEPD.....	476	PN59DSBFL.....	89	PN1580TBH.....	104
GSBTP1620LK.....	330	GWH488436.....	351	JNRU2066.....	427	PEUTEM.....	467	PN59DSBFR.....	89	PN1584TBW.....	104
GSBTP1620SF.....	330	GWH488441.....	351	JNRU2072.....	427	PEVWM.....	475	PN59RCSL.....	89	PN1622CU.....	97
GSBTP1620SK.....	330	GWH489629.....	351	JNRU2454.....	427	PEWM1.....	105, 475	PN59RCSR.....	89	PN1652WDL.....	88
GSBTP1620V.....	330	GWH489636.....	351	JNRU2460.....	427	PEWM1.5.....	105, 475	PN59RTSL.....	91	PN1652WDR.....	88
GSBTP1622.....	330	GWH489641.....	351	JNRU2466.....	427	PEWM2.....	105, 475	PN59RTSR.....	91	PN1666WDL.....	92
GSBTP1622LK.....	330	H.....		JNRU2472.....	427	PEWM2.5.....	105, 475	PN59SBFTL.....	91	PN1666WDR.....	92
GSBTP1622SF.....	330	HANDLE HO.....	267	JNRU3054.....	427	PEWM3.....	105, 475	PN59SBFTR.....	91	PN1920ST.....	98
GSBTP1622V.....	330	HANDLE HQ.....	267	JNRU3060.....	427	PEWM3.5.....	105, 475	PN59TBFL.....	91	PN1960LS.....	102
GSBTP2430.....	334	HANDLE HR.....	267	JNRU3066.....	427	PEWM4.....	105, 475	PN59TBFR.....	91	PN1960LWH.....	102
GSBTP2430LK.....	334	HANDLE HS.....	266	JNRU3072.....	427	PEWM4.5.....	105, 475	PN59TSBFL.....	90	PN1960WHO.....	102
GSBTP2430SF.....	334	HANDLE HU.....	266	JNTS.....	430	PEWM5.....	105, 475	PN59TSBFR.....	90	PN1960WHO.....	103
GSBTP2430SK.....	334	HANDLE HV.....	266	JNTT2048.....	427	PEWM5.5.....	105, 475	PN66TWBL.....	92	PN1972LS.....	102
GSBTP2430V.....	334	HANDLE HX.....	266	JNTT2060.....	427	PEWM6.....	105, 475	PN66TWBR.....	92	PN1972LWH.....	102
GSBTP2436.....	334	HTM2446T.....	455	JNTT2448.....	427	PGDPS20.....	104	PN67CSBFL.....	93	PN1972WH.....	102
GSBTP2436SF.....	334	HTM2458T.....	455	JNTT2460.....	427	PGDPS21.....	104	PN67CSBFR.....	93	PN1972WHO.....	103
GSBTP2436SK.....	334	HTM3046T.....	455	JNTT3060.....	427	PGDPS41.....	104	PN67DRCSL.....	94	PN1984LS.....	102
GSBTP2436V.....	334	HTM3058T.....	455	JNTT3072.....	427	PLED30.....	105, 421, 466	PN67DRCSR.....	94	PN1984LWH.....	102
GSBTP3036.....	334	I.....		K.....		PLED50.....	105, 466	PN67DRDSL.....	96	PN1984WH.....	102
GSBTP3036LK.....	334	IT60MP.....	360	KEZLCSTR.....	455	PLED100.....	105, 421, 466	PN67DRTSR.....	96	PN1984WHO.....	103
GSBTP3036SF.....	334	IT72MP.....	360	KEZLIFT.....	455	PLEDA240.....	466	PN67DSBFL.....	94	PN2027CU.....	87
GSBTP3036SK.....	334	IT1860RX.....	360	KP0101.....	464	PLEDA360.....	466	PN67DSBFR.....	94	PN2030CU.....	87
GSBTP3036V.....	334	IT2460RX.....	360	KP0102.....	464	PLEDA480.....	466	PN67RCSL.....	93	PN2337CRS.....	85
GSBTP3042.....	336	IT2472RX.....	360	KP0103.....	464	PLEDOS.....	466	PN67RCSR.....	93	PN2354NCL.....	85
GSBTP3042LK.....	336	J.....		KP0201.....	464	PLEDS240.....	466	PN67RTSL.....	95	PN2354NCR.....	85
GSBTP3042SF.....	336	JB36C.....	391	KP0202.....	464	PLEDS360.....	466	PN67RTSR.....	95	PN2360CO.....	86
GSBTP3042SK.....	336	JB36L.....	391	KP0203.....	464	PLEDS480.....	466	PN67SBFTL.....	96	PN2360CPL.....	85
				KP0301.....	464	PMDCA3MG.....	474	PN67SBFTR.....	96	PN2360CPR.....	85
						PMDCA3WH.....	474				

PN2360CRL.....84	PN2460SOL.....70	PN2754NCL.....82	PN2984CLS.....80	PN3066FTR.....68	PN3090RBL.....72
PN2360CRR.....84	PN2460SOR.....70	PN2754NCR.....82	PN2984CO.....81	PN3066OML.....69	PN3090RBR.....72
PN2360NCL.....85	PN2466BGS.....100	PN2760CGS.....83	PN2984CPL.....78	PN3066OMR.....69	PN3096COL.....74
PN2360NCR.....85	PN2466BLS.....100	PN2760CLS.....83	PN2984CPR.....78	PN3066OTL.....69	PN3096COR.....74
PN2366CPL.....85	PN2466BOL.....66	PN2760CO.....84	PN2984CRL.....78	PN3066OTR.....69	PN3096CUL.....75
PN2366CPR.....85	PN2466BOR.....66	PN2760CPL.....81	PN2984CRR.....78	PN3066OSL.....70	PN3096CUR.....75
PN2366CRL.....84	PN2466BK.....64	PN2760CPR.....82	PN2984MCL.....79	PN3066SOR.....70	PN3096RBL.....72
PN2366CRR.....84	PN2466DM.....66	PN2760CRL.....81	PN2984MCR.....79	PN3066TSL.....70	PN3096RBR.....72
PN2372CO.....86	PN2466FBL.....72	PN2760CRR.....81	PN2984MPL.....79	PN3066TSR.....70	PN3560CH.....100
PN2372CPL.....85	PN2466FBR.....72	PN2760NCL.....82	PN2984MPR.....79	PN3072CFL.....73	PN3560CHO.....101
PN2372CPR.....85	PN2466FML.....67	PN2760NCR.....82	PN3013DG.....76, 77	PN3072CFR.....73	PN3560LCH.....100
PN2372CRD.....85	PN2466FMR.....68	PN2766CPL.....81	PN3013DMF.....76	PN3072DBL.....67	PN3572CH.....100
PN2372CRL.....84	PN2466OBL.....71	PN2766CPR.....81	PN3013DML.....76	PN3072DBR.....67	PN3572CHO.....101
PN2372CRR.....84	PN2466ORL.....71	PN2766CRL.....82	PN3013PT9-1.....77	PN3072DK.....64	PN3572LCH.....100
PN2378CPL.....85	PN2466OML.....69	PN2766CRR.....81	PN3013PT9-4.....77	PN3072DM.....66	PN3584CH.....100
PN2378CPR.....85	PN2466OMR.....69	PN2772CGS.....83	PN3013PT9-12.....77	PN3072DDL.....74	PN3584CHO.....101
PN2378CRL.....84	PN2466OSL.....71	PN2772CLS.....83	PN3023GDB.....101	PN3072DOL.....74	PN3584LCH.....100
PN2378CRR.....84	PN2466OSR.....71	PN2772CO.....84	PN3023LDB.....101	PN3072DUL.....75	PN3613DG.....76, 77
PN2384CO.....86	PN2466RFL.....65	PN2772CPL.....81	PN3025GDB.....101	PN3072DUR.....75	PN3613DMF.....76
PN2384CPL.....85	PN2466RFR.....65	PN2772CPR.....82	PN3025LDB.....101	PN3072FBL.....72	PN3613DML.....76
PN2384CPR.....85	PN2466SOL.....70	PN2772CRD.....83	PN3029BGS.....100	PN3072FBR.....72	PN3613PT9-1.....77
PN2384CRL.....84	PN2466SOR.....70	PN2772CRL.....81	PN3037GDB.....102	PN3072FML.....67	PN3613PT9-4.....77
PN2384CRR.....84	PN2472BOL.....66	PN2772CRR.....81	PN3037LDB.....102	PN3072FMR.....68	PN3613PT9-12.....77
PN2423GDB.....101	PN2472BOR.....66	PN2772MCL.....82	PN3037MCL.....102	PN3072FTL.....68	PN3622CU.....98
PN2423LDB.....101	PN2472DK.....64	PN2772MCR.....82	PN3039GDB.....102	PN3072FTR.....68	PN3623GDB.....101
PN2425GDB.....101	PN2472DM.....66	PN2772MPL.....83	PN3039LDB.....102	PN3072DMO.....69	PN3623LDB.....101
PN2425LDB.....101	PN2472DFL.....72	PN2772MPR.....83	PN3048DFL.....73	PN3072OMR.....69	PN3625GDB.....101
PN2429BGS.....100	PN2472FBR.....72	PN2778CPL.....81	PN3048DFR.....73	PN3072OTL.....69	PN3625LDB.....101
PN2429BLS.....100	PN2472FML.....67	PN2778CPR.....82	PN3048DK.....64	PN3072OTR.....69	PN3629BGS.....100
PN2430CU.....87	PN2472FMR.....68	PN2778CRL.....81	PN3048DM.....66	PN3072SOL.....100	PN3629BLS.....100
PN2433CU.....87	PN2472OBL.....71	PN2778CRR.....81	PN3048FML.....67	PN3072SOR.....70	PN3637GDB.....102
PN2436BF.....65	PN2472OBR.....71	PN2784CGS.....83	PN3048FMR.....68	PN3072TOL.....74	PN3637LDB.....102
PN2436BFM.....71	PN2472OML.....69	PN2784CLS.....83	PN3048FTL.....68	PN3072TOR.....74	PN3639GDB.....102
PN2436CU.....87	PN2472OMR.....69	PN2784CO.....84	PN3048FTR.....68	PN3072TSL.....70	PN3639LDB.....102
PN2437CU.....88	PN2472OSL.....71	PN2784CPL.....81	PN3048FTL.....73	PN3072TSR.....70	PN3648DK.....64
PN2437GDB.....102	PN2472OSR.....71	PN2784CPR.....82	PN3048TFR.....73	PN3078DBL.....67	PN3648DM.....66
PN2437LDB.....102	PN2472RFL.....65	PN2784CRL.....81	PN3052BGS.....100	PN3078DBR.....67	PN3652BGS.....100
PN2439CU.....87	PN2472RFR.....65	PN2784CRR.....81	PN3052BLS.....100	PN3078DK.....64	PN3652BLS.....100
PN2439GDB.....102	PN2472ROL.....65	PN2784MCL.....82	PN3054DK.....64	PN3078DM.....66	PN3654DK.....64
PN2439LDB.....102	PN2472ROR.....65	PN2784MCR.....82	PN3054DM.....66	PN3078DMO.....74	PN3654DM.....66
PN2442BF.....65	PN2472SOL.....70	PN2784MPL.....83	PN3054FML.....67	PN3078DOR.....74	PN3660DK.....64
PN2442BFM.....71	PN2472SOR.....70	PN2784MPR.....83	PN3054FMR.....68	PN3078FBL.....72	PN3660DM.....66
PN2442CU.....87	PN2478BOL.....66	PN2930CO.....81	PN3054FTL.....68	PN3078FBR.....72	PN3666BGS.....100
PN2448BF.....65	PN2478BOR.....66	PN2936CO.....81	PN3054FTR.....68	PN3078FML.....67	PN3666BLS.....100
PN2448BFM.....71	PN2478DK.....64	PN2937CRS.....80	PN3060DBL.....67	PN3078FMR.....68	PN3666DK.....64
PN2448DFL.....73	PN2478DM.....66	PN2937LFS.....80	PN3060DBR.....67	PN3078OML.....69	PN3666DM.....66
PN2448DFR.....73	PN2478FBL.....72	PN2954NCL.....79	PN3060DFL.....73	PN3078OMR.....69	PN3672DBL.....67
PN2448DK.....64	PN2478FBR.....72	PN2954NCR.....79	PN3060DFR.....73	PN3078OTL.....69	PN3672DBR.....67
PN2448DM.....66	PN2478FML.....67	PN2960CGS.....80	PN3060DK.....64	PN3078OTR.....69	PN3672DK.....64
PN2448FML.....67	PN2478FMR.....68	PN2960CLS.....80	PN3060DM.....66	PN3078OSL.....70	PN3672DM.....66
PN2448FMR.....68	PN2478OBL.....71	PN2960CO.....81	PN3060FBL.....72	PN3078SOR.....70	PN3678DBL.....67
PN2448RFL.....65	PN2478OBR.....71	PN2960CPL.....78	PN3060FBR.....72	PN3078TSL.....70	PN3678DBR.....67
PN2448RFR.....65	PN2478OML.....69	PN2960CPR.....78	PN3060FML.....67	PN3078TSR.....70	PN3678DK.....64
PN2452BGS.....100	PN2478OMR.....69	PN2960CRL.....78	PN3060FMR.....68	PN3084DBL.....67	PN3678DM.....66
PN2452BLS.....100	PN2478OSL.....71	PN2960CRR.....78	PN3060FTL.....68	PN3084DBR.....67	PN3684DBL.....67
PN2454BF.....65	PN2478OSR.....71	PN2960NCL.....79	PN3060FTR.....68	PN3084DK.....64	PN3684DBR.....67
PN2454BFM.....71	PN2478RDL.....65	PN2960NCR.....79	PN3060FML.....68	PN3084DM.....66	PN3684DK.....64
PN2454DK.....64	PN2478ROR.....65	PN2966CPL.....78	PN3060OMR.....69	PN3084DOL.....74	PN3684DM.....66
PN2454DM.....66	PN2478SOL.....70	PN2966CPR.....78	PN3060OTL.....69	PN3084DOR.....74	PN4213DG.....76, 77
PN2454FML.....67	PN2478SOR.....70	PN2966CRL.....78	PN3060OTR.....69	PN3084DUL.....75	PN4213DMF.....76
PN2454FMR.....68	PN2484DK.....64	PN2966CRR.....78	PN3060OSL.....70	PN3084DUR.....75	PN4213DML.....76
PN2454RFL.....65	PN2484ADM.....66	PN2972CGS.....80	PN3060SOR.....70	PN3084FBL.....72	PN4213PT9-1.....77
PN2454RFR.....65	PN2484FBL.....72	PN2972CLS.....80	PN3060TFL.....73	PN3084FBR.....72	PN4213PT9-4.....77
PN2460BOL.....66	PN2484FBR.....72	PN2972CO.....81	PN3060TFR.....73	PN3084OML.....69	PN4213PT9-12.....77
PN2460BOR.....66	PN2484OML.....69	PN2972CPL.....78	PN3060TSL.....70	PN3084OMR.....69	PN4229BGS.....99
PN2460DK.....64	PN2484OMR.....69	PN2972CPR.....78	PN3060TSR.....70	PN3084OTL.....69	PN4229PL.....99
PN2460DM.....66	PN2484RBL.....72	PN2972CRD.....80	PN3066BGS.....100	PN3084DOR.....69	PN4813DG.....76, 77
PN2460FBL.....72	PN2484RBR.....72	PN2972CRL.....78	PN3066BLS.....100	PN3084RBL.....72	PN4813DMF.....76
PN2460FBR.....72	PN2484ROL.....65	PN2972CRR.....78	PN3066CFL.....73	PN3084RBR.....72	PN4813DML.....76
PN2460FML.....67	PN2484ROR.....65	PN2972LFL.....80	PN3066CFR.....73	PN3084SOL.....70	PN4813PT9-1.....77
PN2460FMR.....68	PN2484SOL.....70	PN2972MCL.....79	PN3066DBL.....67	PN3084SOR.....70	PN4813PT9-4.....77
PN2460OBL.....71	PN2484SOR.....70	PN2972MCR.....79	PN3066DBR.....67	PN3084TOL.....74	PN4813PT9-12.....77
PN2460OBR.....71	PN2490RBL.....72	PN2972MPL.....79	PN3066DK.....64	PN3084TOR.....74	PN5413DG.....76, 77
PN2460OML.....69	PN2490RBR.....72	PN2972MPR.....79	PN3066DM.....66	PN3084TSL.....70	PN5413DMF.....76
PN2460OMR.....69	PN2496RBL.....72	PN2978CPL.....78	PN3066FBL.....72	PN3084TSR.....70	PN5413DML.....76
PN2460OSL.....71	PN2496RBR.....72	PN2978CPR.....78	PN3066FBR.....72	PN3090COL.....74	PN5413PT9-1.....77
PN2460OSR.....71	PN2730CO.....84	PN2978CRL.....78	PN3066FML.....67	PN3090COR.....74	PN5413PT9-4.....77
PN2460RFL.....65	PN2736CO.....84	PN2978CRR.....78	PN3066FMR.....68	PN3090CUL.....75	PN5413PT9-12.....77
PN2460RFR.....65	PN2737CRS.....83	PN2984CGS.....80	PN3066FTL.....68	PN3090CUR.....75	PN6013DG.....76, 77

INDEX

PN6013DMF.....	76	PN783629.....	106	PRTMCS401B.....	469	PTL03.....	471	Z12L4SHR.....	183	Z12S42TCL.....	256
PN6013DML.....	76	PN784229.....	106	PRTMCS401T.....	469	PTL04.....	471	Z12L5SHL.....	186	Z12S42TCR.....	257
PN6013PT9-1.....	77	PN784829.....	106	PRTMCS401W.....	469	PTL05.....	471	Z12L5SHN.....	187	Z12S42TL.....	256
PN6013PT9-4.....	77	PN842429.....	106	PRTMCS421B.....	470	PTL08.....	472	Z12L5SHR.....	186	Z12S42TN.....	257
PN6013PT9-12.....	77	PN843029.....	106	PRTMCS421T.....	470	PTL09.....	472	Z12L6SHL.....	189	Z12S42TR.....	256
PN6613DG.....	76, 77	PN843629.....	106	PRTMCS421W.....	470	PTL10.....	472	Z12L6SHN.....	190	Z12S43TCL.....	260
PN6613DMF.....	76	PN844229.....	106	PS305002.....	468	PTL11.....	472	Z12L6SHR.....	189	Z12S43TCR.....	261
PN6613DML.....	76	PN844829.....	106	PS305057.....	468	PTL12.....	471	Z12L6WAL.....	191	Z12S43TL.....	260
PN6613PT9-1.....	77	PN902429.....	106	PS305102.....	468	PTL13.....	471	Z12L6WAR.....	192	Z12S43TN.....	261
PN6613PT9-4.....	77	PN903029.....	106	PS305157.....	468	PTL14.....	471	Z12L7SHL.....	197	Z12S43TR.....	260
PN6613PT9-12.....	77	PN903629.....	106	PS3525002.....	468	PTSL96GB.....	469	Z12L7SHN.....	198	Z12S55TCL.....	259
PN7213DG.....	76, 77	PN904229.....	106	PS3525057.....	468	PTSL96GW.....	469	Z12L7SHR.....	197	Z12S55TCR.....	259
PN7213DMF.....	76	PN904829.....	106	PS3526002.....	468	PTSL96SP.....	469	Z12L7WAL.....	199	Z12S55TL.....	258
PN7213DML.....	76	PN962429.....	106	PS3526057.....	468	PUSBTRSF.....	472	Z12L7WAR.....	200	Z12S55TN.....	259
PN7213PT9-1.....	77	PN963029.....	106	PSCOV51UB.....	467	R.....		Z12L8SHL.....	205	Z12S55TR.....	258
PN7213PT9-4.....	77	PN963629.....	106	PSCOV51US.....	467	R27855.....	447	Z12L8SHN.....	206	Z15L2BF.....	181
PN7213PT9-12.....	77	PN964229.....	106	PSCOVSM2B.....	467	R27856.....	448	Z12L8SHR.....	206	Z15L2BFS.....	174
PN7229BGS.....	99	PN964829.....	106	PSCOVSM2S.....	467	R27857.....	448	Z12L8WAL.....	208	Z15L2E.....	181
PN7229PL.....	99	PN1203629.....	107	PSDPC22W.....	468	R27858.....	448	Z12L8WAR.....	208	Z15L2ES.....	173
PN7813DMF.....	76	PN1204229.....	107	PSDPC32W.....	468	R27859.....	448	Z12M2SHL.....	179	Z15L2FN.....	181
PN7813DML.....	76	PN1204829.....	107	PSMA1.....	458	R27860.....	448	Z12M2SHN.....	180	Z15L2FS.....	174
PN7813PT9-1.....	77	PN1443629.....	107	PSMA2.....	458	R27861.....	448	Z12M2SHR.....	180	Z15L2SHL.....	179
PN7813PT9-4.....	77	PN1444229.....	107	PSMS.....	458	RT6.....	318	Z12M2SHSL.....	173	Z15L2SHN.....	180
PN7813PT9-12.....	77	PN1444829.....	107	PT9MP3013-1.....	457	RT6A.....	317	Z12M2SHSN.....	174	Z15L2SHR.....	180
PN8413DML.....	76	PP42D0361.....	393	PT9MP3013-4.....	457	RT6R.....	318	Z12M2SHSR.....	173	Z15L2SHSL.....	173
PN242429.....	106	PP42D0362.....	393	PT9MP3013-12.....	457	RT6X.....	317	Z12M4SHL.....	183	Z15L2SHSN.....	174
PN242429C.....	107	PP42D0421.....	393	PT9MP3613-1.....	457	RT6Z.....	317	Z12M4SHN.....	184	Z15L2SHSR.....	173
PN246027R.....	64	PP42D0422.....	393	PT9MP3613-4.....	457	RT8.....	318	Z12M4SHR.....	183	Z15L4EN.....	184
PN246029R.....	64	PP42D0481.....	393	PT9MP3613-12.....	457	RT8A.....	317	Z12M5SHL.....	186	Z15L4SHL.....	183
PN246627R.....	64	PP42D0482.....	393	PT9MP4213-1.....	457	RT8R.....	318	Z12M5SHN.....	187	Z15L4SHN.....	184
PN246629R.....	64	PP42D0541.....	393	PT9MP4213-4.....	457	RT8W.....	318	Z12M5SHR.....	186	Z15L4SHR.....	183
PN247227R.....	64	PP42D0542.....	393	PT9MP4213-12.....	457	RT8WA.....	317	Z12M6SHL.....	189	Z15L5EL.....	187
PN247229R.....	64	PP42D0601.....	393	PT9MP4813-1.....	457	RT8WR.....	318	Z12M6SHN.....	190	Z15L5EN.....	188
PN247827R.....	64	PP42D0602.....	393	PT9MP4813-4.....	457	RT8WX.....	317	Z12M6SHR.....	189	Z15L5ER.....	188
PN247829R.....	64	PP42D0661.....	393	PT9MP4813-12.....	457	RT8WZ.....	317	Z12M6WAL.....	191	Z15L5SHL.....	186
PN248427R.....	64	PP42D0662.....	393	PT9MP5413-1.....	457	RT8X.....	317	Z12M6WAR.....	192	Z15L5SHN.....	187
PN248429R.....	64	PP42D0721.....	393	PT9MP5413-4.....	457	RT8Z.....	317	Z12M7SHL.....	197	Z15L5SHR.....	186
PN303029.....	106	PP42D0722.....	393	PT9MP5413-12.....	457	RT10.....	318	Z12M7SHN.....	198	Z15L6EL.....	190
PN303029C.....	107	PP42HW72.....	394	PT9MP6013-1.....	457	RT10A.....	317	Z12M7SHR.....	197	Z15L6EN.....	191
PN363629.....	106	PP42J18.....	394	PT9MP6013-4.....	457	RT10R.....	318	Z12M7WAL.....	199	Z15L6ER.....	191
PN363629C.....	107	PP42J24.....	394	PT9MP6013-12.....	457	RT10W.....	318	Z12M7WAR.....	200	Z15L6SHL.....	189
PN424229.....	106	PP42J30.....	394	PT9MP6613-1.....	457	RT10WA.....	317	Z12M8SHL.....	205	Z15L6SHN.....	190
PN424229C.....	107	PP42J36.....	394	PT9MP6613-4.....	457	RT10WR.....	318	Z12M8SHN.....	206	Z15L6SHR.....	189
PN482429.....	106	PP42J42.....	394	PT9MP6613-12.....	457	RT10WX.....	317	Z12M8SHR.....	206	Z15L6WAL.....	191
PN482429C.....	107	PP42J48.....	394	PT9MP7213-1.....	457	RT10WZ.....	317	Z12M8WAL.....	208	Z15L6WAR.....	192
PN483029.....	106	PP42J54.....	394	PT9MP7213-4.....	457	RT10X.....	317	Z12M8WAR.....	208	Z15L7EL.....	198
PN483029C.....	107	PP42J60.....	394	PT9MP7213-12.....	457	RT10Z.....	317	Z12S2SHL.....	179	Z15L7EN.....	199
PN484829.....	106	PP42J66.....	394	PT9MP7813-1.....	457	RT12W.....	318	Z12S2SHN.....	180	Z15L7ER.....	198
PN484829C.....	107	PP42J72.....	394	PT9MP7813-4.....	457	RT12WA.....	317	Z12S2SHR.....	180	Z15L7SHL.....	197
PN542429.....	106	PP42SO241.....	393	PT9MP7813-12.....	457	RT12WR.....	318	Z12S4SHL.....	183	Z15L7SHN.....	198
PN542429C.....	107	PP42SO242.....	393	PT9PP3013-1.....	456	RT12WX.....	317	Z12S4SHN.....	184	Z15L7SHR.....	197
PN543029.....	106	PP42SO301.....	393	PT9PP3013-4.....	456	RT12WZ.....	317	Z12S4SHR.....	183	Z15L7WAL.....	199
PN543029C.....	107	PP42SO302.....	393	PT9PP3013-12.....	456	S.....		Z12S5SHL.....	186	Z15L7WAR.....	200
PN602429.....	106	PP42SO361.....	393	PT9PP3613-1.....	456	SEAT-PN1920ST.....	99	Z12S5SHN.....	187	Z15L8EL.....	207
PN602429C.....	107	PP42SO362.....	393	PT9PP3613-4.....	456	T.....		Z12S5SHR.....	186	Z15L8EN.....	207
PN603029.....	106	PP42SO421.....	393	PT9PP3613-12.....	456	TB4018.....	58	Z12S6SHL.....	189	Z15L8ER.....	207
PN603029C.....	107	PP42SO422.....	393	PT9PP4213-1.....	456	TB4618.....	58	Z12S6SHN.....	190	Z15L8SHL.....	205
PN603629.....	106	PP42SO481.....	393	PT9PP4213-4.....	456	TB5818.....	57	Z12S6SHR.....	189	Z15L8SHN.....	206
PN603629C.....	107	PP42SO482.....	393	PT9PP4213-12.....	456	TB6418.....	57	Z12S7SHL.....	197	Z15L8SHR.....	206
PN604229.....	106	PP42SO541.....	393	PT9PP4813-1.....	456	TB6618.....	57	Z12S7SHN.....	198	Z15L8WAL.....	208
PN604829.....	106	PP42SO542.....	393	PT9PP4813-4.....	456	TB6918.....	57	Z12S7SHR.....	197	Z15L8WAR.....	208
PN662429.....	106	PP42SO601.....	393	PT9PP4813-12.....	456	TB7018.....	57	Z12S8SHL.....	205	Z15L43F.....	185
PN662429C.....	107	PP42SO602.....	393	PT9PP5413-1.....	456	TCR24.....	312	Z12S8SHN.....	206	Z15L54F.....	188
PN663029.....	106	PP42SO661.....	393	PT9PP5413-4.....	456	TCR30.....	312	Z12S8SHR.....	206	Z15M2BF.....	181
PN663029C.....	107	PP42SO662.....	393	PT9PP5413-12.....	456	TCR36.....	312	Z12S12TN.....	251	Z15M2BFS.....	174
PN663629.....	106	PP42SO721.....	393	PT9PP6013-1.....	456	TCR42.....	312	Z12S23TL.....	252	Z15M2E.....	181
PN663629C.....	107	PP42SO722.....	393	PT9PP6013-4.....	456	TCS24.....	313	Z12S23TN.....	253	Z15M2ES.....	173
PN664229.....	106	PP42TP72.....	394	PT9PP6013-12.....	456	TCS30.....	313	Z12S23TR.....	253	Z15M2FN.....	181
PN664829.....	106	PP42TP120.....	394	PT9PP6613-1.....	456	TCS36.....	313	Z12S24TL.....	255	Z15M2FS.....	174
PN722429.....	106	PPVST3WF.....	469	PT9PP6613-4.....	456	TCS42.....	313	Z12S24TN.....	255	Z15M2SHL.....	179
PN722429C.....	107	PRTMCD602B.....	470	PT9PP6613-12.....	456	Z.....		Z12S24TR.....	255	Z15M2SHN.....	180
PN723029.....	106	PRTMCD602T.....	470	PT9PP7213-1.....	456	Z12L2SHL.....	179	Z12S31TL.....	257	Z15M2SHR.....	180
PN723029C.....	107	PRTMCD602W.....	470	PT9PP7213-4.....	456	Z12L2SHN.....	180	Z12S31TN.....	258	Z15M2SHSL.....	173
PN723629.....	106	PRTMCD622B.....	470	PT9PP7213-12.....	456	Z12L2SHR.....	180	Z12S31TR.....	258	Z15M2SHSN.....	174
PN723629C.....	107	PRTMCD622T.....	470	PT9PP7813-1.....	456	Z12L2SHSL.....	173	Z12S36TCL.....	254	Z15M2SHSR.....	173
PN724229.....	106	PRTMCD622W.....	470	PT9PP7813-4.....	456	Z12L2SHSN.....	174	Z12S36TCR.....	254	Z15M4EN.....	184
PN724829.....	106	PRTMCD642B.....	470	PT9PP7813-12.....	456	Z12L2SHSR.....	173	Z12S36TL.....	253	Z15M4SHL.....	183
PN782429.....	106	PRTMCD642T.....	470	PTL01.....	471	Z12L4SHL.....	183	Z12S36TN.....	254	Z15M4SHN.....	184
PN783029.....	106	PRTMCD642W.....	470	PTL02.....	471	Z12L4SHN.....	184	Z12S36TR.....	253	Z15M4SHR.....	183

Z15M5EL.....187	Z15S36TN.....254	Z16M2SHSN.....174	Z16S8EN.....207	Z18M2SHN.....180	Z20M4ESHR.....262
Z15M5EN.....188	Z15S36TR.....253	Z16M2SHSR.....173	Z16S8ER.....207	Z18M2SHR.....180	Z20M5ESHL.....262
Z15M5ER.....188	Z15S42TCL.....256	Z16M4EN.....184	Z16S8ESHL.....263	Z18M2SHSL.....173	Z20M5ESHR.....262
Z15M5SHL.....186	Z15S42TCR.....257	Z16M4SHL.....183	Z16S8ESHR.....263	Z18M2SHSN.....174	Z20M6ESHL.....262
Z15M5SHN.....187	Z15S42TL.....256	Z16M4SHN.....184	Z16S8SHL.....205	Z18M2SHSR.....173	Z20M6ESHR.....262
Z15M5SHR.....186	Z15S42TN.....257	Z16M4SHR.....183	Z16S8SHN.....206	Z18M4SHL.....183	Z20M7ESHL.....263
Z15M6EL.....190	Z15S42TR.....256	Z16M5EL.....187	Z16S8SHR.....206	Z18M4SHN.....184	Z20M7ESHR.....263
Z15M6EN.....191	Z15S43F.....185	Z16M5EN.....188	Z16S12DL.....263	Z18M4SHR.....183	Z20M8ESHL.....263
Z15M6ER.....191	Z15S43TCL.....260	Z16M5ER.....188	Z16S12DR.....263	Z18M5SHL.....186	Z20M8ESHR.....263
Z15M6SHL.....189	Z15S43TCR.....261	Z16M5SHL.....186	Z16S12PH.....228	Z18M5SHN.....187	Z20M12PH.....228
Z15M6SHN.....190	Z15S43TL.....260	Z16M5SHN.....187	Z16S12TN.....251	Z18M5SHR.....186	Z20M23PH.....228
Z15M6SHR.....189	Z15S43TN.....261	Z16M5SHR.....186	Z16S23DL.....264	Z18M6SHL.....189	Z20S12PH.....228
Z15M6WAL.....191	Z15S43TR.....260	Z16M6EL.....190	Z16S23DR.....264	Z18M6SHN.....190	Z20S23PH.....228
Z15M6WAR.....192	Z15S54F.....188	Z16M6EN.....191	Z16S23PH.....228	Z18M6SHR.....189	Z21L2SHL.....179
Z15M7EL.....198	Z15S55TCL.....259	Z16M6ER.....191	Z16S23TL.....252	Z18M6WAL.....191	Z21L2SHN.....180
Z15M7EN.....199	Z15S55TCR.....259	Z16M6SHL.....189	Z16S23TN.....253	Z18M6WAR.....192	Z21L2SHR.....180
Z15M7ER.....198	Z15S55TL.....258	Z16M6SHN.....190	Z16S23TR.....253	Z18M7SHL.....197	Z21L2SHSL.....173
Z15M7SHL.....197	Z15S55TN.....259	Z16M6SHR.....189	Z16S24TL.....255	Z18M7SHN.....198	Z21L2SHSN.....174
Z15M7SHN.....198	Z15S55TR.....258	Z16M6WAL.....191	Z16S24TN.....255	Z18M7SHR.....197	Z21L2SHSR.....173
Z15M7SHR.....197	Z16L2BF.....181	Z16M6WAR.....192	Z16S24TR.....255	Z18M7WAL.....199	Z21L4SHL.....183
Z15M7WAL.....199	Z16L2BFS.....174	Z16M7EL.....198	Z16S31TL.....258	Z18M7WAR.....200	Z21L4SHN.....184
Z15M7WAR.....200	Z16L2E.....181	Z16M7EN.....199	Z16S31TR.....258	Z18M8SHL.....205	Z21L4SHR.....183
Z15M8EL.....207	Z16L2ES.....173	Z16M7ER.....198	Z16S31TR.....258	Z18M8SHN.....206	Z21L5SHL.....186
Z15M8EN.....207	Z16L2FN.....181	Z16L2FN.....197	Z16S36DL.....264	Z18M8SHR.....206	Z21L5SHN.....187
Z15M8ER.....207	Z16L2FS.....174	Z16M7SHL.....197	Z16S36DR.....264	Z18M8WAL.....208	Z21L5SHR.....186
Z15M8SHL.....205	Z16L2FSL.....179	Z16M7SHN.....198	Z16S36TR.....253	Z18M8WAR.....208	Z21L6DIL.....192
Z15M8SHN.....206	Z16L2SHL.....179	Z16M7SHR.....197	Z16S36TCL.....261	Z18S2SHL.....179	Z21L6DINL.....193
Z15M8SHR.....206	Z16L2SHN.....180	Z16M7SHR.....197	Z16S36TCR.....254	Z18S2SHN.....180	Z21L6DINR.....193
Z15M8WAL.....208	Z16L2SHR.....180	Z16M7WAR.....200	Z16S36TL.....253	Z18S2SHR.....180	Z21L6DIR.....192
Z15M8WAR.....208	Z16L2SHSL.....173	Z16M8EL.....207	Z16S36TN.....254	Z18S4SHL.....183	Z21L6SHL.....189
Z15M8WAR.....208	Z16L2SHSN.....174	Z16M8EN.....207	Z16S36TR.....253	Z18S4SHN.....184	Z21L6SHN.....190
Z15M43F.....185	Z16L2SHSR.....173	Z16M8ER.....207	Z16S42DL.....264	Z18S4SHR.....183	Z21L6SHR.....189
Z15M54F.....188	Z16L4EN.....184	Z16M8SHL.....205	Z16S42DR.....265	Z18S5SHL.....186	Z21L6WAL.....191
Z15S2BF.....181	Z16L4SHL.....183	Z16M8SHN.....206	Z16S42TCL.....256	Z18S5SHN.....187	Z21L6WAR.....192
Z15S2E.....181	Z16L4SHN.....184	Z16M8SHR.....206	Z16S42TCR.....257	Z18S5SHR.....186	Z21L7DIL.....200
Z15S2FN.....181	Z16L4SHR.....183	Z16M8WAL.....208	Z16S42TL.....256	Z18S5SHR.....186	Z21L7DINL.....201
Z15S2SHL.....179	Z16L5EL.....187	Z16M8WAR.....208	Z16S42TN.....256	Z18S6SHL.....189	Z21L7DINR.....201
Z15S2SHN.....180	Z16L5EN.....188	Z16M12PH.....228	Z16S42TR.....256	Z18S6SHN.....190	Z21L7DIR.....200
Z15S2SHR.....180	Z16L5ER.....188	Z16M23PH.....228	Z16S43F.....185	Z18S6SHR.....189	Z21L7SHL.....197
Z15S4EN.....184	Z16L5SHL.....186	Z16M43F.....185	Z16S43TCL.....260	Z18S7SHL.....197	Z21L7SHN.....198
Z15S4SHL.....183	Z16L5SHN.....187	Z16M54F.....188	Z16S43TCR.....261	Z18S7SHR.....197	Z21L7SHR.....197
Z15S4SHN.....184	Z16L5SHR.....186	Z16S2BF.....181	Z16S43TL.....260	Z18S8SHL.....205	Z21L7WAL.....199
Z15S4SHR.....183	Z16L6EL.....190	Z16S2E.....181	Z16S43TN.....261	Z18S8SHN.....206	Z21L7WAR.....200
Z15S5EL.....187	Z16L6EN.....191	Z16S2ESHL.....261	Z16S43TR.....260	Z18S8SHR.....206	Z21L8DIL.....208
Z15S5EN.....188	Z16L6ER.....191	Z16S2ESHR.....261	Z16S54F.....188	Z18S12TN.....251	Z21L8DINL.....209
Z15S5ER.....188	Z16L6SHL.....189	Z16S2FN.....181	Z16S55DL.....265	Z18S23TL.....252	Z21L8DINR.....209
Z15S5SHL.....186	Z16L6SHN.....190	Z16S2SHL.....179	Z16S55DR.....265	Z18S23TN.....253	Z21L8DIR.....209
Z15S5SHN.....187	Z16L6SHR.....189	Z16S2SHN.....180	Z16S55TCL.....259	Z18S23TR.....253	Z21L8SHL.....205
Z15S5SHR.....186	Z16L6WAL.....191	Z16S2SHR.....180	Z16S55TCR.....259	Z18S24TL.....255	Z21L8SHN.....206
Z15S6EL.....190	Z16L6WAR.....192	Z16S4EN.....184	Z16S55TL.....258	Z18S24TN.....255	Z21L8SHR.....206
Z15S6EN.....191	Z16L7EL.....198	Z16S4ESHL.....262	Z16S55TN.....259	Z18S24TR.....255	Z21L8WAL.....208
Z15S6ER.....191	Z16L7EN.....199	Z16S4ESHR.....262	Z16S55TR.....258	Z18S31TL.....257	Z21L8WAR.....208
Z15S6SHL.....189	Z16L7ER.....198	Z16S4SHL.....183	Z18L2SHL.....179	Z18S31TN.....258	Z21M2SHL.....179
Z15S6SHN.....190	Z16L7SHL.....197	Z16S4SHN.....184	Z18L2SHN.....180	Z18S31TR.....258	Z21M2SHN.....180
Z15S6SHR.....189	Z16L7SHN.....198	Z16S4SHR.....183	Z18L2SHR.....180	Z18S36TCL.....254	Z21M2SHR.....180
Z15S7EL.....198	Z16L7SHR.....197	Z16S5EL.....187	Z18L2SHSL.....173	Z18S36TCR.....254	Z21M2SHSL.....173
Z15S7EN.....199	Z16L7WAL.....199	Z16S5EN.....188	Z18L2SHSN.....174	Z18S36TL.....253	Z21M2SHSN.....174
Z15S7ER.....198	Z16L7WAR.....200	Z16S5ER.....188	Z18L2SHSR.....173	Z18S36TN.....254	Z21M2SHSR.....173
Z15S7SHL.....197	Z16L8EL.....207	Z16S5ESHL.....262	Z18L4SHL.....183	Z18S36TR.....253	Z21M4SHL.....183
Z15S7SHN.....198	Z16L8EN.....207	Z16S5ESHR.....262	Z18L4SHN.....184	Z18S42TCL.....256	Z21M4SHN.....184
Z15S7SHR.....197	Z16L8ER.....207	Z16S5ESHL.....186	Z18L4SHR.....183	Z18S42TCR.....257	Z21M4SHR.....183
Z15S8EL.....207	Z16L8ER.....207	Z16S5SHL.....186	Z18L5SHL.....186	Z18S42TL.....256	Z21M5SHL.....186
Z15S8EN.....207	Z16L8SHL.....205	Z16S5SHN.....187	Z18L5SHN.....187	Z18S42TN.....257	Z21M5SHN.....187
Z15S8EN.....207	Z16L8SHN.....206	Z16S5SHR.....186	Z18L6SHL.....189	Z18S42TR.....256	Z21M5SHR.....186
Z15S8ER.....207	Z16L8SHR.....206	Z16S6EL.....190	Z18L6SHL.....189	Z18S43TCL.....260	Z21M6DIL.....192
Z15S8SHL.....205	Z16L8WAL.....208	Z16S6EN.....191	Z18L6SHL.....189	Z18S43TCR.....261	Z21M6DINL.....193
Z15S8SHN.....206	Z16L8WAR.....208	Z16S6ER.....191	Z18L6SHN.....190	Z18S43TL.....260	Z21M6DINR.....193
Z15S8SHR.....206	Z16L12PH.....228	Z16S6ESHL.....262	Z18L6SHR.....189	Z18S43TN.....261	Z21M6DIR.....192
Z15S12TN.....251	Z16L23PH.....228	Z16S6ESHR.....262	Z18L6WAL.....191	Z18S43TR.....260	Z21M6SHL.....189
Z15S23TL.....252	Z16L43F.....185	Z16S6SHL.....189	Z18L6WAR.....192	Z18S43TR.....260	Z21M6SHN.....190
Z15S23TN.....253	Z16L54F.....188	Z16S6SHN.....190	Z18L7SHL.....197	Z18S55TCL.....259	Z21M6SHR.....189
Z15S23TR.....253	Z16M2BF.....181	Z16S6SHR.....189	Z18L7SHN.....198	Z18S55TCR.....259	Z21M6WAL.....191
Z15S24TL.....255	Z16M2BFS.....174	Z16S7EL.....198	Z18L7SHR.....197	Z18S55TN.....259	Z21M6WAR.....192
Z15S24TN.....255	Z16M2E.....181	Z16S7EN.....199	Z18L7WAR.....199	Z18S55TR.....258	Z21M7DIL.....200
Z15S24TR.....255	Z16M2ES.....173	Z16S7ER.....198	Z18L7WAR.....200	Z20L12PH.....228	Z21M7DINL.....201
Z15S31TL.....257	Z16M2FN.....181	Z16S7ESHL.....263	Z18L8SHL.....205	Z20L23PH.....228	Z21M7DINR.....201
Z15S31TN.....258	Z16M2FS.....174	Z16S7ESHR.....263	Z18L8SHN.....206	Z20M2ESHL.....261	Z21M7DIR.....200
Z15S31TR.....258	Z16M2SHL.....179	Z16S7SHL.....197	Z18L8SHR.....206	Z20M2ESHR.....261	Z21M7SHL.....197
Z15S36TCL.....254	Z16M2SHN.....180	Z16S7SHN.....198	Z18L8SHR.....208	Z20M4ESHL.....262	Z21M7SHN.....198
Z15S36TCR.....254	Z16M2SHR.....180	Z16S7SHR.....197	Z18L8WAR.....208		
Z15S36TL.....253	Z16M2SHSL.....173	Z16S8EL.....207	Z18M2SHL.....179		

INDEX

Z21M7SHR.....	197	Z24L6EL.....	194	Z24M7ECL.....	202	Z30L5SH.....	186	Z30M2FN.....	181	Z30M8BFCL.....	212
Z21M7WAL.....	199	Z24L6ENL.....	195	Z24M7ECCR.....	202	Z30L5SHCN.....	187	Z30M2FS.....	174	Z30M8BFCR.....	212
Z21M7WAR.....	200	Z24L6ENR.....	195	Z24M7ECL.....	201	Z30L6BFCL.....	196	Z30M2HCSL.....	172	Z30M8BFL.....	211
Z21M8DIL.....	208	Z24L6ER.....	194	Z24M7ENL.....	202	Z30L6BFCSR.....	196	Z30M2HCSR.....	172	Z30M8BFNL.....	212
Z21M8DINL.....	209	Z24L6ESHL.....	262	Z24M7ENR.....	202	Z30L6BFL.....	195	Z30M2HE.....	178	Z30M8BFNR.....	212
Z21M8DINR.....	209	Z24L6ESHR.....	262	Z24M7ER.....	201	Z30L6BFNL.....	196	Z30M2HES.....	171	Z30M8BFR.....	211
Z21M8DIR.....	209	Z24L6GVAL.....	191	Z24M7WAR.....	199	Z30L6BFNR.....	196	Z30M2HFN.....	178	Z30M8DIL.....	208
Z21M8SHL.....	205	Z24L6GWAR.....	192	Z24M7WAR.....	200	Z30L6BFR.....	195	Z30M2HFS.....	171	Z30M8DINL.....	209
Z21M8SHN.....	206	Z24L7BFCL.....	203	Z24M8BFCL.....	212	Z30L6DIL.....	192	Z30M2HSH.....	178	Z30M8DINR.....	209
Z21M8SHR.....	206	Z24L7BFCSR.....	203	Z24M8BFCSR.....	212	Z30L6DINL.....	193	Z30M2HSHN.....	178	Z30M8DIR.....	209
Z21M8WAL.....	208	Z24L7BFL.....	203	Z24M8BFL.....	211	Z30L6DINR.....	193	Z30M2HSHNS.....	171	Z30M8ECL.....	206
Z21M8WAR.....	208	Z24L7BFNL.....	204	Z24M8BFNL.....	212	Z30L6DIR.....	192	Z30M2HSHS.....	172	Z30M8ECL.....	210
Z21S2SHL.....	179	Z24L7BFNR.....	204	Z24M8BFNR.....	212	Z30L6E.....	190	Z30M2HXHL.....	179	Z30M8ECCR.....	210
Z21S2SHN.....	180	Z24L7BFR.....	203	Z24M8BFR.....	211	Z30L6ECL.....	194	Z30M2HXHR.....	179	Z30M8ECL.....	210
Z21S2SHR.....	180	Z24L7DIL.....	200	Z24M8DIL.....	208	Z30L6ECCR.....	194	Z30M2HXNL.....	178	Z30M8EN.....	207
Z21S4SHL.....	183	Z24L7DINL.....	201	Z24M8DINL.....	209	Z30L6EL.....	194	Z30M2HXNR.....	178	Z30M8ENL.....	211
Z21S4SHN.....	184	Z24L7DIR.....	201	Z24M8DINR.....	209	Z30L6EN.....	191	Z30M2HXSL.....	171	Z30M8ENR.....	211
Z21S4SHR.....	183	Z24L7DIR.....	200	Z24M8DIR.....	209	Z30L6ENL.....	195	Z30M2HXSR.....	171	Z30M8ER.....	210
Z21S5SHL.....	186	Z24L7ECL.....	202	Z24M8ECL.....	210	Z30L6ENR.....	195	Z30M2SH.....	179	Z30M8SH.....	205
Z21S5SHN.....	187	Z24L7ECCR.....	202	Z24M8ECCR.....	210	Z30L6ER.....	194	Z30M2SHN.....	180	Z30M8SHN.....	206
Z21S5SHR.....	186	Z24L7EL.....	201	Z24M8EL.....	210	Z30L6ESH.....	189	Z30M2SHS.....	173	Z30M8WA.....	208
Z21S6SHL.....	189	Z24L7ENL.....	202	Z24M8ENL.....	211	Z30L6SHN.....	190	Z30M2SHSN.....	174	Z30M21E.....	177
Z21S6SHN.....	190	Z24L7ENR.....	202	Z24M8ENR.....	211	Z30L6WA.....	191	Z30M2XL.....	182	Z30M21ES.....	169
Z21S6SHR.....	189	Z24L7ER.....	201	Z24M8ER.....	210	Z30L7BFCL.....	203	Z30M2XNL.....	182	Z30M21E.....	177
Z21S7SHL.....	197	Z24L7ESHL.....	263	Z24M8WAL.....	208	Z30L7BFCSR.....	203	Z30M2XNR.....	182	Z30M21SHN.....	177
Z21S7SHN.....	198	Z24L7ESHR.....	263	Z24M8WAR.....	208	Z30L7BFL.....	203	Z30M2XNSL.....	175	Z30M21SHS.....	169
Z21S7SHR.....	197	Z24L7WAL.....	199	Z24M12PH.....	228	Z30L7BFNL.....	204	Z30M2XNSR.....	175	Z30M21SNS.....	169
Z21S8SHL.....	205	Z24L7WAR.....	200	Z24M23PH.....	228	Z30L7BFNR.....	204	Z30M2XR.....	182	Z30M21XHL.....	177
Z21S8SHN.....	206	Z24L8BFCL.....	212	Z24S12PH.....	228	Z30L7BFR.....	203	Z30M2XSL.....	175	Z30M21XHR.....	177
Z21S8SHR.....	206	Z24L8BFCR.....	212	Z24S20OS.....	216	Z30L7DIL.....	200	Z30M2XSR.....	175	Z30M21XSL.....	170
Z21S12TN.....	251	Z24L8BFL.....	211	Z24S20OSD.....	218	Z30L7DINL.....	201	Z30M4EN.....	184	Z30M21XSR.....	170
Z21S23TL.....	252	Z24L8BFNL.....	212	Z24S20OSL.....	216	Z30L7DINR.....	201	Z30M4SH.....	183	Z30M43F.....	185
Z21S23TN.....	253	Z24L8BFNR.....	212	Z24S20OSN.....	220	Z30L7DIR.....	200	Z30M4SHN.....	184	Z30M54F.....	188
Z21S23TR.....	253	Z24L8BFR.....	211	Z24S20OSR.....	216	Z30L7E.....	198	Z30M5E.....	187	Z30S2E.....	181
Z21S24TL.....	255	Z24L8DIL.....	208	Z24S23PH.....	228	Z30L7ECL.....	202	Z30M5EN.....	188	Z30S2FFN.....	181
Z21S24TN.....	255	Z24L8DINL.....	209	Z24S33OP.....	213	Z30L7ECCR.....	202	Z30M5SH.....	186	Z30S2SH.....	179
Z21S24TR.....	255	Z24L8DIR.....	209	Z24S33OPN.....	219	Z30L7EL.....	201	Z30M5SHN.....	187	Z30S2SHN.....	180
Z21S31TL.....	257	Z24L8ECL.....	210	Z24S33OS.....	213	Z30L7EN.....	199	Z30M6BFCL.....	196	Z30S2XL.....	182
Z21S31TN.....	258	Z24L8ECLR.....	210	Z24S33OSD.....	215	Z30L7ENL.....	202	Z30M6BFCSR.....	196	Z30S2XNL.....	182
Z21S31TR.....	258	Z24L8ECCR.....	210	Z24S33OSL.....	214	Z30L7ENR.....	202	Z30M6BFL.....	195	Z30S2XNR.....	182
Z21S36TCL.....	254	Z24L8EL.....	210	Z24S33OSN.....	219	Z30L7ER.....	201	Z30M6BFNL.....	196	Z30S2XR.....	182
Z21S36TCR.....	254	Z24L8ENL.....	211	Z24S33OSR.....	214	Z30L7SH.....	197	Z30M6BFNR.....	196	Z30S4EN.....	184
Z21S36TL.....	253	Z24L8ENR.....	211	Z30LZE.....	181	Z30L7SHN.....	198	Z30M6BFR.....	195	Z30S4SH.....	183
Z21S36TN.....	254	Z24L8ER.....	210	Z30LZES.....	173	Z30L7WA.....	199	Z30M6DIL.....	192	Z30S4SHN.....	184
Z21S36TR.....	253	Z24L8ESHL.....	263	Z30LZFN.....	181	Z30L8BFCR.....	212	Z30M6DINL.....	193	Z30S5E.....	187
Z21S42TCL.....	256	Z24L8ESHR.....	263	Z30LZFS.....	174	Z30L8BFCSR.....	212	Z30M6DINR.....	193	Z30S5EN.....	188
Z21S42TCR.....	257	Z24L8WAL.....	208	Z30LZHCSL.....	172	Z30L8BFL.....	211	Z30M6DIR.....	192	Z30S5SH.....	186
Z21S42TL.....	256	Z24L8WAR.....	208	Z30LZHCSR.....	172	Z30L8BFNL.....	212	Z30M6E.....	190	Z30S5SHN.....	187
Z21S42TN.....	257	Z24L12PH.....	228	Z30LZHE.....	178	Z30L8BFR.....	212	Z30M6ECL.....	194	Z30S6E.....	190
Z21S42TR.....	256	Z24L23PH.....	228	Z30LZHES.....	171	Z30L8BFR.....	211	Z30M6ECCR.....	194	Z30S6EN.....	191
Z21S43TCL.....	260	Z24M2HSHNS.....	171	Z30LZHFS.....	178	Z30L8DIL.....	208	Z30M6EL.....	194	Z30S6SH.....	189
Z21S43TCR.....	261	Z24M6BFCL.....	196	Z30LZHFS.....	171	Z30L8DINL.....	209	Z30M6EN.....	191	Z30S6SHN.....	190
Z21S43TL.....	260	Z24M6BFCR.....	196	Z30LZHSH.....	178	Z30L8DIR.....	209	Z30M6ENL.....	195	Z30S7E.....	198
Z21S43TN.....	261	Z24M6BFL.....	195	Z30LZHSHN.....	178	Z30L8DIR.....	209	Z30M6ENR.....	195	Z30S7EN.....	199
Z21S43TR.....	260	Z24M6BFNL.....	196	Z30LZHSHNS.....	171	Z30L8E.....	206	Z30M6ER.....	194	Z30S7SH.....	197
Z21S55TCL.....	259	Z24M6BFNR.....	196	Z30LZHSHS.....	172	Z30L8ECL.....	210	Z30M6ESH.....	189	Z30S7SHN.....	198
Z21S55TCR.....	259	Z24M6BFR.....	195	Z30LZHSHS.....	179	Z30L8ECCR.....	210	Z30M6SH.....	190	Z30S8E.....	206
Z21S55TL.....	258	Z24M6DIL.....	192	Z30LZHXL.....	179	Z30L8EL.....	210	Z30M6WA.....	191	Z30S8EN.....	207
Z21S55TN.....	259	Z24M6DINL.....	193	Z30LZHXR.....	178	Z30L8ECL.....	210	Z30M7BFCL.....	203	Z30S8SH.....	205
Z21S55TR.....	258	Z24M6DINR.....	193	Z30LZHXL.....	178	Z30L8ENL.....	211	Z30M7BFCSR.....	203	Z30S8SHN.....	206
Z24L2ESHL.....	261	Z24M6DIR.....	192	Z30LZHXR.....	171	Z30L8ENR.....	211	Z30M7BFL.....	203	Z30S12TN.....	251
Z24L2ESHR.....	261	Z24M6ECL.....	194	Z30LZHXR.....	171	Z30L8ER.....	210	Z30M7BFNL.....	204	Z30S16OS.....	218
Z24L2HSHNS.....	171	Z24M6ECCR.....	194	Z30LZHS.....	179	Z30L8ESH.....	205	Z30M7BFNR.....	204	Z30S16OSN.....	220
Z24L4ESHL.....	262	Z24M6EL.....	194	Z30LZSH.....	180	Z30L8SHN.....	206	Z30M7BFR.....	203	Z30S20OS.....	216
Z24L4ESHR.....	262	Z24M6ENL.....	195	Z30LZSHS.....	173	Z30L8WA.....	208	Z30M7DIL.....	200	Z30S20OSD.....	218
Z24L5ESHL.....	262	Z24M6ENR.....	195	Z30LZSHSN.....	174	Z30L21E.....	177	Z30M7DINL.....	201	Z30S20OSL.....	216
Z24L5ESHR.....	262	Z24M6ER.....	194	Z30LZXL.....	182	Z30L21ES.....	169	Z30M7DINR.....	201	Z30S20OSN.....	220
Z24L6BFCL.....	196	Z24M6WAL.....	191	Z30LZXNL.....	182	Z30L21SH.....	177	Z30M7DIR.....	200	Z30S20OSR.....	216
Z24L6BFCR.....	196	Z24M6WAR.....	192	Z30LZXNR.....	182	Z30L21SHN.....	177	Z30M7E.....	198	Z30S23HN.....	221
Z24L6BFL.....	195	Z24M7BFCL.....	203	Z30LZXNSL.....	175	Z30L21SHS.....	169	Z30M7ECL.....	202	Z30S23T.....	252
Z24L6BFNL.....	196	Z24M7BFCR.....	203	Z30LZXNSR.....	175	Z30L21SNS.....	169	Z30M7ECCR.....	202	Z30S23TN.....	253
Z24L6BFNR.....	196	Z24M7BFL.....	203	Z30LZXR.....	182	Z30L21XHL.....	177	Z30M7EL.....	201	Z30S24T.....	255
Z24L6BFR.....	195	Z24M7BFNL.....	204	Z30LZXS.....	175	Z30L21XHR.....	177	Z30M7EN.....	199	Z30S24TN.....	255
Z24L6DIL.....	192	Z24M7BFR.....	203	Z30LZXSR.....	175	Z30L21XSL.....	170	Z30M7ENL.....	202	Z30S31T.....	257
Z24L6DINL.....	193	Z24M7BFR.....	203	Z30L4EN.....	184	Z30L21XSR.....	170	Z30M7ENR.....	202	Z30S31TN.....	258
Z24L6DINR.....	193	Z24M7DIL.....	200	Z30L4SH.....	183	Z30L43F.....	185	Z30M7ER.....	201	Z30S33OP.....	213
Z24L6DIR.....	192	Z24M7DINL.....	201	Z30L4ASH.....	184	Z30L54F.....	188	Z30M7SH.....	197	Z30S33OPN.....	219
Z24L6ECL.....	194	Z24M7DINR.....	201	Z30L5E.....	187	Z30M2E.....	181	Z30M7SHN.....	198	Z30S33OS.....	213
Z24L6ECCR.....	194	Z24M7DIR.....	200	Z30L5EN.....	188	Z30M2ES.....	173	Z30M7WA.....	199	Z30S33OSD.....	215

Z30S330SL	214	Z36L6DIR	192	Z36M2HSHS	172	Z36M8DIR	209	Z36S41T	251	Z54S360HO	223
Z30S330SN	219	Z36L6E	190	Z36M2HXHL	179	Z36M8DIR	209	Z36S42H	226	Z54S42HOH	224
Z30S330SR	214	Z36L6ECL	194	Z36M2HXHR	179	Z36M8E	206	Z36S42HN	222	Z54S42HSD	225
Z30S36H	224	Z36L6ECCR	194	Z36M2HXNL	178	Z36M8ECL	210	Z36S42T	256	Z54S42HSL	225
Z30S36HN	221	Z36L6EL	194	Z36M2HXNR	178	Z36M8ECCR	210	Z36S42TC	256	Z54S42HSR	225
Z30S36T	253	Z36L6EN	191	Z36M2HXSL	171	Z36M8ECL	210	Z36S42TN	257	Z54S420HN	222
Z30S36TC	254	Z36L6ENL	195	Z36M2HXSR	171	Z36M8ECL	210	Z36S43F	185	Z54S420HO	225
Z30S36TN	254	Z36L6ENR	195	Z36M2SE	181	Z36M8ENL	211	Z36S43T	260	Z54S55HOH	226
Z30S41T	251	Z36L6ER	194	Z36M2SH	179	Z36M8ENR	211	Z36S43TC	260	Z54S55HSD	227
Z30S42H	226	Z36L6ESH	189	Z36M2SHN	180	Z36M8ER	210	Z36S43TN	261	Z54S55HSL	226
Z30S42HN	222	Z36L6SHN	190	Z36M2SHS	173	Z36M8ESH	205	Z36S48T	251	Z54S55HSR	226
Z30S42T	256	Z36L6WA	191	Z36M2SHSN	174	Z36M8SHN	206	Z36S49T	252	Z54S550HN	223
Z30S42TC	256	Z36L7BFCL	203	Z36M2XL	182	Z36M8WA	208	Z36S54F	188	Z54S550HO	226
Z30S42TN	257	Z36L7BFCR	203	Z36M2XNL	182	Z36M21E	177	Z36S54T	252	Z60BEC	278
Z30S43F	185	Z36L7BFL	203	Z36M2XNR	182	Z36M21ES	169	Z36S55H	227	Z60LMP	167
Z30S43T	260	Z36L7BFNL	204	Z36M2XNSL	175	Z36M21SH	177	Z36S55HN	222	Z60S160S	218
Z30S43TC	260	Z36L7BFNR	204	Z36M2XNSR	175	Z36M21SHN	177	Z36S55T	258	Z60S160SN	220
Z30S43TN	261	Z36L7BFR	203	Z36M2XR	182	Z36M21SHS	169	Z36S55TC	259	Z60S200N	220
Z30S48T	251	Z36L7DIL	200	Z36M2XSL	175	Z36M21SNS	169	Z36S55TN	259	Z60S200S	216
Z30S49T	252	Z36L7DINL	201	Z36M2XSR	175	Z36M21XHL	177	Z36S61T	252	Z60S200SD	218
Z30S54F	188	Z36L7DIR	201	Z36M4EN	184	Z36M21XHR	177	Z42S160S	218	Z60S200SL	217
Z30S54T	252	Z36L7DIR	200	Z36M4S3F	185	Z36M21XSL	170	Z42S160SN	220	Z60S200SN	220
Z30S55H	227	Z36L7E	198	Z36M4SH	183	Z36M21XSR	170	Z42S200S	216	Z60S200SO	217
Z30S55HN	222	Z36L7ECL	202	Z36M4SHN	184	Z36M43F	185	Z42S200SD	218	Z60S200SR	217
Z30S55T	258	Z36L7ECCR	202	Z36M5E	187	Z36M54F	188	Z42S200SL	216	Z60S20SOS	217
Z30S55TC	259	Z36L7EL	201	Z36M5EN	188	Z36S2E	181	Z42S200SN	220	Z60S23HN	221
Z30S55TN	259	Z36L7EN	199	Z36M5S4F	188	Z36S2FN	181	Z42S200SR	216	Z60S330N	219
Z30S61T	252	Z36L7ENL	202	Z36M5SH	186	Z36S2SH	179	Z42S23HN	221	Z60S330S	213
Z36L2E	181	Z36L7ENR	202	Z36M5SHN	187	Z36S2SHN	180	Z42S330P	213	Z60S330SD	215
Z36L2ES	173	Z36L7ER	201	Z36M6BFC	196	Z36S2XNL	182	Z42S330PN	219	Z60S330SL	219
Z36L2FN	181	Z36L7SH	197	Z36M6BFCR	196	Z36S2XNL	182	Z42S330S	213	Z60S330SN	219
Z36L2FS	174	Z36L7SHN	198	Z36M6BFL	195	Z36S2XNR	182	Z42S330SD	215	Z60S330SO	214
Z36L2HCSL	172	Z36L7WA	199	Z36M6BFNL	196	Z36S2XR	182	Z42S330SL	214	Z60S330SR	215
Z36L2HCSR	172	Z36L8BFCL	212	Z36M6BFNR	196	Z36S4EN	184	Z42S330SN	219	Z60S330SO	213
Z36L2HE	178	Z36L8BFCR	212	Z36M6BFR	195	Z36S4SH	183	Z42S330SR	214	Z60S36H	224
Z36L2HES	171	Z36L8BFL	211	Z36M6DIL	192	Z36S4SHN	184	Z42S36H	224	Z60S36HN	221
Z36L2HFN	178	Z36L8BFNL	212	Z36M6DINL	193	Z36S5E	187	Z42S36HN	221	Z60S36HOH	223
Z36L2HFS	171	Z36L8BFNR	212	Z36M6DINR	193	Z36S5EN	188	Z42S42H	226	Z60S36HSD	224
Z36L2HSH	178	Z36L8BFR	211	Z36M6DIR	192	Z36S5SH	186	Z42S42HN	222	Z60S36HSL	223
Z36L2HSHN	178	Z36L8DIL	208	Z36M6E	190	Z36S5SHN	187	Z42S55H	227	Z60S36HSR	224
Z36L2HSHNS	171	Z36L8DINL	209	Z36M6ECL	194	Z36S6E	190	Z42S55HN	222	Z60S360HN	221
Z36L2HSHS	172	Z36L8DIR	209	Z36M6ECCR	194	Z36S6EN	191	Z48BEC	278	Z60S360HO	223
Z36L2HXHL	179	Z36L8DIR	209	Z36M6EL	194	Z36S6SH	189	Z48LMP	167	Z60S42H	225
Z36L2HXHR	179	Z36L8HR	206	Z36M6EN	191	Z36S6SHN	190	Z48S160S	218	Z60S42HN	222
Z36L2HXNL	178	Z36L8ECL	210	Z36M6ENL	195	Z36S7E	198	Z48S160SN	220	Z60S42HOH	224
Z36L2HXNR	178	Z36L8ECCR	210	Z36M6ENR	195	Z36S7EN	199	Z48S200SD	218	Z60S42HSD	225
Z36L2HXSL	171	Z36L8EL	210	Z36M6ER	194	Z36S7SH	197	Z48S200SL	216	Z60S42HSL	225
Z36L2HXSR	171	Z36L8EN	207	Z36M6ESH	189	Z36S7SHN	198	Z48S200SR	216	Z60S42HSR	225
Z36L2SE	181	Z36L8ENL	211	Z36M6SHN	190	Z36S8E	206	Z48S23HN	221	Z60S420HN	222
Z36L2SH	179	Z36L8ENR	211	Z36M6WA	191	Z36S8EN	207	Z48S330SD	215	Z60S420HO	225
Z36L2SHN	180	Z36L8ER	210	Z36M7BFC	203	Z36S8SH	205	Z48S330SL	214	Z60S55H	227
Z36L2SHS	173	Z36L8ESH	205	Z36M7BFCR	203	Z36S8SHN	206	Z48S330SR	214	Z60S55HN	222
Z36L2SHSN	174	Z36L8SHN	206	Z36M7BFL	203	Z36S12TN	251	Z48S36H	224	Z60S55HOH	226
Z36L2XL	182	Z36L8WA	208	Z36M7BFNL	204	Z36S160S	218	Z48S36HN	221	Z60S55HSD	227
Z36L2XNL	182	Z36L21E	177	Z36M7BFNR	204	Z36S160SN	220	Z48S42H	226	Z60S55HSL	226
Z36L2XNR	182	Z36L21ES	169	Z36M7BFR	203	Z36S200S	216	Z48S42HN	222	Z60S55HSR	226
Z36L2XNSL	175	Z36L21SH	177	Z36M7DIL	200	Z36S200SD	218	Z48S55H	227	Z60S550HN	223
Z36L2XNSR	175	Z36L21SHN	177	Z36M7DINL	201	Z36S200SL	216	Z48S55HN	222	Z60S550HO	226
Z36L2XR	182	Z36L21SHS	169	Z36M7DIR	201	Z36S200SN	220	Z54S200N	220	Z60LMP	167
Z36L2XSL	175	Z36L21SNS	169	Z36M7DIR	200	Z36S200SR	216	Z54S200S	216	Z66S200N	220
Z36L2XSR	175	Z36L21XHL	177	Z36M7E	198	Z36S23HN	221	Z54S200SD	218	Z66S200S	216
Z36L4EN	184	Z36L21XHR	177	Z36M7ECL	202	Z36S23T	252	Z54S200SL	217	Z66S200SD	218
Z36L4S3F	185	Z36L21XSL	170	Z36M7ECCR	202	Z36S23TN	253	Z54S200SN	220	Z66S200SL	217
Z36L4SH	183	Z36L21XSR	170	Z36M7EL	201	Z36S24T	255	Z54S200SO	217	Z66S200SN	220
Z36L4SHN	184	Z36L43F	185	Z36M7EN	199	Z36S24TN	255	Z54S200SR	217	Z66S200SO	217
Z36L5E	187	Z36L54F	188	Z36M7ENL	202	Z36S31T	257	Z54S20SOS	217	Z66S200SR	217
Z36L5EN	188	Z36M2E	181	Z36M7ENR	202	Z36S31TN	258	Z54S330N	219	Z66S200SO	217
Z36L5S4F	188	Z36M2ES	173	Z36M7ER	201	Z36S330P	213	Z54S330S	213	Z66S23HN	221
Z36L5SH	186	Z36M2FN	181	Z36M7SH	197	Z36S330PN	219	Z54S330SD	215	Z66S330N	219
Z36L5SHN	187	Z36M2FS	174	Z36M7SHN	198	Z36S330S	213	Z54S330SL	215	Z66S330S	213
Z36L6BFC	196	Z36M2HCSL	172	Z36M7WA	199	Z36S330SD	215	Z54S330SN	219	Z66S330SD	215
Z36L6BFCR	196	Z36M2HCSR	172	Z36M8BFC	212	Z36S330SL	214	Z54S330SO	214	Z66S330SL	215
Z36L6BFL	195	Z36M2HE	178	Z36M8BFCR	212	Z36S330SN	219	Z54S330SR	215	Z66S330SN	219
Z36L6BFNL	196	Z36M2HES	171	Z36M8BFL	211	Z36S330SR	214	Z54S330SOS	213	Z66S330SO	214
Z36L6BFNR	196	Z36M2HFN	178	Z36M8BFL	212	Z36S36H	224	Z54S36HOH	223	Z66S330SR	215
Z36L6BFR	195	Z36M2HFS	171	Z36M8BFNL	212	Z36S36HN	221	Z54S36HSD	224	Z66S330SO	213
Z36L6DIL	192	Z36M2HSH	178	Z36M8BFR	211	Z36S36T	253	Z54S36HSL	223	Z66S36H	224
Z36L6DINL	193	Z36M2HSHN	178	Z36M8DIL	208	Z36S36TC	254	Z54S36HSR	224	Z66S36HN	221
Z36L6DINR	193	Z36M2HSHNS	171	Z36M8DINL	209	Z36S36TN	254	Z54S360HN	221	Z66S36HOH	223

INDEX

Z66S36HSD	224	Z1242BRRL	287	Z2048FR	136	Z2066FFL	152	Z2090TB	176	Z2448LK.....	159
Z66S36HSL	223	Z1242BRRR	288	Z2048HRRR	283	Z2066FFR	154	Z2096HTB.....	172	Z2448LN.....	160
Z66S36HSR	224	Z1248BRRL	287	Z2048HRRR	284	Z2066FNL	152	Z2096TB	176	Z2448LRRL.....	284
Z66S36OHN	221	Z1248BRRR	288	Z2048HTB	172	Z2066FNR	155	Z2142TRBL.....	142	Z2448LRRR.....	284
Z66S36OHO	223	Z1254BRRL	287	Z2048L4	136	Z2066HTB	172	Z2142TRBR.....	142	Z2448MRL.....	167
Z66S42H	225	Z1254BRRR	288	Z2048LRRL	284	Z2066HNL	153	Z2148TRBL.....	142	Z2448MRRR.....	167
Z66S42HNL	222	Z1260BRRL	287	Z2048LRRR	285	Z2066NFR	156	Z2148TRBR.....	142	Z2448N	158
Z66S42HOH	224	Z1260BRRR	288	Z2048NHR	137	Z2066NNL	154	Z2430HTB.....	172	Z2448NHR.....	137
Z66S42HSD	225	Z1272BRRL	287	Z2048NRL	139	Z2066NNR	156	Z2430L	128, 157	Z2448NRL.....	139
Z66S42HSL	225	Z1272BRRR	288	Z2048NRR	139	Z2066S2L	145	Z2430LK.....	159	Z2448NRR.....	139
Z66S42HSR	225	Z12425SKL	266	Z2048NR4	136	Z2066S4L	146	Z2430LN.....	160	Z2448P4L.....	137
Z66S42OHN	222	Z12425SKR	266	Z2048SRL	139	Z2066S4R	146	Z2430N.....	158	Z2448P4R.....	137
Z66S42OHO	225	Z1636RL	136	Z2048SRR	139	Z2066TB	176	Z2430R	128, 158	Z2448R	158
Z66S55H	227	Z1636RR	137	Z2048TB	176	Z2072BBOL.....	129	Z2430RK.....	159	Z2448R4.....	136
Z66S55HN	222	Z1642B	140	Z2048TBRL.....	286	Z2072BBOR.....	129	Z2430RN.....	160	Z2448RFIL.....	166
Z66S55HOH	226	Z1642RL	136	Z2048TBRR.....	286	Z2072BLFL.....	129	Z2430T.....	157	Z2448RFIR.....	167
Z66S55HSD	227	Z1642RR	137	Z2048TSRL.....	285	Z2072BLFR.....	129	Z2430TB.....	176	Z2448RI.....	166
Z66S55HSL	226	Z1642TRBL.....	142	Z2048TSRR.....	285	Z2072C	145	Z2436FB.....	140	Z2448RK.....	159
Z66S55HSR	226	Z1642TRBR.....	142	Z2054HRRR.....	283	Z2072CCK	145	Z2436HRRL.....	283	Z2448RN.....	160
Z66S55OHN	223	Z1648B	140	Z2054HRRL.....	284	Z2072CS2L.....	148	Z2436HRRR.....	284	Z2448SRL.....	139
Z66S55OHO	226	Z1648RL	136	Z2054HTB	172	Z2072CS2R.....	145, 148	Z2436HTB.....	172	Z2448SRR.....	139
Z71S23HN	221	Z1648RR	137	Z2054LRRL.....	284	Z2072CS4L.....	148	Z2436L	128, 157	Z2448T.....	157
Z71S23H	224	Z1648TBRL.....	142	Z2054LRRR.....	285	Z2072CS4R.....	148	Z2436LK.....	159	Z2448TB.....	176
Z71S36HN	221	Z1648TRBR.....	142	Z2054PRRL.....	287	Z2072CSL	146	Z2436LN.....	160	Z2448TBRL.....	286
Z71S42H	225	Z1654RL	136	Z2054PRRR.....	287	Z2072CSR	146	Z2436LRRL.....	284	Z2448TBRR.....	286
Z71S42HN	222	Z1654RR	137	Z2054TB	176	Z2072D4	145	Z2436LRRR.....	284	Z2448TSRL.....	285
Z71S55H	227	Z1660ECFL.....	153	Z2054TBRL.....	286	Z2072ECFL.....	153	Z2436N.....	158	Z2448TSRR.....	285
Z71S55HN	222	Z1660ECFR	155	Z2054TBRR.....	286	Z2072ECFR.....	155	Z2436R	128, 158	Z2454HRRR.....	283
Z72LMP	167	Z1660RL	136	Z2054TSRL.....	285	Z2072ECNL.....	154	Z2436RK.....	159	Z2454HRRR.....	284
Z72S200N	220	Z1660RR	137	Z2054TSRR.....	285	Z2072ECNR.....	156	Z2436RN.....	160	Z2454HTB.....	172
Z72S200S	216	Z1666ECFL.....	153	Z2060BBOL.....	129	Z2072FFL	152	Z2436T.....	157	Z2454LRRL.....	284
Z72S200SD	218	Z1666ECFR	155	Z2060BBOR.....	129	Z2072FFR	154	Z2436TB.....	176	Z2454LRRR.....	284
Z72S200SL	217	Z1666RL	136	Z2060BLFL.....	129	Z2072FNL	152	Z2436TBRL.....	286	Z2454PRRL.....	286
Z72S200SN	220	Z1666RR	137	Z2060BLFR.....	129	Z2072FNR	155	Z2436TBRR.....	286	Z2454PRRR.....	287
Z72S200SO	217	Z1672ECFL.....	153	Z2060CK	145	Z2072HBR	144	Z2436TSRL.....	285	Z2454TB	176
Z72S200SR	217	Z1672ECFR	155	Z2060CSL	146	Z2072HBFR.....	144	Z2436TSRR.....	285	Z2454TBRL.....	286
Z72S200SOS	217	Z1672RL	136	Z2060CSR	146	Z2072HFSL.....	144	Z2442EL.....	136	Z2454TBRR.....	286
Z72S23HN	221	Z1672RR	137	Z2060D4	145	Z2072HFSR.....	144	Z2442ER.....	137	Z2454TSRL.....	285
Z72S233ON	219	Z1684ECFL.....	153	Z2060ECL	153	Z2072HRRL.....	283	Z2442FB.....	140	Z2454TSRR.....	285
Z72S233OS	213	Z1684ECFR	155	Z2060ECFR.....	155	Z2072HRRR.....	284	Z2442FL.....	136	Z2460BBOL.....	129
Z72S233OSD	215	Z2030HTB	172	Z2060ECONL.....	154	Z2072HTB	172	Z2442FR.....	136	Z2460BBOR.....	129
Z72S233OSL	215	Z2030TB	176	Z2060ECONR.....	156	Z2072L2F2.....	146	Z2442HRRL.....	283	Z2460BLFL.....	129
Z72S233OSN	219	Z2036FB	140	Z2060HBFL.....	144	Z2072LKL	147	Z2442HRRR.....	284	Z2460BLFR.....	129
Z72S233OHO	214	Z2036HRRL.....	283	Z2060HBFR.....	144	Z2072LKR	147	Z2442HTB.....	172	Z2460ECFL.....	153
Z72S233OSR	215	Z2036HRRR.....	284	Z2060HFSL.....	144	Z2072LMOL.....	143	Z2442L	128, 157	Z2460ECFR.....	155
Z72S233SOS	213	Z2036HTB	172	Z2060HFNR.....	144	Z2072LMOR.....	143	Z2442L4	136	Z2460ECNL.....	154
Z72S236H	224	Z2036LRRL.....	284	Z2060HRRL.....	283	Z2072LQF	143	Z2442LK.....	159	Z2460ECONR.....	156
Z72S236HN	221	Z2036LRRR.....	285	Z2060HRRR.....	284	Z2072LOFR.....	143	Z2442LN.....	160	Z2460FI.....	164
Z72S236HOH	223	Z2036TB	176	Z2060HTB	172	Z2072LRRL.....	284	Z2442LRRL.....	284	Z2460HBFL.....	144
Z72S236HSD	224	Z2036TBRL.....	286	Z2060LMOL.....	143	Z2072LRRR.....	285	Z2442LRRR.....	284	Z2460HBFR.....	144
Z72S236HSL	223	Z2036TBRR.....	286	Z2060LMOR.....	143	Z2072LS	147	Z2442N	158	Z2460HFSL.....	144
Z72S236HSR	224	Z2036TSRL.....	285	Z2060LOFL.....	143	Z2072LSFL.....	143	Z2442NHR.....	137	Z2460HFSR.....	144
Z72S236HNL	221	Z2036TSRR.....	285	Z2060LOFR.....	143	Z2072LSFR.....	143	Z2442NRL.....	139	Z2460HRRR.....	283
Z72S236OHO	223	Z2042EL	136	Z2060LRRL.....	284	Z2072NFL	153	Z2442NRR.....	139	Z2460HRRR.....	284
Z72S42H	225	Z2042ER	137	Z2060LRRR.....	285	Z2072NFR	156	Z2442R	128, 158	Z2460HTB.....	172
Z72S42HN	222	Z2042FB	140	Z2060LSFL.....	143	Z2072NNL	154	Z2442R4.....	136	Z2460I	164
Z72S42HOH	224	Z2042FL	136	Z2060LSFR.....	143	Z2072NRR.....	156	Z2442RK.....	159	Z2460L	128, 157
Z72S42HSD	225	Z2042FR	136	Z2060PRRL.....	287	Z2072NFR.....	156	Z2442RN.....	160	Z2460LK.....	159
Z72S42HSL	225	Z2042HRRL.....	283	Z2060PRRR.....	287	Z2072PFR.....	155	Z2442SRL.....	139	Z2460LMOL.....	143
Z72S42HSR	225	Z2042HRRR.....	284	Z2060PSL	145	Z2072PRRR.....	287	Z2442SRR.....	139	Z2460LMOR.....	143
Z72S42OHN	222	Z2042HTB	172	Z2060S4L	146	Z2072PS2L.....	145	Z2442T	157	Z2460LN.....	160
Z72S42OHO	225	Z2042L4.....	136	Z2060S4R	146	Z2072PSSC.....	146	Z2442TB.....	176	Z2460LOFL.....	143
Z72S55H	227	Z2042LRRL.....	284	Z2060TB	176	Z2072SCK.....	146	Z2442TBRL.....	286	Z2460LOFR.....	143
Z72S55HN	222	Z2042LRRR.....	285	Z2060TBRL.....	286	Z2072SKL	147	Z2442TBRR.....	286	Z2460LRRL.....	284
Z72S55HOH	226	Z2042NHR.....	137	Z2060TBRR.....	286	Z2072SKR	147	Z2442TSRL.....	285	Z2460LRRR.....	284
Z72S55HSD	227	Z2042NRL	139	Z2060TSRL.....	285	Z2072TB	176	Z2442TSR.....	285	Z2460LSFL.....	143
Z72S55HSL	226	Z2042NRR.....	139	Z2060TSRR.....	285	Z2072TBRL.....	286	Z2442LRC.....	279	Z2460LSFR.....	143
Z72S55HSR	226	Z2042R4	136	Z2066CK	145	Z2072TBRR.....	286	Z2448EL.....	136	Z2460MRL.....	167
Z72S55OHN	223	Z2042SRL	139	Z2066CS2L.....	148	Z2072TBRL.....	286	Z2448ER.....	137	Z2460MRR.....	167
Z72S55OHO	226	Z2042SRR.....	139	Z2066CS2R.....	145, 148	Z2072TSRL.....	285	Z2448FB.....	140	Z2460N	158
Z84S23HN	221	Z2042TB	176	Z2066CS4L.....	148	Z2072TSRR.....	285	Z2448F	164	Z2460PRRL.....	286
Z84S36H	224	Z2042TBRL.....	286	Z2066CS4R.....	148	Z2078HTB.....	172	Z2448FL.....	136	Z2460PRRR.....	287
Z84S36HN	221	Z2042TBRR.....	286	Z2066CSL	146	Z2078TB	176	Z2448FR.....	136	Z2460R	128, 158
Z84S42H	225	Z2042TSRL.....	285	Z2066CSR	146	Z2084ECFL.....	153	Z2448HRRL.....	283	Z2460RDB.....	283
Z84S42HN	222	Z2042TSRR.....	285	Z2066D4	145	Z2084ECFR.....	155	Z2448HRRR.....	284	Z2460RDS.....	283
Z84S55H	227	Z2048EL	136	Z2066ECFL.....	153	Z2084ECNL.....	154	Z2448HTB.....	172	Z2460RFL.....	166
Z84S55HN	222	Z2048ER.....	137	Z2066ECFR.....	155	Z2084ECNR.....	156	Z2448I	164	Z2460RFIR.....	167
Z1236BRRL	287	Z2048FB.....	140	Z2066ECNL.....	154	Z2084HTB.....	176	Z2448L	128, 157	Z2460RI.....	166
Z1236BRRR	288	Z2048FL	136	Z2066ECNR.....	156	Z2084TB	176	Z2448L4	136	Z2460RK.....	159

Z2460RN.....	160	Z2472HFSL.....	144	Z3036L.....	157	Z3066I.....	164	Z3660EDRR.....	162	Z3666IPR.....	165
Z2460T.....	157	Z2472HFSR.....	144	Z3036LK.....	159	Z3066L.....	157	Z3660EDTL.....	161	Z3666NHD.....	133
Z2460TB.....	176	Z2472HRRL.....	283	Z3036LN.....	160	Z3066LK.....	159	Z3660EDTR.....	161	Z3666OML.....	135
Z2460TBRL.....	286	Z2472HRRR.....	284	Z3036N.....	158	Z3066LN.....	160	Z3660EPM.....	164	Z3666OMR.....	135
Z2460TBRR.....	286	Z2472HTB.....	172	Z3036R.....	158	Z3066MRL.....	167	Z3660EPMR.....	164	Z3666PL.....	166
Z2460TSRL.....	285	Z2472L.....	128, 157	Z3036RK.....	159	Z3066MRR.....	167	Z3660EPRL.....	163	Z3666PP.....	166
Z2460TSRR.....	285	Z2472LF2.....	146	Z3036RN.....	160	Z3066N.....	158	Z3660EPRR.....	163	Z3666SOL.....	135
Z2462TRL.....	141	Z2472LK.....	159	Z3036T.....	157	Z3066NHD.....	133	Z3660EPTL.....	162	Z3666SOR.....	135
Z2462TRR.....	141	Z2472LKL.....	147	Z3042L.....	157	Z3066OML.....	135	Z3660EPTR.....	162	Z3666WS.....	229
Z2466CK.....	145	Z2472LKR.....	147	Z3042LK.....	159	Z3066OMR.....	135	Z3660F2L.....	132	Z3666WSO.....	229
Z2466CS2L.....	148	Z2472LMOL.....	143	Z3042LN.....	160	Z3066R.....	158	Z3660F2R.....	132	Z3672DK.....	134
Z2466CS2R.....	145, 148	Z2472LMOR.....	143	Z3042N.....	158	Z3066RDB.....	283	Z3660F3L.....	133	Z3672DM.....	134
Z2466CS4L.....	148	Z2472LN.....	160	Z3042R.....	159	Z3066RDS.....	283	Z3660F3R.....	133	Z3672DMR.....	134
Z2466CS4R.....	148	Z2472LOFL.....	143	Z3042RK.....	159	Z3066RFIL.....	166	Z3660F22.....	130	Z3672DML.....	134
Z2466CSL.....	146	Z2472LOFR.....	143	Z3042RN.....	160	Z3066RFIR.....	167	Z3660F23.....	131	Z3672E2L.....	150
Z2466CSR.....	146	Z2472LRRL.....	284	Z3042T.....	157	Z3066RI.....	166	Z3660F32.....	131	Z3672E2R.....	151
Z2466D4.....	145	Z2472LRRR.....	284	Z3048L.....	157	Z3066RK.....	159	Z3660F33.....	131	Z3672E3L.....	150
Z2466ECFL.....	153	Z2472LS.....	147	Z3048LK.....	159	Z3066RN.....	160	Z3660FB2L.....	131	Z3672E3R.....	151
Z2466ECFR.....	155	Z2472LSFL.....	143	Z3048LN.....	160	Z3066SOL.....	135	Z3660FB2R.....	132	Z3672EB2L.....	150
Z2466ECNL.....	154	Z2472LSFR.....	143	Z3048N.....	158	Z3066SOR.....	135	Z3660FB3L.....	132	Z3672EB2R.....	151
Z2466ECNR.....	156	Z2472MRL.....	167	Z3048P4L.....	137	Z3066T.....	157	Z3660FB3R.....	132	Z3672EB3L.....	150
Z2466FFL.....	152	Z2472MRR.....	167	Z3048P4R.....	137	Z3066WS.....	229	Z3660FB22.....	130	Z3672EB3R.....	151
Z2466FFR.....	154	Z2472N.....	158	Z3048R.....	158	Z3066WSO.....	229	Z3660FB23.....	130	Z3672EDML.....	162
Z2466FI.....	164	Z2472NFL.....	153	Z3048RK.....	159	Z3072DK.....	134	Z3660FB32.....	130	Z3672EDMR.....	162
Z2466FNL.....	152	Z2472NFR.....	155	Z3048RN.....	160	Z3072DM.....	134	Z3660FB33.....	130	Z3672EDRL.....	161
Z2466FNR.....	155	Z2472NNL.....	154	Z3048T.....	157	Z3072DML.....	134	Z3660FPL.....	165	Z3672EDRR.....	162
Z2466HTB.....	172	Z2472NNR.....	156	Z3060DK.....	134	Z3072DMR.....	134	Z3660FPR.....	166	Z3672EDTL.....	161
Z2466I.....	164	Z2472PRRL.....	286	Z3060DM.....	134	Z3072F2L.....	132	Z3660IPL.....	165	Z3672EDTR.....	161
Z2466L.....	128, 157	Z2472PRRR.....	287	Z3060DML.....	134	Z3072F2R.....	132	Z3660IPR.....	165	Z3672EPL.....	164
Z2466LK.....	159	Z2472R.....	128, 158	Z3060DMR.....	134	Z3072F3L.....	133	Z3660NHD.....	133	Z3672EPMR.....	164
Z2466LN.....	160	Z2472RDB.....	283	Z3060F2L.....	132	Z3072F3R.....	133	Z3660OML.....	135	Z3672EPRL.....	163
Z2466MRL.....	167	Z2472RDS.....	283	Z3060F2R.....	132	Z3072F22.....	130	Z3660OMR.....	135	Z3672EPRR.....	163
Z2466MRR.....	167	Z2472RFL.....	166	Z3060F3L.....	133	Z3072F23.....	131	Z3660PL.....	166	Z3672EPTL.....	162
Z2466N.....	158	Z2472RFIR.....	167	Z3060F3R.....	133	Z3072F32.....	131	Z3660PR.....	166	Z3672EPTR.....	162
Z2466NFL.....	153	Z2472RKL.....	159	Z3060F22.....	130	Z3072F33.....	131	Z3660SOL.....	135	Z3672F2L.....	132
Z2466NFR.....	155	Z2472RNL.....	160	Z3060F23.....	131	Z3072FI.....	164	Z3660SOR.....	135	Z3672F2R.....	132
Z2466NNL.....	154	Z2472S2L.....	145	Z3060F32.....	131	Z3072L.....	157	Z3666DK.....	134	Z3672F3L.....	133
Z2466NNR.....	156	Z2472S4L.....	146	Z3060F33.....	131	Z3072LK.....	159	Z3666DM.....	134	Z3672F3R.....	133
Z2466R.....	128, 158	Z2472S4R.....	146	Z3060FI.....	164	Z3072LN.....	160	Z3666DML.....	134	Z3672F22.....	130
Z2466RDB.....	283	Z2472SCSC.....	146	Z3060FIC.....	165	Z3072MRL.....	167	Z3666DML.....	134	Z3672F23.....	131
Z2466RDS.....	283	Z2472SKL.....	147	Z3060FIL.....	165	Z3072MRR.....	167	Z3666E2L.....	150	Z3672F32.....	131
Z2466RFL.....	166	Z2472SKR.....	147	Z3060FIR.....	165	Z3072N.....	158	Z3666E2R.....	151	Z3672F33.....	131
Z2466RFIR.....	167	Z2472T.....	157	Z3060I.....	164	Z3072NHD.....	133	Z3666E3L.....	150	Z3672FB2L.....	131
Z2466RI.....	166	Z2472TB.....	176	Z3060L.....	157	Z3072OML.....	135	Z3666E3R.....	151	Z3672FB2R.....	132
Z2466RK.....	159	Z2472TBRL.....	286	Z3060LK.....	159	Z3072OMR.....	135	Z3666EB2L.....	150	Z3672FB3L.....	132
Z2466RN.....	160	Z2472TBRR.....	286	Z3060LN.....	160	Z3072R.....	158	Z3666EB2R.....	151	Z3672FB3R.....	132
Z2466S2L.....	145	Z2472TRL.....	141	Z3060MRL.....	167	Z3072RDB.....	283	Z3666EB3L.....	150	Z3672FB22.....	130
Z2466S4L.....	146	Z2472TRR.....	141	Z3060MRR.....	167	Z3072RDS.....	283	Z3666EB3R.....	151	Z3672FB23.....	130
Z2466S4R.....	146	Z2472TSRL.....	285	Z3060N.....	158	Z3072RK.....	159	Z3666EDML.....	162	Z3672FB32.....	130
Z2466T.....	157	Z2472TSRR.....	285	Z3060NHD.....	133	Z3072RN.....	160	Z3666EDMR.....	162	Z3672FB33.....	130
Z2466TB.....	176	Z2472WS.....	230	Z3060OML.....	135	Z3072SOL.....	135	Z3666EDRL.....	161	Z3672FI.....	164
Z2466TRL.....	141	Z2472WSO.....	230	Z3060OMR.....	135	Z3072SOR.....	135	Z3666EDRR.....	162	Z3672FIC.....	165
Z2466TRR.....	141	Z2478HTB.....	172	Z3060R.....	158	Z3072T.....	157	Z3666EDTL.....	161	Z3672FIL.....	165
Z2466WS.....	229	Z2478TB.....	176	Z3060RDB.....	283	Z3072WS.....	230	Z3666EDTR.....	161	Z3672FIR.....	165
Z2466WSO.....	229	Z2484ECFL.....	153	Z3060RDS.....	283	Z3072WSO.....	230	Z3666EPM.....	164	Z3672FPL.....	165
Z2468TRL.....	141	Z2484ECFR.....	155	Z3060RFIL.....	166	Z3084RDB.....	283	Z3666EPMR.....	164	Z3672FPR.....	166
Z2468TRR.....	141	Z2484ECNL.....	154	Z3060RFIR.....	167	Z3084RDS.....	283	Z3666EPRL.....	163	Z3672FBR.....	164
Z2472BBOL.....	129	Z2484ECNR.....	156	Z3060RI.....	166	Z3084RFIL.....	166	Z3666EPRR.....	163	Z3672IPL.....	165
Z2472BBOR.....	129	Z2484HTB.....	172	Z3060RK.....	159	Z3084RFIR.....	167	Z3666EPTL.....	162	Z3672IPR.....	165
Z2472BLFL.....	129	Z2484RDB.....	283	Z3060RN.....	160	Z3084WS.....	230	Z3666EPTR.....	162	Z3672MRL.....	167
Z2472BLFR.....	129	Z2484RDS.....	283	Z3060SOL.....	135	Z3084WSO.....	230	Z3666F2L.....	132	Z3672MRR.....	167
Z2472CK.....	145	Z2484TB.....	176	Z3060SOR.....	135	Z3096RDB.....	283	Z3666F2R.....	132	Z3672NHD.....	133
Z2472CS2L.....	148	Z2484WS.....	230	Z3060T.....	157	Z3096RDS.....	283	Z3666F3L.....	133	Z3672OML.....	135
Z2472CS2R.....	145, 148	Z2484WSO.....	230	Z3066DK.....	134	Z3636SQ.....	270	Z3666F3R.....	133	Z3672OMR.....	135
Z2472CS4L.....	148	Z2490HTB.....	172	Z3066DM.....	134	Z3660DK.....	134	Z3666F22.....	130	Z3672PL.....	166
Z2472CS4R.....	148	Z2490TB.....	176	Z3066DML.....	134	Z3660DM.....	134	Z3666F23.....	131	Z3672PR.....	166
Z2472CSL.....	146	Z2496HTB.....	172	Z3066DMR.....	134	Z3660DML.....	134	Z3666F32.....	131	Z3672RFL.....	166
Z2472CSR.....	146	Z2496RDB.....	283	Z3066F2L.....	132	Z3660DMR.....	134	Z3666F33.....	131	Z3672RFIR.....	167
Z2472D4.....	145	Z2496RDS.....	283	Z3066F2R.....	132	Z3660E2L.....	150	Z3666FB2L.....	131	Z3672RI.....	166
Z2472ECFL.....	153	Z2496TB.....	176	Z3066F3L.....	133	Z3660E2R.....	151	Z3666FB2R.....	132	Z3672SOL.....	135
Z2472ECFR.....	155	Z2822MCE.....	279	Z3066F3R.....	133	Z3660E3L.....	150	Z3666FB3L.....	132	Z3672SOR.....	135
Z2472ECNL.....	154	Z3030L.....	157	Z3066F22.....	130	Z3660E3R.....	151	Z3666FB3R.....	132	Z3672WSO.....	230
Z2472ECNR.....	156	Z3030LK.....	159	Z3066F23.....	131	Z3660EB2L.....	150	Z3666FB22.....	130	Z3672WSO.....	230
Z2472FFL.....	152	Z3030LN.....	160	Z3066F32.....	131	Z3660EB2R.....	151	Z3666FB23.....	130	Z3684DK.....	134
Z2472FFR.....	154	Z3030N.....	158	Z3066F33.....	131	Z3660EB3L.....	150	Z3666FB32.....	130	Z3684DM.....	134
Z2472FNL.....	152	Z3030R.....	158	Z3066FI.....	164	Z3660EB3R.....	151	Z3666FB33.....	130	Z3684DML.....	134
Z2472FNRL.....	155	Z3030RK.....	159	Z3066FIC.....	165	Z3660EDML.....	162	Z3666FPL.....	165	Z3684DMR.....	134
Z2472HBFL.....	144	Z3030RN.....	160	Z3066FIL.....	165	Z3660EDMR.....	162	Z3666FPR.....	166	Z3684E2L.....	150
Z2472HBFR.....	144	Z3030T.....	157	Z3066FIR.....	165	Z3660EDRL.....	161	Z3666IPL.....	165	Z3684E2R.....	151

INDEX

Z3684E3L.....	150	Z4284EPFR.....	163	Z6072RMIM.....	277	Z42165C.....	149	Z205416RR.....	138	ZA2448RR.....	128
Z3684E3R.....	151	Z4284EPML.....	164	Z6072WMIH.....	277	Z42205C.....	149	Z206016RL.....	138	ZEF19.....	236
Z3684EPML.....	164	Z4284EPMR.....	164	Z6072WMIL.....	275	Z42245C.....	149	Z206016RR.....	138	ZEFC32.....	236
Z3684EPMR.....	164	Z4284EPRL.....	163	Z6072WMMIM.....	276	Z48120BE.....	270	Z206616RL.....	138	ZEFC49.....	236
Z3684EPRL.....	163	Z4284EPRR.....	163	Z6084DMIH.....	277	Z48120BW.....	274	Z206616RR.....	138	ZEFC52.....	236
Z3684EPRR.....	163	Z4284EPTL.....	162	Z6084DMIL.....	275	Z48120REE.....	273	Z207216RL.....	138	ZEFC66.....	236
Z3684EPTL.....	162	Z4284EPTR.....	162	Z6084DMIM.....	276	Z48120RTE.....	272	Z207216RR.....	138	ZEFC72.....	236
Z3684EPTR.....	162	Z4284F2L.....	132	Z6084RMIH.....	278	Z48144BE.....	270	Z214216B.....	141	ZEFC84.....	236
Z3684F2L.....	132	Z4284F2R.....	132	Z6084RMIL.....	276	Z48144BW.....	274	Z214216BR.....	141	ZF1S2466.....	231
Z3684F2R.....	132	Z4284F3L.....	133	Z6084RMIM.....	277	Z48144REE.....	273	Z214816BL.....	141	ZF1S2466O.....	231
Z3684F3L.....	133	Z4284F3R.....	133	Z6084WMIH.....	277	Z48144RTE.....	272	Z214816BR.....	141	ZF1S2472.....	231
Z3684F3R.....	133	Z4284F22.....	130	Z6084WMIL.....	275	Z48168BE.....	270	Z243616RL.....	138	ZF1S2472O.....	231
Z3684F22.....	130	Z4284F23.....	131	Z6084WMMIM.....	276	Z48168BW.....	274	Z243616RR.....	138	ZF1S3066.....	231
Z3684F23.....	131	Z4284F32.....	131	Z6096BE.....	270	Z48168REE.....	273	Z244216BL.....	141	ZF1S3066O.....	231
Z3684F32.....	131	Z4284F33.....	131	Z6096BW.....	273	Z48168RTE.....	272	Z244216BR.....	141	ZF1S3072.....	231
Z3684F33.....	131	Z4284FB2L.....	131	Z6096DMIH.....	277	Z48192BE.....	271	Z244216RL.....	138	ZF1S3072O.....	231
Z3684NHD.....	133	Z4284FB2R.....	132	Z6096DMIL.....	275	Z48192BW.....	274	Z244216RR.....	138	ZF1S3666.....	231
Z3684OML.....	135	Z4284FB3L.....	132	Z6096DMIM.....	276	Z48192REE.....	273	Z244816BL.....	141	ZF1S3666O.....	231
Z3684OMR.....	135	Z4284FB3R.....	132	Z6096REE.....	272	Z48192RTE.....	272	Z244816BR.....	141	ZF1S3672.....	231
Z3684SOL.....	135	Z4284FB22.....	130	Z6096RMIH.....	278	Z48216BE.....	271	Z244816RL.....	138	ZF1S3672O.....	231
Z3684SOR.....	135	Z4284FB23.....	130	Z6096RMIL.....	276	Z48216BW.....	274	Z244816RR.....	138	ZF2S2466.....	231
Z3684WS.....	230	Z4284FB32.....	130	Z6096RMIM.....	277	Z48216REE.....	273	Z245416RL.....	138	ZF2S2466O.....	231
Z3684WSO.....	230	Z4284FB33.....	130	Z6096RTE.....	271	Z48216RTE.....	272	Z245416RR.....	138	ZF1S4272.....	231
Z4242SQ.....	270	Z4284NHD.....	133	Z6096WE.....	274	Z48240BE.....	271	Z246016RL.....	138	ZF1S4272O.....	231
Z4266EDFL.....	161	Z4284WS.....	230	Z6096WMIH.....	277	Z48240BW.....	274	Z246016RR.....	138	ZF2S2432.....	229
Z4266EDFR.....	161	Z4284WISO.....	230	Z6096WMIL.....	275	Z48240RTE.....	273	Z246616RL.....	138	ZF2S2466.....	232
Z4266EPFL.....	163	Z484SQ.....	270	Z6096WMMIM.....	276	Z48240RTE.....	272	Z246616RR.....	138	ZF2S2466O.....	232
Z4266EPFR.....	163	Z4860DMIH.....	277	Z20301TB.....	170	Z48264BE.....	271	Z247216RL.....	138	ZF2S2472.....	233
Z4266WS.....	229	Z4860DMIL.....	275	Z20361TB.....	170	Z48264BW.....	274	Z247216RR.....	138	ZF2S2472O.....	233
Z4266WSO.....	229	Z4860DMIM.....	276	Z20363BR.....	141	Z48264REE.....	273	Z261836BK.....	280	ZF2S2484.....	232
Z4272EB2L.....	150	Z4860RMIH.....	277	Z20421TB.....	170	Z48264RTE.....	272	Z361829BD.....	280	ZF2S2484O.....	232
Z4272EB2R.....	151	Z4860RMIL.....	275	Z20423BR.....	141	Z48288BE.....	271	Z361829BK.....	280	ZF2S3032.....	229
Z4272EB3L.....	150	Z4860RMIM.....	276	Z20481TB.....	170	Z48288BW.....	274	Z361829KO.....	280	ZF2S3066.....	232
Z4272EB3R.....	151	Z4872DMIH.....	277	Z20483BR.....	141	Z48288RTE.....	273	Z361829KO.....	280	ZF2S3066O.....	232
Z4272EDFL.....	161	Z4872DMIL.....	275	Z20483L.....	140	Z48288RTE.....	272	Z361836BD.....	280	ZF2S3072.....	233
Z4272EDFR.....	161	Z4872DMIM.....	276	Z20483R.....	140	Z60120BE.....	271	Z361836BD.....	280	ZF2S3072O.....	233
Z4272EDRL.....	162	Z4872EDFL.....	161	Z20541TB.....	170	Z60120REE.....	273	Z361836KO.....	280	ZF2S3084.....	232
Z4272EDMR.....	162	Z4872EDFR.....	161	Z20543L.....	140	Z60120RTE.....	272	Z361836KO.....	280	ZF2S3084O.....	232
Z4272EDRL.....	161	Z4872EPFL.....	163	Z20543R.....	140	Z60120WE.....	274	Z361872VB.....	279	ZF2S3632.....	229
Z4272EDRR.....	162	Z4872EPFR.....	163	Z20601TB.....	170	Z60144BE.....	271	Z367229BT.....	278	ZF2S3666.....	232
Z4272EDTL.....	161	Z4872RMIH.....	277	Z20603L.....	140	Z60144REE.....	273	Z367236BT.....	278	ZF2S3666O.....	232
Z4272EDTR.....	161	Z4872RMIL.....	275	Z20603R.....	140	Z60144RTE.....	272	Z367242BT.....	279	ZF2S3672.....	233
Z4272EPFL.....	163	Z4872RMIM.....	276	Z20661TB.....	170	Z60144WE.....	274	Z368429BT.....	278	ZF2S3672O.....	233
Z4272EPFR.....	163	Z4884DMIH.....	277	Z20663L.....	140	Z60168BE.....	271	Z368436BT.....	278	ZF2S3684.....	232
Z4272F2L.....	132	Z4884DMIL.....	275	Z20663R.....	140	Z60168REE.....	273	Z368442BT.....	279	ZF2S3684O.....	232
Z4272F2R.....	132	Z4884DMIM.....	276	Z20721TB.....	170	Z60168RTE.....	272	Z369629BT.....	278	ZF2S4232.....	229
Z4272F3L.....	133	Z4884EDFL.....	161	Z20723L.....	140	Z60168WE.....	274	Z369636BT.....	278	ZF2S4266.....	232
Z4272F3R.....	133	Z4884EDFR.....	161	Z20723R.....	140	Z60192BE.....	271	Z369642BT.....	279	ZF2S4266O.....	232
Z4272F22.....	130	Z4884EPFL.....	163	Z20781TB.....	170	Z60192BW.....	274	Z481829BD.....	280	ZF2S4272.....	233
Z4272F23.....	131	Z4884EPFR.....	163	Z20841TB.....	170	Z60192REE.....	273	Z481829BD.....	280	ZF2S4272O.....	233
Z4272F32.....	131	Z4884RMIH.....	277	Z20901TB.....	170	Z60192RTE.....	272	Z481836BD.....	280	ZF2S4284.....	232
Z4272F33.....	131	Z4884RMIL.....	275	Z20961TB.....	170	Z60192WE.....	275	Z481836BD.....	280	ZF2S4284O.....	232
Z4272FB2L.....	131	Z4884RMIM.....	276	Z24301TB.....	170	Z60216BE.....	271	Z482036BD.....	280	ZF3S2484.....	233
Z4272FB2R.....	132	Z4896BE.....	270	Z24361TB.....	170	Z60216BW.....	274	Z487229BT.....	278	ZF3S2484O.....	233
Z4272FB3L.....	132	Z4896BW.....	273	Z24363BR.....	141	Z60216REE.....	273	Z487236BT.....	279	ZF3S3008.....	233
Z4272FB3R.....	132	Z4896DMIH.....	277	Z24421TB.....	170	Z60216RTE.....	272	Z487242BT.....	279	ZF3S3084O.....	233
Z4272FB22.....	130	Z4896DMIL.....	275	Z24423BR.....	141	Z60216WE.....	275	Z488429BT.....	278	ZF3S3684.....	233
Z4272FB23.....	130	Z4896DMIM.....	276	Z24481TB.....	170	Z60240BE.....	271	Z488436BT.....	279	ZF3S3684O.....	233
Z4272FB32.....	130	Z4896REE.....	272	Z24483BR.....	141	Z60240BW.....	274	Z488442BT.....	279	ZF3S4284.....	233
Z4272FB33.....	130	Z4896RMIH.....	277	Z24483L.....	140	Z60240RTE.....	273	Z489629BT.....	278	ZF3S4284O.....	233
Z4272WS.....	230	Z4896RMIL.....	275	Z24483R.....	140	Z60240RTE.....	272	Z489636BT.....	279	ZFS2420.....	229
Z4272WSO.....	230	Z4896RMIM.....	276	Z24541TB.....	170	Z60240WE.....	275	Z489642BT.....	279	ZFS3020.....	229
Z4284E2L.....	150	Z4896RTE.....	271	Z24543L.....	140	Z60264BE.....	271	Z601829BU.....	281	ZFS3620.....	229
Z4284E2R.....	151	Z5454SQ.....	270	Z24543R.....	140	Z60264BW.....	274	Z601836BU.....	281	ZFS4220.....	229
Z4284E3L.....	150	Z6060DMIH.....	277	Z24601TB.....	170	Z60264REE.....	273	Z602036BD.....	281	ZH2442TB.....	127
Z4284E3R.....	151	Z6060DMIL.....	275	Z24603L.....	140	Z60264RTE.....	272	Z721829BU.....	281	ZH2448TB.....	127
Z4284EB2L.....	150	Z6060DMIM.....	276	Z24603R.....	140	Z60264WE.....	275	Z721836BU.....	281	ZH2454TB.....	127
Z4284EB2R.....	151	Z6060RMIH.....	278	Z24661TB.....	170	Z60288BE.....	271	Z722036BD.....	281	ZH2460TB.....	127
Z4284EB3L.....	150	Z6060RMIL.....	276	Z24663L.....	140	Z60288BW.....	274	ZA2036RL.....	128	ZH2466TB.....	127
Z4284EB3R.....	151	Z6060RMIM.....	277	Z24663R.....	140	Z60288RTE.....	273	ZA2036RR.....	128	ZH2472TB.....	127
Z4284EDFL.....	161	Z6072DMIH.....	270	Z24721TB.....	170	Z60288RTE.....	272	ZA2042RL.....	128	ZH2484TB.....	127
Z4284EDFR.....	161	Z6060WMIH.....	277	Z24723L.....	140	Z60288WE.....	275	ZA2042RR.....	128	ZH3042TB.....	127
Z4284EDML.....	162	Z6060WMIL.....	275	Z24723R.....	140	Z203616RL.....	138	ZA2048RL.....	128	ZH3048TB.....	127
Z4284EDMR.....	162	Z6060WMMIM.....	276	Z24781TB.....	170	Z203616RR.....	138	ZA2048RR.....	128	ZH3054TB.....	127
Z4284EDRL.....	161	Z6072DMIH.....	277	Z24841TB.....	170	Z204216RL.....	138	ZA2436RL.....	128	ZH3060F2S.....	126
Z4284EDRR.....	162	Z6072DMIL.....	275	Z24901TB.....	170	Z204216RR.....	138	ZA2436RR.....	128	ZH3060F3S.....	125
Z4284EDTL.....	161	Z6072DMIM.....	276	Z24961TB.....	170	Z204816RL.....	138	ZA2442RL.....	128	ZH3060F23.....	125
Z4284EDTR.....	161	Z6072RMIM.....	278	Z36165C.....	149	Z204816RR.....	138	ZA2442RR.....	128	ZH3060F32.....	125
Z4284EPFL.....	163	Z6072RMIL.....	276	Z36205C.....	149	Z205416RL.....	138	ZA2448RL.....	128	ZH3060F32.....	126

ZH3060FS3	126	ZK54RNDSC	439	ZTB6921	240
ZH3060NP	126	ZK54RNDSL	440	ZTB7016	238
ZH3060TB	127	ZK54WAVCC	438	ZTB7017	237
ZH3066F2S	126	ZK54WAVCL	439	ZTB7021	240
ZH3066F3S	125	ZK44848	434	ZTB8216	238
ZH3066F23	125	ZK44848P	434	ZTB8217	237
ZH3066F32	125	ZK45959	434	ZTB8221	240
ZH3066FS2	126	ZK45959P	434	ZVS14	228
ZH3066FS3	126	ZK65990	434	ZVS20	228
ZH3066NP	126	ZK65990P	434	ZVS21	228
ZH3066TB	127	ZK302529C	436	ZVS26	228
ZH3072F2S	126	ZK302529L	435	ZWHP2466	234
ZH3072F3S	125	ZK352129C	436	ZWHP24660	234
ZH3072F23	125	ZK352129L	435	ZWHP2472	234
ZH3072F32	125	ZK352132L	435	ZWHP24720	234
ZH3072F2S2	126	ZK412529C	436	ZWHP2484	235
ZH3072F3S2	126	ZK412529L	435	ZWHP24840	235
ZH3072NP	126	ZK412532L	435	ZWHP3066	234
ZH3072TB	127	ZK4484820	434	ZWHP30660	234
ZH3084F2S	126	ZK4595920	434	ZWHP3072	234
ZH3084F3S	125	ZK6599020	434	ZWHP30720	234
ZH3084F23	125	ZKFR3024	441	ZWHP3084	235
ZH3084F32	125	ZKFR6024	441	ZWHP30840	235
ZH3084FS2	126	ZKFTM30	441	ZWHP3666	234
ZH3084FS3	126	ZKFTM60	441	ZWHP36660	234
ZH3084TB	127	ZKR3020C	437	ZWHP3672	234
ZH3660F2S	126	ZKR3020L	436	ZWHP36720	234
ZH3660F3S	125	ZKR3024C	437	ZWHP3684	235
ZH3660F23	125	ZKR3024L	436	ZWHP36840	235
ZH3660F32	125	ZKR3620C	437	ZWHP4266	234
ZH3660FS2	126	ZKR3620L	436	ZWHP42660	234
ZH3660FS3	126	ZKR3624C	437	ZWHP4272	234
ZH3660NP	126	ZKR3624L	436	ZWHP42720	234
ZH3666F2S	126	ZKR4820C	437	ZWHP4284	235
ZH3666F3S	125	ZKR4820L	436	ZWHP42840	235
ZH3666F23	125	ZKR4824C	437	ZWHT2414	241
ZH3666F32	125	ZKR4824L	436	ZWHT2421	246
ZH3666FS2	126	ZKR5420C	437	ZWHT3014	241
ZH3666FS3	126	ZKR5420L	436	ZWHT3018	243
ZH3666NP	126	ZKR5424C	437	ZWHT3021	246
ZH3672F2S	126	ZKR5424L	436	ZWHT3025	248
ZH3672F3S	125	ZKR6020C	437	ZWHT3614	241
ZH3672F23	125	ZKR6020L	436	ZWHT3618	244
ZH3672F32	125	ZKR6024C	437	ZWHT3621	246
ZH3672FS2	126	ZKR6024L	436	ZWHT3625	248
ZH3672FS3	126	ZKR7220C	437	ZWHT4214	242
ZH3672NP	126	ZKR7220L	436	ZWHT4218	244
ZH3684F2S	126	ZKR7224C	437	ZWHT4221	246
ZH3684F3S	125	ZKR7224L	436	ZWHT4225	249
ZH3684F23	125	ZMPBBF19	168	ZWHT4814	242
ZH3684F32	125	ZMPBBF22	168	ZWHT4818	244
ZH3684FS2	126	ZMPBBF28	168	ZWHT4821	247
ZH3684FS3	126	ZMPBF19	169	ZWHT4825	249
ZH3684NP	126	ZMPBF22	168	ZWHT6014	242
ZH607224L	127	ZMPBF28	168	ZWHT6018	244
ZH607224R	127	ZMPFF19	168	ZWHT6021	247
ZH608424L	127	ZMPFF22	168	ZWHT6025	249
ZH608424R	127	ZMPFF28	168	ZWHT6614	242
ZHBC48	251	ZRDVS13	288	ZWHT6618	245
ZHBC65	250	ZTB2816	239	ZWHT6621	247
ZHBC72	250	ZTB2817	238	ZWHT6625	249
ZHPBF18	169	ZTB2821	241	ZWHT7214	243
ZHS36	227	ZTB3416	239	ZWHT7218	245
ZHS42	227	ZTB3417	238	ZWHT7221	247
ZHS48	227	ZTB3421	241	ZWHT7225	250
ZHS60	227	ZTB4016	239	ZWHT7814	243
ZHS66	227	ZTB4017	238	ZWHT7818	245
ZHS71	227	ZTB4021	240	ZWHT7821	248
ZHS72	227	ZTB4616	239	ZWHT7825	250
ZHS84	227	ZTB4617	238	ZWHT8414	243
ZHSHELF	251	ZTB4621	240	ZWHT8418	245
ZK54HEXCC	438	ZTB5816	239	ZWHT8421	248
ZK54HEXCL	439	ZTB5817	237	ZWHT8425	250
ZK54HEXSC	439	ZTB5821	240		
ZK54HEXSL	440	ZTB6416	239		
ZK54RECTC	439	ZTB6417	237		
ZK54RECTL	440, 441	ZTB6421	240		
ZK54RNDCC	438	ZTB6916	238		
ZK54RNDCL	439	ZTB6917	237		

Global offices in Canada

Head Office

560 Supertest Road
Toronto, Ontario
M3J 2M6
T (416) 650-6500

Toronto Sales Office

1350 Flint Road
Toronto, Ontario
M3J 2J7
T (416) 661-3660

Showrooms

Calgary

237 8 Avenue SE, Suite 302
Calgary, Alberta
T2G 5C3
T (403) 250-7770

The Blueprint Montreal

1010 Sainte-Catherine Street W, Mezz 2
Montreal, Quebec
H3B 1E7
T (514) 866-4331

Ottawa

251 Laurier Avenue West, Suite 400
Ottawa, Ontario
K1P 5J6
T (613) 234-2881
Please call ahead to book an appointment.

Edmonton

10158 103 Street NW, Suite 201
Edmonton, Alberta
T5J 0X6
T (780) 444-8922

Toronto

1350 Flint Road
Toronto, Ontario
M3J 2J7
T (416) 661-3660

Vancouver

675 West Hastings Street, Suite 1000
Vancouver, British Columbia
V6B 1N2
T (604) 432-1701

Halifax

1061 Marginal Road, Suite 120
Halifax, Nova Scotia
B3H 4P7
T (902) 422-7434

The Blueprint Toronto

(MetroCentre)
200 Wellington Street West, Suite 1602
Toronto, Ontario
M5V 3C7

Winnipeg

111 Lombard Avenue, Suite 220
Winnipeg, Manitoba
R3B 0T4
T (204) 925-3350

