

# desking - laminate



Adaptabilities

9



Genoa

48



Princeton

60



Zira

108

The following applies to all series **EXCEPT Princeton**. For information on the **Princeton** series, please refer to page 60.

- Outside and surface panels are made from 1" thick 45 lb. density particle board and covered on both sides with high performance thermally fused laminate. Modesty panels are  $\frac{1}{16}$ " thick.
- **FILE DRAWERS** use full extension steel ball bearing slides for smooth action.  
**BOX DRAWERS** use  $\frac{3}{4}$  extension steel ball bearing slides for a smooth action.
- **BOX AND FILE PEDESTALS** are standard and are constructed independently of the chassis, with fully closed bottoms. This picture frame construction technique prevents racking, and provides a product that lasts for years.
- **FILE DRAWERS** file legal and letter documents as standard (letter files will file in both directions, as will lateral files).
- Drawers and end panels are **EDGE BANDED** on all four sides to protect clothing and the floor covering.
- Locks are standard on all box and file pedestals, lateral files, storage cabinets and combination storage units.
- All locking components within each series can be keyed alike at no additional charge. Please specify the request at time of order.
- Standard key numbers are 401 through 440.
- Drawers are opened with side pulls and are constructed 22" deep (Genoa 18"D). Woodgrain enameled bottoms are routed into the woodgrain (MDF) sides on three edges.
- Pencil tray included with each desk.
- **LEVELING GLIDES** are standard on all units.
- All units are **shipped fully assembled** (except where noted) on 1" x 3" thick wood furniture skids with pedestal supports inside high quality cartons.
- **ALL "L" SHAPED DESKS** have flush backs on the return (modesty panels).
- Additional options available include (add suffix to item number):  
**FM** = full modesty panel. Available on any desk or credenza. **Add \$62.** (Standard on Adaptabilities & Zira.)  
**FP** = full modesty panel. Available on any desk or credenza. **Add \$62.** (Genoa only.)
- Desks with full to floor pedestals **cannot** have  $\frac{3}{4}$  modesty panels.
- Corners must have matching modesty panels (both sides must be either  $\frac{3}{4}$  or full modesty panels).
- **Modesty panels** on corners will be 1" above the floor. **Modesty panels** on returns are flush with the floor. It is recommended that corner units are used for corner spaces when configuring workstations so there is no visible difference if a corner is connected to a return.
- Optional grommets are available. **SEE EACH series** for details. **Add \$91.**
- Global will consider custom, specials and product alterations on an individual basis.
- Desk series can only be made in **standard Global laminates**.
- **PLEASE REFER TO SERIES FOR AVAILABLE FINISHES.** The following desk finishes are offered:

<b>WOODGRAINS:</b>	Absolute Acajou (ACJ) Asian Night (ASN) Avant Cherry (AWC) Avant Honey (AWH) Clear Maple (CMB) Dark Espresso (DES)	Fashionista (FAS) First Class (FCL) Noce Biondo (NBL) Noce Grigio (NGL) Noce Leggero (NEL) Noce Medio (NML)	Quartered Mahogany (QTM) Sheer Beauty (SBY) Walnut Heights (WHE) White Chocolate (WHC) Winter Cherry (WCR)
<b>SOLIDS:</b>	Black (BLK) Designer White (DWT)	Blizzard (BZD) Stonedust (SDT)	Custom Grey (CGY) Storm Grey (SOG)
<b>PATTERNS:</b>	Brushed Cobalt (BRC)		

- For additional options, see **Productivity Solutions** page 454.



With over 370 components available in 400 color combinations, Adaptabilities provides the ultimate in flexibility and modularity. Rich laminate colors coordinate easily with any office or home decor. All surfaces are constructed from Global's exclusive premium grade, high performance laminate and finished in preferred matching edges.

Adaptabilities features an extensive range of versatile components which can be configured into multi-user workstations suitable for intensive task functions, or for private executive suites requiring stately elegance and workforce functions. All laminate filing cabinets have a safety mechanism that prevents two drawers from being opened at the same time. File drawers have fully progressive ball bearing suspensions and accommodate letter or legal filing. For heavy duty usage, two, three and four drawer laminate files are available with steel drawer interiors.

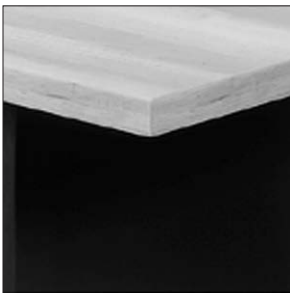

Tops are 1" thick with a top over side, edge panel design.



3/4 modesty panel is available at no extra charge.



For heavy duty usage, two, three and four drawer laminate files are available with steel drawer interiors.

#### Features and Benefits

- 45 lb. density particle board substructure with high performance thermally fused laminate.
- 1" thick worksurfaces in thermally fused or high pressure laminate.
- Worksurfaces feature 2mm edging in matching color.
- All desks are size (incrementally) accurate.
- 1 1/16" thick full modesty panel is standard.
- 1 1/16" thick 3/4 modesty panel is available on most components.
- Pencil tray included in the box drawer.
- File drawers accommodate letter or legal documents.
- Full progressive ball bearing suspension on file drawers.
- All drawer fronts edge banded with side pull opening pedestals and standard with pedestal locks.
- Compatible with **Divide** panel systems for increased privacy and storage requirements.

## GENERAL INFORMATION

- Constructed of 45 lb. density particle board with high performance thermally fused laminate.
- Adaptabilities components are compatible with Divide transaction tops and partitioning panels. See page 290 for Divide specifications and prices.
- See page 42 for keyboard drawers and additional accessory options.
- Adaptabilities desk and storage products have been tested and comply with all BIFMA mechanical tests.
- For environmental certification, please visit [globalfurnituregroup.com](http://globalfurnituregroup.com).

## WORKSURFACES

- 1" thick high performance thermally fused laminate tops sealed with Global's preferred edging in matching color. Woodgrain surfaces feature edging with matching printed woodgrain.
- High pressure tops are available in all Adaptabilities laminate finishes at an extended lead time. Please see model # for pricing and availability.

## EDGE DETAIL

- Two edge options



**A3** 1" top, standard flat edge



**AR** 1" top, bicut edge

## CONSTRUCTION

- Constructed of 45 lb. density particle board with high performance thermally fused laminate.
- Cabinets and wardrobes are 65" high to match overall height of a worksurface with hutch (worksurface 29" + hutch 36" = 65").
- 65" high end shelves are also available to match overall height.
- Models with monoposts are available with Black (**TBL**) or Tungsten (**TTU**) monoposts, please specify.
- Models with handles are available with Black (**HX**) or Silver (**HS**) handles, please specify.
- All drawer fronts edge banded with side pull opening pedestals and standard pedestal locks.
- Double wall pedestal housing with fully closed bottom.

## MODESTY PANELS

- $\frac{1}{16}$ " thick full modesty panel is standard.
- $\frac{1}{16}$ " thick  $\frac{3}{4}$  modesty panel available on most components.
- $\frac{3}{4}$  height modesty panels available on most models at no additional charge. Please specify (**34**). (Corners must have both modesty panels as  $\frac{3}{4}$  or full.)
- **Note:** Woodgrain modesty panels over 60" wide will have the grain pattern in a horizontal direction. All end panels and modesty panels 60" or less will have the grain pattern in a vertical direction.

## STORAGE

- Storage top is optional with worksurface edge option (**A3**) or (**AR**).
- All lateral file drawer fronts feature the woodgrain running in a horizontal direction.
- Pencil tray included in box drawer.
- File drawers can accommodate letter or legal documents.
- Triple progressive ball bearing suspension on file drawers.

## LOCKS

- Optional locks available for all straight hutch unit doors. **Add \$119** each lock.
- Front-to-back filing bars for all steel drawer files available separately. Order FBB file bars. See page 42 for pricing.
- Locks are Black with Black (**HX**) and Silver (**HS**) handles.

## SPECIAL SIZES

- Special widths are available on most products with open knee space and/or units with open or hinged door storage configurations. To price, take the list price of the next larger standard size up and add **10%**. Quotations are not required, some exceptions may apply.
- For custom widths outside of the range of standard sizes published or any custom depths, submit a SPECIALS / MTM quote request through the Global Dealer Center.
- Orders must indicate the custom quote number and list price.
- Changes to custom quotes are not permitted. Any revisions will necessitate a new quotation.
- Adaptabilities boardroom table tops are now available with bicut edge at no upcharge. Please specify (**CR**).

## HUTCHES

- 71" hutches are for use when a hutch is placed across the back of a 42" wide return and across the depth of a 29.63" (30") deep surface top.

## SPECIFICATIONS

- Specifications marked with an \* are applicable to only those products which have the \* symbol beside the product name.

## 1. SPECIFY MODEL NUMBER

## 2. SPECIFY FINISH

### One Tone Finishes:

<b>ACJ</b>	Absolute Acajou
<b>ASN</b>	Asian Night
<b>AWC</b>	Avant Cherry
<b>AWH</b>	Avant Honey
<b>BLK</b>	Black
<b>BZD</b>	Blizzard
<b>BRC</b>	Brushed Cobalt
<b>CMB</b>	Clear Maple
<b>CGY</b>	Custom Grey
<b>DES</b>	Dark Espresso
<b>DWT</b>	Designer White
<b>FAS</b>	Fashionista
<b>FCL</b>	First Class
<b>NBL</b>	Noce Biondo
<b>NGL</b>	Noce Grigio
<b>NEL</b>	Noce Leggero
<b>NML</b>	Noce Medio
<b>QTM</b>	Quartered Mahogany
<b>SBY</b>	Sheer Beauty
<b>SDT</b>	Stonedust
<b>SOG</b>	Storm Grey
<b>WHE</b>	Walnut Heights
<b>WHC</b>	White Chocolate
<b>WCR</b>	Winter Cherry

### Top Finishes:

<b>ACJ</b>	Absolute Acajou
<b>ASN</b>	Asian Night
<b>AWC</b>	Avant Cherry
<b>AWH</b>	Avant Honey
<b>BLK</b>	Black
<b>BZD</b>	Blizzard
<b>BRC</b>	Brushed Cobalt
<b>CMB</b>	Clear Maple
<b>CGY</b>	Custom Grey
<b>DES</b>	Dark Espresso
<b>DWT</b>	Designer White
<b>FAS</b>	Fashionista
<b>FCL</b>	First Class
<b>NBL</b>	Noce Biondo
<b>NGL</b>	Noce Grigio
<b>NEL</b>	Noce Leggero
<b>NML</b>	Noce Medio
<b>QTM</b>	Quartered Mahogany
<b>SBY</b>	Sheer Beauty
<b>SDT</b>	Stonedust
<b>SOG</b>	Storm Grey
<b>WHE</b>	Walnut Heights
<b>WHC</b>	White Chocolate
<b>WCR</b>	Winter Cherry

### Body Finishes (including pedestals):

<b>ACJ</b>	Absolute Acajou
<b>ASN</b>	Asian Night
<b>AWC</b>	Avant Cherry
<b>AWH</b>	Avant Honey
<b>BLK</b>	Black
<b>BZD</b>	Blizzard
<b>BRC</b>	Brushed Cobalt
<b>CMB</b>	Clear Maple
<b>CGY</b>	Custom Grey
<b>DES</b>	Dark Espresso
<b>DWT</b>	Designer White
<b>FAS</b>	Fashionista
<b>FCL</b>	First Class
<b>NBL</b>	Noce Biondo
<b>NGL</b>	Noce Grigio
<b>NEL</b>	Noce Leggero
<b>NML</b>	Noce Medio
<b>QTM</b>	Quartered Mahogany
<b>SBY</b>	Sheer Beauty
<b>SDT</b>	Stonedust
<b>SOG</b>	Storm Grey
<b>WHE</b>	Walnut Heights
<b>WHC</b>	White Chocolate
<b>WCR</b>	Winter Cherry

## 3. SPECIFY OPTIONS

### GROMMETS

- Additional grommets available in standard worksurface locations (left, center or right).
- Order as: **FOG1, FOG2 or FOG3. Add \$91.**



- Grommet hole dimensions are 3.25" wide x 1.875" deep.
- Actual grommet locations on the worksurface are depicted in the example drawings shown below. Dimensions shown are actual measurements (in inches).

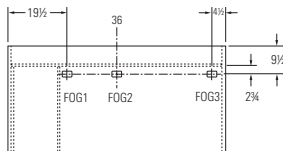

36 x 72 single pedestal left desks (A3672SPL)

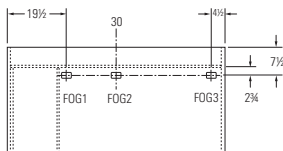

30 x 60 single pedestal left desks (A3060SPL)

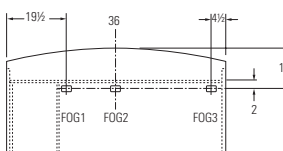

36 x 72 single pedestal left bow top desks (A3672SLB)

- Grommets may be placed at non-standard locations. Order **CSG. Add \$132.** A drawing must be supplied with vertical and horizontal dimensions to the center of the cut-out (as in drawings on the left). Please refer to the **custom grommet location** form in the back reference section.
- Components that come standard with a grommet may be ordered without a grommet order **RSG. Add \$51.**
- Grommets are available on modesty panels of extended corners and 5-sided corners 6.5" in where the two modesty panels meet at a 90° angle. Please specify **FOGMPR** for right grommet placement and **FOGMPL** for left grommet placement (as shown on diagrams below). Cost is **\$132.**
- Modesty panels are 1" off of ground.

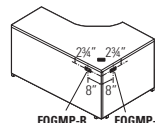

Left extended corner unit

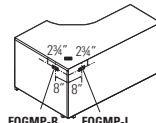

Right extended corner unit

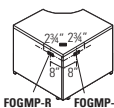

5-sided corner unit

### POWER BLOCK

- A power block (model **PMSPDM**) may be ordered on all worksurfaces.
- A power block is a rectangular worksurface power/data module with one electrical duplex receptacle and includes two data (RJ45) receptacles. 9 foot Black cord included. Power block dimensions are 6.5"W x 3.5"D x 2.75"H.
- To purchase a power block, you must specify both the power block cut-out location and the power block model #. Order power block as **PMSPDM. Add \$268.**
- Power blocks are available in standard worksurface locations (left, center or right). Order as **E1, E2 or E3. Add \$91.**

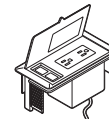

Power block **PMSPDM. Add \$268.**

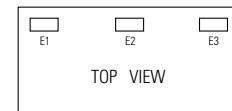

Specify location **E1, E2 or E3. Add \$91.**

# A ADAPTABILITIES®

## DOUBLE PEDESTAL DESKS

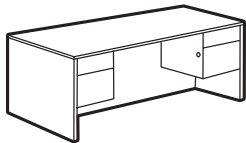

**Double Pedestal Desk\***

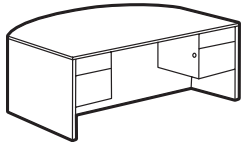

**Double Pedestal Bow Top Desk\***

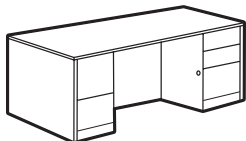

**Full to Floor Double Pedestal Desk**

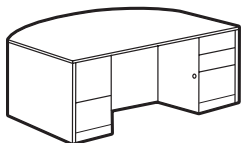

**Full to Floor Double Pedestal Bow Top Desk**

MODEL #	DIMENSIONS	WT/LB.	CUBIC FT.	LIST PRICE	HP ADD
<b>W x D x H</b>					
A3672DP	72 x 36 x 29.6	296	52.5	<b>\$1662</b>	<b>\$471</b>
A3072DP	72 x 29.69 x 29.6	263	43	<b>\$1775</b>	<b>\$440</b>
A3066DP	66 x 29.69 x 29.6	254	39.75	<b>\$1656</b>	<b>\$404</b>
A3060DP	60 x 29.69 x 29.6	247	36.25	<b>\$1504</b>	<b>\$404</b>

Standard with box/file pedestals on both sides. Pedestals lock. One pencil tray. Shipped assembled in 1 carton.

A3672DPB	72 x 30-36 x 29.6	280	52.5	<b>\$1963</b>	<b>\$471</b>
----------	-------------------	-----	------	---------------	--------------

Standard with box/file pedestals on both sides and bow top. Pedestals lock. One pencil tray. Shipped assembled in 1 carton.

A3672D4	72 x 36 x 29.6	330	52.5	<b>\$2244</b>	<b>\$471</b>
A3072D4	72 x 30 x 29.6	295	43.75	<b>\$2244</b>	<b>\$471</b>
A3066D4	66 x 29.69 x 29.6	285	39.75	<b>\$2150</b>	<b>\$404</b>
A3060D4	60 x 29.69 x 29.6	276	36.25	<b>\$1886</b>	<b>\$404</b>

Standard with full to floor box/box/file on right pedestal and file/file on left pedestal. Pedestals lock. On box/box/file pedestal, lower box drawer and file drawer lock. One pencil tray. Shipped assembled in 1 carton.

A3672DB4	72 x 32-36 x 29.6	311	52.5	<b>\$2473</b>	<b>\$471</b>
----------	-------------------	-----	------	---------------	--------------

Standard with full to floor box/box/file on right pedestal and file/file on left pedestal. Bow top. Pedestals lock. On box/box/file pedestal, lower box drawer and file drawer lock. One pencil tray. Shipped assembled in 1 carton.

## SINGLE PEDESTAL DESKS

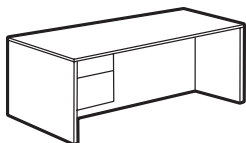

**Single Pedestal Desk - LEFT\***

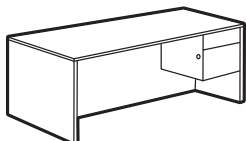

**Single Pedestal Desk - RIGHT\***

A3672SPL	72 x 36 x 29.6	245	52.5	<b>\$1418</b>	<b>\$471</b>
A3072SPL	72 x 29.69 x 29.6	216	43	<b>\$1378</b>	<b>\$440</b>
A3066SPL	66 x 29.69 x 29.6	207	39.75	<b>\$1311</b>	<b>\$404</b>
A3060SPL	60 x 29.69 x 29.6	197	36.25	<b>\$1227</b>	<b>\$404</b>
A3048SPL	48 x 29.69 x 29.6	177	29.25	<b>\$1138</b>	<b>\$345</b>
A2448SPL	48 x 24 x 29.6	150	24.25	<b>\$1138</b>	<b>\$239</b>

Standard with box/file pedestal on **left**. Pedestal locks. One pencil tray. Shipped assembled in 1 carton.

A3672SPR	72 x 36 x 29.6	245	52.5	<b>\$1418</b>	<b>\$471</b>
A3072SPR	72 x 29.69 x 29.6	216	43	<b>\$1378</b>	<b>\$440</b>
A3066SPR	66 x 29.69 x 29.6	207	39.75	<b>\$1311</b>	<b>\$404</b>
A3060SPR	60 x 29.69 x 29.6	197	36.25	<b>\$1227</b>	<b>\$404</b>
A3048SPR	48 x 29.69 x 29.6	177	29.25	<b>\$1138</b>	<b>\$345</b>
A2448SPR	48 x 24 x 29.6	150	24.25	<b>\$1138</b>	<b>\$239</b>

Standard with box/file pedestal on **right**. Pedestal locks. One pencil tray. Shipped assembled in 1 carton.

### Required specifications

Top finish  
Base finish  
Edge detail

### Optional specifications

Key #  
Grommet position or power block cut-out  
HP laminate  
¾ modesty panel\*

### Accessories

Power block  
Keyboard tray  
Pencil tray

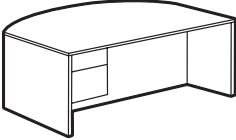
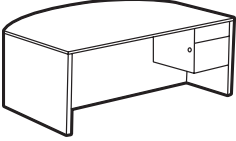
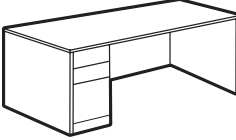
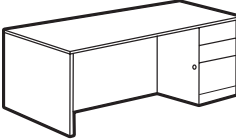
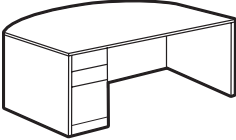
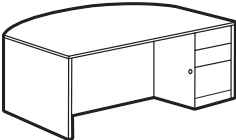
SINGLE PEDESTAL DESKS	MODEL #	DIMENSIONS W x D x H	WT/LB.	CUBIC FT.	LIST PRICE	HP ADD
	A3672SLB	72 x 30-36 x 29.6	233	52.5	<b>\$1572</b>	<b>\$471</b>
<b>Single Pedestal Bow Top Desk - LEFT*</b>	Standard with box/file pedestal on the <b>left</b> and bow top. Pedestal locks. One pencil tray. Shipped assembled in 1 carton.					
	A3672SRB	72 x 30-36 x 29.6	233	52.5	<b>\$1572</b>	<b>\$471</b>
<b>Single Pedestal Bow Top Desk - RIGHT*</b>	Standard with box/file pedestal on the <b>right</b> and bow top. Pedestal locks. One pencil tray. Shipped assembled in 1 carton.					
	A3672S4L	72 x 36 x 29.6	261	52.5	<b>\$1606</b>	<b>\$471</b>
	A3072S4L	72 x 29.69 x 29.6	232	43.75	<b>\$1606</b>	<b>\$471</b>
	A3066S4L	66 x 29.69 x 29.6	221	39.5	<b>\$1484</b>	<b>\$404</b>
	A3060S4L	60 x 29.69 x 29.6	211	36.25	<b>\$1419</b>	<b>\$404</b>
	A3048S4L	48 x 29.69 x 29.6	191	29.5	<b>\$1340</b>	<b>\$345</b>
	A2448S4L	48 x 24 x 29.6	164	24.25	<b>\$1340</b>	<b>\$239</b>
<b>Full to Floor Single Pedestal Desk - LEFT</b>	Standard with full to floor box/box/file pedestal on the <b>left</b> . Lower box drawer and file drawer lock. One pencil tray. Shipped assembled in 1 carton.					
	A3672S4R	72 x 36 x 29.6	261	52.5	<b>\$1606</b>	<b>\$471</b>
	A3072S4R	72 x 29.69 x 29.6	232	43.75	<b>\$1606</b>	<b>\$471</b>
	A3066S4R	66 x 29.69 x 29.6	221	39.75	<b>\$1484</b>	<b>\$404</b>
	A3060S4R	60 x 29.69 x 29.6	211	36.25	<b>\$1419</b>	<b>\$404</b>
	A3048S4R	48 x 29.69 x 29.6	191	29.5	<b>\$1340</b>	<b>\$345</b>
	A2448S4R	48 x 24 x 29.6	164	24.25	<b>\$1340</b>	<b>\$239</b>
<b>Full to Floor Single Pedestal Desk - RIGHT</b>	Standard with full to floor box/box/file pedestal on the <b>right</b> . Lower box drawer and file drawer lock. One pencil tray. Shipped assembled in 1 carton.					
	A3672S4LB	72 x 32-36 x 29.6	247	52.5	<b>\$1835</b>	<b>\$471</b>
<b>Full to Floor Single Pedestal Bow Top Desk - LEFT</b>	Standard with box/box/file pedestal on the <b>left</b> and bow top. Lower box drawer and file drawer lock. One pencil tray. Shipped assembled in 1 carton.					
	A3672S4RB	72 x 32-36 x 29.6	247	52.5	<b>\$1835</b>	<b>\$471</b>
<b>Full to Floor Single Pedestal Bow Top Desk - RIGHT</b>	Standard with box/box/file pedestal on the <b>right</b> and bow top. Lower box drawer and file drawer lock. One pencil tray. Shipped assembled in 1 carton.					

**Required specifications**

Top finish  
Base finish  
Edge detail

**Optional specifications**

Key #  
Grommet position or power block cut-out  
HP laminate  
¾ modesty panel\*

**Accessories**

Power block  
Keyboard tray  
Pencil tray

# A ADAPTABILITIES®

## RETURNS

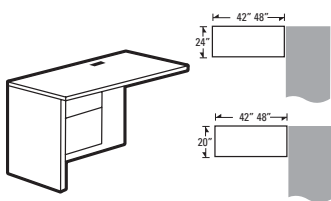

**Flush Return - LEFT\***

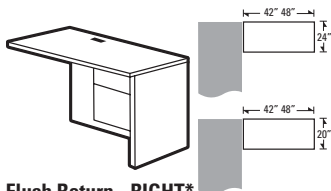

**Flush Return - RIGHT\***

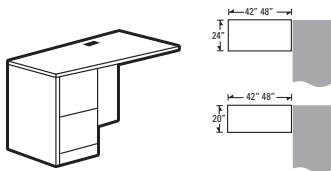

**Full to Floor Flush Return - LEFT\***

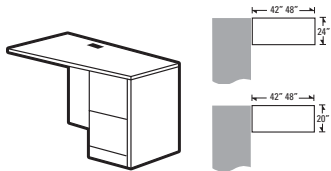

**Full to Floor Flush Return - RIGHT\***

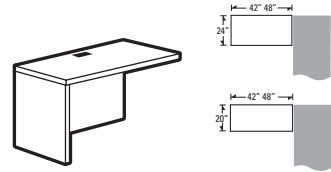

**Flush Return - LEFT**

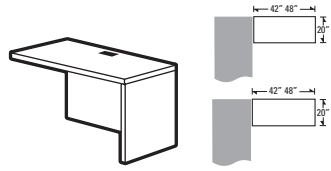

**Flush Return - RIGHT**

MODEL #	DIMENSIONS W x D x H	WT/LB.	CUBIC FT.	LIST PRICE	HP ADD
A2448FL	48 x 24 x 29.6	141	24	<b>\$1013</b>	<b>\$239</b>
A2442FL	42 x 24 x 29.6	131	21.25	<b>\$1013</b>	<b>\$202</b>
A2048FL	48 x 20 x 29.6	128	20.25	<b>\$957</b>	<b>\$202</b>
A2042FL	42 x 20 x 29.6	119	18	<b>\$957</b>	<b>\$202</b>

Standard with box/file drawer pedestal on the **left**. One pencil tray. Pedestal locks. Grommet in worksurface. Shipped assembled in 1 carton.

A2448FR	48 x 24 x 29.6	141	24	<b>\$1013</b>	<b>\$239</b>
A2442FR	42 x 24 x 29.6	131	21.25	<b>\$1013</b>	<b>\$202</b>
A2048FR	48 x 20 x 29.6	128	20.25	<b>\$957</b>	<b>\$202</b>
A2042FR	42 x 20 x 29.6	119	18	<b>\$957</b>	<b>\$202</b>

Standard with box/file drawer pedestal on the **right**. One pencil tray. Pedestal locks. Grommet in worksurface. Shipped assembled in 1 carton.

A2448L4	48 x 24 x 29.6	156	24.25	<b>\$1279</b>	<b>\$239</b>
A2442L4	42 x 24 x 29.6	146	21.5	<b>\$1279</b>	<b>\$202</b>
A2048L4	48 x 20 x 29.6	142	20.5	<b>\$1202</b>	<b>\$202</b>
A2042L4	42 x 20 x 29.6	133	18	<b>\$1202</b>	<b>\$202</b>

Standard with file/file drawer pedestal on the **left**. One pencil tray. Pedestal locks. Grommet in worksurface. Shipped assembled in 1 carton.

A2448R4	48 x 24 x 29.6	156	24.25	<b>\$1279</b>	<b>\$239</b>
A2442R4	42 x 24 x 29.6	146	21.5	<b>\$1279</b>	<b>\$202</b>
A2048R4	48 x 20 x 29.6	142	20.5	<b>\$1202</b>	<b>\$202</b>
A2042R4	42 x 20 x 29.6	133	18	<b>\$1202</b>	<b>\$202</b>

Standard with file/file drawer pedestal on the **right**. One pencil tray. Pedestal locks. Grommet in worksurface. Shipped assembled in 1 carton.

A2448EL	48 x 24 x 29.6	92	4.3	<b>\$710</b>	<b>\$239</b>
A2442EL	42 x 24 x 29.6	82	3.8	<b>\$710</b>	<b>\$202</b>
A2048EL	48 x 20 x 29.6	84	4.3	<b>\$655</b>	<b>\$202</b>
A2042EL	42 x 20 x 29.6	75	3.8	<b>\$655</b>	<b>\$202</b>

Return has no pedestal. Grommet in worksurface. Shipped easy to assemble in 1 carton.

A2448ER	48 x 24 x 29.6	92	4.3	<b>\$710</b>	<b>\$239</b>
A2442ER	42 x 24 x 29.6	82	3.8	<b>\$710</b>	<b>\$202</b>
A2048ER	48 x 20 x 29.6	84	4.3	<b>\$655</b>	<b>\$202</b>
A2042ER	42 x 20 x 29.6	75	3.8	<b>\$655</b>	<b>\$202</b>

Return has no pedestal. Grommet in worksurface. Shipped easy to assemble in 1 carton.

### Required specifications

Top finish  
Base finish  
Edge detail

### Optional specifications

Key #\*  
Grommet position or power block cut-out  
HP laminate

### Accessories

Power block  
Keyboard tray  
Pencil tray



**SPACE SAVER RETURNS**      **MODEL #**      **DIMENSIONS**      **WT/LB.**      **CUBIC FT.**      **LIST PRICE**      **HP ADD**

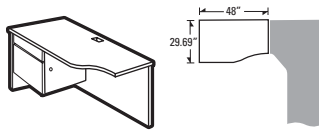

**Space Saver Return - LEFT**

W x D x H						
A3048FSL	48 x 29.69 x 29.6	148	29	<b>\$1095</b>	<b>\$283</b>	

Standard with box/file pedestal on the **left**, grommet in worksurface. One pencil tray. Pedestal locks. Connects to 24"D 5-sided corner unit and 2466/2472 NFL or NNL extended corner unit. Shipped assembled in 1 carton.

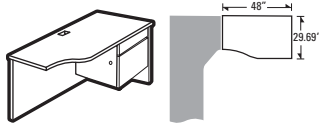

**Space Saver Return - RIGHT**

A3048FSR	48 x 29.69 x 29.6	148	29	<b>\$1095</b>	<b>\$283</b>	
----------	-------------------	-----	----	---------------	--------------	--

Standard with box/file pedestal on the **right**, grommet in worksurface. One pencil tray. Pedestal locks. Connects to 24"D 5-sided corner unit and 2466/2472 FNR or NNR extended corner unit. Shipped assembled in 1 carton.

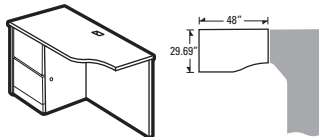

**Space Saver Return - LEFT**

A3048P4L	48 x 29.69 x 29.6	170	29	<b>\$1407</b>	<b>\$345</b>	
----------	-------------------	-----	----	---------------	--------------	--

Standard with file/file pedestal on the **left**, grommet in worksurface. One pencil tray. Pedestal locks. Connects to 24"D 5-sided corner unit and 2466/2472 NFL or NNL extended corner unit. Shipped assembled in 1 carton.

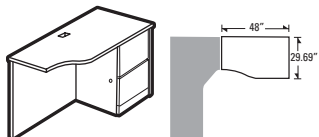

**Space Saver Return - RIGHT**

A3048P4R	48 x 29.69 x 29.6	170	29	<b>\$1407</b>	<b>\$345</b>	
----------	-------------------	-----	----	---------------	--------------	--

Standard with file/file pedestal on the **right**, grommet in worksurface. One pencil tray. Pedestal locks. Connects to 24"D 5-sided corner unit and 2466/2472 FNR or NNR extended corner unit. Shipped assembled in 1 carton.

**FLUSH BRIDGES**

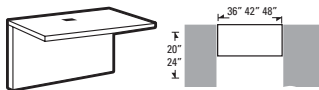

**Flush Bridge\***

A2448FB	48 x 24 x 29.6	75	4.3	<b>\$629</b>	<b>\$239</b>	
A2442FB	42 x 24 x 29.6	65	3.8	<b>\$629</b>	<b>\$202</b>	
A2436FB	36 x 24 x 29.6	58	3.3	<b>\$586</b>	<b>\$152</b>	
A2048FB	48 x 20 x 29.6	71	4.3	<b>\$484</b>	<b>\$202</b>	
A2042FB	42 x 20 x 29.6	65	3.8	<b>\$460</b>	<b>\$202</b>	
A2036FB	36 x 20 x 29.6	54	3.3	<b>\$434</b>	<b>\$152</b>	

Top surface, back panel and hardware to connect two units. Grommet in worksurface. Shipped easy to assemble in 1 carton.

**CREDENZAS**



**Center Storage Credenza\*\***

A2072C	72 x 20 x 29.6	243	30	<b>\$1811</b>	<b>\$314</b>	
--------	----------------	-----	----	---------------	--------------	--

Standard with box/file pedestals on both sides and self-closing, hinged, center doors covering one adjustable shelf. Pedestals and doors lock. One pencil tray. Shipped assembled in 1 carton.

**Required specifications**

Top finish  
Base finish  
Handles\*\*  
Edge detail

**Optional specifications**

Key #  
Additional grommet position (not A2072C)  
HP laminate  
Power block cut-out (not A2072C)

**Accessories**

Power block  
Keyboard tray\*  
Pencil tray\*

# A ADAPTABILITIES®

CREDENZAS	MODEL #	DIMENSIONS	WT/LB.	CUBIC FT.	LIST PRICE	HP ADD
-----------	---------	------------	--------	-----------	------------	--------

W x D x H

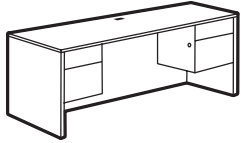

**Kneespace Credenza**

A2472CK	72 x 24 x 29.6	234	35.75	<b>\$1750</b>	<b>\$325</b>
A2466CK	66 x 24 x 29.6	225	32.75	<b>\$1750</b>	<b>\$300</b>
A2072CK	72 x 20 x 29.6	212	30.25	<b>\$1498</b>	<b>\$314</b>
A2066CK	66 x 20 x 29.6	204	27.75	<b>\$1498</b>	<b>\$300</b>
A2060CK	60 x 20 x 29.6	199	25.25	<b>\$1469</b>	<b>\$276</b>

Standard with box/file pedestals on both sides. Center is open. Pedestals lock. One pencil tray. Grommet in worksurface. Shipped assembled in 1 carton.

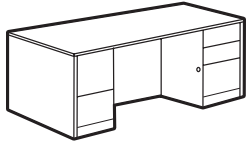

**Full to Floor Kneespace Credenza**

A2472D4	72 x 24 x 29.6	261	35.5	<b>\$2438</b>	<b>\$325</b>
A2466D4	66 x 24 x 29.6	252	33	<b>\$2438</b>	<b>\$300</b>
A2072D4	72 x 20 x 29.6	236	30	<b>\$2080</b>	<b>\$314</b>
A2066D4	66 x 20 x 29.6	228	27.75	<b>\$2080</b>	<b>\$300</b>
A2060D4	60 x 20 x 29.6	220	25.25	<b>\$2018</b>	<b>\$276</b>

Standard with full to floor box/box/file on right pedestal and file/file on left pedestal. Pedestal locks on box/box/file pedestal, lower box drawer and file drawer lock. One pencil tray. Shipped assembled in 1 carton.

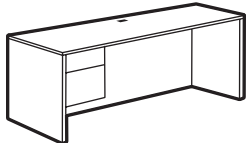

**Single Pedestal Credenza - LEFT**

A2472CSL	72 x 24 x 29.6	190	35.75	<b>\$1407</b>	<b>\$325</b>
A2466CSL	66 x 24 x 29.6	181	32.75	<b>\$1407</b>	<b>\$300</b>
A2072CSL	72 x 20 x 29.6	172	30.25	<b>\$1194</b>	<b>\$314</b>
A2066CSL	66 x 20 x 29.6	163	27.75	<b>\$1194</b>	<b>\$300</b>
A2060CSL	60 x 20 x 29.6	155	25.25	<b>\$1130</b>	<b>\$276</b>

Standard with box/file pedestal on the **left**. Pedestal locks. One pencil tray. Grommet in worksurface. Shipped assembled in 1 carton.

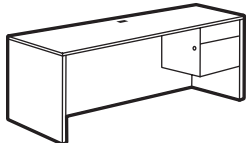

**Single Pedestal Credenza - RIGHT**

A2472CSR	72 x 24 x 29.6	190	35.75	<b>\$1407</b>	<b>\$325</b>
A2466CSR	66 x 24 x 29.6	181	32.75	<b>\$1407</b>	<b>\$300</b>
A2072CSR	72 x 20 x 29.6	171	30.25	<b>\$1194</b>	<b>\$314</b>
A2066CSR	66 x 20 x 29.6	163	27.75	<b>\$1194</b>	<b>\$300</b>
A2060CSR	60 x 20 x 29.6	155	25.25	<b>\$1130</b>	<b>\$276</b>

Standard with box/file pedestal on the **right**. Pedestal locks. One pencil tray. Grommet in worksurface. Shipped assembled in 1 carton.

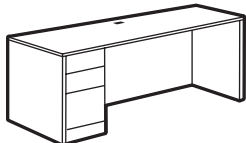

**Full to Floor Single Pedestal Credenza - LEFT**

A2472S4L	72 x 24 x 29.6	205	35.5	<b>\$1629</b>	<b>\$314</b>
A2466S4L	66 x 24 x 29.6	196	33	<b>\$1629</b>	<b>\$300</b>
A2072S4L	72 x 20 x 29.6	187	30	<b>\$1373</b>	<b>\$314</b>
A2066S4L	66 x 20 x 29.6	177	27.75	<b>\$1373</b>	<b>\$314</b>
A2060S4L	60 x 20 x 29.6	168	25.25	<b>\$1300</b>	<b>\$276</b>

Standard with full to floor box/box/file pedestal on the **left**. Lower box drawer and file drawer lock. Grommet in worksurface. One pencil tray. Shipped assembled in 1 carton.

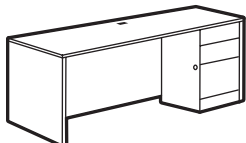

**Full to Floor Single Pedestal Credenza - RIGHT**

A2472S4R	72 x 24 x 29.6	205	35.5	<b>\$1629</b>	<b>\$314</b>
A2466S4R	66 x 24 x 29.6	196	33	<b>\$1629</b>	<b>\$300</b>
A2072S4R	72 x 20 x 29.6	187	30	<b>\$1373</b>	<b>\$314</b>
A2066S4R	66 x 20 x 29.6	177	27.75	<b>\$1373</b>	<b>\$314</b>
A2060S4R	60 x 20 x 29.6	168	25.25	<b>\$1300</b>	<b>\$276</b>

Standard with full to floor box/box/file pedestal on the **right**. Lower box drawer and file drawer lock. Grommet in worksurface. One pencil tray. Shipped assembled in 1 carton.

**Required specifications**

Top finish  
Base finish  
Edge detail

**Optional specifications**

Key #  
Grommet position or power block cut-out  
HP laminate

**Accessories**

Power block  
Keyboard tray  
Pencil tray

CREDENZAS	MODEL #	DIMENSIONS	WT/LB.	CUBIC FT.	LIST PRICE	HP ADD
-----------	---------	------------	--------	-----------	------------	--------

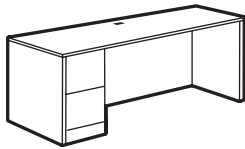

**Full to Floor Single Pedestal Credenza - LEFT\***

	W x D x H					
A2472S2L	72 x 24 x 29.6	205	35.5	<b>\$1483</b>	<b>\$314</b>	
A2466S2L	66 x 24 x 29.6	196	32.75	<b>\$1483</b>	<b>\$300</b>	
A2072S2L	72 x 20 x 29.6	187	30.25	<b>\$1401</b>	<b>\$314</b>	
A2066S2L	66 x 20 x 29.6	177	27.75	<b>\$1401</b>	<b>\$314</b>	
A2060S2L	60 x 20 x 29.6	168	25.25	<b>\$1341</b>	<b>\$276</b>	

Standard with full to floor file/file pedestal on the **left**. Pedestal Locks. Grommet in worksurface. Shipped assembled in 1 carton.

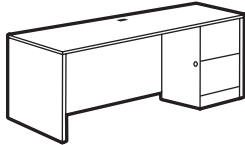

**Full to Floor Single Pedestal Credenza - RIGHT\***

A2472S2R	72 x 24 x 29.6	205	35.5	<b>\$1483</b>	<b>\$314</b>	
A2466S2R	66 x 24 x 29.6	196	32.75	<b>\$1483</b>	<b>\$300</b>	
A2072S2R	72 x 20 x 29.6	187	30.25	<b>\$1401</b>	<b>\$314</b>	
A2066S2R	66 x 20 x 29.6	177	27.75	<b>\$1401</b>	<b>\$314</b>	
A2060S2R	60 x 20 x 29.6	168	25.25	<b>\$1341</b>	<b>\$276</b>	

Standard with full to floor file/file pedestal on the **right**. Pedestal locks. Grommet in worksurface. Shipped assembled in 1 carton.

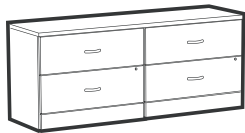

**Lateral File Credenza**

A2472LF2	72 x 24 x 29.6	322	35.75	<b>\$2703</b>	<b>\$314</b>	
A2072LF2	72 x 20 x 29.6	296	30.25	<b>\$2647</b>	<b>\$314</b>	

Two 2-drawer lateral files side-by-side. Locking drawers, keyed alike. File bars included for side-to-side and front-to-back letter/legal filing capability. Anti-lock tilt suspension. Shipped assembled in 1 carton.

- MUST specify Black (**HX**) or Silver (**HS**) finish for handles.
- File drawer construction is for accommodating hanging files NOT for stacking materials on the drawer bottom.

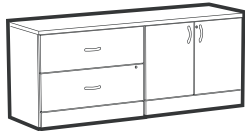

**Lateral File/Storage Cabinet Credenza**

A2472LS	72 x 24 x 29.6	297	35.75	<b>\$2421</b>	<b>\$314</b>	
A2072LS	72 x 20 x 29.6	267	30.25	<b>\$2364</b>	<b>\$314</b>	

One 2-drawer lateral file on the **left** and one storage cabinet on the **right**. Locking doors/drawers, keyed alike. Storage cabinet includes one adjustable shelf. File bars included for side-to-side and front-to-back letter/legal filing capability. Anti-lock tilt suspension. Shipped assembled in 1 carton.

- MUST specify Black (**HX**) or Silver (**HS**) finish for handles.
- File drawer construction is for accommodating hanging files NOT for stacking materials on the drawer bottom.



**Kneespace Lateral File Credenza - LEFT\***

A2472LKL	72 x 24 x 29.6	239	35.75	<b>\$2126</b>	<b>\$314</b>	
A2072LKL	72 x 20 x 29.6	216	30.25	<b>\$2071</b>	<b>\$314</b>	

One 2-drawer lateral file on the **left**. Locking drawers. File bars included for side-to-side and front-to-back letter/legal filing capability. Anti-lock tilt suspension. Grommet in worksurface. Shipped assembled in 1 carton.

- MUST specify Black (**HX**) or Silver (**HS**) finish for handles.
- File drawer construction is for accommodating hanging files NOT for stacking materials on the drawer bottom.

**Required specifications**

Top finish  
Base finish  
Handles (not A2xxxS2L/A2xxxS2R)  
Edge detail

**Optional specifications**

Key #  
Additional grommet  
HP laminate  
Power block cut-out\*

**Accessories**

Power block\*  
Keyboard tray\*  
Pencil tray\*

# A ADAPTABILITIES®

## CREDENZAS



**Kneespace Lateral File Credenza - RIGHT**

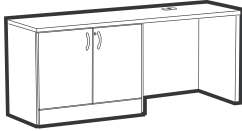

**Kneespace Storage Cabinet Credenza - LEFT**

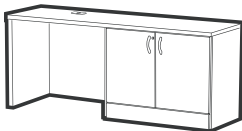

**Kneespace Storage Cabinet Credenza - RIGHT**

MODEL #	DIMENSIONS W x D x H	WT/LB.	CUBIC FT.	LIST PRICE	HP ADD
A2472LKR	72 x 24 x 29.6	239	35.75	<b>\$2126</b>	<b>\$314</b>
A2072LKR	72 x 20 x 29.6	216	30.25	<b>\$2071</b>	<b>\$314</b>

One 2-drawer lateral file on the **right**. Locking drawers. File bars included for side-to-side and front-to-back letter/legal filing capability. Anti-lock tilt suspension. Grommet in worksurface. Shipped assembled in 1 carton.

- MUST specify Black (**HX**) or Silver (**HS**) finish for handles.
- File drawer construction is for accommodating hanging files **NOT** for stacking materials on the drawer bottom.

A2472SKL	72 x 24 x 29.6	218	35.75	<b>\$1674</b>	<b>\$314</b>
A2072SKL	72 x 20 x 29.6	188	30.25	<b>\$1618</b>	<b>\$314</b>

One storage cabinet on the **left**. Locking doors. Storage cabinet has one adjustable shelf. Grommet in worksurface. Shipped assembled in 1 carton.

- MUST specify Black (**HX**) or Silver (**HS**) finish for handles.

A2472SKR	72 x 24 x 29.6	218	35.75	<b>\$1674</b>	<b>\$314</b>
A2072SKR	72 x 20 x 29.6	188	30.25	<b>\$1618</b>	<b>\$314</b>

One storage cabinet on the **right**. Locking doors. Storage cabinet has one adjustable shelf. Grommet in worksurface. Shipped assembled in 1 carton.

- MUST specify Black (**HX**) or Silver (**HS**) finish for handles.

## 5-SIDED CORNERS

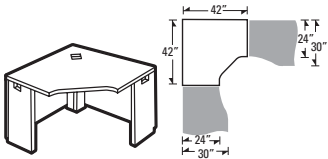

**5-Sided Corner\***

A42245C	42 x 42 x 29.6	113	5.75	<b>\$1044</b>	<b>\$440</b>
---------	----------------	-----	------	---------------	--------------

Connects to **30" D** space saver connectable surfaces, **24" D** connectables, returns and bridge. Grommet in worksurface. Narrow end panels on left and right. **Not freestanding**. Shipped easy to assemble in 1 carton.

- Modesty panel is 1" off of ground.

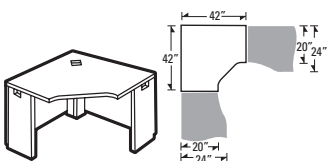

**5-Sided Corner\***

A42205C	42 x 42 x 29.6	110	5.75	<b>\$1044</b>	<b>\$440</b>
---------	----------------	-----	------	---------------	--------------

Connects to **24" D** space saver connectable surfaces, **20" D** returns, lateral files, storage/lateral file credenzas, credenzas, bridges and end shelves. Grommet in worksurface. Narrow end panels on left and right. **Not freestanding**. Shipped easy to assemble in 1 carton.

- Modesty panel is 1" off of ground.

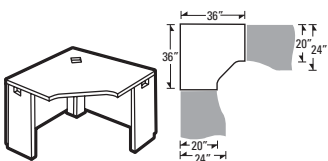

**5-Sided Corner\***

A36205C	36 x 36 x 29.6	94	4.8	<b>\$891</b>	<b>\$283</b>
---------	----------------	----	-----	--------------	--------------

Connects to **24" D** space saver connectable surfaces, **20" D** returns, lateral files, storage/lateral file credenzas, credenzas, bridges and end shelves. Grommet in worksurface. Narrow end panels on left and right. **Not freestanding**. Shipped easy to assemble in 1 carton.

- Modesty panel is 1" off of ground.

### Required specifications

Top finish  
Base finish  
Handles (only credenzas)  
Edge detail

### Optional specifications

Key #  
Additional grommet position  
HP laminate  
Power block cut-out

### Accessories

Power block  
Keyboard tray\*  
Pencil tray

**LEFT EXTENDED CORNERS**      **MODEL #**      **DIMENSIONS**      **WT/LB.**      **CUBIC FT.**      **LIST PRICE**      **HP ADD**

W x D x H

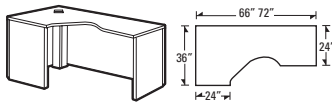

**Left Extended Corner - Freestanding**

A2472FFL	72 x 24-36 x 29.6	157	7	<b>\$1269</b>	<b>\$471</b>
A2466FFL	66 x 24-36 x 29.6	151	7	<b>\$1209</b>	<b>\$471</b>

Extended worksurface on right. **Full end panels on left and right. Cannot be connected on left or right due to full end panel.** Corner has one grommet. Shipped easy to assemble in 1 carton.

- **Modesty panel is 1" off of ground.**
- **A2466FFL cannot accept pedestals.**

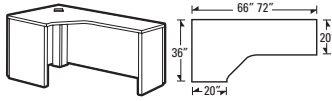

**Left Extended Corner**

A2072FFL	72 x 20-36 x 29.6	147	7	<b>\$1249</b>	<b>\$453</b>
A2066FFL	66 x 20-36 x 29.6	141	7	<b>\$1209</b>	<b>\$453</b>

Extended worksurface on right. **Full end panels on left and right. Cannot be connected on left or right due to full end panel.** Corner has one grommet. Shipped easy to assemble in 1 carton.

- **Modesty panel is 1" off of ground.**

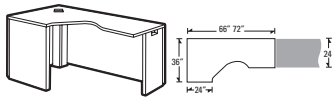

**Left Extended Corner**

A2472FNL	72 x 24-36 x 29.6	149	7	<b>\$1249</b>	<b>\$471</b>
A2466FNL	66 x 24-36 x 29.6	142	7	<b>\$1209</b>	<b>\$453</b>

Extended worksurface on right. **Narrow end panel on right. Full end panel on left.** Connects to 30"D space saver connectables, 24"D returns or 24"D connectable tables. **Full end panel cannot be connected.** Corner has one grommet. Shipped easy to assemble in 1 carton.

- **Modesty panel is 1" off of ground.**
- **A2466FNL cannot accept pedestals.**

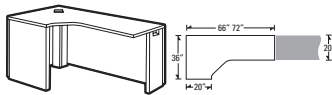

**Left Extended Corner**

A2072FNL	72 x 20-36 x 29.6	141	7	<b>\$1229</b>	<b>\$453</b>
A2066FNL	66 x 20-36 x 29.6	135	7	<b>\$1185</b>	<b>\$453</b>

Extended worksurface on right. **Narrow end panel on right. Full end panel on left.** Connects to 24"D space saver connectables, 20"D returns or 20"D connectable tables. **Full end panel cannot be connected.** Corner has one grommet. Shipped easy to assemble in 1 carton.

- **Modesty panel is 1" off of ground.**

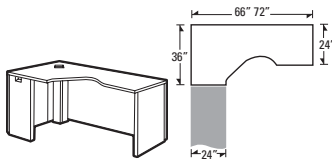

**Left Extended Corner**

A2472NFL	72 x 24-36 x 29.6	149	7	<b>\$1249</b>	<b>\$471</b>
A2466NFL	66 x 24-36 x 29.6	142	7	<b>\$1209</b>	<b>\$453</b>

Extended worksurface on right. **Narrow end panel on left. Full end panel on right.** Connects to 30"D space saver connectables, 24"D returns or 24"D connectable tables. **Full end panel cannot be connected.** Corner has one grommet. Shipped easy to assemble in 1 carton.

- **Modesty panel is 1" off of ground.**
- **A2466NFL cannot accept pedestals.**

**Required specifications**

- Top finish
- Base finish
- Edge detail

**Optional specifications**

- Additional grommet position
- HP laminate
- Power block cut-out

**Accessories**

- Power block
- Keyboard tray
- Pencil tray

# A ADAPTABILITIES®

## LEFT EXTENDED CORNERS

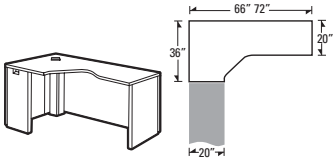

Left Extended Corner

MODEL #	DIMENSIONS W x D x H	WT/LB.	CUBIC FT.	LIST PRICE	HP ADD
A2072NFL	72 x 20-36 x 29.6	141	7	<b>\$1229</b>	<b>\$471</b>
A2066NFL	66 x 20-36 x 29.6	135	7	<b>\$1185</b>	<b>\$453</b>

Extended worksurface on right. **Narrow end panel on left. Full end panel on right.** Connects to 24"D space saver connectables and 20"D returns. **Full end panel can be connected.** Corner has one grommet. Shipped easy to assemble in 1 carton.

- **Modesty panel is 1" off of ground.**

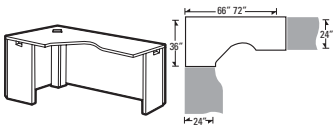

Left Extended Corner

A2472NNL	72 x 24-36 x 29.6	140	7	<b>\$1229</b>	<b>\$471</b>
A2466NNL	66 x 24-36 x 29.6	134	7	<b>\$1185</b>	<b>\$453</b>

Extended worksurface on right. **Narrow end panels on left and right.** Connects to 30"D space saver connectables, 24"D returns and 24"D connectable tables on either end. Corner has one grommet. Shipped easy to assemble in 1 carton.

- **Modesty panel is 1" off of ground.**
- **A2466NNL cannot accept pedestals.**

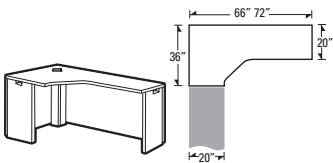

Left Extended Corner

A2072NNL	72 x 20-36 x 29.6	136	7	<b>\$1209</b>	<b>\$471</b>
A2066NNL	66 x 20-36 x 29.6	130	7	<b>\$1166</b>	<b>\$453</b>

Extended worksurface on right. **Narrow end panels on left and right.** Connects to 24"D space saver connectables and 20"D returns or bridge on either end. Corner has one grommet.

- **Modesty panel is 1" off of ground.**

## RIGHT EXTENDED CORNERS

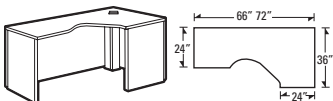

Right Extended Corner - Freestanding

A2472FFR	72 x 24-36 x 29.6	157	7	<b>\$1269</b>	<b>\$471</b>
A2466FFR	66 x 24-36 x 29.6	151	7	<b>\$1209</b>	<b>\$471</b>

Extended worksurface on left. **Full end panels on left and right. Cannot be connected on left or right due to full end panel.** Corner has one grommet. Shipped easy to assemble in 1 carton.

- **Modesty panel is 1" off of ground.**
- **A2466FFR cannot accept pedestals.**

### Required specifications

Top finish  
Base finish  
Edge detail

### Optional specifications

Additional grommet position  
HP laminate  
Power block cut-out

### Accessories

Power block  
Keyboard tray  
Pencil tray

**RIGHT EXTENDED CORNERS**      **MODEL #**      **DIMENSIONS**      **WT/LB.**      **CUBIC FT.**      **LIST PRICE**      **HP ADD**

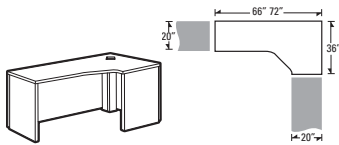

**Right Extended Corner**

	W x D x H					
A2072FFR	72 x 20-36 x 29.6	147	7	<b>\$1249</b>	<b>\$453</b>	
A2066FFR	66 x 20-36 x 29.6	141	7	<b>\$1209</b>	<b>\$453</b>	

Extended worksurface on left. **Full end panels on left and right. Cannot be connected on left or right due to full end panel.** Corner has one grommet. Shipped easy to assemble in 1 carton.  
 • **Modesty panel is 1" off of ground.**

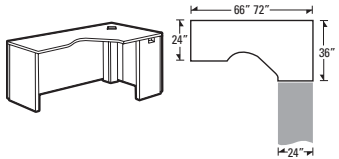

**Right Extended Corner**

A2472FNR	72 x 24-36 x 29.6	149	7	<b>\$1249</b>	<b>\$471</b>	
A2466FNR	66 x 24-36 x 29.6	142	7	<b>\$1209</b>	<b>\$453</b>	

Extended worksurface on left. **Narrow end panel on right. Full end panel on left.** Connects to 30"D space saver connectables, 24"D returns or 24"D connectable tables. **Full end panel cannot be connected.** Corner has one grommet. Shipped easy to assemble in 1 carton.  
 • **Modesty panel is 1" off of ground.**  
 • **A2466FNR cannot accept pedestals.**

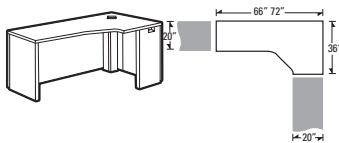

**Right Extended Corner**

A2072FNR	72 x 20-36 x 29.6	141	7	<b>\$1229</b>	<b>\$471</b>	
A2066FNR	66 x 20-36 x 29.6	135	7	<b>\$1185</b>	<b>\$453</b>	

Extended worksurface on left. **Narrow end panel on right. Full end panel on left.** Connects to 24"D space saver connectables, 20"D returns or 20"D connectable tables. **Full end panel cannot be connected.** Corner has one grommet. Shipped easy to assemble in 1 carton.  
 • **Modesty panel is 1" off of ground.**

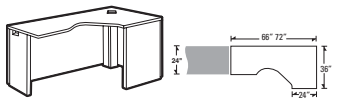

**Right Extended Corner**

A2472NFR	72 x 24-36 x 29.6	149	7	<b>\$1249</b>	<b>\$471</b>	
A2466NFR	66 x 24-36 x 29.6	142	7	<b>\$1209</b>	<b>\$453</b>	

Extended worksurface on left. **Narrow end panel on left. Full end panel on right.** Connects to 30"D space saver connectables, 24"D returns or 24"D connectable tables. **Full end panel cannot be connected.** Corner has one grommet. Shipped easy to assemble in 1 carton.  
 • **Modesty panel is 1" off of ground.**  
 • **A2466NFR cannot accept pedestals.**

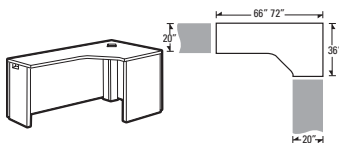

**Right Extended Corner**

A2072NFR	72 x 20-36 x 29.6	141	7	<b>\$1229</b>	<b>\$471</b>	
A2066NFR	66 x 20-36 x 29.6	135	7	<b>\$1185</b>	<b>\$453</b>	

Extended worksurface on left. **Narrow end panel on left. Full end panel on right.** Connects to 24"D space saver connectables, 20"D returns. **Full end panel cannot be connected.** Corner has one grommet. Shipped easy to assemble in 1 carton.  
 • **Modesty panel is 1" off of ground.**

**Required specifications**

Top finish  
 Base finish  
 Edge detail

**Optional specifications**

Additional grommet position  
 HP laminate  
 Power block cut-out

**Accessories**

Power block  
 Keyboard tray  
 Pencil tray

# A ADAPTABILITIES®

## RIGHT EXTENDED CORNERS

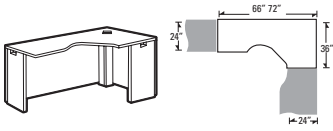

Right Extended Corner

MODEL #	DIMENSIONS W x D x H	WT/LB.	CUBIC FT.	LIST PRICE	HP ADD
A2472NNR	72 x 24-36 x 29.6	140	7	<b>\$1229</b>	<b>\$471</b>
A2466NNR	66 x 24-36 x 29.6	133	7	<b>\$1185</b>	<b>\$453</b>

Extended worksurface on left. **Narrow end panels on left and right.** Connects to 30"D space saver connectables, 24"D returns and 24"D connectable tables on either end. Corner has one grommet. Shipped easy to assemble in 1 carton.

- **Modesty panel is 1" off of ground.**
- **A2466NNR cannot accept pedestals.**

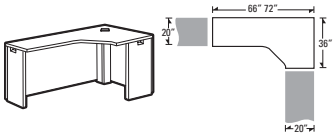

Right Extended Corner

A2072NNR	72 x 20-36 x 29.6	136	7	<b>\$1209</b>	<b>\$471</b>
A2066NNR	66 x 20-36 x 29.6	130	7	<b>\$1166</b>	<b>\$453</b>

Extended worksurface on left. **Narrow end panels on left and right.** Connects to 24"D space saver connectables and 20"D returns or bridge on either end. Corner has one grommet. Shipped easy to assemble in 1 carton.

- **Modesty panel is 1" off of ground.**

## FREESTANDING TABLES

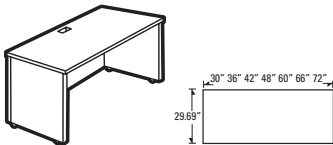

30" Deep Freestanding Table

A3072T	72 x 29.69 x 29.6	148	6	<b>\$939</b>	<b>\$440</b>
A3066T	66 x 29.69 x 29.6	140	6	<b>\$887</b>	<b>\$404</b>
A3060T	60 x 29.69 x 29.6	131	5.25	<b>\$853</b>	<b>\$404</b>
A3048T	48 x 29.69 x 29.6	116	5.25	<b>\$791</b>	<b>\$345</b>
A3042T	42 x 29.69 x 29.6	108	5.25	<b>\$747</b>	<b>\$314</b>
A3036T	36 x 29.69 x 29.6	97	4.3	<b>\$717</b>	<b>\$283</b>
A3030T	30 x 29.69 x 29.6	88	3.6	<b>\$694</b>	<b>\$253</b>

Two full end panels. **Cannot be connected on left or right side of full end panels.** Grommet in worksurface. Shipped easy to assemble in 1 carton.

- **Modesty panel is 1" off of ground.**

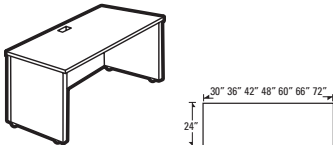

24" Deep Freestanding Table

A2472T	72 x 24 x 29.6	130	6	<b>\$844</b>	<b>\$314</b>
A2466T	66 x 24 x 29.6	123	6	<b>\$801</b>	<b>\$300</b>
A2460T	60 x 24 x 29.6	114	5.25	<b>\$761</b>	<b>\$300</b>
A2448T	48 x 24 x 29.6	99	4.3	<b>\$732</b>	<b>\$239</b>
A2442T	42 x 24 x 29.6	92	4.3	<b>\$673</b>	<b>\$202</b>
A2436T	36 x 24 x 29.6	84	4.2	<b>\$670</b>	<b>\$152</b>
A2430T	30 x 24 x 29.6	76	3.6	<b>\$635</b>	<b>\$152</b>

Two full end panels. **Cannot be connected on left or right side of full end panels.** Grommet in worksurface. Shipped easy to assemble in 1 carton.

- **Modesty panel is 1" off of ground.**

### Required specifications

Top finish  
Base finish  
Edge detail

### Optional specifications

Additional grommet position  
HP laminate  
Power block cut-out

### Accessories

Power block  
Keyboard tray  
Pencil tray



CONNECTABLE TABLES - LEFT

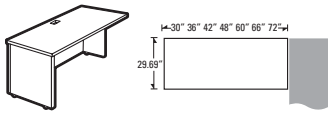

30" Deep Connectable Table - LEFT

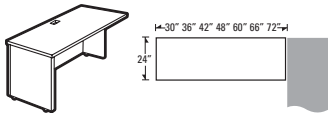

24" Deep Connectable Table - LEFT

MODEL # DIMENSIONS WT/LB. CUBIC FT. LIST PRICE HP ADD

W x D x H

A3072L	72 x 29.69 x 29.6	140	6	\$939	\$440
A3066L	66 x 29.69 x 29.6	132	6	\$887	\$404
A3060L	60 x 29.69 x 29.6	123	5.25	\$853	\$404
A3048L	48 x 29.69 x 29.6	105	4.3	\$791	\$345
A3042L	42 x 29.69 x 29.6	98	4.3	\$747	\$314
A3036L	36 x 29.69 x 29.6	88	4.2	\$714	\$283
A3030L	30 x 29.69 x 29.6	80	3.6	\$701	\$253

Full end panel on **left**. Right narrow end panel connects to 30"D center/right connectable table, or at 90° angle to a freestanding table; and "D" islands or "P" islands with "T" and "H" bases. Grommet in worksurface. Shipped easy to assemble in 1 carton.

• Modesty panel is 1" off of ground.

A2472L	72 x 24 x 29.6	121	6	\$844	\$314
A2466L	66 x 24 x 29.6	115	6	\$801	\$300
A2460L	60 x 24 x 29.6	106	5.25	\$773	\$300
A2448L	48 x 24 x 29.6	90	4.3	\$732	\$239
A2442L	42 x 24 x 29.6	82	3.8	\$673	\$202
A2436L	36 x 24 x 29.6	74	3.3	\$660	\$152
A2430L	30 x 24 x 29.6	68	3.6	\$635	\$152

Full end panel on **left**. Right narrow end panel connects to 24"D center/right connectable table, or at 90° angle to a freestanding table; 24"D extended corners, 42" 5-sided corners or at the end of a straight run; "D" islands or "P" islands with "T" and "H" bases. Grommet in worksurface. Shipped easy to assemble in 1 carton.

• Modesty panel is 1" off of ground.

CONNECTABLE TABLES - RIGHT

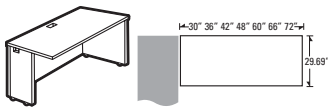

30" Deep Connectable Table - RIGHT

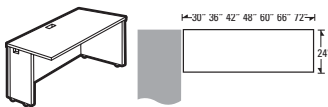

24" Deep Connectable Table - RIGHT

A3072R	72 x 29.69 x 29.6	140	6	\$939	\$440
A3066R	66 x 29.69 x 29.6	132	6	\$887	\$404
A3060R	60 x 29.69 x 29.6	123	5.25	\$853	\$404
A3048R	48 x 29.69 x 29.6	105	4.3	\$791	\$345
A3042R	42 x 29.69 x 29.6	98	4.3	\$747	\$314
A3036R	36 x 29.69 x 29.6	88	4.3	\$714	\$283
A3030R	30 x 29.69 x 29.6	80	3.6	\$701	\$253

Full end panel on **right**. Left narrow end panel connects to 30"D center/left connectable table, or at 90° angle to a freestanding table; "D" islands or "P" islands with "T" and "H" bases. Grommet in worksurface. Shipped easy to assemble in 1 carton.

• Modesty panel is 1" off of ground.

A2472R	72 x 24 x 29.6	121	6	\$844	\$314
A2466R	66 x 24 x 29.6	115	6	\$801	\$300
A2460R	60 x 24 x 29.6	105	5.25	\$773	\$300
A2448R	48 x 24 x 29.6	90	4.3	\$732	\$239
A2442R	42 x 24 x 29.6	82	3.8	\$673	\$202
A2436R	36 x 24 x 29.6	74	3.3	\$660	\$152
A2430R	30 x 24 x 29.6	67	3.6	\$635	\$152

Full end panel on **right**. Left narrow end panel connects to 24"D center/left connectable table, or at 90° angle to a freestanding table; 24"D extended corners, 42" 5-sided corners or at the end of a straight run; "D" islands or "P" islands with "T" and "H" bases. Grommet in worksurface. Shipped easy to assemble in 1 carton.

• Modesty panel is 1" off of ground.

Required specifications

Top finish  
Body finish  
Edge detail

Optional specifications

Additional grommet position  
HP laminate  
Power block cut-out

Accessories

Power block  
Keyboard tray  
Pencil tray

# A ADAPTABILITIES®

## CONNECTABLE TABLES

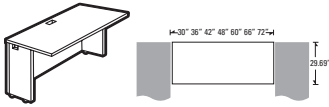

**30" Deep Connectable Table**

MODEL #	DIMENSIONS W x D x H	WT/LB.	CUBIC FT.	LIST PRICE	HP ADD
A3072N	72 x 29.69 x 29.6	131	6	<b>\$939</b>	<b>\$440</b>
A3066N	66 x 29.69 x 29.6	124	6	<b>\$887</b>	<b>\$404</b>
A3060N	60 x 29.69 x 29.6	114	5.25	<b>\$853</b>	<b>\$404</b>
A3048N	48 x 29.69 x 29.6	97	4.3	<b>\$798</b>	<b>\$345</b>
A3042N	42 x 29.69 x 29.6	89	3.8	<b>\$778</b>	<b>\$314</b>
A3036N	36 x 29.69 x 29.6	80	3.3	<b>\$714</b>	<b>\$283</b>
A3030N	30 x 29.69 x 29.6	71	3.6	<b>\$665</b>	<b>\$253</b>

Narrow end panels on both sides. Connects to 30"D worksurfaces; "D" islands or "P" islands with "T" and "H" bases; or at 90° angle to freestanding table(s). Grommet in worksurface. Shipped easy to assemble in 1 carton.

- **Modesty panel is 1" off of ground.**

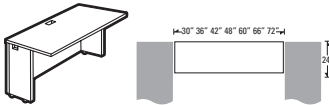

**24" Deep Connectable Table**

A2472N	72 x 24 x 29.6	113	6	<b>\$844</b>	<b>\$314</b>
A2466N	66 x 24 x 29.6	105	6	<b>\$801</b>	<b>\$300</b>
A2460N	60 x 24 x 29.6	100	4.5	<b>\$781</b>	<b>\$300</b>
A2448N	48 x 24 x 29.6	82	4.3	<b>\$710</b>	<b>\$239</b>
A2442N	42 x 24 x 29.6	73	3.8	<b>\$673</b>	<b>\$202</b>
A2436N	36 x 24 x 29.6	66	3.3	<b>\$635</b>	<b>\$152</b>
A2430N	30 x 24 x 29.6	59	3.6	<b>\$598</b>	<b>\$152</b>

Narrow end panels on both sides. Connects to 24"D worksurfaces; "D" islands or "P" islands with "T" and "H" bases; or at 90° angle to freestanding table(s). Grommet in worksurface. Shipped easy to assemble in 1 carton.

- **Modesty panel is 1" off of ground.**

## SPACE SAVER CONNECTABLE TABLES - LEFT

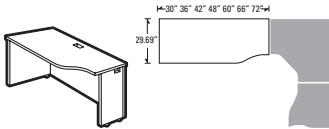

**30" Deep Space Saver Connectable Table - LEFT**

A3072LK	72 x 29.69 x 29.6	133	6	<b>\$982</b>	<b>\$440</b>
A3066LK	66 x 29.69 x 29.6	126	6	<b>\$939</b>	<b>\$404</b>
A3060LK	60 x 29.69 x 29.6	117	5.25	<b>\$894</b>	<b>\$404</b>
A3048LK	48 x 29.69 x 29.6	100	4.3	<b>\$829</b>	<b>\$345</b>
A3042LK	42 x 29.69 x 29.6	92	3.8	<b>\$779</b>	<b>\$314</b>
A3036LK	36 x 29.69 x 29.6	83	4.3	<b>\$756</b>	<b>\$283</b>
A3030LK	30 x 29.69 x 29.6	74	3.6	<b>\$726</b>	<b>\$253</b>

**Full end panel on left.** Narrow right end panel connects to 24"D 5-sided corner unit. Grommet in worksurface. Shipped easy to assemble in 1 carton.

- **Modesty panel is 1" off of ground.**
- *Keyboard and pencil trays for use on units 42" and above.*

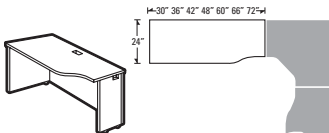

**24" Deep Space Saver Connectable Table - LEFT**

A2472LK	72 x 24 x 29.6	120	6	<b>\$887</b>	<b>\$314</b>
A2466LK	66 x 24 x 29.6	114	6	<b>\$844</b>	<b>\$300</b>
A2460LK	60 x 24 x 29.6	105	5.25	<b>\$809</b>	<b>\$300</b>
A2448LK	48 x 24 x 29.6	89	4.3	<b>\$759</b>	<b>\$239</b>
A2442LK	42 x 24 x 29.6	81	3.8	<b>\$732</b>	<b>\$202</b>
A2436LK	36 x 24 x 29.6	73	3.3	<b>\$694</b>	<b>\$152</b>
A2430LK	30 x 24 x 29.6	66	3.6	<b>\$660</b>	<b>\$152</b>

**Full end panel on left.** Narrow right end panel connects to 20"D 5-sided corner unit. Grommet in worksurface. Shipped easy to assemble in 1 carton.

- **Modesty panel is 1" off of ground.**
- *Keyboard and pencil trays for use on units 42" and above.*

### Required specifications

Top finish  
Base finish  
Edge detail

### Optional specifications

Additional grommet position  
HP laminate  
Power block cut-out

### Accessories

Power block  
Keyboard tray  
Pencil tray

**SPACE SAVER CONNECTABLE TABLES - RIGHT**

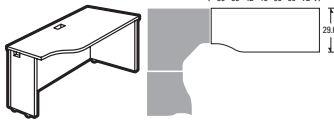

**30" Deep Space Saver Connectable Table - RIGHT**

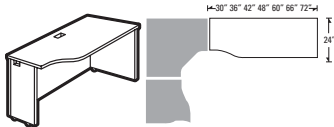

**24" Deep Space Saver Connectable Table - RIGHT**

MODEL #	DIMENSIONS W x D x H	WT/LB.	CUBIC FT.	LIST PRICE	HP ADD
A3072RK	72 x 29.69 x 29.6	133	6	<b>\$982</b>	<b>\$440</b>
A3066RK	66 x 29.69 x 29.6	126	6	<b>\$939</b>	<b>\$404</b>
A3060RK	60 x 29.69 x 29.6	117	5.25	<b>\$894</b>	<b>\$404</b>
A3048RK	48 x 29.69 x 29.6	100	4.3	<b>\$829</b>	<b>\$345</b>
A3042RK	42 x 29.69 x 29.6	91	3.8	<b>\$779</b>	<b>\$314</b>
A3036RK	36 x 29.69 x 29.6	83	4.3	<b>\$756</b>	<b>\$283</b>
A3030RK	30 x 29.69 x 29.6	74	3.6	<b>\$726</b>	<b>\$253</b>

**Full end panel on right.** Narrow right end panel connects to 24"D 5-sided corner unit. Grommet in worksurface. Shipped easy to assemble in 1 carton.

- **Modesty panel is 1" off of ground.**
- *Keyboard and pencil trays for use on units 42" and above.*

A2472RK	72 x 24 x 29.6	120	6	<b>\$887</b>	<b>\$314</b>
A2466RK	66 x 24 x 29.6	114	6	<b>\$844</b>	<b>\$300</b>
A2460RK	60 x 24 x 29.6	105	5.25	<b>\$809</b>	<b>\$300</b>
A2448RK	48 x 30 x 29.6	89	4.3	<b>\$759</b>	<b>\$239</b>
A2442RK	42 x 24 x 29.6	81	3.8	<b>\$732</b>	<b>\$202</b>
A2436RK	36 x 24 x 29.6	73	3.3	<b>\$694</b>	<b>\$152</b>
A2430RK	30 x 24 x 29.6	66	3.6	<b>\$660</b>	<b>\$152</b>

**Full end panel on right.** Narrow right end panel connects to 20"D 5-sided corner unit. Grommet in worksurface. Shipped easy to assemble in 1 carton.

- **Modesty panel is 1" off of ground.**
- *Keyboard and pencil trays for use on units 42" and above.*

**SPACE SAVER CONNECTABLE TABLES**

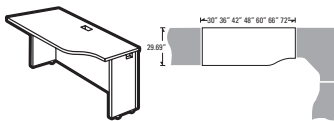

**30" Deep Space Saver Connectable Table**

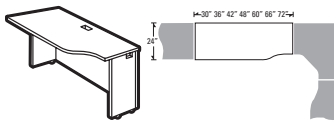

**24" Deep Space Saver Connectable Table**

A3072LN	72 x 29.69 x 29.6	125	6	<b>\$982</b>	<b>\$440</b>
A3066LN	66 x 29.69 x 29.6	117	6	<b>\$939</b>	<b>\$404</b>
A3060LN	60 x 29.69 x 29.6	108	5.25	<b>\$894</b>	<b>\$404</b>
A3048LN	48 x 29.69 x 29.6	91	4.3	<b>\$828</b>	<b>\$345</b>
A3042LN	42 x 29.69 x 29.6	83	3.8	<b>\$793</b>	<b>\$314</b>
A3036LN	36 x 29.69 x 29.6	74	3.3	<b>\$744</b>	<b>\$283</b>
A3030LN	30 x 29.69 x 29.6	66	3.6	<b>\$694</b>	<b>\$253</b>

**Narrow end panels on both sides.** Connects the **right end only to 24"D 5-sided corner unit.** Left end allows the continuation of additional connectable center or left connectable worksurface. Grommet in worksurface. Shipped easy to assemble in 1 carton.

- **Modesty panel is 1" off of ground.**
- *Keyboard and pencil trays for use on units 42" and above.*

A2472LN	72 x 24 x 29.6	112	6	<b>\$871</b>	<b>\$314</b>
A2466LN	66 x 24 x 29.6	105	6	<b>\$844</b>	<b>\$300</b>
A2460LN	60 x 24 x 29.6	96	5.25	<b>\$791</b>	<b>\$300</b>
A2448LN	48 x 24 x 29.6	81	4.3	<b>\$732</b>	<b>\$239</b>
A2442LN	42 x 24 x 29.6	73	3.8	<b>\$716</b>	<b>\$202</b>
A2436LN	36 x 24 x 29.6	65	3.3	<b>\$665</b>	<b>\$152</b>
A2430LN	30 x 24 x 29.6	58	3.6	<b>\$635</b>	<b>\$152</b>

**Narrow end panels on both sides.** Connects the **right end only to 20"D 5-sided corner unit.** Left end allows the continuation of an additional connectable center or left connectable worksurface. Grommet in worksurface. Shipped easy to assemble in 1 carton.

- **Modesty panel is 1" off of ground.**
- *Keyboard and pencil trays for use on units 42" and above.*

**Required specifications**

Top finish  
Base finish  
Edge detail

**Optional specifications**

Additional grommet  
HP laminate  
Power block cut-out

**Accessories**

Power block  
Keyboard tray  
Pencil tray

# A ADAPTABILITIES®

## SPACE SAVER CONNECTABLE TABLES

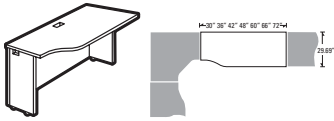

**30" Deep Space Saver Connectable Table**

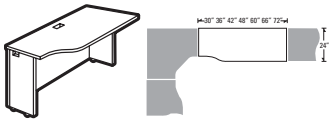

**24" Deep Space Saver Connectable Table**

MODEL #	DIMENSIONS		WT/LB.	CUBIC FT.	LIST PRICE	HP ADD	
	W x D x H						
A3072RN	72	29.69	29.6	125	6	<b>\$982</b>	<b>\$440</b>
A3066RN	66	29.69	29.6	117	6	<b>\$939</b>	<b>\$404</b>
A3060RN	60	29.69	29.6	108	5.25	<b>\$894</b>	<b>\$404</b>
A3048RN	48	29.69	29.6	91	4.3	<b>\$828</b>	<b>\$345</b>
A3042RN	42	29.69	29.6	83	3.8	<b>\$793</b>	<b>\$314</b>
A3036RN	36	29.69	29.6	74	3.3	<b>\$744</b>	<b>\$283</b>
A3030RN	30	29.69	29.6	66	3.6	<b>\$694</b>	<b>\$253</b>

**Narrow end panels on both sides.** Connects the **left end only to 24"D 5-sided corner unit.** Right end allows the continuation of additional connectable center or right connectable worksurface. Grommet in worksurface. Shipped easy to assemble in 1 carton.

- **Modesty panel is 1" off of ground.**
- *Keyboard and pencil trays for use on units 42" and above.*

A2472RN	72	24	29.6	112	6	<b>\$871</b>	<b>\$314</b>
A2466RN	66	24	29.6	105	6	<b>\$844</b>	<b>\$300</b>
A2460RN	60	24	29.6	96	5.25	<b>\$791</b>	<b>\$300</b>
A2448RN	48	24	29.6	81	4.3	<b>\$732</b>	<b>\$239</b>
A2442RN	42	24	29.6	72	3.8	<b>\$716</b>	<b>\$202</b>
A2436RN	36	24	29.6	59	3.3	<b>\$665</b>	<b>\$152</b>
A2430RN	30	24	29.6	53	3.6	<b>\$635</b>	<b>\$152</b>

**Narrow end panels on both sides.** Connects the **left end only to 20"D 5-sided corner unit.** Right end allows the continuation of additional connectable center or right connectable worksurface. Grommet in worksurface. Shipped easy to assemble in 1 carton.

- **Modesty panel is 1" off of ground.**
- *Keyboard and pencil trays for use on units 42" and above.*

## "D" ISLANDS

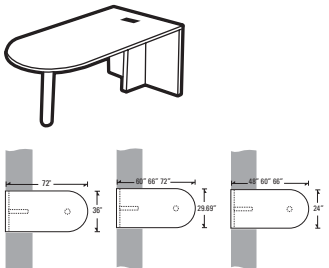

**"D" Island - Full End Panel & Post (T-Base)\***

A3672FI	72	36	29.6	124	8.5	<b>\$994</b>	<b>\$471</b>
A3072FI	72	29.69	29.6	107	7.5	<b>\$957</b>	<b>\$440</b>
A3066FI	66	29.69	29.6	102	7.5	<b>\$894</b>	<b>\$404</b>
A3060FI	60	29.69	29.6	96	6.76	<b>\$844</b>	<b>\$404</b>
A2466FI	66	24	29.6	90	7.5	<b>\$838</b>	<b>\$300</b>
A2460FI	60	24	29.6	84	6.76	<b>\$794</b>	<b>\$300</b>
A2448FI	48	24	29.6	74	5.76	<b>\$759</b>	<b>\$239</b>

Connects to narrow end panel. Attaching hardware included. **Not freestanding.** Grommet in worksurface. Shipped easy to assemble in 2 cartons.

- Post is shipped in separate carton. MUST specify Black (TBL) or Tungsten (TTU) finish.

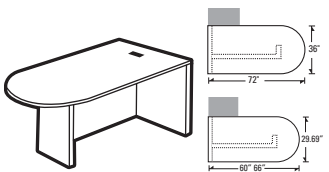

**"D" Island - Full Modesty Panel (H-Base) - LEFT**

A3672FIL	72	36	29.6	139	7	<b>\$999</b>	<b>\$471</b>
A3066FIL	66	29.69	29.6	116	6	<b>\$921</b>	<b>\$404</b>
A3060FIL	60	29.69	29.6	106	5.25	<b>\$844</b>	<b>\$404</b>

Connects to the left side of a worksurface. Accommodates all 19" pedestals (freestanding, mobile and hanging pedestals). Grommet in worksurface. Shipped easy to assemble in 1 carton.

- **Modesty panel is 1" off of ground.**

### Required specifications

Top finish  
Base finish  
Edge detail  
Post finish\*

### Optional specifications

Additional grommet position  
HP laminate  
Power block cut-out

### Accessories

Power block  
Keyboard tray  
Pencil tray

**"D" ISLANDS** **MODEL #** **DIMENSIONS** **WT/LB.** **CUBIC FT.** **LIST PRICE** **HP ADD**

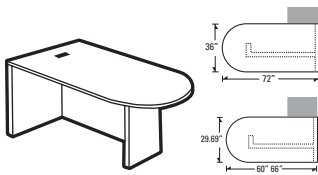

**"D" Island - Full Modesty Panel (H-Base) - RIGHT**

	W x D x H				
A3672FIR	72 x 36 x 29.6	139	7	<b>\$999</b>	<b>\$471</b>
A3066FIR	66 x 29.69 x 29.6	116	6	<b>\$921</b>	<b>\$404</b>
A3060FIR	60 x 29.69 x 29.6	106	5.25	<b>\$844</b>	<b>\$404</b>

Connects to the right side of a worksurface. Accommodates all 19" pedestals (freestanding, mobile and hanging pedestals). Grommet in worksurface. Shipped easy to assemble in 1 carton.  
 • Modesty panel is 1" off of ground.

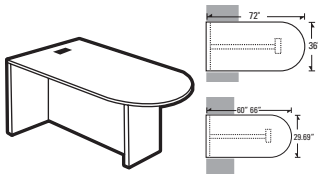

**"D" Island - Full Modesty Panel (H-Base) - Center**

A3672FIC	72 x 36 x 29.6	139	7	<b>\$999</b>	<b>\$471</b>
A3066FIC	66 x 29.69 x 29.6	116	6	<b>\$921</b>	<b>\$404</b>
A3060FIC	60 x 29.69 x 29.6	106	5.25	<b>\$844</b>	<b>\$404</b>

Connects in between two worksurfaces. Will not accommodate pedestals. Grommet in worksurface. Shipped easy to assemble in 1 carton.  
 • Modesty panel is 1" off of ground.

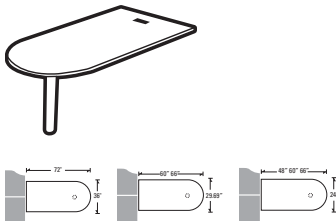

**Attachable "D" Island with Post\***

A3672I	72 x 36 x 29.6	88	8.5	<b>\$801</b>	<b>\$471</b>
A3066I	66 x 29.69 x 29.6	71	7.5	<b>\$741</b>	<b>\$404</b>
A3060I	60 x 29.69 x 29.6	65	6.76	<b>\$716</b>	<b>\$404</b>
A2466I	66 x 24 x 29.6	63	7.5	<b>\$679</b>	<b>\$300</b>
A2460I	60 x 24 x 29.6	57	6.76	<b>\$655</b>	<b>\$300</b>
A2448I	48 x 24 x 29.6	47	5.76	<b>\$625</b>	<b>\$239</b>

Attaches to edge of worksurfaces. Attaching hardware included. Grommet in worksurface. Shipped easy to assemble in 2 cartons.  
 • Post is shipped in separate carton. MUST specify Black (TBL) or Tungten (TTU) finish.

**EXTENDED CORNER ISLANDS**

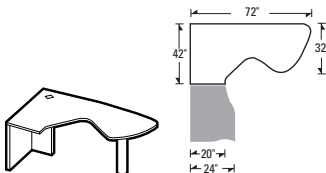

**Extended Corner Island - RIGHT\***

A4272EIR	72 x 42-32 x 29.6	104	11.5	<b>\$1259</b>	<b>\$629</b>
----------	-------------------	-----	------	---------------	--------------

Extended island worksurface on right. Connects to 20"D returns or 24"D space saver connectables on the left. **Not freestanding.** Grommet in worksurface. Shipped easy to assemble in 2 cartons.  
 • Post is shipped in separate carton. MUST specify Black (TBL) or Tungten (TTU) finish.

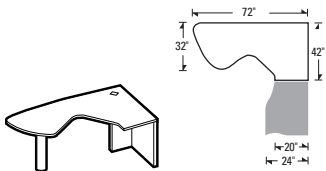

**Extended Corner Island - LEFT\***

A4272EIL	72 x 42-32 x 29.6	104	11.5	<b>\$1259</b>	<b>\$629</b>
----------	-------------------	-----	------	---------------	--------------

Extended island worksurface on left. Connects to 20"D returns or 24"D space saver connectables on the right. **Not freestanding.** Grommet in worksurface. Shipped easy to assemble in 2 cartons.  
 • Post is shipped in separate carton. MUST specify Black (TBL) or Tungten (TTU) finish.

**Required specifications**

Top finish  
 Base finish (not attachable "d" island w/post)  
 Edge detail  
 Post finish\*

**Optional specifications**

Additional grommet position  
 HP laminate  
 Power block cut-out

**Accessories**

Power block  
 Keyboard tray  
 Pencil tray

# A ADAPTABILITIES®

## "P" ISLANDS

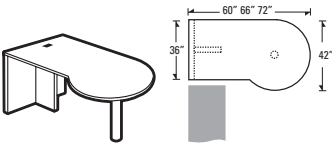

**"P" Island - Full End Panel & Post (T-Base) - LEFT\***

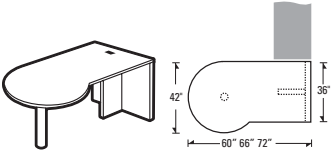

**"P" Island - Full End Panel & Post (T-Base) - RIGHT\***

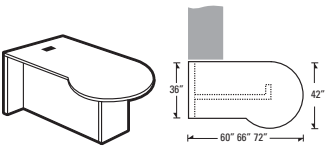

**"P" Island - Full Modesty Panel (H-Base) - LEFT**

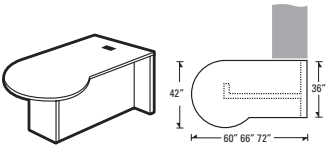

**"P" Island - Full Modesty Panel (H-Base) - RIGHT**

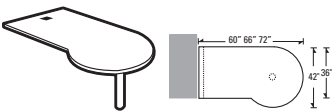

**"P" Island with Post - LEFT\***

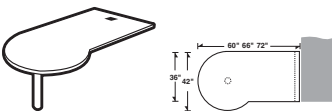

**"P" Island with Post - RIGHT\***

MODEL #	DIMENSIONS W x D x H	WT/LB.	CUBIC FT.	LIST PRICE	HP ADD
A3672FPL	72 x 36-42 x 29.6	128	9.26	<b>\$1153</b>	<b>\$629</b>
A3666FPL	66 x 36-42 x 29.6	122	8.76	<b>\$1123</b>	<b>\$629</b>
A3660FPL	60 x 36-42 x 29.6	116	8	<b>\$1068</b>	<b>\$533</b>

Connects to left side of worksurface. Attaching hardware included. **Not freestanding.** Grommet in worksurface. Shipped easy to assemble in 2 cartons.

- Post is shipped in separate carton. MUST specify Black (**TBL**) or Tungsten (**TTU**) finish.

A3672FPR	72 x 36-42 x 29.6	128	9.26	<b>\$1153</b>	<b>\$629</b>
A3666FPR	66 x 36-42 x 29.6	122	8.76	<b>\$1123</b>	<b>\$629</b>
A3660FPR	60 x 36-42 x 29.6	116	8	<b>\$1068</b>	<b>\$533</b>

Connects to right side of worksurface. Attaching hardware included. **Not freestanding.** Grommet in worksurface. Shipped easy to assemble in 2 cartons.

- Post is shipped in separate carton. MUST specify Black (**TBL**) or Tungsten (**TTU**) finish.

A3672PL	72 x 36-42 x 29.6	143	7.75	<b>\$1168</b>	<b>\$629</b>
A3666PL	66 x 36-42 x 29.6	136	7.25	<b>\$1087</b>	<b>\$629</b>
A3660PL	60 x 36-42 x 29.6	126	6.5	<b>\$1024</b>	<b>\$533</b>

Connects to the left side of a worksurface. Accommodates all 19" pedestals (freestanding, mobile and hanging pedestals). Grommet in worksurface. Shipped easy to assemble in 1 carton.

- Modesty panel is 1" off of ground.

A3672PR	72 x 36-42 x 29.6	143	7.75	<b>\$1168</b>	<b>\$629</b>
A3666PR	66 x 36-42 x 29.6	136	7.25	<b>\$1087</b>	<b>\$629</b>
A3660PR	60 x 36-42 x 29.6	126	6.5	<b>\$1024</b>	<b>\$533</b>

Connects to the right side of a worksurface. Accommodates all 19" pedestals (freestanding, mobile and hanging pedestals). Grommet in worksurface. Shipped easy to assemble in 1 carton.

- Modesty panel is 1" off of ground.

A3672IPL	72 x 36-42 x 29.6	92	9.26	<b>\$993</b>	<b>\$629</b>
A3666IPL	66 x 36-42 x 29.6	86	8.76	<b>\$951</b>	<b>\$629</b>
A3660IPL	60 x 36-42 x 29.6	80	8	<b>\$887</b>	<b>\$533</b>

Attaches to edge of worksurfaces. Attaching hardware included. Grommet in worksurface. Shipped easy to assemble in 2 cartons.

- Post is shipped in separate carton. MUST specify Black (**TBL**) or Tungsten (**TTU**) finish.

A3672IPR	72 x 36-42 x 29.6	92	9.26	<b>\$993</b>	<b>\$629</b>
A3666IPR	66 x 36-42 x 29.6	86	8.76	<b>\$951</b>	<b>\$629</b>
A3660IPR	60 x 36-42 x 29.6	80	8	<b>\$887</b>	<b>\$533</b>

Attaches to edge of worksurfaces. Attaching hardware included. Grommet in worksurface. Shipped easy to assemble in 2 cartons.

- Post is shipped in separate carton. MUST specify Black (**TBL**) or Tungsten (**TTU**) finish.

### Required specifications

Top finish  
Base finish  
Edge detail  
Post finish\*

### Optional specifications

Additional grommet position  
HP laminate  
Power block cut-out

### Accessories

Power block  
Keyboard tray  
Pencil tray

**RADIUS SPANNER ISLANDS**      **MODEL #**      **DIMENSIONS**      **WT/LB.**      **CUBIC FT.**      **LIST PRICE**      **HP ADD**

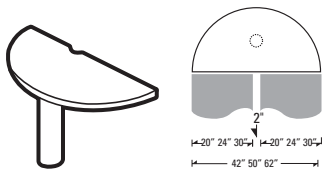

**Radius Spanner Island with Panel Cut-Out\*\***

	W x D x H					
A62RS	62 x 31 x 29.6	59	6.76	<b>\$951</b>	<b>\$314</b>	
A50RS	50 x 25 x 29.6	46	5.76	<b>\$816</b>	<b>\$314</b>	
A42RS	42 x 21 x 29.6	41	5.26	<b>\$741</b>	<b>\$253</b>	

Used to connect two back-to-back units of same depth with a panel. Includes monopost. Requires "L" bracket (model **MLB90**) for connection to full end panels. Shipped easy to assemble in 2 cartons.

- MLB90 must be ordered separately - see page 265.
- Post is shipped in separate carton. MUST specify Black (**TBL**) or Tungsten (**TTU**) finish.
- **Cannot accept keyboard trays or pencil tray.**

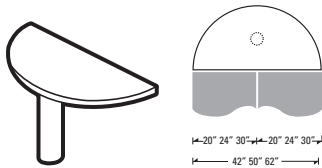

**Radius Spanner Island\*\***

A60RS	60 x 29.69 x 29.6	56	5.76	<b>\$951</b>	<b>\$314</b>	
A48RS	48 x 24 x 29.6	43	5.76	<b>\$816</b>	<b>\$253</b>	
A40RS	40 x 20 x 29.6	40	5.26	<b>\$741</b>	<b>\$253</b>	

Used to connect two back-to-back units of same depth. Includes monopost. Requires "L" bracket (model **MLB90**) for connection to full end panels. Shipped easy to assemble in 2 cartons.

- MLB90 must be ordered separately - see page 265.
- Post is shipped in separate carton. MUST specify Black (**TBL**) or Tungsten (**TTU**) finish.
- **Cannot accept keyboard trays or pencil tray.**

**RECEPTION DESKS**

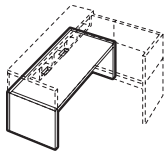

**Lower Desk Unit\***

A3072RD	72 x 29.69 x 29.6	149	7	<b>\$1019</b>	<b>\$440</b>	
---------	-------------------	-----	---	---------------	--------------	--

**No pedestals.** Two grommets in worksurface. Shipped easy to assemble in 1 carton.

- Reception desk components are only designed to be used together. Do not specify with standard Adaptabilities components.
- *Cannot be used with Divide.*

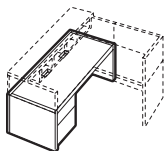

**Single Pedestal Lower Desk Unit - LEFT\***

A3072RDL	72 x 29.69 x 29.6	222	43.75	<b>\$1494</b>	<b>\$440</b>	
----------	-------------------	-----	-------	---------------	--------------	--

Box/file pedestal on **left** with lock. Two grommets in worksurface. Shipped easy to assemble in 1 carton.

- Reception desk components are only designed to be used together. Do not specify with standard Adaptabilities components.
- *Cannot be used with Divide.*

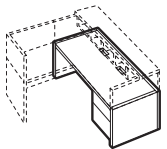

**Single Pedestal Lower Desk Unit - RIGHT\***

A3072RDR	72 x 29.69 x 29.6	222	43.75	<b>\$1494</b>	<b>\$440</b>	
----------	-------------------	-----	-------	---------------	--------------	--

Box/file pedestal on **right** with lock. Two grommets in worksurface. Shipped easy to assemble in 1 carton.

- Reception desk components are only designed to be used together. Do not specify with standard Adaptabilities components.
- *Cannot be used with Divide.*

**Required specifications**

- Top finish
- Base finish (not radius spanner islands)
- Post finish\*\*
- Edge detail

**Optional specifications**

- Additional grommet position\*
- HP laminate\*
- Power block cut-out\*

**Accessories**

- Power block\*
- Keyboard tray\*
- Pencil tray\*

# A ADAPTABILITIES®

## RECEPTION RETURNS

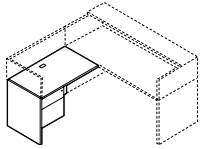

**Reception Return - LEFT\***

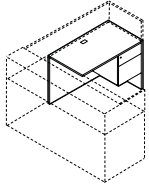

**Reception Return - RIGHT\***

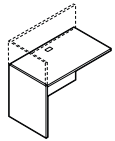

**Reception Return - LEFT\***

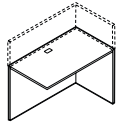

**Reception Return - RIGHT\***

MODEL #	DIMENSIONS	WT/LB.	CUBIC FT.	LIST PRICE	HP ADD
---------	------------	--------	-----------	------------	--------

W x D x H

A2442RRL	42 x 24 x 29.6	131	21.25	<b>\$1005</b>	<b>\$202</b>
----------	----------------	-----	-------	---------------	--------------

Box/file pedestal on **left** with lock. Grommet in worksurface. Shipped assembled in 1 carton.

- Reception desk components are only designed to be used together. Do not specify with standard Adaptabilities components.
- *Cannot be used with Divide.*
- **Cannot accept keyboard trays or pencil tray.**

A2442RRR	42 x 24 x 29.6	131	21.25	<b>\$1005</b>	<b>\$202</b>
----------	----------------	-----	-------	---------------	--------------

Box/file pedestal on **right** with lock. Grommet in worksurface. Shipped assembled in 1 carton.

- Reception desk components are only designed to be used together. Do not specify with standard Adaptabilities components.
- *Cannot be used with Divide.*
- **Cannot accept keyboard trays or pencil tray.**

A2442KRL	42 x 24 x 29.6	83	3.8	<b>\$710</b>	<b>\$202</b>
----------	----------------	----	-----	--------------	--------------

**No pedestal.** Grommet in worksurface. Shipped easy to assemble in 1 carton.

- Reception desk components are only designed to be used together. Do not specify with standard Adaptabilities components.
- *Cannot be used with Divide.*

A2442KRR	42 x 24 x 29.6	83	3.8	<b>\$710</b>	<b>\$202</b>
----------	----------------	----	-----	--------------	--------------

**No pedestal.** Grommet in worksurface. Shipped easy to assemble in 1 carton.

- Reception desk components are only designed to be used together. Do not specify with standard Adaptabilities components.
- *Cannot be used with Divide.*

## TRANSACTION COUNTERS

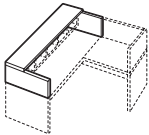

**Transaction Counter**

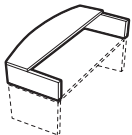

**Bow Front Transaction Counter**

A3072URD	72 x 29.69 x 13.75	67	4.3	<b>\$636</b>	<b>\$188</b>
----------	--------------------	----	-----	--------------	--------------

For main reception desk. Depth of reception top is 12". Shipped easy to assemble in 1 carton.

- Reception top units are to be used only with lower reception units. Tops have mini-fix fasteners to attach the reception top units.

A3072URB	72 x 29.69-36 x 13.75	72	4.3	<b>\$887</b>	<b>\$253</b>
----------	-----------------------	----	-----	--------------	--------------

For main reception desk. To be used on A3072RD, A3072RDL or A3072RDR. Depth of reception bow top is 12-15". Shipped easy to assemble in 1 carton.

- Reception top units are to be used only with desks listed. Tops have mini-fix fasteners to attach the reception top units.

### Required specifications

Top finish  
Base finish  
Edge detail

### Optional specifications

Additional grommet position\*  
HP laminate\*  
Power block cut-out\*

### Accessories

Power block\*  
Keyboard tray\*  
Pencil tray\*



**RETURN SCREEN UNITS**

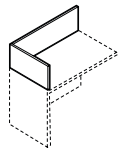

**Return Screen Unit - LEFT**

MODEL #	DIMENSIONS	WT/LB.	CUBIC FT.	LIST PRICE	HP ADD
<b>W x D x H</b>					
A2442URL	42 x 24 x 12.75	27	2	<b>\$303</b>	N/A

To be used on top of **left** reception return (A2442RRL/KRL). Shipped easy to assemble in 1 carton.  
 • Reception top units are to be used only with returns listed. Tops have mini-fix fasteners to attach the reception top units.

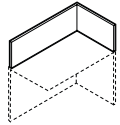

**Return Screen Unit - RIGHT**

A2442URR	42 x 24 x 12.75	27	2	<b>\$303</b>	N/A
----------	-----------------	----	---	--------------	-----

To be used on top of **right** reception return (A2442RRR/KRR). Shipped easy to assemble in 1 carton.  
 • Reception top units are to be used only with returns listed. Tops have mini-fix fasteners to attach the reception top units.

**DESK TOP ORGANIZER**

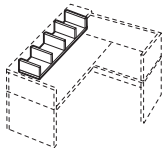

**Desk Top Organizer**

A1172ORD	52 x 11 x 6	22	2.6	<b>\$174</b>	N/A
----------	-------------	----	-----	--------------	-----

To be used under transaction counter. Black finish only. There are no specifications for Desk Top Organizer. Shipped easy to assemble in 1 carton.

**WALL/PANEL MOUNT OVERSTORAGE UNITS**

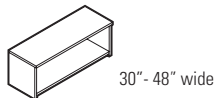
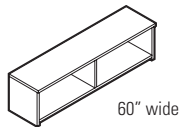

**Overstorage Unit\***

A00S60	60 x 15 x 16	86	5.25	<b>\$794</b>	N/A
A00S48	48 x 15 x 16	70	4.3	<b>\$649</b>	N/A
A00S42	42 x 15 x 16	62	3.8	<b>\$636</b>	N/A
A00S36	36 x 15 x 16	56	3.3	<b>\$563</b>	N/A
A00S30	30 x 15 x 16	48	3	<b>\$532</b>	N/A

Standard with pre-mounted "J" bracket for wall mount applications. One fixed shelf, closed back. Uses standard Adaptabilities hutch doors. 30" to 48" wide units are without center divider. Shipped easy to assemble in 1 carton.  
 • **NOTE:** Care should be taken to mount the units. Units should be mounted to wall studs using correct fasteners. Failure to do so may result in collapse of the unit and subsequent personal injury. **Mounting hardware not included.** Mounting hardware used should be based on wall material. Consult an installation professional for proper wall mounting.

**Required specifications**

Top finish  
 Base finish\*  
 Edge detail\*

**Optional specifications**

Doors\*

# A ADAPTABILITIES®

## OPEN HUTCHES

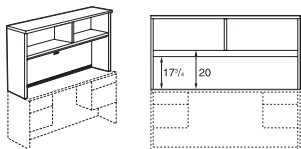

Open Hutch with Closed Back\*

MODEL #	DIMENSIONS W x D x H	WT/LB.	CUBIC FT.	LIST PRICE	HP ADD
A72HOCB	72 x 15 x 36	175	28.25	<b>\$1116</b>	N/A
A71HOCB	71.69 x 15 x 36	175	28.25	<b>\$1116</b>	N/A
A66HOCB	66 x 15 x 36	164	26	<b>\$951</b>	N/A
A60HOCB	60 x 15 x 36	151	23.75	<b>\$887</b>	N/A

One fixed shelf and fixed shelf divider. Closed back features a grommet and flexible sweep for wire management. **A71HOCB** for use when spanning 30" x 60/66" SPL/R and 20/24" x 42" FL/FR/L4/R4.

Shipped assembled in 1 carton.

- Clearance from worksurface to valance is 17.75"; clearance from worksurface to hutch doors is 20".
- Woodgrain runs horizontal on both the upper and lower back panels.

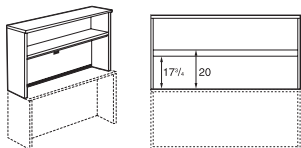

Open Hutch with Closed Back\*

A48HOCB	48 x 15 x 36	124	19	<b>\$809</b>	N/A
A42HOCB	42 x 15 x 36	111	16.75	<b>\$729</b>	N/A
A36HOCB	36 x 15 x 36	99	14.5	<b>\$673</b>	N/A
A30HOCB	30 x 15 x 36	88	12.25	<b>\$618</b>	N/A

One fixed shelf. Closed back features a grommet and flexible sweep for wire management. Shipped assembled in 1 carton.

- Clearance from worksurface to valance is 17.75"; clearance from worksurface to hutch doors is 20".
- Woodgrain runs horizontal on both the upper and lower back panels.

## PIGEON-HOLE STORAGE

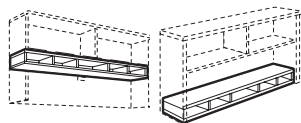

Horizontal Pigeon-Hole Storage

AHS72	70 x 11.25 x 5.62	41	3	<b>\$668</b>	N/A
AHS71	69 x 11.25 x 5.62	41	3	<b>\$698</b>	N/A
AHS66	64 x 11.25 x 5.62	38	2.8	<b>\$668</b>	N/A
AHS60	58 x 11.25 x 5.62	35	2.5	<b>\$550</b>	N/A
AHS48	46 x 11.25 x 5.62	28	2	<b>\$399</b>	N/A
AHS42	40 x 11.25 x 5.62	24	2	<b>\$399</b>	N/A
AHS36	34 x 11.25 x 5.62	22	2	<b>\$327</b>	N/A

For additional storage. Can be **top** or **bottom** mounted. For use inside hutch. Shipped easy to assemble in 1 carton.

- **Cannot be used on A00S and C00S overstorage units.**
- Black finish is standard. Brushed Cobalt (**BRC**) is available at no charge, please specify.

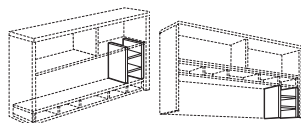

Vertical Pigeon-Hole Storage

AVS14	13.37 x 11.25 x 14.37	13	0.9	<b>\$419</b>	N/A
-------	-----------------------	----	-----	--------------	-----

For use in conjunction with horizontal pigeon-hole storage. Can be used under or over horizontal unit. Shipped easy to assemble in 1 carton.

- Black finish is standard. Brushed Cobalt (**BRC**) is available at no charge, please specify.

## CORNER HUTCHES



Corner Hutch with Closed Back\*

A42CH	42 x 15 x 36	144	6.25	<b>\$1300</b>	N/A
A36CH	36 x 15 x 36	125	4.8	<b>\$1164</b>	N/A

One fixed shelf. Closed back features a grommet in both back panels and flexible sweep for wire management. Shipped easy to assemble in 1 carton.

- Woodgrain runs horizontal on both the upper and lower back panels.

### Required specifications

Top finish\*  
Base finish\*  
Edge detail

**CORNER HUTCHES**      **MODEL #**      **DIMENSIONS**      **WT/LB.**      **CUBIC FT.**      **LIST PRICE**      **HP ADD**

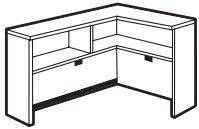

**Corner Hutch with Closed Back - RIGHT**

	W x D x H					
A3672CHR	36-72 x 15 x 36	186	7	<b>\$1532</b>	N/A	
A3666CHR	36-66 x 15 x 36	177	7	<b>\$1518</b>	N/A	

One fixed shelf and shelf divider on **left** side. Closed back features a grommet in both back panels and flexible sweep for wire management on the left side. Shipped easy to assemble in 1 carton.

- Woodgrain runs horizontal on both the upper and lower back panels.

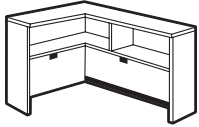

**Corner Hutch with Closed Back - LEFT**

A3672CHL	36-72 x 15 x 36	186	7.25	<b>\$1532</b>	N/A	
A3666CHL	36-66 x 15 x 36	177	7.25	<b>\$1518</b>	N/A	

One fixed shelf and shelf divider on **right** side. Closed back features a grommet in both back panels and flexible sweep for wire management on the right side. Shipped easy to assemble in 1 carton.

- Woodgrain runs horizontal on both the upper and lower back panels.

**HUTCH DOORS**

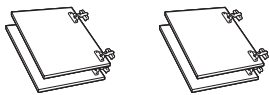

**Four-Door Kit**

ADOOR72	17.75 x 0.69 x 15	25	1.8	<b>\$454</b>	N/A	
ADOOR71	17.12 x 0.69 x 15	25	1.8	<b>\$454</b>	N/A	
ADOOR66	16.75 x 0.69 x 15	24	1.8	<b>\$454</b>	N/A	
ADOOR60	14.75 x 0.69 x 15	22	1.8	<b>\$454</b>	N/A	

For use on 72", 71", 66" and 60"W straight hutches. Hinges included. Locks available. **Add \$238** for locks. Doors for units 60" wide or more require two locks. Shipped easy to assemble, 1 kit per carton.

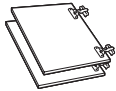

**Two-Door Kit**

ADOOR48	23.5 x 0.69 x 15	18	1.8	<b>\$272</b>	N/A	
ADOOR42	20.5 x 0.69 x 15	17	1.8	<b>\$272</b>	N/A	
ADOOR36	17.5 x 0.69 x 15	15	1.8	<b>\$272</b>	N/A	
ADOOR30	14.5 x 0.69 x 15	13	1.8	<b>\$272</b>	N/A	

For use on 48", 42", 36" and 30"W straight hutches. Hinges included. Locks available. **Add \$119** for the lock. Doors for units 48" wide or less require one lock. Shipped easy to assemble, 1 kit per carton.

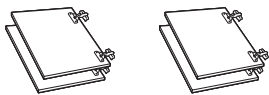

**Corner Hutch Four-Door Kit**

ADOOR72C	56.5 x 0.69 x 15	27	1.8	<b>\$484</b>	N/A	
ADOOR66C	50.5 x 0.69 x 15	25	1.8	<b>\$484</b>	N/A	

For use on 72" and 66"W corner hutches. Hinges included. Locks not available on corner hutch doors. Shipped easy to assemble, 1 kit per carton.

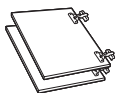

**Corner Hutch Two-Door Kit**

ADOOR42C	26.5 x 0.69 x 15	20	1.8	<b>\$454</b>	N/A	
ADOOR36C	21.5 x 0.69 x 15	17	1.8	<b>\$290</b>	N/A	

For use on 42" and 36"W corner hutches. Hinges included. Locks not available on corner hutch doors. Shipped easy to assemble, 1 kit per carton.

**Required specifications**

- Top/door finish
- Base finish (hutches only)
- Edge detail (hutches only)

## TACKBOARDS FOR HUTCHES

**NOTES:** Tackboards can be upholstered in all of the following fabrics:

- Anchorage
- Global seating fabrics\*
- Lola
- Merge

For a custom size tackboard that is less than 82"W x 21"H, price = next size up plus 10%.  
ie: ATB4921: next size up - ATB5821 plus 10%.

\* Contact Customer Service for pricing.

### TACKBOARDS FOR HUTCHES

MODEL #	DIMENSIONS	WT/LB.	CUBIC FT.	LIST PRICE
---------	------------	--------	-----------	------------

W x D x H

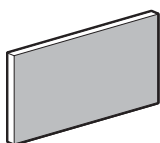

Tackboard

ATB7016	70 x 1 x 15	7	1.3	<b>\$367</b>
---------	-------------	---	-----	--------------

For use on **A72HOCB** straight hutch. Includes mounting screws and covers.

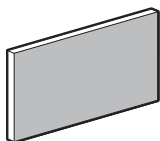

Tackboard

ATB6916	69.5 x 1 x 15	7	1.3	<b>\$367</b>
---------	---------------	---	-----	--------------

For use on **A71HOCB** straight hutch. Includes mounting screws and covers.

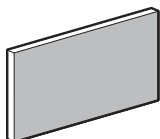

Tackboard

ATB6416	64 x 1 x 15	6.4	1.3	<b>\$356</b>
---------	-------------	-----	-----	--------------

For use on **A66HOCB** straight hutch. Includes mounting screws and covers.

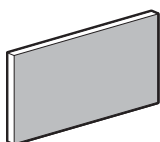

Tackboard

ATB5816	58 x 1 x 15	5.8	1.08	<b>\$347</b>
---------	-------------	-----	------	--------------

For use on **A60HOCB** straight hutch. Includes mounting screws and covers.

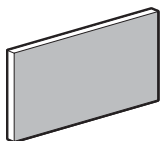

Tackboard

ATB4616	46 x 1 x 15	4.6	0.85	<b>\$338</b>
---------	-------------	-----	------	--------------

For use on **A48HOCB** straight hutch. Includes mounting screws and covers.

#### Required specifications

Fabric

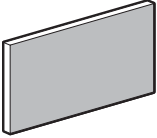
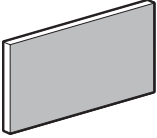
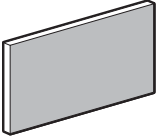
TACKBOARDS FOR HUTCHES	MODEL #	DIMENSIONS	WT/LB.	CUBIC FT.	LIST PRICE
 <b>Tackboard</b>		<b>W x D x H</b>			
	ATB4016	40 x 1 x 15	4	0.85	<b>\$322</b>
	For use on <b>A42HOCB</b> straight hutch. Includes mounting screws and covers.				
 <b>Tackboard</b>	ATB3416	34 x 1 x 15	3.4	0.85	<b>\$214</b>
	For use on <b>A36HOCB</b> straight hutch. Includes mounting screws and covers.				
 <b>Tackboard</b>	ATB2816	28 x 1 x 15	2.8	0.85	<b>\$200</b>
	For use on <b>A30HOCB</b> straight hutch. Includes mounting screws and covers.				

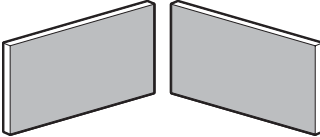
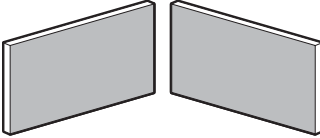
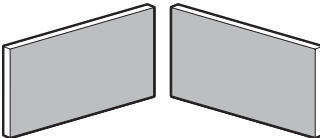
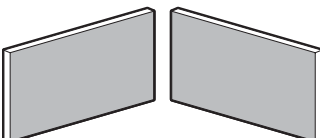
TACKBOARDS FOR CORNER HUTCHES	MODEL #	DIMENSIONS	WT/LB.	CUBIC FT.	LIST PRICE
 <b>Tackboard</b>	ATB72CH	33-72 x 1 x 15	9.94	1.3	<b>\$583</b>
	For use on <b>A3672CHR/L corner</b> hutch. Includes mounting screws and covers.				
 <b>Tackboard</b>	ATB66CH	33-64 x 1 x 15	9.4	1.3	<b>\$570</b>
	For use on <b>A3666CHR/L corner</b> hutch. Includes mounting screws and covers.				
 <b>Tackboard</b>	ATB42CH	39-40 x 1 x 15	7.7	0.85	<b>\$454</b>
	For use on <b>A42CH corner</b> hutch. Includes mounting screws and covers.				
 <b>Tackboard</b>	ATB36CH	33-34 x 1 x 15	6.6	0.85	<b>\$428</b>
	For use on <b>A36CH corner</b> hutch. Includes mounting screws and covers.				

**Required specifications**  
Fabric

# A ADAPTABILITIES®

## WALL MOUNTED TACKBOARDS

MODEL #      DIMENSIONS      WT/LB.      CUBIC FT.      LIST PRICE

W x D x H

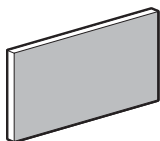

Wall Mounted Tackboard

AWHT3019	30 x 1.25 x 19	6.3	1	<b>\$238</b>
----------	----------------	-----	---	--------------

For use under **A00S30** overstorage unit. Standard with pre-mounted “J” bracket for wall mount applications. There will be a 1.75” clearance between the top of the tackboard and bottom of the overhead, and a .25” clearance between the bottom of the tackboard and the worksurface.

- **NOTE:** Care should be taken to mount the units. Units should be mounted to wall studs using correct fasteners. Failure to do so may result in collapse of the unit and subsequent personal injury. Mounting hardware not included. Mounting hardware used should be based on wall material. Consult an installation professional for proper wall mounting.

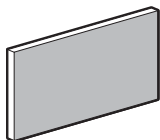

Wall Mounted Tackboard

AWHT3619	36 x 1.25 x 19	7.6	1	<b>\$272</b>
----------	----------------	-----	---	--------------

For use under **A00S36** overstorage unit. Standard with pre-mounted “J” bracket for wall mount applications. There will be a 1.75” clearance between the top of the tackboard and bottom of the overhead, and a .25” clearance between the bottom of the tackboard and the worksurface.

- **NOTE:** Care should be taken to mount the units. Units should be mounted to wall studs using correct fasteners. Failure to do so may result in collapse of the unit and subsequent personal injury. Mounting hardware not included. Mounting hardware used should be based on wall material. Consult an installation professional for proper wall mounting.

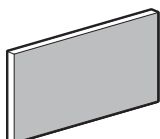

Wall Mounted Tackboard

AWHT4219	42 x 1.25 x 19	8.9	1	<b>\$403</b>
----------	----------------	-----	---	--------------

For use under **A00S42** overstorage unit. Standard with pre-mounted “J” bracket for wall mount applications. There will be a 1.75” clearance between the top of the tackboard and bottom of the overhead, and a .25” clearance between the bottom of the tackboard and the worksurface.

- **NOTE:** Care should be taken to mount the units. Units should be mounted to wall studs using correct fasteners. Failure to do so may result in collapse of the unit and subsequent personal injury. Mounting hardware not included. Mounting hardware used should be based on wall material. Consult an installation professional for proper wall mounting.

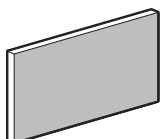

Wall Mounted Tackboard

AWHT4819	48 x 1.25 x 19	10.1	1	<b>\$419</b>
----------	----------------	------	---	--------------

For use under **A00S48** overstorage unit. Standard with pre-mounted “J” bracket for wall mount applications. There will be a 1.75” clearance between the top of the tackboard and bottom of the overhead, and a .25” clearance between the bottom of the tackboard and the worksurface.

- **NOTE:** Care should be taken to mount the units. Units should be mounted to wall studs using correct fasteners. Failure to do so may result in collapse of the unit and subsequent personal injury. Mounting hardware not included. Mounting hardware used should be based on wall material. Consult an installation professional for proper wall mounting.

**Required specifications**

Fabric

**WALL MOUNTED TACKBOARDS**      **MODEL #**      **DIMENSIONS**      **WT/LB.**      **CUBIC FT.**      **LIST PRICE**

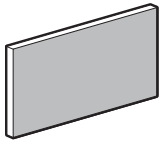

**Wall Mounted Tackboard\***

W x D x H					
AWHT6019	60 x 1.25 x 19	12.7	1.8		<b>\$434</b>

For use under **A00S60** overstorage unit. Standard with pre-mounted "J" bracket for wall mount applications. There will be a 1.75" clearance between the top of the tackboard and bottom of the overhead, and a .25" clearance between the bottom of the tackboard and the worksurface.

- **NOTE:** Care should be taken to mount the units. Units should be mounted to wall studs using correct fasteners. Failure to do so may result in collapse of the unit and subsequent personal injury. Mounting hardware not included. Mounting hardware used should be based on wall material. Consult an installation professional for proper wall mounting.

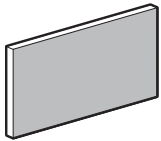

**Wall Mounted Tackboard\***

AWHT6619	66 x 1.25 x 19	13.9	1.8		<b>\$443</b>
AWHT7219	72 x 1.25 x 19	15.2	1.8		<b>\$458</b>
AWHT7819	78 x 1.25 x 19	16.5	1.8		<b>\$548</b>
AWHT8419	84 x 1.25 x 19	17.7	1.8		<b>\$642</b>

For use under **multiple** Adaptabilities wall mounted overstorage units. Standard with pre-mounted "J" bracket for wall mount applications. There will be a 1.75" clearance between the top of the tackboard and bottom of the overhead, and a .25" clearance between the bottom of the tackboard and the worksurface.

- **NOTE:** Care should be taken to mount the units. Units should be mounted to wall studs using correct fasteners. Failure to do so may result in collapse of the unit and subsequent personal injury. Mounting hardware not included. Mounting hardware used should be based on wall material. Consult an installation professional for proper wall mounting.

**ACCESSORY PIECES**



**Mixed Drawer Cabinet - LEFT\*\***

A2036MDL	36 x 20 x 29.6	162	15.5		<b>\$2140</b>
A2436MDL	36 x 24 x 29.6	176	18.25		<b>\$2169</b>

Two box drawers on **right**, one file drawer on **left** and one lateral file drawer on bottom. File on lateral file drawers locking. 1 pencil tray. Front-to-back filing bars. Shipped assembled in 1 carton.

- MUST specify Black (**HX**) or Silver (**HS**) finish for handles.
- *File drawer construction is for accommodating hanging files NOT for stacking materials on the drawer bottom.*



**Mixed Drawer Cabinet - RIGHT\*\***

A2036MDR	36 x 20 x 29.6	162	15.5		<b>\$2140</b>
A2436MDR	36 x 24 x 29.6	176	18.25		<b>\$2169</b>

Two box drawers on **left**, one file drawer on **right** and one lateral file drawer on bottom. File on lateral file drawers locking. 1 pencil tray. Front-to-back filing bars. Shipped assembled in 1 carton.

- MUST specify Black (**HX**) or Silver (**HS**) finish for handles.
- *File drawer construction is for accommodating hanging files NOT for stacking materials on the drawer bottom.*

**Required specifications**

Fabric\*  
Top finish\*\*  
Handle finish  
Base finish

**Optional specifications**

Edge  
Key # (not tackboards)

# A ADAPTABILITIES®

## ACCESSORY PIECES

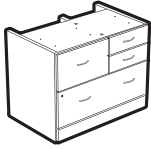

Mixed Drawer Cabinet Shell - LEFT



Mixed Drawer Cabinet Shell - RIGHT

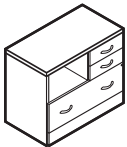

Mixed Storage Cabinet\*



2 Drawer Lateral File\*

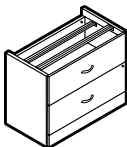

2 Drawer Lateral File Shell

MODEL #	DIMENSIONS W x D x H	WT/LB.	CUBIC FT.	LIST PRICE	HP ADD
A2036MDLS	36 x 19.25 x 28.6	137	15	<b>\$2119</b>	N/A
A2436MDLS	36 x 23.25 x 28.6	150	18	<b>\$2150</b>	N/A

For use **under 29"H limited single pedestal desks, workstations or limited single pedestal credenzas. Unfinished top, no back.** Two box drawers on right, one file drawer on left and one lateral file drawer on bottom. File and lateral file drawers locking. 1 pencil tray. Front-to-back filing bars. Shipped assembled in 1 carton.

- MUST specify Black (**HX**) or Silver (**HS**) finish for handles.
- File drawer construction is for accommodating hanging files **NOT** for stacking materials on the drawer bottom.
- For 24" deep worksurfaces, order **A2436MDLS**. For 20" deep worksurfaces, order **A2036MDLS**.

A2036MDRS	36 x 19.25 x 28.6	137	15	<b>\$2119</b>	N/A
A2436MDRS	36 x 23.25 x 28.6	150	18	<b>\$2150</b>	N/A

For use **under 29"H limited single pedestal desks, workstations or limited single pedestal credenzas. Unfinished top, no back.** Two box drawers on left, one file drawer on right and one lateral file drawer on bottom. File and lateral file drawers locking. 1 pencil tray. Front-to-back filing bars. Shipped assembled in 1 carton.

- MUST specify Black (**HX**) or Silver (**HS**) finish for handles.
- File drawer construction is for accommodating hanging files **NOT** for stacking materials on the drawer bottom.
- For 24" deep worksurfaces, order **A2436MDRS**. For 20" deep worksurfaces, order **A2036MDRS**.

A2436MSC	36 x 24 x 29.6	163	18.25	<b>\$1520</b>	<b>\$152</b>
A2036MSC	36 x 20 x 29.6	147	15.5	<b>\$1500</b>	<b>\$152</b>

Features open storage compartment with access grommet on back. 2 box drawers and 1 lateral file drawer, all locking. 1 pencil tray. Front-to-back filing bars. Shipped assembled in 1 carton.

- MUST specify Black (**HX**) or Silver (**HS**) finish for handles.
- File drawer construction is for accommodating hanging files **NOT** for stacking materials on the drawer bottom.

A2036LF	36 x 20 x 29.6	145	15.5	<b>\$1196</b>	<b>\$152</b>
---------	----------------	-----	------	---------------	--------------

Two full suspension drawers. Front-to-back and side-to-side letter/legal filing capability with lock. Anti-lock tilt suspension. Shipped assembled in 1 carton.

- MUST specify Black (**HX**) or Silver (**HS**) finish for handles.
- File drawer construction is for accommodating hanging files **NOT** for stacking materials on the drawer bottom.

A2436S2	36 x 24 x 28.6	114	18	<b>\$1666</b>	N/A
A2036S2	36 x 20 x 28.5	104	14.75	<b>\$1666</b>	N/A

For use **under 29"H limited single pedestal desks, workstations or limited single pedestal credenzas. No top or back.** Two full suspension locking drawers with **steel drawer interior**. Side-to-side file bars included. Anti-lock tilt suspension. Shipped assembled in 1 carton.

- MUST specify Black (**HX**) or Silver (**HS**) finish for handles.
- For 24" deep worksurfaces, order **A2436S2**. For 20" deep worksurfaces, order **A2036S2**.
- For front-to-back file bars order **FBB**; see page 42.



### Required specifications

Top finish (not shells)  
Base finish  
Handles  
Edge detail\*

### Optional specifications

Key #  
HP laminate (not shells)

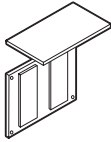

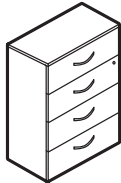
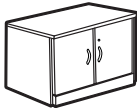
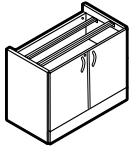
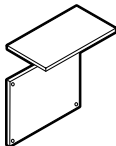
ACCESSORY PIECES	MODEL #	DIMENSIONS	WT/LB.	CUBIC FT.	LIST PRICE	HP ADD
 <p><b>2 Drawer Lateral File Top and Back</b></p>		<b>W x D x H</b>				
	ALF24TB	36 x 24 x 29.6	82	3.3	<b>\$569</b>	<b>\$188</b>
	ALF20TB	36 x 20 x 29.6	78	3.3	<b>\$569</b>	<b>\$188</b>
<p>For use with lateral file shell. Counterweights included. Shipped easy to assemble in 1 carton.</p> <ul style="list-style-type: none"> <li>• Use <b>ALF24TB</b> for model A2436S2. Use <b>ALF20TB</b> for model A2036S2.</li> </ul>						
 <p><b>3 Drawer Lateral File</b></p>	A2036S3	36 x 20 x 37.75	219	20	<b>\$2396</b>	<b>\$152</b>
	<p>Three full suspension locking drawers with <b>steel drawer interior</b>. Steel drawer construction includes metal sides and masonite bottoms. Side-to-side file bars included. Includes anti-tip interlock feature. Shipped assembled in 1 carton.</p> <ul style="list-style-type: none"> <li>• MUST specify Black (<b>HX</b>) or Silver (<b>HS</b>) finish for handles.</li> <li>• For front-to-back file bars order <b>FBB</b>; see page 42.</li> </ul>					
 <p><b>4 Drawer Lateral File</b></p>	A2036S4	36 x 20 x 49.5	267	25.75	<b>\$3017</b>	<b>\$152</b>
	<p>Four full suspension locking drawers with <b>steel drawer interior</b>. Steel drawer construction includes metal sides and masonite bottoms. Side-to-side file bars included. Includes anti-tip interlock feature. Shipped assembled in 1 carton.</p> <ul style="list-style-type: none"> <li>• MUST specify Black (<b>HX</b>) or Silver (<b>HS</b>) finish for handles.</li> <li>• For front-to-back file bars order <b>FBB</b>; see page 42.</li> </ul>					
 <p><b>Storage Cabinet</b></p>	A2036SC	36 x 20 x 29.6	121	15.5	<b>\$983</b>	<b>\$152</b>
	<p>Self-closing hinged doors cover one adjustable shelf. Standard with lock. Shipped assembled in 1 carton.</p> <ul style="list-style-type: none"> <li>• MUST specify Black (<b>HX</b>) or Silver (<b>HS</b>) finish for handles.</li> </ul>					
 <p><b>Storage Cabinet Shell</b></p>	A2436SCS	36 x 23.25 x 28.6	106	18	<b>\$964</b>	N/A
	A2036SCS	36 x 19.25 x 28.6	91	14.75	<b>\$964</b>	N/A
<p>For use <b>under 29"H limited single pedestal desks, workstations or limited single pedestal credenzas. No top or back</b>. Self-closing hinged doors cover one adjustable shelf. Standard with lock. Shipped assembled in 1 carton.</p> <ul style="list-style-type: none"> <li>• MUST specify Black (<b>HX</b>) or Silver (<b>HS</b>) finish for handles.</li> <li>• For 24" deep worksurfaces, order <b>A2436SCS</b>. For 20" deep worksurfaces, order <b>A2036SCS</b>.</li> </ul>						
 <p><b>Storage Cabinet Top and Back*</b></p>	ASC24TB	36 x 24 x 29.6	49	3.3	<b>\$512</b>	<b>\$188</b>
	ASC20TB	36 x 20 x 29.6	45	3.3	<b>\$512</b>	<b>\$188</b>
<p>For use with <b>Storage Cabinet Shell</b>. Shipped easy to assemble in 1 carton.</p> <ul style="list-style-type: none"> <li>• Use <b>ASC24TB</b> for model A2436SCS/MSCS; use <b>ASC20TB</b> for model A2036SCS/MSCS.</li> </ul>						

**Required specifications**

Top finish (not shells)  
 Base finish  
 Handles  
 Edge (not A2xxxSCS)

**Optional specifications**

Key #  
 HP laminate

# A ADAPTABILITIES®

## ACCESSORY PIECES

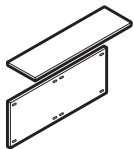

**Credenza Top and Back\***

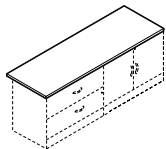

**Credenza Top\***

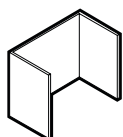

**Kneespace Module**

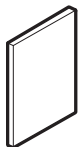

**Full Leg**



**Personal Tower\***

MODEL #	DIMENSIONS W x D x H	WT/LB.	CUBIC FT.	LIST PRICE	HP ADD
A2472TB	72 x 24 x 29.6	95	6	<b>\$907</b>	<b>\$314</b>
A2072TB	72 x 20 x 29.6	87	6	<b>\$907</b>	<b>\$314</b>

For use with the following: **two lateral file shells**, or **two storage cabinet shells**, or **two mixed storage cabinet shells**, or any combination. May also be used with **one lateral file shell plus one full leg**, or one **storage cabinet/mixed storage cabinet shell plus one full leg**. Shipped easy to assemble in 1 carton.

- For 24" deep worksurfaces, order **A2472TB**. For 20" deep worksurfaces, order **A2072TB**.

A2472CT	72 x 24 x 1	52	1.9	<b>\$395</b>	<b>\$325</b>
A2072CT	72 x 20 x 1	44	1.9	<b>\$320</b>	<b>\$314</b>

For use with the following: **two lateral file shells**, or **two storage cabinet shells**, or **two mixed storage cabinet shells**, or any combination. May also be used with **one lateral file shell plus one full leg**, or one **storage cabinet/mixed storage cabinet shell plus one full leg**. Shipped easy to assemble in 1 carton.

- For 24" deep worksurfaces, order **A2472CT**. For 20" deep worksurfaces, order **A2072CT**.

A2036KM	36 x 19 x 28.6	54	3.3	<b>\$419</b>	N/A
---------	----------------	----	-----	--------------	-----

For use with lateral file/credenza top and storage cabinet/credenza top combinations. Shipped easy to assemble in 1 carton.

- *Not designed to be used with a flush bridge.*

A24FL	1 x 24 x 28.6	20	1.7	<b>\$309</b>	N/A
A20FL	1 x 20 x 28.6	16	0.6	<b>\$309</b>	N/A

For use at **either end of A24/2072TB credenza top and back** to create a kneespace. Non-handed; can be used left or right. Shipped easy to assemble in 1 carton.

- For 24" deep worksurfaces, order **A24FL**. For 20" deep worksurfaces, order **A20FL**.

A24PTFF	24 x 24 x 65.5	219	27	<b>\$2607</b>	N/A
A20PTFF	24 x 20 x 65.5	198	22.75	<b>\$2607</b>	N/A

Includes 7" wardrobe section with a hanging rod; storage section with one adjustable shelf; and file section with **two file drawers**. Locks are keyed alike. Upper lock secures wardrobe and storage section. Lower lock secures both file drawers. Shipped assembled in 1 carton.

- MUST specify Black (**HX**) or Silver (**HS**) finish for handles.

### Required specifications

Top finish  
Base finish  
Handles (only personal towers)  
Edge detail\*

### Optional specifications

Key # (not credenzas or full leg)  
HP laminate (tops and backs)

**ACCESSORY PIECES**      **MODEL #**      **DIMENSIONS**      **WT/LB.**      **CUBIC FT.**      **LIST PRICE**      **HP ADD**



**Personal Tower**

	W x D x H					
A24PTBBF	24 x 24 x 65.5	213	27	<b>\$2607</b>	N/A	
A20PTBBF	24 x 20 x 65.5	193	22.75	<b>\$2607</b>	N/A	

Includes 7" wardrobe section with a hanging rod; storage section with one adjustable shelf; and file section with **box/box/file drawers**. Locks are keyed alike. Upper lock secures wardrobe and storage section. Lower lock secures all drawers. Shipped assembled in 1 carton.

- MUST specify Black (**HX**) or Silver (**HS**) finish for handles.



**Vertical Storage/Lateral File Cabinet**

A3665VSL	36 x 20 x 65.5	273	33	<b>\$2050</b>	N/A	
----------	----------------	-----	----	---------------	-----	--

Contains storage area with one adjustable shelf behind a self-closing hinged door, plus two full suspension file drawers. Lateral file drawers lock. Shipped assembled in 1 carton.

- *File drawer construction is for accommodating hanging files NOT for stacking materials on the drawer bottom.*
- MUST specify Black (**HX**) or Silver (**HS**) finish for handles.



**Storage Wardrobe Cabinet**

A2436DI	36 x 24 x 65.5	270	12	<b>\$2359</b>	N/A	
A3665DI	36 x 20 x 65.5	240	12	<b>\$2036</b>	N/A	

Includes 16" hanging rod on one side and four adjustable shelves on the other. Lock. Shipped easy to assemble in 1 carton.

- MUST specify Black (**HX**) or Silver (**HS**) finish for handles.

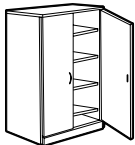

**Storage Cabinet**

A2436SH	36 x 24 x 65.5	296	12	<b>\$2451</b>	N/A	
A3665SH	36 x 20 x 65.5	261	12	<b>\$2130</b>	N/A	

Includes four adjustable shelves. Lock. Shipped easy to assemble in 1 carton.

- MUST specify Black (**HX**) or Silver (**HS**) finish for handles.

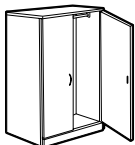

**Wardrobe Cabinet**

A2436ROD	36 x 24 x 65.5	220	12	<b>\$2308</b>	N/A	
A3665ROD	36 x 20 x 65.5	199	12	<b>\$1988</b>	N/A	

Includes full width hanging rod. Lock. Shipped easy to assemble in 1 carton.

- MUST specify Black (**HX**) or Silver (**HS**) finish for handles.

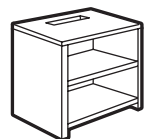

**Printer Table**

A2430PT	30 x 24 x 29.6	108	4.3	<b>\$747</b>	<b>\$152</b>	
---------	----------------	-----	-----	--------------	--------------	--

Includes two fixed shelves, cut-back top shelf allows paper to fall onto lower shelf. Shipped easy to assemble in 1 carton.

**Required specifications**

Top finish  
Base finish  
Handles  
Edge detail

**Optional specifications**

Key #  
HP laminate (only printer table)

# A ADAPTABILITIES®

## ACCESSORY PIECES



Magazine Table\*

MODEL #	DIMENSIONS W x D x H	WT/LB.	CUBIC FT.	LIST PRICE	HP ADD
A2248MT	48 x 22 x 18.5	61	4.3	<b>\$499</b>	<b>\$213</b>
A2222MT	22 x 22 x 18.5	40	3	<b>\$415</b>	<b>\$113</b>

Shipped easy to assemble in 1 carton.

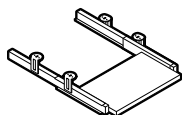

Pull-Out Keyboard

APOKL28	28 x 17 x 3.5	13	0.9	<b>\$296</b>	N/A
APOKL22	22 x 17 x 3.5	22	0.9	<b>\$270</b>	N/A

Constructed of thermally fused laminate. **APOKL28** will accommodate keyboard and mouse pad. **APOKL28** will only fit on a single pedestal desk, freestanding table, or **A42205C**. Please specify color from available finishes listed on page 11.

- **APOKL28** will not fit extended corners or **A42245C**, **A36205C** 5-sided corners.

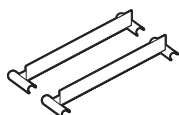

Front-to-Back File Bars

FBB	15.5 x - x -	1	0.1	<b>\$24</b>	N/A
-----	--------------	---	-----	-------------	-----

Includes two bars. Standard in **EFC** (environmentally friendly color - similar to Charcoal Grey due to the use of recycled powder). Will fit Adaptabilities wood lateral file drawers. There are no specifications for File Bars.

- Not recommended for "L" opening with receding door and roll-out shelves.

## BOOKCASES

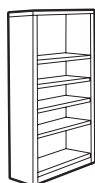

Bookcase - 72.5" High\*

ABC72	36 x 12 x 72.5	170	23	<b>\$1055</b>	N/A
-------	----------------	-----	----	---------------	-----

One fixed heavy duty shelf and **three adjustable shelves**. Shipped assembled in 1 carton.

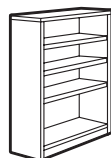

Bookcase - 65.5" High\*

ABC65	36 x 12 x 65.5	150	21	<b>\$926</b>	N/A
-------	----------------	-----	----	--------------	-----

One fixed heavy duty shelf and **two adjustable shelves**. Shipped assembled in 1 carton.

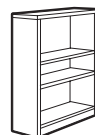

Bookcase - 48.5" High\*

ABC48	36 x 12 x 48.5	116	15.75	<b>\$867</b>	N/A
-------	----------------	-----	-------	--------------	-----

**Two adjustable shelves**. Shipped assembled in 1 carton.

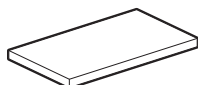

Bookcase Shelf

ABCSELF	34 x 11 x 1	14	1.5	<b>\$200</b>	N/A
---------	-------------	----	-----	--------------	-----

Extra shelf for bookcases. 1" thick.

### Required specifications

Top finish\*  
Base finish\*  
Edge detail\*

### Optional specifications

HP laminate (only magazine table)

**BOOKCASES**      **MODEL #**      **DIMENSIONS**      **WT/LB.**      **CUBIC FT.**      **LIST PRICE**      **HP ADD**

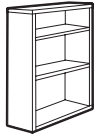

**Table Top Bookcase**

	W x D x H				
A3636TBC	36 x 15 x 36	108	14.75	<b>\$875</b>	N/A
AD00R3636	36 x 0.69 x 36	26	3	<b>\$540</b>	N/A

To be placed on top of 36"W lateral file or storage cabinet. Two adjustable shelves. Shipped assembled in 1 carton.  
 • For a set of doors, order **AD00R3636**.  
 • Locks available on AD00R3636. **Add \$119** each lock.

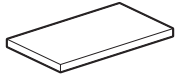

**Bookcase Shelf**

ATBC36SH	34 x 13.25 x 1	16	1.7	<b>\$260</b>	N/A
----------	----------------	----	-----	--------------	-----

Extra shelf for table top bookcases. 1" thick.

**END SHELVES**

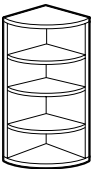

**End Shelf - 65.5" High\***

A2465ESHL	24 x 24 x 65.5	136	5	<b>\$1152</b>	N/A
A2065ESHL	20 x 20 x 65.5	113	5	<b>\$957</b>	N/A
A2465ESHR	24 x 24 x 65.5	136	5	<b>\$1152</b>	N/A
A2065ESHR	20 x 20 x 65.5	113	5	<b>\$957</b>	N/A

For use at end of **wardrobe/storage, vertical storage cabinets, and personal towers**. Four fixed shelves.  
**Specify left or right.** Shipped easy to assemble in 1 carton.  
 • For 24" deep cabinet, order **A2465ESH**. For 20" deep cabinet, order **A2065ESH**.

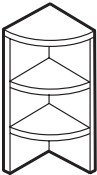

**End Shelf - 36" High\***

A1536ESHL	15 x 15 x 36	44	3.3	<b>\$458</b>	N/A
A1536ESHR	15 x 15 x 36	44	3.3	<b>\$458</b>	N/A

For use at end of **hutches**. Two fixed shelves. To be used on top of **A3029ESHL, A3029ESHR, A2429ESHL, A2429ESHR, A2029ESHL** or **A2029ESHR**. **Specify left or right.** Shipped easy to assemble in 1 carton.

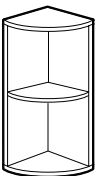

**End Shelf - 29.5" High\***

A3029ESHL	30 x 30 x 29.6	104	5.25	<b>\$820</b>	<b>\$253</b>
A2429ESHL	24 x 24 x 29.6	77	4.3	<b>\$655</b>	<b>\$126</b>
A2029ESHL	20 x 20 x 29.6	60	3.8	<b>\$558</b>	<b>\$101</b>
A3029ESHR	30 x 30 x 29.6	104	5.25	<b>\$820</b>	<b>\$253</b>
A2429ESHR	24 x 24 x 29.6	77	4.3	<b>\$655</b>	<b>\$126</b>
A2029ESHR	20 x 20 x 29.6	60	3.8	<b>\$558</b>	<b>\$101</b>

For use at end of **worksurfaces**. Two fixed shelves. **Specify left or right.** Shipped easy to assemble in 1 carton.  
 • For 30" deep worksurface, order **A3029ESH**. For 24" deep worksurface, order **A2429ESH**.  
 For 20" deep worksurface, order **A2029ESH**.

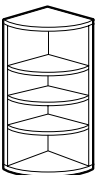

**End Shelf - 49.5" High\***

A2049ESHL	20 x 20 x 49.5	94	3.8	<b>\$902</b>	N/A
A2049ESHR	20 x 20 x 49.5	94	3.8	<b>\$902</b>	N/A

For use at end of **A2036S4 4-high lateral file**. Four fixed shelves. **Specify left or right.** Shipped easy to assemble in 1 carton.

**Required specifications**

- Top finish
- Base finish
- Edge detail\*

# A ADAPTABILITIES®

## END SHELVES

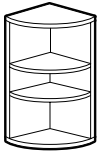

**End Shelf - 37.75" High\***

MODEL #	DIMENSIONS W x D x H	WT/LB.	CUBIC FT.	LIST PRICE	HP ADD
A2037ESHL	20 x 20 x 38.2	77	5	<b>\$655</b>	N/A
A2037ESHR	20 x 20 x 38.2	77	5	<b>\$655</b>	N/A

For use at end of **A2036S3 3-high lateral file**. Three fixed shelves. **Specify left or right.**  
Shipped easy to assemble in 1 carton.

## PEDESTALS

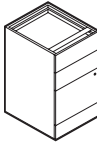

**Freestanding Pedestal\*\***

AFPBBF19	16 x 19 x 28.6	68	7.25	<b>\$1013</b>	N/A
AFPBBF22	16 x 22 x 28.6	72	8.25	<b>\$1070</b>	N/A
AFPBBF28	16 x 28 x 28.6	88	10.25	<b>\$1137</b>	N/A

For use under a freestanding worksurface (20", 24" or 30"); attaches to worksurface top. No top and unfinished back. Two box and one file drawer. One pencil tray. File drawer and lower box drawer are locking. Shipped assembled in 1 carton.

- *Cannot be used with **A2466** extended corners.*
- *When used with connectable tables bottom rear of pedestal will show because of the modesty on table units.*

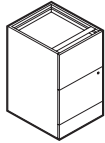

**Freestanding Pedestal\*\***

AFPFF19	16 x 19 x 28.6	67	7.25	<b>\$1092</b>	N/A
AFPFF22	16 x 22 x 28.6	75	8.25	<b>\$1150</b>	N/A
AFPFF28	16 x 28 x 28.6	89	10.25	<b>\$1235</b>	N/A

For use under a freestanding worksurface (20", 24" or 30"); attaches to worksurface top. No top and unfinished back. Two file drawers. Locking. Shipped assembled in 1 carton.

- *Cannot be used with **A2466** extended corners.*
- *When used with connectable tables bottom rear of pedestal will show because of the modesty on table units.*

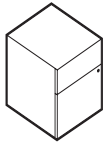

**Hanging Pedestal\*\***

AHPBF18	16 x 18 x 18	48	4.5	<b>\$832</b>	N/A
---------	--------------	----	-----	--------------	-----

For use under a freestanding worksurface (20", 24" or 30"); attaches to worksurface top. No top and unfinished back. One box and one file drawer. One pencil tray. Locking. 18" high. Shipped assembled in 1 carton.

- *Cannot be used with **A2466** extended corners.*
- *When used with connectable tables bottom rear of pedestal will show because of the modesty on table units.*



**Mobile Pedestal\*\***

AMPBBF19	16 x 19 x 28	96	6.5	<b>\$1112</b>	<b>\$202</b>
AMPBBF22	16 x 23 x 28	92	7.75	<b>\$1173</b>	<b>\$202</b>
AMPBBF28	16 x 29 x 28	105	9.5	<b>\$1240</b>	<b>\$202</b>

Pedestal on casters. Front casters lock. Fits under worksurfaces and is easily moved. Two box and one file drawer. One pencil tray. File drawer and lower box drawer are locking. Includes counterweight to prevent tipping. Shipped assembled in 1 carton.

- *Cannot be used with **A2466** extended corners.*

### Required specifications

Top finish (only end shelf and mobile ped)  
Base finish (only end shelf and mobile ped)  
Edge detail\*

### Optional specifications

Key #\*\*  
HP laminate (mobile pedestal)  
Handle\*\*

**PEDESTALS** **MODEL #** **DIMENSIONS** **WT/LB.** **CUBIC FT.** **LIST PRICE** **HP ADD**



**Mobile Pedestal\*\***

	W x D x H					
AMPFF19	16 x 19 x 28	97	6.5	<b>\$1168</b>	<b>\$202</b>	
AMPFF22	16 x 23 x 28	95	7.75	<b>\$1229</b>	<b>\$202</b>	
AMPFF28	16 x 29 x 28	106	9.5	<b>\$1312</b>	<b>\$202</b>	

Pedestal on casters. Front casters lock. Fits under worksurfaces and is easily moved. Two file drawers. Locking. Includes counterweight to prevent tipping. Shipped assembled in 1 carton.

- *Cannot be used with **A2466** extended corners.*



**Mobile Pedestal\*\***

AMPBF19	16 x 19 x 22	77	5.25	<b>\$921</b>	<b>\$202</b>	
AMPBF22	16 x 23 x 22	73	6	<b>\$981</b>	<b>\$202</b>	
AMPBF28	16 x 29 x 22	83	7.5	<b>\$1023</b>	<b>\$202</b>	

Pedestal on casters. Front casters lock. Fits under worksurfaces and is easily moved. One box and one file drawer. One pencil tray. Locking. 22" high. Includes counterweight to prevent tipping. Shipped assembled in 1 carton.

**BOARDROOM TABLES**



**Boardroom Table - Round Top\***

A48R	48 x 48 x 1.5	83	7.5	<b>\$629</b>	<b>\$440</b>	
A42R	42 x 42 x 1.5	63	5.75	<b>\$572</b>	<b>\$440</b>	
A36R	36 x 36 x 1.5	49	4.9	<b>\$372</b>	<b>\$253</b>	

- *Available with bicut edge (CR) at no upcharge, please specify.*
- **A48R** to be used with four monopost legs only (model **A5L**).
- **A42R** to be used with four monoposts (model **A5L**) or cross base (model **A2727XB**).
- **A36R** to be used with four monoposts (model **A5L**), drum base (model **A18Z**) or cross base (model **A2727XB**).



**Boardroom Table - Rectangular Top\***

A48120RE	120 x 48 x 1.5	274	13	<b>\$1260</b>	<b>\$1054</b>	
A4896RE	96 x 48 x 1.5	237	11.5	<b>\$921</b>	<b>\$877</b>	
A3672RE	72 x 36 x 1.5	116	7	<b>\$610</b>	<b>\$471</b>	

For use with two drum bases, two "V" bases, one panel base OR four monoposts. Predrilled for "V" base and panel base. **Top comes in one piece, except for A48120RE (two pieces).**

- *Available with bicut edge (CR) at no upcharge, please specify.*
- **A48120RE** uses three drum bases, three "V" bases, one double panel base OR six monoposts.



**Boardroom Table - Boat Shape Top\***

A48144B	144 x 48 x 1.5	321	15.25	<b>\$1364</b>	<b>\$1254</b>	
A48120B	120 x 48 x 1.5	274	13	<b>\$1202</b>	<b>\$1001</b>	
A4896B	96 x 48 x 1.5	221	11.5	<b>\$1040</b>	<b>\$877</b>	

For use with three drum bases, three "V" bases, one double panel base OR six monoposts. Predrilled for "V" base and panel base. **Top comes in two pieces, except for A4896B.**

- *Available with bicut edge (CR) at no upcharge, please specify.*
- **A4896B** uses two drum bases, two "V" bases, one panel base OR four monoposts.

**Required specifications**

Top finish  
Edge detail\*

**Optional specifications**

Key #\*\*  
HP laminate  
Handles\*\*

# A ADAPTABILITIES®

## BOARDROOM TABLES



**Boardroom Table - Racetrack Top\***

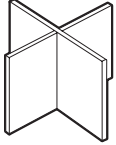

**Cross Base**

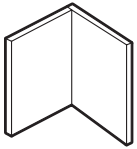

**"V" Base**

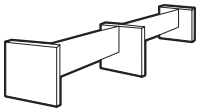

**Panel Base**

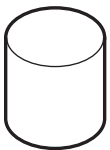

**Drum Base**



**Mono Post**

MODEL #	DIMENSIONS W x D x H	WT/LB.	CUBIC FT.	LIST PRICE	HP ADD
A48144RT	144 x 48 x 1.5	324	15.25	<b>\$1364</b>	<b>\$1254</b>
A48120RT	120 x 48 x 1.5	273	13	<b>\$1202</b>	<b>\$1001</b>
A4896RT	96 x 48 x 1.5	217	11.5	<b>\$1040</b>	<b>\$877</b>
A3672RT	72 x 36 x 1.5	104	7	<b>\$747</b>	<b>\$471</b>

For use with three drum bases, three "V" bases, one double panel base OR six monoposts. Predrilled for "V" base and panel base. **Top comes in two pieces except for A4896RT and A3672RT.**

- Available with bicut edge (CR) at no upcharge, please specify.
- **NOTE:** 48" x 120" and 48" x 144" woodgrain finish Adaptabilities tables will not have a perfect match of grain at the center where the two halves meet.
- **A4896RT and A3672RT** use two drum bases, two "V" bases, one panel base OR four monoposts.

A2727XB	27 x 27 x 29.6	63	3.6	<b>\$495</b>	N/A
---------	----------------	----	-----	--------------	-----

Use as the base for **36" or 42" round tops (model A36R or A42R)**. Shipped easy to assemble in 1 carton.

A1616V	16 x 16 x 28.6	39	2	<b>\$320</b>	N/A
A1616V2	16 x 16 x 28.6	74	3.6	<b>\$642</b>	N/A

Use as the base for **rectangular, boat shaped or racetrack tops**. Shipped easy to assemble in 1 carton.

- **A1616V2** is shipped 2 bases (1 pair) per carton.

A2488PB	88 x 24 x 29.6	119	6	<b>\$926</b>	N/A
A2445PB	45 x 24 x 28.6	76	4.3	<b>\$588</b>	N/A

Use as the base for **rectangular, boat shaped or racetrack tops**. Shipped easy to assemble in 1 carton.

- Use **A2488PB** for 120 - 144" wide tops.
- Use **A2445PB** for 72 - 96" wide tops.

A18Z	18 x 18 x 28.6	29	7.5	<b>\$913</b>	N/A
------	----------------	----	-----	--------------	-----

Use as the base for **36" round tops (model A36R) and 72", 96", 120" or 144" wide tops**. Available in **Black finish only**. There are no specifications for Drum Base.

- All drum bases require approximately 125 lb. of sand in each base for adequate stability. Sand bag not included.

A5L	5 x 5 x 28.6	12	1	<b>\$446</b>	N/A
-----	--------------	----	---	--------------	-----

Use as the base for **48" round tops (model A48R) and 72", 96", 120" or 144" wide tops**.

- Post is shipped in separate carton. MUST specify Black (TBL) or Tungsten (TTU) finish.



### Required specifications

Finish  
Edge detail\*

### Optional specifications

HP laminate\*

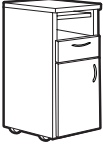

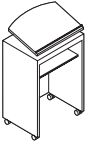
BOARDROOM ACCESSORIES	MODEL #	DIMENSIONS	WT/LB.	CUBIC FT.	LIST PRICE	HP ADD
 <p><b>Serving Cart*</b></p>	A2036SK	36 x 20 x 36.5	179	19	<b>\$1869</b>	<b>\$152</b>
	<p>Includes <b>two</b> side opening, self-closing hinged doors, <b>two box drawers</b>, one slide-out tray and storage shelf. On casters. Shipped assembled in 1 carton.</p> <ul style="list-style-type: none"> <li>• Available with bicut edge (<b>CR</b>) at no upcharge, please specify.</li> <li>• MUST specify Black (<b>HX</b>) or Silver (<b>HS</b>) finish for handles.</li> </ul>					
 <p><b>Serving Cart*</b></p>	A2020SK	20 x 20 x 36	114	11	<b>\$1082</b>	<b>\$101</b>
	<p>Includes <b>one</b> side opening, self-closing hinged door, <b>one box drawer</b>, one slide-out tray and storage shelf. On casters. Shipped assembled in 1 carton.</p> <ul style="list-style-type: none"> <li>• Available with bicut edge (<b>CR</b>) at no upcharge, please specify.</li> <li>• MUST specify Black (<b>HX</b>) or Silver (<b>HS</b>) finish for handles.</li> </ul>					
 <p><b>Audio/Visual Cabinet*</b></p>	A2436AV	36 x 24 x 65.5	272	11.25	<b>\$2345</b>	N/A
	<p>Includes <b>four</b> side opening doors covering two adjustable and two fixed shelves. Wire access through one grommet on back panel. Holds up to 27"H TV monitor. Doors do not lock. Shipped easy to assemble in 1 carton.</p> <ul style="list-style-type: none"> <li>• MUST specify Black (<b>HX</b>) or Silver (<b>HS</b>) finish for handles.</li> </ul>					
 <p><b>Visual Board</b></p>	AVB4848	48 x 4 x 48	135	9	<b>\$1329</b>	N/A
	<p>Includes whiteboard and two side opening doors containing cork board on right door and 50-sheet paper writing pad on left door. Marker board can be used for projection.</p> <ul style="list-style-type: none"> <li>• <b>NOTE:</b> Care should be taken to mount the units. Units should be mounted to wall studs using correct fasteners. Failure to do so may result in collapse of the unit and subsequent personal injury. Mounting hardware not included. Mounting hardware used should be based on wall material. Consult an installation professional for proper wall mounting.</li> </ul>					
 <p><b>Lectern</b></p>	A1844LC	24 x 18 x 44	92	4.8	<b>\$858</b>	<b>\$101</b>
	<p>Features angled stand, storage shelf and casters. Shipped easy to assemble in 1 carton.</p>					

**Required specifications**

Top finish  
Base finish  
Handles\*  
Edge detail\*

**Optional specifications**

Key #\* (not A2436AV)  
HP laminate (not A2436AV, AVB4848 or FC)



The Genoa series combines the value of laminate furniture with the contemporary styling of top over end panel design. This versatile offering of components and wide selection of laminate finish options is the perfect complement to any office environment.

For added security of confidential material, all desks and credenzas are equipped with one locking pedestal. Genoa's kneespace credenza easily accommodates a computer, books, binders and files to maximize space.

Genoa features quality construction. Fully progressive ball bearing suspensions ensure years of smooth, trouble-free drawer service.

Genoa's classic styling and simplicity integrate easily with existing furnishings and any interior decor. For new offices or current office expansions, Genoa is clearly the affordable and practical choice.

**Features and Benefits**

- 45 lb. density particle board substructure with high performance thermally fused laminate.
- Available bow front desk provides extra legroom and work area for visitors.
- ¾ modesty panel is standard.
- Most components shipped fully assembled, 1 per carton.
- Pencil tray included in the box drawer.
- Box drawers mounted on ¾ extension steel ball bearings.
- Drawers open with side pull.
- Compatible with **Divide** panel systems for increased privacy and storage requirements.

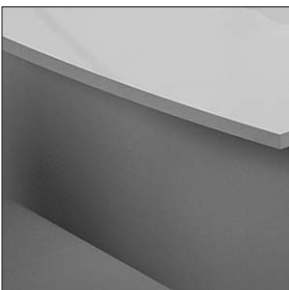

Bow front available on 36" x 72" desks.



Contemporary top-over-end panel design.



Drawer fronts are edge banded on all sides.

**GENERAL INFORMATION**

- Constructed of 45 lb. density particle board with high performance thermally fused laminate.
- Genoa components are compatible with Divide partitioning panels.
- Large offering of extended corners, full to floor pedestals, islands and storage options.
- Double wall pedestal housing.
- Genoa desk and storage products have been tested and comply with all BIFMA mechanical tests.
- For environmental certification, please visit [globalfurnituregroup.com](http://globalfurnituregroup.com).

**CONSTRUCTION**

- Constructed of 45 lb. density particle board with high performance thermally fused laminate.
- Double wall pedestal housing.
- Panel end style with top over side panel design.
- 1" adjustable leveling glides standard on all units.
- Standard with locks.

**MODESTY PANELS**

- Recessed ¾ height modesty panel is standard. Full modesty panel available. **Add \$62.**
- All full to floor units, bridges and returns are standard with a full modesty panel.

**STORAGE**

- All lateral file drawer fronts feature the woodgrain running in a horizontal direction.
- Pencil tray included in box drawer.

**FINISHES**

<b>ACJ</b> Absolute Acajou	<b>NBL</b> Noce Biondo
<b>ASN</b> Asian Night	<b>NGL</b> Noce Grigio
<b>AWC</b> Avant Cherry	<b>NEL</b> Noce Leggero
<b>AWH</b> Avant Honey	<b>NML</b> Noce Medio
<b>BLK</b> Black	<b>QTM</b> Quartered Mahogany
<b>CMB</b> Clear Maple	<b>WHE</b> Walnut Heights
<b>DES</b> Dark Espresso	<b>WHC</b> White Chocolate
<b>DWT</b> Designer White	<b>WCR</b> Winter Cherry

**MONOPOSTS**

- Available in Black (TBL) only.

**GROMMETS**

- Grommets may be ordered on Genoa hutch back panel.
- Additional grommets available in standard worksurface locations (left, center or right). Order as: **FOG1, FOG2 or FOG3. Add \$91.**
- Grommet hole dimensions are 3.25"W x 1.875"D.

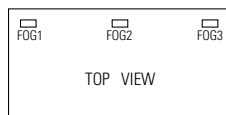

- Actual grommet locations on the worksurface are depicted in the example drawings shown below. Dimensions shown are actual measurements (in inches).

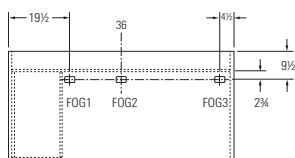

36 x 72 single pedestal left desks (G3672SPL)

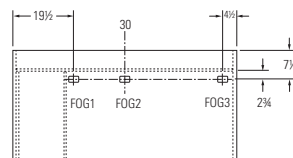

30 x 60 single pedestal left desks (G3060SPL)

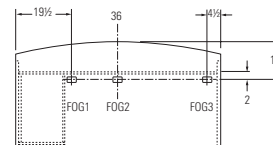

36 x 72 single pedestal left bow top desks (G3672SPLB)

- Grommets may be placed at non-standard locations. Order as: **CSG. Add \$132.** A drawing must be supplied with vertical and horizontal dimensions to the center of the cut-out (as in drawing above). Please refer to the **custom grommet location form** in the back reference section.
- Components that come standard with grommet may be ordered without a grommet, order **RSG. Add \$51**
- Grommets are available on modesty panels of **5-sided corners** 6.5" in where the two modesty panels meet at a 90° angle. Please specify **FOGMPR** for right grommet placement and **FOGMPL** for left grommet (placement shown below). Cost is **\$132.**
- Modesty panels are 1" off of ground.

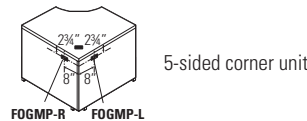

**POWER BLOCK**

- A power block (model **PMSPDM**) may be ordered on all worksurfaces.
- A power block is a rectangular worksurface power/data module with one electrical duplex receptacle and two data (RJ45) receptacles. 9 foot Black cord included. Power block dimensions are 6.5"W x 3.5"D x 2.75"H.
- To purchase a power block, you must specify both the power block cut-out location and the power block model #. Order power block as **PMSPDM. Add \$268.** Power blocks are available in standard worksurface locations (left, center or right). Order as **E1, E2 or E3. Add \$91.**

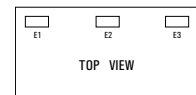

Power block **PMSPDM. Add \$268.**

Specify location **E1, E2 or E3. Add \$91.**

**SPECIAL SIZES**

- Special widths are available on most products with open knee space and/or units with open or hinged door storage configurations. To price, take the list price of the next larger standard size up and add **15%.** Quotations are not required, some exceptions may apply.
- For custom widths outside of the range of standard sizes published or any custom depths, submit a **SPECIALS / MTM** quote request through the Global Dealer Centre.
- Orders must indicate the custom quote number and list price.
- Changes to custom quotes are not permitted. Any revisions will necessitate a new quotation.

**SPECIFICATIONS**

- Specifications marked with an \* are applicable to only those products which have the \* symbol beside the product name.

**DOUBLE PEDESTAL DESKS**

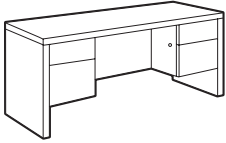

**Double Pedestal Desk**

MODEL #	DIMENSIONS W x D x H	WT/LB.	CUBIC FT.	LIST PRICE
G3672DP	72 x 36 x 29.4	286	50.5	<b>\$1316</b>
G3066DP	66 x 29.69 x 29.4	235	39.25	<b>\$1231</b>
G3060DP	60 x 29.69 x 29.4	226	35.5	<b>\$1048</b>

Standard with box/file pedestals on both sides. Pedestals lock. One pencil tray. Shipped assembled in 1 carton.

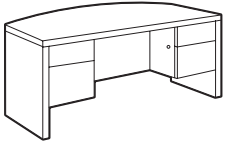

**Double Pedestal Bow Top Desk**

G3672DPB	72 x 32-36 x 29.4	256	50.5	<b>\$2212</b>
----------	-------------------	-----	------	---------------

Standard with box/file pedestals on both sides and bow top. Pedestals lock. One pencil tray. Shipped assembled in 1 carton.

**SINGLE PEDESTAL DESKS**

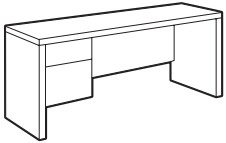

**Single Pedestal Desk - LEFT**

G3672SPL	72 x 36 x 29.4	235	50.5	<b>\$1165</b>
G3066SPL	66 x 29.69 x 29.4	192	39.25	<b>\$1080</b>
G3060SPL	60 x 29.69 x 29.4	183	35.5	<b>\$915</b>
G3048SPL	48 x 29.69 x 29.4	166	28.75	<b>\$788</b>
G2445SPL	45 x 24 x 29.4	137	23.5	<b>\$624</b>

Standard with box/file pedestal on the **left**. Pedestal locks. One pencil tray. Shipped assembled in 1 carton.

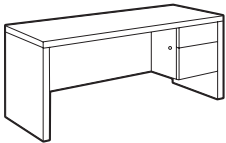

**Single Pedestal Desk - RIGHT**

G3672SPR	72 x 36 x 29.4	235	50.5	<b>\$1165</b>
G3066SPR	66 x 29.69 x 29.4	192	39.25	<b>\$1080</b>
G3060SPR	60 x 29.69 x 29.4	183	35.5	<b>\$915</b>
G3048SPR	48 x 29.69 x 29.4	166	28.75	<b>\$788</b>
G2445SPR	45 x 24 x 29.4	137	23.5	<b>\$624</b>

Standard with box/file pedestal on the **right**. Pedestal locks. One pencil tray. Shipped assembled in 1 carton.

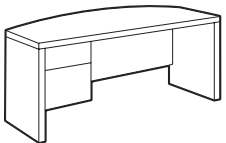

**Single Pedestal Bow Top Desk - LEFT**

G3672SPLB	72 x 32-36 x 29.4	214	50.5	<b>\$1882</b>
-----------	-------------------	-----	------	---------------

Standard with box/file pedestal on the **left** and bow top. Pedestal locks. One pencil tray. Shipped assembled in 1 carton.

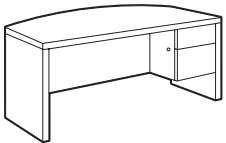

**Single Pedestal Bow Top Desk - RIGHT**

G3672SPRB	72 x 32-36 x 29.4	214	50.5	<b>\$1882</b>
-----------	-------------------	-----	------	---------------

Standard with box/file pedestal on the **right** and bow top. Pedestal locks. One pencil tray. Shipped assembled in 1 carton.

**Required specifications**

Finish

**Optional specifications**

Full modesty  
Grommet  
Key #

**Accessories**

Power block  
Keyboard tray  
Pencil tray

**RETURNS MODEL # DIMENSIONS WT/LB. CUBIC FT. LIST PRICE**

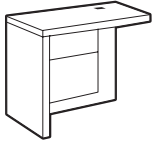

**Typing Return - LEFT**

W x D x H			WT/LB.	CUBIC FT.	LIST PRICE
G2448SDL	48 x 24 x 26		137	23.5	<b>\$761</b>
G2040SDL	40 x 20 x 26		111	17.5	<b>\$648</b>

Standard with box/file pedestal on the **left** and lower **26" height**. Pedestal locks. Grommet in worksurface. Shipped assembled in 1 carton.

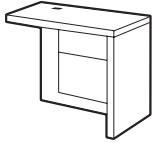

**Typing Return - RIGHT**

G2448SDR	48 x 24 x 26		137	23.5	<b>\$761</b>
G2040SDR	40 x 20 x 26		111	17.5	<b>\$648</b>

Standard with box/file pedestal on the **right** and lower **26" height**. Pedestal locks. Grommet in worksurface. Shipped assembled in 1 carton.

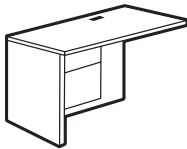

**Flush Return - LEFT**

G2448FL	48 x 24 x 29.4		142	23.5	<b>\$1024</b>
G2040FL	40 x 20 x 29.4		115	17.5	<b>\$985</b>

Standard with box/file drawer pedestal on the **left**. Pedestal locks. Grommet in worksurface. Shipped assembled in 1 carton.

- For 24" deep worksurfaces, order **G24\_\_FL**. For 20" deep worksurfaces, order **G20\_\_FL**.
- Keyboard and pencil trays for use on units 42" and above.

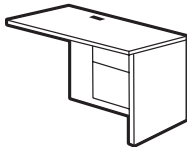

**Flush Return - RIGHT**

G2448FR	48 x 24 x 29.4		142	23.5	<b>\$1024</b>
G2040FR	40 x 20 x 29.4		115	17.5	<b>\$985</b>

Standard with box/file drawer pedestal on the **right**. Pedestal locks. Grommet in worksurface. Shipped assembled in 1 carton.

- For 24" deep worksurfaces, order **G24\_\_FR**. For 20" deep worksurfaces, order **G20\_\_FR**.
- Keyboard and pencil trays for use on units 42" and above.

**Required specifications**  
Finish

**Optional specifications**  
Key #

**Accessories**  
Power block  
Keyboard tray  
Pencil tray

**FULL TO FLOOR FLUSH RETURNS**

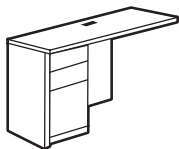

**Full to Floor Flush Return - LEFT**

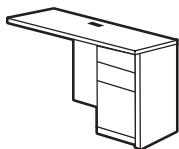

**Full to Floor Flush Return - RIGHT**

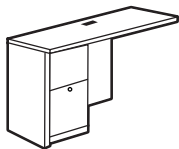

**Full to Floor Flush Return - LEFT**

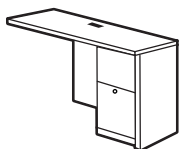

**Full to Floor Flush Return - RIGHT**

**MODEL # DIMENSIONS WT/LB. CUBIC FT. LIST PRICE**

**W x D x H**

G2448BL4	48 x 24 x 29.4	136	25	<b>\$1288</b>
G2442BL4	42 x 24 x 29.4	128	21.5	<b>\$1246</b>
G2436BL4	36 x 24 x 29.4	120	18	<b>\$1223</b>

Standard with box/box/file drawer pedestal on the **left**. Lower box drawer and file drawer lock. Grommet in worksurface. Shipped assembled in 1 carton.

- For 24" deep worksurfaces, order **G24\_\_BL4**. For 20" deep worksurfaces, order **G20\_\_BL4**.
- Keyboard and pencil trays for use on units 42" and above.

G2448BR4	48 x 24 x 29.4	136	25	<b>\$1288</b>
G2442BR4	42 x 24 x 29.4	128	21.5	<b>\$1246</b>
G2436BR4	36 x 24 x 29.4	120	18	<b>\$1223</b>

Standard with box/box/file drawer pedestal on the **right**. Lower box drawer and file drawer lock. Grommet in worksurface. Shipped assembled in 1 carton.

- For 24" deep worksurfaces, order **G24\_\_BR4**. For 20" deep worksurfaces, order **G20\_\_BR4**.
- Keyboard and pencil trays for use on units 42" and above.

G2448L4	48 x 24 x 29.4	132	25	<b>\$1309</b>
G2442L4	42 x 24 x 29.4	124	21.5	<b>\$1267</b>
G2436L4	36 x 24 x 29.4	116	18	<b>\$1246</b>

Standard with file/file drawer pedestal on the **left**. Pedestal locks. Grommet in worksurface. Shipped assembled in 1 carton.

- For 24" deep worksurfaces, order **G24\_\_L4**. For 20" deep worksurfaces, order **G20\_\_L4**.
- Keyboard and pencil trays for use on units 42" and above.

G2448R4	48 x 24 x 29.4	132	25	<b>\$1309</b>
G2442R4	42 x 24 x 29.4	124	21.5	<b>\$1267</b>
G2436R4	36 x 24 x 29.4	116	18	<b>\$1246</b>

Standard with file/file drawer pedestal on the **right**. Pedestal locks. Grommet in worksurface. Shipped assembled in 1 carton.

- For 24" deep worksurfaces, order **G24\_\_R4**. For 20" deep worksurfaces, order **G20\_\_R4**.
- Keyboard and pencil trays for use on units 42" and above.

**Required specifications**

Finish

**Optional specifications**

Key #  
Additional grommet

**Accessories**

Power block  
Keyboard tray  
Pencil tray

**FLUSH RETURNS**

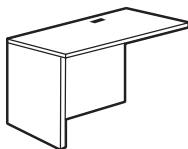

**Flush Return - LEFT**

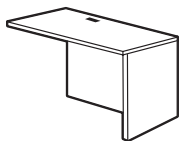

**Flush Return - RIGHT**

MODEL #	DIMENSIONS W x D x H	WT/LB.	CUBIC FT.	LIST PRICE
G2448FLK	48 x 24 x 29.4	96	4.5	<b>\$574</b>
G2040FLK	40 x 20 x 29.4	78	4.5	<b>\$510</b>

Return has no pedestal. Grommet in worksurface. Shipped easy to assemble in 1 carton.  
 • For 24" deep worksurfaces, order **G2448FLK**. For 20" deep worksurfaces, order **G2040FLK**.

G2448FRK	48 x 24 x 29.4	96	4.5	<b>\$574</b>
G2040FRK	40 x 20 x 29.4	78	4.5	<b>\$510</b>

Return has no pedestal. Grommet in worksurface. Shipped easy to assemble in 1 carton.  
 • For 24" deep worksurfaces, order **G2448FRK**. For 20" deep worksurfaces, order **G2040FRK**.

**FLUSH BRIDGES**

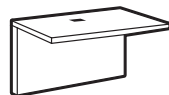

**Flush Bridge**

G2448FB	48 x 24 x 29.4	78	3.5	<b>\$627</b>
G2436FB	36 x 24 x 29.4	58	3.3	<b>\$627</b>
G2040FB	40 x 20 x 29.4	62	3.1	<b>\$486</b>

Top surface, back panel and hardware to connect two units. Grommet in worksurface. Shipped easy to assemble in 1 carton.  
 • **G2448FB** will connect 66" and 72" units plus all D islands.  
 • **G2040FB** will connect 60", 66" and 72" units plus all D islands and 5-sided corners.

**CREDENZAS**

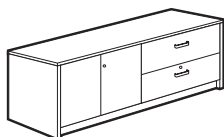

**Credenza**

G2072LS	72 x 20 x 29.4	222	29.4	<b>\$1632</b>
---------	----------------	-----	------	---------------

Standard with locking lateral file drawers on right and storage cabinet on left. Locking doors/drawers, keyed alike. Self-closing hinged doors covering one adjustable shelf. File bars included. One pencil tray. Shipped assembled in 1 carton.



**Center Storage Credenza\***

G2072C	72 x 20 x 29.4	213	29.4	<b>\$1316</b>
--------	----------------	-----	------	---------------

Standard with box/file pedestals on both sides and self-closing hinged center doors covering one adjustable shelf. Pedestal locks are inside the storage cabinet. One pencil tray. Shipped assembled in 1 carton.

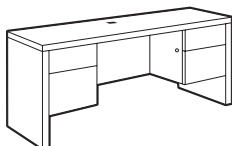

**Kneespace Credenza\***

G2072CK	72 x 20 x 29.4	181	29.5	<b>\$1196</b>
G2066CK	66 x 20 x 29.4	174	27	<b>\$1196</b>

Standard with box/file pedestals on both sides. Center is open. Pedestals lock. One pencil tray. Grommet in worksurface. Shipped assembled in 1 carton.

**Required specifications**  
Finish

**Optional specifications**  
Key # (only G2072LS)  
Full modesty\*  
Grommet

**Accessories**  
Power block  
Keyboard tray  
Pencil tray

**CREDENZAS**      **MODEL #**      **DIMENSIONS**      **WT/LB.**      **CUBIC FT.**      **LIST PRICE**

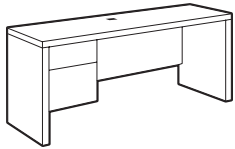

**Single Pedestal Credenza - LEFT**

W x D x H					
G2072CSL	72 x 20 x 29.4	150	29.5	<b>\$1185</b>	

Standard with box/file pedestal on the **left**. Pedestal locks. One pencil tray. Grommet in worksurface. Shipped assembled in 1 carton.

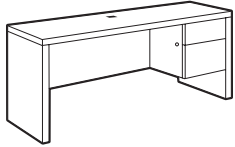

**Single Pedestal Credenza - RIGHT**

G2072CSR	72 x 20 x 29.4	150	29.5	<b>\$1185</b>	
----------	----------------	-----	------	---------------	--

Standard with box/file pedestal on the **right**. Pedestal locks. One pencil tray. Grommet in worksurface. Shipped assembled in 1 carton.

**5-SIDED CORNERS**



**5-Sided Corner**

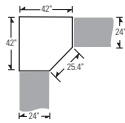

G42245C	42 x 42 x 29.4	114	5	<b>\$1046</b>	
---------	----------------	-----	---	---------------	--

Connects to **24"** returns, bridges and other **24"** units. Grommet in worksurface. Narrow end panels on left and right. Shipped easy to assemble in 1 carton.

- $\frac{3}{4}$  modesty panel is not available.

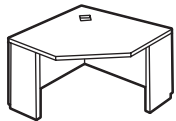

**5-Sided Corner**

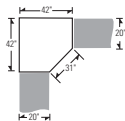

G42205C	42 x 42 x 29.4	108	5	<b>\$1046</b>	
G36205C	36 x 36 x 29.4	92	4.75	<b>\$1035</b>	

Connects to **20"** returns, bridges and other **20"** units. Grommet in worksurface. Narrow end panels on left and right. Shipped easy to assemble in 1 carton.

- $\frac{3}{4}$  modesty panel is not available.

**"D" ISLANDS**

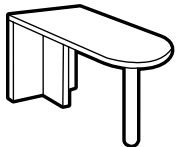

**"D" Island - Full End Panel & Post**

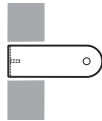

G3072FI	72 x 29.69 x 29.4	101	5	<b>\$1035</b>	
G3066FI	66 x 29.69 x 29.4	96	4.6	<b>\$919</b>	
G3060FI	60 x 29.69 x 29.4	91	4.2	<b>\$878</b>	

Connects to single pedestal credenza with half end panel or bridge to create a "T" grouping. **Not freestanding.** Connecting hardware for flush installation included. Shipped easy to assemble in 1 carton.

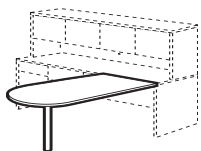

**"D" Island - with Post**

G3072I	72 x 29.69 x 29.4	72	5	<b>\$813</b>	
G3066I	66 x 29.69 x 29.4	67	4.6	<b>\$726</b>	
G3060I	60 x 29.69 x 29.4	62	4.2	<b>\$679</b>	

Connects to single pedestal credenza with half end panel or bridge to create a "T" or "U" shape grouping. **Not freestanding.** Connecting hardware for flush installation included. Shipped easy to assemble in 1 carton.

**Required specifications**

Finish

**Optional specifications**

Key # (credenzas only)  
Full modesty (credenzas only)  
Grommet

**Accessories**

Power block  
Keyboard tray  
Pencil tray



**"P" SHAPED ISLANDS**      **MODEL #**      **DIMENSIONS**      **WT/LB.**      **CUBIC FT.**      **LIST PRICE**

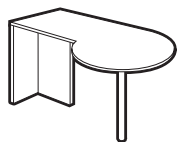

**"P" Shaped Island**

**W x D x H**

G3072FPL	72 x 30-36 x 29.4	121	6	<b>\$1285</b>
----------	-------------------	-----	---	---------------

Connects to single pedestal credenza with half end panel or bridge to create a "T" or "U" shape grouping. **Not freestanding.** Connecting hardware for flush installation included. Shipped easy to assemble in 1 carton.

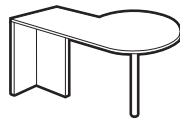

**"P" Shaped Island**

G3072FPR	72 x 30-36 x 29.4	121	6	<b>\$1285</b>
----------	-------------------	-----	---	---------------

Connects to single pedestal credenza with half end panel or bridge to create a "T" or "U" shape grouping. **Not freestanding.** Connecting hardware for flush installation included. Shipped easy to assemble in 1 carton.

**OPEN HUTCHES**

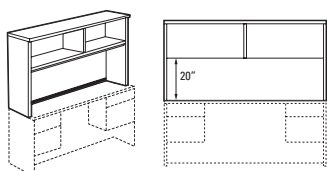

**Open Hutch with Closed Back\***

G72HOCB	72 x 15 x 36	138	7	<b>\$1078</b>
G66HOCB	66 x 15 x 36	133	7	<b>\$1078</b>
G60HOCB	60 x 15 x 36	123	5.25	<b>\$898</b>

One 1" thick fixed shelf **and one fixed shelf divider**. Closed back features a flexible sweep for wire management. Available in single color only. Shipped easy to assemble in 1 carton.

- **G71HOCB** for use when spanning 30" x 60/66" SPL/R and 20/24" x 42" FL/FR/L4/R4.
- **G69HOCB** for use when spanning 30" x 60/66" SPL/R and 20" x 42" FL/FR/L4/R4.
- Clearance from worksurface to hutch doors is 20".
- Woodgrain runs horizontal on both the upper and lower back panels.

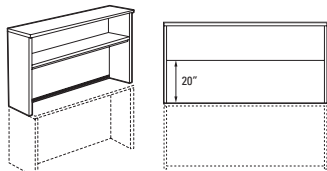

**Open Hutch with Closed Back\***

G48HOCB	48 x 15 x 36	100	4.2	<b>\$762</b>
G42HOCB	42 x 15 x 36	91	3.8	<b>\$756</b>
G36HOCB	36 x 15 x 36	82	3.3	<b>\$651</b>

One 1" thick fixed shelf. Closed back features a flexible sweep for wire management. Available in single color only. Shipped easy to assemble in 1 carton.

- Clearance from worksurface to hutch doors is 20".
- Woodgrain runs horizontal on both the upper and lower back panels.

**CORNER HUTCHES**

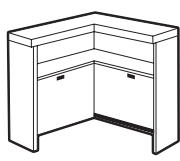

**Corner Hutch with Closed Back\***

G4242CH	42 x 15 x 36	137	6.25	<b>\$1185</b>
G3636CH	36 x 15 x 36	119	4.8	<b>\$1185</b>

One 1" thick fixed shelf. Closed back features a flexible sweep for wire management on lower right panel. Available in single color only. Shipped easy to assemble in 1 carton.

- Woodgrain runs horizontal on both the upper and lower back panels.

<b>Required specifications</b> Finish	<b>Optional specifications</b> Grommet (p-islands only)	<b>Accessories</b> Doors*
--	--	------------------------------

**PIGEON-HOLE STORAGE**

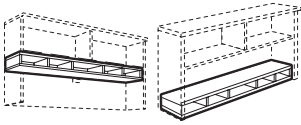

**Horizontal Pigeon-Hole Storage**

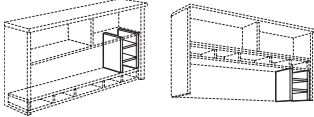

**Vertical Pigeon-Hole Storage**

MODEL #	DIMENSIONS W x D x H	WT/LB.	CUBIC FT.	LIST PRICE
AHS72	70 x 11.25 x 5.62	41	3	<b>\$668</b>
AHS71	69 x 11.25 x 5.62	41	3	<b>\$698</b>
AHS66	64 x 11.25 x 5.62	38	2.8	<b>\$668</b>
AHS60	58 x 11.25 x 5.62	35	2.5	<b>\$550</b>
AHS48	46 x 11.25 x 5.62	28	2	<b>\$399</b>
AHS42	40 x 11.25 x 5.62	24	2	<b>\$399</b>
AHS36	34 x 11.25 x 5.62	22	2	<b>\$327</b>

For additional storage. Can be **top** or **bottom** mounted. For use inside **straight hutch** (end panels not finished). Self edge facing. Shipped easy to assemble in 1 carton.

- Black finish is standard. Brushed Cobalt (**BRC**) is available at no charge, please specify.
- Cannot be used on A00S and C00S overstorage units.

AVS14	13.37 x 11.25 x 14.37	13	0.9	<b>\$419</b>
-------	-----------------------	----	-----	--------------

For use in conjunction with the horizontal pigeon-hole storage. Can be used **under** or **over** horizontal unit. Facing self edge. Shipped easy to assemble in 1 carton.

- Black finish is standard. Brushed Cobalt (**BRC**) is available at no charge, please specify.

**DOORS FOR HUTCHES**

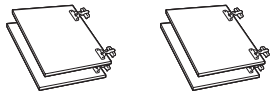

**Four-Door Kit**

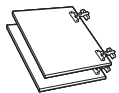

**Two-Door Kit**

GDOOR72	72 x 0.69 x 15	24	1.75	<b>\$506</b>
GDOOR66	66 x 0.69 x 15	22	1.75	<b>\$506</b>
GDOOR60	60 x 0.69 x 15	20	1.75	<b>\$506</b>

For use on 72", 71", 69", 66" and 60"W straight hutches. Hinges included. Locks available. **Add \$260** for two locks. Doors for units 60" wide or more require two locks. Shipped easy to assemble, 1 kit per carton.

GDOOR48	48 x 0.69 x 15	17	1.75	<b>\$252</b>
GDOOR42	42 x 0.69 x 15	16	1.75	<b>\$252</b>
GDOOR36	36 x 0.69 x 15	14	1.75	<b>\$252</b>

For use on 48", 42" 40" and 36"W straight hutches. Hinges included. Locks available. **Add \$131** for one lock. Doors for units 48" wide or less require one lock. Shipped easy to assemble, 1 kit per carton.

**Required specifications**  
Finish

**Optional specifications**  
Key # (only GDOORxx)

TACKBOARDS FOR HUTCHES

**NOTES:** Tackboards can be upholstered in all of the following fabrics:

- Anchorage
- Global seating fabrics\*
- Lola
- Merge

\* Contact Customer Service for pricing.

TACKBOARDS FOR HUTCHES

MODEL # DIMENSIONS WT/LB. CUBIC FT. LIST PRICE

W x D x H

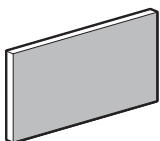

Tackboard

TB7018 70 x 1 x 18 12 2.2 **\$367**

For use on **G72HOCB** straight hutch. Includes mounting screws and covers.

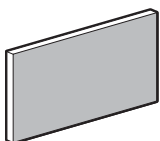

Tackboard

TB6918 69.5 x 1 x 18 12 2.1 **\$367**

For use on **G71HOCB** straight hutch. Includes mounting screws and covers.

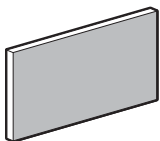

Tackboard

TB6618 66 x 1 x 18 12 2.2 **\$347**

For use on **G68HOCB** straight hutch. Includes mounting screws and covers.

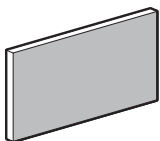

Tackboard

TB6418 64 x 1 x 18 11 2 **\$356**

For use on **G66HOCB** straight hutch. Includes mounting screws and covers.

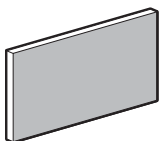

Tackboard

TB5818 58 x 1 x 18 10 1.8 **\$347**

For use on **G60HOCB** straight hutch. Includes mounting screws and covers.

**Required specifications**

Fabric

**TACKBOARDS FOR HUTCHES**

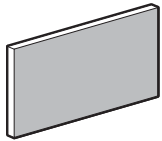

**Tackboard**

MODEL #	DIMENSIONS W x D x H	WT/LB.	CUBIC FT.	LIST PRICE
TB4618	46 x 1 x 18	9	1.6	<b>\$338</b>

For use on **G48HOCB** straight hutch. Includes mounting screws and covers.

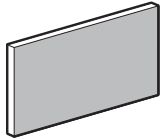

**Tackboard**

TB4018	40 x 1 x 18	8	1.4	<b>\$322</b>
--------	-------------	---	-----	--------------

For use on **G42HOCB** straight hutch. Includes mounting screws and covers.

**ACCESSORIES**



**2 Drawer Lateral File\***

G2036LF	36 x 20 x 29.4	109	15	<b>\$1165</b>
---------	----------------	-----	----	---------------

Two full suspension drawers. Front-to-back and side-to-side letter/legal filing capability with lock. Anti-lock tilt suspension. Shipped assembled in 1 carton.

- Back of file is always Black.
- File drawer construction is for accommodating hanging files NOT for stacking materials on the drawer bottom.

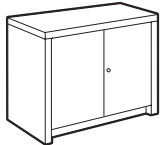

**Storage Cabinet\***

G2036SC	36 x 20 x 29.4	109	15	<b>\$1014</b>
---------	----------------	-----	----	---------------

Hinged doors cover one adjustable shelf. Standard with lock. Shipped assembled in 1 carton.

- Back of storage cabinet is always Black.

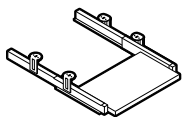

**Pull-Out Keyboard**

APOKL28	28 x 17 x 3.5	13	0.9	<b>\$296</b>
APOKL22	22 x 17 x 3.5	12	0.9	<b>\$270</b>

Constructed of thermally fused laminate.

- APOKL28 accommodates keyboard and mouse pad.

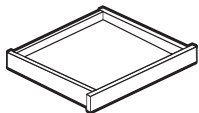

**Center Drawer**

CD28	28 x 18 x 3	5	1	<b>\$248</b>
------	-------------	---	---	--------------

Can be mounted on double-pedestal desks, credenzas or worksurfaces.

**Required specifications**

Fabric (only tackboards)  
Finish (not tackboards)

**Optional specifications**

Key #\*  
Grommet (only G2036LF)

ACCESSORIES      MODEL #      DIMENSIONS      WT/LB.      CUBIC FT.      LIST PRICE

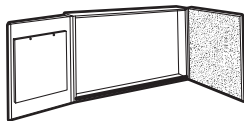

**Visual Board**

	W x D x H			
GVB4848	48 x 4 x 48	122	9.25	<b>\$1408</b>

Includes whiteboard and two side opening doors containing cork board on right door and 50-sheet paper writing pad on left door. Marker board can be used for projection.

- **NOTE:** Care should be taken to mount the units. Units should be mounted to wall studs using correct fasteners. Failure to do so may result in collapse of the unit and subsequent personal injury. **Mounting hardware not included.** Mounting hardware used should be based on wall material. Consult an installation professional for proper wall mounting..

**Required specifications**  
Finish



The design of Princeton reflects the personality of today's young, dynamic workforce. The freestanding, modular components build out from you and where you work. With over 1000 available components, Princeton offers a flexible footprint that's simple to reconfigure. A variety of storage options allow you to do more with less space.

Princeton delivers contemporary design to the workplace; whether it be in commercial and corporate offices, government offices, small businesses, banking, legal, accounting, hospitality or the professional home office. Every element, from the mix of materials and finishes to open storage pieces, floating modesty panels and overlapping surfaces, has been designed to provide visual appeal and intelligent function. Princeton is a freestanding and fully modular collection offering maximum flexibility; ease of installation and facilitates simple reconfigurations. The overlapping worksurface design also allows the footprint to adapt to smaller spaces by just a few inches.



Bench doubles as lateral filing.



Pull-out equipment shelf (printer not included).



Bookshelf with accessory hook.

#### Features and Benefits

- 1" thick worksurfaces in thermally fused or high pressure laminate.
- Worksurfaces feature Global's preferred edging in matching color.
- Optional tempered glass shelves with acid etched finish on one side.
- Counterweights standard on all mobile pedestals, lateral files and credenzas.
- Handles & pulls in satin anodized finish standard on all credenza, pedestal drawers and cabinet doors.
- Monoposts and hutch supports standard in Tungsten finish.
- Benches double as lateral filing.
- Pull-out equipment shelves on select credenzas.
- Energy efficient LED lighting for overhead storage cabinets.
- Grommets and power blocks to accommodate power/data needs.
- Choose glass or fabric equipment screens.

## GENERAL INFORMATION

- Over 1000 components are available.
- No cubicles or panels needed for configurations.
- Products can be added and reconfigured as needed.
- Princeton desk and storage products have been tested and comply with all BIFMA mechanical tests.
- For environmental certification, please visit [globalfurnituregroup.com](http://globalfurnituregroup.com).

## WORKSURFACES

- 1" thick high performance thermally fused laminate tops sealed with Global's preferred edging in matching color.
- High pressure tops are available in all Princeton laminate finishes at an extended lead time. Please see model # for pricing and availability.
- Worksurfaces with metal legs which have a span of 54" and over are standard with metal support hat channel(s); support channels are Black.
- 36" deep - 2 - 2"H support channels.

## CONSTRUCTION

- Laminate end panel and metal leg products are **not intended** to be combined for the most visually compatible design. They are, however, interchangeable if required.
- All components, with the exception of worksurfaces, have 1mm thick matching edges.
- Leveling glides are standard on all floor units.
- End panels are 1.5" thick on laminate end panel desks and credenzas. Cabinet end panels are 1 1/16" thick.
- 1" x 2" metal frame legs for desks and returns (closed 'O' style leg). Available finish options: Tungsten (**TTU**), Black (**TBL**) or Designer White (**TDW**).
- 1" x 2.5" metal frame legs for freestanding tables (open 'U' style leg). Available finish options: Tungsten (**TTU**), Black (**TBL**) or Designer White (**TDW**).
- Constructed of 45 lb. density particle board with high performance thermally fused laminate.
- Mobile pedestals and mobile lateral files come standard with front locking casters.
- Counterweights are standard on all pedestals, lateral files, credenzas and cabinets.
- Stool and rolling table come standard with non-locking casters.
- Laminate shelves are 1 1/16" thick and edged on all 4 sides. Tempered glass is 6mm thick with acid etched finish on one side.
- Credenzas come standard with file bars for side-to-side and front-to-back letter/legal capability. File bars are not shipped with cabinets and pedestals.
- Handles and pulls in satin anodized finish are standard on all credenza, pedestal drawers and cabinet doors.
- Pull-out equipment shelves are available on select credenzas.
- Grommets and power blocks are available to accommodate power/data needs.

## EDGE DETAILS

- All worksurfaces have 2mm thick matching edge detail on all sides.
- All other components have 1mm thick edge detail on all sides.
- Edging cannot be specified separately. No substitutions.

## STORAGE

- Mobile storage greater than 25.5"H may only be used with 29"H Princeton products with laminate end panels or gables. Princeton products with metal legs for support do not accommodate 27"H mobile units.
- Roll-out shelf on credenza holds up to 80 lbs.
- Laminate shelves are standard on storage cabinets. Tempered glass is available at an upcharge (varies by item; see product for details). Specify (**TG**).
- All cabinets with side open shelf area that aligns with 29"H or 27"H credenzas - fixed shelf is 1" thick.
- Recycling/waste drawer accommodates 1 recycling basket and 1 waste basket.

## LAMINATE MODESTY PANELS

- Standard on all desks with laminate end panels, returns with laminate end panels and bridges for laminate end panel desks.
- Flush on freestanding returns with laminate end panels.
- Recessed 4" deep on 24"D desks with laminate end panels, 5" deep on 30"D desks with laminate end panels and 6" deep on 36"D desks with laminate end panels.
- Recessed 4" on 24"D, 5" deep on 30"D, and 6" deep on 36"D flush and overlapping returns with laminate end panels.
- Recessed 4" on 24" deep and 5" deep on 30" deep flush and overlapping bridges with laminate end panels.
- Desks and returns feature modesty panel that is flush with end panel.
- Bottom of laminate modesty panel is 18" from floor.

## GLASS DESKTOP PANELS

- Glass desktop panel is sold separately, see page 76.
- Available for installation onto desks, returns, bridges and conference tops.
- Made of 6mm tempered glass with acid etched finish on one side.
- On-site installation is required. Installation instructions included with product.

## FABRIC DESKTOP/MODESTY PANELS

- Fabric desktop/modesty panels are sold separately, see page 77.
- Products may be upmounted as a desk top privacy screen or down mounted as a modesty panel.
- Available in:
  - Grade 2:** Lola
  - Grade 3:** Anchorage, Merge
- On-site installation is required. Installation instructions included with product.
- Non-tackable.
- Bottom of fabric modesty panel is 15.5" from floor.

## PET FELT DESKTOP/MODESTY PANELS

- PET Felt desktop/modesty panel is sold separately, see page 77.
- 9mm thick panels offered in nine finishes: Black (**BLK**), Brick (**BRI**), Denim (**DEN**), Harvest (**HVT**), Graphite (**GPH**), Mist (**MTS**), Pewter (**PWT**), Shamrock (**SHR**) and White (**WHT**).
- Made from 100% PET (polyester) fiber with a high content of post-recycled material (50%), free of added chemicals, binders and adhesives.
- Lightweight panels are tackable, impact and tear resistant, bacteria resistant, moisture resistant, and installation friendly.
- Variation in fiber mix and color are inherent to the character of the product.
- Clamps are included, available in satin anodized finish only.

## CREDENZAS

- Available in 29", 27" and 23" heights.
- 29" high connect to flush returns, flush conference tops and flush bridges.
- 27" high connect to overlapping returns, overlapping conference tops and overlapping bridges.
- Fixed drawer widths - see individual models for details.
- Upper adjustable shelf must be removed when products with laminate modesty panels are installed (i.e. PN2448RFR flush return with laminate end panel or PN2436BF flush bridge for laminate end panel desk).
- Connection of flush or overlapping surfaces to credenzas is only possible over full height opening.
- All credenza tops are 1" thick.
- Grommet location is 2.5" from the back edge to the cut-out edge.
- Grommet locations are only available as shown, otherwise a quote is required.

## LOCKS

- Standard on all credenzas, storage cabinets, lateral files, pedestals & benches.
- Lock on all credenzas, cabinets and pedestals is always on the bottom drawer.
- All components within a workstation or private office can be keyed alike. For up to 20 key numbers, the lead times are standard.
- To order specified keying, tag each component of each workstation or office with a lock number between 401 and 420.
- For projects larger than 20 offices, 20 additional key numbers are available at no charge, from 421 to 440. Delivery will be extended an additional week.
- Storage cabinets and pedestals with box/box/file drawers - only file drawer and lower box drawer are locking. Credenza file drawer lock secures both drawers.

## HUTCHES & OVERHEAD STORAGE

- Available in 60", 66", 72", 78" and 84" widths.
- Hutches with full back feature one small hole in each corner for wire pass-through.
- 15.75" height clearance between worksurface and underside of hutch.
- Overhead storage cabinets have full width lower storage with center divider.
- Hutches feature 1" x 2" steel support frame in Black (**TBL**), Designer White (**TDW**) or Tungsten (**TTU**).
- Laminate and tempered glass sliding doors available.
- Hutches cannot be placed on desks with laminate end panels.
- Wallhung mounting rails are provided; wall fastener hardware is not included.
- Locks are not available.
- Energy efficient LED lighting available, see page 466.

## TABLES

- 1" x 2.5" open metal frame leg. Available finish options: Black (**TBL**), Designer White (**TDW**) or Tungsten (**TTU**).
- Standard with 1" thick top and Global's preferred edging in matching color.
- 120" and 144" wide table tops with center leg are shipped in two pieces.
- Tables which have a span of 54" or wider are standard with 2"H metal support hat channel(s); support channels are Black.
- Grommets and power block cut-outs are available for most tables. Due to support channel location(s) for all 29" high tables, a quote request is required. Contact our Specials Department.
- Available standard with levelers or locking casters.

## CONNECTION

- Metal flat plates and wood screws are provided for connection between two units.

## TACKBOARDS

- Tackboards available for hutches and overhead units.
- Available to fit 60", 66", 72", 78" and 84" widths.
- Available in:
  - Anchorage
  - Lola
  - Merge
- Contact Customer Service for COM selection.

## CUSHIONS

- Cushions are sold separately.
- Cushions are available in all Global seating fabrics including bonded leather. Contact Customer Service for COM selection and procedure.
- Cushions are not available in leather, leather/mock leather or mesh.

## SPECIAL SIZES

- Special sizes are available, submit a SPECIALS / MTM quote request through the Global Dealer Centre.
- Orders must indicate the custom quote number and list price.
- Changes to custom quotes are not permitted. Any revisions will necessitate a new quotation.

## TASK LIGHTS

- Optional, energy efficient LED task lights (ultra slim design) are available for mounting under hutches and overheads.
- Hutches and overhead storage cabinets are predrilled for easy installation.
- Available in 12", 20" and 40" widths.

## WIRE MANAGEMENT

- 2"W x 2"H.
- Plastic tray flexes to receive and hold electrical and data wires.
- Quickly attaches with double-sided tape (included).
- Finished Black only.

## MONOPOST

- Standard support for conference tops; support for select desks and returns.
- 4" square post with 10" square base.

## PLANTERS

- Plastic planter pots provided.
- 8.5" diameter x 8"H.
- Available in Black (**BK**) or White (**WT**). Must specify at time of order.

## SHIPPING

- Items are shipped easy to assemble unless otherwise noted.
- Shipped in 1 carton unless otherwise noted.
- Connecting hardware included.

## SPECIFICATIONS

- Specifications marked with an \* are applicable to only those products which have the \* symbol beside the product name.



1. SPECIFY MODEL NUMBER

2. SPECIFY FINISH

Top Finishes:

- ACJ** Absolute Acajou
- ASN** Asian Night
- AWC** Avant Cherry
- AWH** Avant Honey
- BLK** Black
- BZD** Blizzard
- BRC** Brushed Cobalt
- CMB** Clear Maple
- CGY** Custom Grey
- DES** Dark Espresso
- DWT** Designer White
- FAS** Fashionista
- FCL** First Class
- NBL** Noce Biondo
- NGL** Noce Grigio
- NEL** Noce Leggero
- NML** Noce Medio
- QTM** Quartered Mahogany
- SBY** Sheer Beauty
- SDT** Stonedust
- WHE** Walnut Heights
- WHC** White Chocolate
- WCR** Winter Cherry

Base Finishes:

- ACJ** Absolute Acajou
- ASN** Asian Night
- AWC** Avant Cherry
- AWH** Avant Honey
- BLK** Black
- BZD** Blizzard
- BRC** Brushed Cobalt
- CMB** Clear Maple
- CGY** Custom Grey
- DES** Dark Espresso
- DWT** Designer White
- FAS** Fashionista
- FCL** First Class
- NBL** Noce Biondo
- NGL** Noce Grigio
- NEL** Noce Leggero
- NML** Noce Medio
- QTM** Quartered Mahogany
- SBY** Sheer Beauty
- SDT** Stonedust
- WHE** Walnut Heights
- WHC** White Chocolate
- WCR** Winter Cherry

Door, Drawer and Cabinet Front Finishes:

- ACJ** Absolute Acajou
- ASN** Asian Night
- AWC** Avant Cherry
- AWH** Avant Honey
- BLK** Black
- BZD** Blizzard
- BRC** Brushed Cobalt
- CMB** Clear Maple
- CGY** Custom Grey
- DES** Dark Espresso
- DWT** Designer White
- FAS** Fashionista
- FCL** First Class
- NBL** Noce Biondo
- NGL** Noce Grigio
- NEL** Noce Leggero
- NML** Noce Medio
- QTM** Quartered Mahogany
- SBY** Sheer Beauty
- SDT** Stonedust
- WHE** Walnut Heights
- WHC** White Chocolate
- WCR** Winter Cherry

Monopost Finishes

4" square monopost is available in Tungsten (TTU), Black (TBL) or Designer White (TDW) finish.

Planters

Planter pots are standard in White. Available in Black (BK) at no upcharge. Must specify at time of order.

Metal Frame Desk Legs

1" x 2" metal frame legs are available in Tungsten (TTU), Black (TBL) or Designer White (TDW) finish.

Metal Frame Table Legs

1" x 2.5" metal frame legs available in Tungsten (TTU), Black (TBL) or Designer White (TDW) finish.

Metal Hutch Supports

1" x 2" metal supports are available in Tungsten (TTU), Black (TBL) or Designer White (TDW) finish.

3. SPECIFY OPTIONS

GROMMETS

- One grommet in satin anodized finish is standard on many components, as specified.
- Additional grommets may be available in other standard worksurface locations (left, center or right).
- Order as: **Left POG1, Center POG2 or Right POG3. Add \$94.**

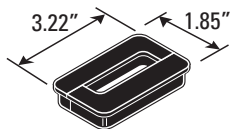

- Worksurface grommet hole dimensions are 3.22"W by 1.85"D.
- Standard grommet position is POG2 in desks, returns, bridges and conference tops.
- Modesty panel pass-through hole dimensions are 3.43"W by 2"H.
- Standard grommets are as per lineart depicted. Grommets may be placed at non-standard locations on select models only as indicated on product pages.  
Order as **PCSG. Add \$132.**  
A drawing must be supplied with vertical and horizontal dimensions to the center of the cut-out. Any others would require a special quote.
- Components that come standard with grommet may be ordered without a grommet.  
Order as **RSG. Add \$52.**
- Grommet only available at POG2 on the following 48"W worksurfaces:
  - Desks: PN2448DK, PN3048DK, PN3648DK
  - Return-freestandings: PN246029R, PN246027R
  - Return-flushes: PN2448RFR, PN3048RFR, PN3648RFR, PN2448RFL, PN3048RFL, PN3648RFL

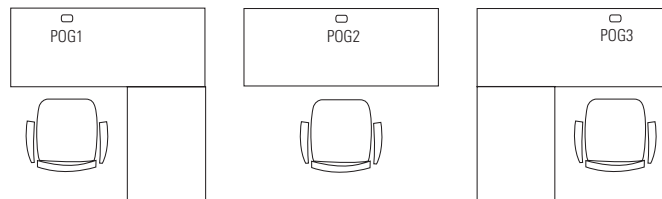

POWER BLOCK

- Power block (model **PGDPS20**) with 1 power outlet and 1 data opening, 12 foot long power cord, available for mounting under worksurfaces or inside of laminate end panels.
- Power block (model **PGDPS21**) with 2 power outlets and 1 data opening, 12 foot long power cord, available for mounting under worksurfaces or inside of laminate end panels.
- Power bar (model **PGDPS41**) with 4 power outlets and 1 data opening, 12 foot long power cord, available for mounting behind credenza pull-out shelf or at back of credenza opening.
- Rectangular shape. Finished in Tungsten (TN).
- Power block dimensions:
  - PGDPS20: 2.5"D x 3.50"W x 2.25"H.
  - PGDPS21: 2.5"D x 6.75"W x 2.25"H.
- Power bar dimensions:
  - PGDPS41: 2.5"D x 10.25"W x 2.22"H.

**FREESTANDING DESKS**

**MODEL #      DIMENSIONS      WT/LB.      CUBIC FT.      LIST PRICE      HP ADD**

**W x D x H**

PN2484DK	84 x 24 x 29	115	6.5	<b>\$866</b>	<b>\$106</b>
PN2478DK	78 x 24 x 29	110	6	<b>\$842</b>	<b>\$104</b>
PN2472DK	72 x 24 x 29	104	5.5	<b>\$804</b>	<b>\$103</b>
PN2466DK	66 x 24 x 29	98	5	<b>\$793</b>	<b>\$103</b>
PN2460DK	60 x 24 x 29	93	4.75	<b>\$750</b>	<b>\$103</b>
PN2454DK	54 x 24 x 29	88	4.5	<b>\$742</b>	<b>\$101</b>
PN2448DK	48 x 24 x 29	83	4	<b>\$718</b>	<b>\$99</b>

PN3084DK	84 x 30 x 29	139	7.5	<b>\$881</b>	<b>\$109</b>
PN3078DK	78 x 30 x 29	132	7	<b>\$855</b>	<b>\$108</b>
PN3072DK	72 x 30 x 29	126	6.5	<b>\$827</b>	<b>\$106</b>
PN3066DK	66 x 30 x 29	119	6	<b>\$801</b>	<b>\$104</b>
PN3060DK	60 x 30 x 29	112	5.5	<b>\$769</b>	<b>\$103</b>
PN3054DK	54 x 30 x 29	106	5	<b>\$756</b>	<b>\$103</b>
PN3048DK	48 x 30 x 29	98	4.5	<b>\$731</b>	<b>\$103</b>

PN3684DK	84 x 36 x 29	163	8.75	<b>\$932</b>	<b>\$120</b>
PN3678DK	78 x 36 x 29	155	8.25	<b>\$902</b>	<b>\$115</b>
PN3672DK	72 x 36 x 29	147	7.5	<b>\$885</b>	<b>\$113</b>
PN3666DK	66 x 36 x 29	140	7	<b>\$844</b>	<b>\$108</b>
PN3660DK	60 x 36 x 29	132	6.5	<b>\$812</b>	<b>\$104</b>
PN3654DK	54 x 36 x 29	124	5.75	<b>\$787</b>	<b>\$103</b>
PN3648DK	48 x 36 x 29	117	5.25	<b>\$741</b>	<b>\$103</b>

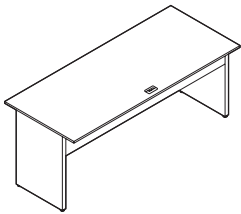

**Freestanding Desk**

Standard with inset end panel on both ends and 10”H modesty panel with pass-through grommet. Connects to flush return with laminate end panel, bridges for laminate end panel desks, flush return with bookshelf, flush conference tops. Can be placed over 27”H freestanding returns or 23”H/27”H credenzas. Grommet in worksurface. Shipped easy to assemble in 1 carton.

**RETURNS - LAMINATE END PANELS**

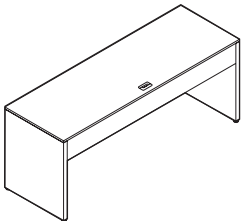

**Freestanding Return - 29”H**

PN248429R	84 x 24 x 29	133	6.5	<b>\$845</b>	<b>\$119</b>
PN247829R	78 x 24 x 29	127	6	<b>\$818</b>	<b>\$114</b>
PN247229R	72 x 24 x 29	122	5.5	<b>\$794</b>	<b>\$108</b>
PN246629R	66 x 24 x 29	116	5	<b>\$755</b>	<b>\$106</b>
PN246029R	60 x 24 x 29	110	4.75	<b>\$746</b>	<b>\$103</b>

Standard with flush laminate 1.5” thick end panels. 10”H modesty panel without pass-through grommet. Connects to flush return with laminate end panel, bridges for laminate end panel desks, flush return with bookshelf and flush conference tops. Can be placed over 27”H freestanding returns or 23”H/27”H credenzas. Grommet in worksurface. Shipped easy to assemble in 1 carton.

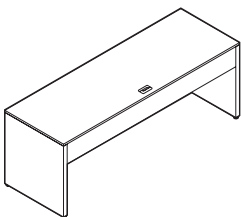

**Freestanding Return - 27”H**

PN248427R	84 x 24 x 27	129	6.5	<b>\$831</b>	<b>\$115</b>
PN247827R	78 x 24 x 27	124	6	<b>\$808</b>	<b>\$111</b>
PN247227R	72 x 24 x 27	119	5.5	<b>\$784</b>	<b>\$106</b>
PN246627R	66 x 24 x 27	113	5	<b>\$757</b>	<b>\$104</b>
PN246027R	60 x 24 x 27	107	4.75	<b>\$704</b>	<b>\$101</b>

Standard with flush laminate 1.5” thick end panels. 10”H modesty panel without pass-through grommet. Supports overlapping return with laminate end panel, overlapping bridge for laminate end panel desks and overlapping return with bookshelf and overlapping conference top. Can be placed under desk. Grommet in worksurface. Shipped easy to assemble in 1 carton.

**Required specifications**

Top finish  
Base finish

**Optional specifications**

HP laminate  
POG1, POG2  
PCSG - custom grommet  
RSG - no grommet

**Accessories**

Power block      Wire manager  
Keyboard tray      Keyboard mechanism  
Fabric desktop / M.P.  
Glass desktop panel

**RETURNS - LAMINATE END PANELS**

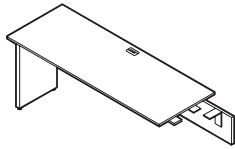

**Flush Return - 29" H - LEFT\***

MODEL #	DIMENSIONS W x D x H	WT/LB.	CUBIC FT.	LIST PRICE	HP ADD
PN2472RFL	72 x 24 x 29	93	6.5	<b>\$721</b>	<b>\$113</b>
PN2466RFL	66 x 24 x 29	87	6	<b>\$698</b>	<b>\$109</b>
PN2460RFL	60 x 24 x 29	81	5.75	<b>\$656</b>	<b>\$104</b>
PN2454RFL	54 x 24 x 29	75	5.25	<b>\$640</b>	<b>\$103</b>
PN2448RFL	48 x 24 x 29	70	4.75	<b>\$611</b>	<b>\$101</b>

Return has no pedestal. Standard with inset end panel on **left**. 10"H modesty panel with pass-through grommet. Connects to freestanding desk with laminate end panels, 29"H freestanding returns and 29"H credenzas. Grommet in worksurface. Shipped easy to assemble in 2 carton.

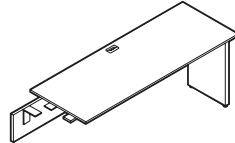

**Flush Return - 29" H - RIGHT\***

PN2472RFR	72 x 24 x 29	93	6.5	<b>\$721</b>	<b>\$113</b>
PN2466RFR	66 x 24 x 29	87	6	<b>\$698</b>	<b>\$109</b>
PN2460RFR	60 x 24 x 29	81	5.75	<b>\$656</b>	<b>\$104</b>
PN2454RFR	54 x 24 x 29	75	5.25	<b>\$640</b>	<b>\$103</b>
PN2448RFR	48 x 24 x 29	70	4.75	<b>\$611</b>	<b>\$101</b>

Return has no pedestal. Standard with inset end panel on **right**. 10"H modesty panel with pass-through grommet. Connects to freestanding desk with laminate end panels, 29"H freestanding returns and 29"H credenzas. Grommet in worksurface. Shipped easy to assemble in 2 carton.

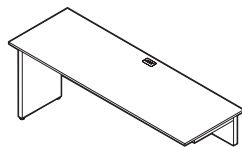

**Overlapping Return - 29" H - LEFT\***

PN2484ROL	84 x 24 x 29	106	6.5	<b>\$799</b>	<b>\$91</b>
PN2478ROL	78 x 24 x 29	101	6	<b>\$745</b>	<b>\$90</b>
PN2472ROL	72 x 24 x 29	95	5.5	<b>\$721</b>	<b>\$84</b>

Standard with inset laminate end panel on **left** and 10"H modesty panel with pass-through grommet. Overlaps 27"H credenza and 27"H freestanding returns. Grommet in worksurface. 1" spacer included. Shipped easy to assemble in 1 carton.

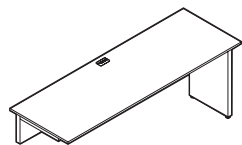

**Overlapping Return - 29" H - RIGHT\***

PN2484ROR	84 x 24 x 29	106	6.5	<b>\$799</b>	<b>\$91</b>
PN2478ROR	78 x 24 x 29	101	6	<b>\$745</b>	<b>\$90</b>
PN2472ROR	72 x 24 x 29	95	5.5	<b>\$721</b>	<b>\$84</b>

Standard with inset laminate end panel on **right** and 10"H modesty panel with pass-through grommet. Overlaps 27"H credenza and 27"H freestanding Returns. Grommet in worksurface. 1" spacer included. Shipped easy to assemble in 1 carton.

**BRIDGES FOR LAMINATE END PANEL DESKS**

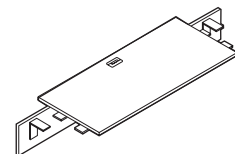

**Flush Bridge**

PN2454BF	54 x 24 x 11	61	3.5	<b>\$570</b>	<b>\$88</b>
PN2448BF	48 x 24 x 11	57	3.25	<b>\$543</b>	<b>\$81</b>
PN2442BF	42 x 24 x 11	51	3	<b>\$518</b>	<b>\$77</b>
PN2436BF	36 x 24 x 11	49	2.75	<b>\$486</b>	<b>\$74</b>

Standard with 10"H modesty panel with pass-through grommet. Connects between any two: freestanding desk with laminate end panels, 29"H freestanding returns, conference top for U configurations or 29"H credenza opening. Subtop finish is granite with Black edge. Grommet in worksurface. Shipped easy to assemble in 2 carton.

**Required specifications**

Top finish  
Base finish

**Optional specifications**

HP laminate  
POG1, POG3\*  
PCSG - custom grommet  
RSG - no grommet

**Accessories**

Power block  
Keyboard tray  
Fabric desktop / M.P.  
Glass desktop panel  
Wire manager  
Keyboard mechanism

**BRIDGES FOR LAMINATE END PANEL DESKS**

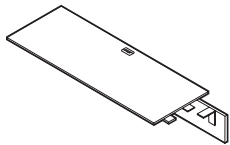

**Overlapping Bridge - LEFT**

MODEL #	DIMENSIONS W x D x H	WT/LB.	CUBIC FT.	LIST PRICE	HP ADD
PN2478BOL	78 x 24 x 11	89	7	<b>\$682</b>	<b>\$101</b>
PN2472BOL	72 x 24 x 11	83	6.5	<b>\$649</b>	<b>\$91</b>
PN2466BOL	66 x 24 x 11	77	6	<b>\$626</b>	<b>\$85</b>
PN2460BOL	60 x 24 x 11	72	5.75	<b>\$617</b>	<b>\$83</b>

Standard with 10"H modesty panel with pass-through grommet. Connects freestanding desk with laminate end panels, 29"H freestanding returns, conference top for U configurations on one end, and overlaps 27"H credenza or 27"H freestanding return on other end. Subtop finish is granite with Black edge. Grommet in worksurface. Includes 1" spacer, one side only. Shipped easy to assemble in 2 carton.

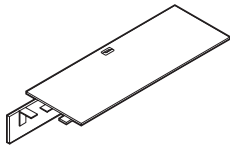

**Overlapping Bridge - RIGHT**

PN2478BOR	78 x 24 x 11	89	7	<b>\$682</b>	<b>\$101</b>
PN2472BOR	72 x 24 x 11	83	6.5	<b>\$649</b>	<b>\$91</b>
PN2466BOR	66 x 24 x 11	77	6	<b>\$626</b>	<b>\$85</b>
PN2460BOR	60 x 24 x 11	72	5.75	<b>\$617</b>	<b>\$83</b>

Standard with 10"H modesty panel with pass-through grommet. Connects freestanding desk with laminate end panels, 29"H freestanding returns, conference top for U configurations on one end, and overlaps 27"H credenza or 27"H freestanding return on other end. Subtop finish is granite with Black edge. Grommet in worksurface. Includes 1" spacer, one side only. Shipped easy to assemble in 2 carton.

**FREESTANDING DESKS WITH METAL LEGS**

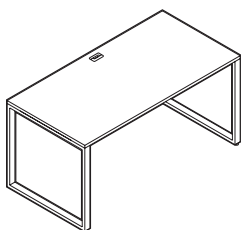

**Freestanding Desk with Metal Legs\***

PN2484DM	84 x 24 x 29	116	13.25	<b>\$1446</b>	<b>\$219</b>
PN2478DM	78 x 24 x 29	111	13	<b>\$1340</b>	<b>\$204</b>
PN2472DM	72 x 24 x 29	104	12.5	<b>\$1182</b>	<b>\$179</b>
PN2466DM	66 x 24 x 29	100	12	<b>\$1169</b>	<b>\$177</b>
PN2460DM	60 x 24 x 29	95	11.5	<b>\$1148</b>	<b>\$175</b>
PN2454DM	54 x 24 x 29	90	11.25	<b>\$1113</b>	<b>\$169</b>
PN2448DM	48 x 24 x 29	78	9.25	<b>\$993</b>	<b>\$152</b>
PN3084DM	84 x 30 x 29	136	16.25	<b>\$1501</b>	<b>\$229</b>
PN3078DM	78 x 30 x 29	129	15.75	<b>\$1398</b>	<b>\$211</b>
PN3072DM	72 x 30 x 29	124	15.25	<b>\$1258</b>	<b>\$193</b>
PN3066DM	66 x 30 x 29	117	14.75	<b>\$1219</b>	<b>\$184</b>
PN3060DM	60 x 30 x 29	111	14.25	<b>\$1182</b>	<b>\$180</b>
PN3054DM	54 x 30 x 29	105	13.75	<b>\$1159</b>	<b>\$176</b>
PN3048DM	48 x 30 x 29	92	11.25	<b>\$1029</b>	<b>\$156</b>
PN3684DM	84 x 36 x 29	165	19	<b>\$1695</b>	<b>\$258</b>
PN3678DM	78 x 36 x 29	157	18.5	<b>\$1558</b>	<b>\$236</b>
PN3672DM	72 x 36 x 29	149	17.75	<b>\$1518</b>	<b>\$231</b>
PN3666DM	66 x 36 x 29	141	17.25	<b>\$1337</b>	<b>\$204</b>
PN3660DM	60 x 36 x 29	133	16.75	<b>\$1292</b>	<b>\$196</b>
PN3654DM	54 x 36 x 29	125	16.25	<b>\$1224</b>	<b>\$186</b>
PN3648DM	48 x 36 x 29	108	15.25	<b>\$1112</b>	<b>\$169</b>

Standard with two 1" x 2" metal open frame legs with support channel(s). Connects to flush returns with metal leg, bridges for desks and returns with metal leg, flush return with bookshelf and flush conference tops. Grommet in worksurface. Shipped easy to assemble in 3 cartons.

**Required specifications**

Top finish  
Base finish (not PNxxxxDM)  
Leg finish\*

**Optional specifications**

HP laminate      PCSG - custom grommet  
POG1 (only PNxxxxBOR)      RSG - no grommet  
POG3 (only PNxxxxBOL)  
POG1, POG3 (only PNxxxxDM)

**Accessories**

Power block      Wire manager  
Keyboard tray      Keyboard mechanism  
Fabric desktop / M.P.      Glass desktop panel

**FREESTANDING DESKS W/BOOKSHELF**      **MODEL #**      **DIMENSIONS**      **WT/LB.**      **CUBIC FT.**      **LIST PRICE**      **HP ADD**

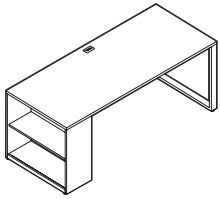

**Freestanding Desk with Bookshelf - LEFT**

**W x D x H**

PN3060DBL	60 x 30 x 29	134	15.5	<b>\$1278</b>	<b>\$195</b>	
PN3066DBL	66 x 30 x 29	147	18.25	<b>\$1405</b>	<b>\$214</b>	
PN3072DBL	72 x 30 x 29	153	18.75	<b>\$1447</b>	<b>\$219</b>	
PN3078DBL	78 x 30 x 29	159	19.25	<b>\$1557</b>	<b>\$236</b>	
PN3084DBL	84 x 30 x 29	166	19.75	<b>\$1639</b>	<b>\$250</b>	
PN3672DBL	72 x 36 x 29	182	22.25	<b>\$1499</b>	<b>\$229</b>	
PN3678DBL	78 x 36 x 29	190	22.75	<b>\$1622</b>	<b>\$247</b>	
PN3684DBL	84 x 36 x 29	198	23.25	<b>\$1821</b>	<b>\$276</b>	

12"D bookcase with adjustable shelf on **left**. One 1" x 2" metal open frame leg with support channel(s). Right side connects to flush returns with metal leg, bridges for desks and returns with metal leg, flush return with bookshelf and flush conference tops. Grommet in worksurface. Shipped easy to assemble in 3 cartons.

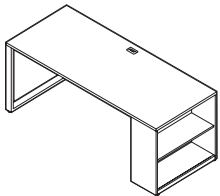

**Freestanding Desk with Bookshelf - RIGHT**

PN3060DBR	60 x 30 x 29	134	15.5	<b>\$1278</b>	<b>\$195</b>	
PN3066DBR	66 x 30 x 29	147	18.25	<b>\$1405</b>	<b>\$214</b>	
PN3072DBR	72 x 30 x 29	153	18.75	<b>\$1447</b>	<b>\$219</b>	
PN3078DBR	78 x 30 x 29	159	19.25	<b>\$1557</b>	<b>\$236</b>	
PN3084DBR	84 x 30 x 29	166	19.75	<b>\$1639</b>	<b>\$250</b>	
PN3672DBR	72 x 36 x 29	182	22.25	<b>\$1499</b>	<b>\$229</b>	
PN3678DBR	78 x 36 x 29	190	22.75	<b>\$1622</b>	<b>\$247</b>	
PN3684DBR	84 x 36 x 29	198	23.25	<b>\$1821</b>	<b>\$276</b>	

12"D bookcase with adjustable shelf on **right**. One 1" x 2" metal open frame leg with support channel(s). Left side connects to flush returns with metal leg, bridges for desks and returns with metal leg, flush return with bookshelf and flush conference tops. Grommet in worksurface. Shipped easy to assemble in 3 cartons.

**RETURNS W/METAL LEG**

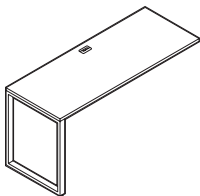

**Flush Return with Metal Leg - LEFT**

PN2448FML	48 x 24 x 29	59	5.75	<b>\$647</b>	<b>\$98</b>	
PN2454FML	54 x 24 x 29	69	7.75	<b>\$774</b>	<b>\$119</b>	
PN2460FML	60 x 24 x 29	75	8.25	<b>\$813</b>	<b>\$124</b>	
PN2466FML	66 x 24 x 29	80	8.5	<b>\$843</b>	<b>\$128</b>	
PN2472FML	72 x 24 x 29	85	9	<b>\$870</b>	<b>\$133</b>	
PN2478FML	78 x 24 x 29	91	9	<b>\$970</b>	<b>\$145</b>	
PN3048FML	48 x 30 x 29	71	7	<b>\$686</b>	<b>\$104</b>	
PN3054FML	54 x 30 x 29	82	9.25	<b>\$808</b>	<b>\$123</b>	
PN3060FML	60 x 30 x 29	88	9.75	<b>\$844</b>	<b>\$128</b>	
PN3066FML	66 x 30 x 29	94	10.25	<b>\$875</b>	<b>\$133</b>	
PN3072FML	72 x 30 x 29	100	10.75	<b>\$931</b>	<b>\$141</b>	
PN3078FML	78 x 30 x 29	106	10.75	<b>\$1017</b>	<b>\$154</b>	

1" x 2" metal frame leg on **left**. Support channel(s) included for units 72"W and above. Connects to freestanding desk with metal legs, freestanding desk with bookshelf and metal leg or 29"H credenza opening. Grommet in worksurface. Shipped easy to assemble in 2 cartons.

**Required specifications**

Top finish  
Base finish  
Leg finish

**Optional specifications**

HP laminate  
POG1, POG3 (N/A to 48"W)  
PCSG - custom grommet  
RSG - no grommet

**Accessories**

Power block      Wire manager  
Keyboard tray      Keyboard mechanism  
Fabric desktop / M.P.      Glass desktop panel  
Keyboard tray mounting kit

**RETURNS W/METAL LEG**

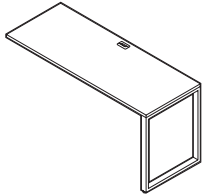

**Flush Return with Metal Leg - RIGHT**

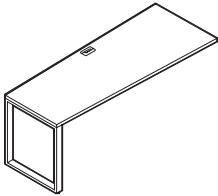

**Flush Wedge Return w/Metal Leg - LEFT**

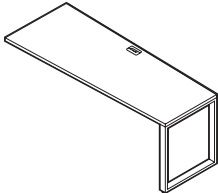

**Flush Wedge Return w/Metal Leg - RIGHT**

MODEL #	DIMENSIONS W x D x H	WT/LB.	CUBIC FT.	LIST PRICE	HP ADD
PN2448FMR	48 x 24 x 29	59	5.75	<b>\$647</b>	<b>\$98</b>
PN2454FMR	54 x 24 x 29	69	7.75	<b>\$774</b>	<b>\$119</b>
PN2460FMR	60 x 24 x 29	75	8.25	<b>\$813</b>	<b>\$124</b>
PN2466FMR	66 x 24 x 29	80	8.5	<b>\$843</b>	<b>\$128</b>
PN2472FMR	72 x 24 x 29	85	9	<b>\$870</b>	<b>\$133</b>
PN2478FMR	78 x 24 x 29	91	9	<b>\$970</b>	<b>\$148</b>
PN3048FMR	48 x 30 x 29	71	7	<b>\$686</b>	<b>\$104</b>
PN3054FMR	54 x 30 x 29	82	9.25	<b>\$808</b>	<b>\$123</b>
PN3060FMR	60 x 30 x 29	88	9.75	<b>\$844</b>	<b>\$128</b>
PN3066FMR	66 x 30 x 29	94	10.25	<b>\$875</b>	<b>\$133</b>
PN3072FMR	72 x 30 x 29	100	10.75	<b>\$931</b>	<b>\$141</b>
PN3078FMR	78 x 30 x 29	106	10.75	<b>\$1017</b>	<b>\$154</b>

1" x 2" metal frame leg on **right**. Support channel(s) included for units 72"W and above. Connects to freestanding desk with metal legs, freestanding desk with bookshelf and metal leg or 29"H credenza opening. Grommet in worksurface. Shipped easy to assemble in 2 cartons.

PN3048FTL	48 x 30 x 29	62	6	<b>\$674</b>	<b>\$152</b>
PN3054FTL	54 x 30 x 29	75	8.5	<b>\$798</b>	<b>\$122</b>
PN3060FTL	60 x 30 x 29	80	9	<b>\$844</b>	<b>\$128</b>
PN3066FTL	66 x 30 x 29	86	9.5	<b>\$893</b>	<b>\$136</b>
PN3072FTL	72 x 30 x 29	92	10	<b>\$931</b>	<b>\$141</b>

1" x 2" metal frame leg on **left**. Support channel(s) included for 72"W unit only. 30"D has 24" deep leg. 36"D has 30" deep leg. Connects to freestanding desk with metal legs, freestanding desk with bookshelf and metal leg or 29"H credenza opening. Grommet in worksurface. Shipped easy to assemble in 2 cartons.

PN3048FTR	48 x 30 x 29	62	6	<b>\$674</b>	<b>\$152</b>
PN3054FTR	54 x 30 x 29	75	8.5	<b>\$798</b>	<b>\$122</b>
PN3060FTR	60 x 30 x 29	80	9	<b>\$844</b>	<b>\$128</b>
PN3066FTR	66 x 30 x 29	86	9.5	<b>\$893</b>	<b>\$136</b>
PN3072FTR	72 x 30 x 29	92	10	<b>\$931</b>	<b>\$141</b>

1" x 2" metal frame leg on **right**. Support channel(s) included for 72"W unit only. 30"D has 24" deep leg. 36"D has 30" deep leg. Connects to freestanding desk with metal legs, freestanding desk with bookshelf and metal leg or 29"H credenza opening. Grommet in worksurface. Shipped easy to assemble in 2 cartons.

**Required specifications**

Top finish  
Leg finish

**Optional specifications**

HP laminate  
POG1, POG3 (N/A to 48"W)  
PCSG - custom grommet  
RSG - no grommet

**Accessories**

Power block  
Keyboard tray  
Fabric desktop / M.P.  
Keyboard tray mounting kit  
Wire manager  
Keyboard mechanism  
Glass desktop panel

**OVERLAPPING RETURNS W/METAL LEG**      **MODEL #**      **DIMENSIONS**      **WT/LB.**      **CUBIC FT.**      **LIST PRICE**      **HP ADD**

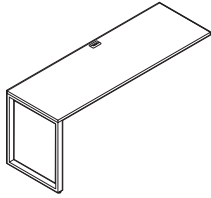

**Overlapping Return w/Metal Leg - LEFT\***

	W x D x H					
PN2460OML	60 x 24 x 29	74	6.25	<b>\$723</b>	<b>\$110</b>	
PN2466OML	66 x 24 x 29	79	6.5	<b>\$744</b>	<b>\$113</b>	
PN2472OML	72 x 24 x 29	83	6.75	<b>\$771</b>	<b>\$117</b>	
PN2478OML	78 x 24 x 29	88	7	<b>\$918</b>	<b>\$140</b>	
PN2484OML	84 x 24 x 29	100	9.75	<b>\$1062</b>	<b>\$162</b>	
PN3060OML	60 x 30 x 29	90	7.5	<b>\$756</b>	<b>\$115</b>	
PN3066OML	66 x 30 x 29	95	7.75	<b>\$784</b>	<b>\$120</b>	
PN3072OML	72 x 30 x 29	100	8	<b>\$829</b>	<b>\$126</b>	
PN3078OML	78 x 30 x 29	106	8.5	<b>\$986</b>	<b>\$151</b>	
PN3084OML	84 x 30 x 29	120	11.75	<b>\$1101</b>	<b>\$168</b>	

1" x 2" metal frame leg on **left**. Support channel(s) included for 84"W units only. Overlaps 27"H credenza opening. Grommet in worksurface. Shipped easy to assemble in 2 cartons.

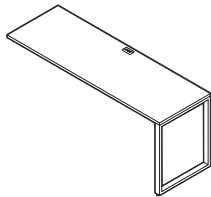

**Overlapping Return w/Metal Leg - RIGHT\*\***

PN2460OMR	60 x 24 x 29	74	6.25	<b>\$723</b>	<b>\$110</b>	
PN2466OMR	66 x 24 x 29	79	6.5	<b>\$744</b>	<b>\$113</b>	
PN2472OMR	72 x 24 x 29	83	6.75	<b>\$771</b>	<b>\$117</b>	
PN2478OMR	78 x 24 x 29	88	7	<b>\$918</b>	<b>\$140</b>	
PN2484OMR	84 x 24 x 29	100	9.75	<b>\$1062</b>	<b>\$162</b>	
PN3060OMR	60 x 30 x 29	90	7.5	<b>\$756</b>	<b>\$115</b>	
PN3066OMR	66 x 30 x 29	95	7.75	<b>\$784</b>	<b>\$120</b>	
PN3072OMR	72 x 30 x 29	100	8	<b>\$829</b>	<b>\$126</b>	
PN3078OMR	78 x 30 x 29	106	8.5	<b>\$986</b>	<b>\$151</b>	
PN3084OMR	84 x 30 x 29	120	11.75	<b>\$1101</b>	<b>\$168</b>	

1" x 2" metal frame leg on **right**. Support channel(s) included for 84"W units only. Overlaps 27"H credenza opening. Grommet in worksurface. Shipped easy to assemble in 2 cartons.

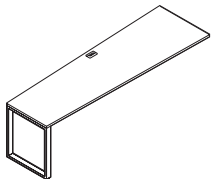

**Overlapping Wedge Return w/Metal Leg - LEFT\***

PN3060OTL	60 x 30 x 29	82	6.75	<b>\$771</b>	<b>\$117</b>	
PN3066OTL	66 x 30 x 29	87	7	<b>\$799</b>	<b>\$122</b>	
PN3072OTL	72 x 30 x 29	92	7.25	<b>\$837</b>	<b>\$127</b>	
PN3078OTL	78 x 30 x 29	97	7.5	<b>\$1002</b>	<b>\$153</b>	
PN3084OTL	84 x 30 x 29	111	11	<b>\$1116</b>	<b>\$170</b>	

1" x 2" metal frame leg on **left**. Support channel(s) included for 84"W unit only. 30"D has 24" deep leg. 36"D has 30" deep leg. Overlaps 27"H credenza opening. Grommet in worksurface. Includes 1" spacer. Shipped easy to assemble in 2 cartons.

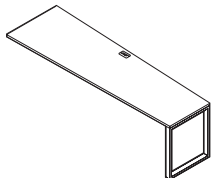

**Overlapping Wedge Return w/Metal Leg - RIGHT\*\***

PN3060OTR	60 x 30 x 29	82	6.75	<b>\$771</b>	<b>\$117</b>	
PN3066OTR	66 x 30 x 29	87	7	<b>\$799</b>	<b>\$122</b>	
PN3072OTR	72 x 30 x 29	92	7.25	<b>\$837</b>	<b>\$127</b>	
PN3078OTR	78 x 30 x 29	97	7.5	<b>\$1002</b>	<b>\$153</b>	
PN3084OTR	84 x 30 x 29	111	11	<b>\$1116</b>	<b>\$170</b>	

1" x 2" metal frame leg on **right**. Support channel(s) included for 84"W unit only. 30"D has 24" deep leg. 36"D has 30" deep leg. Overlaps 27"H credenza opening. Grommet in worksurface. Includes 1" spacer. Shipped easy to assemble in 2 cartons.

**Required specifications**

Top finish  
Leg finish

**Optional specifications**

HP laminate      RSG - no grommet  
POG1\*  
POG3\*\*  
PCSG - custom grommet

**Accessories**

Power block      Wire manager  
Keyboard tray      Keyboard mechanism  
Fabric desktop / M.P.      Glass desktop panel  
Keyboard tray mounting kit

**OVERLAPPING RETURNS W/ METAL LEG**

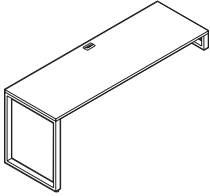

**Overlapping Return w/Metal Leg and Spacer for 23”H Credenza - LEFT**

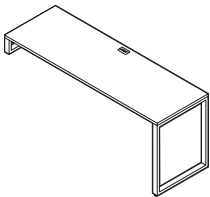

**Overlapping Return w/Metal Leg and Spacer for 23”H Credenza - RIGHT**

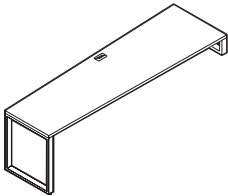

**Overlapping Wedge Return w/Metal Leg and Spacer for 23”H Credenza - LEFT**

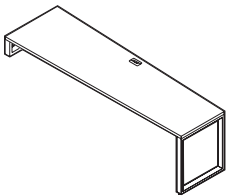

**Overlapping Wedge Return w/Metal Leg and Spacer for 23”H Credenza - RIGHT**

MODEL #	DIMENSIONS W x D x H	WT/LB.	CUBIC FT.	LIST PRICE	HP ADD
PN2460SOL	60 x 24 x 29	82	16.5	<b>\$1064</b>	<b>\$162</b>
PN2466SOL	66 x 24 x 29	88	17	<b>\$1097</b>	<b>\$168</b>
PN2472SOL	72 x 24 x 29	93	17.25	<b>\$1128</b>	<b>\$173</b>
PN2478SOL	78 x 24 x 29	99	17.25	<b>\$1224</b>	<b>\$186</b>
PN2484SOL	84 x 24 x 29	103	18.25	<b>\$1288</b>	<b>\$196</b>
PN3060SOL	60 x 30 x 29	97	20.25	<b>\$1134</b>	<b>\$173</b>
PN3066SOL	66 x 30 x 29	103	20.75	<b>\$1166</b>	<b>\$177</b>
PN3072SOL	72 x 30 x 29	109	21.25	<b>\$1194</b>	<b>\$181</b>
PN3078SOL	78 x 30 x 29	115	21.75	<b>\$1280</b>	<b>\$195</b>
PN3084SOL	84 x 30 x 29	122	22.25	<b>\$1365</b>	<b>\$208</b>

1” x 2” metal frame leg on **left** and 5” high metal frame spacer on **right**. Support channel(s) included for units 78”W and above. Overlaps 23”H credenza. Grommet in worksurface. Shipped easy to assemble in 3 cartons.

PN2460SOR	60 x 24 x 29	82	16.5	<b>\$1064</b>	<b>\$162</b>
PN2466SOR	66 x 24 x 29	88	17	<b>\$1097</b>	<b>\$168</b>
PN2472SOR	72 x 24 x 29	93	17.25	<b>\$1128</b>	<b>\$173</b>
PN2478SOR	78 x 24 x 29	99	17.25	<b>\$1224</b>	<b>\$186</b>
PN2484SOR	84 x 24 x 29	103	18.25	<b>\$1288</b>	<b>\$196</b>
PN3060SOR	60 x 30 x 29	97	20.25	<b>\$1134</b>	<b>\$173</b>
PN3066SOR	66 x 30 x 29	103	20.75	<b>\$1166</b>	<b>\$177</b>
PN3072SOR	72 x 30 x 29	109	21.25	<b>\$1194</b>	<b>\$181</b>
PN3078SOR	78 x 30 x 29	115	21.75	<b>\$1280</b>	<b>\$195</b>
PN3084SOR	84 x 30 x 29	122	22.25	<b>\$1365</b>	<b>\$208</b>

1” x 2” metal frame leg on **right** and 5” high metal frame spacer on **left**. Support channel(s) included for units 78”W and above. Overlaps 23”H credenza. Grommet in worksurface. Shipped easy to assemble in 3 cartons.

PN3060TSL	60 x 30.25 x 29	95	19.5	<b>\$1111</b>	<b>\$169</b>
PN3066TSL	66 x 30.25 x 29	101	19.75	<b>\$1155</b>	<b>\$176</b>
PN3072TSL	72 x 30.25 x 29	107	20.25	<b>\$1183</b>	<b>\$180</b>
PN3078TSL	78 x 30.25 x 29	112	20.75	<b>\$1269</b>	<b>\$194</b>
PN3084TSL	84 x 30.25 x 29	118	21.25	<b>\$1341</b>	<b>\$204</b>

1” x 2” metal frame leg on **left** and 5” high metal frame spacer on **right**. Support channel(s) included for units 78”W and above. 30”D has 24” deep leg and 30”D spacer. 36”D has 30” deep leg and 36”D spacer. Overlaps 23”H credenza. Grommet in worksurface. Shipped easy to assemble in 3 cartons.

PN3060TSR	60 x 30.25 x 29	95	19.5	<b>\$1111</b>	<b>\$169</b>
PN3066TSR	66 x 30.25 x 29	101	19.75	<b>\$1155</b>	<b>\$176</b>
PN3072TSR	72 x 30.25 x 29	107	20.25	<b>\$1183</b>	<b>\$180</b>
PN3078TSR	78 x 30.25 x 29	112	20.75	<b>\$1269</b>	<b>\$194</b>
PN3084TSR	84 x 30.25 x 29	118	21.25	<b>\$1341</b>	<b>\$204</b>

1” x 2” metal frame leg on **right** and 5” high metal frame spacer on **left**. Support channel(s) included for units 78”W and above. 30”D has 24” deep leg and 30”D spacer. 36”D has 30” deep leg and 36”D spacer. Overlaps 23”H credenza. Grommet in worksurface. Shipped easy to assemble in 3 cartons.

**Required specifications**

Top finish  
Leg finish

**Optional specifications**

HP laminate  
POG1, POG3  
PCSG - custom grommet  
RSG - no grommet

**Accessories**

Power block  
Keyboard tray  
Fabric desktop / M.P.  
Keyboard tray mounting kit  
Wire manager  
Keyboard mechanism  
Glass desktop panel



**BRIDGES FOR DESKS/RETURNS - METAL LEG**

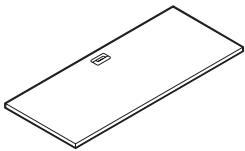

**Flush Bridge for Metal Leg Configurations**

MODEL #	DIMENSIONS W x D x H	WT/LB.	CUBIC FT.	LIST PRICE	HP ADD
PN2436BFM	36 x 24 x 1	28	1.75	<b>\$327</b>	<b>\$68</b>
PN2442BFM	42 x 24 x 1	33	2	<b>\$338</b>	<b>\$69</b>
PN2448BFM	48 x 24 x 1	37	2.25	<b>\$351</b>	<b>\$71</b>
PN2454BFM	54 x 24 x 1	49	4.25	<b>\$479</b>	<b>\$97</b>

Connects between any two: freestanding desk with metal legs, freestanding desk with bookshelf and metal leg, conference top for U configurations or 29"H credenza opening. Grommet in worksurface. Shipped easy to assemble in 1 carton.

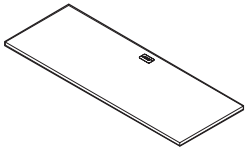

**Overlapping Bridge for Metal Leg Configurations - LEFT\*\*\***

PN2460OBL	60 x 24 x 2	56	4.75	<b>\$422</b>	<b>\$84</b>
PN2466OBL	66 x 24 x 2	60	5	<b>\$437</b>	<b>\$88</b>
PN2472OBL	72 x 24 x 2	65	5.5	<b>\$444</b>	<b>\$90</b>
PN2478OBL	78 x 24 x 2	76	5.5	<b>\$603</b>	<b>\$123</b>

Connects freestanding desk with metal legs, freestanding desk with bookshelf and metal leg, conference top for U configurations flush on one end, and overlaps 27"H credenza opening on the other end. Includes 1" spacer. Grommet in worksurface. Shipped easy to assemble in 1 carton.

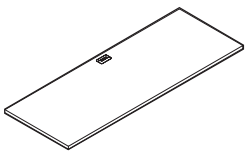

**Overlapping Bridge for Metal Leg Configurations - RIGHT\*\***

PN2460OBR	60 x 24 x 2	56	4.75	<b>\$422</b>	<b>\$84</b>
PN2466OBR	66 x 24 x 2	60	5	<b>\$437</b>	<b>\$88</b>
PN2472OBR	72 x 24 x 2	65	5.5	<b>\$444</b>	<b>\$90</b>
PN2478OBR	78 x 24 x 2	76	5.5	<b>\$603</b>	<b>\$123</b>

Connects freestanding desk with metal legs, freestanding desk with bookshelf and metal leg, conference top for U configurations flush on one end, and overlaps 27"H credenza opening on the other end. Includes 1" spacer. Grommet in worksurface. Shipped easy to assemble in 1 carton.

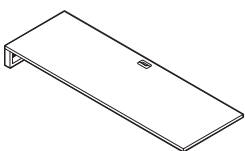

**Overlapping Bridge with Metal Spacer for 23"H Credenza - LEFT\*\***

PN2460OSL	60 x 24 x 6	62	5.5	<b>\$756</b>	<b>\$153</b>
PN2466OSL	66 x 24 x 6	67	6	<b>\$794</b>	<b>\$162</b>
PN2472OSL	72 x 24 x 6	72	6.5	<b>\$821</b>	<b>\$167</b>
PN2478OSL	78 x 24 x 6	78	6.5	<b>\$929</b>	<b>\$189</b>

One 5"H metal frame spacer with support channel(s). Connects flush on **right** side to freestanding desk with metal legs, freestanding desk with bookshelf and metal leg, or conference top for U configurations. Overlaps 23"H credenza opening on the **left**. Grommet in worksurface. Shipped easy to assemble in 2 cartons.

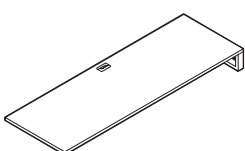

**Overlapping Bridge with Metal Spacer for 23"H Credenza - RIGHT\*\***

PN2460OSR	60 x 24 x 6	62	5.5	<b>\$756</b>	<b>\$153</b>
PN2466OSR	66 x 24 x 6	67	6	<b>\$794</b>	<b>\$162</b>
PN2472OSR	72 x 24 x 6	72	6.5	<b>\$821</b>	<b>\$167</b>
PN2478OSR	78 x 24 x 6	78	6.5	<b>\$929</b>	<b>\$189</b>

One 5"H metal frame spacer with support channel(s). Connects flush on **left** side to freestanding desk with metal legs, freestanding desk with bookshelf and metal leg, or conference top for U configurations. Overlaps 23"H credenza opening on the **right**. Grommet in worksurface. Shipped easy to assemble in 2 cartons.

**Required specifications**

Top finish  
Leg finish (only PN24xxOSL and PN24xxOSR)

**Optional specifications**

HP laminate      PCSG - custom grommet  
POG1, POG3\*      RSG - no grommet  
POG1\*\*  
POG3\*\*\*

**Accessories**

Power block      Wire manager  
Keyboard tray      Keyboard mechanism  
Fabric desktop / M.P.      Glass desktop panel  
Keyboard tray mounting kit

RETURNS WITH BOOKSHELVES

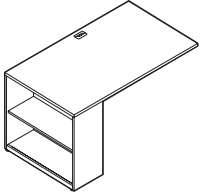

Flush Return with Bookshelf - LEFT

MODEL #	DIMENSIONS W x D x H	WT/LB.	CUBIC FT.	LIST PRICE	HP ADD
PN2460FBL	60 x 24 x 29	93	9.25	\$824	\$126
PN2466FBL	66 x 24 x 29	104	10.25	\$939	\$142
PN2472FBL	72 x 24 x 29	110	13.5	\$967	\$148
PN2478FBL	78 x 24 x 29	116	13.5	\$1028	\$155
PN2484FBL	84 x 24 x 29	120	14.5	\$1085	\$166
PN3060FBL	60 x 30 x 29	111	11.25	\$875	\$133
PN3066FBL	66 x 30 x 29	124	13	\$992	\$152
PN3072FBL	72 x 30 x 29	130	16	\$1025	\$155
PN3078FBL	78 x 30 x 29	136	17.5	\$1098	\$168
PN3084FBL	84 x 30 x 29	142	18	\$1203	\$183

**12"D** bookcase with adjustable shelf on **left**. With support channel(s). Connects on **right** side to freestanding desk with metal legs or laminate end panels, 29"H freestanding returns or 29"H credenza opening. Laminate shelf is standard. Grommet in worksurface. Shipped easy to assemble in 2 cartons.

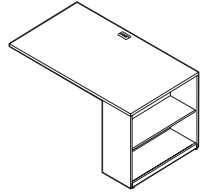

Flush Return with Bookshelf - RIGHT

PN2460FBR	60 x 24 x 29	93	9.25	\$824	\$126
PN2466FBR	66 x 24 x 29	104	10.25	\$939	\$142
PN2472FBR	72 x 24 x 29	110	13.5	\$967	\$148
PN2478FBR	78 x 24 x 29	116	13.5	\$1028	\$155
PN2484FBR	84 x 24 x 29	120	14.5	\$1085	\$166
PN3060FBR	60 x 30 x 29	111	11.25	\$875	\$133
PN3066FBR	66 x 30 x 29	124	13	\$992	\$152
PN3072FBR	72 x 30 x 29	130	16	\$1025	\$155
PN3078FBR	78 x 30 x 29	136	17.5	\$1098	\$168
PN3084FBR	84 x 30 x 29	142	18	\$1203	\$183

**12"D** bookcase with adjustable shelf on **right**. With support channel(s). Connects on **left** side to freestanding desk with metal legs or laminate end panels, 29"H freestanding returns or 29"H credenza opening. Laminate shelf is standard. Grommet in worksurface. Shipped easy to assemble in 2 cartons.

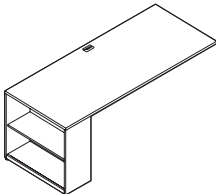

Overlapping Return with Bookshelf - LEFT

PN2484RBL	84 x 24 x 29	118	10.25	\$1069	\$165
PN2490RBL	90 x 24 x 29	131	13.25	\$1188	\$180
PN2496RBL	96 x 24 x 29	136	13.75	\$1251	\$191
PN3084RBL	84 x 30 x 29	145	15.5	\$1112	\$169
PN3090RBL	90 x 30 x 29	156	16	\$1219	\$184
PN3096RBL	96 x 30 x 29	162	16.5	\$1283	\$195

**12"D** bookcase with adjustable shelf on **left**. With support channel(s). **Right** side overlaps 27"H credenza opening, 27"H freestanding return. Laminate shelf is standard. Grommet in worksurface. Shipped easy to assemble in 2 cartons.

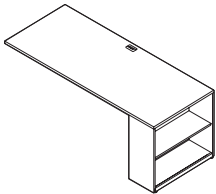

Overlapping Return with Bookshelf - RIGHT

PN2484RBR	84 x 24 x 29	118	10.25	\$1069	\$165
PN2490RBR	90 x 24 x 29	131	13.25	\$1188	\$180
PN2496RBR	96 x 24 x 29	136	13.75	\$1251	\$191
PN3084RBR	84 x 30 x 29	145	15.5	\$1112	\$169
PN3090RBR	90 x 30 x 29	156	16	\$1219	\$184
PN3096RBR	96 x 30 x 29	162	16.5	\$1283	\$195

**12"D** bookcase with adjustable shelf on **right**. With support channel(s). **Left** side overlaps 27"H credenza opening, 27"H freestanding return. Laminate shelf is standard. Grommet in worksurface. Shipped easy to assemble in 2 cartons.

**Required specifications**

Top finish  
Base finish

**Optional specifications**

HP laminate  
POG1, POG3  
PCSG - custom grommet  
RSG - no grommet

**Accessories**

Power block  
Keyboard tray  
Fabric desktop / M.P.  
Keyboard tray mounting kit  
Wire manager  
Keyboard mechanism  
Glass desktop panel

**CONFERENCE TOPS - FLUSH**      **MODEL #**      **DIMENSIONS**      **WT/LB.**      **CUBIC FT.**      **LIST PRICE**      **HP ADD**

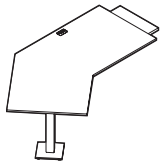

**LEFT**

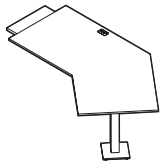

**RIGHT**

**Offset Conference Top, Flush**

	W x D x H					
PN3066CFL	66 x 47 x 29	77	7	<b>\$1000</b>	<b>\$138</b>	
PN3072CFL	72 x 47 x 29	83	7.25	<b>\$1012</b>	<b>\$131</b>	
PN3066CFR	66 x 47 x 29	77	7	<b>\$1000</b>	<b>\$138</b>	
PN3072CFR	72 x 47 x 29	83	7.25	<b>\$1012</b>	<b>\$131</b>	

Specify PNxxxxCFL for **left** or PNxxxxCFR for **right**.

Standard with square monopost and base. Connects to freestanding desks with metal legs or laminate end panels, 29"H freestanding returns or 29"H credenza opening. Subtop finish is granite with Black edge. Grommet in worksurface. Shipped easy to assemble in 2 cartons.

**Recommended maximum modesty panel size:**

PN3066CFR/CFL: 36" wide (PN3613DMF)      PN3072CFR/CFL: 42" wide (PN4213DMF)

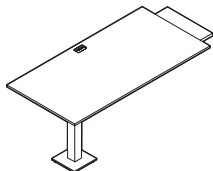

**LEFT**

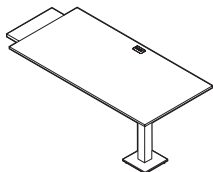

**RIGHT**

**Conference Tops, Flush**

PN2448DFL	48 x 24 x 29	51	4	<b>\$712</b>	<b>\$97</b>	
PN3048DFL	48 x 30 x 29	57	4.25	<b>\$759</b>	<b>\$104</b>	
PN3060DFL	60 x 30 x 29	70	5	<b>\$788</b>	<b>\$109</b>	
PN2448DFR	48 x 24 x 29	51	4	<b>\$712</b>	<b>\$97</b>	
PN3048DFR	48 x 30 x 29	57	4.25	<b>\$759</b>	<b>\$104</b>	
PN3060DFR	60 x 30 x 29	70	5	<b>\$788</b>	<b>\$109</b>	

Specify PNxxxxDFL for **left** or PNxxxxDFR for **right**.

Standard with square monopost and base. Connects to freestanding desks with metal legs or laminate end panels, 29"H freestanding returns or 29"H credenza opening. Subtop finish is granite with Black edge. Grommet in worksurface. Shipped easy to assemble in 2 cartons.

**Recommended maximum modesty panel size:**

PN2448DFR/DFL: 30" wide (PN3013DMF)      PN3048DFR/DFL: 30" wide (PN3013DMF)  
 PN3060DFR/DFL: 36" wide (PN3613DMF)

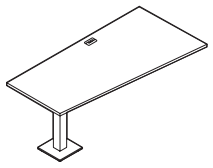

**LEFT**

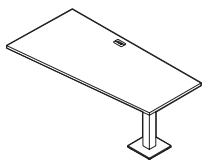

**RIGHT**

**Wedge Shaped Flush Conference Top**

PN3048TFL	48 x 30 x 29	56	4.5	<b>\$759</b>	<b>\$104</b>	
PN3060TFL	60 x 30 x 29	66	5	<b>\$788</b>	<b>\$109</b>	
PN3048TFR	48 x 30 x 29	56	4.5	<b>\$759</b>	<b>\$104</b>	
PN3060TFR	60 x 30 x 29	66	5	<b>\$788</b>	<b>\$109</b>	

Specify PNxxxxTFL for **left** or PNxxxxTFR for **right**.

Standard with square monopost and base. 30"D at connecting end, 24"D at monopost end. Connects to freestanding desks with metal legs or laminate end panels, 29"H freestanding returns or 29"H credenza opening. Subtop finish is granite with Black edge. Grommet in worksurface. Shipped easy to assemble in 2 cartons.

**Recommended maximum modesty panel size:**

PN3048TFR/TFL: 30" wide (PN3013DMF)      PN3060TFR/TFL: 36" wide (PN3013DMF)

**Required specifications**

Top finish  
 Leg finish

**Optional specifications**

HP laminate  
 RSG - no grommet  
 PCSG - custom grommet

**Accessories**

Power block      Wire manager  
 Keyboard tray      Keyboard mechanism  
 Fabric desktop / M.P.      Modesty panel  
 Glass desktop panel

**CONFERENCE TOPS - OVERLAPPING**

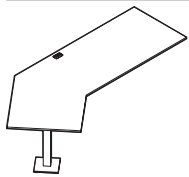

**LEFT**

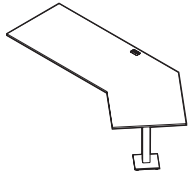

**RIGHT**

**Offset Conference Top, Overlapping**

MODEL #	DIMENSIONS W x D x H	WT/LB.	CUBIC FT.	LIST PRICE	HP ADD
PN3090COL	90 x 47 x 29	113	12.75	<b>\$1064</b>	<b>\$128</b>
PN3096COL	96 x 47 x 29	118	13.25	<b>\$1077</b>	<b>\$134</b>
PN3090COR	90 x 47 x 29	113	12.75	<b>\$1064</b>	<b>\$128</b>
PN3096COR	96 x 47 x 29	118	13.25	<b>\$1077</b>	<b>\$134</b>

Specify PNxxxxCOL for **left** or PNxxxxCOR for **right**.

Standard with square monopost and base. Overlaps 27”H credenza opening or 27”H freestanding return. Subtop finish is granite with Black edge. Grommet in worksurface. 1” spacer included. Shipped easy to assemble in 2 cartons.

**Recommended maximum modesty panel size:**

PN3090COR/COL: 36” wide (PN3613DMF)

PN3096COR/COL: 42” wide (PN4213DMF)

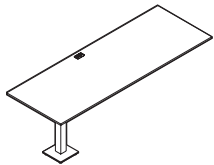

**LEFT**

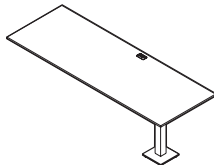

**RIGHT**

**Conference Top, Overlapping**

PN3072DOL	72 x 30 x 29	91	5.75	<b>\$916</b>	<b>\$114</b>
PN3078DOL	78 x 30 x 29	97	6	<b>\$935</b>	<b>\$114</b>
PN3084DOL	84 x 30 x 29	102	6.25	<b>\$1002</b>	<b>\$124</b>
PN3072DOR	72 x 30 x 29	91	5.75	<b>\$916</b>	<b>\$114</b>
PN3078DOR	78 x 30 x 29	97	6	<b>\$935</b>	<b>\$114</b>
PN3084DOR	84 x 30 x 29	102	6.25	<b>\$1002</b>	<b>\$124</b>

Specify PNxxxxDOL for **left** or PNxxxxDOR for **right**.

Standard with square monopost and base. Overlaps 27”H credenza opening or 27”H freestanding return. Subtop finish is granite with Black edge. Grommet in worksurface. 1” spacer included. Shipped easy to assemble in 2 cartons.

**Recommended maximum modesty panel size:**

PN3072DOR/DOL: 30” wide (PN3013DMF)

PN3078DOR/DOL: 30” wide (PN3013DMF)

PN3084DOR/DOL: 36” wide (PN3613DMF)

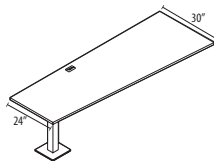

**LEFT**

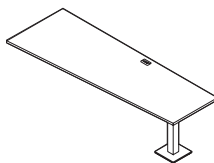

**RIGHT**

**Wedge Shaped Overlapping Conference Top**

PN3072TOL	72 x 30 x 29	86	5.75	<b>\$916</b>	<b>\$126</b>
PN3084TOL	84 x 30 x 29	96	6.25	<b>\$1002</b>	<b>\$138</b>
PN3072TOR	72 x 30 x 29	86	5.75	<b>\$916</b>	<b>\$126</b>
PN3084TOR	84 x 30 x 29	96	6.25	<b>\$1002</b>	<b>\$138</b>

Specify PNxxxxDOL for **left** or PNxxxxDOR for **right**.

Standard with square monopost and base. 30”D at overlapping end, 24”D at monopost end. Overlaps 27”H credenza opening or 27”H freestanding return. Grommet in worksurface. 1” spacer included. Shipped easy to assemble in 2 cartons.

**Recommended maximum modesty panel size:**

PN3072TOR/TOL: 30” wide (PN3013DMF)PN3084TOR/TOL: 36” wide (PN3613DMF)

**Required specifications**

Top finish  
Leg finish

**Optional specifications**

HP laminate  
RSG - no grommet  
PCSG - custom grommet

**Accessories**

Power block  
Keyboard tray  
Fabric desktop / M.P.  
Glass desktop panel  
Wire manager  
Keyboard mechanism  
Modesty panel

**CONFERENCE TOPS - OVERLAPPING**      **MODEL #**      **DIMENSIONS**      **WT/LB.**      **CUBIC FT.**      **LIST PRICE**      **HP ADD**

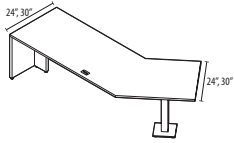

**LEFT**

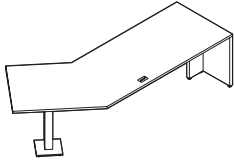

**RIGHT**

**Offset Conference Top for U Configurations**

à

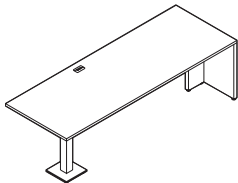

**LEFT**

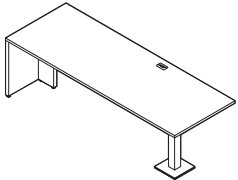

**RIGHT**

**Conference Top for U Configurations**

	<b>W x D x H</b>					
PN3090CUL	90 x 47 x 29	148	12.75	<b>\$1267</b>	<b>\$174</b>	
PN3096CUL	96 x 47 x 29	154	13.25	<b>\$1282</b>	<b>\$176</b>	
PN3090CUR	90 x 47 x 29	148	12.75	<b>\$1267</b>	<b>\$174</b>	
PN3096CUR	96 x 47 x 29	154	13.25	<b>\$1282</b>	<b>\$176</b>	

Specify PNxxxxCUL for **left** or PNxxxxCUR for **right**.

Standard with T base with square monopost and base. End panel is 1" thick. 1.5" thick support gable extends 12" for end panel. **Not freestanding, must be connected.** Connects to bridges. Grommet in worksurface. Shipped easy to assemble in 2 cartons.

**Recommended maximum modesty panel size:**

PN3090CUR/CUL: 60" wide (PN6013DMF)      PN3096CUR/CUL: 66" wide (PN6613DMF)

PN3072DUL	72 x 30 x 29	130	8.25	<b>\$1077</b>	<b>\$148</b>	
PN3084DUL	84 x 30 x 29	141	9.25	<b>\$1264</b>	<b>\$174</b>	
PN3072DUR	72 x 30 x 29	130	8.25	<b>\$1077</b>	<b>\$148</b>	
PN3084DUR	84 x 30 x 29	141	9.25	<b>\$1264</b>	<b>\$174</b>	

Specify PNxxxxDUL for **left** or PNxxxxDUR for **right**.

Standard with T base with square monopost and base. End panel is 1" thick. 1.5" thick support gable extends 12" for end panel. **Not freestanding, must be connected.** Connects to bridges. Grommet in worksurface. Shipped easy to assemble in 2 cartons.

**Recommended maximum modesty panel size:**

PN3072DUR/DUL: 48" wide (PN4813DMF)      PN3084DUR/DUL: 60" wide (PN6013DMF)

**Required specifications**

Top finish  
Leg finish

**Optional specifications**

HP laminate  
RSG - no grommet  
PCSG - custom grommet

**Accessories**

Power block      Wire manager  
Keyboard tray      Keyboard mechanism  
Fabric desktop / M.P.      Modesty panel  
Glass desktop panel

DESKTOP AND MODESTY PANELS

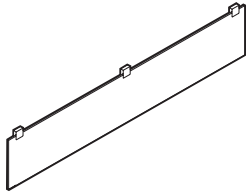

Fabric Desktop/Modesty Panel\*

MODEL # DIMENSIONS WT/LB. CUBIC FT. GR. 2 GR. 3

W x D x H

PN3013DMF	30 x 0.37 x 13	3	1	\$440	\$467
PN3613DMF	36 x 0.37 x 13	3.6	1	\$466	\$500
PN4213DMF	42 x 0.37 x 13	4.2	1	\$493	\$527
PN4813DMF	48 x 0.37 x 13	4.8	1.5	\$502	\$543
PN5413DMF	54 x 0.37 x 13	5.4	1.5	\$526	\$573
PN6013DMF	60 x 0.37 x 13	6	1.5	\$561	\$608
PN6613DMF	66 x 0.37 x 13	6.6	1.5	\$665	\$719
PN7213DMF	72 x 0.37 x 13	7.2	1.75	\$709	\$770
PN7813DMF	78 x 0.37 x 13	7.8	1.75	\$715	\$783

Panels up to 54"W have two clamps. Panels 60" and wider have three clamps. **When used as a modesty panel, specify a nominal size 6" shorter than worksurface size.** Non-tackable.

LIST PRICE

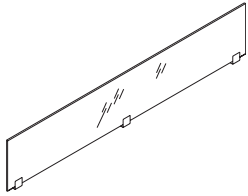

Glass Desktop Panel

PN3013DG	30 x 0.25 x 13	14	0.5	\$360
PN3613DG	36 x 0.25 x 13	16	0.5	\$376
PN4213DG	42 x 0.25 x 13	19	0.75	\$408
PN4813DG	48 x 0.25 x 13	21	0.75	\$424
PN5413DG	54 x 0.25 x 13	24	0.75	\$476
PN6013DG	60 x 0.25 x 13	26	1	\$559
PN6613DG	66 x 0.25 x 13	29	1	\$578
PN7213DG	72 x 0.25 x 13	31	1	\$594

Panels up to 54"W have two clamps. Panels 60" and wider have three clamps. **Cannot be used as a modesty panel.** There are no specifications for Glass Desktop Panel.

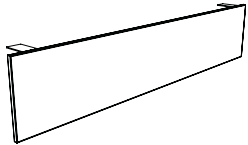

Laminate Desktop/Modesty Panel

PN3013DML	30 x 0.69 x 13	11	0.5	\$346
PN3613DML	36 x 0.69 x 13	13	0.5	\$375
PN4213DML	42 x 0.69 x 13	14	0.5	\$401
PN4813DML	48 x 0.69 x 13	16	0.75	\$419
PN5413DML	54 x 0.69 x 13	18	0.75	\$468
PN6013DML	60 x 0.69 x 13	19	0.75	\$552
PN6613DML	66 x 0.69 x 13	21	1	\$570
PN7213DML	72 x 0.69 x 13	23	1	\$587
PN7813DML	78 x 0.69 x 13	24	1	\$692
PN8413DML	84 x 0.69 x 13	26	1	\$855

Attaches to worksurface with "L" brackets. Panels up to 54"W have two brackets. Panels 60" and wider have three brackets. **When used as a modesty panel, specify a nominal size 6" shorter than worksurface size.** If using modesty with overlapping worksurface or lower storage, contact Customer Service.

Required specifications

Fabric\*

**PET DESKTOP AND MODESTY PANELS**

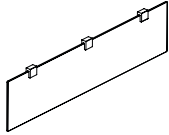

**PET Felt Desktop/Modesty Panel, 1 pk.**

MODEL #	DIMENSIONS W x D x H	WT/LB.	CUBIC FT.	LIST PRICE
PN3013PT9-1	30 x 0.36 x 12.5	2.48	0.6	<b>\$190</b>
PN3613PT9-1	36 x 0.36 x 12.5	2.74	0.7	<b>\$200</b>
PN4213PT9-1	42 x 0.36 x 12.5	2.99	0.8	<b>\$273</b>
PN4813PT9-1	48 x 0.36 x 12.5	3.85	0.9	<b>\$283</b>
PN5413PT9-1	54 x 0.36 x 12.5	4.11	1	<b>\$346</b>
PN6013PT9-1	60 x 0.36 x 12.5	4.36	1.1	<b>\$356</b>
PN6613PT9-1	66 x 0.36 x 12.5	5.22	1.3	<b>\$427</b>
PN7213PT9-1	72 x 0.36 x 12.5	5.48	1.4	<b>\$437</b>
PN7813PT9-1	78 x 0.36 x 12.5	5.73	1.5	<b>\$445</b>

PET Felt Desktop/Modesty Panel available in three finishes, please specify finish. 2, 3 or 4 clamps are included depending on width. Clamps available in satin anodized finish only. **When used as a modesty panel, specify a nominal size 6" shorter than worksurface size.**

- Up to 42" w - 2 clamps per
- 48"-60" w - 3 clamps per
- 66"-78" w - 4 clamps per

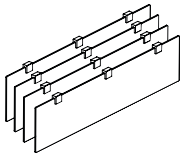

**PET Felt Desktop/Modesty Panel, 4 pk.**

PN3013PT9-4	30 x 0.36 x 12.5	8.9	0.6	<b>\$732</b>
PN3613PT9-4	36 x 0.36 x 12.5	9.9	0.7	<b>\$769</b>
PN4213PT9-4	42 x 0.36 x 12.5	10.8	0.8	<b>\$1053</b>
PN4813PT9-4	48 x 0.36 x 12.5	13.9	1	<b>\$1090</b>
PN5413PT9-4	54 x 0.36 x 12.5	14.8	1.1	<b>\$1334</b>
PN6013PT9-4	60 x 0.36 x 12.5	15.7	1.2	<b>\$1366</b>
PN6613PT9-4	66 x 0.36 x 12.5	18.8	1.3	<b>\$1649</b>
PN7213PT9-4	72 x 0.36 x 12.5	19.7	1.4	<b>\$1682</b>
PN7813PT9-4	78 x 0.36 x 12.5	20.6	1.5	<b>\$1713</b>

Pack of four PET Felt Desktop/Modesty Panels available in three finishes, please specify finish. 2, 3 or 4 clamps are included depending on width. Clamps available in satin anodized finish only. **When used as a modesty panel, specify a nominal size 6" shorter than worksurface size.**

- Up to 42" w - 2 clamps per
- 48"-60" w - 3 clamps per
- 66"-78" w - 4 clamps per

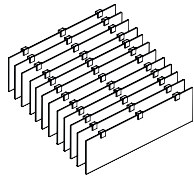

**PET Felt Desktop/Modesty Panel, 12 pk.**

PN3013PT9-12	30 x 0.36 x 12.5	25.3	1.9	<b>\$2159</b>
PN3613PT9-12	36 x 0.36 x 12.5	27.9	2.3	<b>\$2262</b>
PN4213PT9-12	42 x 0.36 x 12.5	30.5	2.6	<b>\$3102</b>
PN4813PT9-12	48 x 0.36 x 12.5	39.3	3	<b>\$3202</b>
PN5413PT9-12	54 x 0.36 x 12.5	41.9	3.4	<b>\$3930</b>
PN6013PT9-12	60 x 0.36 x 12.5	44.5	3.7	<b>\$4017</b>
PN6613PT9-12	66 x 0.36 x 12.5	53.2	4.2	<b>\$4859</b>
PN7213PT9-12	72 x 0.36 x 12.5	55.9	4.5	<b>\$4947</b>
PN7813PT9-12	78 x 0.36 x 12.5	58.5	4.9	<b>\$5036</b>

Pack of twelve PET Felt Desktop/Modesty Panels available in three finishes, please specify finish. 2, 3 or 4 clamps are included depending on width. Clamps available in satin anodized finish only. **When used as a modesty panel, specify a nominal size 6" shorter than worksurface size.**

- Up to 42" w - 2 clamps per
- 48"-60" w - 3 clamps per
- 66"-78" w - 4 clamps per

**Required specifications**

Fabric\*

**29"H CREDENZAS**

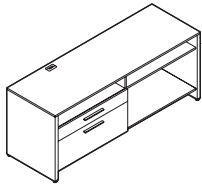

**29"H Credenza - LEFT**

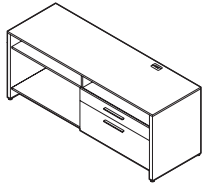

**29"H Credenza - RIGHT**

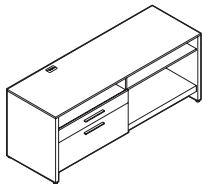

**29"H Credenza w/Pull-Out Equipment Tray - LEFT**

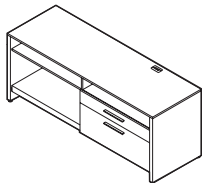

**29"H Credenza w/Pull-Out Equipment Tray - RIGHT**

MODEL #	DIMENSIONS W x D x H	WT/LB.	CUBIC FT.	LIST PRICE	HP ADD
PN2984CRL	84 x 24 x 29	329	43	<b>\$1794</b>	<b>\$211</b>
PN2978CRL	78 x 24 x 29	313	38.25	<b>\$1751</b>	<b>\$211</b>
PN2972CRL	72 x 24 x 29	298	35.6	<b>\$1703</b>	<b>\$209</b>
PN2966CRL	66 x 24 x 29	285	32.75	<b>\$1682</b>	<b>\$208</b>
PN2960CRL	60 x 24 x 29	269	29.8	<b>\$1655</b>	<b>\$196</b>

Standard with locking 34"W box and lateral file drawer on **left**. File bars included for front-to-back letter/legal filing capability. Lock on file drawer secures both drawers. Adjustable 6 position shelf. Wire management grommet on surface and internal pass-through behind equipment shelf. Connects to flush returns, flush bridges and flush conference tops. Shipped assembled in 1 carton.

PN2984CRR	84 x 24 x 29	329	43	<b>\$1794</b>	<b>\$211</b>
PN2978CRR	78 x 24 x 29	313	38.25	<b>\$1751</b>	<b>\$211</b>
PN2972CRR	72 x 24 x 29	298	35.6	<b>\$1703</b>	<b>\$209</b>
PN2966CRR	66 x 24 x 29	285	32.75	<b>\$1682</b>	<b>\$208</b>
PN2960CRR	60 x 24 x 29	269	29.8	<b>\$1655</b>	<b>\$196</b>

Standard with locking 34"W box and lateral file drawer on **right**. File bars included for front-to-back letter/legal filing capability. Lock on file drawer secures both drawers. Adjustable 6 position shelf. Wire management grommet on surface and internal pass-through behind equipment shelf. Connects to flush returns, flush bridges and flush conference tops. Shipped assembled in 1 carton.

PN2984CPL	84 x 24 x 29	354	43	<b>\$2025</b>	<b>\$226</b>
PN2978CPL	78 x 24 x 29	336	38.25	<b>\$1970</b>	<b>\$224</b>
PN2972CPL	72 x 24 x 29	318	35.6	<b>\$1923</b>	<b>\$223</b>
PN2966CPL	66 x 24 x 29	301	32.75	<b>\$1850</b>	<b>\$218</b>
PN2960CPL	60 x 24 x 29	282	29.8	<b>\$1801</b>	<b>\$205</b>

Standard with locking 34"W box and lateral file drawer on **left**. File bars included for front-to-back letter/legal filing capability. Lock on file drawer secures both drawers. Adjustable 6 position shelf. Pull-out equipment shelf can support up to 80 lbs. Wire management grommet on surface and internal pass-through behind equipment shelf. Connects to flush returns, flush bridges and flush conference tops. Shipped assembled in 1 carton.

PN2984CPR	84 x 24 x 29	354	43	<b>\$2025</b>	<b>\$226</b>
PN2978CPR	78 x 24 x 29	336	38.25	<b>\$1970</b>	<b>\$224</b>
PN2972CPR	72 x 24 x 29	318	35.6	<b>\$1923</b>	<b>\$223</b>
PN2966CPR	66 x 24 x 29	301	32.75	<b>\$1850</b>	<b>\$218</b>
PN2960CPR	60 x 24 x 29	282	29.8	<b>\$1801</b>	<b>\$205</b>

Standard with locking 34"W box and lateral file drawer on **right**. File bars included for front-to-back letter/legal filing capability. Lock on file drawer secures both drawers. Adjustable 6 position shelf. Pull-out equipment shelf can support up to 80 lbs. Wire management grommet on surface and internal pass-through behind equipment shelf. Connects to flush returns, flush bridges and flush conference tops. Shipped assembled in 1 carton.

**Required specifications**

Top finish  
Base finish  
Drawer front finish

**Optional specifications**

RSG - no grommet  
HP laminate



**29" H CREDENZAS**      **MODEL #**      **DIMENSIONS**      **WT/LB.**      **CUBIC FT.**      **LIST PRICE**      **HP ADD**

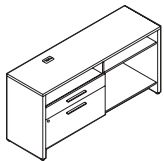

**LEFT**

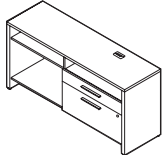

**RIGHT**

**29" H Narrow Credenza\***

	W x D x H					
PN2954NCL	54 x 20 x 29	227	22.7	<b>\$1641</b>	<b>\$224</b>	
PN2960NCL	60 x 20 x 29	239	25.5	<b>\$1661</b>	<b>\$229</b>	
PN2954NCR	54 x 20 x 29	227	22.7	<b>\$1641</b>	<b>\$224</b>	
PN2960NCR	60 x 20 x 29	239	25.5	<b>\$1661</b>	<b>\$229</b>	

Specify PNxxxxNCL for **left** or PNxxxxNCR for **right**.

20" deep. Standard with 30"W box and lateral file drawer. Front-to-back letter/legal filing capability. Lock on file drawer secures both drawers. Adjustable 6 position shelf. Wire management grommet on surface and internal pass-through behind lower shelf. Connects to flush returns, flush bridges and flush conference tops. File bars included. Shipped assembled in 1 carton.

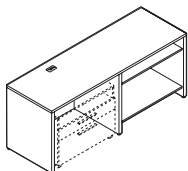

**LEFT**

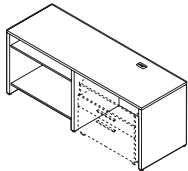

**RIGHT**

**29" H Credenza for Mobile Lateral File**

PN2972MCL	72 x 24 x 29	218	35.6	<b>\$1340</b>	<b>\$183</b>	
PN2984MCL	84 x 24 x 29	248	43	<b>\$1447</b>	<b>\$197</b>	
PN2972MCR	72 x 24 x 29	218	35.6	<b>\$1340</b>	<b>\$183</b>	
PN2984MCR	84 x 24 x 29	248	43	<b>\$1447</b>	<b>\$197</b>	

Specify PNxxxxMCL for **left** or PNxxxxMCR for **right**.

Standard with 42"W space for lateral file. Adjustable 6 position shelf. Wire management grommet on surface and internal pass-through behind lower shelf. Connects to flush returns, flush bridges and flush conference tops. Accepts all mobile lateral file units. Shipped assembled in 1 carton.

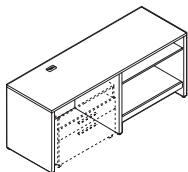

**LEFT**

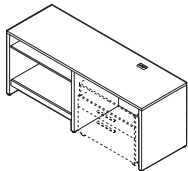

**RIGHT**

**29" H Credenza for Mobile Lateral File w/Pull-Out Equipment Tray**

PN2972MPL	72 x 24 x 29	235	35.6	<b>\$1534</b>	<b>\$210</b>	
PN2984MPL	84 x 24 x 29	270	43	<b>\$1634</b>	<b>\$224</b>	
PN2972MPR	72 x 24 x 29	235	35.6	<b>\$1534</b>	<b>\$210</b>	
PN2984MPR	84 x 24 x 29	270	43	<b>\$1634</b>	<b>\$224</b>	

Specify PNxxxxMPL for **left** or PNxxxxMPR for **right**.

Standard with 42"W space for lateral file, adjustable 6 position shelf, and pull-out equipment shelf that can support up to 80 lbs. Grommet in worksurface and internal pass-through behind equipment shelf. Connects to flush returns, flush bridges and flush conference tops. Accepts all mobile lateral file units. Shipped assembled in 1 carton.

**Required specifications**

Top finish  
Base finish  
Drawer front finish\*

**Optional specifications**

HP laminate  
RSG - no grommet

29" H CREDENZAS	MODEL #	DIMENSIONS	WT/LB.	CUBIC FT.	LIST PRICE	HP ADD
-----------------	---------	------------	--------	-----------	------------	--------

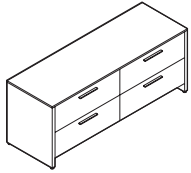

**29" H Lateral File Credenza**

	W x D x H					
PN2972LF	72 x 24 x 29	315	35.6	<b>\$2023</b>	<b>\$269</b>	

Standard with four lateral file drawers. File bars included for front-to-back letter/legal filing capability. Lock on lower drawer secures both drawers. Anti-tip mechanism. Shipped assembled in 1 carton.

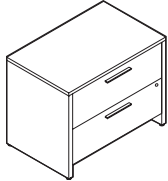

**29" H Single Lateral File Credenza**

PN2937LFS	37 x 24 x 29	199	19	<b>\$1369</b>	<b>\$189</b>	
-----------	--------------	-----	----	---------------	--------------	--

Standard with two lateral file drawers. File bars included for front-to-back letter/legal filing capability. Lock on lower drawer secures both drawers. Anti-tip mechanism. Shipped assembled in 1 carton.

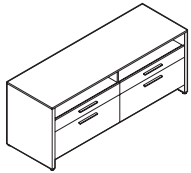

**29" H Double Credenza**

PN2972CRD	72 x 24 x 29	357	36.5	<b>\$1948</b>	<b>\$244</b>	
-----------	--------------	-----	------	---------------	--------------	--

Standard with 34" W box and lateral file drawer on each side. File bars included for front-to-back letter/legal filing capability. Lock on file drawer secures both drawers. Shipped assembled in 1 carton.

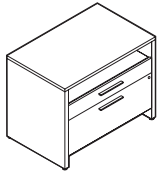

**29" H Single Credenza**

PN2937CRS	37 x 24 x 29	200	19	<b>\$1370</b>	<b>\$189</b>	
-----------	--------------	-----	----	---------------	--------------	--

Standard with 34" W box and lateral file drawer. File bars included for front-to-back letter/legal filing capability. Lock on file drawer secures both drawers. Shipped assembled in 1 carton.

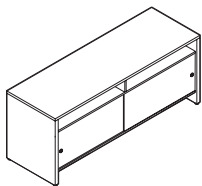

**29" H Credenza w/Sliding Laminate Doors**

PN2960CLS	60 x 24 x 29	229	29.8	<b>\$1589</b>	<b>\$218</b>	
PN2972CLS	72 x 24 x 29	263	35.6	<b>\$1665</b>	<b>\$229</b>	
PN2984CLS	84 x 24 x 29	297	43	<b>\$1817</b>	<b>\$248</b>	

Standard with sliding laminate doors in upper plastic track. Recessed brushed aluminum finger pulls. No lock. Shipped assembled in 1 carton.

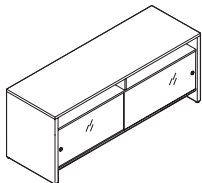

**29" H Credenza w/Sliding Glass Doors**

PN2960CGS	60 x 24 x 29	235.5	31.2	<b>\$2003</b>	<b>\$274</b>	
PN2972CGS	72 x 24 x 29	270.5	37.3	<b>\$2218</b>	<b>\$303</b>	
PN2984CGS	84 x 24 x 29	306	45	<b>\$2451</b>	<b>\$335</b>	

Standard with sliding glass doors in upper aluminum track. Acid etched 6mm glass. Brushed aluminum finger pulls. No lock. Shipped assembled in 2 cartons (glass doors shipped separately).

**Required specifications**

- Top finish
- Base finish
- Drawer front finish
- Door finish (only PN29xxCLS)

**Optional specifications**

- HP laminate

**29" H CREDENZAS**

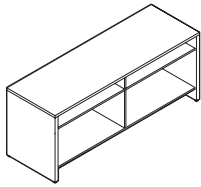

**29" H Open Credenza**

MODEL #	DIMENSIONS W x D x H	WT/LB.	CUBIC FT.	LIST PRICE	HP ADD
PN2960CO	60 x 24 x 29	210	29.8	<b>\$1334</b>	<b>\$183</b>
PN2972CO	72 x 24 x 29	241	35.6	<b>\$1413</b>	<b>\$194</b>
PN2984CO	84 x 24 x 29	272	43	<b>\$1569</b>	<b>\$215</b>

Open storage with adjustable 6 position upper shelves with pass-throughs at back of lower shelves. Connects to flush returns, flush bridges and flush conference tops. Shipped assembled in 1 carton

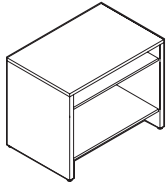

**29" H Single Open Credenza**

PN2930CO	30 x 24 x 29	126	15	<b>\$857</b>	<b>\$117</b>
PN2936CO	36 x 24 x 29	141	18.5	<b>\$897</b>	<b>\$123</b>

Open storage with adjustable 6 position upper shelf with pass-through at back of lower shelf. Connects to flush returns, flush bridges and flush conference tops. Shipped assembled in 1 carton.

**27" H CREDENZAS**

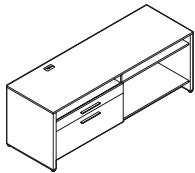

**27" H Credenza - LEFT**

PN2760CRL	60 x 24 x 27	269	28	<b>\$1642</b>	<b>\$191</b>
PN2766CRL	66 x 24 x 27	285	32.75	<b>\$1667</b>	<b>\$196</b>
PN2772CRL	72 x 24 x 27	298	33.5	<b>\$1682</b>	<b>\$202</b>
PN2778CRL	78 x 24 x 27	313	38.25	<b>\$1733</b>	<b>\$205</b>
PN2784CRL	84 x 24 x 27	322	36	<b>\$1776</b>	<b>\$208</b>

Standard with locking 34"W box and lateral file drawer on **left**. File bars included for front-to-back letter/legal filing capability. Lock on file drawer secures both drawers. Adjustable 6 position shelf. Wire management grommet on surface and internal pass-through behind equipment shelf. Supports overlapping returns, bridges and conference tops that have a 1" spacer (example: PN24600MR). Cannot nest under 29"H products with metal legs. Shipped assembled in 1 carton.

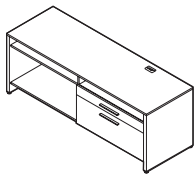

**27" H Credenza - RIGHT**

PN2760CRR	60 x 24 x 27	269	28	<b>\$1642</b>	<b>\$191</b>
PN2766CRR	66 x 24 x 27	285	32.75	<b>\$1667</b>	<b>\$196</b>
PN2772CRR	72 x 24 x 27	298	33.5	<b>\$1682</b>	<b>\$202</b>
PN2778CRR	78 x 24 x 27	313	38.25	<b>\$1733</b>	<b>\$205</b>
PN2784CRR	84 x 24 x 27	322	36	<b>\$1776</b>	<b>\$208</b>

Standard with locking 34"W box and lateral file drawer on **right**. File bars included for front-to-back letter/legal filing capability. Lock on file drawer secures both drawers. Adjustable 6 position shelf. Wire management grommet on surface and internal pass-through behind equipment shelf. Supports overlapping returns, bridges and conference tops that have a 1" spacer (example: PN24600MR). Cannot nest under 29"H products with metal legs. Shipped assembled in 1 carton.

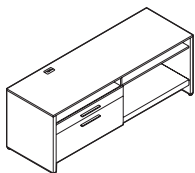

**27" H Credenza w/Pull-Out Equipment Tray - LEFT**

PN2760CPL	60 x 24 x 27	275	28	<b>\$1788</b>	<b>\$197</b>
PN2766CPL	66 x 24 x 27	295	32.75	<b>\$1834</b>	<b>\$209</b>
PN2772CPL	72 x 24 x 27	311	33.5	<b>\$1907</b>	<b>\$214</b>
PN2778CPL	78 x 24 x 27	328	38.25	<b>\$1955</b>	<b>\$219</b>
PN2784CPL	84 x 24 x 27	347	36	<b>\$2010</b>	<b>\$226</b>

Standard with locking 34"W box and lateral file drawer on **left**. File bars included for front-to-back letter/legal filing capability. Lock on file drawer secures both drawers. Adjustable 6 position shelf. Pull-out equipment tray can support up to 80 lbs. Wire management grommet on surface and internal pass-through behind equipment shelf. Supports overlapping returns, bridges and conference tops that have a 1" spacer (example: PN24600MR). Cannot nest under 29"H products with metal legs. Shipped assembled in 1 carton.

**Required specifications**

Top finish  
Base finish

**Optional specifications**

HP laminate

**27" H CREDENZAS**

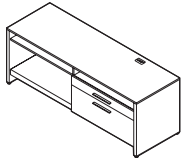

**27" H Credenza w/Pull-Out Equipment Tray - RIGHT**

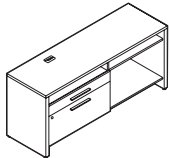

**LEFT**

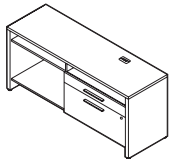

**RIGHT**

**27" H Narrow Credenza\***

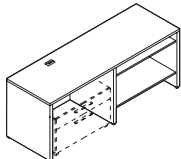

**LEFT**

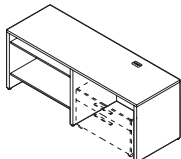

**RIGHT**

**27" H Credenza for Mobile Lateral File**

MODEL #	DIMENSIONS W x D x H	WT/LB.	CUBIC FT.	LIST PRICE	HP ADD
PN2760CPR	60 x 24 x 27	275	28	<b>\$1788</b>	<b>\$197</b>
PN2766CPR	66 x 24 x 27	295	32.75	<b>\$1834</b>	<b>\$209</b>
PN2772CPR	72 x 24 x 27	311	33.5	<b>\$1907</b>	<b>\$214</b>
PN2778CPR	78 x 24 x 27	328	38.25	<b>\$1955</b>	<b>\$219</b>
PN2784CPR	84 x 24 x 27	347	36	<b>\$2010</b>	<b>\$226</b>

Standard with locking 34"W box and lateral file drawer on **right**. File bars included for front-to-back letter/legal filing capability. Lock on file drawer secures both drawers. Adjustable 6 position shelf. Pull-out equipment tray can support up to 80 lbs. Wire management grommet on surface and internal pass-through behind equipment shelf. Supports overlapping returns, bridges and conference tops that have a 1" spacer (example: PN2460OMR). Cannot nest under 29"H products with metal legs. Shipped assembled in 1 carton.

PN2754NCL	54 x 20 x 27	218	21.5	<b>\$1596</b>	<b>\$218</b>
PN2760NCL	60 x 20 x 27	232	23.5	<b>\$1617</b>	<b>\$222</b>
PN2754NCR	54 x 20 x 27	218	21.5	<b>\$1596</b>	<b>\$218</b>
PN2760NCR	60 x 20 x 27	232	23.5	<b>\$1617</b>	<b>\$222</b>

Specify PNxxxxNCL for **left** or PNxxxxNCR for **right**.

20" deep. Standard with 30"W box and lateral file drawer. Front-to-back letter/legal filing capability. Lock on file drawer secures both drawers. Adjustable 6 position shelf. Wire management grommet on surface and internal pass-through at back of lower shelf. Supports overlapping returns, bridges and conference tops that have a 1" spacer (example: PN2460OMR). Cannot nest under 29"H products with metal legs. File bars included. Shipped assembled in 1 carton.

PN2772MCL	72 x 24 x 27	210	33.5	<b>\$1325</b>	<b>\$181</b>
PN2784MCL	84 x 24 x 27	228	36	<b>\$1428</b>	<b>\$196</b>
PN2772MCR	72 x 24 x 27	210	33.5	<b>\$1325</b>	<b>\$181</b>
PN2784MCR	84 x 24 x 27	228	36	<b>\$1428</b>	<b>\$196</b>

Specify PNxxxxMCL for **left** or PNxxxxMCR for **right**.



Standard with 42"W space for lateral file. Adjustable 6 position shelf. Wire management grommet on surface and internal pass-through at back of lower shelf. Supports overlapping returns, bridges and conference tops that have a 1" spacer (example: PN2460OMR). Cannot nest under 29"H products with metal legs. Accepts mobile lateral file unit: PN22MLBF with and without cushions, and PN25MLSBF without cushions. Shipped assembled in 1 carton.

**Required specifications**

Top finish  
Base finish  
Drawer front finish\*

**Optional specifications**

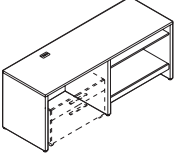
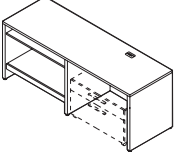
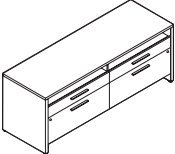
HP laminate  
RSG - no grommet

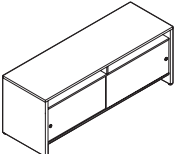
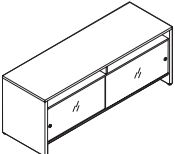
27" H CREDENZAS		MODEL #	DIMENSIONS	WT/LB.	CUBIC FT.	LIST PRICE	HP ADD
		W x D x H					
	<b>LEFT</b>	PN2772MPL	72 x 24 x 27	240	33.5	<b>\$1519</b>	<b>\$208</b>
		PN2784MPL	84 x 24 x 27	263	36	<b>\$1617</b>	<b>\$222</b>
	<b>RIGHT</b>	PN2772MPR	72 x 24 x 27	240	33.5	<b>\$1519</b>	<b>\$208</b>
		PN2784MPR	84 x 24 x 27	263	36	<b>\$1617</b>	<b>\$222</b>
<b>27" H Credenza for Mobile Lateral File w/Pull-Out Equipment Tray</b>		Standard with 42"W space for lateral file, adjustable 6 position shelf, and pull-out equipment shelf that can support up to 80 lbs. Wire management grommet in surface and internal pass-through at back of pull-out equipment shelf. Supports overlapping returns, bridges and conference tops that have a 1" spacer (example: PN2460OMR). Cannot nest under 29"H products with metal legs. Accepts mobile lateral file unit: PN22MLBF with and without cushions, and PN25MLSFB <u>without cushions</u> . Shipped assembled in 1 carton.					
	<b>27" H Double Credenza</b>	PN2772CRD	72 x 24 x 27	351	33.5	<b>\$1911</b>	<b>\$244</b>
		Standard with locking 34"W box and lateral file drawer on each side. File bars included for front-to-back letter/legal filing capability. Lock on file drawer secures both drawers. Shipped assembled in 1 carton.					
	<b>27" H Single Credenza</b>	PN2737CRS	37 x 24 x 27	196	17.75	<b>\$1332</b>	<b>\$181</b>
		Standard with 34"W box and lateral file drawer. Lock on file drawer secures both drawers. File bars included for front-to-back letter/legal filing capability. Shipped assembled in 1 carton.					
	<b>27" H Credenza w/Sliding Laminate Doors</b>	PN2760CLS	60 x 24 x 27	222	28	<b>\$1571</b>	<b>\$215</b>
		PN2772CLS	72 x 24 x 27	256	33.5	<b>\$1649</b>	<b>\$226</b>
		PN2784CLS	84 x 24 x 27	289	36	<b>\$1799</b>	<b>\$247</b>
		Standard with sliding laminate doors in upper plastic track. Recessed brushed aluminum finger pulls. No lock. Shipped assembled in 1 carton.					
	<b>27" H Credenza w/Sliding Glass Doors</b>	PN2760CGS	60 x 24 x 27	227.5	29.4	<b>\$1988</b>	<b>\$271</b>
		PN2772CGS	72 x 24 x 27	264	35.2	<b>\$2211</b>	<b>\$303</b>
		PN2784CGS	84 x 24 x 27	298	38	<b>\$2432</b>	<b>\$333</b>
		Standard with sliding glass doors in upper aluminum track. Acid etched 6mm glass. Brushed aluminum finger pulls. No lock. Shipped assembled in 2 cartons (glass doors shipped separately).					

**Required specifications**

- Top finish
- Base finish
- Drawer front finish\*
- Door finish\*\*

**Optional specifications**

- HP laminate
- RSG - no grommet

**27"H CREDENZAS**

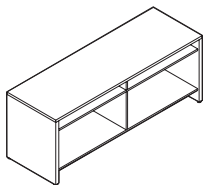

**27" Open Credenza**

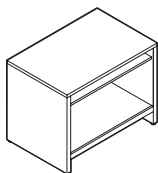

**27" Single Open Credenza**

MODEL #	DIMENSIONS W x D x H	WT/LB.	CUBIC FT.	LIST PRICE	HP ADD
PN2760CO	60 x 24 x 27	203	28	<b>\$1334</b>	<b>\$183</b>
PN2772CO	72 x 24 x 27	232	33.5	<b>\$1413</b>	<b>\$194</b>
PN2784CO	84 x 24 x 27	261	36	<b>\$1569</b>	<b>\$215</b>

Open storage with adjustable 6 position upper shelves with pass-throughs at back of lower shelves. Supports overlapping returns, bridges and conference tops that have a 1" spacer (example: PN24600MR). Cannot nest under 29"H products with metal legs. Shipped assembled in 1 carton.

PN2730CO	30 x 24 x 27	121	15.5	<b>\$842</b>	<b>\$115</b>
PN2736CO	36 x 24 x 27	135	17.5	<b>\$881</b>	<b>\$122</b>

Open storage with adjustable 6 position upper shelf with pass-through at back of lower shelf. Supports overlapping returns, bridges and conference tops that have a 1" spacer (example: PN24600MR). Cannot nest under 29"H products with metal legs. Shipped assembled in 1 carton.

**23"H CREDENZAS**

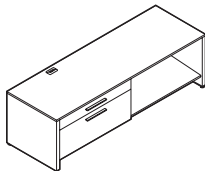

**LEFT**

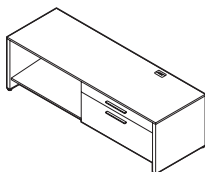

**RIGHT**

**23" H Credenza\***

PN2360CRL	60 x 24 x 23	224	24.25	<b>\$1368</b>	<b>\$175</b>
PN2366CRL	66 x 24 x 23	237	26.5	<b>\$1398</b>	<b>\$179</b>
PN2372CRL	72 x 24 x 23	247	28.75	<b>\$1421</b>	<b>\$181</b>
PN2378CRL	78 x 24 x 23	260	31.25	<b>\$1452</b>	<b>\$184</b>
PN2384CRL	84 x 24 x 23	271	34.5	<b>\$1480</b>	<b>\$190</b>

PN2360CRR	60 x 24 x 23	224	24.25	<b>\$1368</b>	<b>\$175</b>
PN2366CRR	66 x 24 x 23	237	26.5	<b>\$1398</b>	<b>\$179</b>
PN2372CRR	72 x 24 x 23	247	28.75	<b>\$1421</b>	<b>\$181</b>
PN2378CRR	78 x 24 x 23	260	31.25	<b>\$1452</b>	<b>\$184</b>
PN2384CRR	84 x 24 x 23	271	34.5	<b>\$1480</b>	<b>\$190</b>

Specify PNxxxxCRL for **left** or PNxxxxCRR for **right**.

Standard with 34"W box and lateral file drawer. File bars included for front-to-back letter/legal filing capability. Lock on file drawer secures both drawers. Wire management grommet as shown on surface and internal pass-through at back of lower shelf. Supports overlapping returns with metal leg and spacer for 23"H credenza, overlapping tapered return with metal leg and spacer for 23"H credenza, and overlapping bridges with metal spacer for 23"H credenza. Shipped assembled in 1 carton.

**Required specifications**

Top finish  
Base finish  
Drawer front finish\*

**Optional specifications**

RSG - no grommet\*  
HP laminate

**Accessories**

Cushion\*

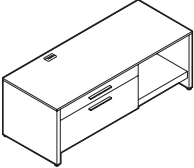
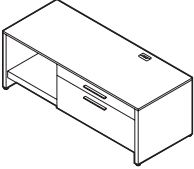
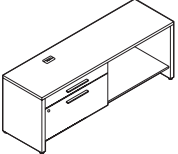
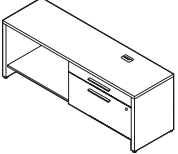
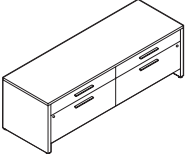
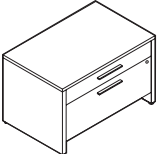
23"H CREDENZAS		MODEL #	DIMENSIONS	WT/LB.	CUBIC FT.	LIST PRICE	HP ADD
		W x D x H					
	LEFT	PN2360CPL	60 x 24 x 23	237	24.25	<b>\$1550</b>	<b>\$184</b>
		PN2366CPL	66 x 24 x 23	253	26.5	<b>\$1600</b>	<b>\$193</b>
		PN2372CPL	72 x 24 x 23	267	28.75	<b>\$1654</b>	<b>\$193</b>
		PN2378CPL	78 x 24 x 23	282	31.25	<b>\$1692</b>	<b>\$196</b>
		PN2384CPL	84 x 24 x 23	296	34.5	<b>\$1724</b>	<b>\$200</b>
	RIGHT	PN2360CPR	60 x 24 x 23	237	24.25	<b>\$1550</b>	<b>\$184</b>
		PN2366CPR	66 x 24 x 23	253	26.5	<b>\$1600</b>	<b>\$193</b>
		PN2372CPR	72 x 24 x 23	267	28.75	<b>\$1654</b>	<b>\$193</b>
		PN2378CPR	78 x 24 x 23	282	31.25	<b>\$1692</b>	<b>\$196</b>
		PN2384CPR	84 x 24 x 23	296	34.5	<b>\$1724</b>	<b>\$200</b>
<p><b>23"H Credenza w/Pull-Out Equipment Tray - RIGHT*</b></p>		<p>Specify PNxxxxCRL for <b>left</b> or PNxxxxCRR for <b>right</b>.</p> <p>Standard with 34"W box and lateral file drawer. Pull-out equipment shelf can support up to 80 lbs. Adjustable 6 position shelf. File bars included for front-to-back letter/legal filing capability. Lock on file drawer secures both drawers. Wire management grommet as shown on surface and internal pass-through at back of lower shelf. Supports overlapping return with metal leg and spacer for 23"H credenza, overlapping tapered return with metal leg and spacer for 23"H credenza, and overlapping bridges with metal spacer for 23"H credenza. Shipped assembled in 1 carton.</p>					
	LEFT	PN2354NCL	54 x 20 x 23	187	18.3	<b>\$1338</b>	<b>\$183</b>
		PN2360NCL	60 x 20 x 23	200	20.5	<b>\$1344</b>	<b>\$184</b>
	RIGHT	PN2354NCR	54 x 20 x 23	187	18.3	<b>\$1338</b>	<b>\$183</b>
		PN2360NCR	60 x 20 x 23	200	20.5	<b>\$1344</b>	<b>\$184</b>
<p><b>23"H Narrow Credenza*</b></p>		<p>Specify PNxxxxNCL for <b>left</b> or PNxxxxNCR for <b>right</b>.</p> <p>20" deep. Standard with 30"W box and lateral file drawer. File bars included for front-to-back letter/legal filing capability. Lock on file drawer secures both drawers. Wire management grommet as shown on surface and internal pass-through at back of lower shelf. Supports overlapping return with metal leg and spacer for 23"H credenza, overlapping tapered return with metal leg and spacer for 23"H credenza, and overlapping bridges with metal spacer for 23"H credenza. Shipped assembled in 1 carton.</p>					
	<p><b>23"H Double Credenza</b></p> <p>Standard with locking 34"W box and lateral file drawer on each side. File bars included for front-to-back letter/legal filing capability. Lock on file drawer secures both drawers. Shipped assembled in 1 carton.</p>						
	<p><b>23"H Single Credenza</b></p> <p>Standard with 34"W box and lateral file drawer. File bars included for front-to-back letter/legal filing capability. Lock on file drawer secures both drawers. Shipped assembled in 1 carton.</p>						

**Required specifications**

Top finish  
Base finish  
Drawer front finish

**Optional specifications**

HP laminate  
RSG - no grommet\*

**Accessories**

Cushion

**23"H CRENZAS**

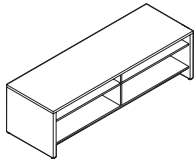

**23"H Open Credenza**

**MODEL #      DIMENSIONS      WT/LB.      CUBIC FT.      LIST PRICE      HP ADD**

	<b>W x D x H</b>				
PN2360CO	60 x 24 x 23	187	24.25	<b>\$1177</b>	<b>\$162</b>
PN2372CO	72 x 24 x 23	216	28.75	<b>\$1279</b>	<b>\$175</b>
PN2384CO	84 x 24 x 23	244	34.5	<b>\$1423</b>	<b>\$195</b>

Open storage with adjustable 6 position upper shelves with pass-throughs at back of lower shelves. Supports overlapping return with metal leg and spacer for 23"H credenza, overlapping tapered return with metal leg and spacer for 23"H credenza, and overlapping bridges with metal spacer for 23"H credenza. Shipped assembled in 1 carton.

**Required specifications**

Top finish  
Base finish

**Optional specifications**

HP laminate

**Accessories**

Cushion



CUSHIONS FOR 23" H CREDENZAS

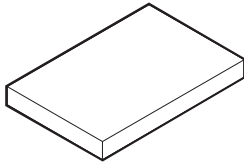

Cushion for 23" H Credenzas

MODEL #	DIMENSIONS	WT/LB.	CUBIC FT.	GRADE	LIST	GRADE	LIST
W x D x H							
PN2430CU	30 x 24 x 2.5	12	2.4	1	\$236	7	\$589
				2	\$284	8	\$650
				3	\$325	9	\$727
				4	\$371	10	\$799
				5	\$448	11	\$896
				6	\$518	12	\$1034
PN2433CU	33 x 24 x 2.5	12	2.4	1	\$262	7	\$732
				2	\$326	8	\$814
				3	\$380	9	\$916
				4	\$442	10	\$1012
				5	\$544	11	\$1142
				6	\$638	12	\$1326
PN2436CU	36 x 24 x 2.25	11	2.6	1	\$269	7	\$798
				2	\$341	8	\$890
				3	\$402	9	\$1005
				4	\$472	10	\$1113
				5	\$586	11	\$1259
				6	\$692	12	\$1466
PN2439CU	39 x 24 x 2.5	13	2.4	1	\$286	7	\$815
				2	\$358	8	\$907
				3	\$419	9	\$1022
				4	\$489	10	\$1130
				5	\$603	11	\$1276
				6	\$709	12	\$1483
PN2442CU	42 x 24 x 2.5	13	2.4	1	\$295	7	\$824
				2	\$367	8	\$916
				3	\$428	9	\$1031
				4	\$498	10	\$1139
				5	\$612	11	\$1285
				6	\$718	12	\$1492

Cushion attaches with Velcro strips. Fits **24" D** credenzas.

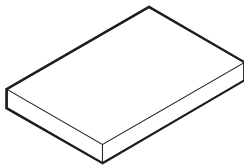

Cushion for 23" H Narrow Credenzas

PN2027CU	27 x 20 x 2.5	11	2.4	1	\$205	7	\$499
				2	\$245	8	\$550
				3	\$279	9	\$614
				4	\$318	10	\$674
				5	\$381	11	\$755
				6	\$440	12	\$870
PN2030CU	30 x 20 x 2.5	11	2.4	1	\$227	7	\$521
				2	\$267	8	\$572
				3	\$301	9	\$636
				4	\$340	10	\$696
				5	\$403	11	\$777
				6	\$462	12	\$892

Cushion attaches with Velcro strips. Fits **20" D** credenzas.

**Required specifications**

Fabric

**CUSHION FOR 23" HIGH CREDENZAS**

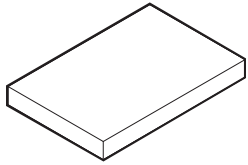

**Cushion for 23" H Single Credenza**

MODEL #	DIMENSIONS W x D x H	WT/LB.	CUBIC FT.	GRADE	LIST	GRADE	LIST
PN2437CU	37 x 24 x 2.5	13	2.4	1	<b>\$284</b>	7	<b>\$813</b>
				2	<b>\$356</b>	8	<b>\$905</b>
				3	<b>\$417</b>	9	<b>\$1020</b>
				4	<b>\$487</b>	10	<b>\$1128</b>
				5	<b>\$601</b>	11	<b>\$1274</b>
				6	<b>\$707</b>	12	<b>\$1481</b>

Cushion attaches with Velcro strips. Fits **PN2337CRS** credenza.

**52" H STORAGE CABINETS**

**LIST PRICE**

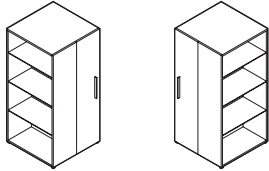

**LEFT**

**RIGHT**

**52" H Tower Wardrobe w/Full Height Bookcase**

PN52TWBL	24 x 24 x 51.5	147	21.5	<b>\$1306</b>
PN52TWBR	24 x 24 x 51.5	147	21.5	<b>\$1306</b>

Specify PN52TWBL for **left** or PN52TWBR for **right**.

Locking wardrobe with full height bookcase. Three adjustable laminate shelves with fixed bottom laminate shelf. Coat rail. Shipped assembled in 1 carton.

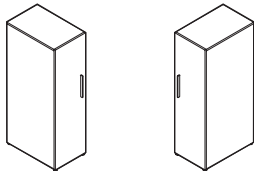

**LEFT**

**RIGHT**

**52" H Wardrobe**

PN1652WDL	16 x 24 x 51.5	105	15.25	<b>\$774</b>
PN1652WDR	16 x 24 x 51.5	105	15.25	<b>\$774</b>

Specify PN1652WDL for **left** or PN1652WDR for **right**.

Locking wardrobe with coat rail. Shipped assembled in 1 carton.

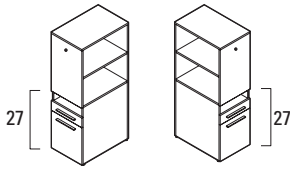

**LEFT**

**RIGHT**

**52" H Storage Cabinet w/Bookshelf at 27" H**

PN57CSBFL	16 x 24 x 51.5	131	15.25	<b>\$1116</b>
PN57CSBFR	16 x 24 x 51.5	131	15.25	<b>\$1116</b>

Specify PN57CSBFL for **left** or PN57CSBFR for **right**.

**Open shelf/box/file drawer.** Lock on file drawer secures both drawers. One adjustable laminate shelf. Fixed bottom shelf aligns with **27" H** surfaces. Outside accessory hook. Shipped assembled in 1 carton.

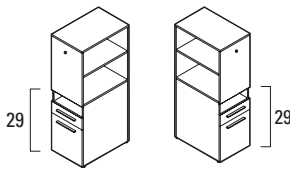

**LEFT**

**RIGHT**

**52" H Storage Cabinet w/Bookshelf at 29" H**

PN59CSBFL	16 x 24 x 51.5	131	15.25	<b>\$1135</b>
PN59CSBFR	16 x 24 x 51.5	131	15.25	<b>\$1135</b>

Specify PN59CSBFL for **left** or PN59CSBFR for **right**.

**Open shelf/box/file drawer.** Lock on file drawer secures both drawers. One adjustable laminate shelf. Fixed bottom shelf aligns with **29" H** surfaces. Outside accessory hook. Shipped assembled in 1 carton.

**Required specifications**

Top finish  
Base finish  
Fabric (only cushion)  
Door finish

**Optional specifications**

No lock

**52" H STORAGE CABINETS**      **MODEL #**      **DIMENSIONS**      **WT/LB.**      **CUBIC FT.**      **LIST PRICE**

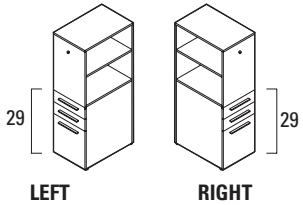

**52" H Storage Cabinet w/Bookshelf at 29" H**

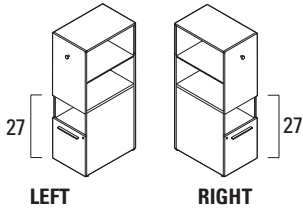

**52" H Recycling Cabinet w/Bookshelf at 27" H**

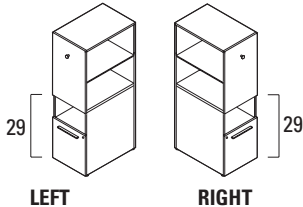

**52" H Recycling Cabinet w/Bookshelf at 29" H**

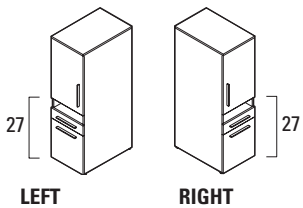

**52" H Storage Cabinet w/Door at 27" H**

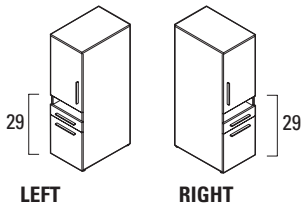

**52" H Storage Cabinet w/Door at 29" H**

W x D x H

PN59CBBFL	16 x 24 x 51.5	132	15.25	<b>\$1198</b>
PN59CBBFR	16 x 24 x 51.5	132	15.25	<b>\$1198</b>

Specify PN59CBBFL for **left** or PN59CBBFR for **right**.

**Box/box/file drawer.** Lock on file drawer secures both drawers. One adjustable laminate shelf. Fixed bottom shelf aligns with **29" H** surfaces. Outside accessory hook. Shipped assembled in 1 carton.

PN57RCSL	16 x 24 x 51.5	131	15.25	<b>\$1153</b>
PN57RCSR	16 x 24 x 51.5	131	15.25	<b>\$1153</b>

Specify PN57RCSL for **left** or PN57RCSR for **right**.

Drawer with one waste bin, one recycling bin and an open shelf above. One adjustable laminate shelf. Fixed bottom shelf aligns with **27" H** surfaces. Outside accessory hook. Shipped assembled in 1 carton.

PN59RCSL	16 x 24 x 51.5	131	15.25	<b>\$1165</b>
PN59RCSR	16 x 24 x 51.5	131	15.25	<b>\$1165</b>

Specify PN59RCSL for **left** or PN59RCSR for **right**.

Drawer with one waste bin, one recycling bin and an open shelf above. One adjustable laminate shelf. Fixed bottom shelf aligns with **29" H** surfaces. Outside accessory hook. Shipped assembled in 1 carton.

PN57DSBFL	16 x 24 x 51.5	137	15.25	<b>\$1245</b>
PN57DSBFR	16 x 24 x 51.5	137	15.25	<b>\$1245</b>

Specify PN57DSBFL for **left** or PN57DSBFR for **right**.

**Open shelf/box/file drawer.** Lock on file drawer secures both drawers. Upper storage cabinet with locking door and one adjustable laminate shelf inside. Door aligns with **27" H** surfaces. Shipped assembled in 1 carton.

PN59DSBFL	16 x 24 x 51.5	137	15.25	<b>\$1245</b>
PN59DSBFR	16 x 24 x 51.5	137	15.25	<b>\$1245</b>

Specify PN59DSBFL for **left** or PN59DSBFR for **right**.

**Open shelf/box/file drawer.** Lock on file drawer secures both drawers. Upper storage cabinet with locking door and one adjustable laminate shelf inside. Door aligns with **29" H** surfaces. Shipped assembled in 1 carton.

**Required specifications**

- Top finish
- Base finish
- Drawer/panel finish
- Door/drawer finish

**Optional specifications**

- No lock (where applicable)

52"H STORAGE CABINETS

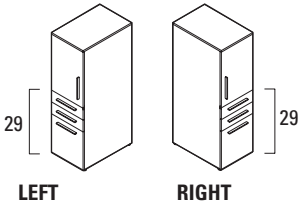

52"H Storage Cabinet w/Door at 29"H

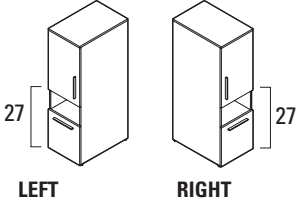

52"H Recycling Cabinet w/Door at 27"H

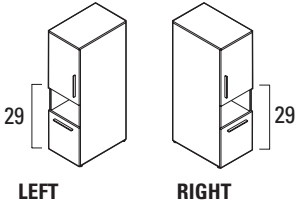

52"H Recycling Cabinet w/Door at 29"H

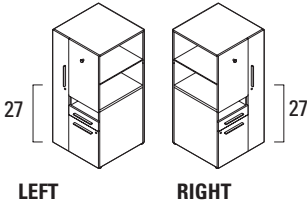

52"H Storage Tower w/Wardrobe, Shelf and Bookshelf at 27"H

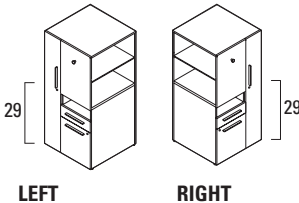

52"H Storage Tower w/Wardrobe, Shelf and Bookshelf at 29"H

MODEL # DIMENSIONS WT/LB. CUBIC FT. LIST PRICE

W x D x H

PN59DBBFL	16 x 24 x 51.5	139	15.25	<b>\$1347</b>
PN59DBBFR	16 x 24 x 51.5	139	15.25	<b>\$1347</b>

Specify PN59DBBFL for **left** or PN59DBBFR for **right**.

**Box/box/file drawer.** Lock on file drawer secures file and lower box drawers. Upper storage cabinet with locking door and one adjustable laminate shelf inside. Door aligns with **29"H** surfaces. Shipped assembled in 1 carton.

PN57DRCSL	16 x 24 x 51.5	138	15.25	<b>\$1139</b>
PN57DRCSR	16 x 24 x 51.5	138	15.25	<b>\$1139</b>

Specify PN57DRCSL for **left** or PN57DRCSR for **right**.

Upper storage cabinet with locking door. Drawer with one waste bin, one recycling bin, and an open shelf above. One adjustable laminate shelf inside locking cabinet door. Door aligns with **27"H** surfaces. Shipped assembled in 1 carton.

PN59DRCSL	16 x 24 x 51.5	137	15.25	<b>\$1157</b>
PN59DRCSR	16 x 24 x 51.5	137	15.25	<b>\$1157</b>

Specify PN59DRCSL for **left** or PN59DRCSR for **right**.

Upper storage cabinet with locking door. Drawer with one waste bin, one recycling bin, and an open shelf above. One adjustable laminate shelf inside locking cabinet door. Door aligns with **29"H** surfaces. Shipped assembled in 1 carton.

PN57TSBFL	24 x 24 x 51.5	180	21.5	<b>\$1611</b>
PN57TSBFR	24 x 24 x 51.5	180	21.5	<b>\$1611</b>

Specify PN57TSBFL for **left** or PN57TSBFR for **right**.

**Open shelf/box/file drawer.** Lock on file drawer secures both drawers. One adjustable laminate shelf. Fixed bottom shelf aligns with 27"H surfaces. Outside accessory hook and locking wardrobe with coat rail. Shipped assembled in 1 carton.

PN59TSBFL	24 x 24 x 51.5	180	21.5	<b>\$1364</b>
PN59TSBFR	24 x 24 x 51.5	180	21.5	<b>\$1364</b>

Specify PN59TSBFL for **left** or PN59TSBFR for **right**.

**Open shelf/box/file drawer.** Lock on file drawer secures both drawers. One adjustable laminate shelf. Fixed bottom shelf aligns with **29"H** surfaces. Outside accessory hook and locking wardrobe with coat rail. Shipped assembled in 1 carton.

**Required specifications**

Top finish \_\_\_\_\_ Panel finish\* \_\_\_\_\_  
 Base finish \_\_\_\_\_  
 Drawer finish \_\_\_\_\_  
 Door finish \_\_\_\_\_

**Optional specifications**

No lock (not PN57DRCSx) \_\_\_\_\_

**52" H STORAGE CABINETS**      **MODEL #**      **DIMENSIONS**      **WT/LB.**      **CUBIC FT.**      **LIST PRICE**

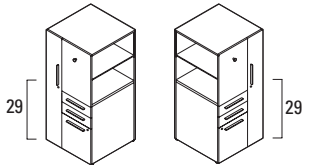

**LEFT**      **RIGHT**

**52" H Storage Tower w/Wardrobe, and Bookshelf at 29" H**

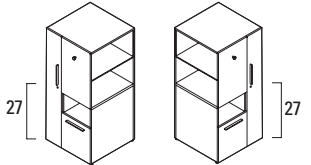

**LEFT**      **RIGHT**

**52" H Storage Tower w/Wardrobe, Shelf, Recycling and Bookshelf at 27" H**

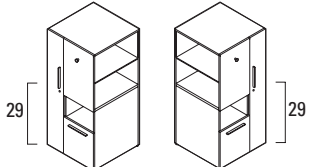

**LEFT**      **RIGHT**

**52" H Storage Tower w/Wardrobe, Shelf, Recycling and Bookshelf at 29" H**

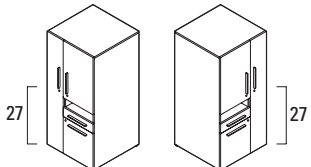

**LEFT**      **RIGHT**

**52" H Storage Tower w/Wardrobe, Shelf/Box/File and Door at 27" H**

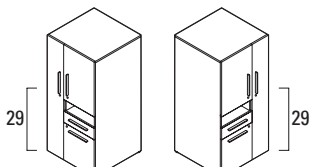

**LEFT**      **RIGHT**

**52" H Storage Tower w/Wardrobe, Shelf/Box/File and Door at 29" H**

	<b>W x D x H</b>			
PN59TBBFL	24 x 24 x 51.5	183	21.5	<b>\$1863</b>
PN59TBBFR	24 x 24 x 51.5	183	21.5	<b>\$1863</b>

Specify PN59TBBFL for **left** or PN59TBBFR for **right**.

**Box/box/file drawer.** Lock on file drawer secures file and lower box drawer. One adjustable laminate shelf. Fixed bottom shelf aligns with **29" H** surfaces. Outside accessory hook and locking wardrobe with coat rail. Shipped assembled in 1 carton.

PN57RTSL	24 x 24 x 51.5	181	21.5	<b>\$1729</b>
PN57RTSR	24 x 24 x 51.5	181	21.5	<b>\$1729</b>

Specify PN57RTSL for **left** or PN57RTSR for **right**.

**Drawer with one waste and one recycling bin.** Open shelf above. One adjustable laminate shelf. Fixed bottom shelf aligns with 27" H surfaces. Outside accessory hook. Locking wardrobe with coat rail. Shipped assembled in 1 carton.

PN59RTSL	24 x 24 x 51.5	181	21.5	<b>\$1729</b>
PN59RTSR	24 x 24 x 51.5	181	21.5	<b>\$1729</b>

Specify PN59RTSL for **left** or PN59RTSR for **right**.

Drawer with one waste and one recycling bin. Open shelf above. One adjustable laminate shelf. Fixed bottom shelf aligns with **29" H** surfaces. Outside accessory hook. Locking wardrobe with coat rail. Shipped assembled in 1 carton.

PN57SBFTL	24 x 24 x 51.5	187	21.5	<b>\$1811</b>
PN57SBFTR	24 x 24 x 51.5	187	21.5	<b>\$1811</b>

Specify PN57SBFTL for **left** or PN57SBFTR for **right**.

**Open shelf/box/file drawer.** Lock on file drawer secures both drawers. Upper storage cabinet with locking door and one adjustable laminate shelf inside. Door aligns with **27" H** surfaces. Locking wardrobe with coat rail. Shipped assembled in 1 carton.

PN59SBFTL	24 x 24 x 51.5	186	21.5	<b>\$1811</b>
PN59SBFTR	24 x 24 x 51.5	186	21.5	<b>\$1811</b>

Specify PN59SBFTL for **left** or PN59SBFTR for **right**.

**Open shelf/box/file drawer.** Lock on file drawer secures both drawers. Upper storage cabinet with locking door and one adjustable laminate shelf inside. Door aligns with 29" H surfaces. Locking wardrobe with coat rail. Shipped assembled in 1 carton.

**Required specifications**

- Top finish
- Base finish
- Drawer/panel finish
- Door finish

**Optional specifications**

- No lock

52"H STORAGE CABINETS

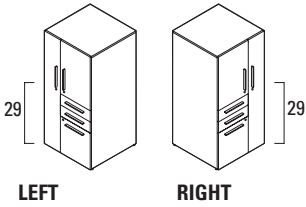

52"H Storage Tower w/Wardrobe, Shelf, Box/Box/File and Door at 29"H\*

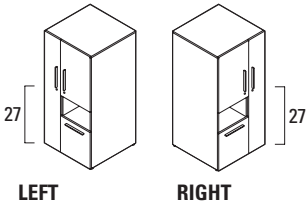

52"H Storage Tower w/Wardrobe, Shelf, Recycling and Door at 27"H\*

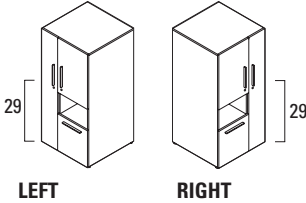

52"H Storage Tower w/Wardrobe, Shelf, Recycling and Door at 29"H\*

MODEL # DIMENSIONS WT/LB. CUBIC FT. LIST PRICE

W x D x H

PN59BBFTL	24 x 24 x 51.5	189	21.5	<b>\$1911</b>
PN59BBFTR	24 x 24 x 51.5	189	21.5	<b>\$1911</b>

Specify PN59BBFTL for **left** or PN59BBFTR for **right**.

**Box/box/file drawer.** Lock on file drawer secures file and lower box drawers. Upper storage cabinet with locking door and one adjustable laminate shelf inside. Door aligns with **29"H** surfaces. Locking wardrobe with coat rail. Shipped assembled in 1 carton.

PN57DRTSL	24 x 24 x 51.5	188	21.5	<b>\$1845</b>
PN57DRTSR	24 x 24 x 51.5	188	21.5	<b>\$1845</b>

Specify PN57DRTSL for **left** or PN57DRTSR for **right**.

Drawer with one waste and one recycling bin. Open shelf above. Upper storage cabinet with locking door and one adjustable laminate shelf inside. Door aligns with **27"H** surfaces. Locking wardrobe with coat rail. Shipped assembled in 1 carton.

PN59DRTSL	24 x 24 x 51.5	187	21.5	<b>\$1845</b>
PN59DRTSR	24 x 24 x 51.5	187	21.5	<b>\$1845</b>

Specify PN59DRTSL for **left** or PN59DRTSR for **right**.

Drawer with one waste and one recycling bin. Open shelf above. Upper storage cabinet with locking door and one adjustable laminate shelf inside. Door aligns with **29"H** surfaces. Locking wardrobe with coat rail. Shipped assembled in 1 carton.

66"H STORAGE CABINETS

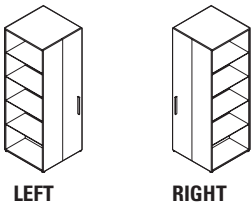

66"H Tower Wardrobe w/Full Height Bookcase

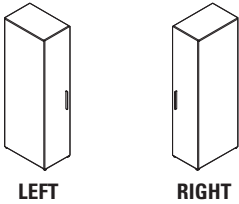

66"H Wardrobe\*\*

PN66TWBL	24 x 24 x 65.5	184	27	<b>\$1518</b>
PN66TWBR	24 x 24 x 65.5	184	27	<b>\$1518</b>

Specify PN66TWBL for **left** or PN66TWBR for **right**.

Locking wardrobe and full height bookcase. Four adjustable laminate shelves with fixed bottom laminate shelf. Coat rail. Shipped assembled in 1 carton.

PN1666WDL	16 x 24 x 65.5	133	19	<b>\$927</b>
PN1666WDR	16 x 24 x 65.5	133	19	<b>\$927</b>

Specify PN1666WDL for **left** or PN1666WDR for **right**.

Locking wardrobe with coat rail and fixed shelf above. Shipped assembled in 1 carton.

Required specifications

- Top finish
- Base finish
- Drawer finish\*
- Door finish\*\*

Optional specifications

- No lock

**66" H STORAGE CABINETS**      **MODEL #**      **DIMENSIONS**      **WT/LB.**      **CUBIC FT.**      **LIST PRICE**

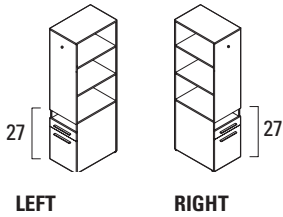

**66" H Storage Cabinet w/Bookshelf at 27" H**

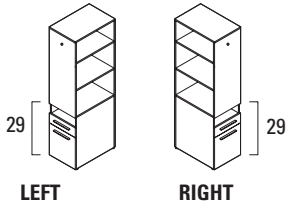

**66" H Storage Cabinet w/Bookshelf at 29" H**

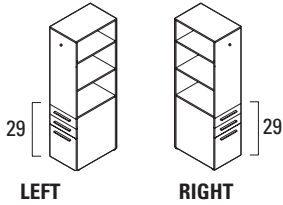

**66" H Storage Cabinet w/Bookshelf at 29" H**

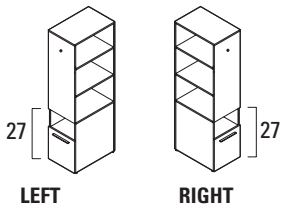

**66" H Recycling Cabinet w/Bookshelf at 27" H**

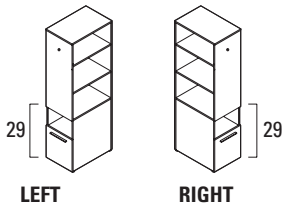

**66" H Recycling Cabinet w/Bookshelf at 29" H**

W x D x H

PN67CSBFL	16 x 24 x 65.5	153	19	<b>\$1323</b>
PN67CSBFR	16 x 24 x 65.5	153	19	<b>\$1323</b>

Specify PN67CSBFL for **left** or PN67CSBFR for **right**.

**Open shelf/box/file drawer.** Lock on file drawer secures both drawers. Two adjustable laminate shelves. Fixed bottom shelf aligns with **27" H** surfaces. Outside accessory hook. Shipped assembled in 1 carton.

PN69CSBFL	16 x 24 x 65.5	154	19	<b>\$1323</b>
PN69CSBFR	16 x 24 x 65.5	154	19	<b>\$1323</b>

Specify PN69CSBFL for **left** or PN69CSBFR for **right**.

**Open shelf/box/file drawer.** Lock on file drawer secures both drawers. Two adjustable laminate shelves. Fixed bottom shelf aligns with **29" H** surfaces. Outside accessory hook. Shipped assembled in 1 carton.

PN69CBBFL	16 x 24 x 65.5	155	19	<b>\$1413</b>
PN69CBBFR	16 x 24 x 65.5	155	19	<b>\$1413</b>

Specify PN69CBBFL for **left** or PN69CBBFR for **right**.

**Box/box/file drawer.** Lock on file drawer secures file and lower box drawer. Two adjustable laminate shelves. Fixed bottom shelf aligns with **29" H** surfaces. Outside accessory hook. Shipped assembled in 1 carton.

PN67RCSL	16 x 24 x 65.5	154	19	<b>\$1384</b>
PN67RCR	16 x 24 x 65.5	154	19	<b>\$1384</b>

Specify PN67RCSL for **left** or PN67RCR for **right**.

Drawer with one waste bin and one recycling bin. Open shelf above. Two adjustable laminate shelves. Fixed bottom shelf aligns with **27" H** surfaces. Outside accessory hook. Shipped assembled in 1 carton.

PN69RCSL	16 x 24 x 65.5	154	19	<b>\$1384</b>
PN69RCR	16 x 24 x 65.5	154	19	<b>\$1384</b>

Specify PN69RCSL for **left** or PN69RCR for **right**.

Drawer with one waste bin and one recycling bin. Open shelf above. Two adjustable laminate shelves. Fixed bottom shelf aligns with **29" H** surfaces. Outside accessory hook. Shipped assembled in 1 carton.

**Required specifications**

- Top finish
- Base finish
- Drawer/panel finish

**Optional specifications**

- No lock

66"H STORAGE CABINETS

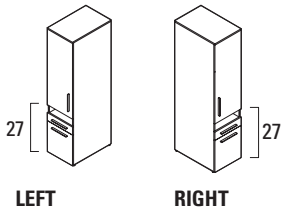

66"H Storage Cabinet w/Door at 27"H\*\*

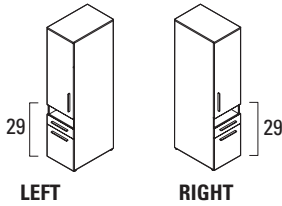

66"H Storage Cabinet w/Door at 29"H

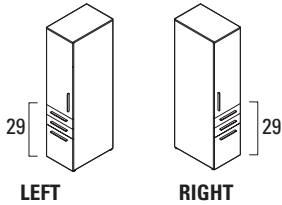

66"H Storage Cabinet w/Door at 29"H

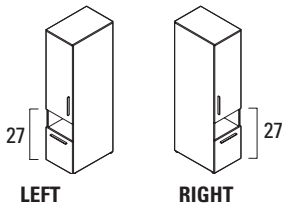

66"H Recycling Cabinet w/Door at 27"H

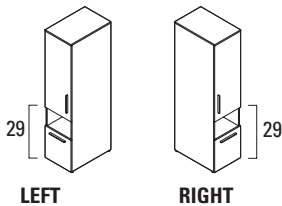

66"H Recycling Cabinet w/Door at 29"H

MODEL # DIMENSIONS WT/LB. CUBIC FT. LIST PRICE

W x D x H

PN67DSBFL	16 x 24 x 65.5	166	19	<b>\$1332</b>
PN67DSBFR	16 x 24 x 65.5	166	19	<b>\$1332</b>

Specify PN67DSBFL for **left** or PN67DSBFR for **right**.

**Open shelf/box/file drawer.** Lock on file drawer secures both drawers. Upper storage cabinet with locking door and two adjustable laminate shelves inside. Door aligns with **27"H** surfaces. Shipped assembled in 1 carton.

PN69DSBFL	16 x 24 x 65.5	166	19	<b>\$1332</b>
PN69DSBFR	16 x 24 x 65.5	166	19	<b>\$1332</b>

Specify PN69DSBFL for **left** or PN69DSBFR for **right**.

**Open shelf/box/file drawer.** Lock on file drawer secures both drawers. Upper storage cabinet with locking door and two adjustable laminate shelves inside. Door aligns with **29"H** surfaces. Shipped assembled in 1 carton.

PN69DBBFL	16 x 24 x 65.5	168	19	<b>\$1535</b>
PN69DBBFR	16 x 24 x 65.5	168	19	<b>\$1535</b>

Specify PN69DBBFL for **left** or PN69DBBFR for **right**.

**Box/box/file drawer.** Lock on file drawer secures file and lower box drawer. Upper storage cabinet with locking door and two adjustable laminate shelves inside. Door aligns with **29"H** surfaces. Shipped assembled in 1 carton.

PN67DRCSL	16 x 24 x 65.5	167	19	<b>\$1343</b>
PN67DRCSR	16 x 24 x 65.5	167	19	<b>\$1343</b>

Specify PN67DRCSL for **left** or PN67DRCSR for **right**.

Upper storage cabinet with locking door and two adjustable laminate shelves inside. Drawer with one waste bin, one recycling bin, and an open shelf above. Door aligns with **27"H** surfaces. Shipped assembled in 1 carton.

PN69DRCSL	16 x 24 x 65.5	167	19	<b>\$1343</b>
PN69DRCSR	16 x 24 x 65.5	167	19	<b>\$1343</b>

Specify PN69DRCSL for **left** or PN69DRCSR for **right**.

Upper storage cabinet with locking door and two adjustable laminate shelves inside. Drawer with one waste bin, one recycling bin, and an open shelf above. Door aligns with **29"H** surfaces. Shipped assembled in 1 carton.

**Required specifications**

- Top finish
- Base finish
- Drawer/door finish

**Optional specifications**

- No lock



**66" H STORAGE CABINETS**      **MODEL #**      **DIMENSIONS**      **WT/LB.**      **CUBIC FT.**      **LIST PRICE**

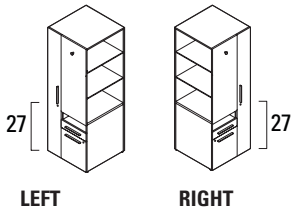

**66" H Storage Tower w/Wardrobe, Shelf, Box/File and Bookshelf at 27" H**

	W x D x H			
PN67TSBFL	24 x 24 x 65.5	216	27	<b>\$1888</b>
PN67TSBFR	24 x 24 x 65.5	216	27	<b>\$1888</b>

Specify PN67TSBFL for **left** or PN67TSBFR for **right**.

**Open shelf/box/file drawer.** Lock on file drawer secures both drawers. Two adjustable laminate shelves. Fixed bottom shelf aligns with **27" H** surfaces. Outside accessory hook and locking wardrobe with coat rail. Shipped assembled in 1 carton.

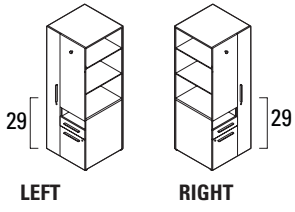

**66" H Storage Tower w/Wardrobe, Shelf, Box/File and Bookshelf at 29" H**

PN69TSBFL	24 x 24 x 65.5	216	27	<b>\$1888</b>
PN69TSBFR	24 x 24 x 65.5	216	27	<b>\$1888</b>

Specify PN69TSBFL for **left** or PN69TSBFR for **right**.

**Open shelf/box/file drawer.** Lock on file drawer secures both drawers. Two adjustable laminate shelves. Fixed bottom shelf aligns with **29" H** surfaces. Outside accessory hook and locking wardrobe with coat rail. Shipped assembled in 1 carton.

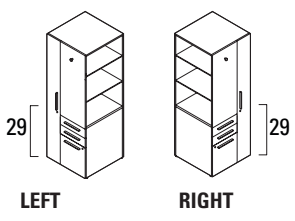

**66" H Storage Tower w/Wardrobe, Shelf, Box/Box/File and Bookshelf at 29" H**

PN69TBBFL	24 x 24 x 65.5	219	27	<b>\$1990</b>
PN69TBBFR	24 x 24 x 65.5	219	27	<b>\$1990</b>

Specify PN69TBBFL for **left** or PN69TBBFR for **right**.

**Box/box/file drawer.** Lock on file and lower box drawer. Two adjustable laminate shelves. Fixed bottom shelf aligns with **29" H** surfaces. Outside accessory hook and locking wardrobe with coat rail. Shipped assembled in 1 carton.

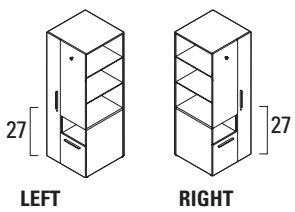

**66" H Storage Tower w/Wardrobe, Shelf, Recycling and Bookshelf at 27" H**

PN67RTSL	24 x 24 x 65.5	217	27	<b>\$1896</b>
PN67RTSR	24 x 24 x 65.5	217	27	<b>\$1896</b>

Specify PN67RTSL for **left** or PN67RTSR for **right**.

Drawer with one waste and one recycling bin. Open shelf above. Two adjustable laminate shelves. Fixed bottom shelf aligns with **27" H** surfaces. Outside accessory hook. Locking wardrobe with coat rail. Shipped assembled in 1 carton.

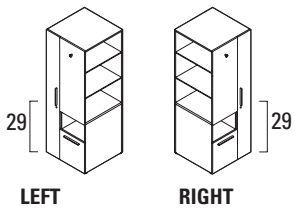

**66" H Storage Tower w/Wardrobe, Shelf, Recycling and Bookshelf at 29" H**

PN69RTSL	24 x 24 x 65.5	217	27	<b>\$1896</b>
PN69RTSR	24 x 24 x 65.5	217	27	<b>\$1896</b>

Specify PN69RTSL for **left** or PN69RTSR for **right**.

Drawer with one waste and one recycling bin. Open shelf above. Two adjustable laminate shelves. Fixed bottom shelf aligns with **29" H** surfaces. Outside accessory hook. Locking wardrobe with coat rail. Shipped assembled in 1 carton.

Required specifications	Optional specifications
Top finish	No lock
Base finish	
Drawer/door finish	
Panel finish	

66"H STORAGE CABINETS

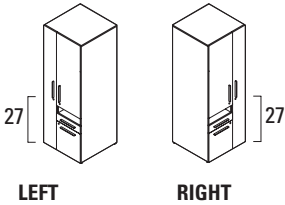

66"H Storage Tower w/Wardrobe, Shelf, Box/File and Door at 27"H

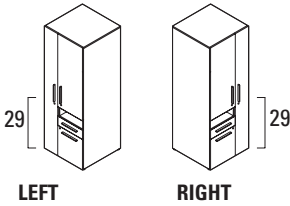

66"H Storage Tower w/Wardrobe, Shelf, Box/File and Door at 29"H

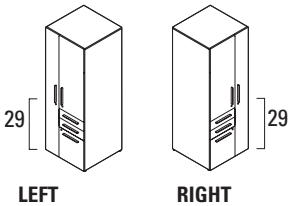

66"H Storage Tower w/Wardrobe, Box/Box/File and Door at 29"H

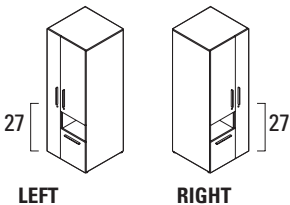

66"H Storage Tower w/Wardrobe, Large Shelf, Recycling and Door at 27"H

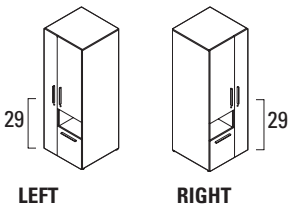

66"H Storage Tower w/Wardrobe, Large Shelf, Recycling and Door at 29"H

MODEL #	DIMENSIONS W x D x H	WT/LB.	CUBIC FT.	LIST PRICE
PN67SBFTL	24 x 24 x 65.5	229	27	<b>\$1960</b>
PN67SBFTR	24 x 24 x 65.5	229	27	<b>\$1960</b>

Specify PN67SBFTL for **left** or PN67SBFTR for **right**.

**Open shelf/box/file drawer.** Lock on file drawer secures both drawers. Upper storage cabinet with locking door and two adjustable laminate shelves inside. Door aligns with **27"H** surfaces. Outside accessory hook. Locking wardrobe with coat rail. Shipped assembled in 1 carton.

PN69SBFTL	24 x 24 x 65.5	229	27	<b>\$1960</b>
PN69SBFTR	24 x 24 x 65.5	229	27	<b>\$1960</b>

Specify PN69SBFTL for **left** or PN69SBFTR for **right**.

**Open shelf/box/file drawer.** Lock on file drawer secures both drawers. Upper storage cabinet with locking door and two adjustable laminate shelves inside. Door aligns with **29"H** surfaces. Locking wardrobe with coat rail. Shipped assembled in 1 carton.

PN69BBFTL	24 x 24 x 65.5	230	27	<b>\$2059</b>
PN69BBFTR	24 x 24 x 65.5	230	27	<b>\$2059</b>

Specify PN69BBFTL for **left** or PN69BBFTR for **right**.

**Box/box/file drawer.** Lock on file drawer secures file and lower box drawer. Upper storage cabinet with locking door and two adjustable laminate shelves inside. Door aligns with **29"H** surfaces. Locking wardrobe with coat rail. Shipped assembled in 1 carton.

PN67DRTSL	24 x 24 x 65.5	229	27	<b>\$2007</b>
PN67DRTSR	24 x 24 x 65.5	229	27	<b>\$2007</b>

Specify PN67DRTSL for **left** or PN67DRTSR for **right**.

Drawer with one waste and one recycling bin. Open shelf above. Upper storage cabinet with locking door and two adjustable laminate shelves inside. Door aligns with **27"H** surfaces. Locking wardrobe with coat rail. Shipped assembled in 1 carton.

PN69DRTSL	24 x 24 x 65.5	229	27	<b>\$2007</b>
PN69DRTSR	24 x 24 x 65.5	229	27	<b>\$2007</b>

Specify PN69DRTSL for **left** or PN69DRTSR for **right**.





Drawer with one waste and one recycling bin. Open shelf above. Upper storage cabinet with locking door and two adjustable laminate shelves inside. Door aligns with **29"H** surfaces. Locking wardrobe with coat rail. Shipped assembled in 1 carton.

**Required specifications**

Top finish  
Base finish  
Drawer/door finish

**Optional specifications**

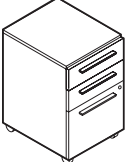
No lock

MOBILE PEDESTALS	MODEL #	DIMENSIONS	WT/LB.	CUBIC FT.	LIST PRICE	HP ADD
		W x D x H				
	PN22MBF	16 x 22 x 20.9	69	6.05	<b>\$840</b>	<b>\$88</b>
<b>20.9"H Mobile Pedestal*</b>						
	PN25MSBF	16 x 22 x 25.4	80	7.25	<b>\$888</b>	<b>\$95</b>
<b>25.4"H Mobile Pedestal*</b>						
	PN25MBBF	16 x 22 x 25.4	88	7.25	<b>\$938</b>	<b>\$113</b>
<b>25.4"H Mobile Pedestal</b>						
	PN27MFF	16 x 22 x 26.8	108	7.5	<b>\$917</b>	<b>\$104</b>
<b>26.8"H Mobile Pedestal</b>						

**Box/file drawer.** Lock on box drawer secures both drawers. Front casters are locking. Shipped assembled in 1 carton.

**Open shelf/box/file drawer.** Lock on file drawer secures both drawers. 29"H units with hat channels have an underside clearance of only 25.9"H. Front casters are locking. Shipped assembled in 1 carton.

**Box/box/file drawer.** Lock on file drawer secures file and lower box drawer. 29"H units with hat channels have an underside clearance of only 25.9"H. Front casters are locking. Shipped assembled in 1 carton.

**File/file.** 26.8"H mobile storage can only be used with 29"H Princeton products that have laminate end panels/gables; 29"H units with hat channels have an underside clearance of only 25.9"H. Lock on lower file drawer secures both drawers. Front casters are locking. Shipped assembled in 1 carton.

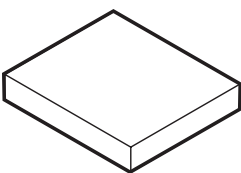
PEDESTAL CUSHIONS	MODEL #	DIMENSIONS	WT/LB.	CUBIC FT.	GRADE	LIST	GRADE	LIST
		W x D x H						
	PN1622CU	16 x 21.5 x 2.5	3	0.9	1	<b>\$122</b>	7	<b>\$357</b>
					2	<b>\$154</b>	8	<b>\$398</b>
					3	<b>\$181</b>	9	<b>\$449</b>
					4	<b>\$212</b>	10	<b>\$497</b>
					5	<b>\$263</b>	11	<b>\$562</b>
					6	<b>\$310</b>	12	<b>\$654</b>
<b>Pedestal Cushion</b>								

For **PN22MBF** mobile pedestal.

**Required specifications**

- Top finish
- Base finish
- Drawer finish
- Fabric (only cushion)

**Optional specifications**

- No lock
- HP laminate

**Accessories**

- Cushion\*

**MOBILE LATERAL FILES**

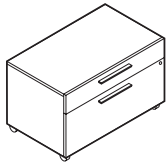

**20.5”H Mobile Lateral File\***

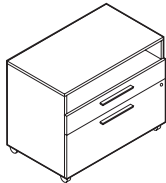

**25.5”H Mobile Lateral File**

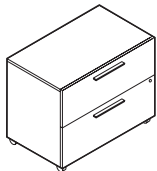

**27”H Mobile Lateral File**

MODEL #	DIMENSIONS W x D x H	WT/LB.	CUBIC FT.	LIST PRICE	HP ADD
PN22MLBF	35.5 x 22 x 21	120	12.5	<b>\$1326</b>	<b>\$181</b>

**Box/file drawer.** Lock on file drawer secures both drawers. File bars included for front-to-back letter/legal filing capability. Front casters are locking. Can fit under 29” and 27” high credenzas for mobile lateral file with or without a cushion. Can fit under 23” high credenzas without cushion only. Shipped assembled in 1 carton.

PN25MLSBF	35.5 x 22 x 25	141	15	<b>\$1385</b>	<b>\$191</b>
-----------	----------------	-----	----	---------------	--------------

**Open shelf/box/file drawer.** Lock on file drawer secures both drawers. File bars included for front-to-back letter/legal filing capability. Front casters are locking. Can fit under 29” high credenzas for mobile lateral file without cushion only. Shipped assembled in 1 carton.

PN27MLFF	35.5 x 22 x 27	161	15.5	<b>\$1447</b>	<b>\$197</b>
----------	----------------	-----	------	---------------	--------------

**File/file drawer.** 27”H mobile storage can only be used with 29”H Princeton products that have laminate end panels/gables; Princeton products with metal legs will not accommodate 27”H mobile units. Lock on bottom file drawer secures both drawers. File bars included for front-to-back letter/legal filing capability. Front casters are locking. Can fit under 29” high credenzas for mobile lateral file without cushion only. Shipped assembled in 1 carton.

**MOBILE LATERAL FILE CUSHIONS**

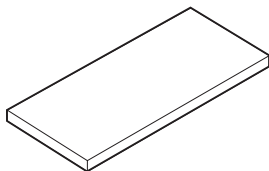

**Mobile Lateral File Cushion**

MODEL #	DIMENSIONS	WT/LB.	CUBIC FT.	GRADE	LIST	GRADE	LIST
PN3622CU	22 x 36 x 2.5	13	2.4	1	<b>\$302</b>	7	<b>\$772</b>
				2	<b>\$366</b>	8	<b>\$854</b>
				3	<b>\$420</b>	9	<b>\$956</b>
				4	<b>\$482</b>	10	<b>\$1052</b>
				5	<b>\$584</b>	11	<b>\$1182</b>
				6	<b>\$678</b>	12	<b>\$1366</b>

For **PN22MLBF** mobile lateral file.

**MOBILE STOOL**

**LIST PRICE**

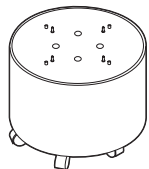

**Round Mobile Stool**

PN1920ST	19 x 19 x 14.68	25	5.25	<b>\$675</b>
----------	-----------------	----	------	--------------

Laminate base for use with cushion. **CANNOT BE USED WITHOUT CUSHION. Cushion sold separately.** Six casters. Shipped assembled in 1 carton.

• **NOTE: Maximum weight capacity is 200 lbs**

**Required specifications**

Top finish  
Base finish  
Drawer finish  
Fabric (only cushion)

**Optional specifications**

No lock  
HP laminate

**Accessories**

Cushion\*

**CUSHION FOR MOBILE STOOL**      **MODEL #**      **DIMENSIONS**      **WT/LB.**      **CUBIC FT.**      **GRADE**      **LIST**      **LIST**

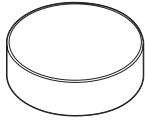

**Cushion for Round Mobile Stool\***

		W x D x H					
SEAT-PN1920ST	19 x 19 x 5	6	5.25	1	<b>\$176</b>	7	<b>\$352</b>
				2	<b>\$200</b>	8	<b>\$383</b>
				3	<b>\$220</b>	9	<b>\$421</b>
				4	<b>\$244</b>	10	<b>\$457</b>
				5	<b>\$282</b>	11	<b>\$506</b>
				6	<b>\$317</b>	12	<b>\$575</b>

To be used with mobile stool PN1920ST. Shipped in 1 carton.

**POT PLANTERS**      **MODEL #**      **DIMENSIONS**      **WT/LB.**      **CUBIC FT.**      **LIST PRICE**

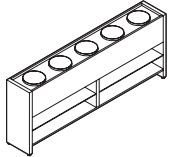

**Five Pot Planter\*\***

PN7229PL	72 x 12 x 29	156	20.25	<b>\$1225</b>
----------	--------------	-----	-------	---------------

Five plastic pots - specify Black (**BK**) or White (**WT**). Adjustable 3 position laminate shelf. Shipped assembled in 1 carton.

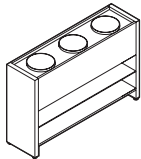

**Three Pot Planter\*\***

PN4229PL	42 x 12 x 29	99	12.25	<b>\$931</b>
----------	--------------	----	-------	--------------

Three plastic pots - specify Black (**BK**) or White (**WT**). Adjustable 3 position laminate shelf. Shipped assembled in 1 carton.

**DIVIDER SHELVES**

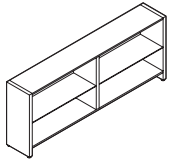

**72"W Divider Shelf**

PN7229BGS	72 x 12 x 29	126	20.25	<b>\$1012</b>
-----------	--------------	-----	-------	---------------

Adjustable 3 position laminate shelves. Shipped assembled in 1 carton.

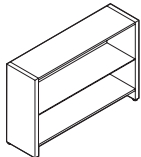

**42"W Divider Shelf**

PN4229BGS	42 x 12 x 29	80	12.25	<b>\$816</b>
-----------	--------------	----	-------	--------------

Adjustable 3 position laminate shelf. Shipped assembled in 1 carton.

**Required specifications**

- Top finish
- Base finish
- Fabric\*
- Pot finish\*\*

**BOOKSHELVES**

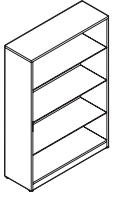

**Bookshelf w/Laminate Shelves\***

MODEL #	DIMENSIONS W x D x H	WT/LB.	CUBIC FT.	LIST PRICE	HP ADD
PN2429BLS	24 x 12 x 29	50	6.5	<b>\$622</b>	<b>\$96</b>
PN2452BLS	24 x 12 x 52	82	11.5	<b>\$788</b>	N/A
PN2466BLS	24 x 12 x 66	101	14.5	<b>\$865</b>	N/A
PN3029BLS	30 x 12 x 29	57	8	<b>\$699</b>	<b>\$108</b>
PN3052BLS	30 x 12 x 52	95	14	<b>\$817</b>	N/A
PN3066BLS	30 x 12 x 66	116	17.25	<b>\$903</b>	N/A
PN3629BLS	36 x 12 x 29	66	9.5	<b>\$750</b>	<b>\$114</b>
PN3652BLS	36 x 12 x 52	109	16.75	<b>\$861</b>	N/A
PN3666BLS	36 x 12 x 66	133	21	<b>\$945</b>	N/A

66"H models have four adjustable shelves. 52"H models have 3 adjustable shelves. 29"H models have 1 adjustable shelf. HP laminate is only available on 29"H models. Shipped assembled in 1 carton.

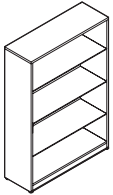

**Bookshelf w/Glass Shelves\***

PN2429BGS	24 x 12 x 29	54	7.1	<b>\$647</b>	<b>\$98</b>
PN2452BGS	24 x 12 x 52	98	13.3	<b>\$962</b>	N/A
PN2466BGS	24 x 12 x 66	121	16.9	<b>\$1142</b>	N/A
PN3029BGS	30 x 12 x 29	63	8.73	<b>\$747</b>	<b>\$114</b>
PN3052BGS	30 x 12 x 52	112	16.2	<b>\$1032</b>	N/A
PN3066BGS	30 x 12 x 66	140	20.2	<b>\$1192</b>	N/A
PN3629BGS	36 x 12 x 29	72	10.5	<b>\$746</b>	<b>\$114</b>
PN3652BGS	36 x 12 x 52	128	16.75	<b>\$1127</b>	N/A
PN3666BGS	36 x 12 x 66	156	24.4	<b>\$1321</b>	N/A

66"H models have four adjustable shelves. 52"H models have 3 adjustable shelves. 29"H models have 1 adjustable shelf. HP laminate is only available on 29"H models. Shipped assembled in 2 carton.

**DESKTOP AND OVERHEAD STORAGE**

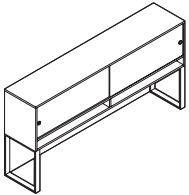

**Hutch w/Laminate Doors\*\***

PN3560LCH	60 x 16 x 35	215	24.5	<b>\$1592</b>	N/A
PN3572LCH	72 x 16 x 35	242	29.5	<b>\$1646</b>	N/A
PN3584LCH	84 x 16 x 35	266	34	<b>\$1766</b>	N/A

Sliding laminate doors in upper plastic track. Recessed brushed aluminum finger pulls. No lock. Laminate back board. 15.75" clearance between worksurface and underside. Shipped partially assembled in 1 carton.

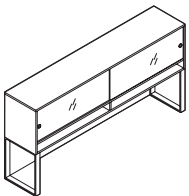

**Hutch w/Glass Doors\*\***

PN3560CH	60 x 16 x 35	223	25.8	<b>\$2312</b>	N/A
PN3572CH	72 x 16 x 35	249	31	<b>\$2485</b>	N/A
PN3584CH	84 x 16 x 35	271	35.7	<b>\$2729</b>	N/A

Sliding glass doors in upper aluminum track. Acid etched 6mm glass. Brushed aluminum finger pulls. No lock. Laminate back board. 15.75" clearance between worksurface and underside. Shipped partially assembled in 2 cartons (glass doors shipped separately).

**Required specifications**

Top finish  
Base finish  
Door finish (PN35xxLCH and PN11xxLDS only)  
Hutch support\*\*

**Optional specifications**

HP laminate (29"H only)\*

**DESKTOP AND OVERHEAD STORAGE      MODEL #      DIMENSIONS      WT/LB.      CUBIC FT.      LIST PRICE**

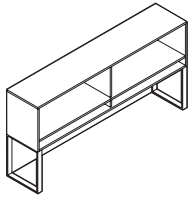

**Open Hutch\*\***

	W x D x H			
PN3560CHO	60 x 16 x 35	201	24.5	<b>\$1390</b>
PN3572CHO	72 x 16 x 35	224	29.5	<b>\$1431</b>
PN3584CHO	84 x 16 x 35	246	34	<b>\$1543</b>

Laminate back board. 15.75" clearance between worksurface and underside. Shipped partially assembled in 1 carton.

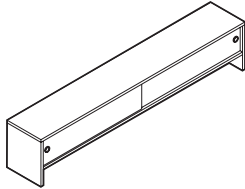

**Desktop Storage w/Laminate Doors**

PN1160LDS	60 x 11 x 12	58	7	<b>\$831</b>
PN1172LDS	72 x 11 x 12	68	8.5	<b>\$898</b>

Sliding laminate doors in upper plastic track. Recessed brushed aluminum finger pulls. No lock. Shipped assembled in 1 carton.

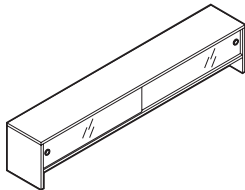

**Desktop Storage w/Glass Doors**

PN1160DS	60 x 11 x 12	62.5	7.8	<b>\$1340</b>
PN1172DS	72 x 11 x 12	74	9.4	<b>\$1512</b>

Sliding glass doors in upper aluminum track. Acid etched 6mm glass. Recessed aluminum finger pulls. No lock. Shipped assembled in 2 cartons (glass doors shipped separately).

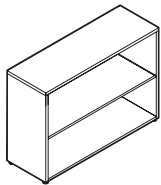

**Desktop Shelf - Two High w/Laminate Shelf**

PN2423LDB	24 x 12 x 23	43	5.5	<b>\$394</b>
PN3023LDB	30 x 12 x 23	51	6.75	<b>\$429</b>
PN3623LDB	36 x 12 x 23	58	8	<b>\$434</b>
PN2425LDB	24 x 12 x 25	45	6	<b>\$394</b>
PN3025LDB	30 x 12 x 25	53	7.25	<b>\$429</b>
PN3625LDB	36 x 12 x 25	60	8.75	<b>\$434</b>

One multiple-position adjustable **laminate** shelf. Shipped assembled in 1 carton.

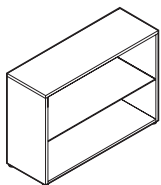

**Desktop Shelf - Two High w/Glass Shelf**

PN2423GDB	24 x 12 x 23	48	6.25	<b>\$452</b>
PN3023GDB	30 x 12 x 23	56	7.5	<b>\$496</b>
PN3623GDB	36 x 12 x 23	64	9	<b>\$526</b>
PN2425GDB	24 x 12 x 25	50	6.75	<b>\$452</b>
PN3025GDB	30 x 12 x 25	58	8.25	<b>\$496</b>
PN3625GDB	36 x 12 x 25	67	9.75	<b>\$526</b>

One multiple-position adjustable **glass** shelf. Shipped assembled in 2 cartons.

**Required specifications**

Top finish  
Base finish

DESKTOP AND OVERHEAD STORAGE

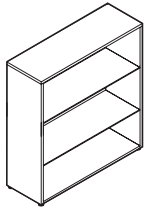

Desktop Shelf - Three High w/Laminate Shelves

MODEL #	DIMENSIONS W x D x H	WT/LB.	CUBIC FT.	LIST PRICE
PN2437LDB	24 x 12 x 37	62	8.5	\$491
PN3037LDB	30 x 12 x 37	72	10.5	\$522
PN3637LDB	36 x 12 x 37	83	12.25	\$543
PN2439LDB	24 x 12 x 39	64	9	\$515
PN3039LDB	30 x 12 x 39	75	11	\$545
PN3639LDB	36 x 12 x 39	85	13	\$569

Two multiple-position adjustable **laminated** shelves. Shipped assembled in 1 carton.

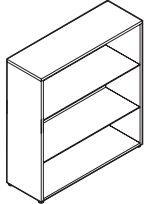

Desktop Shelf - Three High w/Glass Shelves

PN2437GDB	24 x 12 x 37	72	9.75	\$633
PN3037GDB	30 x 12 x 37	83	12	\$703
PN3637GDB	36 x 12 x 37	95	14	\$731
PN2439GDB	24 x 12 x 39	74	10.25	\$633
PN3039GDB	30 x 12 x 39	85	12.5	\$703
PN3639GDB	36 x 12 x 39	98	14.75	\$731

Two multiple-position adjustable **glass** shelves. Shipped assembled in 3 carton.

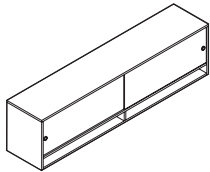

Large Overhead Storage w/Laminate Doors, Wall-Mounted\*

PN1960LWH	60 x 16 x 19	121	14	\$1173
PN1972LWH	72 x 16 x 19	141	16.5	\$1227
PN1984LWH	84 x 16 x 19	160	19	\$1347

Sliding laminate doors in upper plastic track. Recessed brushed aluminum finger pulls. No lock. Shipped assembled in 1 carton.

• **NOTE:** Care should be taken to mount the units. Units should be mounted to wall studs using correct fasteners. Failure to do so may result in collapse of the unit and subsequent personal injury. **Mounting hardware not included.** Mounting hardware used should be based on wall material. Consult an installation professional for proper wall mounting.

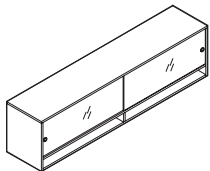

Large Overhead Storage w/Glass Doors Wall-Mounted

PN1960WH	60 x 16 x 19	127.5	15.3	\$1829
PN1972WH	72 x 16 x 19	148	18	\$2054
PN1984WH	84 x 16 x 19	168	20.7	\$2250

Sliding glass doors in upper aluminum track. Acid etched 6mm glass. Brushed aluminum finger pulls. No lock. Shipped assembled in 2 cartons (glass doors shipped separately).

• **NOTE:** Care should be taken to mount the units. Units should be mounted to wall studs using correct fasteners. Failure to do so may result in collapse of the unit and subsequent personal injury. **Mounting hardware not included.** Mounting hardware used should be based on wall material. Consult an installation professional for proper wall mounting.

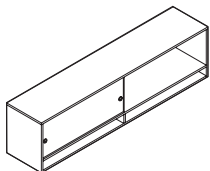

Large Overhead Storage w/Single Laminate Door, Wall-Mounted\*

PN1960LS	60 x 16 x 19	115	14	\$1089
PN1972LS	72 x 16 x 19	132	16.5	\$1146
PN1984LS	84 x 16 x 19	150	19	\$1259

Sliding laminate door in upper plastic track. Recessed brushed aluminum finger pulls. No lock. Shipped assembled in 1 carton.

• **NOTE:** Care should be taken to mount the units. Units should be mounted to wall studs using correct fasteners. Failure to do so may result in collapse of the unit and subsequent personal injury. **Mounting hardware not included.** Mounting hardware used should be based on wall material. Consult an installation professional for proper wall mounting.

**Required specifications**

- Top finish
- Base finish
- Door finish\*



**DESKTOP AND OVERHEAD STORAGE**      **MODEL #**      **DIMENSIONS**      **WT/LB.**      **CUBIC FT.**      **LIST PRICE**

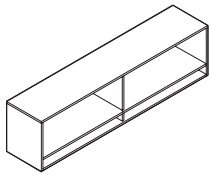

**Large Overhead Storage, Wall-Mounted**

	W x D x H			
PN1960WHO	60 x 16 x 19	107	14	<b>\$987</b>
PN1972WHO	72 x 16 x 19	123	16.5	<b>\$1028</b>
PN1984WHO	84 x 16 x 19	140	19	<b>\$1140</b>

Open storage with center divider. Shipped assembled in 1 carton.

• **NOTE:** Care should be taken to mount the units. Units should be mounted to wall studs using correct fasteners. Failure to do so may result in collapse of the unit and subsequent personal injury. **Mounting hardware not included.** Mounting hardware used should be based on wall material. Consult an installation professional for proper wall mounting.

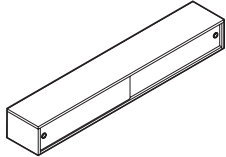

**Small Overhead Storage w/Laminate Doors, Wall-Mounted\***

PN1260LWH	60 x 12 x 8	59	5.25	<b>\$861</b>
PN1272LWH	72 x 12 x 8	69	6	<b>\$932</b>
PN1284LWH	84 x 12 x 8	79	7	<b>\$979</b>

Sliding laminate doors in upper plastic track. Recessed brushed aluminum finger pulls. No lock. Shipped assembled in 1 carton.

• **NOTE:** Care should be taken to mount the units. Units should be mounted to wall studs using correct fasteners. Failure to do so may result in collapse of the unit and subsequent personal injury. **Mounting hardware not included.** Mounting hardware used should be based on wall material. Consult an installation professional for proper wall mounting.

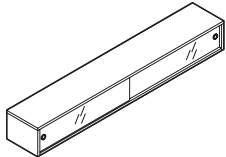

**Small Overhead Storage w/Glass Doors, Wall-Mounted**

PN1260WH	60 x 12 x 8	63.5	6.1	<b>\$1683</b>
PN1272WH	72 x 12 x 8	74	6.9	<b>\$1898</b>
PN1284WH	84 x 12 x 8	85	8	<b>\$2005</b>

Sliding glass doors in upper aluminum track. Acid etched 6mm glass. Brushed aluminum finger pulls. No lock. Shipped assembled in 2 cartons (glass doors shipped separately).

• **NOTE:** Care should be taken to mount the units. Units should be mounted to wall studs using correct fasteners. Failure to do so may result in collapse of the unit and subsequent personal injury. **Mounting hardware not included.** Mounting hardware used should be based on wall material. Consult an installation professional for proper wall mounting.

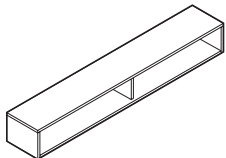

**Small Overhead Storage, Wall-Mounted\***

PN1260WHO	60 x 12 x 8	52	5.25	<b>\$658</b>
PN1272WHO	72 x 12 x 8	61	6	<b>\$740</b>
PN1284WHO	84 x 12 x 8	70	7	<b>\$804</b>

Open storage shelf with center divider. Shipped assembled in 1 carton.

• **NOTE:** Care should be taken to mount the units. Units should be mounted to wall studs using correct fasteners. Failure to do so may result in collapse of the unit and subsequent personal injury. **Mounting hardware not included.** Mounting hardware used should be based on wall material. Consult an installation professional for proper wall mounting.

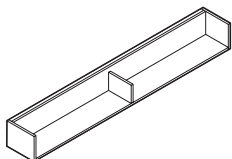

**Wall-Mounted Shelf\*\***

PN1260WHS	60 x 12 x 8	40	5.25	<b>\$487</b>
PN1272WHS	72 x 12 x 8	46	6	<b>\$529</b>
PN1284WHS	84 x 12 x 8	53	7	<b>\$570</b>

Open storage shelf with center divider. Shipped assembled in 1 carton.

• **NOTE:** Care should be taken to mount the units. Units should be mounted to wall studs using correct fasteners. Failure to do so may result in collapse of the unit and subsequent personal injury. **Mounting hardware not included.** Mounting hardware used should be based on wall material. Consult an installation professional for proper wall mounting.

**Required specifications**

- Top finish
- Base finish
- Door finish\*

**TACKBOARDS FOR HUTCHES**

**NOTES:** Tackboards can be upholstered in all of the following fabrics:

- Anchorage
- Global seating fabrics\*
- Lola
- Merge

\* Contact Customer Service for pricing.

**TACKBOARDS FOR HUTCHES**

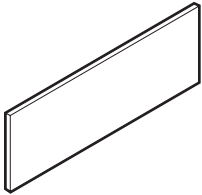

**Tackboard for Hutches\***

MODEL #	DIMENSIONS W x D x H	WT/LB.	CUBIC FT.	LIST PRICE
PN1556TBH	56 x 1 x 14.5	8.2	1	<b>\$403</b>
PN1562TBH	62 x 1 x 14.5	7.75	1	<b>\$409</b>
PN1568TBH	68 x 1 x 14.5	11	1	<b>\$416</b>
PN1574TBH	74 x 1 x 14.5	9	1.5	<b>\$532</b>
PN1580TBH	80 x 1 x 14.5	10	1.5	<b>\$561</b>

Attaches to hutch backboard with Velcro.

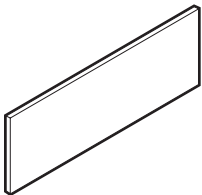

**Tackboard for Wall Mounted Overhead storage\***

PN1560TBW	60 x 1 x 14.5	10	1	<b>\$434</b>
PN1566TBW	66 x 1 x 14.5	12	1	<b>\$459</b>
PN1572TBW	72 x 1 x 14.5	12.5	1	<b>\$483</b>
PN1578TBW	78 x 1 x 14.5	14	1.5	<b>\$583</b>
PN1584TBW	84 x 1 x 14.5	15	1.5	<b>\$638</b>

Attaches with adhesive backed Velcro.

**ELECTRICAL / DATA**

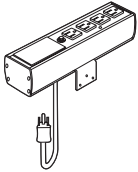

**4 Outlet, 1 Telecom Blank Plate**

PGDPS41	10.25 x 2.5 x 2.22	2.9	0.7	<b>\$304</b>
---------	--------------------	-----	-----	--------------

4 power receptacles and 1 telecom blank plate. Available for mounting behind pull-out shelf or open space credenza. Tungsten (TN) finish. 12 foot Black cord.

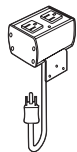

**2 Outlet Power Block**

PGDPS20	3.58 x 2.5 x 2.22	2.5	0.7	<b>\$217</b>
---------	-------------------	-----	-----	--------------

2 power receptacles. Available for side mounted installation. Tungsten (TN) finish. 12 foot Black cord.

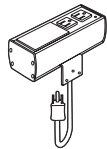

**2 Outlet, 1 Telecom Blank Plate**

PGDPS21	6.75 x 2.5 x 2.22	2.7	0.7	<b>\$280</b>
---------	-------------------	-----	-----	--------------

2 power receptacles and 1 telecom blank plate. Available for side mounted installation. Tungsten (TN) finish. 12 foot Black cord.

**Required specifications**

Textile\*

**ACCESSORIES** **MODEL #** **DIMENSIONS** **WT/LB.** **CUBIC FT.** **LIST PRICE**

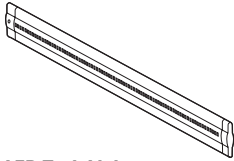

**LED Task Light**

**W x D x H**

PLED30	15.5 x 1.5 x 0.5	2	0.5	<b>\$344</b>
PLED50	23.5 x 1.5 x 0.5	2	0.5	<b>\$396</b>
PLED100	43.5 x 1.5 x 0.5	3	0.5	<b>\$461</b>

Energy efficient LED. Ultra slim design. Suitable for hanging under hutch or wallhung units.



**Wire Manager**

PEWM5.5	66 x 2 x 2	0.6	0.1	<b>\$136</b>
PEWM5	60 x 2 x 2	0.6	0.1	<b>\$114</b>
PEWM4.5	54 x 2 x 2	0.5	0.1	<b>\$103</b>
PEWM4	48 x 2 x 2	0.5	0.1	<b>\$89</b>
PEWM3.5	42 x 2 x 2	0.4	0.1	<b>\$80</b>
PEWM3	36 x 2 x 2	0.4	0.1	<b>\$70</b>
PEWM2.5	30 x 2 x 2	0.3	0.1	<b>\$55</b>
PEWM2	24 x 2 x 2	0.3	0.1	<b>\$46</b>
PEWM1.5	18 x 2 x 2	0.2	0.1	<b>\$34</b>
PEWM1	12 x 2 x 2	0.2	0.1	<b>\$25</b>

Plastic tray flexes to receive and hold electrical and data wires. Quickly attaches with two strips of double-sided tape. Black only.

**29" H TABLES**

**MODEL # DIMENSIONS WT/LB. CUBIC FT. LIST PRICE HP ADD**

**W x D x H**

PN242429	24 x 24 x 29	60	4.75	<b>\$817</b>	<b>\$124</b>
PN482429	48 x 24 x 29	77	5.75	<b>\$871</b>	<b>\$133</b>
PN542429	54 x 24 x 29	89	7.75	<b>\$1035</b>	<b>\$156</b>
PN602429	60 x 24 x 29	94	8.25	<b>\$1055</b>	<b>\$160</b>
PN662429	66 x 24 x 29	99	8.5	<b>\$1077</b>	<b>\$165</b>
PN722429	72 x 24 x 29	104	9	<b>\$1083</b>	<b>\$166</b>
PN782429	78 x 24 x 29	111	9.5	<b>\$1188</b>	<b>\$180</b>
PN842429	84 x 24 x 29	115	9.75	<b>\$1284</b>	<b>\$195</b>
PN902429	90 x 24 x 29	121	10.25	<b>\$1347</b>	<b>\$205</b>
PN962429	96 x 24 x 29	126	10.75	<b>\$1398</b>	<b>\$211</b>

PN303029	30 x 30 x 29	73	6	<b>\$902</b>	<b>\$138</b>
PN483029	48 x 30 x 29	89	7	<b>\$959</b>	<b>\$147</b>
PN543029	54 x 30 x 29	102	9.25	<b>\$1129</b>	<b>\$173</b>
PN603029	60 x 30 x 29	108	9.75	<b>\$1137</b>	<b>\$174</b>
PN663029	66 x 30 x 29	114	10.25	<b>\$1169</b>	<b>\$177</b>
PN723029	72 x 30 x 29	121	10.75	<b>\$1188</b>	<b>\$180</b>
PN783029	78 x 30 x 29	127	11.25	<b>\$1299</b>	<b>\$197</b>
PN843029	84 x 30 x 29	133	11.75	<b>\$1394</b>	<b>\$211</b>
PN903029	90 x 30 x 29	140	12.25	<b>\$1457</b>	<b>\$223</b>
PN963029	96 x 30 x 29	146	12.75	<b>\$1493</b>	<b>\$228</b>

PN363629	36 x 36 x 29	88	7.5	<b>\$957</b>	<b>\$147</b>
PN603629	60 x 36 x 29	128	11.5	<b>\$1305</b>	<b>\$200</b>
PN663629	66 x 36 x 29	136	12.25	<b>\$1347</b>	<b>\$205</b>
PN723629	72 x 36 x 29	144	12.75	<b>\$1369</b>	<b>\$208</b>
PN783629	78 x 36 x 29	152	13.25	<b>\$1350</b>	<b>\$205</b>
PN843629	84 x 36 x 29	160	13.75	<b>\$1446</b>	<b>\$219</b>
PN903629	90 x 36 x 29	168	14.5	<b>\$1553</b>	<b>\$234</b>
PN963629	96 x 36 x 29	176	15	<b>\$1567</b>	<b>\$238</b>

PN424229	42 x 42 x 29	107	11	<b>\$1106</b>	<b>\$168</b>
PN604229	60 x 42 x 29	142	13.25	<b>\$1365</b>	<b>\$208</b>
PN664229	66 x 42 x 29	151	14	<b>\$1407</b>	<b>\$214</b>
PN724229	72 x 42 x 29	160	14.5	<b>\$1436</b>	<b>\$218</b>
PN784229	78 x 42 x 29	169	14.75	<b>\$1597</b>	<b>\$243</b>
PN844229	84 x 42 x 29	178	15.5	<b>\$1740</b>	<b>\$265</b>
PN904229	90 x 42 x 29	235	22.5	<b>\$1867</b>	<b>\$285</b>
PN964229	96 x 42 x 29	239	23.5	<b>\$1902</b>	<b>\$289</b>

PN484829	48 x 48 x 29	124	10.75	<b>\$1139</b>	<b>\$174</b>
PN604829	60 x 48 x 29	156	15	<b>\$1414</b>	<b>\$215</b>
PN664829	66 x 48 x 29	164	15.75	<b>\$1462</b>	<b>\$223</b>
PN724829	72 x 48 x 29	176	16.5	<b>\$1484</b>	<b>\$226</b>
PN784829	78 x 48 x 29	186	17.25	<b>\$1677</b>	<b>\$256</b>
PN844829	84 x 48 x 29	196	17.75	<b>\$1821</b>	<b>\$276</b>
PN904829	90 x 48 x 29	257	25.25	<b>\$1946</b>	<b>\$296</b>
PN964829	96 x 48 x 29	202	26.5	<b>\$1975</b>	<b>\$300</b>

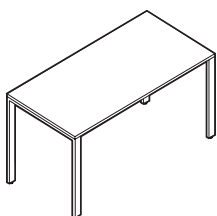

**29" H Table**

Freestanding. 1" x 2.5" open metal frame legs with levelers. Metal support hat channel(s) provided on tables exceeding 54" in width. Shipped easy to assemble in 2 cartons.

**Required specifications**

Top finish  
Leg finish

**Optional specifications**

HP laminate

29" H TABLES WITH CENTER LEGS

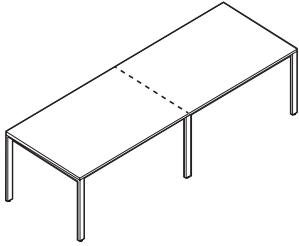

29" H Table with Center Leg

MODEL #	DIMENSIONS	WT/LB.	CUBIC FT.	LIST PRICE	HP ADD
---------	------------	--------	-----------	------------	--------

W x D x H

PN1203629	120 x 36 x 29	234	27	<b>\$2390</b>	<b>\$366</b>
PN1443629	144 x 36 x 29	265	29.25	<b>\$2532</b>	<b>\$385</b>
PN1204229	120 x 42 x 29	260	31	<b>\$2485</b>	<b>\$379</b>
PN1444229	144 x 42 x 29	296	33.75	<b>\$2621</b>	<b>\$399</b>
PN1204829	120 x 48 x 29	286	35.25	<b>\$2633</b>	<b>\$400</b>
PN1444829	144 x 48 x 29	326	38	<b>\$2768</b>	<b>\$423</b>

Freestanding. 1" x 2.5" open metal frame legs with levelers. 120" and 144" wide with 2 piece top. Metal support hat channel(s) provided on tables exceeding 54" in width. Shipped easy to assemble in 4 cartons.

29" H TABLES WITH CASTERS

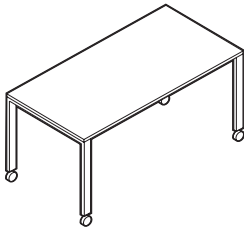

29" H Table with Casters

PN242429C	24 x 24 x 29	58	4.75	<b>\$844</b>	<b>\$128</b>
PN482429C	48 x 24 x 29	76	5.75	<b>\$897</b>	<b>\$136</b>
PN542429C	54 x 24 x 29	88	7.75	<b>\$1073</b>	<b>\$165</b>
PN602429C	60 x 24 x 29	93	8.25	<b>\$1093</b>	<b>\$167</b>
PN662429C	66 x 24 x 29	98	8.5	<b>\$1112</b>	<b>\$169</b>
PN722429C	72 x 24 x 29	104	9	<b>\$1133</b>	<b>\$173</b>
PN303029C	30 x 30 x 29	71	6	<b>\$929</b>	<b>\$141</b>
PN483029C	48 x 30 x 29	88	7	<b>\$983</b>	<b>\$151</b>
PN543029C	54 x 30 x 29	101	9.25	<b>\$1167</b>	<b>\$177</b>
PN603029C	60 x 30 x 29	107	9.75	<b>\$1177</b>	<b>\$179</b>
PN663029C	66 x 30 x 29	113	10.25	<b>\$1202</b>	<b>\$183</b>
PN723029C	72 x 30 x 29	119	10.75	<b>\$1243</b>	<b>\$190</b>
PN363629C	36 x 36 x 29	86	7.5	<b>\$977</b>	<b>\$149</b>
PN603629C	60 x 36 x 29	127	11.5	<b>\$1233</b>	<b>\$189</b>
PN663629C	66 x 36 x 29	135	12.25	<b>\$1262</b>	<b>\$193</b>
PN723629C	72 x 36 x 29	143	12.75	<b>\$1446</b>	<b>\$219</b>
PN424229C	42 x 42 x 29	105	11	<b>\$1130</b>	<b>\$173</b>
PN484829C	48 x 48 x 29	123	10.75	<b>\$1169</b>	<b>\$177</b>

Freestanding. 1" x 2.5" open metal frame legs with casters. All casters are locking. Metal support hat channel(s) provided on tables exceeding 54" in width. Shipped easy to assemble in 2 cartons.

**Required specifications**

Top finish  
Leg finish

**Optional specifications**

HP laminate



Zira is a contemporary desking solution with extensive options to personalize your workspace. Components can be freestanding for single workstation configurations, or joined together to form multiple work groups. Create a work environment that meets your worksurface needs and storage requirements - then go ahead and personalize it!

Select from the following: hundreds of components for any office size or shape, storage components that can tower to 84.5" high, 21 laminate finishes, 5 edge options, 9 handle options in Silver, Black, Nickel or Brass finishes, 2 glazing options with 2 frame finishes on doors and modesty panels, and lastly, worksurface grommets and power blocks for your electrical needs.

Zira is your most functional solution to work environment efficiency and organization.



Tops are available in a choice of 1" or 1.5" thick with a variety of edge details and a top over side, edge panel design.  
\* Shown with 1.5" thick top and bicut edge (CR).



Optional frosted or ribbed glazing on doors and modesty panels. Available with Silver or Black frames.



Collator option is available for the convenient storage of day-to-day documents. Available in Black (BK) or Brushed Cobalt (BC) finish.

**Features and Benefits**

- 45 lb. density particle board substructure with high performance thermally fused laminate.
- Top over side panel design.
- Worksurfaces feature 2mm edging in matching color.
- Available in 1" or 1.5" thick top with a variety of edge details.
- 11/16" thick full modesty panel is standard.
- 11/16" thick 3/4 modesty panel available on most components.
- Pencil tray included in the box drawer.
- Lateral file drawers can accommodate letter or legal documents.
- Premium full extension progressive ball bearing slides on file drawers and box drawers.
- All drawer fronts edge banded with side pull opening pedestals and standard pedestal locks.
- Compatible with **Divide** partitioning systems for increased privacy and storage requirements.

## GENERAL INFORMATION

- Modular collection with over 5000 different standard components available.
- Collection includes elements and options that can deliver a custom millwork feel to any space.
- Handles, lock finish and trim color (if applicable) must match.
- Specification information begins on page 125.
- Dimensionally compatible with the Adaptabilities and Divide series.
- For environmental certification, please visit [globalfurnituregroup.com](http://globalfurnituregroup.com).

## WORKSURFACES

- Available in 1" or 1.5" thick thermally fused laminate tops with a variety of edge details.
- Tops are sealed with Global's preferred edge in matching color. Woodgrain surfaces feature edging with matching printed woodgrain.
- High pressure (**HP**) tops are available in all Zira laminate finishes at an extended lead time. Please see model # for pricing and availability.
- Products specified with the HP option are finished on the underside of the surface with a kraft paper backing.

## CONSTRUCTION

- Constructed of 45 lb. density particle board with high performance thermally fused laminate.
- All desks are size (incrementally) accurate.
- All desk drawers/storage feature built-in pulls; optional applied pulls are available in 9 different styles.
- Models with monopost are standard with 4" square monopost. Optional 5" round and 4" round monoposts are available at no upcharge. Available in Black (**TBL**) or Tungsten (**TTU**) finish, please specify.
- Leveling glides are standard on all floor units.
- Premium full extension progressive ball bearing slides on file drawers & box drawers.
- All drawer fronts are edge banded with side pull opening pedestals and standard pedestal locks.

## HEIGHT ADJUSTABLE DESKS

- Zira height adjustable desks include a laminate chassis. **Height adjustable base mechanism to be ordered separately.**
- Use **FTZ52SFNL** with all **ZHxx60Fxx**, **ZHxx66Fxx**, **ZHxx72Fxx** and **ZHxx60NP** models.
- Use **FTZ52LFNL** with all **ZHxx84Fxx**, **ZHxx66NP**, **ZHxx72NP** and **ZHxx84NP** models.
- Use **FTZ539FSLNL** with all **ZH60xx24L/R** models.
- Steel constructed Kick & Click™ top frame with soft start/stop technology.
- Table frame designed with 50mm x 80mm rectangular outer leg with the larger tube attaching to a bracket within the pedestal.
- Control box ensures optimal parallel drive and low noise level (<55dB(a) in typical applications)
- Powder coat finish for base is available in Black (**BLK**) or Tungsten (**TUN**), specify finish.
- Wire management channels available in Black (**BK**) or Silver (**SI**). Silver (**SI**) complements Tungsten.
- Zira height adjustable desks have 2 stages and feature an adjustment range of 29.5"/30" - 49.2"/49.7".
- Lift capacity of 300 lbs.
- Operates at 1.5" per second.
- Power rate 18V Max.10.0A.
- Each lifting column is equipped with a motor and parallel/memory drive.

## HANDSET

- Standard up/down handset (**SH**) with two memory positions. No digital readout. Diode stand reminder. Bluetooth compatible with FreeFit's Desk Control™ App. Black only.
- Handset with digital readout and four programmable settings is optional, Bluetooth compatible, stand reminder light bar, specify Digital readout handset (**DH**). **Add \$66.** Silver only.



Standard handset (**SH**)



Digital readout handset (**DH**)

## MODESTY PANELS

- Laminate full modesty panel is standard. Laminate ¾ modesty panel is available on select models at no additional charge. Please specify (**34**).
- Glazing options are available on both the full modesty panel and ¾ modesty panel, please specify. See next page for options and codes.
- 11/16" thick full modesty panel is standard.
- 11/16" thick ¾ modesty panel available on most components.
- **Note:** Woodgrain modesty panels over 60" wide will have the grain pattern in the horizontal direction. All end panels and modesty panels 60" or less will have the grain pattern in the vertical direction.

## STORAGE

- All lateral files feature a foolproof interlock device.
- Pencil tray included in box drawer.
- Lateral file drawers can accommodate letter or legal documents.
- All drawers are locking unless otherwise noted.
- Front-to-back filing bars for all steel drawer files available separately. Order FBB bars. See Metal Filing + Storage price list page 14 for pricing.
- All desks, returns and credenzas with fixed storage are shipped standard with box/box/file, file/file or box/file 16" wide pedestals.
- Storage modules, wardrobe cabinets, personal towers, hutches and table top bookcases have  $\frac{11}{16}$ " thick shelves.
- End shelves, bookcases and table top end shelves have 1" thick shelves.
- **All shelves are 3 position fixed/height adjustable.**
- Storage cabinets less than **30" wide are not intended to be freestanding** and should be ganged or anchored. Specific units indicating counterweight included do not require ganging. Ganging hardware and instructions are provided. Interior of all cabinets are pre-drilled for ganging connections; drill through on site is required.
- Adjustable shelves can be positioned to accept **binder** storage as follows:  
For **29" to 53"H** units where applicable:
  - with one shelf - cannot accommodate binder row
  - with two shelves - can accommodate one row of binders
  - with three shelves - can accommodate two rows of binders
  - with four shelves - can accommodate three rows of bindersFor **65.5" to 84.5"H** units where applicable:
  - with one shelf - can accommodate one row of binders
  - with two shelves - 65.5" and 72" H can accommodate one row of binders  
84" H can accommodate two rows of binders
  - with three shelves - can accommodate two rows of binders
  - with four shelves - can accommodate three rows of binders
  - with five shelves - can accommodate four rows of binders
  - with six shelves - can accommodate five rows of binders

## LOCKS

- Locks are standard on all storage modules. Finish will coordinate with handles and/or aluminum doors. For desk, return or table components where no handles is default, please specify lock finish: Black (**BK**) or Silver (**SI**).
- Optional key alike or specific key number for all products with locks.
- Reserved for new orders greater than \$20,000 list, all Zira units with locks can be ordered with a cap option (**CA**) under the lock option and specific lock cores/keys can be ordered separately for field installation rather than specifying duplicate product lines with different key numbers.
- When **CA** option is specified, units will ship with a cap over the empty lock housing.
- Order the appropriate number of cores with keys separately: use product code **SIL-CORE-H-SHOE** for Silver core/key sets, **BLK-CORE-H-SHOE** for Black core/key sets. Specify quantity and lock number required (one order per line per key number required). Key number range: 401 to 440. Must be ordered at the same time the product is ordered with a lock cap option (**CA**) specified.
- Also require one core removal key, recommend one core removal per every 25 cores ordered, order product code **REMOVE-K-H-SHOE**.
- No charge applies for separate lock cores or core removal keys only when ordered with the product. If replacement lock core and key required, contact Customer Service for applicable product code and pricing.

## SHIPPING

- Shipped assembled, 1 per carton, unless otherwise noted. Other components are easy to assemble.

## SPECIAL SIZES

- Special widths are available on most products with open knee space. To price, take the list price of the next larger standard size up and add **5%**. Quotations are not required, some exceptions may apply.
- For custom widths outside of the range of standard sizes published or any custom depths, submit a SPECIALS / MTM quote request through the Global Dealer Centre.
- Orders must indicate the custom quote number and list price.
- Changes to custom quotes are not permitted. Any revisions will necessitate a new quotation.

## HUTCHES

- 71" wide hutches (actual width 71.69") are for use when a hutch is placed across the back of a 42" wide return and across the depth of a 30" deep surface top (actual depth 29.69").

## SPECIFICATIONS

- Specifications marked with an \* are applicable to only those products which have the \* symbol beside the product name.



1. SPECIFY MODEL NUMBER

2. SPECIFY FINISH AND TOP THICKNESS/EDGE DETAIL

- All units available in solid color (top and chassis matching) or two-tone combination except for the following units:
  - Shells: one tone in all standard finishes.
  - Collators: one tone in Black (BK) or Brushed Cobalt (BC).
  - Horizontal pigeon holes: one tone in all standard finishes.
  - Vertical and transitional pigeon holes: two-tone - chassis/shell in all standard finishes, collator shelves in Black (BK) or Brushed Cobalt (BC).

Finishes:

<b>ACJ</b> Absolute Acajou	<b>FCL</b> First Class
<b>ASN</b> Asian Night	<b>NBL</b> Noce Biondo
<b>AWC</b> Avant Cherry	<b>NGL</b> Noce Grigio
<b>AWH</b> Avant Honey	<b>NEL</b> Noce Leggero
<b>BLK</b> Black	<b>NML</b> Noce Medio
<b>BZD</b> Blizzard	<b>QTM</b> Quartered Mahogany
<b>BRC</b> Brushed Cobalt	<b>SBY</b> Sheer Beauty
<b>CMB</b> Clear Maple	<b>SDT</b> Stonedust
<b>CGY</b> Custom Grey	<b>SOG</b> Storm Grey
<b>DES</b> Dark Espresso	<b>WHE</b> Walnut Heights
<b>DWT</b> Designer White	<b>WHC</b> White Chocolate
<b>FAS</b> Fashionista	<b>WCR</b> Winter Cherry

Top Thickness / Edge Detail:

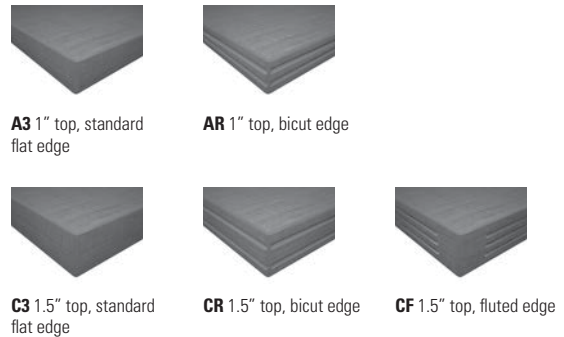

3. SPECIFY OPTIONS

BOX DRAWERS (no upcharge)

- Specify B\_ (drawer position 1-4 must be specified)

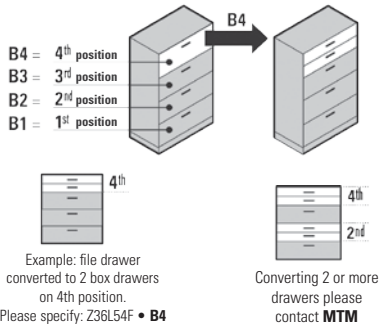

- Not available on drawers with steel interiors

MONOPOST

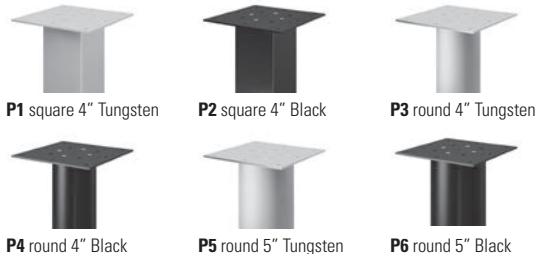

O-LEG DETAIL

- Available in Black (TBL) or Tungsten (TTU).



HANDLES

- Handles are standard on all lateral drawers and doors, and are included in the published list price. When ordering, please select handle from the list of options below.
- Integrated vertical fingers pulls are the standard default for mobile pedestals, hanging pedestals, and where BBF or FF pedestals are part of a desk, return, credenza or corner desk. Handles are optional on these units with a **list price upcharge of \$62**. If a handle is not desired, please specify lock finish: Black (BK) or Silver (SI).
- General guideline: when handles are shown in the individual product lineart within the price list, handles are included. When not shown in the individual product lineart, a **list price upcharge of \$62** applies if a handle option is selected.
- To order handles, please specify corresponding code to image as shown below.

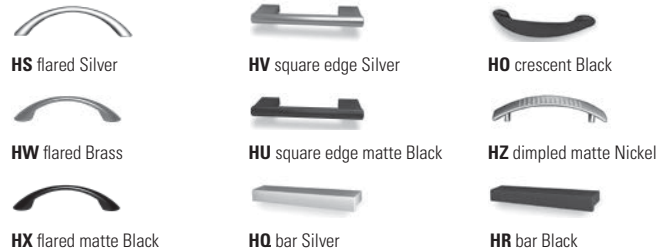

## GROMMETS

- Additional grommets available in standard worksurface locations (left, center or right).
- Order as: **FOG1, FOG2 or FOG3. Add \$91.**

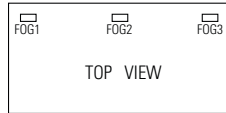
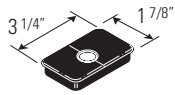

- Grommet hole dimensions are 3.25" wide x 1.875" deep.
- Actual grommet locations on the worksurface are depicted in the example drawings shown below. Dimensions shown are actual measurements (in inches).

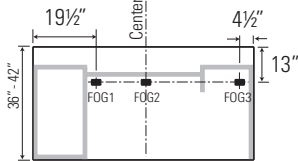

**Straight Front**

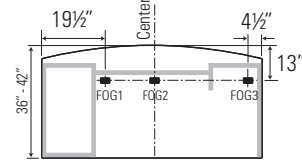

**Bow Front**

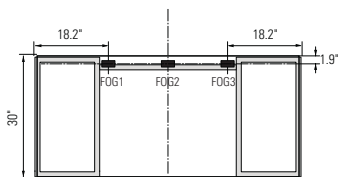

**HA Double Ped**

Primary top is oversized **0.5" (12.5mm)** in width on both sides to allow for gap to mitigate pinch points.

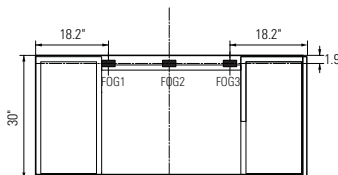
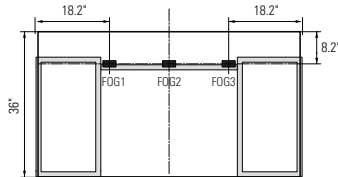

**HA Single Ped**

Primary top is oversized **1" (25mm)** in width with gap on left or right side depending on hand to allow for gap to mitigate pinch points.

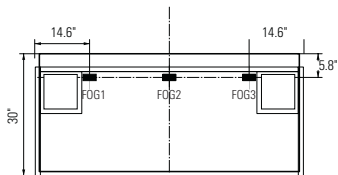
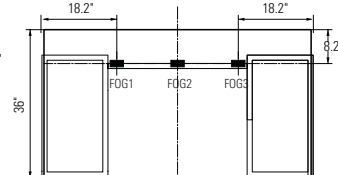

**Freestanding HA**

Primary top is oversized **1" (25mm)** in width on both sides to allow for gap to mitigate pinch points.

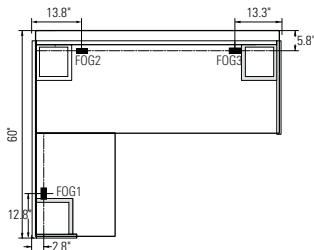

**L HA desk**

Primary top is oversized **0.9" (24.8mm)** in width on return side and **0.5" (12.5mm)** on ends to allow for gap to mitigate pinch points.

## GROMMETS (cont'd)

- Grommets may be placed at non-standard locations (some products excluded). Order as: **CSG. Add \$132.**
- A drawing must be supplied with vertical and horizontal dimensions to the center of the cut-out (as in drawing above). Please refer to the **custom grommet location form** in the back reference section.
- Alternative grommet positions for "D", "P" and rectangular islands not shown in price list line art will require a SPECIALS / MTM quote request.
- Components that come standard with grommet, as stated within the product descriptions or shown in the corresponding price list lineart, may be ordered without a grommet.
- Option to remove standard grommet when required, specify **RSG**. Upcharge applies, **add \$51.**
- Option to remove standard grommet and add one in another position, specify **RSG** + applicable **FOG** position or **CSG**. Upcharge applies:
  - For **RSG + FOGx** combination, **add \$142.**
  - For **RSG + CSG** combination, **add \$183.**
- Option to add an additional grommet in a standard position, specify **FOGx**. Upcharge applies, **Add \$91.** For a customer specified location, specify **CSG. Add \$132.**
- Grommets are available on modesty panels of **extended corners** and **5-sided corners** 8" in where the two modesty panels meet at a 90° angle. Please specify **FOGMP-R** for right grommet placement and **FOGMP-L** for left grommet (placement is as shown on diagrams below). Cost is **\$132.**
- Modesty panels are 1" off of ground.

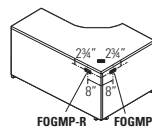

Left extended corner unit

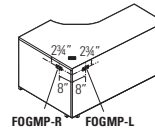

Right extended corner unit

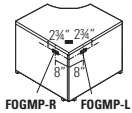

5-sided corner unit

## POWER BLOCK

- A power block (model **PMSDPM**) may be ordered on all worksurfaces.
- A power block is a rectangular worksurface power/data module with one electrical duplex receptacle and two data (RJ45) receptacles. 9 foot Black cord included. Power block dimensions are 6.5"W x 3.5"D x 2.75"H.
- To purchase a power block, you must specify both the power block cut-out location and the power block model #. Order power block as **PMSDPM. Add \$268.** Power blocks are available in standard worksurface locations (left, center or right). Order as **E1, E2 or E3. Add \$91.**

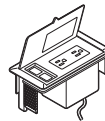

Power block **PMSDPM. Add \$268.**

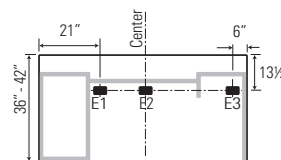

**Straight Front**

Specify location **E1, E2 or E3. Add \$91**

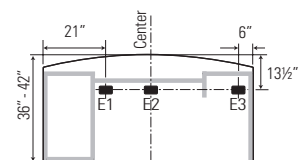

**Bow Front**

**Glazing (Doors and Modesty Panels)**



**Z1** frosted glazing, Tungsten (TUN) frame



**Z2** frosted glazing, Black (BLK) frame



**Z3** ribbed glazing, Tungsten (TUN) frame



**Z4** ribbed glazing, Black (BLK) frame



Full modesty panel - **Z1** frosted glazing, Tungsten (TUN) frame  
 $\frac{3}{4}$  modesty (shown) - **Z1 + 34**



Full modesty panel - **Z2** frosted glazing, Black (BLK) frame  
 $\frac{3}{4}$  modesty (shown) - **Z2 + 34**



Full modesty panel - **Z3** ribbed glazing, Tungsten (TUN) frame  
 $\frac{3}{4}$  modesty (shown) - **Z3 + 34**



Full modesty panel - **Z4** ribbed glazing, Black (BLK) frame  
 $\frac{3}{4}$  modesty (shown) - **Z4 + 34**

## Executive Height Adjustable Desks

Available widths: 60", 66", 72", 84"

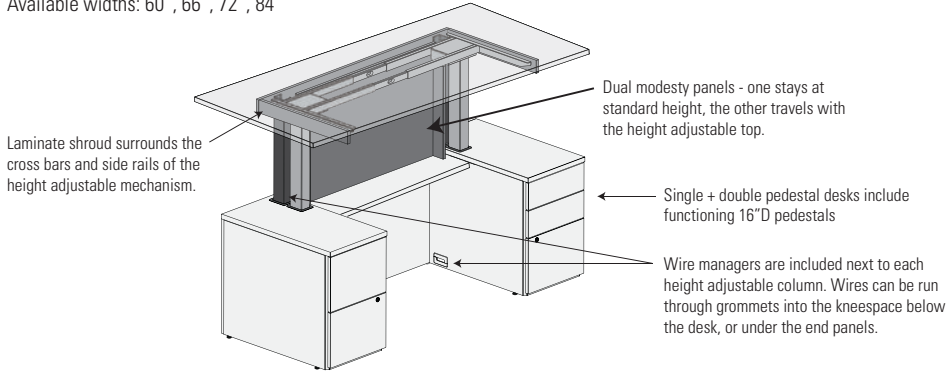

### Returns

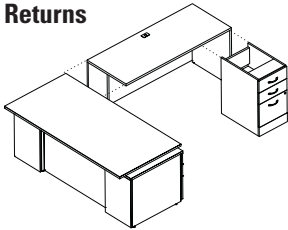

### For "L" Shape Layouts

- Pre-configured
- With custom shell storage

### Bridges

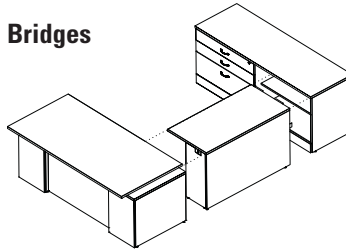

### For "U" shape Layouts

## Top Conditions for Height Adjustable Desks

Top recesses are to minimize potential pinch points when adjacent to fixed surfaces

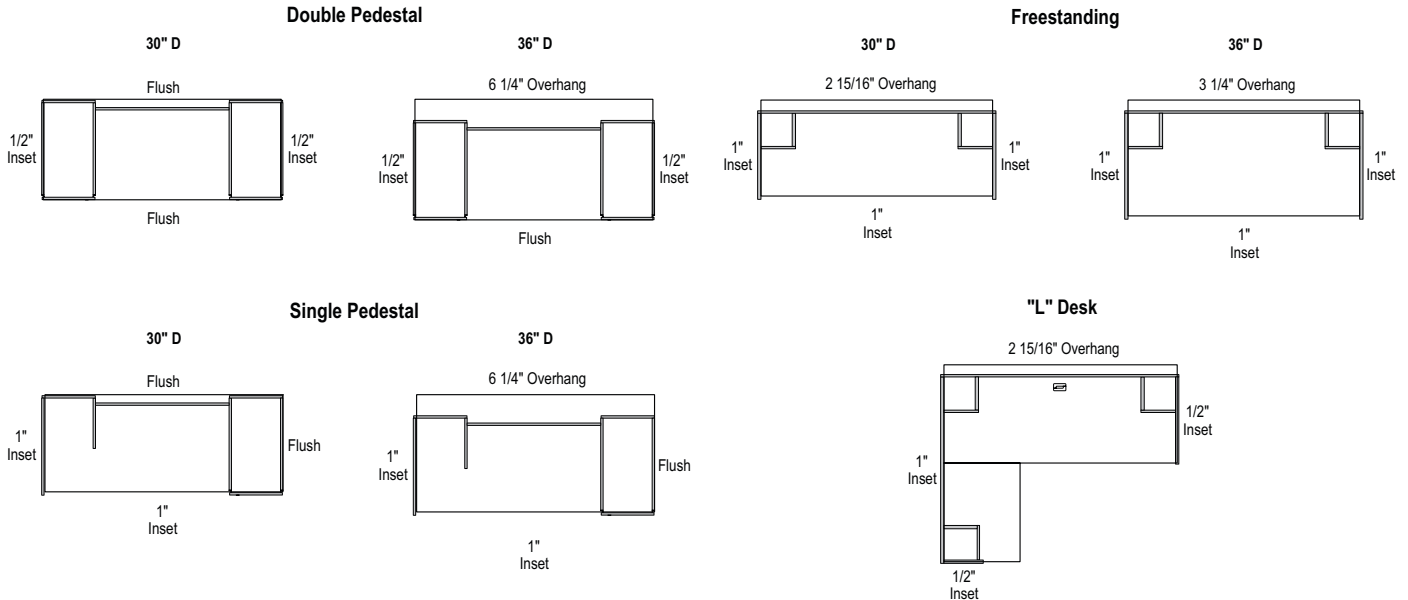

## Wall Panels

Grommet locations for wall panels

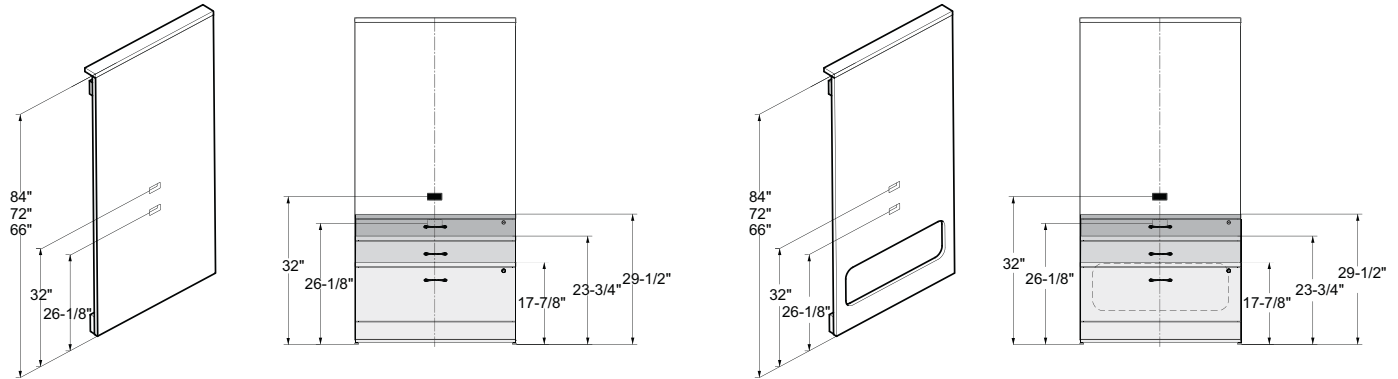

- FOG1 grommet sits at 26 1/8" above the floor, just about 1-1/2 high storage, but below standard 29 1/2" storage
- FOG2 grommet sits at 32" above the floor, above 29 1/2" storage
- When the wall with wire management access is specified, the wire management access opening will sit below all storage heights.

### Weight capacities for wall panels

- When mounting customer supplied flat screen or other to a wall panel, total weight including mounting hardware **should not exceed 140 lbs.** in total. Not approved for use with articulating or extendable mounting arms.
- Wall panels with floating shelves: (Note: weight should be evenly distributed over surface)  
**24"W units** up to 50 lbs.; **30"W units** up to 65 lbs.; **36"W units** up to 75 lbs.; **42"W units** up to 90 lbs. per floating shelf.
- Wall panels with with overhead cabinet storage: (Note: weight should be evenly distributed over surface)  
**66"H - 24"W units** 30 lbs. top/55 lbs. inside bottom; **30"W units** 40 lbs. top/70 lbs. inside bottom; **36"W units** 45 lbs. top/85 lbs. inside bottom;  
**42"W units** 55 lbs. top/95 lbs. inside bottom.  
**72"H - 24"W units** 30 lbs. top/65 lbs. inside bottom; **30"W units** 40 lbs. top/80 lbs. inside bottom; **36"W units** 50 lbs. top/95 lbs. inside bottom;  
**42"W units** 60 lbs. top/100 lbs. inside bottom.  
**84"H - 24"W units** 30 lbs. top/65 lbs. shelf and inside bottom; **30"W units** 40 lbs. top/80 lbs. shelf and inside bottom; **36"W units** 50 lbs. top/95 lbs. shelf and inside bottom;  
**42"W units** 60 lbs. top/100 lbs. shelf and inside bottom.

Desks / Extended Corner Desks - available width: 60", 66", 72" 84"

Modesty treatments

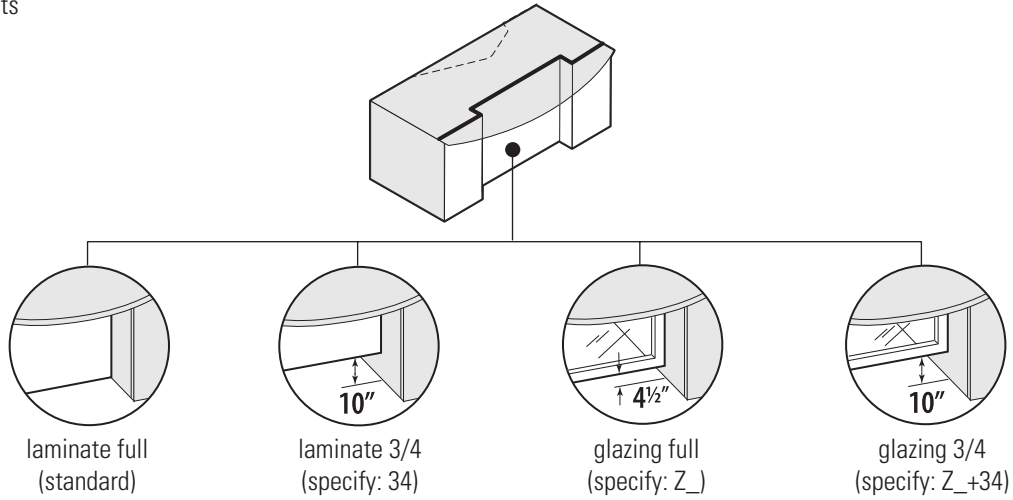

Overhang dimensions

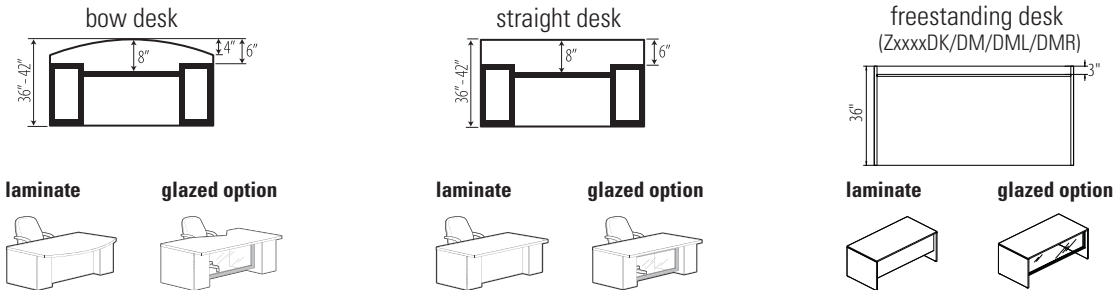

Returns - available width: 36", 42", 48", 54", 60", 66", 72"

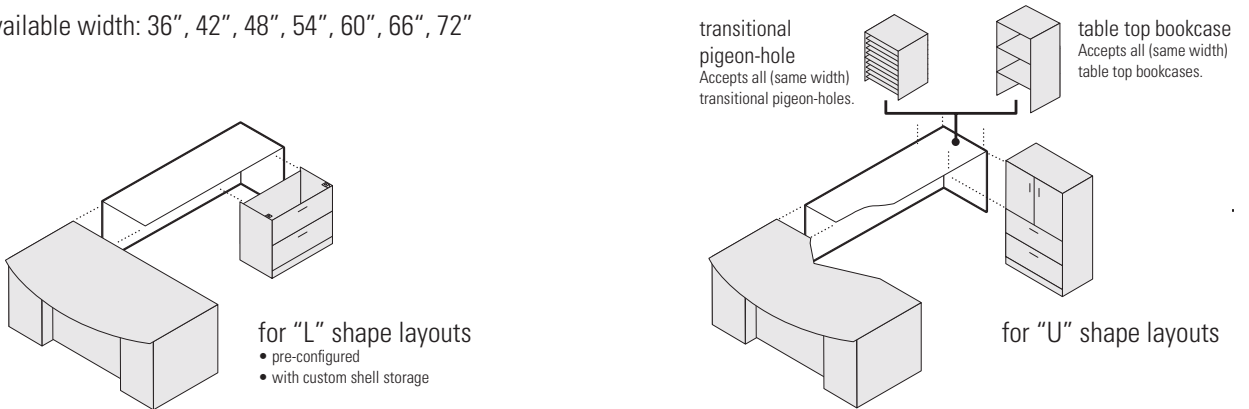

Bridges - available width: 42", 48"

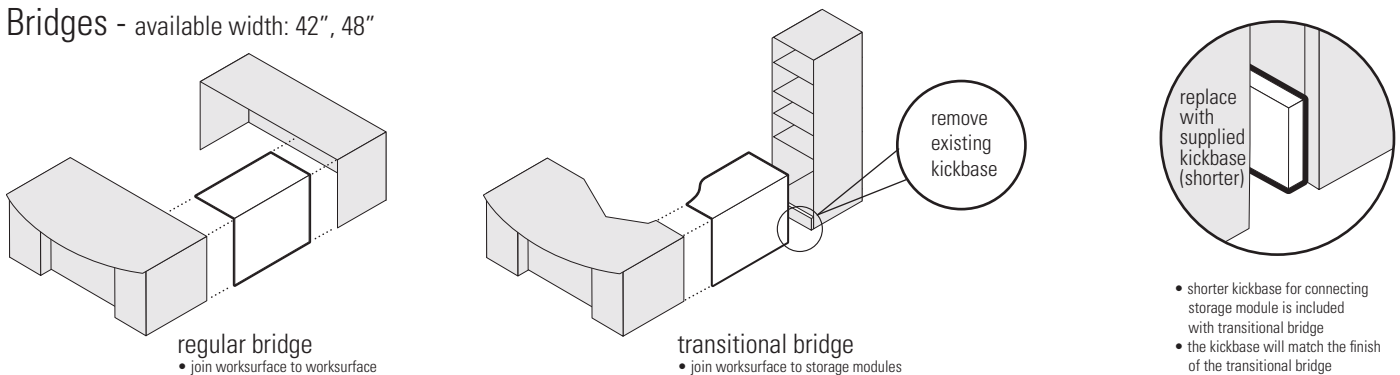

### Extended Corners - available widths: 60", 66", 72", 84"

#### Modesty treatments

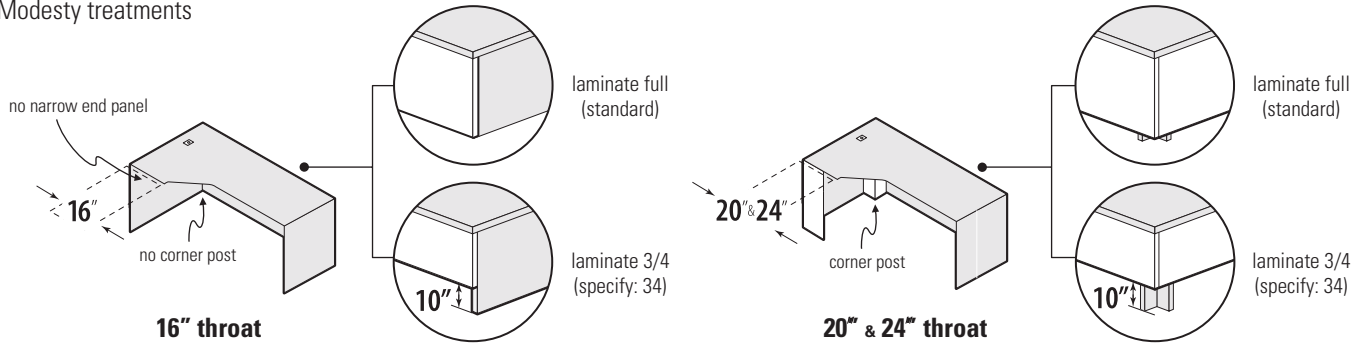

### Extended Corner Islands - available width: 60", 66", 72", 84"

#### Modesty treatments

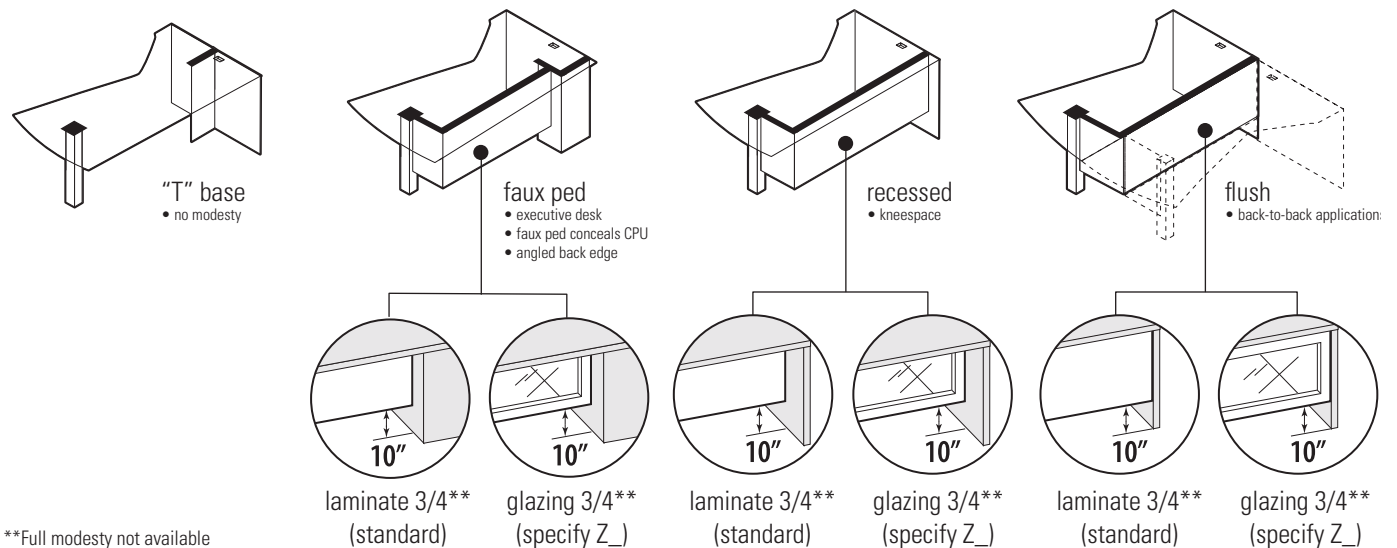

\*\*Full modesty not available

#### Overhang dimensions



### Shells - available width: 12", 15", 16", 18", 21", 30", 36"

For Extended Corners, Space Saver Returns, Space Saver Connectables and Space Saver Bridges

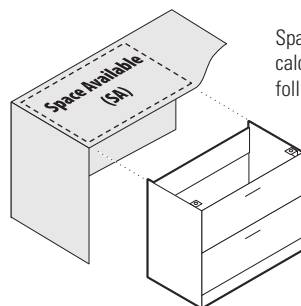

Space available can be calculated with the following formulas:

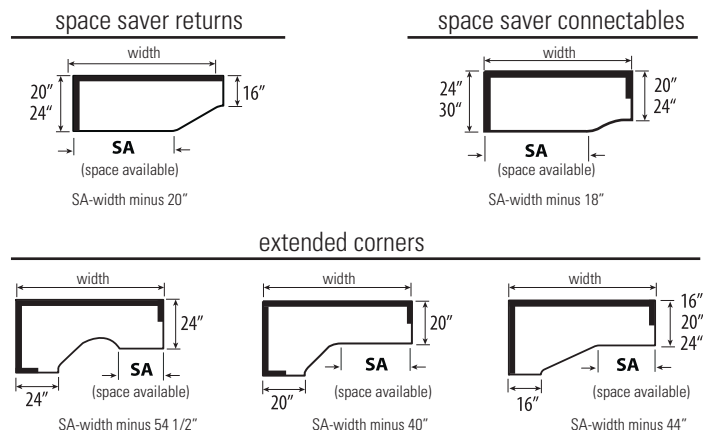

Storage

Closed

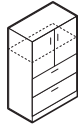

Cavity

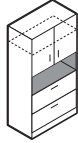

Open

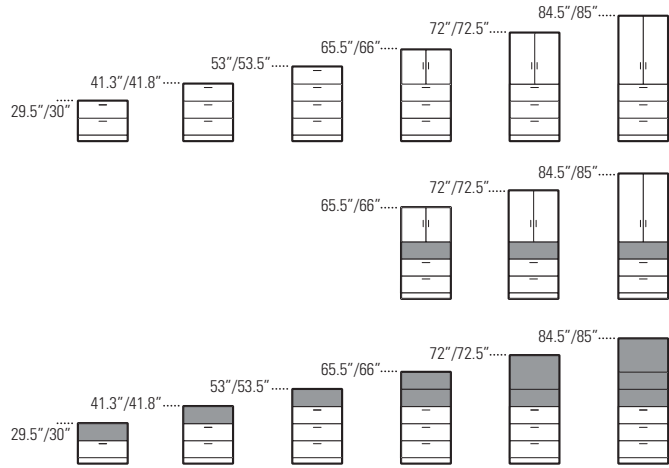
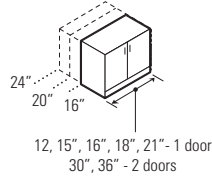
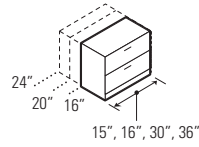
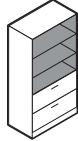

Wardrobe & Personal Towers

Closed

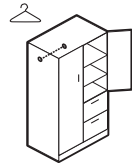

Cavity

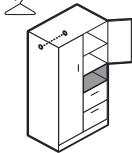

Open

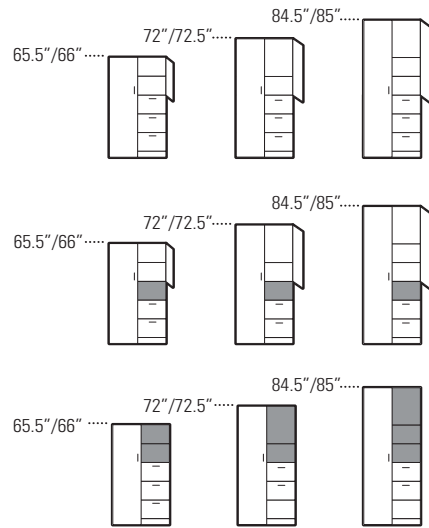
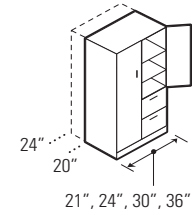
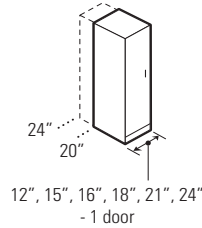
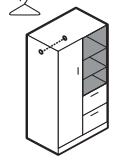

PC Support

PC support

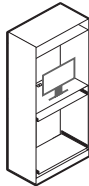

PC support with vertical drawer

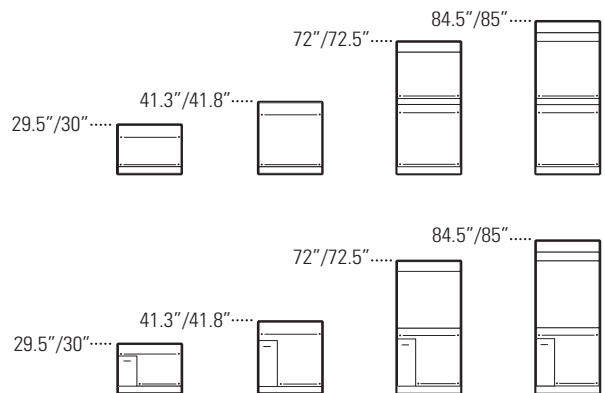
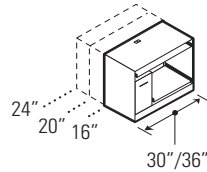
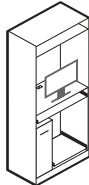

Vertical Utility Drawer

Closed

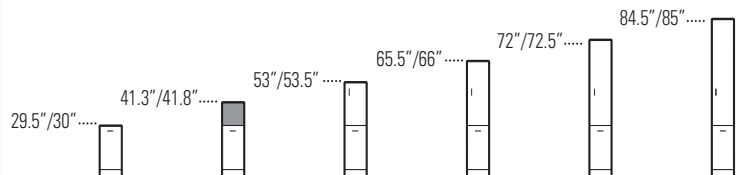
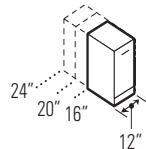



## Drawer & Cavity Positions

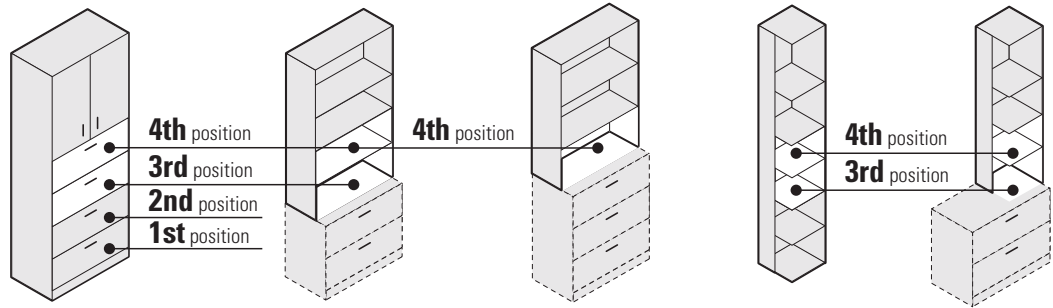

## Box Drawer Option

File drawers can be converted to box/box drawers in any of the four standard positions.

- B1 = 2 box drawers on 1st position
- B2 = 2 box drawers on 2nd position
- B3 = 2 box drawers on 3rd position
- B4 = 2 box drawers on 4th position

Not available on drawers with steel interiors.  
Not available on credenzas with lateral files.

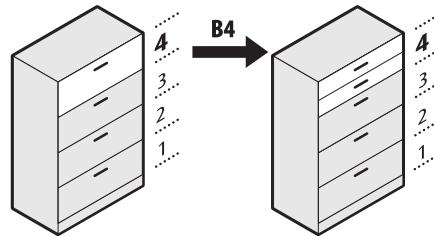

Example:  
File drawer converted to 2 box drawers on 4th position.

specify: Z36L54F - B4

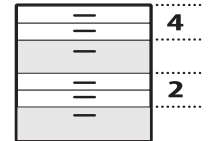

Converting 2 or more drawers to box drawers, please contact the Specials Department.

## Collator Positions

All storage units can be specified with an optional collator on 2<sup>nd</sup>, 3<sup>rd</sup> and/or 4<sup>th</sup> position

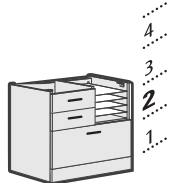

Collator on 2nd position  
specify: **2K - Black or 2T - Brushed Cobalt**

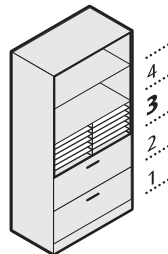

Collator on 3rd position  
specify: **3K - Black or 3T - Brushed Cobalt**

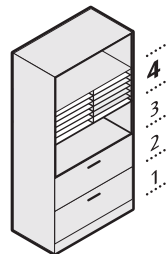

Collator on 4th position  
specify: **4K - Black or 4T - Brushed Cobalt**

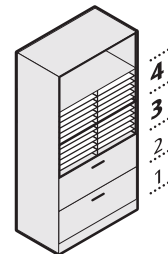

Collator on 3rd & 4th positions  
specify: **7K - Black or 7T - Brushed Cobalt**

For 2K / 2T, 3K / 3T or 4K / 4T - add \$200.

For 7K / 7T - add \$398.

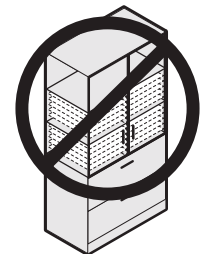

Collators do not fit behind doors

## Glazing

Glazing is available in the following options:

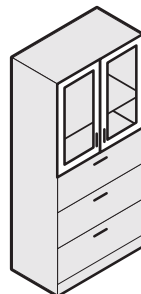

Silver frame  
frosted glazing  
Z1

specify:  
**Z36L73F - Z1**

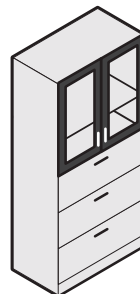

Black frame  
frosted glazing  
Z2

specify:  
**Z36L73F - Z2**

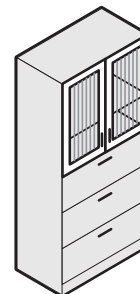

Silver frame  
ribbed glazing  
Z3

specify:  
**Z36L73F - Z3**

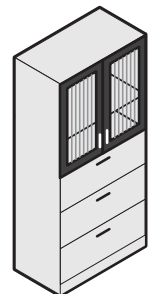

Black frame  
ribbed glazing  
Z4

specify:  
**Z36L73F - Z4**

### Filing Options - For Filing Components

On 16"D files, drawer interiors are only 13"D. On 20"D and 24"D files, drawer interiors are 16"D.  
 Full to floor BBF, FF and BF pedestals are 16"W with all pedestal desks, returns with pedestals and credenzas with pedestals.  
 Full to floor BBF and FF storage shells 15"W x 28.5"H are required under 36"W space saver return with 16"D connection top (Zxx3616Rx).

#### Side-to-Side

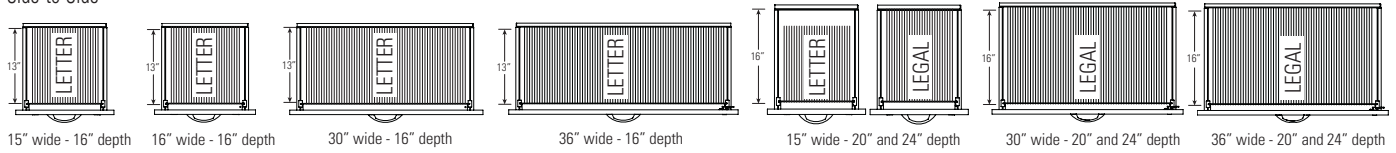

#### Front-to-Back

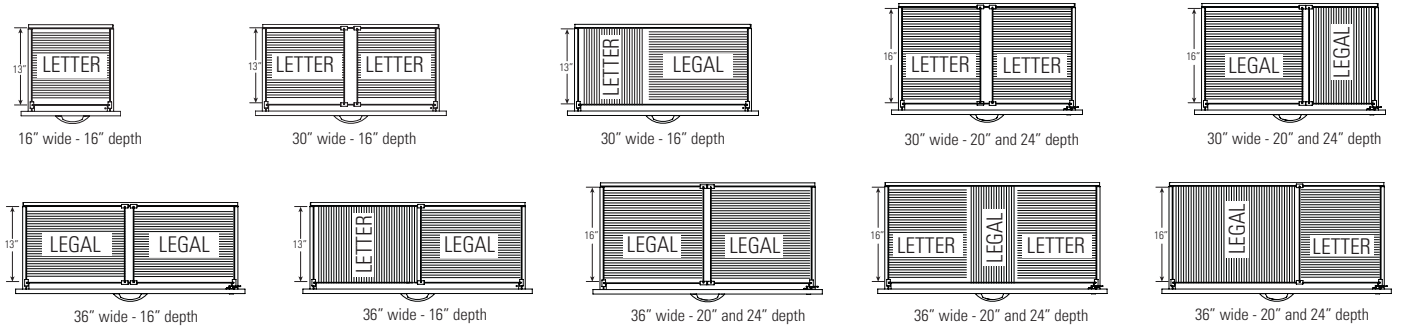

### Height Map

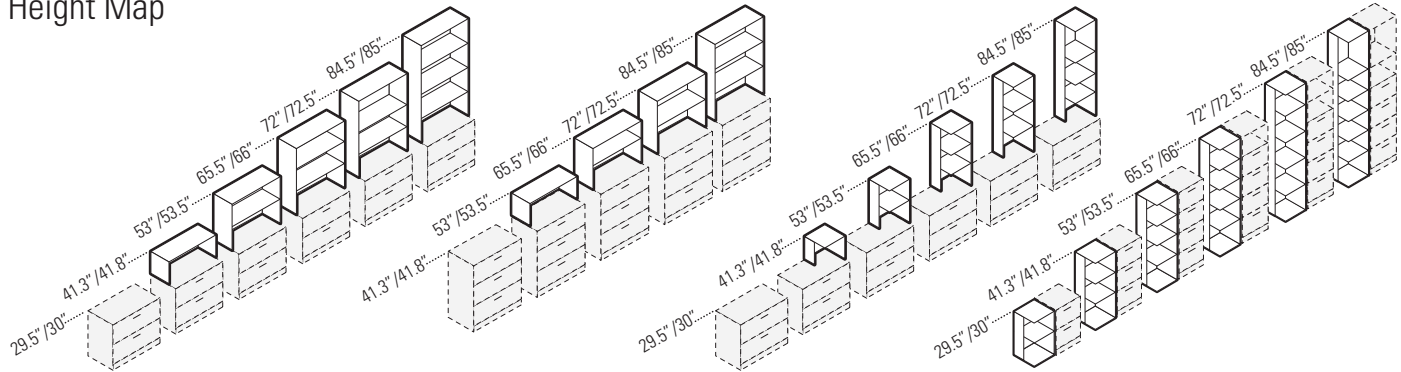

### Drawer & Cavity Positions

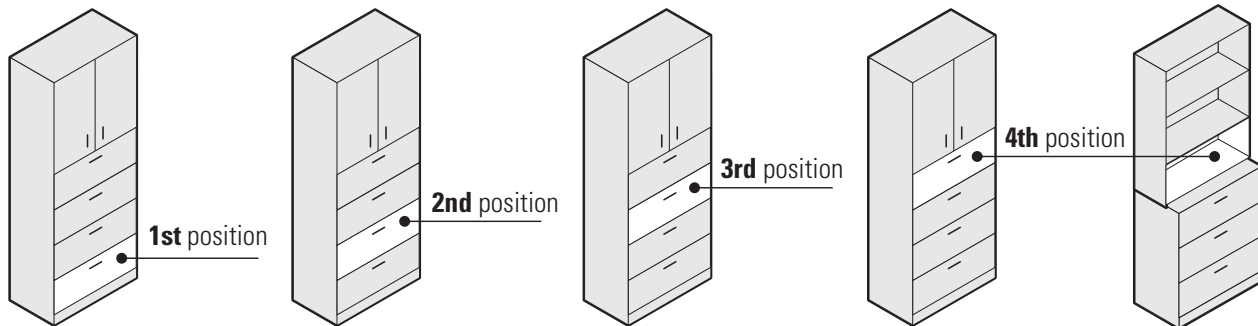

## Collator Positions

For 12"W to 21"W units

\*\*if no collator is desired, must specify when placing order.

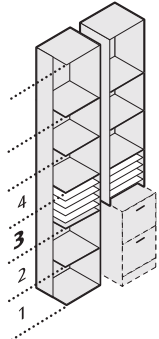

Collator on 3rd position  
specify: **3K - Black** or  
**3T - Brushed Cobalt**

For 3K / 3T or 4K / 4T - add \$220.

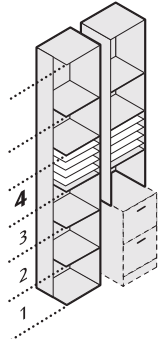

Collator on 4th position  
specify: **4K - Black** or  
**4T - Brushed Cobalt**

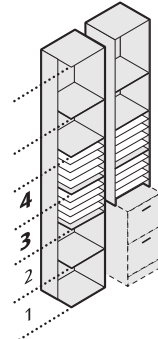

Collator on 3rd & 4th position  
specify: **7K - Black** or  
**7T - Brushed Cobalt**

For 7K / 7T - add \$438.

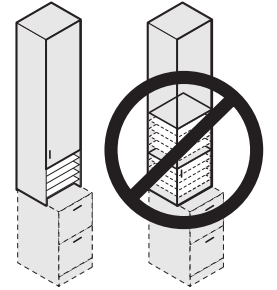

Collators do not fit behind doors

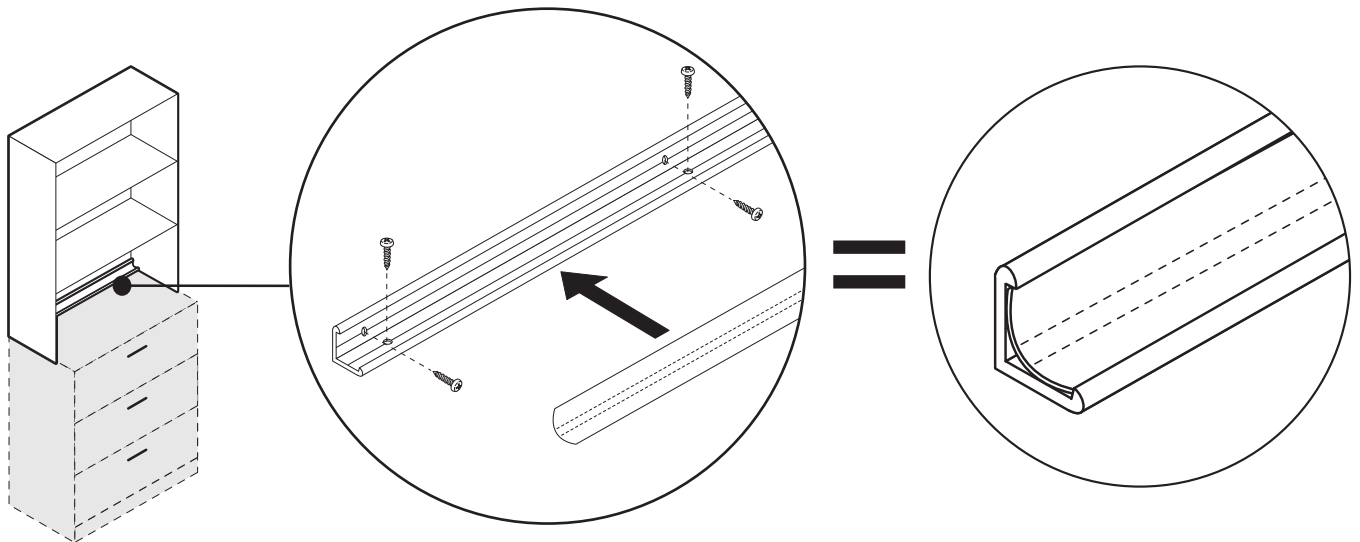

## Table Top Bookcase



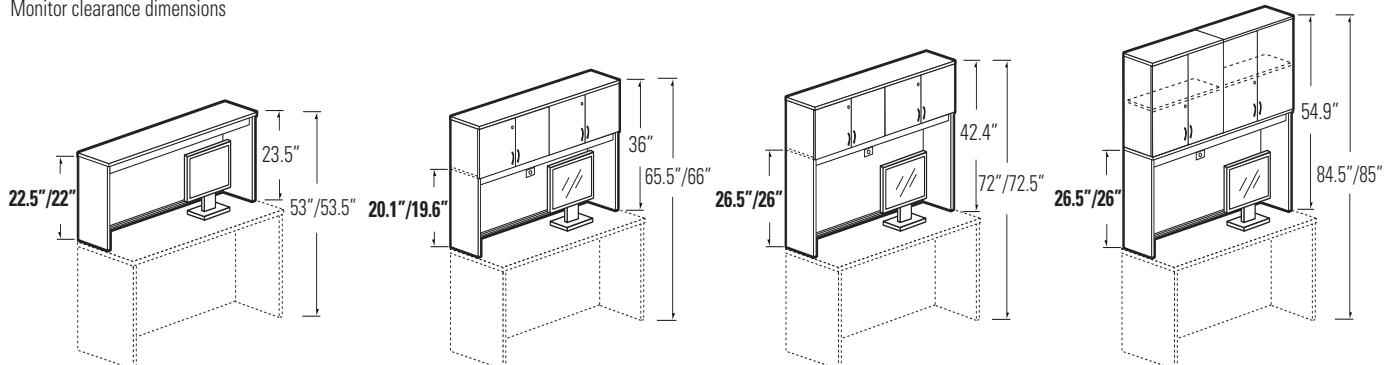

## Hutches

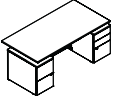
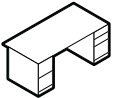
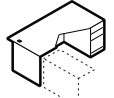
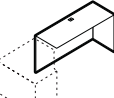
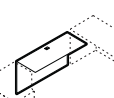
Monitor clearance dimensions

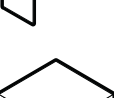
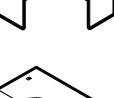
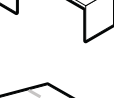
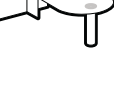
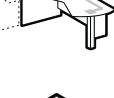
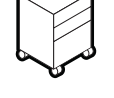

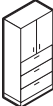
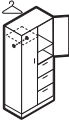
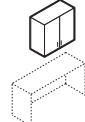
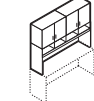
	<b>HEIGHT ADJUSTABLE DESKS</b> .....	125
	<b>DESKS</b> .....	130
	<b>EXTENDED CORNER DESKS</b> .....	150
	<b>RETURNS</b> .....	136
	<b>BRIDGES</b> .....	140
	<b>CREDENZAS</b> .....	143
	<b>TABLES &amp; CONNECTABLES</b> .....	157
	<b>FIVE-SIDED CORNERS</b> .....	149
	<b>EXTENDED CORNERS</b> .....	152
	<b>ISLANDS</b> .....	164
	<b>EXTENDED CORNER ISLANDS</b> .....	161
	<b>PEDESTALS</b> .....	168
	<b>SHELLS</b> .....	169

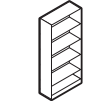
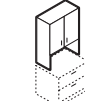
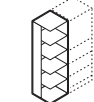
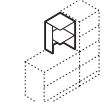
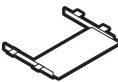
	<b>STORAGE MODULES</b>	
	17.87"/18.37"H.....	177
	23.75"/24.25"H.....	178
	29.5"/30"H.....	179
	41.3"/41.8"H.....	183
	53"/53.5"H.....	186
	65.5"/66"H.....	189
	72"/72.5"H.....	197
	84.5"/85"H.....	205
	<b>WARDROBES &amp; PERSONAL TOWERS</b>	
	65.5"/66"H.....	191
	72"/72.5"H.....	197
	84.5"/85"H.....	205
	<b>OVERHEAD STORAGE</b> .....	213
	<b>HUTCHES</b> .....	221
	<b>TACKBOARDS FOR HUTCHES</b> .....	237
	<b>PIGEON-HOLE STORAGE</b> .....	227
	<b>FLOATING SHELVES</b> .....	229
	<b>WALLS WITH OVERHEADS</b> .....	250
	<b>WALLS WITH FLOATING SHELVES</b> .....	231
	<b>WALL PANELS</b> .....	234
	<b>BOOKCASES</b> .....	250
	<b>TABLE TOP BOOKCASES</b> .....	251
	<b>END SHELVES</b> .....	261
	<b>TABLE TOP END SHELVES</b> .....	263
	<b>KEYBOARDS &amp; ACCESSORIES</b> .....	265



EXECUTIVE



MANAGEMENT



**TEAMING AREAS**



**MULTI-PERSON**

HEIGHT ADJUSTABLE DESKS

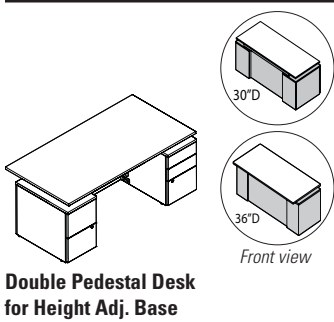

Double Pedestal Desk for Height Adj. Base

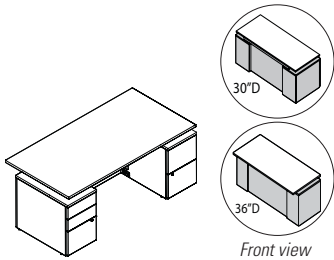

Double Pedestal Desk for Height Adj. Base

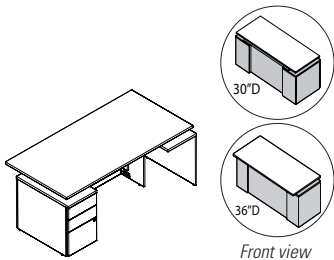

Single Pedestal Desk for Height Adj. Base

MODEL #	DIMENSIONS	WT/LB.	CUBIC FT.	1" TOP	1.5" TOP	GLAZE ADD	HP ADD
W x D x H (1.5" TOP)							
ZH3684F23	84 x 36 x 29.5-49.2	362	26.75	\$4622	\$4783	\$746	\$794
ZH3672F23	72 x 36 x 29.5-49.2	335	25.75	\$4521	\$4718	\$641	\$680
ZH3666F23	66 x 36 x 29.5-49.2	321	25.25	\$4417	\$4578	\$610	\$623
ZH3660F23	60 x 36 x 29.5-49.2	307	24.75	\$4212	\$4425	\$571	\$567
ZH3084F23	84 x 30 x 29.5-49.2	347	25.75	\$4521	\$4718	\$746	\$658
ZH3072F23	72 x 30 x 29.5-49.2	321	24.75	\$4404	\$4609	\$641	\$567
ZH3066F23	66 x 30 x 29.5-49.2	309	24.25	\$4286	\$4469	\$610	\$523
ZH3060F23	60 x 30 x 29.5-49.2	296	23.75	\$4168	\$4329	\$571	\$475

Standard with file/file (FF) pedestal on **left** and box/box/file (BBF) pedestal on **right**. BBF - file drawer and lower box drawer lock. FF - drawers lock. Height adjustable base sold separately: for 60"-72" wide desks, specify with height adjustable base FTZ52SFNL (small frame); for 84" wide desks, specify with FTZ52LFNL (large frame). Shipped easy to assemble in 3 cartons.  
**30"D** - Top is recessed 1/2" on either sides over chassis; flush on user and guest sides.  
**36"D** - Top is recessed 1/2" on either sides over chassis; flush on user side and 6.25" overhang on guest side.

ZH3684F32	84 x 36 x 29.5-49.2	362	26.75	\$4622	\$4783	\$746	\$794
ZH3672F32	72 x 36 x 29.5-49.2	335	25.75	\$4521	\$4718	\$641	\$680
ZH3666F32	66 x 36 x 29.5-49.2	321	25.25	\$4417	\$4578	\$610	\$623
ZH3660F32	60 x 36 x 29.5-49.2	307	24.75	\$4212	\$4425	\$571	\$567
ZH3084F32	84 x 30 x 29.5-49.2	347	25.75	\$4521	\$4718	\$746	\$658
ZH3072F32	72 x 30 x 29.5-49.2	321	24.75	\$4404	\$4609	\$641	\$567
ZH3066F32	66 x 30 x 29.5-49.2	309	24.25	\$4286	\$4469	\$610	\$523
ZH3060F32	60 x 30 x 29.5-49.2	296	23.75	\$4168	\$4329	\$571	\$475

Standard with box/box/file (BBF) pedestal on **left** and file/file (FF) pedestal on **right**. BBF - file drawer and lower box drawer lock. FF - drawers lock. Height adjustable base sold separately: for 60"-72" wide desks, specify with height adjustable base FTZ52SFNL (small frame); for 84" wide desks, specify with (large frame). Shipped easy to assemble in 3 cartons.  
**30"D** - Top is recessed 1/2" on either sides over chassis; flush on user and guest sides.  
**36"D** - Top is recessed 1/2" on either sides over chassis; flush on user side and 6.25" overhang on guest side.

ZH3684F3S	84 x 36 x 29.5-49.2	325	26.75	\$4199	\$4425	\$746	\$794
ZH3672F3S	72 x 36 x 29.5-49.2	298	25.75	\$4094	\$4373	\$641	\$680
ZH3666F3S	66 x 36 x 29.5-49.2	284	25.25	\$3937	\$4151	\$610	\$623
ZH3660F3S	60 x 36 x 29.5-49.2	271	24.75	\$3789	\$3985	\$571	\$567
ZH3084F3S	84 x 30 x 29.5-49.2	310	25.75	\$4094	\$4373	\$746	\$658
ZH3072F3S	72 x 30 x 29.5-49.2	285	24.75	\$3981	\$4177	\$641	\$567
ZH3066F3S	66 x 30 x 29.5-49.2	272	24.25	\$3854	\$4042	\$610	\$523
ZH3060F3S	60 x 30 x 29.5-49.2	260	23.75	\$3737	\$3902	\$571	\$475

Standard with box/box/file pedestal on **left**. File drawer and lower box drawer lock. Height adjustable base sold separately: for 60"-72" wide desks, specify with height adjustable base FTZ52SFNL (small frame); for 84" wide desks, specify with FTZ52LFNL (large frame). Shipped easy to assemble in 3 cartons.  
**30"D** - Top is recessed 1" on non-pedestal side and user side over chassis; flush on pedestal side and guest side.  
**36"D** - Top is recessed 1" on non-pedestal side and user side over chassis; flush on pedestal side and 6.25" overhang on guest side.

**Required specifications**

Top finish Top/edge detail  
 Base finish  
 Wire management finish  
 Default no handle, specify lock finish

**Optional specifications**

HP laminate Handles  
 Key # Modesty finish glazed  
 Modesty type  
 Grommet position or power block cut-out

**Accessories**

Must specify height adjustable base separately  
 Pencil drawer  
 Power block

HEIGHT ADJUSTABLE DESKS

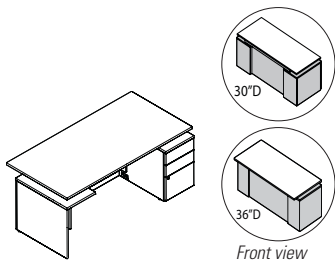

Single Pedestal Desk for Height Adj. Base\*

MODEL #	DIMENSIONS	WT/LB.	CUBIC FT.	1" TOP	1.5" TOP	GLAZE ADD	HP ADD
W x D x H (1.5" TOP)							
ZH3684FS3	84 x 36 x 29.5-49.2	325	26.75	\$4199	\$4425	\$746	\$794
ZH3672FS3	72 x 36 x 29.5-49.2	298	25.75	\$4094	\$4373	\$641	\$680
ZH3666FS3	66 x 36 x 29.5-49.2	284	25.25	\$3937	\$4151	\$610	\$623
ZH3660FS3	60 x 36 x 29.5-49.2	271	24.75	\$3789	\$3985	\$571	\$567
ZH3084FS3	84 x 30 x 29.5-49.2	310	25.75	\$4094	\$4373	\$746	\$658
ZH3072FS3	72 x 30 x 29.5-49.2	285	24.75	\$3981	\$4177	\$641	\$567
ZH3066FS3	66 x 30 x 29.5-49.2	272	24.25	\$3854	\$4042	\$610	\$523
ZH3060FS3	60 x 30 x 29.5-49.2	260	23.75	\$3737	\$3902	\$571	\$475

Standard with box/box/file pedestal on **right**. File drawer and lower box drawer lock. Height adjustable base sold separately: for 60"-72" wide desks, specify with height adjustable base FTZ52SFNL (small frame); for 84" wide desks, specify with FTZ52LFNL (large frame). Shipped easy to assemble in 3 cartons.

**30"D** - Top is recessed 1" on non-pedestal side and user side over chassis; flush on pedestal side and guest side.

**36"D** - Top is recessed 1" on non-pedestal side and user side over chassis; flush on pedestal side and 6.25" overhang on guest side.

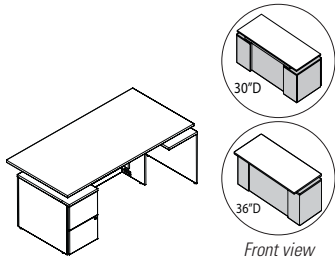

Single Pedestal Desk for Height Adj. Base\*

ZH3684F2S	84 x 36 x 29.5-49.2	323	26.75	\$4142	\$4369	\$746	\$794
ZH3672F2S	72 x 36 x 29.5-49.2	296	25.75	\$4059	\$4343	\$641	\$680
ZH3666F2S	66 x 36 x 29.5-49.2	282	25.25	\$3872	\$4085	\$610	\$623
ZH3660F2S	60 x 36 x 29.5-49.2	268	24.75	\$3732	\$3928	\$571	\$567
ZH3084F2S	84 x 30 x 29.5-49.2	308	25.75	\$4059	\$4343	\$746	\$658
ZH3072F2S	72 x 30 x 29.5-49.2	283	24.75	\$3924	\$4120	\$641	\$567
ZH3066F2S	66 x 30 x 29.5-49.2	270	24.25	\$3798	\$3985	\$610	\$523
ZH3060F2S	60 x 30 x 29.5-49.2	258	23.75	\$3680	\$3846	\$571	\$475

Standard with file/file pedestal on **left**. Pedestal locks. Height adjustable base sold separately: for 60"-72" wide desks, specify with height adjustable base FTZ52SFNL (small frame); for 84" wide desks, specify with FTZ52LFNL (large frame). Shipped easy to assemble in 3 cartons.

**30"D** - Top is recessed 1" on non-pedestal side and user side over chassis; flush on pedestal side and guest side.

**36"D** - Top is recessed 1" on non-pedestal side and user side over chassis; flush on pedestal side and 6.25" overhang on guest side.

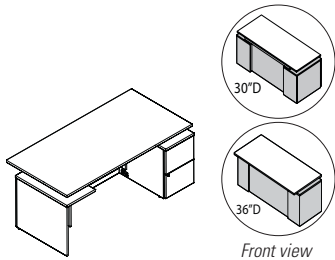

Single Pedestal Desk for Height Adj. Base\*

ZH3684FS2	84 x 36 x 29.5-49.2	323	26.75	\$4142	\$4369	\$746	\$794
ZH3672FS2	72 x 36 x 29.5-49.2	296	25.75	\$4059	\$4343	\$641	\$680
ZH3666FS2	66 x 36 x 29.5-49.2	282	25.25	\$3872	\$4085	\$610	\$623
ZH3660FS2	60 x 36 x 29.5-49.2	268	24.75	\$3732	\$3928	\$571	\$567
ZH3084FS2	84 x 30 x 29.5-49.2	308	25.75	\$4059	\$4343	\$746	\$658
ZH3072FS2	72 x 30 x 29.5-49.2	283	24.75	\$3924	\$4120	\$641	\$567
ZH3066FS2	66 x 30 x 29.5-49.2	270	24.25	\$3798	\$3985	\$610	\$523
ZH3060FS2	60 x 30 x 29.5-49.2	258	23.75	\$3680	\$3846	\$571	\$475

Standard with file/file pedestal on **right**. Pedestal locks. Height adjustable base sold separately: for 60"-72" wide desks, specify with height adjustable base FTZ52SFNL (small frame); for 84" wide desks, specify with FTZ52LFNL (large frame). Shipped easy to assemble in 3 cartons.

**30"D** - Top is recessed 1" on non-pedestal side and user side over chassis; flush on pedestal side and guest side.

**36"D** - Top is recessed 1" on non-pedestal side and user side over chassis; flush on pedestal side and 6.25" overhang on guest side.

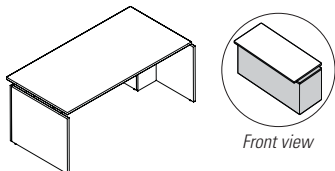

Desk Shell for Height Adj. Base

ZH3684NP	84 x 36 x 29.5-49.2	231	10.5	\$2808	\$3074	N/A	\$794
ZH3672NP	72 x 36 x 29.5-49.2	209	9.25	\$2760	\$2991	N/A	\$680
ZH3666NP	66 x 36 x 29.5-49.2	198	8.5	\$2677	\$2891	N/A	\$623
ZH3660NP	60 x 36 x 29.5-49.2	187	7.75	\$2616	\$2808	N/A	\$567
ZH3072NP	72 x 30 x 29.5-49.2	188	8.75	\$2625	\$2830	N/A	\$567
ZH3066NP	66 x 30 x 29.5-49.2	178	8	\$2542	\$2729	N/A	\$523
ZH3060NP	60 x 30 x 29.5-49.2	168	7.5	\$2503	\$2664	N/A	\$475

Height adjustable base sold separately: for 60" wide desks, specify with height adjustable base FTZ52SFNL (small frame); for 66"-84" wide desks, specify with FTZ52LFNL (large frame). Shipped easy to assemble in 3 cartons.

**30"D** - Top is recessed 1" on user and both sides over chassis; 2 15/16" overhang on guest side.

**36"D** - Top is recessed 1" on user and both sides over chassis; 3.25" overhang on guest side.

**Required specifications**

Top finish      Top/edge detail  
 Base finish  
 Wire management finish  
 Default no handle, specify lock finish\*

**Optional specifications**

HP laminate      Handles\*  
 Key #\*      Modesty finish glazed  
 Modesty type  
 Grommet position or power block cut-out

**Accessories**

Desk and height adjustable base to be ordered separately  
 Pencil drawer  
 Power block



**HEIGHT ADJUSTABLE DESKS**      **MODEL #**      **DIMENSIONS**      **WT/LB.**      **CUBIC FT.**      **1" TOP**      **1.5" TOP**      **GLAZE ADD**      **HP ADD**



**Height Adjustable Base**

**W x D x H (1.5" TOP)**

Small frame								
FTZ52SFNL	60 x 30 x 29.5-49.2	43	2.2	<b>\$1830</b>	N/A	N/A	N/A	
Large frame								
FTZ52LFNL	66 x 30 x 29.5-49.2	43	2.2	<b>\$1835</b>	N/A	N/A	N/A	

For use with Zira height adjustable desks 60"-84" wide. Lifts 300 lbs. Available in Black (**BLK**) or Tungsten (**TUN**).

- For 60-72" wide models ending in F23/F32/F3S/FS3/F2S/FS2, specify FTZ52SFNL; for 84" wide models specify FTZ52LFNL
- For 60" wide models ending in NP, specify FTZ52SFNL; for 66-84" wide NP models, specify FTZ52LFNL.
- **Recommended torque range for installing all fasteners is 3 to 5 foot-pounds and should not be exceeded. In addition, no impact drivers or high-torque equipment are to be used for any fasteners included in the base assembly kits, as this creates a high risk for damage that is not covered under warranty. The use of hand tools is highly recommended.**

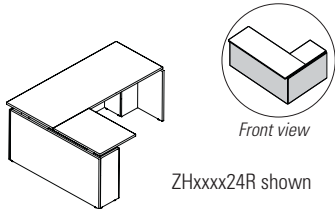

**L Desk Shell for Height Adj. Base\***

ZH608424L	84 x 60 x 29.5-49.2	294	14.5	<b>\$3675</b>	<b>\$3959</b>	N/A	<b>\$1003</b>
ZH607224L	72 x 60 x 29.5-49.2	273	13.25	<b>\$3510</b>	<b>\$3767</b>	N/A	<b>\$894</b>
ZH608424R	84 x 60 x 29.5-49.2	294	14.5	<b>\$3675</b>	<b>\$3959</b>	N/A	<b>\$1003</b>
ZH607224R	72 x 60 x 29.5-49.2	273	13.25	<b>\$3510</b>	<b>\$3767</b>	N/A	<b>\$894</b>

Specify ZH60xx24L for **LEFT** with return on the right side or ZH60xx24R for **RIGHT** with return on left side. Tops on long return side are recessed 1" over chassis; 1/2" recessed on primary top (non return side) and 2 15/16" overhang on guest side. Height adjustable base FTZ539FSLNL sold separately. Shipped easy to assemble in 4 cartons.

- Only accepts FTZ539FSLNL 2-stage, 3-leg height adjustable base.

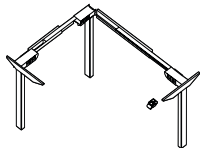

**Height Adjustable Base**

FTZ539FSLNL	60 x 24 x 29.5-49.2	86	4.5	<b>\$3144</b>	N/A	N/A	N/A
-------------	---------------------	----	-----	---------------	-----	-----	-----

For use with Zira height adjustable L desks. Lifts 300 lbs. Available in Black (**BLK**) or Tungsten (**TUN**).

- **Recommended torque range for installing all fasteners is 3 to 5 foot-pounds and should not be exceeded. In addition, no impact drivers or high-torque equipment are to be used for any fasteners included in the base assembly kits, as this creates a high risk for damage that is not covered under warranty. The use of hand tools is highly recommended.**

**MODESTY PANEL KITS**

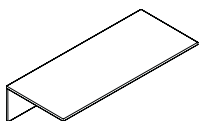

**Top and Modesty Panel Kit**

ZH3084TB	84 x 30 x 16	99	6.75	<b>\$1256</b>	<b>\$1587</b>	<b>\$746</b>	<b>\$658</b>
ZH3072TB	72 x 30 x 16	85	6	<b>\$1107</b>	<b>\$1391</b>	<b>\$641</b>	<b>\$567</b>
ZH3066TB	66 x 30 x 16	79	5.5	<b>\$1033</b>	<b>\$1299</b>	<b>\$610</b>	<b>\$523</b>
ZH3060TB	60 x 30 x 16	71	5	<b>\$920</b>	<b>\$1164</b>	<b>\$571</b>	<b>\$475</b>
ZH3054TB	54 x 30 x 16	64	4.5	<b>\$850</b>	<b>\$1068</b>	<b>\$536</b>	<b>\$432</b>
ZH3048TB	48 x 30 x 16	57	4	<b>\$780</b>	<b>\$972</b>	<b>\$506</b>	<b>\$379</b>
ZH3042TB	42 x 30 x 16	50	3.75	<b>\$702</b>	<b>\$872</b>	<b>\$475</b>	<b>\$331</b>
ZH2484TB	84 x 24 x 16	86	5.5	<b>\$1121</b>	<b>\$1391</b>	<b>\$746</b>	<b>\$532</b>
ZH2472TB	72 x 24 x 16	74	5	<b>\$994</b>	<b>\$1225</b>	<b>\$641</b>	<b>\$453</b>
ZH2466TB	66 x 24 x 16	68	4.5	<b>\$920</b>	<b>\$1142</b>	<b>\$610</b>	<b>\$419</b>
ZH2460TB	60 x 24 x 16	61	4.25	<b>\$820</b>	<b>\$1025</b>	<b>\$571</b>	<b>\$379</b>
ZH2454TB	54 x 24 x 16	55	3.75	<b>\$759</b>	<b>\$937</b>	<b>\$536</b>	<b>\$344</b>
ZH2448TB	48 x 24 x 16	49	3.5	<b>\$698</b>	<b>\$859</b>	<b>\$506</b>	<b>\$301</b>
ZH2442TB	42 x 24 x 16	43	3	<b>\$619</b>	<b>\$776</b>	<b>\$475</b>	<b>\$266</b>

Top and 15"H modesty **for use with Foli height adjustable base PH3T6601**. Height adjustable frame not included. Shipped easy to assemble in 1 carton.

- Cannot be used with FTZ52SFNL, FTZ52LFNL or FTZ539FSLNL.

<b>Required specifications</b>	<b>Optional specifications</b>	<b>Accessories</b>
Top finish	HP laminate	Desk and height adjustable base to be ordered separately*
Top thickness/edge detail	Grommet position or power block cut-out	Pencil drawer*
Base finish		Power block
Wire management finish		

RETURNS COMPATIBLE W/HEIGHT ADJ. DESKS MODEL # DIMENSIONS WT/LB. CUBIC FT. 1" TOP 1.5" TOP GLAZE ADD HP ADD

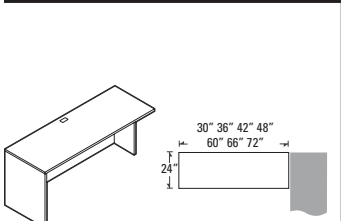

24" Deep Connectable Table - LEFT

	W x D x H (1.5" TOP)							
Z2472L	72 x 24 x 30	164	6	\$902	\$1069	N/A	\$345	
Z2466L	66 x 24 x 30	152	6	\$857	\$1012	N/A	\$330	
Z2460L	60 x 24 x 30	139	5.25	\$827	\$952	N/A	\$330	
Z2448L	48 x 24 x 30	115	4.3	\$783	\$894	N/A	\$263	
Z2442L	42 x 24 x 30	103	3.8	\$719	\$818	N/A	\$222	
Z2436L	36 x 24 x 30	92	3.3	\$705	\$770	N/A	\$167	
Z2430L	30 x 24 x 30	80	3.6	\$677	\$719	N/A	\$167	

**Full end panel on left.** Right narrow end panel connects to 24"D center/right connectable table, or at 90° angle to a freestanding table; 24"D extended corners or at the end of a straight run; "D" islands or "P" islands with "T" and "H" bases. Grommet in worksurface. Shipped easy to assemble in 1 carton.

- Modesty panel is 1" off of ground.

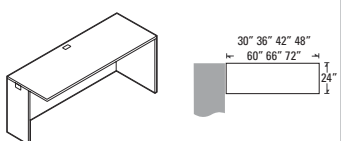

24" Deep Connectable Table - RIGHT

Z2472R	72 x 24 x 30	164	6	\$902	\$1069	N/A	\$345	
Z2466R	66 x 24 x 30	152	6	\$857	\$1012	N/A	\$330	
Z2460R	60 x 24 x 30	139	5.25	\$827	\$952	N/A	\$330	
Z2448R	48 x 24 x 30	115	4.3	\$783	\$894	N/A	\$263	
Z2442R	42 x 24 x 30	103	3.8	\$719	\$818	N/A	\$222	
Z2436R	36 x 24 x 30	92	3.3	\$705	\$770	N/A	\$167	
Z2430R	30 x 24 x 30	80	3.6	\$677	\$719	N/A	\$167	

**Full end panel on right.** Left narrow end panel connects to 24"D center/right connectable table, or at 90° angle to a freestanding table; 24"D extended corners or at the end of a straight run; "D" islands or "P" islands with "T" and "H" bases. Grommet in worksurface. Shipped easy to assemble in 1 carton.

- Modesty panel is 1" off of ground.

BRIDGES FOR CREDENZAS ZxxxxBB0L/R & ZxxxxBLFL/R

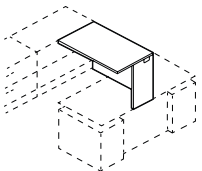

Bridge w/Full Laminate Modest - LEFT\*

ZA2448RL	48 x 24 x 30	78	4.3	\$935	\$1095	N/A	\$316	
ZA2442RL	42 x 24 x 30	66	3.8	\$815	\$955	N/A	\$276	
ZA2436RL	36 x 24 x 30	59	3.3	\$758	\$879	N/A	\$237	
ZA2048RL	48 x 20 x 30	72	4.3	\$892	\$1028	N/A	\$263	
ZA2042RL	42 x 20 x 30	62	3.8	\$777	\$896	N/A	\$231	
ZA2036RL	36 x 20 x 30	56	3.3	\$724	\$827	N/A	\$198	

**For use with height adjustable desks - single pedestal.** Connects to credenza on right. Shipped easy to assemble in 1 carton.

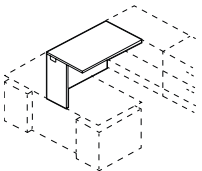

Bridge w/Full Laminate Modesty - RIGHT\*

ZA2448RR	48 x 24 x 30	78	4.3	\$935	\$1095	N/A	\$316	
ZA2442RR	42 x 24 x 30	66	3.8	\$815	\$955	N/A	\$276	
ZA2436RR	36 x 24 x 30	59	3.3	\$758	\$879	N/A	\$237	
ZA2048RR	48 x 20 x 30	72	4.3	\$892	\$1028	N/A	\$263	
ZA2042RR	42 x 20 x 30	62	3.8	\$777	\$896	N/A	\$231	
ZA2036RR	36 x 20 x 30	56	3.3	\$724	\$827	N/A	\$198	

**For use with height adjustable desks - single pedestal.** Connects to credenza on left. Shipped easy to assemble in 1 carton.

- Required specifications**
- Top finish
  - Top/edge detail
  - Base finish
  - Wire management finish

- Optional specifications**
- HP laminate
  - Modesty panel type\*
  - Grommet position or power block cut-out

- Accessories**
- Power block

**CRENZAS COMPATIBLE W/HEIGHT ADJ. BRIDGES**    **MODEL #**    **DIMENSIONS**    **WT/LB.**    **CUBIC FT.**    **1" TOP**    **1.5" TOP**    **GLAZE ADD**    **HP ADD**

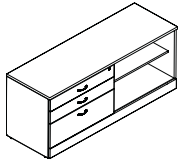

**Credenza**

**W x D x H (1.5" TOP)**

Z2472BBOL	72 x 24 x 30	261	35.75	<b>\$2784</b>	<b>\$2935</b>	N/A	<b>\$473</b>
Z2460BBOL	60 x 24 x 30	231	30	<b>\$2497</b>	<b>\$2621</b>	N/A	<b>\$395</b>
Z2072BBOL	72 x 20 x 30	234	30.25	<b>\$2659</b>	<b>\$2783</b>	N/A	<b>\$395</b>
Z2060BBOL	60 x 20 x 30	207	25.25	<b>\$2413</b>	<b>\$2518</b>	N/A	<b>\$329</b>

Compatible with height adjustable bridges. Box/box/lateral file on **left** with open storage on the **right**. Connects to bridge on **right**. Adjustable shelf. Shipped assembled in 1 carton.

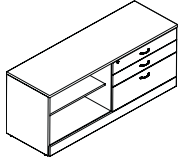

**Credenza**

Z2472BBOR	72 x 24 x 30	261	35.75	<b>\$2784</b>	<b>\$2935</b>	N/A	<b>\$473</b>
Z2460BBOR	60 x 24 x 30	231	30	<b>\$2497</b>	<b>\$2621</b>	N/A	<b>\$395</b>
Z2072BBOR	72 x 20 x 30	234	30.25	<b>\$2659</b>	<b>\$2783</b>	N/A	<b>\$395</b>
Z2060BBOR	60 x 20 x 30	207	25.25	<b>\$2413</b>	<b>\$2518</b>	N/A	<b>\$329</b>

Compatible with height adjustable bridges. Box/box/lateral file on **right** with open storage on the **left**. Connects to bridge on **left**. Adjustable shelf. Shipped assembled in 1 carton.

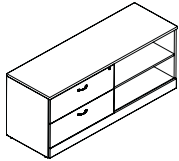

**Credenza**

Z2472BLFL	72 x 24 x 30	265	35.75	<b>\$2742</b>	<b>\$2892</b>	N/A	<b>\$473</b>
Z2460BLFL	60 x 24 x 30	235	30	<b>\$2472</b>	<b>\$2596</b>	N/A	<b>\$395</b>
Z2072BLFL	72 x 20 x 30	239	30.25	<b>\$2617</b>	<b>\$2740</b>	N/A	<b>\$395</b>
Z2060BLFL	60 x 20 x 30	212	25.25	<b>\$2382</b>	<b>\$2487</b>	N/A	<b>\$329</b>

Compatible with height adjustable bridges. Two drawer lateral file on **left** with open storage on the **right**. Connects to bridge on **right**. Adjustable shelf. Shipped assembled in 1 carton.

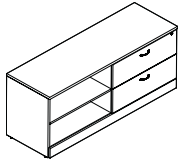

**Credenza**

Z2472BLFR	72 x 24 x 30	265	35.75	<b>\$2742</b>	<b>\$2892</b>	N/A	<b>\$473</b>
Z2460BLFR	60 x 24 x 30	235	30	<b>\$2472</b>	<b>\$2596</b>	N/A	<b>\$395</b>
Z2072BLFR	72 x 20 x 30	239	30.25	<b>\$2617</b>	<b>\$2740</b>	N/A	<b>\$395</b>
Z2060BLFR	60 x 20 x 30	212	25.25	<b>\$2382</b>	<b>\$2487</b>	N/A	<b>\$329</b>

Compatible with height adjustable bridges. Two drawer lateral file on **right** with open storage on the **left**. Connects to bridge on **left**. Adjustable shelf. Shipped assembled in 1 carton.

**Required specifications**

- Top finish
- Top/edge detail
- Base finish

**Optional specifications**

- HP laminate
- Key #
- Handles

DOUBLE PEDESTAL DESKS

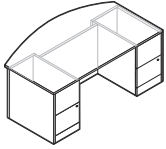

Double Pedestal Bow Top Desk\*

MODEL #	DIMENSIONS W x D x H (1.5" TOP)	WT/LB.	CUBIC FT.	1" TOP	1.5" TOP	GLAZE ADD	HP ADD
Z4284FB22	84 x 42 x 30	381	34.25	\$2694	\$2998	\$873	\$919
Z4272FB22	72 x 42 x 30	377	59	\$2586	\$2851	\$721	\$690
Z3672FB22	72 x 36 x 30	317	50.75	\$2413	\$2645	\$721	\$516
Z3666FB22	66 x 36 x 30	306	46.75	\$2365	\$2580	\$645	\$516
Z3660FB22	60 x 36 x 30	295	42.5	\$2298	\$2497	\$570	\$431

Standard with **freestanding** file/file pedestals on **left** and **right**. Pedestals lock. Bow top overhangs 2.25" at ends and 8.125" on center. Shipped assembled in 1 carton.

- 84" wide desks are shipped easy to assemble in 3 cartons.

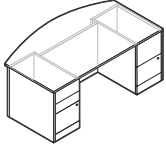

Double Pedestal Bow Top Desk\*

Z4284FB32	84 x 42 x 30	379	34.25	\$2726	\$3030	\$873	\$919
Z4272FB32	72 x 42 x 30	375	59	\$2621	\$2886	\$721	\$690
Z3672FB32	72 x 36 x 30	315	50.75	\$2446	\$2678	\$721	\$516
Z3666FB32	66 x 36 x 30	303	46.75	\$2401	\$2616	\$645	\$516
Z3660FB32	60 x 36 x 30	293	42.5	\$2331	\$2530	\$570	\$431

Standard with **freestanding** file/file pedestal on **right** and box/file pedestal on **left**. File drawer and lower box drawer locking. Bow top overhangs 2.25" at ends and 8.125" on center. Shipped assembled in 1 carton.

- 84" wide desks are shipped easy to assemble in 3 cartons.

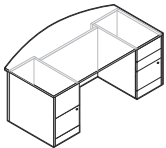

Double Pedestal Bow Top Desk

Z4284FB23	84 x 42 x 30	379	34.25	\$2726	\$3030	\$873	\$919
Z4272FB23	72 x 42 x 30	375	59	\$2621	\$2886	\$721	\$690
Z3672FB23	72 x 36 x 30	315	50.75	\$2446	\$2678	\$721	\$516
Z3666FB23	66 x 36 x 30	303	46.75	\$2401	\$2616	\$645	\$516
Z3660FB23	60 x 36 x 30	293	42.5	\$2331	\$2530	\$570	\$431

Standard with **freestanding** file/file pedestal on **left** and box/file pedestal on **right**. File drawer and lower box drawer locking. Bow top overhangs 2.25" at ends and 8.125" on center. Shipped assembled in 1 carton.

- 84" wide desks are shipped easy to assemble in 3 cartons.

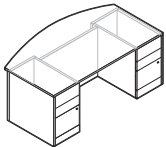

Double Pedestal Bow Top Desk

Z4284FB33	84 x 42 x 30	381	34.25	\$2761	\$3065	\$873	\$919
Z4272FB33	72 x 42 x 30	378	59	\$2654	\$2919	\$721	\$690
Z3672FB33	72 x 42 x 30	317	50.75	\$2483	\$2715	\$721	\$516
Z3666FB33	66 x 36 x 30	306	46.75	\$2434	\$2649	\$645	\$516
Z3660FB33	60 x 36 x 30	295	42.5	\$2369	\$2581	\$570	\$431

Standard with **freestanding** box/file pedestals on **left** and **right**. File drawer and lower box drawer locking. Bow top overhangs 2.25" at ends and 8.125" on center. Shipped assembled in 1 carton.

- 84" wide desks are shipped easy to assemble in 3 cartons.

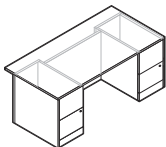

Double Pedestal Desk

Z4284F22	84 x 42 x 30	385	34.25	\$2597	\$2852	\$873	\$919
Z4272F22	72 x 42 x 30	373	59	\$2499	\$2721	\$721	\$690
Z3684F22	84 x 36 x 30	366	59	\$2444	\$2667	\$873	\$690
Z3672F22	72 x 36 x 30	326	50.75	\$2333	\$2527	\$721	\$516
Z3666F22	66 x 36 x 30	315	46.75	\$2287	\$2462	\$645	\$516
Z3660F22	60 x 36 x 30	295	42.5	\$2244	\$2407	\$570	\$431
Z3072F22	72 x 29.7 x 30	293	44	\$2333	\$2527	\$721	\$516
Z3066F22	66 x 29.7 x 30	315	40.25	\$2287	\$2462	\$645	\$516
Z3060F22	60 x 29.7 x 30	268	36.25	\$2244	\$2407	\$570	\$431

Standard with **freestanding** file/file pedestals on **left** and **right**. Pedestals lock. Shipped assembled in 1 carton.

- 84" wide desks are shipped easy to assemble in 3 cartons.

Required specifications

Top finish  
Top thickness/edge detail  
Base finish  
Lock finish

Optional specifications

HP laminate  
Key #  
Modesty type  
Grommet position or power block cut-out

Accessories

Pencil drawer  
Power block

**DOUBLE PEDESTAL DESKS**

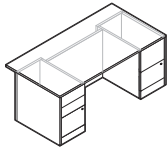

**Double Pedestal Desk**

MODEL #	DIMENSIONS	WT/LB.	CUBIC FT.	1" TOP	1.5" TOP	GLAZE ADD	HP ADD
W x D x H (1.5" TOP)							
Z4284F32	84 x 42 x 30	383	34.25	\$2631	\$2886	\$873	\$919
Z4272F32	72 x 42 x 30	371	59	\$2536	\$2758	\$721	\$690
Z3684F32	84 x 36 x 30	365	59	\$2478	\$2701	\$873	\$690
Z3672F32	72 x 36 x 30	324	50.75	\$2366	\$2560	\$721	\$516
Z3666F32	66 x 36 x 30	313	46.75	\$2323	\$2498	\$645	\$516
Z3660F32	60 x 36 x 30	267	42.5	\$2278	\$2441	\$570	\$431
Z3072F32	72 x 29.7 x 30	324	44	\$2366	\$2560	\$721	\$516
Z3066F32	66 x 29.7 x 30	281	40.25	\$2323	\$2498	\$645	\$516
Z3060F32	60 x 29.7 x 30	266	36.25	\$2278	\$2441	\$570	\$431

Standard with **freestanding** box/box/file pedestal on **left** and file/file pedestal on **right**. File drawer and lower box drawer locking. Shipped assembled in 1 carton.

- 84" wide desks are shipped easy to assemble in 3 cartons.

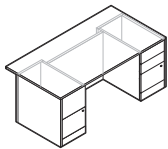

**Double Pedestal Desk**

Z4284F23	84 x 42 x 30	383	34.25	\$2631	\$2886	\$873	\$919
Z4272F23	72 x 42 x 30	371	59	\$2536	\$2758	\$721	\$690
Z3684F23	84 x 36 x 30	365	59	\$2478	\$2701	\$873	\$690
Z3672F23	72 x 36 x 30	324	50.75	\$2366	\$2560	\$721	\$516
Z3666F23	66 x 36 x 30	313	46.75	\$2323	\$2498	\$645	\$516
Z3660F23	60 x 36 x 30	267	42.5	\$2278	\$2441	\$570	\$431
Z3072F23	72 x 29.7 x 30	292	44	\$2366	\$2560	\$721	\$516
Z3066F23	66 x 29.7 x 30	281	40.25	\$2323	\$2498	\$645	\$516
Z3060F23	60 x 29.7 x 30	266	36.25	\$2278	\$2441	\$570	\$431

Standard with **freestanding** file/file pedestal on **left** and box/box/file pedestal on **right**. File drawer and lower box drawer locking. Shipped assembled in 1 carton.

- 84" wide desks are shipped easy to assemble in 3 cartons.

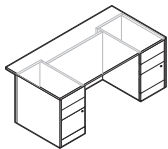

**Double Pedestal Desk**

Z4284F33	84 x 42 x 30	381	34.25	\$2664	\$2919	\$873	\$919
Z4272F33	72 x 42 x 30	370	59	\$2571	\$2793	\$721	\$690
Z3684F33	84 x 36 x 30	341	59	\$2511	\$2734	\$873	\$690
Z3672F33	72 x 36 x 30	316	50.75	\$2402	\$2596	\$721	\$516
Z3666F33	66 x 36 x 30	305	46.75	\$2357	\$2532	\$645	\$516
Z3660F33	60 x 36 x 30	261	42.5	\$2313	\$2476	\$570	\$431
Z3072F33	72 x 29.7 x 30	291	44	\$2402	\$2596	\$721	\$516
Z3066F33	66 x 29.7 x 30	280	40.25	\$2357	\$2532	\$645	\$516
Z3060F33	60 x 29.7 x 30	261	36.25	\$2313	\$2476	\$570	\$431

Standard with **freestanding** box/box/file pedestals on **left** and **right**. File drawer and lower box drawer locking. Shipped assembled in 1 carton.

- 84" wide desks are shipped easy to assemble in 3 cartons.

**SINGLE PEDESTAL DESKS**

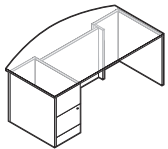

**Single Pedestal Bow Top Desk - LEFT**

W x D x H (1.5" TOP)							
Z4284FB2L	84 x 42 x 30	322	21.75	\$2056	\$2360	\$873	\$919
Z4272FB2L	72 x 42 x 30	315	59	\$1954	\$2219	\$721	\$690
Z3672FB2L	72 x 36 x 30	281	50.75	\$1811	\$2043	\$721	\$516
Z3666FB2L	66 x 36 x 30	275	46.75	\$1761	\$1976	\$645	\$516
Z3660FB2L	60 x 36 x 30	260	42.5	\$1691	\$1890	\$570	\$431

Standard with **freestanding** file/file pedestal on **left** and faux pedestal on **right**. Pedestal locks. Bow top overhangs 2.25" at ends and 8.125" on center. Shipped assembled in 1 carton.

- 84" wide desks are shipped easy to assemble in 2 cartons.

**Required specifications**

Top finish  
Top thickness/edge detail  
Base finish  
Lock finish

**Optional specifications**

HP laminate      Handles  
Key #              Modesty finish glazed  
Modesty type  
Grommet position or power block cut-out

**Accessories**

Pencil drawer  
Power block

SINGLE PEDESTAL DESKS

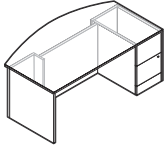

Single Pedestal Bow Top Desk - RIGHT

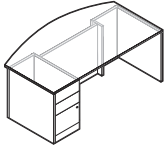

Single Pedestal Bow Top Desk - LEFT

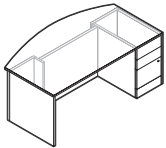

Single Pedestal Bow Top Desk - RIGHT

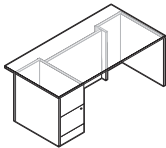

Single Pedestal Desk - LEFT

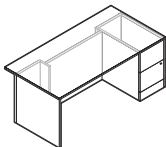

Single Pedestal Desk - RIGHT

MODEL #	DIMENSIONS	WT/LB.	CUBIC FT.	1" TOP	1.5" TOP	GLAZE ADD	HP ADD
W x D x H (1.5" TOP)							
Z4284FB2R	84 x 42 x 30	322	21.75	\$2056	\$2360	\$873	\$919
Z4272FB2R	72 x 42 x 30	315	59	\$1954	\$2219	\$721	\$690
Z3672FB2R	72 x 36 x 30	281	50.75	\$1811	\$2043	\$721	\$516
Z3666FB2R	66 x 36 x 30	275	46.75	\$1761	\$1976	\$645	\$516
Z3660FB2R	60 x 36 x 30	260	42.5	\$1691	\$1890	\$570	\$431

Standard with **freestanding** faux pedestal on **left** and file/file pedestal on **right**. Pedestal locks. Bow top overhangs 2.25" at ends and 8.125" on center. Shipped assembled in 1 carton.

- 84" wide desks are shipped easy to assemble in 2 cartons.

Z4284FB3L	84 x 42 x 30	320	21.75	\$2093	\$2397	\$873	\$919
Z4272FB3L	72 x 42 x 30	313	59	\$1986	\$2251	\$721	\$690
Z3672FB3L	72 x 36 x 30	280	50.75	\$1844	\$2076	\$721	\$516
Z3666FB3L	66 x 36 x 30	273	46.75	\$1797	\$2012	\$645	\$516
Z3660FB3L	60 x 36 x 30	258	42.5	\$1745	\$1944	\$570	\$431

Standard with **freestanding** box/box/file pedestal on **left** and faux pedestal on **right**. File drawer and lower box drawer locking. Bow top overhangs 2.25" at ends and 8.125" on center. Shipped assembled in 1 carton.

- 84" wide desks are shipped easy to assemble in 2 cartons.

Z4284FB3R	84 x 42 x 30	320	21.75	\$2093	\$2397	\$873	\$919
Z4272FB3R	72 x 42 x 30	313	59	\$1986	\$2251	\$721	\$690
Z3672FB3R	72 x 36 x 30	280	50.75	\$1844	\$2076	\$721	\$516
Z3666FB3R	66 x 36 x 30	273	46.75	\$1797	\$2012	\$645	\$516
Z3660FB3R	60 x 36 x 30	258	42.5	\$1745	\$1944	\$570	\$431

Standard with **freestanding** faux pedestal on **left** and box/box/file pedestal on **right**. File drawer and lower box drawer locking. Bow top overhangs 2.25" at ends and 8.125" on center. Shipped assembled in 1 carton.

- 84" wide desks are shipped easy to assemble in 2 cartons.

Z4284F2L	84 x 42 x 30	327	21.75	\$1964	\$2219	\$873	\$919
Z4272F2L	72 x 42 x 30	327	59	\$1866	\$2088	\$721	\$690
Z3684F2L	84 x 36 x 30	291	59	\$1841	\$2064	\$873	\$690
Z3672F2L	72 x 36 x 30	266	50.75	\$1728	\$1922	\$721	\$516
Z3666F2L	66 x 36 x 30	254	46.75	\$1686	\$1861	\$645	\$516
Z3660F2L	60 x 36 x 30	244	42.5	\$1642	\$1808	\$570	\$431
Z3072F2L	72 x 29.7 x 30	266	44	\$1728	\$1922	\$721	\$516
Z3066F2L	66 x 29.7 x 30	266	40.25	\$1686	\$1861	\$645	\$516
Z3060F2L	60 x 29.7 x 30	227	36.25	\$1642	\$1808	\$570	\$431

Standard with **freestanding** file/file pedestal on **left** and faux pedestal on **right**. Pedestal locks. Shipped assembled in 1 carton.

- 84" wide desks are shipped easy to assemble in 2 cartons.

Z4284F2R	84 x 42 x 30	327	21.75	\$1964	\$2219	\$873	\$919
Z4272F2R	72 x 42 x 30	327	59	\$1866	\$2088	\$721	\$690
Z3684F2R	84 x 36 x 30	291	59	\$1841	\$2064	\$873	\$690
Z3672F2R	72 x 36 x 30	266	50.75	\$1728	\$1922	\$721	\$516
Z3666F2R	66 x 36 x 30	254	46.75	\$1686	\$1861	\$645	\$516
Z3660F2R	60 x 36 x 30	244	42.5	\$1642	\$1808	\$570	\$431
Z3072F2R	72 x 29.7 x 30	266	44	\$1728	\$1922	\$721	\$516
Z3066F2R	66 x 29.7 x 30	240	40.25	\$1686	\$1861	\$645	\$516
Z3060F2R	60 x 29.7 x 30	227	36.25	\$1642	\$1808	\$570	\$431

Standard with **freestanding** faux pedestal on **left** and file/file pedestal on **right**. Pedestal locks. Shipped assembled in 1 carton.

- 84" wide desks are shipped easy to assemble in 2 cartons.

Required specifications

Top finish  
Top thickness/edge detail  
Base finish  
Lock finish

Optional specifications

HP laminate  
Key #  
Modesty type  
Grommet position or power block cut-out

Accessories

Pencil drawer  
Power block

**SINGLE PEDESTAL DESKS**

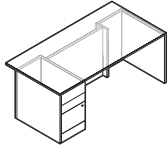

**Single Pedestal Desk - LEFT\***

MODEL #	DIMENSIONS	WT/LB.	CUBIC FT.	1" TOP	1.5" TOP	GLAZE ADD	HP ADD
W x D x H (1.5" TOP)							
Z4284F3L	84 x 42 x 30	324	21.75	<b>\$1995</b>	<b>\$2250</b>	<b>\$873</b>	<b>\$919</b>
Z4272F3L	72 x 42 x 30	324	59	<b>\$1901</b>	<b>\$2123</b>	<b>\$721</b>	<b>\$690</b>
Z3684F3L	84 x 36 x 30	289	59	<b>\$1841</b>	<b>\$2064</b>	<b>\$873</b>	<b>\$690</b>
Z3672F3L	72 x 36 x 30	264	50.75	<b>\$1764</b>	<b>\$1958</b>	<b>\$721</b>	<b>\$516</b>
Z3666F3L	66 x 36 x 30	252	46.75	<b>\$1718</b>	<b>\$1893</b>	<b>\$645</b>	<b>\$516</b>
Z3660F3L	60 x 36 x 30	242	42.5	<b>\$1653</b>	<b>\$1816</b>	<b>\$570</b>	<b>\$431</b>
Z3072F3L	72 x 29.7 x 30	251	44	<b>\$1764</b>	<b>\$1958</b>	<b>\$721</b>	<b>\$516</b>
Z3066F3L	66 x 29.7 x 30	239	40.25	<b>\$1718</b>	<b>\$1893</b>	<b>\$645</b>	<b>\$516</b>
Z3060F3L	60 x 29.7 x 30	226	36.25	<b>\$1653</b>	<b>\$1816</b>	<b>\$570</b>	<b>\$431</b>

Standard with **freestanding** box/box/file pedestal on **left** and faux pedestal on **right**. File drawer and lower box drawer locking. Shipped assembled in 1 carton.

- 84" wide desks are shipped easy to assemble in 2 cartons.

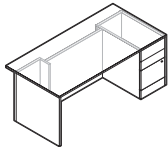

**Single Pedestal Desk - RIGHT\***

Z4284F3R	84 x 42 x 30	324	21.75	<b>\$1995</b>	<b>\$2250</b>	<b>\$873</b>	<b>\$919</b>
Z4272F3R	72 x 42 x 30	324	59	<b>\$1901</b>	<b>\$2123</b>	<b>\$721</b>	<b>\$690</b>
Z3684F3R	84 x 36 x 30	289	59	<b>\$1841</b>	<b>\$2064</b>	<b>\$873</b>	<b>\$690</b>
Z3672F3R	72 x 36 x 30	264	50.75	<b>\$1764</b>	<b>\$1958</b>	<b>\$721</b>	<b>\$516</b>
Z3666F3R	66 x 36 x 30	252	46.75	<b>\$1718</b>	<b>\$1893</b>	<b>\$645</b>	<b>\$516</b>
Z3660F3R	60 x 36 x 30	242	42.5	<b>\$1653</b>	<b>\$1816</b>	<b>\$570</b>	<b>\$431</b>
Z3072F3R	72 x 29.7 x 30	251	44	<b>\$1764</b>	<b>\$1968</b>	<b>\$721</b>	<b>\$543</b>
Z3066F3R	66 x 29.7 x 30	239	40.25	<b>\$1718</b>	<b>\$1893</b>	<b>\$645</b>	<b>\$516</b>
Z3060F3R	60 x 29.7 x 30	226	36.25	<b>\$1653</b>	<b>\$1816</b>	<b>\$570</b>	<b>\$431</b>

Standard with **freestanding** faux pedestal on **left** and box/box/file pedestal on **right**. File drawer and lower box drawer locking. Shipped assembled in 1 carton.

- 84" wide desks are shipped easy to assemble in 2 cartons.

**NON-HANDED DESKS**

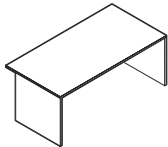

**Non-Handed Desk**

W x D x H (1.5" TOP)							
Z4284NHD	84 x 42 x 30	207	9.53	<b>\$1899</b>	<b>\$2271</b>	N/A	<b>\$955</b>
Z3684NHD	84 x 36 x 30	182	8.37	<b>\$1721</b>	<b>\$2032</b>	N/A	<b>\$828</b>
Z3672NHD	72 x 36 x 30	162	7.25	<b>\$1555</b>	<b>\$1821</b>	N/A	<b>\$711</b>
Z3666NHD	66 x 36 x 30	153	6.7	<b>\$1466</b>	<b>\$1716</b>	N/A	<b>\$651</b>
Z3660NHD	60 x 36 x 30	143	6.14	<b>\$1382</b>	<b>\$1616</b>	N/A	<b>\$591</b>
Z3072NHD	72 x 30 x 30	141	6.19	<b>\$1416</b>	<b>\$1638</b>	N/A	<b>\$592</b>
Z3066NHD	66 x 30 x 30	133	5.71	<b>\$1310</b>	<b>\$1527</b>	N/A	<b>\$545</b>
Z3060NHD	60 x 30 x 30	124	5.24	<b>\$1238</b>	<b>\$1421</b>	N/A	<b>\$494</b>

Two laminate end panels with full modesty panel (lamine only). Recessed modesty. Accepts all standard Zira storage shells. Shipped assembled in 1 carton.

**Required specifications**

Top finish  
Top thickness/edge detail  
Base finish  
Lock finish\*

**Optional specifications**

HP laminate      Handles  
Key #              Modesty type\*  
Modesty finish glazed (not returns)  
Grommet position or power block cut-out

**Accessories**

Pencil drawer  
Power block

**FREESTANDING DESKS**

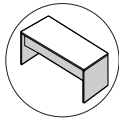
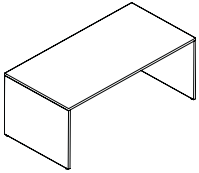

Front view

**Freestanding Desk**

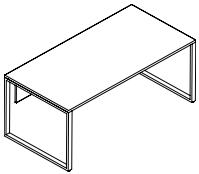

**Freestanding Desk - Metal Legs\***

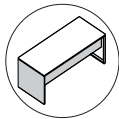
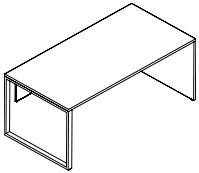

Front view

**Freestanding Desk - Metal Legs\***

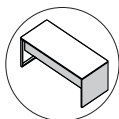
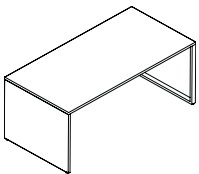

Front view

**Freestanding Desk - Metal Legs\***

MODEL #	DIMENSIONS	WT/LB.	CUBIC FT.	1" TOP	1.5" TOP	GLAZE ADD	HP ADD
<b>W x D x H (1.5" TOP)</b>							
Z3684DK	84 x 36 x 30	168	8.25	<b>\$1395</b>	<b>\$1684</b>	<b>\$1113</b>	<b>\$828</b>
Z3672DK	72 x 36 x 30	152	7.25	<b>\$1279</b>	<b>\$1532</b>	<b>\$992</b>	<b>\$711</b>
Z3666DK	66 x 36 x 30	144	6.75	<b>\$1222</b>	<b>\$1454</b>	<b>\$908</b>	<b>\$651</b>
Z3660DK	60 x 36 x 30	137	6	<b>\$1166</b>	<b>\$1376</b>	<b>\$847</b>	<b>\$592</b>
Z3072DK	72 x 30 x 30	130	6.25	<b>\$1139</b>	<b>\$1351</b>	<b>\$992</b>	<b>\$592</b>
Z3066DK	66 x 30 x 30	123	5.75	<b>\$1082</b>	<b>\$1292</b>	<b>\$908</b>	<b>\$545</b>
Z3060DK	60 x 30 x 30	117	5.25	<b>\$1029</b>	<b>\$1239</b>	<b>\$847</b>	<b>\$494</b>

Two full laminate end panels. 12"H laminate modesty panel. Shipped easy to assemble in 1 carton.

Z3684DM	84 x 36 x 30	167	18.5	<b>\$2987</b>	<b>\$3283</b>	<b>\$850</b>	<b>\$828</b>
Z3672DM	72 x 36 x 30	151	17.5	<b>\$2875</b>	<b>\$3129</b>	<b>\$733</b>	<b>\$711</b>
Z3666DM	66 x 36 x 30	143	17	<b>\$2820</b>	<b>\$3052</b>	<b>\$645</b>	<b>\$651</b>
Z3660DM	60 x 36 x 30	135	16.5	<b>\$2763</b>	<b>\$2973</b>	<b>\$585</b>	<b>\$592</b>
Z3072DM	72 x 30 x 30	133	14.75	<b>\$2737</b>	<b>\$2949</b>	<b>\$733</b>	<b>\$592</b>
Z3066DM	66 x 30 x 30	126	14.25	<b>\$2680</b>	<b>\$2892</b>	<b>\$645</b>	<b>\$545</b>
Z3060DM	60 x 30 x 30	120	14	<b>\$2625</b>	<b>\$2837</b>	<b>\$585</b>	<b>\$494</b>

Double metal legs. 12"H laminate modesty panel. Shipped easy to assemble in 3 cartons.

Z3684DML	84 x 36 x 30	167	13.5	<b>\$2195</b>	<b>\$2483</b>	<b>\$977</b>	<b>\$828</b>
Z3672DML	72 x 36 x 30	151	12.25	<b>\$2083</b>	<b>\$2329</b>	<b>\$858</b>	<b>\$711</b>
Z3666DML	66 x 36 x 30	144	11.75	<b>\$2027</b>	<b>\$2259</b>	<b>\$772</b>	<b>\$651</b>
Z3660DML	60 x 36 x 30	135	11.25	<b>\$1973</b>	<b>\$2183</b>	<b>\$712</b>	<b>\$592</b>
Z3072DML	72 x 30 x 30	131	10.5	<b>\$1944</b>	<b>\$2154</b>	<b>\$858</b>	<b>\$592</b>
Z3066DML	66 x 30 x 30	125	10	<b>\$1890</b>	<b>\$2100</b>	<b>\$772</b>	<b>\$545</b>
Z3060DML	60 x 30 x 30	118	9.5	<b>\$1834</b>	<b>\$2044</b>	<b>\$712</b>	<b>\$494</b>

Single metal leg on **left** and laminate end panel on **right**. 12"H laminate modesty panel. Shipped easy to assemble in 2 cartons.

Z3684DMR	84 x 36 x 30	167	13.5	<b>\$2195</b>	<b>\$2483</b>	<b>\$977</b>	<b>\$828</b>
Z3672DMR	72 x 36 x 30	151	12.25	<b>\$2083</b>	<b>\$2329</b>	<b>\$858</b>	<b>\$711</b>
Z3666DMR	66 x 36 x 30	144	11.75	<b>\$2027</b>	<b>\$2259</b>	<b>\$772</b>	<b>\$651</b>
Z3660DMR	60 x 36 x 30	135	11.25	<b>\$1973</b>	<b>\$2183</b>	<b>\$712</b>	<b>\$592</b>
Z3072DMR	72 x 30 x 30	131	10.5	<b>\$1944</b>	<b>\$2154</b>	<b>\$858</b>	<b>\$592</b>
Z3066DMR	66 x 30 x 30	125	10	<b>\$1890</b>	<b>\$2100</b>	<b>\$772</b>	<b>\$545</b>
Z3060DMR	60 x 30 x 30	118	9.5	<b>\$1834</b>	<b>\$2044</b>	<b>\$712</b>	<b>\$494</b>

Single metal leg on **right** and laminate end panel on **left**. 12"H laminate modesty panel. Shipped easy to assemble in 2 cartons.

**Required specifications**

Top finish  
Top/edge detail  
Base finish  
Leg finish\*

**Optional specifications**

HP laminate  
Modesty finish glazed  
Modesty type  
Grommet position or power block cut-out

**Accessories**

Pencil drawer  
Keyboard  
Power block



**TRANSITIONAL TABLES**      **MODEL #**      **DIMENSIONS**      **WT/LB.**      **CUBIC FT.**      **1" TOP**      **1.5" TOP**      **GLAZE ADD**      **HP ADD**

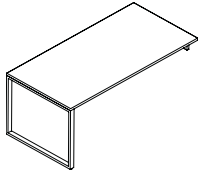

**Overlapping Table - LEFT**

	<b>W x D x H (1.5" TOP)</b>							
Z3684OML	84 x 36 x 30		132	13.5	<b>\$2008</b>	<b>\$2296</b>	N/A	<b>\$828</b>
Z3672OML	72 x 36 x 30		120	12.25	<b>\$1917</b>	<b>\$2205</b>	N/A	<b>\$711</b>
Z3666OML	66 x 36 x 30		112	11.75	<b>\$1876</b>	<b>\$2165</b>	N/A	<b>\$651</b>
Z3660OML	60 x 36 x 30		105	11.25	<b>\$1839</b>	<b>\$2122</b>	N/A	<b>\$592</b>
Z3072OML	72 x 30 x 30		104	10.5	<b>\$1813</b>	<b>\$2088</b>	N/A	<b>\$592</b>
Z3066OML	66 x 30 x 30		97	10	<b>\$1771</b>	<b>\$2053</b>	N/A	<b>\$545</b>
Z3060OML	60 x 30 x 30		90	9.5	<b>\$1736</b>	<b>\$2018</b>	N/A	<b>\$494</b>

Metal open frame leg with support channels on **left**. To be placed on top of 23.75"/24.25" high units. Not freestanding. Shipped easy to assemble in 2 cartons.

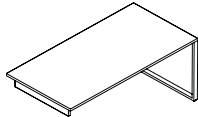

**Overlapping Table - RIGHT**

Z3684OMR	84 x 36 x 30		132	13.5	<b>\$2008</b>	<b>\$2296</b>	N/A	<b>\$828</b>
Z3672OMR	72 x 36 x 30		120	12.25	<b>\$1917</b>	<b>\$2205</b>	N/A	<b>\$711</b>
Z3666OMR	66 x 36 x 30		112	11.75	<b>\$1876</b>	<b>\$2165</b>	N/A	<b>\$651</b>
Z3660OMR	60 x 36 x 30		105	11.25	<b>\$1839</b>	<b>\$2122</b>	N/A	<b>\$592</b>
Z3072OMR	72 x 30 x 30		104	10.5	<b>\$1813</b>	<b>\$2088</b>	N/A	<b>\$592</b>
Z3066OMR	66 x 30 x 30		97	10	<b>\$1771</b>	<b>\$2053</b>	N/A	<b>\$545</b>
Z3060OMR	60 x 30 x 30		90	9.5	<b>\$1736</b>	<b>\$2018</b>	N/A	<b>\$494</b>

Metal open frame leg with support channels on **right**. To be placed on top of 23.75"/24.25" high units. Not freestanding. Shipped easy to assemble in 2 cartons.

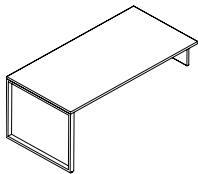

**Overlapping Table - LEFT**

Z3684SOL	84 x 36 x 30		139	13.5	<b>\$2027</b>	<b>\$2315</b>	N/A	<b>\$828</b>
Z3672SOL	72 x 36 x 30		126	12.25	<b>\$1938</b>	<b>\$2226</b>	N/A	<b>\$711</b>
Z3666SOL	66 x 36 x 30		118	11.75	<b>\$1895</b>	<b>\$2184</b>	N/A	<b>\$651</b>
Z3660SOL	60 x 36 x 30		110	11.25	<b>\$1861</b>	<b>\$2143</b>	N/A	<b>\$592</b>
Z3072SOL	72 x 30 x 30		108	10.5	<b>\$1834</b>	<b>\$2109</b>	N/A	<b>\$592</b>
Z3066SOL	66 x 30 x 30		100	10	<b>\$1792</b>	<b>\$2074</b>	N/A	<b>\$545</b>
Z3060SOL	60 x 30 x 30		96	9.5	<b>\$1757</b>	<b>\$2039</b>	N/A	<b>\$494</b>

Metal open frame leg with support channels on **left**. To be placed on top of 17.87"/18.37" high units. Not freestanding. Shipped easy to assemble in 2 cartons.

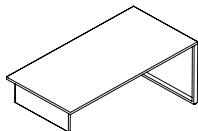

**Overlapping Table - RIGHT**

Z3684SOR	84 x 36 x 30		139	13.5	<b>\$2027</b>	<b>\$2315</b>	N/A	<b>\$828</b>
Z3672SOR	72 x 36 x 30		126	12.25	<b>\$1938</b>	<b>\$2226</b>	N/A	<b>\$711</b>
Z3666SOR	66 x 36 x 30		118	11.75	<b>\$1895</b>	<b>\$2184</b>	N/A	<b>\$651</b>
Z3660SOR	60 x 36 x 30		110	11.25	<b>\$1861</b>	<b>\$2143</b>	N/A	<b>\$592</b>
Z3072SOR	72 x 30 x 30		108	10.5	<b>\$1834</b>	<b>\$2109</b>	N/A	<b>\$592</b>
Z3066SOR	66 x 30 x 30		100	10	<b>\$1792</b>	<b>\$2074</b>	N/A	<b>\$545</b>
Z3060SOR	60 x 30 x 30		96	9.5	<b>\$1757</b>	<b>\$2039</b>	N/A	<b>\$494</b>

Metal open frame leg with support channels on **right**. To be placed on top of 17.87"/18.37" high units. Not freestanding. Shipped easy to assemble in 2 cartons.

**Required specifications**

- Top finish
- Top/edge detail
- Base finish
- Leg finish

**Optional specifications**

- HP laminate
- Grommet position or power block cut-out

**Accessories**

- Pencil drawer
- Keyboard
- Power block

**FLUSH RETURNS**

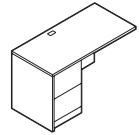

**Flush Return - LEFT**

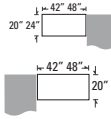

MODEL #	DIMENSIONS	WT/LB.	CUBIC FT.	1" TOP	1.5" TOP	GLAZE ADD	HP ADD
W x D x H (1.5" TOP)							
Z2448L4	48 x 24 x 30	179	24.25	<b>\$1365</b>	<b>\$1474</b>	N/A	<b>\$263</b>
Z2442L4	42 x 24 x 30	167	21.5	<b>\$1365</b>	<b>\$1464</b>	N/A	<b>\$222</b>
Z2048L4	48 x 20 x 30	162	20.5	<b>\$1285</b>	<b>\$1382</b>	N/A	<b>\$222</b>
Z2042L4	42 x 20 x 30	151	18	<b>\$1285</b>	<b>\$1382</b>	N/A	<b>\$222</b>

Standard with **file/file** drawer pedestal on the **left**. Pedestal locks. Grommet in worksurface. For use with right handed single pedestal desks, 20"/24" deep extended corners with narrow end panel or 20"/24" deep five-sided corners with narrow end panel. Shipped assembled in 1 carton.

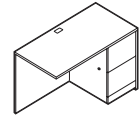

**Flush Return - RIGHT**

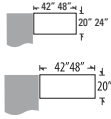

Z2448R4	48 x 24 x 30	179	24.25	<b>\$1365</b>	<b>\$1474</b>	N/A	<b>\$263</b>
Z2442R4	42 x 24 x 30	167	21.5	<b>\$1365</b>	<b>\$1464</b>	N/A	<b>\$222</b>
Z2048R4	48 x 20 x 30	162	20.5	<b>\$1285</b>	<b>\$1382</b>	N/A	<b>\$222</b>
Z2042R4	42 x 20 x 30	151	18	<b>\$1285</b>	<b>\$1382</b>	N/A	<b>\$222</b>

Standard with **file/file** drawer pedestal on the **right**. Pedestal locks. Grommet in worksurface. For use with left handed single pedestal desks, 20"/24" deep extended corners with narrow end panel or 20"/24" deep five-sided corners with narrow end panel. Shipped assembled in 1 carton.

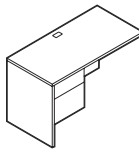

**Flush Return - LEFT\***

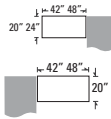

Z2448FL	48 x 24 x 30	163	24	<b>\$1082</b>	<b>\$1191</b>	N/A	<b>\$263</b>
Z2442FL	42 x 24 x 30	151	21.25	<b>\$1082</b>	<b>\$1191</b>	N/A	<b>\$222</b>
Z2048FL	48 x 20 x 30	147	20.25	<b>\$1022</b>	<b>\$1119</b>	N/A	<b>\$222</b>
Z2042FL	42 x 20 x 30	136	18	<b>\$1022</b>	<b>\$1119</b>	N/A	<b>\$222</b>

Standard with **box/file** drawer pedestal on the **left**. One pencil tray. Pedestal locks. Grommet in worksurface. For use with right handed single pedestal desks, 20"/24" deep extended corners with narrow end panel or 20"/24" deep five-sided corners with narrow end panel. Shipped assembled in 1 carton.

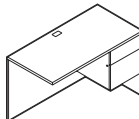

**Flush Return - RIGHT\***

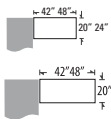

Z2448FR	48 x 24 x 30	163	24	<b>\$1082</b>	<b>\$1191</b>	N/A	<b>\$263</b>
Z2442FR	42 x 24 x 30	151	21.25	<b>\$1082</b>	<b>\$1191</b>	N/A	<b>\$222</b>
Z2048FR	48 x 20 x 30	147	20.25	<b>\$1022</b>	<b>\$1119</b>	N/A	<b>\$222</b>
Z2042FR	42 x 20 x 30	136	18	<b>\$1022</b>	<b>\$1119</b>	N/A	<b>\$222</b>

Standard with **box/file** drawer pedestal on the **right**. One pencil tray. Pedestal locks. Grommet in worksurface. For use with left handed single pedestal desks, 20"/24" deep extended corners with narrow end panel or 20"/24" deep five-sided corners with narrow end panel. Shipped assembled in 1 carton.

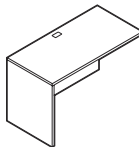

**Flush Return - LEFT**

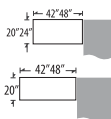

Z2448EL	48 x 24 x 30	117	4.3	<b>\$759</b>	<b>\$870</b>	N/A	<b>\$263</b>
Z2442EL	42 x 24 x 30	104	3.8	<b>\$759</b>	<b>\$870</b>	N/A	<b>\$222</b>
Z2048EL	48 x 20 x 30	106	4.3	<b>\$701</b>	<b>\$798</b>	N/A	<b>\$222</b>
Z2042EL	42 x 20 x 30	94	3.8	<b>\$701</b>	<b>\$798</b>	N/A	<b>\$222</b>

Return has **no pedestal**. Grommet in worksurface. For use with right handed single pedestal desks, 20"/24" deep extended corners with narrow end panel or 20"/24" deep five-sided corners with narrow end panel. Shipped assembled in 1 carton.

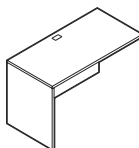

**Flush Return - LEFT**

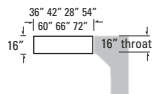

Z1672RL	72 x 15.8 x 30	109	6	<b>\$674</b>	<b>\$788</b>	N/A	<b>\$257</b>
Z1666RL	66 x 15.8 x 30	102	5.75	<b>\$646</b>	<b>\$754</b>	N/A	<b>\$257</b>
Z1660RL	60 x 15.8 x 30	95	5.25	<b>\$606</b>	<b>\$705</b>	N/A	<b>\$215</b>
Z1654RL	54 x 15.8 x 30	87	5.25	<b>\$573</b>	<b>\$663</b>	N/A	<b>\$215</b>
Z1648RL	48 x 15.8 x 30	80	4.25	<b>\$529</b>	<b>\$613</b>	N/A	<b>\$171</b>
Z1642RL	42 x 15.8 x 30	70	4	<b>\$474</b>	<b>\$549</b>	N/A	<b>\$171</b>
Z1636RL	36 x 15.8 x 30	62	3.5	<b>\$422</b>	<b>\$486</b>	N/A	<b>\$128</b>

**16" throat**. Return has **no pedestal**. Grommet in worksurface. For use with extended corners, desks and islands with 16" throat. Shipped easy to assemble in 1 carton.

**Required specifications**

Top finish  
Top thickness/edge detail  
Base finish  
Lock finish\*

**Optional specifications**

HP laminate  
Key #\*  
Modesty type  
Grommet position or power block cut-out

**Accessories**

Pencil drawer  
Power block

**FLUSH RETURNS**      **MODEL #**      **DIMENSIONS**      **WT/LB.**      **CUBIC FT.**      **1" TOP**      **1.5" TOP**      **GLAZE ADD**      **HP ADD**



**Flush Return - RIGHT**

**W x D x H (1.5" TOP)**

Z2448ER	48 x 24 x 30	117	4.3	<b>\$759</b>	<b>\$870</b>	N/A	<b>\$263</b>
Z2442ER	42 x 24 x 30	104	3.8	<b>\$759</b>	<b>\$870</b>	N/A	<b>\$222</b>
Z2048ER	48 x 20 x 30	106	4.3	<b>\$701</b>	<b>\$798</b>	N/A	<b>\$222</b>
Z2042ER	42 x 20 x 30	94	3.8	<b>\$701</b>	<b>\$798</b>	N/A	<b>\$222</b>

Return has **no pedestal**. Grommet in worksurface. For use with left handed single pedestal desks, 20"/24" deep extended corners with narrow end panel or 20"/24" deep five-sided corners with narrow end panel. Shipped easy to assemble in 1 carton.

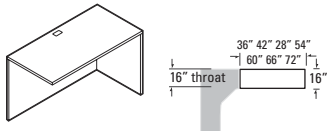

**Flush Return - RIGHT**

Z1672RR	72 x 15.8 x 30	109	6	<b>\$674</b>	<b>\$788</b>	N/A	<b>\$257</b>
Z1666RR	66 x 15.8 x 30	102	5.75	<b>\$646</b>	<b>\$754</b>	N/A	<b>\$257</b>
Z1660RR	60 x 15.8 x 30	95	5.25	<b>\$606</b>	<b>\$705</b>	N/A	<b>\$215</b>
Z1654RR	54 x 15.8 x 30	87	5.25	<b>\$573</b>	<b>\$663</b>	N/A	<b>\$215</b>
Z1648RR	48 x 15.8 x 30	80	4.25	<b>\$529</b>	<b>\$613</b>	N/A	<b>\$171</b>
Z1642RR	42 x 15.8 x 30	70	4	<b>\$474</b>	<b>\$549</b>	N/A	<b>\$171</b>
Z1636RR	36 x 15.8 x 30	62	3.5	<b>\$422</b>	<b>\$486</b>	N/A	<b>\$128</b>

*16" throat.* Return has **no pedestal**. Grommet in worksurface. For use with extended corners, desks and islands with 16" throat. Shipped easy to assemble in 1 carton.

**NON-HANDED RETURNS**

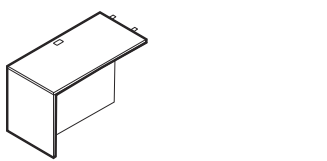

**Non-Handed Return**

**W x D x H (1.5" TOP)**

Z2448NHR	48 x 24 x 30	83.6	4.78	<b>\$888</b>	<b>\$1022</b>	N/A	<b>\$311</b>
Z2442NHR	42 x 24 x 30	75.4	3.83	<b>\$772</b>	<b>\$910</b>	N/A	<b>\$278</b>
Z2048NHR	48 x 20 x 30	75.56	4.3	<b>\$805</b>	<b>\$933</b>	N/A	<b>\$261</b>
Z2042NHR	42 x 20 x 30	67.96	3.83	<b>\$738</b>	<b>\$833</b>	N/A	<b>\$233</b>

Non-handed (reversible) return. 24"D returns accept all standard 23.4" storage shells. 20"D returns accept all standard 19.3" storage shells. Full modesty panel (laminated only). Shipped ready to assemble in 1 carton.

**SPACE SAVER RETURNS**

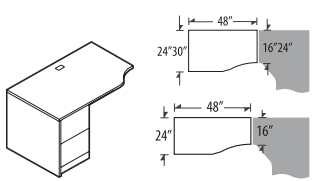

**Space Saver Return - LEFT\***

**W x D x H (1.5" TOP)**

Z3048P4L	48 x 29.69 x 30	222	29	<b>\$1503</b>	<b>\$1639</b>	N/A	<b>\$380</b>
Z2448P4L	48 x 24 x 30	170	24.25	<b>\$1205</b>	<b>\$1318</b>	N/A	<b>\$230</b>

Standard with **file/file** drawer pedestal on the **left**. Grommet in worksurface. Pedestal locks. Connects to 24" or 16" component. Shipped assembled in 1 carton.

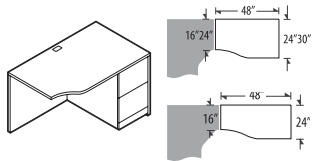

**Space Saver Return - RIGHT\***

Z3048P4R	48 x 29.69 x 30	222	29	<b>\$1503</b>	<b>\$1639</b>	N/A	<b>\$380</b>
Z2448P4R	48 x 24 x 30	170	24.25	<b>\$1205</b>	<b>\$1318</b>	N/A	<b>\$230</b>

Standard with **file/file** drawer pedestal on the **right**. Grommet in worksurface. Pedestal locks. Connects to 24" or 16" component. Shipped assembled in 1 carton.

<b>Required specifications</b>	<b>Optional specifications</b>	<b>Accessories</b>
Top finish	HP laminate	Pencil drawer (only Z2xxx6RL)
Top thickness/edge detail	Handles*	Power block
Base finish	Key #*	
Lock finish*	Modesty type (not ZxxxxP4R/ ZxxxxP4L)	
	Grommet position or power block cut-out	

SPACE SAVER RETURNS

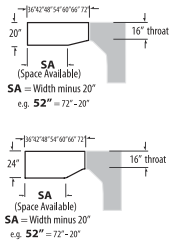
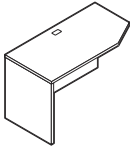

Space Saver Return - LEFT

MODEL #	DIMENSIONS	WT/LB.	CUBIC FT.	1" TOP	1.5" TOP	GLAZE ADD	HP ADD
W x D x H (1.5" TOP)							
Z247216RL	72 x 24 x 30	135	6	\$802	\$973	N/A	\$344
Z246616RL	66 x 24 x 30	127	5.75	\$763	\$923	N/A	\$344
Z246016RL	60 x 24 x 30	118	5.25	\$716	\$862	N/A	\$286
Z245416RL	54 x 24 x 30	108	5.25	\$675	\$807	N/A	\$286
Z244816RL	48 x 24 x 30	100	4.25	\$619	\$739	N/A	\$230
Z244216RL	42 x 24 x 30	88	4	\$557	\$665	N/A	\$230
Z243616RL	36 x 24 x 30	78	3.5	\$503	\$595	N/A	\$171
Z207216RL	72 x 20 x 30	123	6	\$732	\$876	N/A	\$344
Z206616RL	66 x 20 x 30	114	5.75	\$700	\$831	N/A	\$344
Z206016RL	60 x 20 x 30	106	5.25	\$655	\$776	N/A	\$286
Z205416RL	54 x 20 x 30	98	5.25	\$616	\$727	N/A	\$286
Z204816RL	48 x 20 x 30	90	4.25	\$565	\$668	N/A	\$230
Z204216RL	42 x 20 x 30	80	4	\$507	\$596	N/A	\$230
Z203616RL	36 x 20 x 30	70	3.5	\$457	\$535	N/A	\$171

16" throat. Return has **no pedestal**. Grommet in worksurface. For use with extended corners, desks and islands with 16" throat. Accepts same depth storage shells under worksurface, see pages 169-175. Shipped easy to assemble in 1 carton.

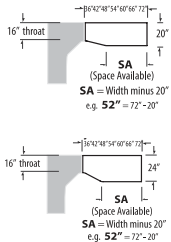
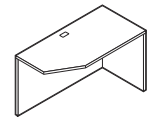

Space Saver Return - RIGHT

Z247216RR	72 x 24 x 30	135	6	\$802	\$973	N/A	\$344
Z246616RR	66 x 24 x 30	127	5.75	\$763	\$923	N/A	\$344
Z246016RR	60 x 24 x 30	118	5.25	\$716	\$862	N/A	\$286
Z245416RR	54 x 24 x 30	108	5.25	\$675	\$807	N/A	\$286
Z244816RR	48 x 24 x 30	100	4.25	\$619	\$739	N/A	\$230
Z244216RR	42 x 24 x 30	88	4	\$557	\$665	N/A	\$230
Z243616RR	36 x 24 x 30	78	3.5	\$503	\$595	N/A	\$171
Z207216RR	72 x 20 x 30	123	6	\$732	\$876	N/A	\$344
Z206616RR	66 x 20 x 30	114	5.75	\$700	\$831	N/A	\$344
Z206016RR	60 x 20 x 30	106	5.25	\$655	\$776	N/A	\$286
Z205416RR	54 x 20 x 30	98	5.25	\$616	\$727	N/A	\$286
Z204816RR	48 x 20 x 30	90	4.25	\$565	\$668	N/A	\$230
Z204216RR	42 x 20 x 30	80	4	\$507	\$596	N/A	\$230
Z203616RR	36 x 20 x 30	70	3.5	\$457	\$535	N/A	\$171

16" throat. Return has **no pedestal**. Grommet in worksurface. For use with extended corners, desks and islands with 16" throat. Accepts same depth storage shells under worksurface, see pages 169-175. Shipped easy to assemble in 1 carton.

Required specifications

Top finish  
Top thickness/edge detail  
Base finish

Optional specifications

Additional grommets  
HP laminate

Accessories

Power block

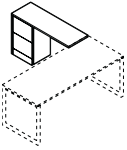
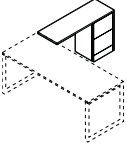
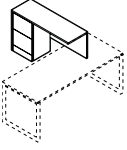
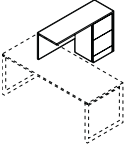
FULL TO FLOOR RETURNS	MODEL #	DIMENSIONS	WT/LB.	CUBIC FT.	1" TOP	1.5" TOP	GLAZE ADD	HP ADD
		W x D x H (1.5" TOP)						
	Z2448NRL	48 x 24 x 30	127	24.25	<b>\$1318</b>	<b>\$1437</b>	N/A	<b>\$316</b>
	Z2442NRL	42 x 24 x 30	123	21.25	<b>\$1305</b>	<b>\$1410</b>	N/A	<b>\$276</b>
	Z2048NRL	48 x 20 x 30	114	20.5	<b>\$1241</b>	<b>\$1340</b>	N/A	<b>\$263</b>
	Z2042NRL	42 x 20 x 30	111	18	<b>\$1211</b>	<b>\$1299</b>	N/A	<b>\$231</b>
<b>Full to Floor Return, No Modesty - LEFT</b>	Full to the floor, locking file/file pedestal and no modesty. File/file pedestal on <b>left</b> . Shipped easy to assemble in 1 carton.							
	Z2448NRR	48 x 24 x 30	127	24.25	<b>\$1318</b>	<b>\$1437</b>	N/A	<b>\$316</b>
	Z2442NRR	42 x 24 x 30	123	21.25	<b>\$1305</b>	<b>\$1410</b>	N/A	<b>\$276</b>
	Z2048NRR	48 x 20 x 30	114	20.5	<b>\$1241</b>	<b>\$1340</b>	N/A	<b>\$263</b>
	Z2042NRR	42 x 20 x 30	111	18	<b>\$1211</b>	<b>\$1299</b>	N/A	<b>\$231</b>
<b>Full to Floor Return, No Modesty - RIGHT</b>	Full to the floor, locking file/file pedestal and no modesty. File/file pedestal on <b>right</b> . Shipped easy to assemble in 1 carton.							
	Z2448SRL	48 x 24 x 30	135	24.25	<b>\$1434</b>	<b>\$1551</b>	N/A	<b>\$316</b>
	Z2442SRL	42 x 24 x 30	130	21.25	<b>\$1410</b>	<b>\$1515</b>	N/A	<b>\$276</b>
	Z2048SRL	48 x 20 x 30	123	20.5	<b>\$1357</b>	<b>\$1455</b>	N/A	<b>\$263</b>
	Z2042SRL	42 x 20 x 30	119	18	<b>\$1316</b>	<b>\$1404</b>	N/A	<b>\$231</b>
<b>Full to Floor Return - LEFT</b>	Full to the floor, locking file/file on <b>left</b> . 12"H modesty panel. Shipped easy to assemble in 1 carton.							
	Z2448SRR	48 x 24 x 30	135	24.25	<b>\$1434</b>	<b>\$1551</b>	N/A	<b>\$316</b>
	Z2442SRR	42 x 24 x 30	130	21.25	<b>\$1410</b>	<b>\$1515</b>	N/A	<b>\$276</b>
	Z2048SRR	48 x 20 x 30	123	20.5	<b>\$1357</b>	<b>\$1455</b>	N/A	<b>\$263</b>
	Z2042SRR	42 x 20 x 30	119	18	<b>\$1316</b>	<b>\$1404</b>	N/A	<b>\$231</b>
<b>Full to Floor Return - RIGHT</b>	Full to the floor, locking file/file on <b>right</b> . 12"H modesty panel. Shipped easy to assemble in 1 carton.							

**Required specifications**

- Top finish
- Top/edge detail
- Base finish
- Lock finish

**Optional specifications**

- HP laminate
- Key #\*
- Grommet position or power block cut-out
- Handles

**Accessories**

- Pencil drawer
- Keyboard
- Power block

**FULL TO FLOOR FLUSH RETURNS**

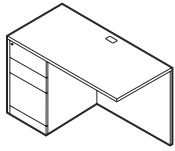

**Full to Floor Flush Return - LEFT\***

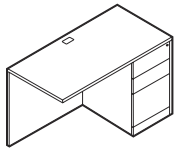

**Full to Floor Flush Return - RIGHT\***

MODEL #	DIMENSIONS	WT/LB.	CUBIC FT.	1" TOP	1.5" TOP	GLAZE ADD	HP ADD
W x D x H (1.5" TOP)							
Z24723L	72 x 24 x 30	215	35.75	<b>\$1653</b>	<b>\$1789</b>	N/A	<b>\$345</b>
Z24663L	66 x 24 x 30	202	32.75	<b>\$1626</b>	<b>\$1762</b>	N/A	<b>\$330</b>
Z24603L	60 x 24 x 30	188	30	<b>\$1531</b>	<b>\$1667</b>	N/A	<b>\$330</b>
Z24543L	54 x 24 x 30	179	29.75	<b>\$1478</b>	<b>\$1614</b>	N/A	<b>\$330</b>
Z24483L	48 x 24 x 30	167	24.25	<b>\$1396</b>	<b>\$1532</b>	N/A	<b>\$263</b>
Z20723L	72 x 20 x 30	183	30.25	<b>\$1520</b>	<b>\$1656</b>	N/A	<b>\$345</b>
Z20663L	66 x 20 x 30	173	27.75	<b>\$1472</b>	<b>\$1608</b>	N/A	<b>\$330</b>
Z20603L	60 x 20 x 30	162	25.25	<b>\$1443</b>	<b>\$1579</b>	N/A	<b>\$330</b>
Z20543L	54 x 20 x 30	154	23	<b>\$1393</b>	<b>\$1529</b>	N/A	<b>\$330</b>
Z20483L	48 x 20 x 30	144	20.5	<b>\$1360</b>	<b>\$1496</b>	N/A	<b>\$263</b>

Standard with box/box/file pedestal on **left**. Grommet in worksurface. One pencil tray. File drawer and lower box drawer locking. Shipped assembled in 1 carton.

Z24723R	72 x 24 x 30	215	35.75	<b>\$1653</b>	<b>\$1789</b>	N/A	<b>\$345</b>
Z24663R	66 x 24 x 30	202	32.75	<b>\$1626</b>	<b>\$1762</b>	N/A	<b>\$330</b>
Z24603R	60 x 24 x 30	188	30	<b>\$1531</b>	<b>\$1667</b>	N/A	<b>\$330</b>
Z24543R	54 x 24 x 30	179	29.75	<b>\$1478</b>	<b>\$1614</b>	N/A	<b>\$330</b>
Z24483R	48 x 24 x 30	167	24.25	<b>\$1396</b>	<b>\$1532</b>	N/A	<b>\$263</b>
Z20723R	72 x 20 x 30	183	30.25	<b>\$1520</b>	<b>\$1656</b>	N/A	<b>\$345</b>
Z20663R	66 x 20 x 30	173	27.75	<b>\$1472</b>	<b>\$1608</b>	N/A	<b>\$330</b>
Z20603R	60 x 20 x 30	162	25.25	<b>\$1443</b>	<b>\$1579</b>	N/A	<b>\$330</b>
Z20543R	54 x 20 x 30	154	23	<b>\$1393</b>	<b>\$1529</b>	N/A	<b>\$330</b>
Z20483R	48 x 20 x 30	144	20.5	<b>\$1360</b>	<b>\$1496</b>	N/A	<b>\$263</b>

Standard with box/box/file pedestal on **right**. Grommet in worksurface. One pencil tray. File drawer and lower box drawer locking. Shipped assembled in 1 carton.

**FLUSH BRIDGES**

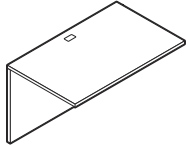

**Flush Bridge**

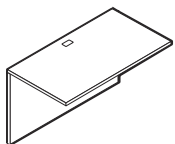
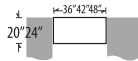

**Flush Bridge**

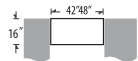

W x D x H (1.5" TOP)							
Z2448FB	48 x 24 x 30	100	4.3	<b>\$673</b>	<b>\$784</b>	N/A	<b>\$263</b>
Z2442FB	42 x 24 x 30	86	3.8	<b>\$673</b>	<b>\$772</b>	N/A	<b>\$222</b>
Z2436FB	36 x 24 x 30	69	3.3	<b>\$626</b>	<b>\$738</b>	N/A	<b>\$167</b>
Z2048FB	48 x 20 x 30	92	4.3	<b>\$515</b>	<b>\$607</b>	N/A	<b>\$222</b>
Z2042FB	42 x 20 x 30	80	3.8	<b>\$490</b>	<b>\$609</b>	N/A	<b>\$222</b>
Z2036FB	36 x 20 x 30	63	3.3	<b>\$464</b>	<b>\$563</b>	N/A	<b>\$167</b>

Top surface, back panel and hardware to create a "U" shape by connecting two units with full end panels. Grommet in worksurface. Shipped assembled in 1 carton.

Z1648B	48 x 15.8 x 30	66	4.25	<b>\$448</b>	<b>\$532</b>	N/A	<b>\$171</b>
Z1642B	42 x 15.8 x 30	60	3.75	<b>\$389</b>	<b>\$465</b>	N/A	<b>\$171</b>

*16" throat.* Top surface, back panel and hardware to create a "U" shape by connecting two units with a 16" throat and full end panels. Grommet in worksurface. Shipped easy to assemble in 1 carton.

**Required specifications**

Top finish  
Top thickness/edge detail  
Base finish

**Optional specifications**

HP laminate  
Grommet position or power block cut-out

**Accessories**

Pencil drawer  
Power block

**SPACE SAVER BRIDGES**

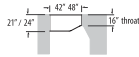
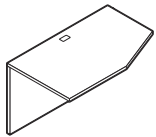

**Space Saver Bridge - LEFT**

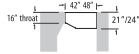
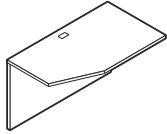

**Space Saver Bridge - RIGHT**

MODEL #	DIMENSIONS	WT/LB.	CUBIC FT.	1" TOP	1.5" TOP	GLAZE ADD	HP ADD
<b>W x D x H (1.5" TOP)</b>							
Z244816BL	48 x 24 x 30	82	4.25	<b>\$520</b>	<b>\$640</b>	N/A	<b>\$230</b>
Z244216BL	42 x 24 x 30	71	3.75	<b>\$458</b>	<b>\$566</b>	N/A	<b>\$230</b>
Z214816BL	48 x 21 x 30	76	4.25	<b>\$483</b>	<b>\$586</b>	N/A	<b>\$230</b>
Z214216BL	42 x 21 x 30	65	3.75	<b>\$419</b>	<b>\$508</b>	N/A	<b>\$230</b>

*16" throat.* Top surface, back panel and hardware to connect extended corners, desks and islands with a 16" throat. Grommet in worksurface. Shipped easy to assemble in 1 carton.

Z244816BR	48 x 24 x 30	82	4.25	<b>\$520</b>	<b>\$640</b>	N/A	<b>\$230</b>
Z244216BR	42 x 24 x 30	71	3.75	<b>\$458</b>	<b>\$566</b>	N/A	<b>\$230</b>
Z214816BR	48 x 21 x 30	76	4.25	<b>\$483</b>	<b>\$586</b>	N/A	<b>\$230</b>
Z214216BR	42 x 21 x 30	65	3.75	<b>\$419</b>	<b>\$508</b>	N/A	<b>\$230</b>

*16" throat.* Top surface, back panel and hardware to connect extended corners, desks and islands with a 16" throat. Grommet in worksurface. Shipped easy to assemble in 1 carton.

**TRANSITIONAL BRIDGES**

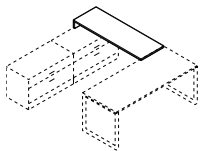

**Overlapping Bridge - LEFT\***

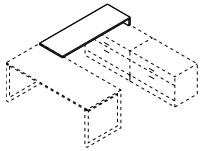

**Overlapping Bridge - RIGHT\***

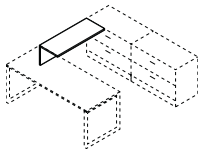

**Flush Bridge**

MODEL #	DIMENSIONS	WT/LB.	CUBIC FT.	1" TOP	1.5" TOP	GLAZE ADD	HP ADD
<b>W x D x H (1.5" TOP)</b>							
Z2468TRL	68 x 24 x 5.9	64	5.25	<b>\$662</b>	<b>\$835</b>	N/A	<b>\$448</b>
Z2462TRL	62 x 24 x 5.9	59	4.7	<b>\$617</b>	<b>\$774</b>	N/A	<b>\$408</b>
Z2472TRL	72 x 24 x 5.9	64	5.25	<b>\$674</b>	<b>\$848</b>	N/A	<b>\$473</b>
Z2466TRL	66 x 24 x 5.9	62	4.7	<b>\$634</b>	<b>\$791</b>	N/A	<b>\$436</b>

*For 20"/24"D, 23.75"/24.25"H storage with no modesty.* Overlaps storage on **right**. Shipped easy to assemble in 1 carton.

- Use Z2462TRR and Z2468TRR for 20"D storage.
- Use Z2466TRR and Z2472TRR for 24"D storage.

Z2468TRR	68 x 24 x 5.9	64	5.25	<b>\$662</b>	<b>\$835</b>	N/A	<b>\$448</b>
Z2462TRR	62 x 24 x 5.9	59	4.7	<b>\$617</b>	<b>\$774</b>	N/A	<b>\$408</b>
Z2472TRR	72 x 24 x 5.9	64	5.25	<b>\$674</b>	<b>\$848</b>	N/A	<b>\$473</b>
Z2466TRR	66 x 24 x 5.9	62	4.7	<b>\$634</b>	<b>\$791</b>	N/A	<b>\$436</b>

*For 20"/24"D, 23.75"/24.25"H storage with no modesty.* Overlaps storage on **left**. Shipped easy to assemble in 1 carton.

- Use Z2462TRR and Z2468TRR for 20"D storage.
- Use Z2466TRR and Z2472TRR for 24"D storage.

Z24483BR	48 x 24 x 13.5	55	3.5	<b>\$745</b>	<b>\$901</b>	N/A	<b>\$316</b>
Z24423BR	42 x 24 x 13.5	48	3.1	<b>\$684</b>	<b>\$825</b>	N/A	<b>\$276</b>
Z24363BR	36 x 24 x 13.5	43	2.7	<b>\$626</b>	<b>\$747</b>	N/A	<b>\$237</b>
Z20483BR	48 x 20 x 13.5	48	3	<b>\$691</b>	<b>\$825</b>	N/A	<b>\$263</b>
Z20423BR	42 x 20 x 13.5	43	2.7	<b>\$637</b>	<b>\$756</b>	N/A	<b>\$231</b>
Z20363BR	36 x 20 x 13.5	38	2.4	<b>\$583</b>	<b>\$686</b>	N/A	<b>\$198</b>

*For use with storage models ZxxxxBBOL/R and ZxxxxBLFL/R. 12"H modesty panel.* Shipped easy to assemble in 1 carton.

**Required specifications**

- Top finish
- Top/edge detail
- Base finish

**Optional specifications**

- HP laminate
- Grommet position or power block cut-out

**Accessories**

- Power block
- Pencil drawer\*

**TRANSITIONAL BRIDGES**      **MODEL #**      **DIMENSIONS**      **WT/LB.**      **CUBIC FT.**      **1" TOP**      **1.5" TOP**      **GLAZE ADD**      **HP ADD**

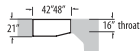
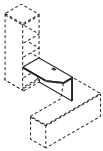

**Transitional Bridge - LEFT**

*For 21" wide storage module.* Top surface, back panel, shorter kickbase and hardware included to connect 21" wide storage module with 16" throat. Grommet in worksurface. Shipped easy to assemble in 1 carton.

W x D x H (1.5" TOP)								
Z2148TRBL	48 x 21 x 30	76	4.25	<b>\$506</b>	<b>\$609</b>	N/A	<b>\$230</b>	
Z2142TRBL	42 x 21 x 30	65	3.75	<b>\$438</b>	<b>\$527</b>	N/A	<b>\$230</b>	

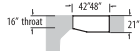
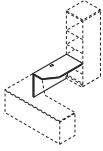

**Transitional Bridge - RIGHT**

*For 21" wide storage module.* Top surface, back panel, shorter kickbase and hardware included to connect 21" wide storage module with 16" throat. Grommet in worksurface. Shipped easy to assemble in 1 carton.

Z2148TRBR	48 x 21 x 30	76	4.25	<b>\$506</b>	<b>\$609</b>	N/A	<b>\$230</b>
Z2142TRBR	42 x 21 x 30	65	3.75	<b>\$438</b>	<b>\$527</b>	N/A	<b>\$230</b>

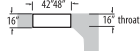
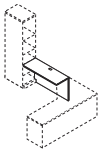

**Transitional Bridge - LEFT**

*For 16" wide storage module.* Top surface, back panel and hardware to connect 16" wide storage module with 16" throat. Grommet in worksurface. Shipped easy to assemble in 1 carton.

Z1648TRBL	48 x 16 x 30	69	4.25	<b>\$466</b>	<b>\$550</b>	N/A	<b>\$171</b>
Z1642TRBL	42 x 16 x 30	59	3.75	<b>\$409</b>	<b>\$485</b>	N/A	<b>\$171</b>

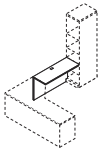

**Transitional Bridge - RIGHT**

*For 16" wide storage module.* Top surface, back panel and hardware to connect 16" wide storage module with 16" throat. Grommet in worksurface. Shipped easy to assemble in 1 carton.

Z1648TRBR	48 x 16 x 30	69	4.25	<b>\$466</b>	<b>\$550</b>	N/A	<b>\$171</b>
Z1642TRBR	42 x 16 x 30	59	3.75	<b>\$409</b>	<b>\$485</b>	N/A	<b>\$171</b>

**Required specifications**

- Top finish
- Top thickness/edge detail
- Base finish

**Optional specifications**

- HP laminate
- Grommet position or power block cut-out

**Accessories**

- Power block



18"H CREDENZAS	MODEL #	DIMENSIONS	WT/LB.	CUBIC FT.	1" TOP	1.5" TOP	GLAZE ADD	HP ADD
----------------	---------	------------	--------	-----------	--------	----------	-----------	--------

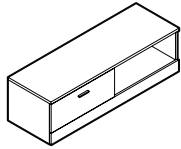

Lateral File Credenza - LEFT

	W x D x H (1.5" TOP)							
Z2472LOFL	72 x 24 x 18.37	181	22.75	<b>\$1834</b>	<b>\$1984</b>	N/A	<b>\$473</b>	
Z2460LOFL	60 x 24 x 18.37	160	19.25	<b>\$1628</b>	<b>\$1752</b>	N/A	<b>\$395</b>	
Z2072LOFL	72 x 20 x 18.37	164	19.25	<b>\$1707</b>	<b>\$1830</b>	N/A	<b>\$395</b>	
Z2060LOFL	60 x 20 x 18.37	143	16.25	<b>\$1505</b>	<b>\$1610</b>	N/A	<b>\$329</b>	

1 high lateral file on the **left**, open storage on the **right**. Shipped assembled in 1 carton.

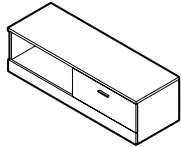

Lateral File Credenza - RIGHT

Z2472LOFR	72 x 24 x 18.37	181	22.75	<b>\$1834</b>	<b>\$1984</b>	N/A	<b>\$473</b>	
Z2460LOFR	60 x 24 x 18.37	160	19.25	<b>\$1628</b>	<b>\$1752</b>	N/A	<b>\$395</b>	
Z2072LOFR	72 x 20 x 18.37	164	19.25	<b>\$1707</b>	<b>\$1830</b>	N/A	<b>\$395</b>	
Z2060LOFR	60 x 20 x 18.37	143	16.25	<b>\$1505</b>	<b>\$1610</b>	N/A	<b>\$329</b>	

1 high lateral file on the **right**, open storage on the **left**. Shipped assembled in 1 carton.

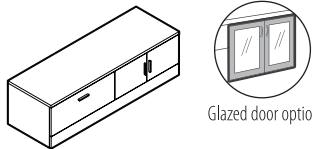

Glazed door option

Lateral File Credenza - LEFT\*

Z2472LSFL	72 x 24 x 18.37	197	22.75	<b>\$2135</b>	<b>\$2285</b>	<b>\$469</b>	<b>\$473</b>	
Z2460LSFL	60 x 24 x 18.37	174	19.25	<b>\$1925</b>	<b>\$2049</b>	<b>\$417</b>	<b>\$395</b>	
Z2072LSFL	72 x 20 x 18.37	178	19.25	<b>\$2002</b>	<b>\$2126</b>	<b>\$469</b>	<b>\$395</b>	
Z2060LSFL	60 x 20 x 18.37	155	16.25	<b>\$1795</b>	<b>\$1900</b>	<b>\$417</b>	<b>\$329</b>	

1 high lateral file on the **left**, closed hinged door storage on the **right**. Shipped assembled in 1 carton.

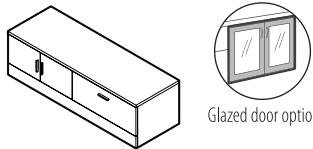

Glazed door option

Lateral File Credenza - RIGHT\*

Z2472LSFR	72 x 24 x 18.37	197	22.75	<b>\$2135</b>	<b>\$2285</b>	<b>\$469</b>	<b>\$473</b>	
Z2460LSFR	60 x 24 x 18.37	174	19.25	<b>\$1925</b>	<b>\$2049</b>	<b>\$417</b>	<b>\$395</b>	
Z2072LSFR	72 x 20 x 18.37	178	19.25	<b>\$2002</b>	<b>\$2126</b>	<b>\$469</b>	<b>\$395</b>	
Z2060LSFR	60 x 20 x 18.37	155	16.25	<b>\$1795</b>	<b>\$1900</b>	<b>\$469</b>	<b>\$329</b>	

1 high lateral file on the **right**, closed hinged door storage on the **left**. Shipped assembled in 1 carton.

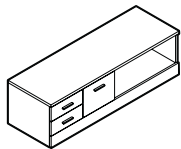

Mixed Storage Credenza - LEFT

Z2472LMOL	72 x 24 x 18.37	197	22.75	<b>\$2111</b>	<b>\$2261</b>	N/A	<b>\$473</b>	
Z2460LMOL	60 x 24 x 18.37	176	19.25	<b>\$1926</b>	<b>\$2050</b>	N/A	<b>\$395</b>	
Z2072LMOL	72 x 20 x 18.37	178	19.25	<b>\$1978</b>	<b>\$2101</b>	N/A	<b>\$395</b>	
Z2060LMOL	60 x 20 x 18.37	157	16.25	<b>\$1797</b>	<b>\$1902</b>	N/A	<b>\$329</b>	

1 high mixed drawers on the **left**, open storage on the **right**. Shipped assembled in 1 carton.

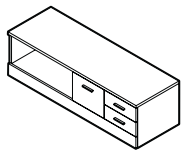

Mixed Storage Credenza - RIGHT

Z2472LMOR	72 x 24 x 18.37	197	22.75	<b>\$2111</b>	<b>\$2261</b>	N/A	<b>\$473</b>	
Z2460LMOR	60 x 24 x 18.37	176	19.25	<b>\$1928</b>	<b>\$2050</b>	N/A	<b>\$395</b>	
Z2072LMOR	72 x 20 x 18.37	178	19.25	<b>\$1978</b>	<b>\$2101</b>	N/A	<b>\$395</b>	
Z2060LMOR	60 x 20 x 18.37	157	16.25	<b>\$1797</b>	<b>\$1902</b>	N/A	<b>\$329</b>	

1 high mixed drawers on the **right**, open storage on the **left**. Shipped assembled in 1 carton.

**Required specifications**

- Top finish
- Top/edge detail
- Base finish
- Handles

**Optional specifications**

- HP laminate
- Key #
- Glazed hinged doors\*
- Box drawer - no upcharge

24"H CREDENZAS

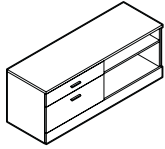

Lateral File Credenza - LEFT

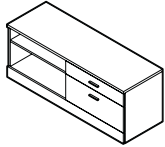

Lateral File Credenza - RIGHT

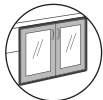
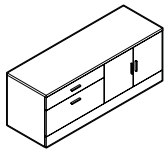

Glazed door option

Lateral File Credenza - LEFT\*

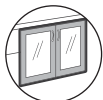
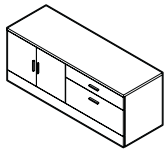

Glazed door option

Lateral File Credenza - RIGHT\*

MODEL #	DIMENSIONS W x D x H (1.5" TOP)	WT/LB.	CUBIC FT.	1" TOP	1.5" TOP	GLAZE ADD	HP ADD
Z2472HBFL	72 x 24 x 24.25	229	29.25	<b>\$2298</b>	<b>\$2448</b>	N/A	<b>\$473</b>
Z2460HBFL	60 x 24 x 24.25	201	24.5	<b>\$2035</b>	<b>\$2159</b>	N/A	<b>\$395</b>
Z2072HBFL	72 x 20 x 24.25	207	24.75	<b>\$2160</b>	<b>\$2284</b>	N/A	<b>\$395</b>
Z2060HBFL	60 x 20 x 24.25	180	20.75	<b>\$1905</b>	<b>\$2010</b>	N/A	<b>\$329</b>

1.5 high box/lateral file on the **left**, open storage on the **right**. Shipped assembled in 1 carton.

Z2472HBFR	72 x 24 x 24.25	229	29.25	<b>\$2298</b>	<b>\$2448</b>	N/A	<b>\$473</b>
Z2460HBFR	60 x 24 x 24.25	201	24.5	<b>\$2035</b>	<b>\$2159</b>	N/A	<b>\$395</b>
Z2072HBFR	72 x 20 x 24.25	207	24.75	<b>\$2160</b>	<b>\$2284</b>	N/A	<b>\$395</b>
Z2060HBFR	60 x 20 x 24.25	180	20.75	<b>\$1905</b>	<b>\$2010</b>	N/A	<b>\$329</b>

1.5 high box/lateral file on the **right**, open storage on the **left**. Shipped assembled in 1 carton.

Z2472HFSL	72 x 24 x 24.25	251	29.25	<b>\$2688</b>	<b>\$2838</b>	<b>\$645</b>	<b>\$473</b>
Z2460HFSL	60 x 24 x 24.25	221	24.5	<b>\$2399</b>	<b>\$2523</b>	<b>\$558</b>	<b>\$395</b>
Z2072HFSL	72 x 20 x 24.25	227	24.75	<b>\$2526</b>	<b>\$2650</b>	<b>\$645</b>	<b>\$395</b>
Z2060HFSL	60 x 20 x 24.25	198	20.75	<b>\$2255</b>	<b>\$2360</b>	<b>\$558</b>	<b>\$329</b>

1.5 high box/lateral file on the **left**, closed hinged door storage on the **right**. Shipped assembled in 1 carton.

Z2472HFSL	72 x 24 x 24.25	251	29.25	<b>\$2688</b>	<b>\$2838</b>	<b>\$645</b>	<b>\$473</b>
Z2460HFSL	60 x 24 x 24.25	221	24.5	<b>\$2399</b>	<b>\$2523</b>	<b>\$558</b>	<b>\$395</b>
Z2072HFSL	72 x 20 x 24.25	227	24.75	<b>\$2526</b>	<b>\$2650</b>	<b>\$645</b>	<b>\$395</b>
Z2060HFSL	60 x 20 x 24.25	198	20.75	<b>\$2255</b>	<b>\$2360</b>	<b>\$558</b>	<b>\$329</b>

1.5 high box/lateral file on the **right**, closed hinged door storage on the **left**. Shipped assembled in 1 carton.

**Required specifications**

Top finish  
Top/edge detail  
Base finish  
Handles

**Optional specifications**

HP laminate  
Key #  
Glazed hinged doors\*  
Box drawer - no upcharge

CRENZAS	MODEL #	DIMENSIONS	WT/LB.	CUBIC FT.	1" TOP	1.5" TOP	GLAZE ADD	HP ADD
---------	---------	------------	--------	-----------	--------	----------	-----------	--------

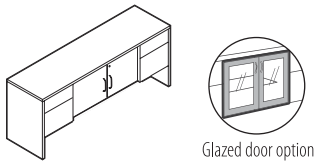

**Center Storage Credenza\*\***

	W x D x H (1.5" TOP)							
Z2072C	72 x 20 x 30	261	30	<b>\$1936</b>	<b>\$2482</b>	<b>\$641</b>		<b>\$345</b>

Standard with box/file pedestals on both sides and self-closing hinged center doors covering one adjustable shelf. Pedestals and doors lock, keyed alike. Two pencil trays. Modesty panel 1" from floor for wire cord escape. Shipped assembled in 1 carton.

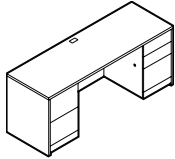

**Full to Floor Kneespace Credenza**

Z2472D4	72 x 24 x 30	282	35.5	<b>\$2305</b>	<b>\$2512</b>	N/A		<b>\$358</b>
Z2466D4	66 x 24 x 30	272.48	33	<b>\$2305</b>	<b>\$2446</b>	N/A		<b>\$330</b>
Z2072D4	72 x 20 x 30	258	30	<b>\$2224</b>	<b>\$2399</b>	N/A		<b>\$345</b>
Z2066D4	66 x 20 x 30	248	27.75	<b>\$2224</b>	<b>\$2360</b>	N/A		<b>\$330</b>
Z2060D4	60 x 20 x 30	238	25.25	<b>\$2153</b>	<b>\$2265</b>	N/A		<b>\$304</b>

Standard with box/box/file pedestal on the right and file/file pedestal on the left. Center is open. File drawer and lower box drawer locking, keyed alike. One pencil tray. Grommet in worksurface. Modesty panel 1" from floor for wire cord escape. Shipped assembled in 1 carton.

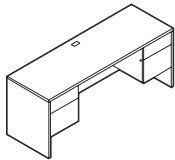

**Kneespace Credenza\***

Z2472CK	72 x 24 x 30	262	35.5	<b>\$1867</b>	<b>\$2139</b>	N/A		<b>\$358</b>
Z2466CK	66 x 24 x 30	250	33	<b>\$1867</b>	<b>\$2072</b>	N/A		<b>\$330</b>
Z2072CK	72 x 20 x 30	228	30	<b>\$1599</b>	<b>\$1752</b>	N/A		<b>\$345</b>
Z2066CK	66 x 20 x 30	218	27.75	<b>\$1599</b>	<b>\$1712</b>	N/A		<b>\$330</b>
Z2060CK	60 x 20 x 30	209	25.25	<b>\$1566</b>	<b>\$1651</b>	N/A		<b>\$304</b>

Standard with box/file pedestals on both sides. Center is open. Pedestals lock, keyed alike. Two pencil trays. Grommet in worksurface. Modesty panel 1" from floor for wire cord escape. Shipped assembled in 1 carton.

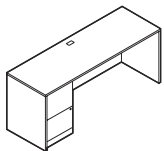

**Full to Floor Single Pedestal Credenza - LEFT**

Z2472S2L	72 x 24 x 30	228	35.5	<b>\$1586</b>	<b>\$1864</b>	N/A		<b>\$345</b>
Z2466S2L	66 x 24 x 30	217	33	<b>\$1586</b>	<b>\$1788</b>	N/A		<b>\$330</b>
Z2072S2L	72 x 20 x 30	203	30	<b>\$1498</b>	<b>\$1689</b>	N/A		<b>\$345</b>
Z2066S2L	66 x 20 x 30	194	27.75	<b>\$1498</b>	<b>\$1650</b>	N/A		<b>\$345</b>
Z2060S2L	60 x 20 x 30	184	25.25	<b>\$1432</b>	<b>\$1544</b>	N/A		<b>\$304</b>

Standard with full to floor file/file pedestal on the **left**. Pedestal locks. Grommet in worksurface. Modesty panel 1" from floor for wire cord escape. Shipped assembled in 1 carton.

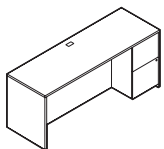

**Full to Floor Single Pedestal Credenza - RIGHT**

Z2472S2R	72 x 24 x 30	228	35.5	<b>\$1586</b>	<b>\$1864</b>	N/A		<b>\$345</b>
Z2466S2R	66 x 24 x 30	217	33	<b>\$1586</b>	<b>\$1788</b>	N/A		<b>\$330</b>
Z2072S2R	72 x 20 x 30	203	30	<b>\$1498</b>	<b>\$1689</b>	N/A		<b>\$345</b>
Z2066S2R	66 x 20 x 30	194	27.75	<b>\$1498</b>	<b>\$1650</b>	N/A		<b>\$345</b>

Standard with full to floor file/file pedestal on the **right**. Pedestal locks. Grommet in worksurface. Modesty panel 1" from floor for wire cord escape. Shipped assembled in 1 carton.

**Required specifications**

Top finish  
 Top thickness/edge detail  
 Base finish  
 Lock finish

**Optional specifications**

HP laminate  
 Key #  
 Modesty type\*  
 Grommet position or power block cut-out

**Accessories**

Pencil drawer (Z2472S2L/R only)  
 Power block (not Z2072C)

CREDENZAS	MODEL #	DIMENSIONS	WT/LB.	CUBIC FT.	1" TOP	1.5" TOP	GLAZE ADD	HP ADD
-----------	---------	------------	--------	-----------	--------	----------	-----------	--------

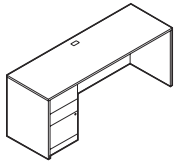

**Full to Floor Single Pedestal Credenza - LEFT\***

	W x D x H (1.5" TOP)							
Z2472S4L	72 x 24 x 30	225	35.5	<b>\$1738</b>	<b>\$1807</b>	N/A	<b>\$345</b>	
Z2466S4L	66 x 24 x 30	215	33	<b>\$1582</b>	<b>\$1737</b>	N/A	<b>\$330</b>	
Z2072S4L	72 x 20 x 30	205	30	<b>\$1467</b>	<b>\$1640</b>	N/A	<b>\$345</b>	
Z2066S4L	66 x 20 x 30	195	27.75	<b>\$1467</b>	<b>\$1599</b>	N/A	<b>\$345</b>	
Z2060S4L	60 x 20 x 30	185	25.25	<b>\$1389</b>	<b>\$1501</b>	N/A	<b>\$304</b>	

Standard with full to floor box/box/file pedestal on the **left**. File drawer and lower box drawer locking. One pencil tray. Grommet in worksurface. Modesty panel 1" from floor for wire cord escape. Shipped assembled in 1 carton.

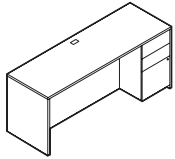

**Full to Floor Single Pedestal Credenza - RIGHT\***

Z2472S4R	72 x 24 x 30	225	35.5	<b>\$1738</b>	<b>\$1807</b>	N/A	<b>\$345</b>
Z2466S4R	66 x 24 x 30	215	33	<b>\$1582</b>	<b>\$1737</b>	N/A	<b>\$330</b>
Z2072S4R	72 x 20 x 30	205	30	<b>\$1467</b>	<b>\$1640</b>	N/A	<b>\$345</b>
Z2066S4R	66 x 20 x 30	195	27.75	<b>\$1467</b>	<b>\$1599</b>	N/A	<b>\$345</b>
Z2060S4R	60 x 20 x 30	185	25.25	<b>\$1389</b>	<b>\$1501</b>	N/A	<b>\$304</b>

Standard with full to floor box/box/file pedestal on the **right**. File drawer and lower box drawer locking. One pencil tray. Grommet in worksurface. Modesty panel 1" from floor for wire cord escape. Shipped assembled in 1 carton.

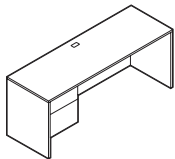

**Single Pedestal Credenza - LEFT\***

Z2472CSL	72 x 24 x 30	210	35.75	<b>\$1503</b>	<b>\$1631</b>	N/A	<b>\$358</b>
Z2466CSL	66 x 24 x 30	199	32.75	<b>\$1503</b>	<b>\$1561</b>	N/A	<b>\$330</b>
Z2072CSL	72 x 20 x 30	190	30.25	<b>\$1275</b>	<b>\$1428</b>	N/A	<b>\$345</b>
Z2066CSL	66 x 20 x 30	180	27.75	<b>\$1275</b>	<b>\$1387</b>	N/A	<b>\$330</b>
Z2060CSL	60 x 20 x 30	171	25.25	<b>\$1205</b>	<b>\$1296</b>	N/A	<b>\$304</b>

Standard with box/file pedestal on the **left**. Pedestal locks. One pencil tray. Grommet in worksurface. Modesty panel 1" from floor for wire cord escape. Shipped assembled in 1 carton.

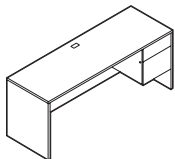

**Single Pedestal Credenza - RIGHT\***

Z2472CSR	72 x 24 x 30	210	35.75	<b>\$1503</b>	<b>\$1631</b>	N/A	<b>\$358</b>
Z2466CSR	66 x 24 x 30	199	32.75	<b>\$1503</b>	<b>\$1561</b>	N/A	<b>\$330</b>
Z2072CSR	72 x 20 x 30	190	30	<b>\$1275</b>	<b>\$1428</b>	N/A	<b>\$345</b>
Z2066CSR	66 x 20 x 30	180	27.75	<b>\$1275</b>	<b>\$1387</b>	N/A	<b>\$330</b>
Z2060CSR	60 x 20 x 30	171	25.25	<b>\$1205</b>	<b>\$1296</b>	N/A	<b>\$304</b>

Standard with box/file pedestal on the **right**. Pedestal locks. One pencil tray. Grommet in worksurface. Modesty panel 1" from floor for wire cord escape. Shipped assembled in 1 carton.

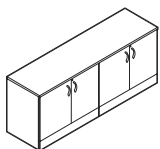

Glazed door option

**Storage Cabinet Credenza\*\***

Z2472SCSC	72 x 24 x 30	290	35.75	<b>\$2196</b>	<b>\$2342</b>	<b>\$799</b>	<b>\$345</b>
Z2072SCSC	72 x 20 x 30	263	30.25	<b>\$1992</b>	<b>\$2123</b>	<b>\$799</b>	<b>\$345</b>

Two storage cabinets side-by-side. Hinged doors cover one adjustable shelf. Locking doors keyed alike. Shipped assembled in 1 carton.

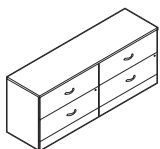

**Storage Cabinet Credenza**

Z2472LF2	72 x 24 x 30	345	35.75	<b>\$2885</b>	<b>\$3148</b>	N/A	<b>\$345</b>
Z2072LF2	72 x 20 x 30	315	30.25	<b>\$2826</b>	<b>\$3089</b>	N/A	<b>\$345</b>

Two 2-drawer lateral files side-by-side. Locking drawers, keyed alike. File bars included for side-to-side and front-to-back letter/legal filing capability. Anti-lock tilt suspension. Shipped assembled in 1 carton.

**Required specifications**

Top finish  
Top thickness/edge detail  
Base finish  
Lock finish\*

**Optional specifications**

HP laminate  
Key # (not Z2x72SCSC)  
Grommet position or power block cut-out (not Z2x72LF2)

Handles  
Glazed doors\*\*

**Accessories**

Pencil drawer\*\*  
Power block\*

CRENZAS	MODEL #	DIMENSIONS	WT/LB.	CUBIC FT.	1" TOP	1.5" TOP	GLAZE ADD	HP ADD
---------	---------	------------	--------	-----------	--------	----------	-----------	--------

W x D x H (1.5" TOP)

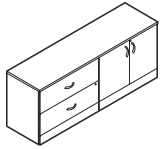

Glazed door option

**Lateral File/Storage Cabinet Credenza\***

One 2-drawer lateral file and one storage cabinet. Locking door/drawers, keyed alike. Storage cabinet includes one adjustable shelf. File bars included for side-to-side and front-to-back letter/legal filing capability. Anti-lock tilt suspension. Shipped assembled in 1 carton.

- File drawer construction is for accommodating hanging files NOT for stacking materials on the drawer bottom.

Z2472LKL	72 x 24 x 30	262	35.75	<b>\$2273</b>	<b>\$2536</b>	N/A	<b>\$345</b>
Z2072LKL	72 x 20 x 30	235	30.25	<b>\$2213</b>	<b>\$2476</b>	N/A	<b>\$345</b>

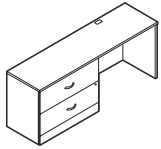

**Kneespace Lateral File Credenza - LEFT**

One 2-drawer lateral file on the **left**. Locking drawers. File bars included for side-to-side and front-to-back letter/legal filing capability. Anti-lock tilt suspension. Grommet in worksurface. Modesty panel 1" from floor for wire cord escape. Shipped assembled in 1 carton.

- File drawer construction is for accommodating hanging files NOT for stacking materials on the drawer bottom.

Z2472LKR	72 x 24 x 30	262	35.75	<b>\$2273</b>	<b>\$2536</b>	N/A	<b>\$345</b>
Z2072LKR	72 x 20 x 30	235	30.25	<b>\$2213</b>	<b>\$2476</b>	N/A	<b>\$345</b>

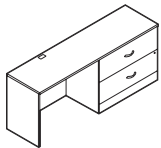

**Kneespace Lateral File Credenza - RIGHT**

One 2-drawer lateral file on the **right**. Locking drawers. File bars included for side-to-side and front-to-back letter/legal filing capability. Anti-lock tilt suspension. Grommet in worksurface. Modesty panel 1" from floor for wire cord escape. Shipped assembled in 1 carton.

- File drawer construction is for accommodating hanging files NOT for stacking materials on the drawer bottom.

Z2472SKL	72 x 24 x 30	241	35.75	<b>\$1788</b>	<b>\$2051</b>	<b>\$721</b>	<b>\$345</b>
Z2072SKL	72 x 20 x 30	207	30.25	<b>\$1728</b>	<b>\$1990</b>	<b>\$721</b>	<b>\$345</b>

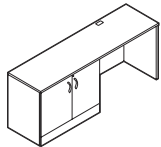

Glazed door option

**Kneespace Storage Cabinet Credenza - LEFT\***

One storage cabinet on the **left**. Locking doors. Storage cabinet has one adjustable shelf. Grommet in worksurface. Modesty panel 1" from floor for wire cord escape. Shipped assembled in 1 carton.

Z2472SKR	72 x 24 x 30	241	35.75	<b>\$1788</b>	<b>\$2051</b>	<b>\$721</b>	<b>\$345</b>
Z2072SKR	72 x 20 x 30	207	30.25	<b>\$1728</b>	<b>\$1990</b>	<b>\$721</b>	<b>\$345</b>

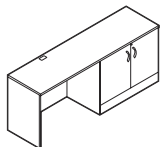

Glazed door option

**Kneespace Storage Cabinet Credenza - RIGHT\***

One storage cabinet on the **right**. Locking doors. Storage cabinet has one adjustable shelf. Grommet in worksurface. Modesty panel 1" from floor for wire cord escape. Shipped assembled in 1 carton.

**Required specifications**

Top finish  
Top thickness/edge detail  
Base finish  
Handles

**Optional specifications**

HP laminate  
Glazed door\*  
Key #  
Grommet position or power block cut-out  
Modesty finish glazed (only Z2x72LS)

**Accessories**

Power block (not Z2x72LS)

CREDENZAS	MODEL #	DIMENSIONS	WT/LB.	CUBIC FT.	1" TOP	1.5" TOP	GLAZE ADD	HP ADD
-----------	---------	------------	--------	-----------	--------	----------	-----------	--------

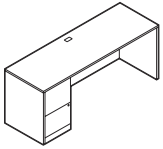

**Full to Floor Single Pedestal Credenza - LEFT**

	W x D x H (1.5" TOP)							
Z2472CS2L	72 x 24 x 30	288	35.5	<b>\$1586</b>	<b>\$1864</b>	N/A	<b>\$345</b>	
Z2466CS2L	66 x 24 x 30	271	33	<b>\$1586</b>	<b>\$1788</b>	N/A	<b>\$330</b>	
Z2072CS2L	72 x 20 x 30	193	30	<b>\$1498</b>	<b>\$1689</b>	N/A	<b>\$345</b>	
Z2066CS2L	66 x 20 x 30	183	27.75	<b>\$1498</b>	<b>\$1650</b>	N/A	<b>\$330</b>	

Standard with file/file pedestal on the **left**. Pedestal locks. Grommet in worksurface. Shipped assembled in 1 carton.

- File drawer construction is for accommodating hanging files **NOT** for stacking materials on the drawer bottom.

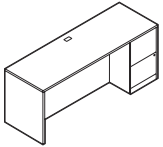

**Full to Floor Single Pedestal Credenza - RIGHT**

Z2472CS2R	72 x 24 x 30	288	35.5	<b>\$1586</b>	<b>\$1864</b>	N/A	<b>\$345</b>
Z2466CS2R	66 x 24 x 30	271	33	<b>\$1586</b>	<b>\$1788</b>	N/A	<b>\$330</b>
Z2072CS2R	72 x 20 x 30	193	30	<b>\$1498</b>	<b>\$1689</b>	N/A	<b>\$345</b>
Z2066CS2R	66 x 20 x 30	184	27.75	<b>\$1498</b>	<b>\$1650</b>	N/A	<b>\$330</b>

Standard with file/file pedestal on the **right**. Pedestal locks. Grommet in worksurface. Shipped assembled in 1 carton.

- File drawer construction is for accommodating hanging files **NOT** for stacking materials on the drawer bottom.

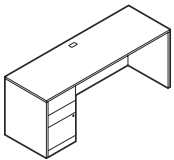

**Full to Floor Single Pedestal Credenza - LEFT**

Z2472CS4L	72 x 24 x 30	289	35.5	<b>\$1738</b>	<b>\$1807</b>	N/A	<b>\$345</b>
Z2466CS4L	66 x 24 x 30	272	33	<b>\$1582</b>	<b>\$1737</b>	N/A	<b>\$330</b>
Z2072CS4L	72 x 20 x 30	194	30	<b>\$1467</b>	<b>\$1640</b>	N/A	<b>\$345</b>
Z2066CS4L	66 x 20 x 30	185	27.75	<b>\$1467</b>	<b>\$1599</b>	N/A	<b>\$330</b>

Standard with box/box/file pedestal on the **left**. File drawer and lower box drawer locking. One pencil tray. Grommet in worksurface. Shipped assembled in 1 carton.

- File drawer construction is for accommodating hanging files **NOT** for stacking materials on the drawer bottom.

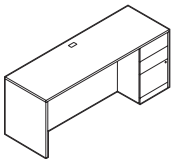

**Full to Floor Single Pedestal Credenza - RIGHT**

Z2472CS4R	72 x 24 x 30	289	35.5	<b>\$1738</b>	<b>\$1807</b>	N/A	<b>\$345</b>
Z2466CS4R	66 x 24 x 30	272	33	<b>\$1582</b>	<b>\$1737</b>	N/A	<b>\$330</b>
Z2072CS4R	72 x 20 x 30	194	30	<b>\$1467</b>	<b>\$1640</b>	N/A	<b>\$345</b>
Z2066CS4R	66 x 20 x 30	185	27.75	<b>\$1467</b>	<b>\$1599</b>	N/A	<b>\$330</b>

Standard with box/box/file pedestal on the **right**. File drawer and lower box drawer locking. One pencil tray. Grommet in worksurface. Shipped assembled in 1 carton.

- File drawer construction is for accommodating hanging files **NOT** for stacking materials on the drawer bottom.

**Required specifications**

Top finish  
Top thickness/edge detail  
Base finish  
Lock finish

**Optional specifications**

HP laminate  
Handles  
Key #  
Grommet position or power block cut-out

**Accessories**

Pencil drawer  
Power block

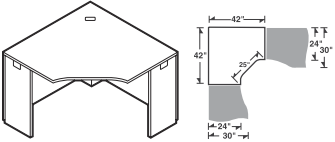
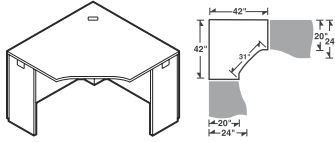
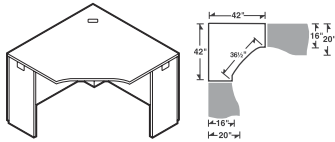
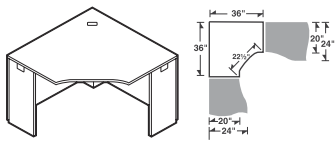
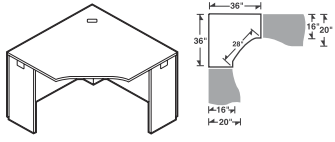
5-SIDED CORNERS	MODEL #	DIMENSIONS W x D x H (1.5" TOP)	WT/LB.	CUBIC FT.	1" TOP	1.5" TOP	GLAZE ADD	HP ADD
 <p><b>5-Sided Corner, 24" Throat</b></p>	Z42245C	42 x 42 x 30	132	5.75	<b>\$1117</b>	<b>\$1301</b>	N/A	<b>\$484</b>
<p>Connects to <b>30"D</b> space saver connectable surfaces, <b>24"D</b> connectables, returns and bridge. Grommet in worksurface. Narrow end panels on left and right. <b>Not freestanding.</b> Shipped easy to assemble in 1 carton.</p> <ul style="list-style-type: none"> <li>• <b>Modesty panel is 1" off of ground.</b></li> </ul>								
 <p><b>5-Sided Corner, 20" Throat</b></p>	Z42205C	42 x 42 x 30	128	5.75	<b>\$1117</b>	<b>\$1301</b>	N/A	<b>\$484</b>
<p>Connects to <b>24"D</b> space saver connectable surfaces, <b>20"D</b> returns, lateral files, storage/lateral file credenzas, credenzas, and bridges. Grommet in worksurface. Narrow end panels on left and right. <b>Not freestanding.</b> Shipped easy to assemble in 1 carton.</p> <ul style="list-style-type: none"> <li>• <b>Modesty panel is 1" off of ground.</b></li> </ul>								
 <p><b>5-Sided Corner, 16" Throat</b></p>	Z42165C	42 x 42 x 30	124	5.75	<b>\$950</b>	<b>\$1093</b>	N/A	<b>\$460</b>
<p>Connects to <b>20"D</b> space saver connectable surfaces, <b>16"D</b> returns, lateral files, storage/lateral file credenzas, credenzas, and bridges. Grommet in worksurface. Narrow end panels on left and right. <b>Not freestanding.</b> Shipped easy to assemble in 1 carton.</p> <ul style="list-style-type: none"> <li>• <b>Modesty panel is 1" off of ground.</b></li> </ul>								
 <p><b>5-Sided Corner, 20" Throat</b></p>	Z36205C	36 x 36 x 30	109	4.8	<b>\$954</b>	<b>\$1045</b>	N/A	<b>\$311</b>
<p>Connects to <b>24"D</b> space saver connectable surfaces, <b>20"D</b> returns, lateral files, storage/lateral file credenzas, credenzas, and bridges. Grommet in worksurface. Narrow end panels on left and right. <b>Not freestanding.</b> Shipped easy to assemble in 1 carton.</p> <ul style="list-style-type: none"> <li>• <b>Modesty panel is 1" off of ground.</b></li> </ul>								
 <p><b>5-Sided Corner, 16" Throat</b></p>	Z36165C	36 x 36 x 30	105	4.8	<b>\$829</b>	<b>\$938</b>	N/A	<b>\$257</b>
<p>Connects to <b>20"D</b> space saver connectable surfaces, <b>16"D</b> returns, lateral files, storage/lateral file credenzas, credenzas, and bridges. Grommet in worksurface. Narrow end panels on left and right. <b>Not freestanding.</b> Shipped easy to assemble in 1 carton.</p> <ul style="list-style-type: none"> <li>• <b>Modesty panel is 1" off of ground.</b></li> </ul>								

**Required specifications**

Top finish  
Top thickness/edge detail  
Base finish

**Optional specifications**

HP laminate  
Modesty type  
Grommet position or power block cut-out

**Accessories**

Power block  
Keyboard

LEFT EXT CORNER DESKS

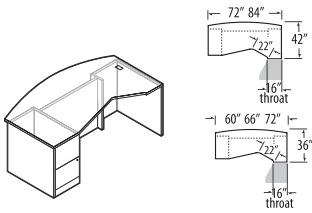

Single Pedestal Bow Top Extended Corner Desk - LEFT

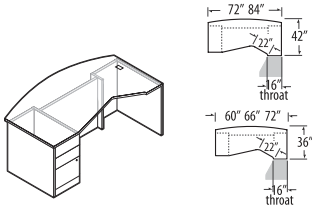

Single Pedestal Bow Top Extended Corner Desk - LEFT

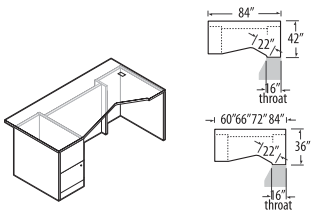

Single Pedestal Extended Corner Desk - LEFT

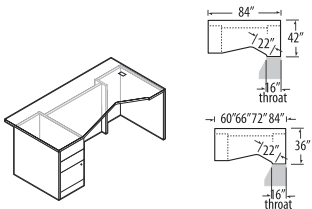

Single Pedestal Extended Corner Desk - LEFT

MODEL # DIMENSIONS WT/LB. CUBIC FT. 1" TOP 1.5" TOP GLAZE ADD HP ADD

	W x D x H (1.5" TOP)							
Z4284EB2L	84 x 42 x 30		316	20.5	\$2059	\$2331	\$873	\$919
Z4272EB2L	72 x 42 x 30		331	59	\$1945	\$2177	\$721	\$690
Z3672EB2L	72 x 36 x 30		273	50.75	\$1770	\$1977	\$721	\$516
Z3666EB2L	66 x 36 x 30		260	46.75	\$1739	\$1927	\$645	\$516
Z3660EB2L	60 x 36 x 30		257	42.5	\$1691	\$1860	\$570	\$431

Extended worksurface on left. Standard with **freestanding** full to floor file/file pedestal on **left** and faux pedestal on **right**. Pedestal locks. Connects to returns or bridges with a 16" throat. Corner has one grommet. Bow top overhangs 2.25" at ends and 6" on center. Shipped assembled in 1 carton.

- 84" wide desks are shipped easy to assemble in 2 cartons.

Z4284EB3L	84 x 42 x 30		315	20.5	\$2082	\$2354	\$873	\$919
Z4272EB3L	72 x 42 x 30		329	59	\$1969	\$2201	\$721	\$690
Z3672EB3L	72 x 36 x 30		271	50.75	\$1806	\$2013	\$721	\$516
Z3666EB3L	66 x 36 x 30		259	46.75	\$1757	\$1945	\$645	\$516
Z3660EB3L	60 x 36 x 30		255	42.5	\$1727	\$1896	\$570	\$431

Extended worksurface on left. Standard with **freestanding** full to floor box/box/file pedestal on **left** and faux pedestal on **right**. File drawer and lower box drawer locking. Connects to returns or bridges with a 16" throat. Corner has one grommet. Bow top overhangs 2.25" at ends and 6" on center. Shipped assembled in 1 carton.

- 84" wide desks are shipped easy to assemble in 2 cartons.

Z4284E2L	84 x 42 x 30		321	20.5	\$2053	\$2313	\$873	\$919
Z3684E2L	84 x 36 x 30		312	59	\$1968	\$2228	\$873	\$690
Z3672E2L	72 x 36 x 30		278	50.75	\$1766	\$1961	\$721	\$516
Z3666E2L	66 x 36 x 30		266	46.75	\$1716	\$1894	\$645	\$516
Z3660E2L	60 x 36 x 30		259	42.5	\$1687	\$1850	\$570	\$431

Extended worksurface on left. Standard with **freestanding** full to floor file/file pedestal on **left** and faux pedestal on **right**. Pedestal locks. Connects to returns or bridges with a 16" throat. Corner has one grommet. Top overhangs 2.25". Shipped assembled in 1 carton.

- 84" wide desks are shipped easy to assemble in 2 cartons.

Z4284E3L	84 x 42 x 30		318	20.5	\$2077	\$2337	\$873	\$919
Z3684E3L	84 x 36 x 30		310	59	\$2002	\$2262	\$873	\$690
Z3672E3L	72 x 36 x 30		275	50.75	\$1800	\$1995	\$721	\$516
Z3666E3L	66 x 36 x 30		264	46.75	\$1755	\$1933	\$645	\$516
Z3660E3L	60 x 36 x 30		257	42.5	\$1724	\$1887	\$570	\$431

Extended worksurface on left. Standard with **freestanding** full to floor box/box/file pedestal on **left** and faux pedestal on **right**. File drawer and lower box drawer locking. Connects to returns or bridges with a 16" throat. Corner has one grommet. Top overhangs 2.25". Shipped assembled in 1 carton.

- 84" wide desks are shipped easy to assemble in 2 cartons.

Required specifications

Top finish  
Top thickness/edge detail  
Base finish  
Handles

Optional specifications

HP laminate  
Key #  
Modesty type  
Grommet position or power block cut-out

Accessories

Power block  
Keyboard



**RIGHT EXT CORNER DESKS**

MODEL #	DIMENSIONS	WT/LB.	CUBIC FT.	1" TOP	1.5" TOP	GLAZE ADD	HP ADD
---------	------------	--------	-----------	--------	----------	-----------	--------

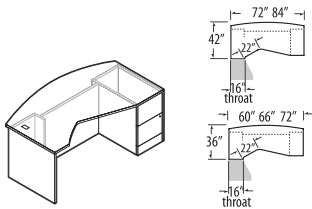

**Single Pedestal Bow Top Extended Corner Desk - RIGHT**

	W x D x H (1.5" TOP)						
Z4284EB2R	84 x 42 x 30	316	41	<b>\$2059</b>	<b>\$2331</b>	<b>\$873</b>	<b>\$919</b>
Z4272EB2R	72 x 42 x 30	331	59	<b>\$1945</b>	<b>\$2177</b>	<b>\$721</b>	<b>\$690</b>
Z3672EB2R	72 x 36 x 30	273	50.75	<b>\$1770</b>	<b>\$1977</b>	<b>\$721</b>	<b>\$516</b>
Z3666EB2R	66 x 36 x 30	260	46.75	<b>\$1739</b>	<b>\$1927</b>	<b>\$645</b>	<b>\$516</b>
Z3660EB2R	60 x 36 x 30	257	42.5	<b>\$1691</b>	<b>\$1860</b>	<b>\$570</b>	<b>\$431</b>

Extended worksurface on right. Standard with faux pedestal on **left** and **freestanding** full to floor file/file pedestal on **right**. Pedestal locks. Connects to returns or bridges with a 16" throat. Corner has one grommet. Bow top overhangs 2.25" at ends and 6" on center. Shipped assembled in 1 carton.

- 84" wide desks are shipped easy to assemble in 2 cartons.

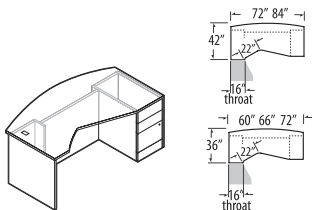

**Single Pedestal Bow Top Extended Corner Desk - RIGHT**

Z4284EB3R	84 x 42 x 30	315	41	<b>\$2082</b>	<b>\$2354</b>	<b>\$873</b>	<b>\$919</b>
Z4272EB3R	72 x 42 x 30	329	59	<b>\$1969</b>	<b>\$2201</b>	<b>\$721</b>	<b>\$690</b>
Z3672EB3R	72 x 36 x 30	271	50.75	<b>\$1806</b>	<b>\$2013</b>	<b>\$721</b>	<b>\$516</b>
Z3666EB3R	66 x 36 x 30	259	46.75	<b>\$1757</b>	<b>\$1945</b>	<b>\$645</b>	<b>\$516</b>
Z3660EB3R	60 x 36 x 30	255	42.5	<b>\$1727</b>	<b>\$1896</b>	<b>\$570</b>	<b>\$431</b>

Extended worksurface on right. Standard with faux pedestal on **left** and **freestanding** full to floor box/box/file pedestal on **right**. File drawer and lower box drawer locking. Connects to returns or bridges with a 16" throat. Corner has one grommet. Bow top overhangs 2.25" at ends and 6" on center. Shipped assembled in 1 carton.

- 84" wide desks are shipped easy to assemble in 2 cartons.

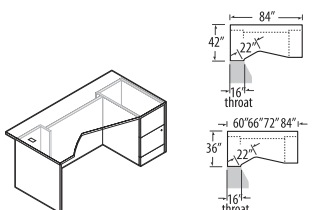

**Single Pedestal Extended Corner Desk - RIGHT**

Z4284E2R	84 x 42 x 30	321	41	<b>\$2053</b>	<b>\$2313</b>	<b>\$873</b>	<b>\$919</b>
Z3684E2R	84 x 36 x 30	312	59	<b>\$1968</b>	<b>\$2228</b>	<b>\$873</b>	<b>\$690</b>
Z3672E2R	72 x 36 x 30	278	50.75	<b>\$1766</b>	<b>\$1961</b>	<b>\$721</b>	<b>\$516</b>
Z3666E2R	66 x 36 x 30	266	46.75	<b>\$1716</b>	<b>\$1894</b>	<b>\$645</b>	<b>\$516</b>
Z3660E2R	60 x 36 x 30	259	42.5	<b>\$1687</b>	<b>\$1850</b>	<b>\$570</b>	<b>\$431</b>

Extended worksurface on right. Standard with **freestanding** full to floor file/file pedestal on **right** and faux pedestal on **left**. Pedestal locks. Connects to returns or bridges with a 16" throat. Corner has one grommet. Top overhangs 2.25". Shipped assembled in 1 carton.

- 84" wide desks are shipped easy to assemble in 2 cartons.

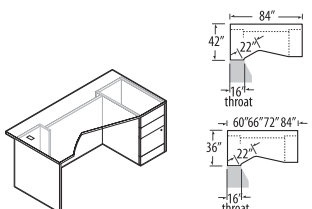

**Single Pedestal Extended Corner Desk - RIGHT**

Z4284E3R	84 x 42 x 30	318	41	<b>\$2077</b>	<b>\$2337</b>	<b>\$873</b>	<b>\$919</b>
Z3684E3R	84 x 36 x 30	310	59	<b>\$2002</b>	<b>\$2262</b>	<b>\$873</b>	<b>\$690</b>
Z3672E3R	72 x 36 x 30	275	50.75	<b>\$1800</b>	<b>\$1995</b>	<b>\$721</b>	<b>\$516</b>
Z3666E3R	66 x 36 x 30	264	46.75	<b>\$1755</b>	<b>\$1933</b>	<b>\$645</b>	<b>\$516</b>
Z3660E3R	60 x 36 x 30	257	42.5	<b>\$1724</b>	<b>\$1887</b>	<b>\$570</b>	<b>\$431</b>

Extended worksurface on right. Standard with **freestanding** full to floor box/box/file pedestal on **right** and faux pedestal on **left**. File drawer and lower box drawer locking. Connects to returns or bridges with a 16" throat. Corner has one grommet. Top overhangs 2.25". Shipped assembled in 1 carton.

- 84" wide desks are shipped easy to assemble in 2 cartons.

**Required specifications**

- Top finish
- Top thickness/edge detail
- Base finish
- Lock finish

**Optional specifications**

- HP laminate
- Handles
- Key #
- Modesty type
- Grommet position or power block cut-out

**Accessories**

- Power block
- Keyboard

LEFT EXT CORNERS (DOES NOT CONNECT)

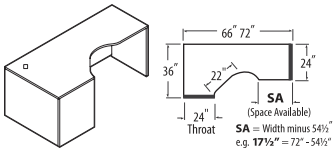

Extended Corner, 24" Throat  
Freestanding - LEFT

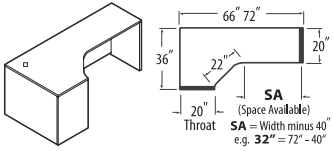

Extended Corner, 20" Throat - LEFT

MODEL # DIMENSIONS WT/LB. CUBIC FT. 1" TOP 1.5" TOP GLAZE ADD HP ADD

	W x D x H (1.5" TOP)						
Z2472FFL	72 x 36 x 30	180	7	\$1356	\$1540	N/A	\$518
Z2466FFL	66 x 36 x 30	172	7	\$1290	\$1454	N/A	\$518

Extended worksurface on right. **Full end panels on left and right. Cannot be connected on left or right, due to full end panel.** Corner has one grommet. Shipped easy to assemble in 1 carton.

- Modesty panel is 1" off of ground.
- Z2466FFL cannot accept pedestals.

Z2072FFL	72 x 36 x 30	168	7	\$1333	\$1538	N/A	\$498
Z2066FFL	66 x 36 x 30	161	7	\$1290	\$1454	N/A	\$498

Extended worksurface on right. **Full end panels on left and right. Can be placed next to** lateral files, storage cabinets, wardrobe units, credenzas and end-shelves. Corner has one grommet. Shipped easy to assemble in 1 carton.

- Modesty panel is 1" off of ground.

LEFT EXT CORNERS (CONNECTS ON EXTENDED SIDE)

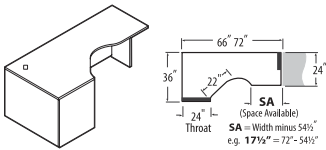

Extended Corner, 24" Throat - LEFT

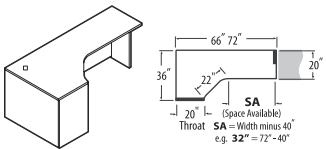

Extended Corner, 20" Throat - LEFT

W x D x H (1.5" TOP)

Z2472FNL	72 x 36 x 30	172	7	\$1333	\$1517	N/A	\$518
Z2466FNL	66 x 36 x 30	164	7	\$1290	\$1431	N/A	\$518

Extended worksurface on right. **Narrow end panel on right. Full end panel on left.** Connects to 30"D space saver connectables, 24"D returns, 24"D connectable tables or "D" and "P" islands with "T" or "H" bases. **Full end panel can be placed next to** lateral files, storage cabinets, wardrobe units, credenzas and end-shelves. Corner has one grommet.

- Shipped easy to assemble in 1 carton.
- Modesty panel is 1" off of ground.
- Z2466FNL cannot accept pedestals.

Z2072FNL	72 x 36 x 30	163	7	\$1311	\$1516	N/A	\$498
Z2066FNL	66 x 36 x 30	157	7	\$1265	\$1429	N/A	\$498

Extended worksurface on right. **Narrow end panel on right. Full end panel on left.** Connects to 24"D space saver connectables, 20"D returns, 20"D connectable tables or "D" and "P" islands with "T" or "H" bases. **Full end panel can be placed next to** lateral files, storage cabinets, wardrobe units, credenzas and end-shelves. Corner has one grommet.

- Shipped easy to assemble in 1 carton.
- Modesty panel is 1" off of ground.
- FNL end panels can be switched to make NFL.

Required specifications

Top finish  
Top thickness/edge detail  
Base finish

Optional specifications

HP laminate  
Modesty type  
Grommet position or power block cut-out

Accessories

Pencil drawer  
Power block  
Keyboard

LEFT EXT CORNERS (CONNECTS ON THROAT SIDE)

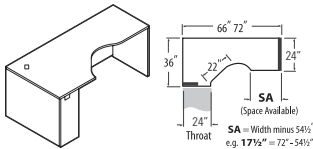

Extended Corner, 24" Throat - LEFT

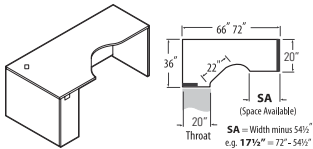

Extended Corner, 20" Throat - LEFT

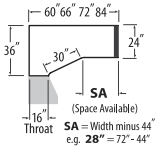

Extended Corner, 16" Throat - LEFT

MODEL #	DIMENSIONS W x D x H (1.5" TOP)	WT/LB.	CUBIC FT.	1" TOP	1.5" TOP	GLAZE ADD	HP ADD
Z2472NFL	72 x 36 x 30	172	7	<b>\$1333</b>	<b>\$1517</b>	N/A	<b>\$518</b>
Z2466NFL	66 x 36 x 30	164	7	<b>\$1290</b>	<b>\$1431</b>	N/A	<b>\$498</b>

Extended worksurface on right. **Narrow end panel on left. Full end panel on right.** Connects to 30"D space saver connectables, 30"D space saver returns, 24"D returns or 24"D connectable tables. **Full end panel can be placed next to** lateral files, storage cabinets, wardrobe units, credenzas and end-shelves. Corner has one grommet.

- Shipped easy to assemble in 1 carton.
- **Modesty panel is 1" off of ground.**
- **Z2466NFL cannot accept pedestals.**

Z2072NFL	72 x 36 x 30	163	7	<b>\$1311</b>	<b>\$1516</b>	N/A	<b>\$518</b>
Z2066NFL	66 x 36 x 30	157	7	<b>\$1265</b>	<b>\$1429</b>	N/A	<b>\$498</b>

Extended worksurface on right. **Narrow end panel on left. Full end panel on right.** Connects to 24"D space saver connectables and 20"D returns. **Full end panel can be placed next to** lateral files, storage cabinets, wardrobe units, credenzas and end-shelves. Corner has one grommet. Shipped easy to assemble in 1 carton.

- **Modesty panel is 1" off of ground.**
- *NFL end panels can be switched to make FNL.*

Z2484ECFL	84 x 36 x 30	196	8	<b>\$1147</b>	<b>\$1418</b>	N/A	<b>\$690</b>
Z2472ECFL	72 x 36 x 30	176	7.5	<b>\$1025</b>	<b>\$1262</b>	N/A	<b>\$516</b>
Z2466ECFL	66 x 36 x 30	168	7.5	<b>\$976</b>	<b>\$1196</b>	N/A	<b>\$516</b>
Z2460ECFL	60 x 36 x 30	159	6	<b>\$928</b>	<b>\$1130</b>	N/A	<b>\$431</b>
Z2084ECFL	84 x 36 x 30	185	8	<b>\$1144</b>	<b>\$1416</b>	N/A	<b>\$690</b>
Z2072ECFL	72 x 36 x 30	168	7.5	<b>\$1022</b>	<b>\$1259</b>	N/A	<b>\$516</b>
Z2066ECFL	66 x 36 x 30	160	7.5	<b>\$972</b>	<b>\$1194</b>	N/A	<b>\$516</b>
Z2060ECFL	60 x 36 x 30	151	6	<b>\$912</b>	<b>\$1110</b>	N/A	<b>\$431</b>
Z1684ECFL	84 x 36 x 30	175	8	<b>\$1140</b>	<b>\$1412</b>	N/A	<b>\$690</b>
Z1672ECFL	72 x 36 x 30	160	7.5	<b>\$1018</b>	<b>\$1256</b>	N/A	<b>\$516</b>
Z1666ECFL	66 x 36 x 30	153	7.5	<b>\$969</b>	<b>\$1191</b>	N/A	<b>\$516</b>
Z1660ECFL	60 x 36 x 30	147	6	<b>\$902</b>	<b>\$1100</b>	N/A	<b>\$431</b>

Extended worksurface on right. **No narrow end panel on left. Full end panel on right.** Connects to returns and bridges with 16" throat on the left. **Full end panel can be placed next to** lateral files, storage cabinets, wardrobe units, credenzas and end-shelves. Corner has one grommet. **Does not accept pencil drawers.** Shipped easy to assemble in 1 carton.

**Required specifications**

Top finish  
Top thickness/edge detail  
Base finish

**Optional specifications**

HP laminate  
Modesty type  
Grommet position or power block cut-out

**Accessories**

Pencil drawer  
Power block  
Keyboard

**LEFT EXT CORNERS (CONNECTS ON BOTH SIDES)**

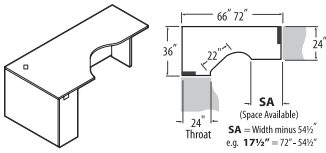

**Extended Corner, 24" Throat - LEFT**

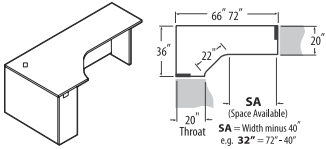

**Extended Corner, 20" Throat - LEFT**

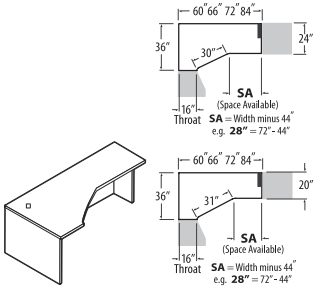

**Extended Corner, 16" Throat - LEFT**

**MODEL # DIMENSIONS WT/LB. CUBIC FT. 1" TOP 1.5" TOP GLAZE ADD HP ADD**

	W x D x H (1.5" TOP)						
Z2472NNL	72 x 36 x 30	164	7	<b>\$1311</b>	<b>\$1494</b>	N/A	<b>\$518</b>
Z2466NNL	66 x 36 x 30	156	7	<b>\$1265</b>	<b>\$1408</b>	N/A	<b>\$498</b>

Extended worksurface on right. **Narrow end panels on left and right.** Connects to 30"D space saver connectables, 30"D space saver returns, 24"D returns or 24"D connectable tables or "D" and "P" islands with "T" or "H" bases on either end. **Full end panel can be placed next to** lateral files, storage cabinets, wardrobe units, credenzas and end-shelves. Corner has one grommet. Shipped easy to assemble in 1 carton.

- Modesty panel is 1" off of ground.
- **Z2466NNL cannot accept pedestals.**

Z2072NNL	72 x 36 x 30	157	7	<b>\$1290</b>	<b>\$1491</b>	N/A	<b>\$518</b>
Z2066NNL	66 x 36 x 30	150	7	<b>\$1247</b>	<b>\$1410</b>	N/A	<b>\$498</b>

Extended worksurface on right. **Narrow end panels on left and right.** Connects to 24"D space saver connectables and 20"D returns, bridges or "D" and "P" islands with "T" or "H" bases one either end. **Full end panel can be placed next to** lateral files, storage cabinets, wardrobe units, credenzas and end-shelves. Corner has one grommet. Shipped easy to assemble in 1 carton.

- Modesty panel is 1" off of ground.

Z2484ECNL	84 x 36 x 30	187	8	<b>\$1113</b>	<b>\$1385</b>	N/A	<b>\$690</b>
Z2472ECNL	72 x 36 x 30	168	7.5	<b>\$993</b>	<b>\$1231</b>	N/A	<b>\$516</b>
Z2466ECNL	66 x 36 x 30	159	7.5	<b>\$942</b>	<b>\$1162</b>	N/A	<b>\$516</b>
Z2460ECNL	60 x 36 x 30	150	6	<b>\$881</b>	<b>\$1079</b>	N/A	<b>\$431</b>
Z2084ECNL	84 x 36 x 30	179	8	<b>\$1111</b>	<b>\$1383</b>	N/A	<b>\$690</b>
Z2072ECNL	72 x 36 x 30	162	7.5	<b>\$988</b>	<b>\$1225</b>	N/A	<b>\$516</b>
Z2066ECNL	66 x 36 x 30	153	7.5	<b>\$937</b>	<b>\$1159</b>	N/A	<b>\$516</b>
Z2060ECNL	60 x 36 x 30	146	6	<b>\$877</b>	<b>\$1075</b>	N/A	<b>\$431</b>

Extended worksurface on right. **No narrow end panel on left. Narrow end panel on right.** Connects to returns and bridges with 16" throat on the left. **Full end panel can be placed next to** lateral files, storage cabinets, wardrobe units, credenzas and end-shelves. Corner has one grommet. **Does not accept pencil drawers.** Shipped easy to assemble in 1 carton.

**RIGHT EXT CORNERS (DOES NOT CONNECT)**

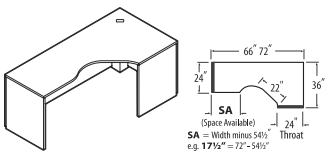

**Extended Corner, 24" Throat - RIGHT Freestanding**

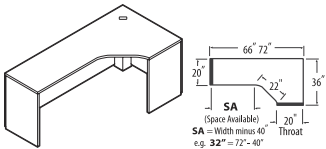

**Extended Corner, 20" Throat - RIGHT**

**W x D x H (1.5" TOP)**

Z2472FFR	72 x 36 x 30	180	7	<b>\$1356</b>	<b>\$1540</b>	N/A	<b>\$518</b>
Z2466FFR	66 x 36 x 30	172	7	<b>\$1290</b>	<b>\$1454</b>	N/A	<b>\$518</b>

Extended worksurface on left. **Full end panels on left and right. Cannot be connected on left or right, due to full end panel.** Corner has one grommet. Shipped easy to assemble in 1 carton.

- Modesty panel is 1" off of ground.
- **Z2466FFR cannot accept pedestals.**

Z2072FFR	72 x 36 x 30	168	7	<b>\$1333</b>	<b>\$1538</b>	N/A	<b>\$498</b>
Z2066FFR	66 x 36 x 30	161	7	<b>\$1290</b>	<b>\$1454</b>	N/A	<b>\$498</b>

Extended worksurface on left. **Full end panels on left and right. Can be placed next to** lateral files, storage cabinets, wardrobe units, credenzas and end-shelves. Corner has one grommet. Shipped easy to assemble in 1 carton.

- Modesty panel is 1" off of ground.

**Required specifications**

Top finish  
Top thickness/edge detail  
Base finish

**Optional specifications**

HP laminate  
Modesty type  
Grommet position or power block cut-out

**Accessories**

Pencil drawer  
Power block  
Keyboard

**RIGHT EXT CORNERS (CONNECTS ON THROAT SIDE)**

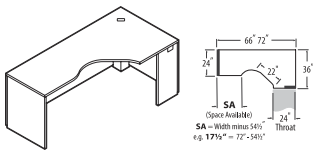

**Extended Corner, 24" Throat - RIGHT**

MODEL #	DIMENSIONS W x D x H (1.5" TOP)	WT/LB.	CUBIC FT.	1" TOP	1.5" TOP	GLAZE ADD	HP ADD
Z2472FNR	72 x 36 x 30	172	7	<b>\$1333</b>	<b>\$1517</b>	N/A	<b>\$518</b>
Z2466FNR	66 x 36 x 30	164	7	<b>\$1290</b>	<b>\$1431</b>	N/A	<b>\$518</b>

Extended worksurface on left. **Narrow end panel on right. Full end panel on left.** Connects to 30"D space saver connectables, 24"D returns, 24"D connectable tables or "D" and "P" islands with "T" or "H" bases. **Full end panel can be placed next to** lateral files, storage cabinets, wardrobe units, credenzas and end-shelves. Corner has one grommet. Shipped easy to assemble in 1 carton.

- **Modesty panel is 1" off of ground.**
- **Z2466FNR cannot accept pedestals.**

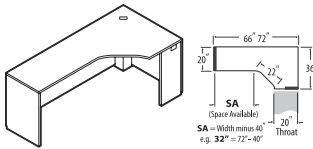

**Extended Corner, 20" Throat - RIGHT**

Z2072FNR	72 x 36 x 30	163	7	<b>\$1311</b>	<b>\$1516</b>	N/A	<b>\$518</b>
Z2066FNR	66 x 36 x 30	157	7	<b>\$1265</b>	<b>\$1429</b>	N/A	<b>\$498</b>

Extended worksurface on left. **Narrow end panel on right. Full end panel on left.** Connects to 24"D space saver connectables, 20"D returns, 20"D connectable tables or "D" and "P" islands with "T" or "H" bases. **Full end panel can be placed next to** lateral files, storage cabinets, wardrobe units, credenzas and end-shelves. Corner has one grommet. Shipped easy to assemble in 1 carton.

- **Modesty panel is 1" off of ground.**
- **FNR end panels can be switched to make NFR.**

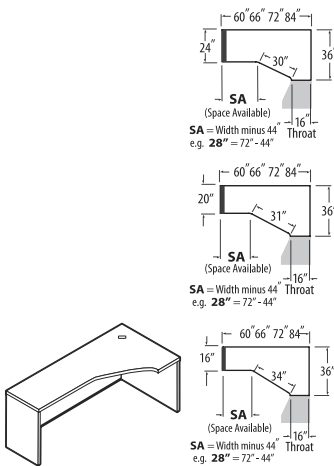

**Extended Corner, 16" Throat - RIGHT**

Z2484ECFR	84 x 36 x 30	196	8	<b>\$1147</b>	<b>\$1418</b>	N/A	<b>\$690</b>
Z2472ECFR	72 x 36 x 30	176	7.5	<b>\$1025</b>	<b>\$1262</b>	N/A	<b>\$516</b>
Z2466ECFR	66 x 36 x 30	168	7.5	<b>\$976</b>	<b>\$1196</b>	N/A	<b>\$516</b>
Z2460ECFR	60 x 36 x 30	159	6	<b>\$928</b>	<b>\$1130</b>	N/A	<b>\$431</b>
Z2084ECFR	84 x 36 x 30	185	8	<b>\$1144</b>	<b>\$1416</b>	N/A	<b>\$690</b>
Z2072ECFR	72 x 36 x 30	168	7.5	<b>\$1022</b>	<b>\$1259</b>	N/A	<b>\$516</b>
Z2066ECFR	66 x 36 x 30	160	7.5	<b>\$972</b>	<b>\$1194</b>	N/A	<b>\$516</b>
Z2060ECFR	60 x 36 x 30	151	6	<b>\$912</b>	<b>\$1110</b>	N/A	<b>\$431</b>
Z1684ECFR	84 x 36 x 30	175	8	<b>\$1140</b>	<b>\$1412</b>	N/A	<b>\$690</b>
Z1672ECFR	72 x 36 x 30	160	7.5	<b>\$1018</b>	<b>\$1256</b>	N/A	<b>\$516</b>
Z1666ECFR	66 x 36 x 30	153	7.5	<b>\$969</b>	<b>\$1191</b>	N/A	<b>\$516</b>
Z1660ECFR	60 x 36 x 30	147	6	<b>\$902</b>	<b>\$1100</b>	N/A	<b>\$431</b>

Extended worksurface on left. **No narrow end panel on right. Full end panel on left.** Connects to returns and bridges with 16" throat on the right. **Full end panel can be placed next to** lateral files, storage cabinets, wardrobe units, credenzas and end-shelves. Corner has one grommet. **Does not accept pencil drawers.** Shipped easy to assemble in 1 carton.

**RIGHT EXT CORNERS (CONNECTS ON EXTENDED SIDE)**

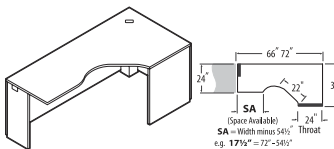

**Extended Corner, 24" Throat - RIGHT**

MODEL #	DIMENSIONS W x D x H (1.5" TOP)	WT/LB.	CUBIC FT.	1" TOP	1.5" TOP	GLAZE ADD	HP ADD
Z2472NFR	72 x 36 x 30	172	7	<b>\$1333</b>	<b>\$1517</b>	N/A	<b>\$518</b>
Z2466NFR	66 x 36 x 30	164	7	<b>\$1290</b>	<b>\$1431</b>	N/A	<b>\$498</b>

Extended worksurface on left. **Narrow end panel on left. Full end panel on right.** Connects to 30"D space saver connectables, 24"D returns, 24"D connectable tables, or "D" and "P" islands with "T" or "H" bases. **Full end panel can be placed next to** lateral files, storage cabinets, wardrobe units, credenzas and end-shelves. Corner has one grommet. Shipped easy to assemble in 1 carton.

- **Modesty panel is 1" off of ground.**
- **Z2466NFR cannot accept pedestals.**

**Required specifications**

Top finish  
Top thickness/edge detail  
Base finish

**Optional specifications**

HP laminate  
Modesty type  
Grommet position or power block cut-out

**Accessories**

Pencil drawer  
Power block  
Keyboard

RIGHT EXTENDED CORNERS (CONNECTS ON EXTENDED SIDE)

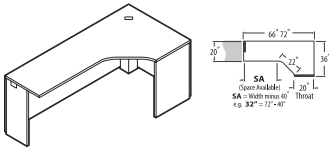

Right Extended Corner, 20" Throat

MODEL #	DIMENSIONS	WT/LB.	CUBIC FT.	1" TOP	1.5" TOP	GLAZE ADD	HP ADD
<b>W x D x H (1.5" TOP)</b>							
Z2072NFR	72 x 36 x 30	163	7	<b>\$1311</b>	<b>\$1516</b>	N/A	<b>\$518</b>
Z2066NFR	66 x 36 x 30	157	7	<b>\$1265</b>	<b>\$1429</b>	N/A	<b>\$498</b>

Extended worksurface on left. **Narrow end panel on left. Full end panel on right.** Connects to 24"D space saver connectables, 20"D returns or "D" and "P" islands with "T" or "H" bases. **Full end panel can be placed next to** lateral files, storage cabinets, wardrobe units, credenzas and end-shelves. Corner has one grommet. Shipped easy to assemble in 1 carton.

- **Modesty panel is 1" off of ground.**
- *NFR end panels can be switched to make FNR.*

RIGHT EXTENDED CORNERS (CONNECTS ON BOTH SIDES)

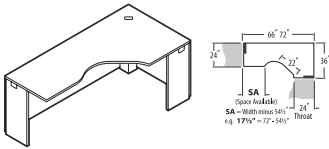

Right Extended Corner, 24" Throat

MODEL #	DIMENSIONS	WT/LB.	CUBIC FT.	1" TOP	1.5" TOP	GLAZE ADD	HP ADD
<b>W x D x H (1.5" TOP)</b>							
Z2472NNR	72 x 36 x 30	164	7	<b>\$1311</b>	<b>\$1494</b>	N/A	<b>\$518</b>
Z2466NNR	66 x 36 x 30	156	7	<b>\$1265</b>	<b>\$1408</b>	N/A	<b>\$498</b>

Extended worksurface on left. **Narrow end panels on left and right.** Connects to 30"D space saver connectables, 30"D space saver returns, 24"D returns, 24"D connectable tables or "D" and "P" islands with "T" or "H" bases on either end. Corner has one grommet. Shipped easy to assemble in 1 carton.

- **Modesty panel is 1" off of ground.**
- *Z2466NNR cannot accept pedestals.*

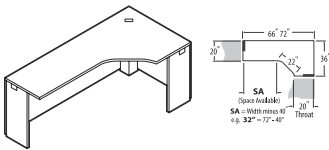

Right Extended Corner, 20" Throat

Z2072NNR	72 x 36 x 30	157	7	<b>\$1290</b>	<b>\$1491</b>	N/A	<b>\$518</b>
Z2066NNR	66 x 36 x 30	150	7	<b>\$1247</b>	<b>\$1410</b>	N/A	<b>\$498</b>

Extended worksurface on left. **Narrow end panels on left and right.** Connects to 24"D space saver connectables and 20"D returns, bridges or "D" and "P" islands with "T" or "H" bases one either end. **Full end panel can be placed next to** lateral files, storage cabinets, wardrobe units, credenzas and end-shelves. Corner has one grommet. Shipped easy to assemble in 1 carton.

- **Modesty panel is 1" off of ground.**

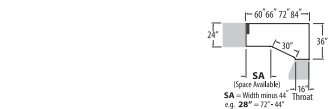

Right Extended Corner, 16" Throat

Z2484ECNR	84 x 36 x 30	187	8	<b>\$1113</b>	<b>\$1385</b>	N/A	<b>\$690</b>
Z2472ECNR	72 x 36 x 30	168	7.5	<b>\$993</b>	<b>\$1231</b>	N/A	<b>\$516</b>
Z2466ECNR	66 x 36 x 30	159	7.5	<b>\$942</b>	<b>\$1162</b>	N/A	<b>\$516</b>
Z2460ECNR	60 x 36 x 30	150	6	<b>\$881</b>	<b>\$1079</b>	N/A	<b>\$431</b>
Z2084ECNR	84 x 36 x 30	179	8	<b>\$1111</b>	<b>\$1383</b>	N/A	<b>\$690</b>
Z2072ECNR	72 x 36 x 30	162	7.5	<b>\$988</b>	<b>\$1225</b>	N/A	<b>\$516</b>
Z2066ECNR	66 x 36 x 30	153	7.5	<b>\$937</b>	<b>\$1159</b>	N/A	<b>\$516</b>
Z2060ECNR	60 x 36 x 30	146	6	<b>\$877</b>	<b>\$1075</b>	N/A	<b>\$431</b>

Extended worksurface on left. **No narrow end panel on right. Narrow end panel on left.** Connects to returns and bridges with 16" throat on the right. **Full end panel can be placed next to** lateral files, storage cabinets, wardrobe units, credenzas and end-shelves. Corner has one grommet. **Does not accept pencil drawers.** Shipped easy to assemble in 1 carton.

Required specifications

Top finish  
Top thickness/edge detail  
Base finish

Optional specifications

HP laminate  
Modesty type  
Grommet position or power block cut-out

Accessories

Pencil drawer  
Power block  
Keyboard

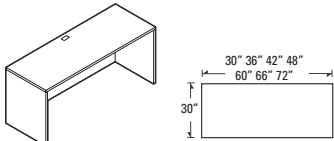
FREESTANDING TABLES	MODEL #	DIMENSIONS	WT/LB.	CUBIC FT.	1" TOP	1.5" TOP	GLAZE ADD	HP ADD
	Z3072T	72 x 29.7 x 30	197	6	<b>\$1003</b>	<b>\$1172</b>	N/A	<b>\$484</b>
	Z3066T	66 x 29.7 x 30	183	6	<b>\$949</b>	<b>\$1118</b>	N/A	<b>\$444</b>
	Z3060T	60 x 29.7 x 30	169	5.25	<b>\$911</b>	<b>\$1065</b>	N/A	<b>\$444</b>
	Z3048T	48 x 29.7 x 30	142	5.25	<b>\$845</b>	<b>\$979</b>	N/A	<b>\$380</b>
	Z3042T	42 x 29.7 x 30	129	5.25	<b>\$799</b>	<b>\$921</b>	N/A	<b>\$345</b>
	Z3036T	36 x 29.7 x 30	116	4.3	<b>\$766</b>	<b>\$871</b>	N/A	<b>\$311</b>
	Z3030T	30 x 29.7 x 30	104	3.6	<b>\$740</b>	<b>\$817</b>	N/A	<b>\$278</b>

30" Deep Freestanding Table\*

**Two full end panels. Cannot be connected on left or right side.** Grommet in worksurface.  
 Shipped easy to assemble in 1 carton.  
 • Modesty panel is 1" off of ground.

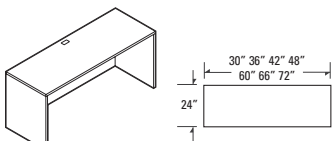

24" Deep Freestanding Table\*

Z2472T	72 x 24 x 30	173	6	<b>\$902</b>	<b>\$1069</b>	N/A	<b>\$345</b>
Z2466T	66 x 24 x 30	160	6	<b>\$857</b>	<b>\$1012</b>	N/A	<b>\$330</b>
Z2460T	60 x 24 x 30	147	5.25	<b>\$814</b>	<b>\$953</b>	N/A	<b>\$330</b>
Z2448T	48 x 24 x 30	123	4.3	<b>\$783</b>	<b>\$894</b>	N/A	<b>\$263</b>
Z2442T	42 x 24 x 30	112	4.3	<b>\$719</b>	<b>\$818</b>	N/A	<b>\$222</b>
Z2436T	36 x 24 x 30	100	4.2	<b>\$715</b>	<b>\$772</b>	N/A	<b>\$167</b>
Z2430T	30 x 24 x 30	89	3.6	<b>\$677</b>	<b>\$719</b>	N/A	<b>\$167</b>

**Two full end panels. Cannot be connected on left or right side.** Grommet in worksurface.  
 Shipped easy to assemble in 1 carton.  
 • Modesty panel is 1" off of ground.

CONNECTABLE TABLES - LEFT

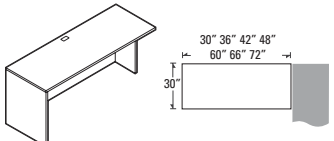

30" Deep Connectable Table - LEFT

	W x D x H (1.5" TOP)						
Z3072L	72 x 29.7 x 30	189	6	<b>\$1003</b>	<b>\$1172</b>	N/A	<b>\$484</b>
Z3066L	66 x 29.7 x 30	175	6	<b>\$949</b>	<b>\$1118</b>	N/A	<b>\$444</b>
Z3060L	60 x 29.7 x 30	161	5.25	<b>\$911</b>	<b>\$1065</b>	N/A	<b>\$444</b>
Z3048L	48 x 29.7 x 30	134	4.3	<b>\$845</b>	<b>\$979</b>	N/A	<b>\$380</b>
Z3042L	42 x 29.7 x 30	121	4.3	<b>\$799</b>	<b>\$921</b>	N/A	<b>\$345</b>
Z3036L	36 x 29.7 x 30	108	4.2	<b>\$762</b>	<b>\$870</b>	N/A	<b>\$311</b>
Z3030L	30 x 29.7 x 30	96	3.6	<b>\$750</b>	<b>\$818</b>	N/A	<b>\$278</b>

**Full end panel on left.** Right narrow end panel connects to 30"D center/right connectable table, or at 90° angle to a freestanding table; and "D" islands or "P" islands with "T" and "H" bases. Grommet in worksurface.  
 Shipped easy to assemble in 1 carton.  
 • Modesty panel is 1" off of ground.

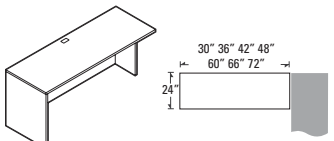

24" Deep Connectable Table - LEFT

Z2472L	72 x 24 x 30	164	6	<b>\$902</b>	<b>\$1069</b>	N/A	<b>\$345</b>
Z2466L	66 x 24 x 30	152	6	<b>\$857</b>	<b>\$1012</b>	N/A	<b>\$330</b>
Z2460L	60 x 24 x 30	139	5.25	<b>\$827</b>	<b>\$952</b>	N/A	<b>\$330</b>
Z2448L	48 x 24 x 30	115	4.3	<b>\$783</b>	<b>\$894</b>	N/A	<b>\$263</b>
Z2442L	42 x 24 x 30	103	3.8	<b>\$719</b>	<b>\$818</b>	N/A	<b>\$222</b>
Z2436L	36 x 24 x 30	92	3.3	<b>\$705</b>	<b>\$770</b>	N/A	<b>\$167</b>
Z2430L	30 x 24 x 30	80	3.6	<b>\$677</b>	<b>\$719</b>	N/A	<b>\$167</b>

**Full end panel on left.** Right narrow end panel connects to 24"D center/right connectable table, or at 90° angle to a freestanding table; 24"D extended corners or at the end of a straight run; "D" islands or "P" islands with "T" and "H" bases. Grommet in worksurface. Shipped easy to assemble in 1 carton.  
 • Modesty panel is 1" off of ground.

Required specifications	Optional specifications	Accessories
Top finish	HP laminate	Pencil drawer
Top thickness/edge detail	Modesty type	Power block
Base finish	Grommet position or power block cut-out	Keyboard*

CONNECTABLE TABLES - RIGHT

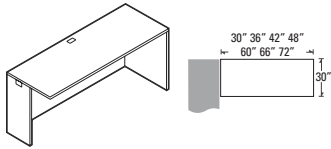

30" Deep Connectable Table - RIGHT

MODEL #	DIMENSIONS	WT/LB.	CUBIC FT.	1" TOP	1.5" TOP	GLAZE ADD	HP ADD
W x D x H (1.5" TOP)							
Z3072R	72 x 29.7 x 30	189	6	\$1003	\$1172	N/A	\$484
Z3066R	66 x 29.7 x 30	175	6	\$949	\$1118	N/A	\$444
Z3060R	60 x 29.7 x 30	161	5.25	\$911	\$1065	N/A	\$444
Z3048R	48 x 29.7 x 30	134	4.3	\$845	\$979	N/A	\$380
Z3042R	42 x 29.7 x 30	121	4.3	\$799	\$921	N/A	\$345
Z3036R	36 x 29.7 x 30	108	4.2	\$762	\$870	N/A	\$311
Z3030R	30 x 29.7 x 30	96	3.6	\$750	\$818	N/A	\$278

**Full end panel on right.** Left narrow end panel connects to **30"D** center/right connectable table, or at 90° angle to a freestanding table; and "D" islands or "P" islands with "T" and "H" bases. Grommet in worksurface. Shipped easy to assemble in 1 carton.

- Modesty panel is 1" off of ground.

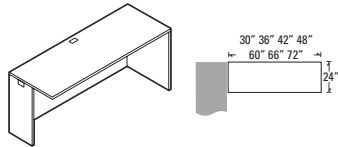

24" Deep Connectable Table - RIGHT

Z2472R	72 x 24 x 30	164	6	\$902	\$1069	N/A	\$345
Z2466R	66 x 24 x 30	152	6	\$857	\$1012	N/A	\$330
Z2460R	60 x 24 x 30	139	5.25	\$827	\$952	N/A	\$330
Z2448R	48 x 24 x 30	115	4.3	\$783	\$894	N/A	\$263
Z2442R	42 x 24 x 30	103	3.8	\$719	\$818	N/A	\$222
Z2436R	36 x 24 x 30	92	3.3	\$705	\$770	N/A	\$167
Z2430R	30 x 24 x 30	80	3.6	\$677	\$719	N/A	\$167

**Full end panel on right.** Left narrow end panel connects to **24"D** center/right connectable table, or at 90° angle to a freestanding table; 24"D extended corners or at the end of a straight run; "D" islands or "P" islands with "T" and "H" bases. Grommet in worksurface. Shipped easy to assemble in 1 carton.

- Modesty panel is 1" off of ground.

CONNECTABLE TABLES

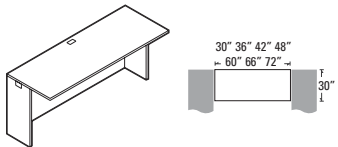

30" Deep Connectable Table

W x D x H (1.5" TOP)							
Z3072N	72 x 29.7 x 30	181	6	\$1003	\$1172	N/A	\$484
Z3066N	66 x 29.7 x 30	167	6	\$949	\$1118	N/A	\$444
Z3060N	60 x 29.7 x 30	153	5.25	\$911	\$1065	N/A	\$444
Z3048N	48 x 29.7 x 30	126	4.3	\$851	\$959	N/A	\$380
Z3042N	42 x 29.7 x 30	113	3.8	\$829	\$921	N/A	\$345
Z3036N	36 x 29.7 x 30	100	3.3	\$762	\$850	N/A	\$311
Z3030N	30 x 29.7 x 30	88	3.6	\$711	\$799	N/A	\$278

**Narrow end panels on both sides** connect to **30"D** worksurfaces, "D" islands or "P" islands with "T" and "H" bases; or at 90° angle to freestanding table(s). Grommet in worksurface. Shipped easy to assemble in 1 carton.

- Modesty panel is 1" off of ground.

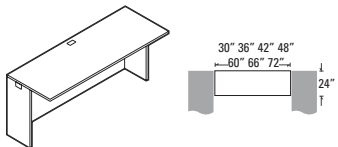

24" Deep Connectable Table

Z2472N	72 x 24 x 30	156	6	\$902	\$1057	N/A	\$345
Z2466N	66 x 24 x 30	143	6	\$857	\$1003	N/A	\$330
Z2460N	60 x 24 x 30	131	4.5	\$833	\$952	N/A	\$330
Z2448N	48 x 24 x 30	106	4.3	\$759	\$870	N/A	\$263
Z2442N	42 x 24 x 30	95	3.8	\$719	\$818	N/A	\$222
Z2436N	36 x 24 x 30	83	3.3	\$677	\$739	N/A	\$167
Z2430N	30 x 24 x 30	72	3.6	\$639	\$687	N/A	\$167

**Narrow end panels on both sides** connect to **24"D** worksurfaces, "D" islands or "P" islands with "T" and "H" bases; or at 90° angle to freestanding table(s). Grommet in worksurface. Shipped easy to assemble in 1 carton.

- Modesty panel is 1" off of ground.

Required specifications

Top finish  
Top thickness/edge detail  
Base finish

Optional specifications

HP laminate  
Modesty type  
Grommet position or power block cut-out

Accessories

Pencil drawer  
Power block  
Keyboard



**SPACE SAVER CONNECTABLE TABLES**      **MODEL #**      **DIMENSIONS**      **WT/LB.**      **CUBIC FT.**      **1" TOP**      **1.5" TOP**      **GLAZE ADD**      **HP ADD**

	<b>W x D x H (1.5" TOP)</b>							
Z3072LK	72 x 29.7 x 30		185	6	<b>\$1049</b>	<b>\$1223</b>	N/A	<b>\$484</b>
Z3066LK	66 x 29.7 x 30		171	6	<b>\$1003</b>	<b>\$1167</b>	N/A	<b>\$444</b>
Z3060LK	60 x 29.7 x 30		157	5.25	<b>\$955</b>	<b>\$1111</b>	N/A	<b>\$444</b>
Z3048LK	48 x 29.7 x 30		130	4.3	<b>\$887</b>	<b>\$1021</b>	N/A	<b>\$380</b>
Z3042LK	42 x 29.7 x 30		117	3.8	<b>\$831</b>	<b>\$952</b>	N/A	<b>\$345</b>
Z3036LK	36 x 29.7 x 30		104	4.3	<b>\$809</b>	<b>\$915</b>	N/A	<b>\$311</b>
Z3030LK	30 x 29.7 x 30		91	3.6	<b>\$774</b>	<b>\$840</b>	N/A	<b>\$278</b>

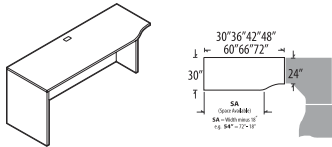

**30" Deep Space Saver Connectable Table - LEFT**

**Full end panel on left.** Narrow right end panel connects to any corner unit with a 24" throat. Grommet in worksurface.  
Shipped easy to assemble in 1 carton.  
• Modesty panel is 1" off of ground.

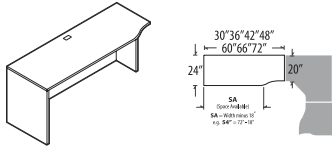

**24" Deep Space Saver Connectable Table - LEFT**

Z2472LK	72 x 24 x 30		164	6	<b>\$949</b>	<b>\$1158</b>	N/A	<b>\$345</b>
Z2466LK	66 x 24 x 30		152	6	<b>\$902</b>	<b>\$1057</b>	N/A	<b>\$330</b>
Z2460LK	60 x 24 x 30		139	5.25	<b>\$864</b>	<b>\$992</b>	N/A	<b>\$330</b>
Z2448LK	48 x 24 x 30		115	4.3	<b>\$810</b>	<b>\$938</b>	N/A	<b>\$263</b>
Z2442LK	42 x 24 x 30		103	3.8	<b>\$783</b>	<b>\$882</b>	N/A	<b>\$222</b>
Z2436LK	36 x 24 x 30		92	3.3	<b>\$740</b>	<b>\$801</b>	N/A	<b>\$167</b>
Z2430LK	30 x 24 x 30		80	3.6	<b>\$705</b>	<b>\$742</b>	N/A	<b>\$167</b>

**Full end panel on left.** Narrow right end panel connects to any corner unit with a 20" throat. Grommet in worksurface.  
Shipped easy to assemble in 1 carton.  
• Modesty panel is 1" off of ground.

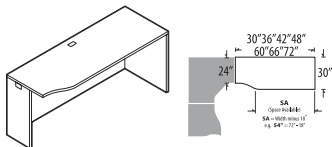

**30" Deep Space Saver Connectable Table - RIGHT**

Z3072RK	72 x 29.7 x 30		185	6	<b>\$1049</b>	<b>\$1223</b>	N/A	<b>\$484</b>
Z3066RK	66 x 29.7 x 30		171	6	<b>\$1003</b>	<b>\$1167</b>	N/A	<b>\$444</b>
Z3060RK	60 x 29.7 x 30		157	5.25	<b>\$955</b>	<b>\$1111</b>	N/A	<b>\$444</b>
Z3048RK	48 x 29.7 x 30		130	4.3	<b>\$887</b>	<b>\$1021</b>	N/A	<b>\$380</b>
Z3042RK	42 x 29.7 x 30		117	3.8	<b>\$831</b>	<b>\$952</b>	N/A	<b>\$345</b>
Z3036RK	36 x 29.7 x 30		104	4.3	<b>\$809</b>	<b>\$915</b>	N/A	<b>\$311</b>
Z3030RK	30 x 29.7 x 30		91	3.6	<b>\$774</b>	<b>\$840</b>	N/A	<b>\$278</b>

**Full end panel on right.** Narrow left end panel connects to any corner unit with a 24" throat. Grommet in worksurface.  
Shipped easy to assemble in 1 carton.  
• Modesty panel is 1" off of ground.

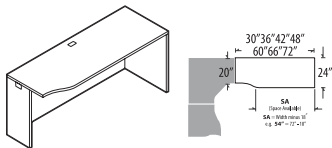

**24" Deep Space Saver Connectable Table - RIGHT**

Z2472RK	72 x 24 x 30		164	6	<b>\$949</b>	<b>\$1158</b>	N/A	<b>\$345</b>
Z2466RK	66 x 24 x 30		152	6	<b>\$902</b>	<b>\$1057</b>	N/A	<b>\$330</b>
Z2460RK	60 x 24 x 30		139	5.25	<b>\$864</b>	<b>\$992</b>	N/A	<b>\$330</b>
Z2448RK	48 x 24 x 30		115	4.3	<b>\$810</b>	<b>\$938</b>	N/A	<b>\$263</b>
Z2442RK	42 x 24 x 30		103	3.8	<b>\$783</b>	<b>\$882</b>	N/A	<b>\$222</b>
Z2436RK	36 x 24 x 30		92	3.3	<b>\$740</b>	<b>\$801</b>	N/A	<b>\$167</b>
Z2430RK	30 x 24 x 30		80	3.6	<b>\$705</b>	<b>\$742</b>	N/A	<b>\$167</b>

**Full end panel on right.** Narrow left end panel connects to any corner unit with a 20" throat. Grommet in worksurface.  
Shipped easy to assemble in 1 carton.  
• Modesty panel is 1" off of ground.

**Required specifications**

- Top finish
- Top thickness/edge detail
- Base finish

**Optional specifications**

- HP laminate
- Modesty type
- Grommet position or power block cut-out

**Accessories**

- Pencil drawer
- Power block
- Keyboard

SPACE SAVER CONNECTABLE TABLES

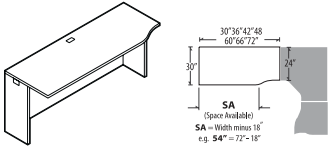

30" Deep Space Saver Connectable Table

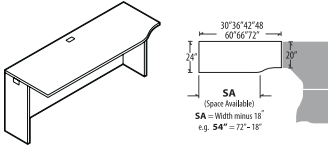

24" Deep Space Saver Connectable Table

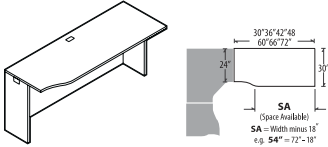

30" Deep Space Saver Connectable Table

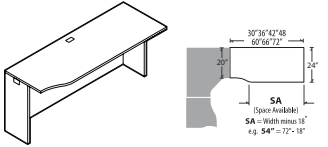

24" Deep Space Saver Connectable Table

MODEL #	DIMENSIONS	WT/LB.	CUBIC FT.	1" TOP	1.5" TOP	GLAZE ADD	HP ADD
W x D x H (1.5" TOP)							
Z3072LN	72 x 29.7 x 30	177	6	\$1049	\$1223	N/A	\$484
Z3066LN	66 x 29.7 x 30	163	6	\$1003	\$1167	N/A	\$444
Z3060LN	60 x 29.7 x 30	148	5.25	\$955	\$1111	N/A	\$444
Z3048LN	48 x 29.7 x 30	122	4.3	\$884	\$989	N/A	\$380
Z3042LN	42 x 29.7 x 30	109	3.8	\$847	\$938	N/A	\$345
Z3036LN	36 x 29.7 x 30	96	3.3	\$795	\$883	N/A	\$311
Z3030LN	30 x 29.7 x 30	83	3.6	\$740	\$827	N/A	\$278

**Narrow end panels on both sides.** Connects the **right end only** to any corner unit with a 24" throat. Left end allows the continuation of additional 30" connectable center or left connectable worksurface. Grommet in worksurface.

Shipped easy to assemble in 1 carton.

- Modesty panel is 1" off of ground.

Z2472LN	72 x 24 x 30	156	6	\$931	\$1097	N/A	\$345
Z2466LN	66 x 24 x 30	143	6	\$902	\$1046	N/A	\$330
Z2460LN	60 x 24 x 30	131	5.25	\$845	\$972	N/A	\$330
Z2448LN	48 x 24 x 30	106	4.3	\$783	\$894	N/A	\$263
Z2442LN	42 x 24 x 30	95	3.8	\$765	\$862	N/A	\$222
Z2436LN	36 x 24 x 30	83	3.3	\$711	\$777	N/A	\$167
Z2430LN	30 x 24 x 30	72	3.6	\$677	\$719	N/A	\$167

**Narrow end panels on both sides.** Connects the **right end only** to any corner unit with a 24" throat. Left end allows the continuation of additional 24" connectable center or left connectable worksurface. Grommet in worksurface.

Shipped easy to assemble in 1 carton.

- Modesty panel is 1" off of ground.

Z3072RN	72 x 29.7 x 30	177	6	\$1049	\$1223	N/A	\$484
Z3066RN	66 x 29.7 x 30	163	6	\$1003	\$1167	N/A	\$444
Z3060RN	60 x 29.7 x 30	148	5.25	\$955	\$1111	N/A	\$444
Z3048RN	48 x 29.7 x 30	122	4.3	\$884	\$989	N/A	\$380
Z3042RN	42 x 29.7 x 30	109	3.8	\$847	\$938	N/A	\$345
Z3036RN	36 x 29.7 x 30	96	3.3	\$795	\$883	N/A	\$311
Z3030RN	30 x 29.7 x 30	83	3.6	\$740	\$827	N/A	\$278

**Narrow end panels on both sides.** Connects the **left end only** to any corner unit with a 24" throat. Right end allows the continuation of additional 30" connectable center or right connectable worksurface. Grommet in worksurface.

Shipped easy to assemble in 1 carton.

- Modesty panel is 1" off of ground.

Z2472RN	72 x 24 x 30	156	6	\$931	\$1097	N/A	\$345
Z2466RN	66 x 24 x 30	143	6	\$902	\$1046	N/A	\$330
Z2460RN	60 x 24 x 30	131	5.25	\$845	\$972	N/A	\$330
Z2448RN	48 x 24 x 30	106	4.3	\$783	\$894	N/A	\$263
Z2442RN	42 x 24 x 30	95	3.8	\$765	\$862	N/A	\$222
Z2436RN	36 x 24 x 30	83	3.3	\$711	\$777	N/A	\$167
Z2430RN	30 x 24 x 30	72	3.6	\$677	\$719	N/A	\$167

**Narrow end panels on both sides.** Connects the **left end only** to any corner unit with a 20" throat. Right end allows the continuation of additional 30" connectable center or right connectable worksurface. Grommet in worksurface.

Shipped easy to assemble in 1 carton.

- Modesty panel is 1" off of ground.

**Required specifications**

- Top finish
- Top thickness/edge detail
- Base finish

**Optional specifications**

- HP laminate
- Modesty type
- Grommet position or power block cut-out

**Accessories**

- Pencil drawer
- Power block
- Keyboard

EXT CORNER ISLANDS	MODEL #	DIMENSIONS	WT/LB.	CUBIC FT.	1" TOP	1.5" TOP	GLAZE ADD	HP ADD
--------------------	---------	------------	--------	-----------	--------	----------	-----------	--------

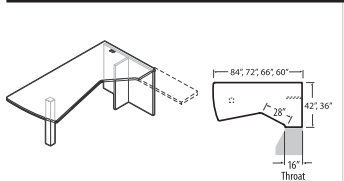

**Extended Corner Island Full End Panel & Post (T-Base) - LEFT**

	W x D x H (1.5" TOP)							
Z4284EDTL	84 x 42 x 30	181	10.75	<b>\$1159</b>	<b>\$1462</b>	N/A	<b>\$919</b>	
Z4272EDTL	72 x 42 x 30	165	9.5	<b>\$1088</b>	<b>\$1358</b>	N/A	<b>\$690</b>	
Z3672EDTL	72 x 36 x 30	140	8.75	<b>\$993</b>	<b>\$1178</b>	N/A	<b>\$516</b>	
Z3666EDTL	66 x 36 x 30	133	8.75	<b>\$952</b>	<b>\$1136</b>	N/A	<b>\$516</b>	
Z3660EDTL	60 x 36 x 30	127	6.5	<b>\$904</b>	<b>\$1089</b>	N/A	<b>\$431</b>	

Extended island worksurface on **left**. Connects to returns or bridges with a 16" throat on the right. **Not freestanding.** Grommet in worksurface. Shipped easy to assemble in 2 cartons.  
 • Post is shipped in separate carton.

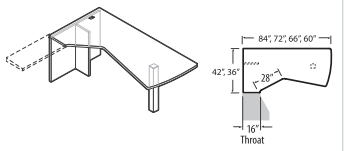

**Extended Corner Island Full End Panel & Post (T-Base) - RIGHT**

Z4284EDTR	84 x 42 x 30	181	10.75	<b>\$1159</b>	<b>\$1462</b>	N/A	<b>\$919</b>	
Z4272EDTR	72 x 42 x 30	165	9.5	<b>\$1088</b>	<b>\$1358</b>	N/A	<b>\$690</b>	
Z3672EDTR	72 x 36 x 30	140	8.75	<b>\$993</b>	<b>\$1178</b>	N/A	<b>\$516</b>	
Z3666EDTR	66 x 36 x 30	133	8.75	<b>\$952</b>	<b>\$1136</b>	N/A	<b>\$516</b>	
Z3660EDTR	60 x 36 x 30	127	6.5	<b>\$904</b>	<b>\$1089</b>	N/A	<b>\$431</b>	

Extended island worksurface on **right**. Connects to returns or bridges with a 16" throat on the left. **Not freestanding.** Grommet in worksurface. Shipped easy to assemble in 2 cartons.  
 • Post is shipped in separate carton.

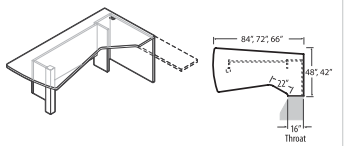

**Extended Corner Island Faux Pedestal and Post - LEFT\***

Z4884EDFL	84 x 48 x 30	214	12	<b>\$1449</b>	<b>\$1788</b>	<b>\$656</b>	<b>\$919</b>	
Z4872EDFL	72 x 48 x 30	192	10.5	<b>\$1344</b>	<b>\$1637</b>	<b>\$542</b>	<b>\$690</b>	
Z4284EDFL	84 x 42 x 30	187	10.75	<b>\$1362</b>	<b>\$1666</b>	<b>\$656</b>	<b>\$919</b>	
Z4272EDFL	72 x 42 x 30	168	8.75	<b>\$1263</b>	<b>\$1526</b>	<b>\$542</b>	<b>\$690</b>	
Z4266EDFL	66 x 42 x 30	159	8.75	<b>\$1216</b>	<b>\$1462</b>	<b>\$484</b>	<b>\$690</b>	

Extended island worksurface on **left**. Connects to returns or bridges with a 16" throat on the right. **Not freestanding.** Faux pedestal on the **right** is ideal for concealing a CPU. ¾ modesty panel is standard. Grommet in worksurface. Shipped easy to assemble in 2 cartons.

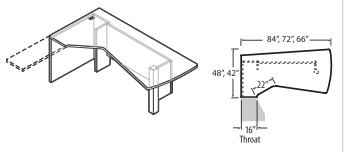

**Extended Corner Island Faux Pedestal and Post - RIGHT\***

Z4884EDFR	84 x 48 x 30	214	12	<b>\$1449</b>	<b>\$1788</b>	<b>\$656</b>	<b>\$919</b>	
Z4872EDFR	72 x 48 x 30	192	10.5	<b>\$1344</b>	<b>\$1637</b>	<b>\$542</b>	<b>\$690</b>	
Z4284EDFR	84 x 42 x 30	187	10.75	<b>\$1362</b>	<b>\$1666</b>	<b>\$656</b>	<b>\$919</b>	
Z4272EDFR	72 x 42 x 30	168	8.75	<b>\$1263</b>	<b>\$1526</b>	<b>\$542</b>	<b>\$690</b>	
Z4266EDFR	66 x 42 x 30	159	8.75	<b>\$1216</b>	<b>\$1462</b>	<b>\$484</b>	<b>\$690</b>	

Extended island worksurface on **right**. Connects to returns or bridges with a 16" throat on the left. **Not freestanding.** Faux pedestal on the **left** is ideal for concealing a CPU. ¾ modesty panel is standard. Grommet in worksurface. Shipped easy to assemble in 2 cartons.

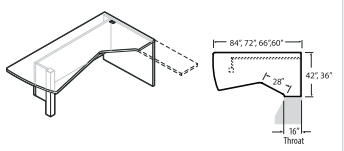

**Extended Corner Island Recessed Modesty and Post - LEFT\***

Z4284EDRL	84 x 42 x 30	199	10.75	<b>\$1286</b>	<b>\$1590</b>	<b>\$768</b>	<b>\$919</b>	
Z4272EDRL	72 x 42 x 30	180	9.5	<b>\$1208</b>	<b>\$1474</b>	<b>\$702</b>	<b>\$690</b>	
Z3672EDRL	72 x 36 x 30	154	8.75	<b>\$1068</b>	<b>\$1294</b>	<b>\$702</b>	<b>\$516</b>	
Z3666EDRL	66 x 36 x 30	144	8.75	<b>\$1029</b>	<b>\$1239</b>	<b>\$645</b>	<b>\$516</b>	
Z3660EDRL	60 x 36 x 30	136	6.5	<b>\$988</b>	<b>\$1183</b>	<b>\$589</b>	<b>\$431</b>	

Extended island worksurface on **left**. Connects to returns or bridges with a 16" throat on the right. **Not freestanding.** Grommet in worksurface. ¾ **recessed** modesty panel is standard. Shipped easy to assemble in 2 cartons.



Required specifications	Optional specifications	Accessories
Top finish	HP laminate	Pencil drawer
Top thickness/edge detail	Grommet position or power block cut-out	Power block
Base finish	Modesty finish glazed*	Keyboard
Monopost style/finish		

EXT CORNER ISLANDS

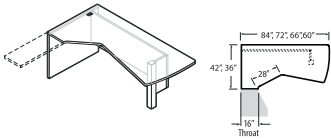

**Extended Corner Island  
Recessed Modesty and Post - RIGHT\***

MODEL #	DIMENSIONS W x D x H (1.5" TOP)	WT/LB.	CUBIC FT.	1" TOP	1.5" TOP	GLAZE ADD	HP ADD
Z4284EDRR	84 x 42 x 30	199	10.75	<b>\$1286</b>	<b>\$1590</b>	<b>\$768</b>	<b>\$919</b>
Z4272EDRR	72 x 42 x 30	180	9.5	<b>\$1208</b>	<b>\$1474</b>	<b>\$702</b>	<b>\$690</b>
Z3672EDRR	72 x 36 x 30	154	8.75	<b>\$1068</b>	<b>\$1294</b>	<b>\$702</b>	<b>\$516</b>
Z3666EDRR	66 x 36 x 30	144	8.75	<b>\$1029</b>	<b>\$1239</b>	<b>\$645</b>	<b>\$516</b>
Z3660EDRR	60 x 36 x 30	136	6.5	<b>\$988</b>	<b>\$1183</b>	<b>\$589</b>	<b>\$431</b>

Extended island worksurface on **right**. Connects to returns or bridges with a 16" throat on the left. **Not freestanding.** Grommet in worksurface. **¾ recessed** modesty panel is standard. Shipped easy to assemble in 2 cartons.

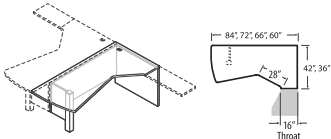

**Extended Corner Island  
Flush Modesty and Post - LEFT\***

Z4284EDML	84 x 42 x 30	209	10.75	<b>\$1302</b>	<b>\$1606</b>	<b>\$768</b>	<b>\$919</b>
Z4272EDML	72 x 42 x 30	184	9.5	<b>\$1220</b>	<b>\$1486</b>	<b>\$702</b>	<b>\$690</b>
Z3672EDML	72 x 36 x 30	159	8.75	<b>\$1080</b>	<b>\$1304</b>	<b>\$702</b>	<b>\$516</b>
Z3666EDML	66 x 36 x 30	150	8.75	<b>\$1035</b>	<b>\$1269</b>	<b>\$645</b>	<b>\$516</b>
Z3660EDML	60 x 36 x 30	142	6.5	<b>\$1007</b>	<b>\$1190</b>	<b>\$589</b>	<b>\$431</b>

Extended island worksurface on **left**. Connects to returns or bridges with a 16" throat on the right. **Not freestanding.** Grommet in worksurface. **¾ flush** modesty panel is standard. Shipped easy to assemble in 2 cartons.

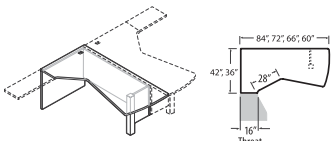

**Extended Corner Island  
Flush Modesty and Post - RIGHT\***

Z4284EDMR	84 x 42 x 30	209	10.75	<b>\$1302</b>	<b>\$1606</b>	<b>\$768</b>	<b>\$919</b>
Z4272EDMR	72 x 42 x 30	184	9.5	<b>\$1220</b>	<b>\$1486</b>	<b>\$702</b>	<b>\$690</b>
Z3672EDMR	72 x 36 x 30	159	8.75	<b>\$1080</b>	<b>\$1304</b>	<b>\$702</b>	<b>\$516</b>
Z3666EDMR	66 x 36 x 30	150	8.75	<b>\$1035</b>	<b>\$1269</b>	<b>\$645</b>	<b>\$516</b>
Z3660EDMR	60 x 36 x 30	142	6.5	<b>\$1007</b>	<b>\$1190</b>	<b>\$589</b>	<b>\$431</b>

Extended island worksurface on **right**. Connects to returns or bridges with a 16" throat on the left. **Not freestanding.** Grommet in worksurface. **¾ flush** modesty panel is standard. Shipped easy to assemble in 2 cartons.



EXT CORNER "P" ISLANDS

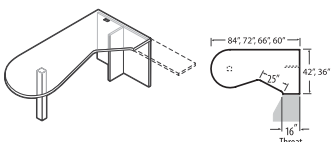

**Extended Corner "P" Island  
Full End Panel & Post (T-Base) - LEFT**

MODEL #	DIMENSIONS W x D x H (1.5" TOP)	WT/LB.	CUBIC FT.	1" TOP	1.5" TOP	GLAZE ADD	HP ADD
Z4284EPTL	84 x 42 x 30	179	10.75	<b>\$1151</b>	<b>\$1454</b>	N/A	<b>\$919</b>
Z3684EPTL	84 x 36 x 30	153	9.5	<b>\$1059</b>	<b>\$1327</b>	N/A	<b>\$690</b>
Z3672EPTL	72 x 36 x 30	145	8.75	<b>\$976</b>	<b>\$1175</b>	N/A	<b>\$516</b>
Z3666EPTL	66 x 36 x 30	139	8.75	<b>\$936</b>	<b>\$1149</b>	N/A	<b>\$516</b>
Z3660EPTL	60 x 36 x 30	129	6.5	<b>\$902</b>	<b>\$1100</b>	N/A	<b>\$431</b>

Extended island worksurface on **left**. Connects to returns or bridges with a 16" throat on the right. **Not freestanding.** Grommet in worksurface. Shipped easy to assemble in 2 cartons.

- Post is shipped in separate carton.

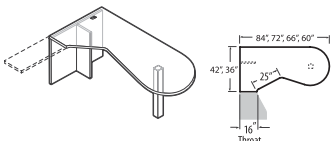

**Extended Corner "P" Island  
Full End Panel & Post (T-Base) - RIGHT**

Z4284EPTR	84 x 42 x 30	179	10.75	<b>\$1151</b>	<b>\$1454</b>	N/A	<b>\$919</b>
Z3684EPTR	84 x 36 x 30	153	9.5	<b>\$1059</b>	<b>\$1327</b>	N/A	<b>\$690</b>
Z3672EPTR	72 x 36 x 30	145	8.75	<b>\$976</b>	<b>\$1175</b>	N/A	<b>\$516</b>
Z3666EPTR	66 x 36 x 30	139	8.75	<b>\$936</b>	<b>\$1149</b>	N/A	<b>\$516</b>
Z3660EPTR	60 x 36 x 30	129	6.5	<b>\$902</b>	<b>\$1100</b>	N/A	<b>\$431</b>

Extended island worksurface on **right**. Connects to returns or bridges with a 16" throat on the right. **Not freestanding.** Grommet in worksurface. Shipped easy to assemble in 2 cartons.

- Post is shipped in separate carton.

**Required specifications**

Top finish  
Top thickness/edge detail  
Base finish  
Monopost style/finish

**Optional specifications**

HP laminate  
Grommet position or power block cut-out  
Modesty finish glazed\*

**Accessories**

Power block  
Keyboard

**EXT CORNER "P" ISLANDS**      **MODEL #**      **DIMENSIONS**      **WT/LB.**      **CUBIC FT.**      **1" TOP**      **1.5" TOP**      **GLAZE ADD**      **HP ADD**

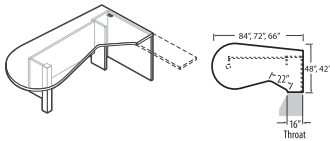

**Extended Corner "P" Island  
Faux Pedestal and Post - LEFT**

	<b>W x D x H (1.5" TOP)</b>							
Z4884EPFL	84 x 48 x 30		217	12	<b>\$1449</b>	<b>\$1787</b>	<b>\$656</b>	<b>\$919</b>
Z4872EPFL	72 x 48 x 30		194	10.5	<b>\$1343</b>	<b>\$1635</b>	<b>\$542</b>	<b>\$690</b>
Z4284EPFL	84 x 42 x 30		191	10.75	<b>\$1362</b>	<b>\$1665</b>	<b>\$656</b>	<b>\$919</b>
Z4272EPFL	72 x 42 x 30		172	8.75	<b>\$1261</b>	<b>\$1524</b>	<b>\$542</b>	<b>\$690</b>
Z4266EPFL	66 x 42 x 30		160	8.75	<b>\$1212</b>	<b>\$1452</b>	<b>\$484</b>	<b>\$690</b>

Extended island worksurface on **left**. Connects to returns or bridges with a 16" throat on the right. **Not freestanding.** Faux pedestal on the **right** is ideal for concealing a CPU. ¾ modesty panel is standard. Grommet in worksurface. Shipped easy to assemble in 2 cartons.

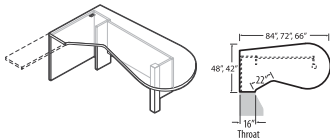

**Extended Corner "P" Island  
Faux Pedestal and Post - RIGHT**

Z4884EPFR	84 x 48 x 30		217	12	<b>\$1449</b>	<b>\$1787</b>	<b>\$656</b>	<b>\$919</b>
Z4872EPFR	72 x 48 x 30		194	10.5	<b>\$1343</b>	<b>\$1635</b>	<b>\$542</b>	<b>\$690</b>
Z4284EPFR	84 x 42 x 30		191	10.75	<b>\$1362</b>	<b>\$1665</b>	<b>\$656</b>	<b>\$919</b>
Z4272EPFR	72 x 42 x 30		172	8.75	<b>\$1261</b>	<b>\$1524</b>	<b>\$542</b>	<b>\$690</b>
Z4266EPFR	66 x 42 x 30		160	8.75	<b>\$1212</b>	<b>\$1452</b>	<b>\$484</b>	<b>\$690</b>

Extended island worksurface on **right**. Connects to returns or bridges with a 16" throat on the left. **Not freestanding.** Faux pedestal on the **left** is ideal for concealing a CPU. ¾ modesty panel is standard. Grommet in worksurface. Shipped easy to assemble in 2 cartons.

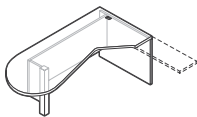

**Extended Corner "P" Island  
Recessed Modesty and Post - LEFT**

Z4284EPRL	84 x 42 x 30		200	10.75	<b>\$1283</b>	<b>\$1586</b>	<b>\$768</b>	<b>\$919</b>
Z3684EPRL	84 x 36 x 30		173	9.5	<b>\$1162</b>	<b>\$1455</b>	<b>\$768</b>	<b>\$690</b>
Z3672EPRL	72 x 36 x 30		156	8.75	<b>\$1068</b>	<b>\$1294</b>	<b>\$702</b>	<b>\$516</b>
Z3666EPRL	66 x 36 x 30		149	8.75	<b>\$1040</b>	<b>\$1253</b>	<b>\$645</b>	<b>\$516</b>
Z3660EPRL	60 x 36 x 30		141	6.5	<b>\$997</b>	<b>\$1195</b>	<b>\$589</b>	<b>\$431</b>

Extended island worksurface on **left**. Connects to returns or bridges with a 16" throat on the right. **Not freestanding.** Grommet in worksurface. ¾ **recessed** modesty panel is standard. Shipped easy to assemble in 2 cartons.

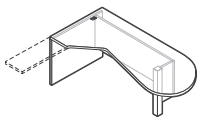
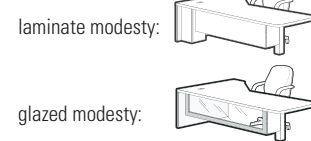
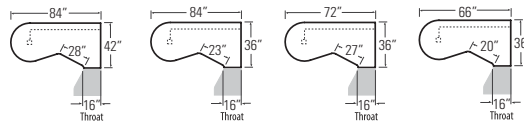

**Extended Corner "P" Island  
Recessed Modesty and Post - RIGHT**

Z4284EPRR	84 x 42 x 30		200	10.75	<b>\$1283</b>	<b>\$1586</b>	<b>\$768</b>	<b>\$919</b>
Z3684EPRR	84 x 36 x 30		173	9.5	<b>\$1162</b>	<b>\$1455</b>	<b>\$768</b>	<b>\$690</b>
Z3672EPRR	72 x 36 x 30		156	8.75	<b>\$1068</b>	<b>\$1294</b>	<b>\$702</b>	<b>\$516</b>
Z3666EPRR	66 x 36 x 30		149	8.75	<b>\$1040</b>	<b>\$1253</b>	<b>\$645</b>	<b>\$516</b>
Z3660EPRR	60 x 36 x 30		141	6.5	<b>\$997</b>	<b>\$1195</b>	<b>\$589</b>	<b>\$431</b>

Extended island worksurface on **right**. Connects to returns or bridges with a 16" throat on the left. **Not freestanding.** Grommet in worksurface. ¾ **recessed** modesty panel is standard. Shipped easy to assemble in 2 cartons.

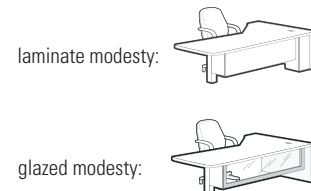
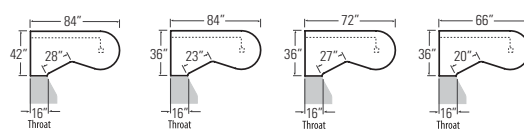

**Required specifications**

- Top finish
- Top thickness/edge detail
- Base finish
- Monopost style/finish

**Optional specifications**

- HP laminate
- Grommet position or power block cut-out
- Modesty finish glazed

**Accessories**

- Power block
- Keyboard

EXT CORNER "P" ISLANDS

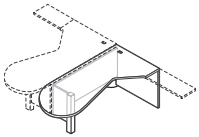

Extended Corner "P" Island  
Flush Modesty and Post - LEFT\*

MODEL #	DIMENSIONS	WT/LB.	CUBIC FT.	1" TOP	1.5" TOP	GLAZE ADD	HP ADD
<b>W x D x H (1.5" TOP)</b>							
Z4284EPML	84 x 42 x 30	200	10.75	<b>\$1299</b>	<b>\$1602</b>	<b>\$768</b>	<b>\$919</b>
Z3684EPML	84 x 36 x 30	172	9.5	<b>\$1173</b>	<b>\$1441</b>	<b>\$768</b>	<b>\$690</b>
Z3672EPML	72 x 36 x 30	156	8.75	<b>\$1079</b>	<b>\$1305</b>	<b>\$702</b>	<b>\$516</b>
Z3666EPML	66 x 36 x 30	150	8.75	<b>\$1035</b>	<b>\$1221</b>	<b>\$645</b>	<b>\$516</b>
Z3660EPML	60 x 36 x 30	141	6.5	<b>\$1003</b>	<b>\$1201</b>	<b>\$589</b>	<b>\$431</b>

Extended island worksurface on **left**. Connects to returns or bridges with a 16" throat on the right. **Not freestanding.** Grommet in worksurface.  $\frac{3}{4}$  flush modesty panel is standard. Shipped easy to assemble in 2 cartons.

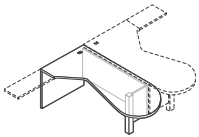
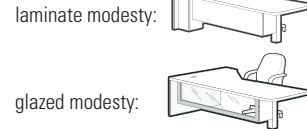
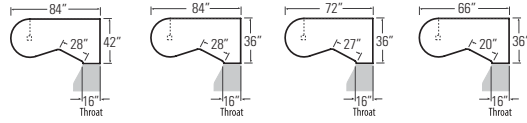

Extended Corner "P" Island  
Flush Modesty and Post - RIGHT\*

<b>W x D x H (1.5" TOP)</b>							
Z4284EPMR	84 x 42 x 30	200	10.75	<b>\$1299</b>	<b>\$1602</b>	<b>\$768</b>	<b>\$919</b>
Z3684EPMR	84 x 36 x 30	172	9.5	<b>\$1173</b>	<b>\$1441</b>	<b>\$768</b>	<b>\$690</b>
Z3672EPMR	72 x 36 x 30	156	8.75	<b>\$1079</b>	<b>\$1305</b>	<b>\$702</b>	<b>\$516</b>
Z3666EPMR	66 x 36 x 30	150	8.75	<b>\$1035</b>	<b>\$1221</b>	<b>\$645</b>	<b>\$516</b>
Z3660EPMR	60 x 36 x 30	141	6.5	<b>\$1003</b>	<b>\$1201</b>	<b>\$589</b>	<b>\$431</b>

Extended island worksurface on **right**. Connects to returns or bridges with a 16" throat on the left. **Not freestanding.** Grommet in worksurface.  $\frac{3}{4}$  flush modesty panel is standard. Shipped easy to assemble in 2 cartons.

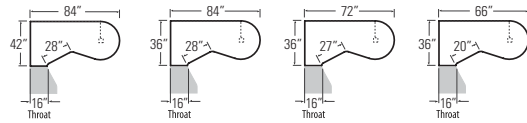

"D" ISLANDS

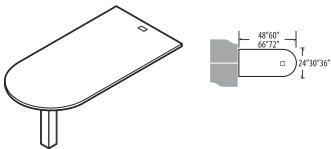

"D" Island with Monopost

MODEL #	DIMENSIONS	WT/LB.	CUBIC FT.	1" TOP	1.5" TOP	GLAZE ADD	HP ADD
<b>W x D x H (1.5" TOP)</b>							
Z3672I	72 x 36 x 30	144	8.5	<b>\$857</b>	<b>\$1070</b>	N/A	<b>\$518</b>
Z3066I	66 x 29.7 x 30	115	7.5	<b>\$790</b>	<b>\$958</b>	N/A	<b>\$444</b>
Z3060I	60 x 29.7 x 30	104	6.76	<b>\$765</b>	<b>\$921</b>	N/A	<b>\$444</b>
Z2466I	66 x 24 x 30	101	7.5	<b>\$724</b>	<b>\$868</b>	N/A	<b>\$330</b>
Z2460I	60 x 24 x 30	92	6.76	<b>\$701</b>	<b>\$828</b>	N/A	<b>\$330</b>
Z2448I	48 x 24 x 30	74	5.76	<b>\$669</b>	<b>\$780</b>	N/A	<b>\$263</b>

Attaches to edge of worksurfaces. Attaching hardware included. Includes grommet as shown. Shipped easy to assemble in 2 cartons.

- Post is shipped in separate carton.

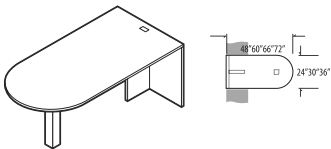

"D" Island - Full End Panel and  
Monopost (T-Base)

Z3672FI	72 x 36 x 30	123	8.5	<b>\$1062</b>	<b>\$1271</b>	N/A	<b>\$518</b>
Z3072FI	72 x 29.7 x 30	106	7.5	<b>\$1022</b>	<b>\$1195</b>	N/A	<b>\$484</b>
Z3066FI	66 x 29.7 x 30	101	7.5	<b>\$955</b>	<b>\$1123</b>	N/A	<b>\$444</b>
Z3060FI	60 x 29.7 x 30	94	6.76	<b>\$902</b>	<b>\$1057</b>	N/A	<b>\$444</b>
Z2466FI	66 x 24 x 30	90	7.5	<b>\$894</b>	<b>\$1039</b>	N/A	<b>\$330</b>
Z2460FI	60 x 24 x 30	84	6.76	<b>\$848</b>	<b>\$959</b>	N/A	<b>\$330</b>
Z2448FI	48 x 24 x 30	74	5.76	<b>\$810</b>	<b>\$922</b>	N/A	<b>\$263</b>

Attaches to edge of worksurfaces. Attaching hardware included. Includes grommet as shown. **Not freestanding.** Shipped easy to assemble in 2 cartons.

- Post is shipped in separate carton.

Required specifications

Top finish  
Top thickness/edge detail  
Base finish  
Monopost style/finish\*

Optional specifications

HP laminate  
Remove standard grommet (RSG)  
Modesty finish glazed\*

Accessories

Power block  
Keyboard\*

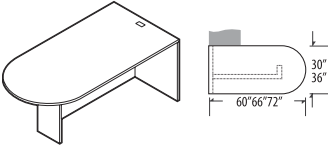
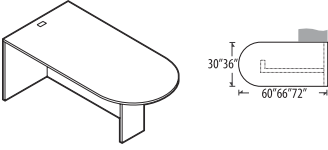
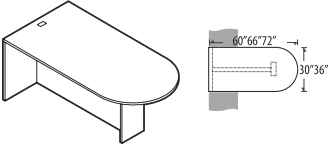
"D" ISLANDS	MODEL #	DIMENSIONS	WT/LB.	CUBIC FT.	1" TOP	1.5" TOP	GLAZE ADD	HP ADD
 <p><b>"D" Island LEFT - Full Modesty Panel (H-Base)</b></p>	Z3672FIL	72 x 36 x 30	194	7	<b>\$1064</b>	<b>\$1277</b>	N/A	<b>\$518</b>
	Z3066FIL	66 x 29.7 x 30	158	6	<b>\$983</b>	<b>\$1151</b>	N/A	<b>\$444</b>
	Z3060FIL	60 x 29.7 x 30	144	5.25	<b>\$902</b>	<b>\$1057</b>	N/A	<b>\$444</b>
 <p><b>"D" Island RIGHT - Full Modesty Panel (H-Base)</b></p>	Z3672FIR	72 x 36 x 30	194	7	<b>\$1064</b>	<b>\$1277</b>	N/A	<b>\$518</b>
	Z3066FIR	66 x 29.7 x 30	158	6	<b>\$983</b>	<b>\$1151</b>	N/A	<b>\$444</b>
	Z3060FIR	60 x 29.7 x 30	144	5.25	<b>\$902</b>	<b>\$1057</b>	N/A	<b>\$444</b>
 <p><b>"D" Island Center - Full Modesty Panel (H-Base)</b></p>	Z3672FIC	72 x 36 x 30	194	7	<b>\$1064</b>	<b>\$1277</b>	N/A	<b>\$518</b>
	Z3066FIC	66 x 29.7 x 30	158	6	<b>\$983</b>	<b>\$1151</b>	N/A	<b>\$444</b>
	Z3060FIC	60 x 29.7 x 30	144	5.25	<b>\$902</b>	<b>\$1057</b>	N/A	<b>\$444</b>

Connects to the left side of a worksurface. Attaching hardware included. Accommodates all 19" pedestals (mobile and hanging pedestals and 19.3" deep storage shells). Includes grommet as shown. Shipped easy to assemble in 1 carton.

Connects to the right side of a worksurface. Attaching hardware included. Accommodates all 19" pedestals (mobile and hanging pedestals and 19.3" deep storage shells). Includes grommet as shown. Shipped easy to assemble in 1 carton.

Connects in between two worksurfaces. Attaching hardware included. **Will not accommodate pedestals.** Includes grommet as shown. Shipped easy to assemble in 1 carton.

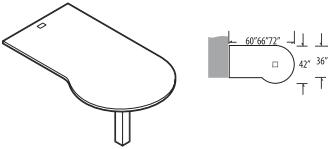
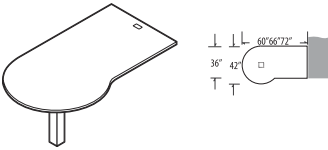
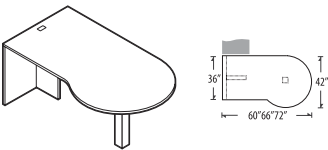
"P" ISLANDS	MODEL #	DIMENSIONS	WT/LB.	CUBIC FT.	1" TOP	1.5" TOP	GLAZE ADD	HP ADD
 <p><b>"P" Island with Post - LEFT*</b></p>	Z3672IPL	72 x 42 x 30	152	9.26	<b>\$1060</b>	<b>\$1270</b>	N/A	<b>\$692</b>
	Z3666IPL	66 x 42 x 30	137	8.76	<b>\$1014</b>	<b>\$1183</b>	N/A	<b>\$692</b>
	Z3660IPL	60 x 42 x 30	125	8	<b>\$949</b>	<b>\$1118</b>	N/A	<b>\$586</b>
 <p><b>"P" Island with Post - RIGHT*</b></p>	Z3672IPR	72 x 42 x 30	152	9.26	<b>\$1060</b>	<b>\$1270</b>	N/A	<b>\$692</b>
	Z3666IPR	66 x 42 x 30	137	8.76	<b>\$1014</b>	<b>\$1183</b>	N/A	<b>\$692</b>
	Z3660IPR	60 x 42 x 30	125	8	<b>\$949</b>	<b>\$1118</b>	N/A	<b>\$586</b>
 <p><b>"P" Island - Full End Panel and Post (T-Base) - LEFT*</b></p>	Z3672FPL	72 x 42 x 30	186	9.26	<b>\$1231</b>	<b>\$1446</b>	N/A	<b>\$692</b>
	Z3666FPL	66 x 42 x 30	173	8.76	<b>\$1198</b>	<b>\$1366</b>	N/A	<b>\$692</b>
	Z3660FPL	60 x 42 x 30	161	8	<b>\$1142</b>	<b>\$1309</b>	N/A	<b>\$586</b>

Attaches to edge of worksurfaces. Attaching hardware included. Includes grommet as shown. Shipped easy to assemble in 2 cartons.

- Post is shipped in separate carton.

Attaches to edge of worksurfaces. Attaching hardware included. Includes grommet as shown. Shipped easy to assemble in 2 cartons.

- Post is shipped in separate carton.

Connects to left side of worksurface. Attaching hardware included. **Not freestanding.** Includes grommet as shown. Shipped easy to assemble in 2 cartons.

- Post is shipped in separate carton.

**Required specifications**

- Top finish
- Top thickness/edge detail
- Base finish (not Z36xxlPL/R)
- Monopost style/finish\*

**Optional specifications**

- HP laminate
- Remove standard grommet (RSG)

**Accessories**

- Power block

"P" ISLANDS

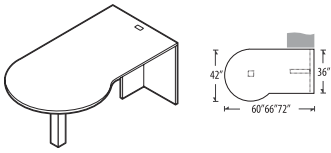

"P" Island - Full End Panel and Post (T-Base) - RIGHT\*

MODEL #	DIMENSIONS W x D x H (1.5" TOP)	WT/LB.	CUBIC FT.	1" TOP	1.5" TOP	GLAZE ADD	HP ADD
Z3672FPR	72 x 42 x 30	186	9.26	<b>\$1231</b>	<b>\$1446</b>	N/A	<b>\$692</b>
Z3666FPR	66 x 42 x 30	173	8.76	<b>\$1198</b>	<b>\$1366</b>	N/A	<b>\$692</b>
Z3660FPR	60 x 42 x 30	161	8	<b>\$1142</b>	<b>\$1309</b>	N/A	<b>\$586</b>

Connects to right side of worksurface. Attaching hardware included. **Not freestanding.** Includes grommet as shown. Shipped easy to assemble in 2 cartons.  
 • Post is shipped in separate carton.

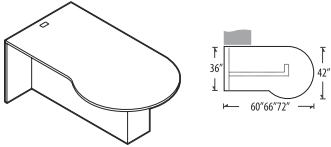

"P" Island LEFT - Full Modesty Panel (H-Base)\*

Z3672PL	72 x 42 x 30	201	7.75	<b>\$1249</b>	<b>\$1462</b>	N/A	<b>\$692</b>
Z3666PL	66 x 42 x 30	185	7.25	<b>\$1162</b>	<b>\$1330</b>	N/A	<b>\$692</b>
Z3660PL	60 x 42 x 30	170	6.5	<b>\$1092</b>	<b>\$1261</b>	N/A	<b>\$586</b>

Connects to the left side of a worksurface. Attaching hardware included. Accommodates all 19" pedestals (freestanding, mobile and hanging pedestals). Includes grommet as shown. Shipped easy to assemble in 1 carton.

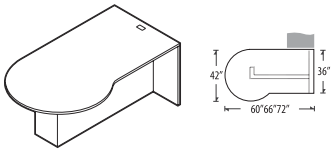

"P" Island RIGHT - Full Modesty Panel (H-Base)\*

Z3672PR	72 x 42 x 30	201	7.75	<b>\$1249</b>	<b>\$1462</b>	N/A	<b>\$692</b>
Z3666PR	66 x 42 x 30	185	7.25	<b>\$1162</b>	<b>\$1330</b>	N/A	<b>\$692</b>
Z3660PR	60 x 42 x 30	170	6.5	<b>\$1092</b>	<b>\$1261</b>	N/A	<b>\$586</b>

Connects to the right side of a worksurface. Attaching hardware included. Accommodates all 19" pedestals (freestanding, mobile and hanging pedestals). Includes grommet as shown. Shipped easy to assemble in 1 carton.

RECTANGULAR ISLANDS

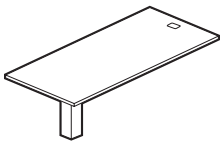

Rectangular Island w/Monopost\*\*

MODEL #	DIMENSIONS W x D x H (1.5" TOP)	WT/LB.	CUBIC FT.	1" TOP	1.5" TOP	GLAZE ADD	HP ADD
Z3672RI	72 x 36 x 30	125	7.25	<b>\$936</b>	<b>\$1170</b>	N/A	<b>\$490</b>
Z3066RI	66 x 29.7 x 30	99	6.25	<b>\$861</b>	<b>\$1045</b>	N/A	<b>\$428</b>
Z3060RI	60 x 29.7 x 30	89	5.25	<b>\$833</b>	<b>\$1005</b>	N/A	<b>\$428</b>
Z2466RI	66 x 24 x 30	84	7.5	<b>\$794</b>	<b>\$949</b>	N/A	<b>\$317</b>
Z2460RI	60 x 24 x 30	76	6.5	<b>\$766</b>	<b>\$906</b>	N/A	<b>\$317</b>
Z2448RI	48 x 24 x 30	63	5.75	<b>\$726</b>	<b>\$848</b>	N/A	<b>\$251</b>

Attaches to edge of worksurfaces. Attaching hardware included. Includes grommet as shown. **Not freestanding.** Shipped easy to assemble in 2 cartons.  
 • Post is shipped in separate carton.

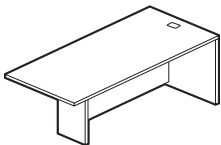

Rectangular Island LEFT - Full Modesty Panel (H-Base)\*\*

Z3672RFIL	72 x 36 x 30	180	7.25	<b>\$1168</b>	<b>\$1397</b>	N/A	<b>\$490</b>
Z3084RFIL	84 x 29.7 x 30	180	7.25	<b>\$1163</b>	<b>\$1386</b>	N/A	<b>\$490</b>
Z3066RFIL	66 x 29.7 x 30	147	6.25	<b>\$1073</b>	<b>\$1257</b>	N/A	<b>\$428</b>
Z3060RFIL	60 x 29.7 x 30	134	5.25	<b>\$987</b>	<b>\$1154</b>	N/A	<b>\$428</b>
Z2472RFIL	72 x 24 x 30	139	6.25	<b>\$920</b>	<b>\$1130</b>	N/A	<b>\$345</b>
Z2466RFIL	66 x 24 x 30	130	5.75	<b>\$879</b>	<b>\$1084</b>	N/A	<b>\$317</b>
Z2460RFIL	60 x 24 x 30	119	5.25	<b>\$822</b>	<b>\$998</b>	N/A	<b>\$317</b>
Z2448RFIL	48 x 24 x 30	101	4.2	<b>\$783</b>	<b>\$918</b>	N/A	<b>\$251</b>

Connects to the **left** side of a worksurface. Attaching hardware included. 36" and 30"D accommodates all 19" pedestals (freestanding, mobile and hanging pedestals). Includes grommet as shown. **Not freestanding.** Shipped easy to assemble in 1 carton.

Required specifications

- Top finish
- Top thickness/edge detail
- Base finish\*
- Monopost style/finish (not Z36xxPL/R/RFIL)

Optional specifications

- HP laminate
- Remove standard grommet (RSG)

Accessories

- Pencil drawer\*
- Power block\*\*
- Keyboard\*\*

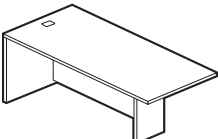

RECTANGULAR ISLANDS	MODEL #	DIMENSIONS	WT/LB.	CUBIC FT.	1" TOP	1.5" TOP	GLAZE ADD	HP ADD
		W x D x H (1.5" TOP)						
	Z3672RFIR	72 x 36 x 30	180	7.25	<b>\$1168</b>	<b>\$1397</b>	N/A	<b>\$490</b>
	Z3084RFIR	84 x 29.7 x 30	180	7.25	<b>\$1163</b>	<b>\$1386</b>	N/A	<b>\$490</b>
	Z3066RFIR	66 x 29.7 x 30	147	6.25	<b>\$1073</b>	<b>\$1257</b>	N/A	<b>\$428</b>
	Z3060RFIR	60 x 29.7 x 30	134	5.25	<b>\$987</b>	<b>\$1154</b>	N/A	<b>\$428</b>
	Z2472RFIR	72 x 24 x 30	139	6.25	<b>\$920</b>	<b>\$1130</b>	N/A	<b>\$345</b>
	Z2466RFIR	66 x 24 x 30	130	5.75	<b>\$879</b>	<b>\$1084</b>	N/A	<b>\$317</b>
	Z2460RFIR	60 x 24 x 30	119	5.25	<b>\$822</b>	<b>\$998</b>	N/A	<b>\$317</b>
	Z2448RFIR	48 x 24 x 30	101	4.2	<b>\$783</b>	<b>\$918</b>	N/A	<b>\$251</b>

**Rectangular Island RIGHT - Full Modesty Panel (H-Base)\***

Connects to the **right** side of a worksurface. Attaching hardware included. 36" and 30"D accommodates all 19" pedestals (freestanding, mobile and hanging pedestals). Includes grommet as shown. **Not freestanding.**  
Shipped easy to assemble in 1 carton.

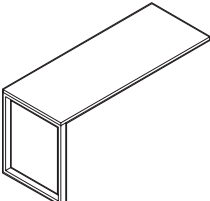
RETURNS W/METAL LEG		DIMENSIONS	WT/LB.	CUBIC FT.	1" TOP	1.5" TOP	GLAZE ADD	HP ADD
		W x D x H (1.5" TOP)						
	Z3672MRL	72 x 36 x 30	116	11.75	<b>\$1275</b>	<b>\$1505</b>	N/A	<b>\$691</b>
	Z3072MRL	72 x 30 x 30	100	10	<b>\$1169</b>	<b>\$1364</b>	N/A	<b>\$579</b>
	Z3066MRL	66 x 30 x 30	94	9.75	<b>\$1122</b>	<b>\$1300</b>	N/A	<b>\$531</b>
	Z3060MRL	60 x 30 x 30	88	9.25	<b>\$1073</b>	<b>\$1237</b>	N/A	<b>\$485</b>
	Z2472MRL	72 x 24 x 30	85	8.25	<b>\$1073</b>	<b>\$1230</b>	N/A	<b>\$461</b>
	Z2466MRL	66 x 24 x 30	80	8	<b>\$1031</b>	<b>\$1177</b>	N/A	<b>\$425</b>
	Z2460MRL	60 x 24 x 30	75	7.75	<b>\$985</b>	<b>\$1127</b>	N/A	<b>\$383</b>
	Z2448MRL	48 x 24 x 30	56	8	<b>\$849</b>	<b>\$1177</b>	N/A	<b>\$308</b>

**Return w/Metal Leg - LEFT\*\***

Flush return attaches to edge of worksurfaces. Attaching hardware included. **Not freestanding.**  
Shipped easy to assemble in 2 cartons (leg is shipped in separate carton).

- Note: Glides need to be slightly extended to accommodate the standard 29.5" height of Zira products.

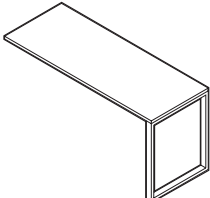
	Z3672MRR	72 x 36 x 30	116	11.75	<b>\$1275</b>	<b>\$1505</b>	N/A	<b>\$691</b>
	Z3072MRR	72 x 30 x 30	100	10	<b>\$1169</b>	<b>\$1364</b>	N/A	<b>\$579</b>
	Z3066MRR	66 x 30 x 30	94	9.75	<b>\$1122</b>	<b>\$1300</b>	N/A	<b>\$531</b>
	Z3060MRR	60 x 30 x 30	88	9.25	<b>\$1073</b>	<b>\$1237</b>	N/A	<b>\$485</b>
	Z2472MRR	72 x 24 x 30	85	8.25	<b>\$1073</b>	<b>\$1230</b>	N/A	<b>\$461</b>
	Z2466MRR	66 x 24 x 30	80	8	<b>\$1031</b>	<b>\$1177</b>	N/A	<b>\$425</b>
	Z2460MRR	60 x 24 x 30	75	7.75	<b>\$985</b>	<b>\$1127</b>	N/A	<b>\$383</b>
	Z2448MRR	48 x 24 x 30	56	5.75	<b>\$849</b>	<b>\$957</b>	N/A	<b>\$308</b>

**Return w/Metal Leg - RIGHT\*\***

Flush return attaches to edge of worksurfaces. Attaching hardware included. **Not freestanding.**  
Shipped easy to assemble in 2 cartons (leg is shipped in separate carton).

- Note: Glides need to be slightly extended to accommodate the standard 29.5" height of Zira products.

MODESTY PANELS					LIST PRICE
	Z72LMP	66 x 18.1 x 0.69	28	1.25	<b>\$338</b>
	Z66LMP	60 x 18.1 x 0.69	26	1	<b>\$319</b>
	Z60LMP	54 x 18.1 x 0.69	23	1	<b>\$297</b>
	Z48LMP	42 x 18.1 x 0.69	19	0.75	<b>\$251</b>

**Laminate Modesty Panel**

**For returns with metal leg.** Modular laminate modesty panel. Specify model number corresponding to worksurface length.

**Required specifications**

- Top finish
- Top thickness/edge detail (not ZxxLMP)
- Base finish\*
- Leg finish\*\*

**Optional specifications**

- HP laminate (not ZxxLMP)
- Remove standard grommet (RSG)\*
- Grommet position or power block cut-out\*\*

**Accessories**

- Keyboard\*
- Pencil drawer\*

**MOBILE PEDESTALS**



**Mobile Pedestal with Overhang\*\***



**Mobile Pedestal\*\***



**Mobile Pedestal with Overhang\*\***



**Mobile Pedestal\*\***

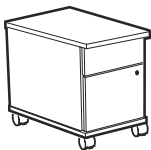

**Mobile Pedestal with Overhang\*\***

MODEL #	DIMENSIONS W x D x H	WT/LB.	CUBIC FT.	1" TOP	1.5" TOP	GLAZE ADD	HP ADD
ZMPFF28	16 x 29 x 28	106	10.25	<b>\$1400</b>	N/A	N/A	<b>\$222</b>
ZMPFF22	16 x 23 x 28	95	8.25	<b>\$1311</b>	N/A	N/A	<b>\$222</b>

**File/file** drawers on fully progressive ball bearing slides, accommodate letter/legal size hanging files. Pedestal top features 1" overhang with built-in grip for ease of mobility. Includes counterweight to prevent tipping. Drawers are locking. Only front casters are locking. Shipped assembled in 1 carton.

ZMPFF19	16 x 19 x 28	97	7.25	<b>\$1249</b>	N/A	N/A	<b>\$222</b>
---------	--------------	----	------	---------------	-----	-----	--------------

**File/file** drawers on fully progressive ball bearing slides, accommodate letter/legal size hanging files. Drawers are locking. Only front casters are locking. Includes counterweight to prevent tipping. Shipped assembled in 1 carton.

ZMPBBF28	16 x 29 x 28	105	10.25	<b>\$1326</b>	N/A	N/A	<b>\$222</b>
ZMPBBF22	16 x 23 x 28	92	8.25	<b>\$1252</b>	N/A	N/A	<b>\$222</b>

**Box/box/file** drawers on fully progressive ball bearing slides, accommodate letter/legal size hanging files. Pedestal top features 1" overhang with built-in grip for ease of mobility. Includes counterweight to prevent tipping. File drawer and lower box drawer are locking. Only front casters are locking. Shipped assembled in 1 carton.

ZMPBBF19	16 x 19 x 28	96	7.25	<b>\$1189</b>	N/A	N/A	<b>\$222</b>
----------	--------------	----	------	---------------	-----	-----	--------------

**Box/box/file** drawers on fully progressive ball bearing slides, accommodate letter/legal size hanging files. File drawer and lower box drawer are locking. Only front casters are locking. Includes counterweight to prevent tipping. Shipped assembled in 1 carton.

ZMPBF28	16 x 29 x 22	83	8.25	<b>\$1091</b>	N/A	N/A	<b>\$222</b>
ZMPBF22	16 x 23 x 22	73	6.75	<b>\$1048</b>	N/A	N/A	<b>\$222</b>

**Box/file** drawers on fully progressive ball bearing slides, accommodate letter/legal size hanging files. Pedestal top features 1" overhang with built-in grip for ease of mobility. Includes counterweight to prevent tipping. Drawers are locking. Only front casters are locking. Shipped assembled in 1 carton.

**Required specifications**

Top finish  
 Top thickness/edge detail (not pedestals)  
 Monopost style/finish\*  
 Base finish\*\*

Lock finish\*\*

**Optional specifications**

HP laminate  
 Key #\*\*  
 Handles\*\*

**MOBILE PEDESTALS**      **MODEL #**      **DIMENSIONS**      **WT/LB.**      **CUBIC FT.**      **1" TOP**      **1.5" TOP**      **GLAZE ADD**      **HP ADD**



**Mobile Pedestal\*\***

	<b>W x D x H</b>							
ZMPBF19	16 x 19 x 22	77	6.25	<b>\$983</b>	N/A	N/A	<b>\$222</b>	

**Box/file** drawers on fully progressive ball bearing slides, accommodate letter/legal size hanging files. Drawers are locking. Only front casters are locking. Includes counterweight to prevent tipping. Shipped assembled in 1 carton.

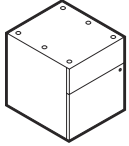

**Hanging Pedestal\*\***

ZHPBF18	16 x 19 x 18	48	4.5	<b>\$890</b>	N/A	N/A	N/A	
---------	--------------	----	-----	--------------	-----	-----	-----	--

**Box/file** drawers on fully progressive ball bearing slides, accommodate letter/legal size hanging files. Drawers are locking. Shipped assembled in 1 carton.

**STORAGE SHELLS - 16.87" HIGH**

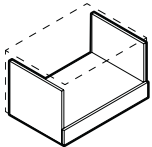

**Open Storage Shell**

Z36L21SNS	36 x 24 x 16.87	62	11.25	<b>\$718</b>	N/A	N/A	N/A	
Z30L21SNS	30 x 24 x 16.87	55	9.5	<b>\$645</b>	N/A	N/A	N/A	
Z36M21SNS	36 x 20 x 16.87	56	9.5	<b>\$660</b>	N/A	N/A	N/A	
Z30M21SNS	30 x 20 x 16.87	49	8	<b>\$592</b>	N/A	N/A	N/A	

For use **under Zxxxx1TB 17.37"H** top and back kit. **No top or back.** Shipped assembled in 1 carton.

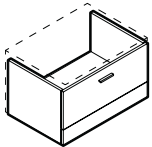

**Lateral File Shell\***

Z36L21ES	36 x 24 x 16.87	82	11.25	<b>\$1052</b>	N/A	N/A	N/A	
Z30L21ES	30 x 24 x 16.87	77	9.5	<b>\$919</b>	N/A	N/A	N/A	
Z36M21ES	36 x 20 x 16.87	78	9.5	<b>\$1014</b>	N/A	N/A	N/A	
Z30M21ES	30 x 20 x 16.87	73	8	<b>\$879</b>	N/A	N/A	N/A	

For use **under Zxxxx1TB 17.37"H** top and back kit. **No top or back.** 36" and 30" wide models have front-to-back and side-to-side letter/legal filing capability. Side-to-side file bars included. Shipped assembled in 1 carton.

- Lateral file drawer construction is for accommodating hanging files NOT for stacking materials on the drawer bottom.

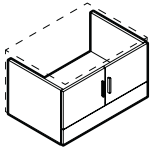

**Closed Storage Shell\*\***



Glazed door option

Z36L21SHS	36 x 24 x 16.87	71	11.25	<b>\$955</b>	N/A	<b>\$471</b>	N/A	
Z30L21SHS	30 x 24 x 16.87	62	9.5	<b>\$864</b>	N/A	<b>\$421</b>	N/A	
Z36M21SHS	36 x 20 x 16.87	65	9.5	<b>\$900</b>	N/A	<b>\$471</b>	N/A	
Z30M21SHS	30 x 20 x 16.87	57	8	<b>\$813</b>	N/A	<b>\$421</b>	N/A	

For use **under Zxxxx1TB 17.37"/17.87"H** top and back kit. **No top or back.** Laminate doors are standard. Standard with lock. Shipped assembled in 1 carton.

**Required specifications**

- Top finish\*\* (not ZHPBF18)
- Base finish
- Lock finish (only pedestals)
- Handles\*

**Optional specifications**

- HP laminate\*\* (not ZHPBF18)
- Key #
- Handles (only pedestals)

STORAGE SHELLS - 16.87" HIGH

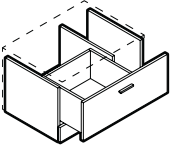

Split Drawer Storage Shell - LEFT\*\*

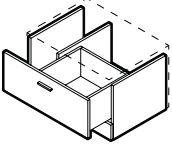

Split Drawer Storage Shell - RIGHT\*\*

MODEL #	DIMENSIONS W x D x H	WT/LB.	CUBIC FT.	1" TOP	1.5" TOP	GLAZE ADD	HP ADD
Z36L21XSL	36 x 24 x 16.87	81	11.25	<b>\$974</b>	N/A	N/A	N/A
Z30L21XSL	30 x 24 x 16.87	72	9.5	<b>\$890</b>	N/A	N/A	N/A
Z36M21XSL	36 x 20 x 16.87	78	9.5	<b>\$936</b>	N/A	N/A	N/A
Z30M21XSL	30 x 20 x 16.87	69	8	<b>\$851</b>	N/A	N/A	N/A

For use under Zxxxx1TB 17.37"/17.87"H top and back kit. **No top or back.** Pull out drawer includes filing space on **left** and storage on **right**. Front-to-back letter capability.

- File drawer construction is for accommodating hanging files **NOT** for stacking materials on the drawer bottom.

Shipped assembled in 1 carton.

Z36L21XSR	36 x 24 x 16.87	81	11.25	<b>\$974</b>	N/A	N/A	N/A
Z30L21XSR	30 x 24 x 16.87	72	9.5	<b>\$890</b>	N/A	N/A	N/A
Z36M21XSR	36 x 20 x 16.87	78	9.5	<b>\$936</b>	N/A	N/A	N/A
Z30M21XSR	30 x 20 x 16.87	69	8	<b>\$851</b>	N/A	N/A	N/A

For use under Zxxxx1TB 17.37"/17.87"H top and back kit. **No top or back.** Pull out drawer includes filing space on **right** and storage on **left**. Front-to-back letter capability. Shipped assembled in 1 carton.

- File drawer construction is for accommodating hanging files **NOT** for stacking materials on the drawer bottom.

TOP AND BACK KITS FOR 16.87" H STORAGE SHELLS

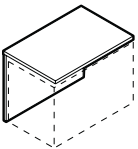

Credenza Top and Back Kit\*

	W x D x H (1.5 TOP)						
Z24961TB	96 x 24 x 17.87	104	6.75	<b>\$903</b>	<b>\$1102</b>	N/A	<b>\$631</b>
Z24901TB	90 x 24 x 17.87	97	6.25	<b>\$858</b>	<b>\$1045</b>	N/A	<b>\$592</b>
Z24841TB	84 x 24 x 17.87	91	6	<b>\$805</b>	<b>\$979</b>	N/A	<b>\$552</b>
Z24781TB	78 x 24 x 17.87	86	5.5	<b>\$756</b>	<b>\$916</b>	N/A	<b>\$514</b>
Z24721TB	72 x 24 x 17.87	78	5.25	<b>\$701</b>	<b>\$851</b>	N/A	<b>\$473</b>
Z24661TB	66 x 24 x 17.87	72	4.75	<b>\$648</b>	<b>\$787</b>	N/A	<b>\$436</b>
Z24601TB	60 x 24 x 17.87	66	4.5	<b>\$595</b>	<b>\$719</b>	N/A	<b>\$395</b>
Z24541TB	54 x 24 x 17.87	59	4	<b>\$539</b>	<b>\$651</b>	N/A	<b>\$355</b>
Z24481TB	48 x 24 x 17.87	55	3.75	<b>\$494</b>	<b>\$593</b>	N/A	<b>\$316</b>
Z24421TB	42 x 24 x 17.87	47	3.25	<b>\$437</b>	<b>\$525</b>	N/A	<b>\$276</b>
Z24361TB	36 x 24 x 17.87	40	3	<b>\$378</b>	<b>\$454</b>	N/A	<b>\$237</b>
Z24301TB	30 x 24 x 17.87	34	2.5	<b>\$328</b>	<b>\$391</b>	N/A	<b>\$198</b>
Z20961TB	96 x 20 x 17.87	93	6	<b>\$831</b>	<b>\$997</b>	N/A	<b>\$527</b>
Z20901TB	90 x 20 x 17.87	86	5.5	<b>\$780</b>	<b>\$934</b>	N/A	<b>\$494</b>
Z20841TB	84 x 20 x 17.87	80	5.25	<b>\$734</b>	<b>\$878</b>	N/A	<b>\$461</b>
Z20781TB	78 x 20 x 17.87	76	4.75	<b>\$693</b>	<b>\$827</b>	N/A	<b>\$428</b>
Z20721TB	72 x 20 x 17.87	69	4.5	<b>\$639</b>	<b>\$763</b>	N/A	<b>\$395</b>
Z20661TB	66 x 20 x 17.87	64	4.25	<b>\$592</b>	<b>\$705</b>	N/A	<b>\$361</b>
Z20601TB	60 x 20 x 17.87	58	3.75	<b>\$545</b>	<b>\$650</b>	N/A	<b>\$329</b>
Z20541TB	54 x 20 x 17.87	53	3.5	<b>\$497</b>	<b>\$589</b>	N/A	<b>\$296</b>
Z20481TB	48 x 20 x 17.87	50	3.25	<b>\$455</b>	<b>\$539</b>	N/A	<b>\$263</b>
Z20421TB	42 x 20 x 17.87	42	2.75	<b>\$402</b>	<b>\$474</b>	N/A	<b>\$231</b>
Z20361TB	36 x 20 x 17.87	35	2.5	<b>\$344</b>	<b>\$407</b>	N/A	<b>\$198</b>
Z20301TB	30 x 20 x 17.87	28	2.25	<b>\$298</b>	<b>\$349</b>	N/A	<b>\$166</b>

For use with 16.87" high storage shells. Shipped ready to assemble in 1 carton.

Required specifications

- Top finish\*
- Top/edge detail\*
- Base finish
- Handles\*\*

Optional specifications

- HP laminate\*
- Key #\*\*
- Glazed doors (only Z3xx21SHS)

STORAGE SHELLS - 22.75" HIGH

MODEL # DIMENSIONS WT/LB. CUBIC FT. 1" TOP 1.5" TOP GLAZE ADD HP ADD

W x D x H

Z36L2HSHNS	36 x 24 x 22.75	83	14.5	<b>\$891</b>	N/A	N/A	N/A
Z30L2HSHNS	30 x 24 x 22.75	75	12.25	<b>\$805</b>	N/A	N/A	N/A
Z24L2HSHNS	24 x 24 x 22.75	66	10	<b>\$715</b>	N/A	N/A	N/A
Z36M2HSHNS	36 x 20 x 22.75	73	12.25	<b>\$813</b>	N/A	N/A	N/A
Z30M2HSHNS	30 x 20 x 22.75	64	10.5	<b>\$724</b>	N/A	N/A	N/A
Z24M2HSHNS	24 x 20 x 22.75	55	8.5	<b>\$648</b>	N/A	N/A	N/A

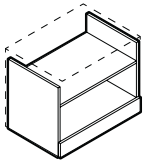

1.5H Open Storage Shell

For use under **ZxxxxHTB 23.25"/23.75"H** top and back kit. **No top or back.** Shipped assembled in 1 carton.

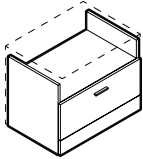

1.5H Open/Lateral File Shell\*

Z36L2HFS	36 x 24 x 22.75	102	14.5	<b>\$1224</b>	N/A	N/A	N/A
Z30L2HFS	30 x 24 x 22.75	97	12.25	<b>\$1078</b>	N/A	N/A	N/A
Z36M2HFS	36 x 20 x 22.75	95	12.25	<b>\$1164</b>	N/A	N/A	N/A
Z30M2HFS	30 x 20 x 22.75	88	10.5	<b>\$1013</b>	N/A	N/A	N/A

For use under **ZxxxxHTB 23.25"/23.75"H** top and back kit. **No top or back.** Open shelf and lateral file storage. 36" and 30" wide models have front-to-back and side-to-side letter/legal filing capability. Side-to-side file bars included. Shipped assembled in 1 carton.

- Lateral file drawer construction is for accommodating hanging files NOT for stacking materials on the drawer bottom.

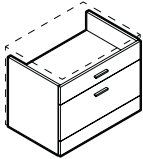

1.5H Box/Lateral File Shell\*

Z36L2HES	36 x 24 x 22.75	103	14.5	<b>\$1288</b>	N/A	N/A	N/A
Z30L2HES	30 x 24 x 22.75	99	12.25	<b>\$1142</b>	N/A	N/A	N/A
Z36M2HES	36 x 20 x 22.75	98	12.25	<b>\$1246</b>	N/A	N/A	N/A
Z30M2HES	30 x 20 x 22.75	92	10.5	<b>\$1091</b>	N/A	N/A	N/A

For use under **ZxxxxHTB 23.25"/23.75"H** top and back kit. **No top or back.** Box drawer and lateral file storage. 36" and 30" wide models have front-to-back and side-to-side letter/legal filing capability. Side-to-side file bars included. Shipped assembled in 1 carton.

- Lateral file drawer construction is for accommodating hanging files NOT for stacking materials on the drawer bottom.

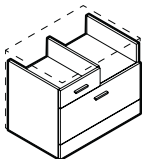

1.5H Mixed Storage Shell - LEFT\*

Z36L2HXSL	36 x 24 x 22.75	110	14.5	<b>\$1389</b>	N/A	N/A	N/A
Z30L2HXSL	30 x 24 x 22.75	105	12.25	<b>\$1244</b>	N/A	N/A	N/A
Z36M2HXSL	36 x 20 x 22.75	104	12.25	<b>\$1310</b>	N/A	N/A	N/A
Z30M2HXSL	30 x 20 x 22.75	97	10.5	<b>\$1161</b>	N/A	N/A	N/A

For use under **ZxxxxHTB 23.25"/23.75"H** top and back kit. **No top or back.** Open shelf on **right**, box drawer on **left** and lateral file storage below. 36" and 30" wide models have front-to-back and side-to-side letter/legal filing capability. Side-to-side file bars included. Shipped assembled in 1 carton.

- Lateral file drawer construction is for accommodating hanging files NOT for stacking materials on the drawer bottom.

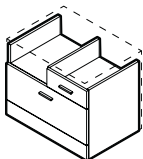

1.5H Mixed Storage Shell - RIGHT\*

Z36L2HXSR	36 x 24 x 22.75	110	14.5	<b>\$1389</b>	N/A	N/A	N/A
Z30L2HXSR	30 x 24 x 22.75	105	12.25	<b>\$1244</b>	N/A	N/A	N/A
Z36M2HXSR	36 x 20 x 22.75	104	12.25	<b>\$1310</b>	N/A	N/A	N/A
Z30M2HXSR	30 x 20 x 22.75	97	10.5	<b>\$1161</b>	N/A	N/A	N/A

For use under **ZxxxxHTB 23.25"/23.75"H** top and back kit. **No top or back.** Open shelf on **left**, box drawer on **right** and lateral file storage below. 36" and 30" wide models have front-to-back and side-to-side letter/legal filing capability. Side-to-side file bars included. Shipped assembled in 1 carton.

- Lateral file drawer construction is for accommodating hanging files NOT for stacking materials on the drawer bottom.

Required specifications

Base finish  
Handles\*

Optional specifications

Key #\*

**STORAGE SHELLS - 22.75" HIGH**

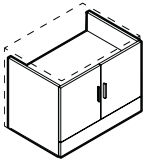

Glazed door option

**1.5H Closed Storage Shell\*\***

MODEL #	DIMENSIONS W x D x H	WT/LB.	CUBIC FT.	1" TOP	1.5" TOP	GLAZE ADD	HP ADD
Z36L2HSHS	36 x 24 x 22.75	96	14.5	<b>\$1175</b>	N/A	<b>\$589</b>	N/A
Z30L2HSHS	30 x 24 x 22.75	86	12.25	<b>\$1063</b>	N/A	<b>\$521</b>	N/A
Z36M2HSHS	36 x 20 x 22.75	86	12.25	<b>\$1098</b>	N/A	<b>\$589</b>	N/A
Z30M2HSHS	30 x 20 x 22.75	75	10.5	<b>\$982</b>	N/A	<b>\$521</b>	N/A

For use **under ZxxxxHTB 23.25"/23.75"H** top and back kit. **No top or back.** Laminate doors are standard. Standard with lock. Shipped assembled in 1 carton.

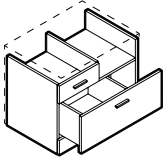

**1.5H Split Drawer Storage Shell - LEFT\*\***

Z36L2HCSL	36 x 24 x 22.75	110	14.5	<b>\$1323</b>	N/A	N/A	N/A
Z30L2HCSL	30 x 24 x 22.75	101	12.25	<b>\$1232</b>	N/A	N/A	N/A
Z36M2HCSL	36 x 20 x 22.75	104	12.25	<b>\$1244</b>	N/A	N/A	N/A
Z30M2HCSL	30 x 20 x 22.75	92	10.5	<b>\$1147</b>	N/A	N/A	N/A

For use **under ZxxxxHTB 23.25"/23.75"H** top and back kit. **No top or back.** Open shelf on **right**, box drawer on **left**. Pull out drawer includes filing space on **left** and storage on **right**. Front-to-back letter capability. Shipped assembled in 1 carton.

- File drawer construction is for accommodating hanging files **NOT** for stacking materials on the drawer bottom.

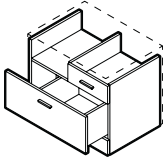

**1.5H Split Drawer Storage Shell - RIGHT\*\***

Z36L2HCSR	36 x 24 x 22.75	110	14.5	<b>\$1323</b>	N/A	N/A	N/A
Z30L2HCSR	30 x 24 x 22.75	101	12.25	<b>\$1232</b>	N/A	N/A	N/A
Z36M2HCSR	36 x 20 x 22.75	104	12.25	<b>\$1244</b>	N/A	N/A	N/A
Z30M2HCSR	30 x 20 x 22.75	92	10.5	<b>\$1147</b>	N/A	N/A	N/A

For use **under ZxxxxHTB 23.25"/23.75"H** top and back kit. **No top or back.** Open shelf on **left**, box drawer on **right**. Pull out drawer includes filing space on **right** and storage on **left**. Front-to-back letter capability. Shipped assembled in 1 carton.

- File drawer construction is for accommodating hanging files **NOT** for stacking materials on the drawer bottom.

**TOP AND BACK KITS FOR 22.75"H STORAGE SHELLS**

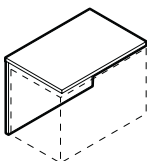

**Credenza Top and Back Kit for 22.75"H Storage Shells\***

	W x D x H (1.5 TOP)						
Z2496HTB	96 x 24 x 23.75	114	6.75	<b>\$954</b>	<b>\$1153</b>	N/A	<b>\$631</b>
Z2490HTB	90 x 24 x 23.75	107	6.25	<b>\$906</b>	<b>\$1092</b>	N/A	<b>\$592</b>
Z2484HTB	84 x 24 x 23.75	100	6	<b>\$851</b>	<b>\$1025</b>	N/A	<b>\$552</b>
Z2478HTB	78 x 24 x 23.75	94	5.5	<b>\$799</b>	<b>\$961</b>	N/A	<b>\$514</b>
Z2472HTB	72 x 24 x 23.75	87	5.25	<b>\$740</b>	<b>\$890</b>	N/A	<b>\$473</b>
Z2466HTB	66 x 24 x 23.75	80	4.75	<b>\$684</b>	<b>\$823</b>	N/A	<b>\$436</b>
Z2460HTB	60 x 24 x 23.75	72	4.5	<b>\$629</b>	<b>\$753</b>	N/A	<b>\$395</b>
Z2454HTB	54 x 24 x 23.75	65	4	<b>\$569</b>	<b>\$680</b>	N/A	<b>\$355</b>
Z2448HTB	48 x 24 x 23.75	55	3.75	<b>\$519</b>	<b>\$618</b>	N/A	<b>\$316</b>
Z2442HTB	42 x 24 x 23.75	51	3.25	<b>\$461</b>	<b>\$549</b>	N/A	<b>\$276</b>
Z2436HTB	36 x 24 x 23.75	44	3	<b>\$400</b>	<b>\$476</b>	N/A	<b>\$237</b>
Z2430HTB	30 x 24 x 23.75	37	2.5	<b>\$345</b>	<b>\$407</b>	N/A	<b>\$198</b>
Z2096HTB	96 x 20 x 23.75	103	6.25	<b>\$893</b>	<b>\$1060</b>	N/A	<b>\$527</b>
Z2090HTB	90 x 20 x 23.75	97	6	<b>\$844</b>	<b>\$999</b>	N/A	<b>\$494</b>
Z2084HTB	84 x 20 x 23.75	91	5.75	<b>\$793</b>	<b>\$937</b>	N/A	<b>\$461</b>
Z2078HTB	78 x 20 x 23.75	86	5.25	<b>\$741</b>	<b>\$875</b>	N/A	<b>\$428</b>
Z2072HTB	72 x 20 x 23.75	78	5	<b>\$692</b>	<b>\$815</b>	N/A	<b>\$395</b>
Z2066HTB	66 x 20 x 23.75	71	4.5	<b>\$634</b>	<b>\$746</b>	N/A	<b>\$361</b>
Z2060HTB	60 x 20 x 23.75	65	4.25	<b>\$584</b>	<b>\$687</b>	N/A	<b>\$329</b>
Z2054HTB	54 x 20 x 23.75	59	3.75	<b>\$531</b>	<b>\$623</b>	N/A	<b>\$296</b>
Z2048HTB	48 x 20 x 23.75	55	3.5	<b>\$486</b>	<b>\$569</b>	N/A	<b>\$263</b>
Z2042HTB	42 x 20 x 23.75	47	3	<b>\$429</b>	<b>\$504</b>	N/A	<b>\$231</b>
Z2036HTB	36 x 20 x 23.75	40	2.75	<b>\$372</b>	<b>\$434</b>	N/A	<b>\$198</b>
Z2030HTB	30 x 20 x 23.75	33	2.25	<b>\$319</b>	<b>\$370</b>	N/A	<b>\$166</b>

For use with 22.75" high storage shells. Shipped ready to assemble in 1 carton.

**Required specifications**

- Top finish\*
- Top/edge detail\*
- Base finish
- Handles\*\*

**Optional specifications**

- HP laminate\*
- Key #\*\*\*
- Glazed doors (only Z3xx2HSHS)

STORAGE SHELLS - 28.5" HIGH

MODEL #	DIMENSIONS	WT/LB.	CUBIC FT.	1" TOP	1.5" TOP	GLAZE ADD	HP ADD
---------	------------	--------	-----------	--------	----------	-----------	--------

W x D x H

Z36L2SHS	36 x 23.4 x 28.5	100	18.5	<b>\$922</b>	N/A	<b>\$723</b>	N/A
Z30L2SHS	30 x 23.4 x 28.5	88	15.5	<b>\$820</b>	N/A	<b>\$666</b>	N/A
Z36M2SHS	36 x 19.3 x 28.5	89	15.5	<b>\$807</b>	N/A	<b>\$723</b>	N/A
Z30M2SHS	30 x 19.3 x 28.5	78	13.25	<b>\$732</b>	N/A	<b>\$666</b>	N/A

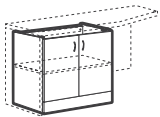

Glazed door option

Storage Shell\*

For use **under 29.5/30" H** returns, extended corners, freestanding and connectable tables of the same depth. **No top or back. One adjustable shelf.** Standard with lock. Shipped assembled in 1 carton.

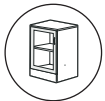
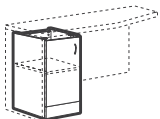

Glazed door option

Storage Shell - LEFT\*

Z21L2SHSL	21 x 23.4 x 28.5	70	11	<b>\$636</b>	N/A	<b>\$408</b>	N/A
Z18L2SHSL	18 x 23.4 x 28.5	64	9.75	<b>\$607</b>	N/A	<b>\$373</b>	N/A
Z16L2SHSL	16 x 23.4 x 28.5	60	9	<b>\$570</b>	N/A	<b>\$365</b>	N/A
Z15L2SHSL	15 x 23.4 x 28.5	59	8.25	<b>\$551</b>	N/A	<b>\$326</b>	N/A
Z12L2SHSL	12 x 23.4 x 28.5	53	6.75	<b>\$514</b>	N/A	<b>\$295</b>	N/A
Z21M2SHSL	21 x 19.3 x 28.5	61	9.5	<b>\$542</b>	N/A	<b>\$408</b>	N/A
Z18M2SHSL	18 x 19.3 x 28.5	56	8.25	<b>\$516</b>	N/A	<b>\$373</b>	N/A
Z16M2SHSL	16 x 19.3 x 28.5	52	7	<b>\$488</b>	N/A	<b>\$365</b>	N/A
Z15M2SHSL	15 x 19.3 x 28.5	52	6.75	<b>\$464</b>	N/A	<b>\$326</b>	N/A
Z12M2SHSL	12 x 19.3 x 28.5	47	5.75	<b>\$436</b>	N/A	<b>\$295</b>	N/A

For use **under 29.5/30" H** returns, extended corners, freestanding and connectable tables of the same depth. **No top or back. One adjustable shelf.** Standard with lock. Shipped assembled in 1 carton.

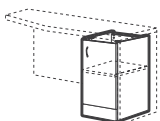

Glazed door option

Storage Shell - RIGHT\*

Z21L2SHSR	21 x 23.4 x 28.5	70	11	<b>\$636</b>	N/A	<b>\$408</b>	N/A
Z18L2SHSR	18 x 23.4 x 28.5	64	9.75	<b>\$607</b>	N/A	<b>\$373</b>	N/A
Z16L2SHSR	16 x 23.4 x 28.5	60	9	<b>\$570</b>	N/A	<b>\$365</b>	N/A
Z15L2SHSR	15 x 23.4 x 28.5	59	8.25	<b>\$551</b>	N/A	<b>\$326</b>	N/A
Z12L2SHSR	12 x 23.4 x 28.5	53	6.75	<b>\$514</b>	N/A	<b>\$295</b>	N/A
Z21M2SHSR	21 x 19.3 x 28.5	61	9.5	<b>\$542</b>	N/A	<b>\$408</b>	N/A
Z18M2SHSR	18 x 19.3 x 28.5	56	8.25	<b>\$516</b>	N/A	<b>\$373</b>	N/A
Z16M2SHSR	16 x 19.3 x 28.5	52	7	<b>\$488</b>	N/A	<b>\$365</b>	N/A
Z15M2SHSR	15 x 19.3 x 28.5	52	6.75	<b>\$464</b>	N/A	<b>\$326</b>	N/A
Z12M2SHSR	12 x 19.3 x 28.5	47	5.75	<b>\$436</b>	N/A	<b>\$295</b>	N/A

For use **under 29.5/30" H** returns, extended corners, freestanding and connectable tables of the same depth. **No top or back. One adjustable shelf.** Standard with lock. Shipped assembled in 1 carton.

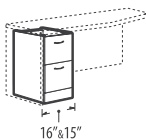
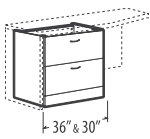

File/File Shell\*\*

Z36L2ES	36 x 23.4 x 28.5	121	18.5	<b>\$1389</b>	N/A	N/A	N/A
Z30L2ES	30 x 23.4 x 28.5	110	15.5	<b>\$1274</b>	N/A	N/A	N/A
Z16L2ES	16 x 23.4 x 28.5	75	9	<b>\$763</b>	N/A	N/A	N/A
Z15L2ES	15 x 23.4 x 28.5	75	8.25	<b>\$747</b>	N/A	N/A	N/A
Z36M2ES	36 x 19.3 x 28.5	114	15.5	<b>\$1279</b>	N/A	N/A	N/A
Z30M2ES	30 x 19.3 x 28.5	102	13.25	<b>\$1195</b>	N/A	N/A	N/A
Z16M2ES	16 x 19.3 x 28.5	69	7	<b>\$700</b>	N/A	N/A	N/A
Z15M2ES	15 x 19.3 x 28.5	68	6.75	<b>\$679</b>	N/A	N/A	N/A

For use **under 29.5/30" H** returns, extended corners, freestanding and connectable tables of the same depth. **No top or back. Two file drawers.** Lock secures all drawers. 36" and 30" wide models have front-to-back and side-to-side letter/legal filing capability. Side-to-side file bars included. Shipped assembled in 1 carton.

- 15" wide models have only side-to-side filing capability.
- Lateral file drawer construction is for accommodating hanging files NOT for stacking materials on the drawer bottom.

Required specifications

Base finish  
Handles

Optional specifications

Key #  
Box drawer - no upcharge\*\*  
Glazed door\*

STORAGE SHELLS - 28.5" HIGH

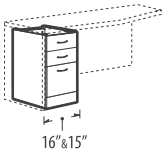

Box/Box/File Shell\*\*

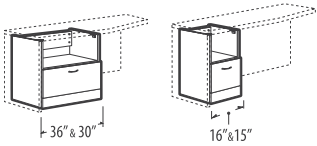

File Shell with Open Shelf\*

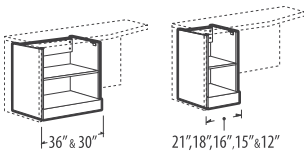

Open Shelving Shell

MODEL #	DIMENSIONS W x D x H	WT/LB.	CUBIC FT.	1" TOP	1.5" TOP	GLAZE ADD	HP ADD
Z16L2BFS	16 x 23.4 x 28.5	77	9	<b>\$881</b>	N/A	N/A	N/A
Z15L2BFS	15 x 23.4 x 28.5	77	8.25	<b>\$864</b>	N/A	N/A	N/A
Z16M2BFS	16 x 19.3 x 28.5	71	7	<b>\$798</b>	N/A	N/A	N/A
Z15M2BFS	15 x 19.3 x 28.5	71	6.75	<b>\$781</b>	N/A	N/A	N/A

For use under 29.5/30"H returns, extended corners, freestanding and connectable tables of the same depth. **No top or back. Two box and one file drawer.** One pencil tray. Lock secures all drawers. Shipped assembled in 1 carton.

- 15" wide models have only side-to-side filing capability.

Z36L2FS	36 x 23.4 x 28.5	109	18.5	<b>\$1080</b>	N/A	N/A	N/A
Z30L2FS	30 x 23.4 x 28.5	98	15.5	<b>\$970</b>	N/A	N/A	N/A
Z16L2FS	16 x 23.4 x 28.5	68	9	<b>\$645</b>	N/A	N/A	N/A
Z15L2FS	15 x 23.4 x 28.5	67	8.25	<b>\$636</b>	N/A	N/A	N/A
Z36M2FS	36 x 19.3 x 28.5	99	15.5	<b>\$958</b>	N/A	N/A	N/A
Z30M2FS	30 x 19.3 x 28.5	89	13.25	<b>\$884</b>	N/A	N/A	N/A
Z16M2FS	16 x 19.3 x 28.5	59	7	<b>\$542</b>	N/A	N/A	N/A
Z15M2FS	15 x 19.3 x 28.5	57	6.75	<b>\$532</b>	N/A	N/A	N/A

For use under 29.5/30"H returns, extended corners, freestanding and connectable tables of the same depth. **No top or back. One file drawer.** Lock secures file drawer. 36" and 30" wide models have front-to-back and side-to-side letter/legal filing capability. Side-to-side file bars included. Shipped assembled in 1 carton.

- 15" wide models have only side-to-side filing capability.
- Lateral file drawer construction is for accommodating hanging files NOT for stacking materials on the drawer bottom.

Z36L2SHSN	36 x 23.4 x 28.5	84	18.5	<b>\$658</b>	N/A	N/A	N/A
Z30L2SHSN	30 x 23.4 x 28.5	75	15.5	<b>\$582</b>	N/A	N/A	N/A
Z21L2SHSN	21 x 23.4 x 28.5	61	11	<b>\$487</b>	N/A	N/A	N/A
Z18L2SHSN	18 x 23.4 x 28.5	56	9.75	<b>\$474</b>	N/A	N/A	N/A
Z16L2SHSN	16 x 23.4 x 28.5	53	9	<b>\$437</b>	N/A	N/A	N/A
Z15L2SHSN	15 x 23.4 x 28.5	52	8.25	<b>\$428</b>	N/A	N/A	N/A
Z12L2SHSN	12 x 23.4 x 28.5	48	6.75	<b>\$398</b>	N/A	N/A	N/A
Z36M2SHSN	36 x 19.3 x 28.5	73	15.5	<b>\$546</b>	N/A	N/A	N/A
Z30M2SHSN	30 x 19.3 x 28.5	65	13.25	<b>\$491</b>	N/A	N/A	N/A
Z21M2SHSN	21 x 19.3 x 28.5	52	9.5	<b>\$395</b>	N/A	N/A	N/A
Z18M2SHSN	18 x 19.3 x 28.5	48	8.25	<b>\$382</b>	N/A	N/A	N/A
Z16M2SHSN	16 x 19.3 x 28.5	45	7	<b>\$354</b>	N/A	N/A	N/A
Z15M2SHSN	15 x 19.3 x 28.5	45	6.75	<b>\$343</b>	N/A	N/A	N/A
Z12M2SHSN	12 x 19.3 x 28.5	42	5.75	<b>\$320</b>	N/A	N/A	N/A

For use under 29.5/30"H returns, extended corners, freestanding and connectable tables of the same depth. **No top or back. One adjustable shelf.** Shipped assembled in 1 carton.

Required specifications

Base finish  
Handles

Optional specifications

Key #  
Box drawer - no upcharge\*\*



**MIXED STORAGE SHELLS - 29.5" HIGH**

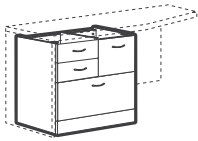

**Mixed Storage Shell - LEFT**

MODEL #	DIMENSIONS W x D x H	WT/LB.	CUBIC FT.	1" TOP	1.5" TOP	GLAZE ADD	HP ADD
Z36L2XSL	36 x 23.4 x 28.5	152	18.5	<b>\$1674</b>	N/A	N/A	N/A
Z30L2XSL	30 x 23.4 x 28.5	136	15.5	<b>\$1533</b>	N/A	N/A	N/A
Z36M2XSL	36 x 19.3 x 28.5	139	15.5	<b>\$1576</b>	N/A	N/A	N/A
Z30M2XSL	30 x 19.3 x 28.5	124	13.25	<b>\$1467</b>	N/A	N/A	N/A

For use **under 29.5/30"H** returns, extended corners, freestanding and connectable tables of the same depth. **No top or back.** Two box drawers on **left**, one file drawer on **right** accommodates letter filing side-to-side and one lateral file drawer on bottom (see filing orientation on page 120). Right lock secures two box and one file drawer, the left lock secures the lateral file. One pencil tray. Front-to-back and side-to-side letter/legal filing capability in lateral drawer, file bars included. Shipped assembled in 1 carton.

- Lateral file drawer construction is for accommodating hanging files NOT for stacking materials on the drawer bottom.
- Top file drawer supports hanging folders only, does NOT accept hanging folders with plastic tabs.

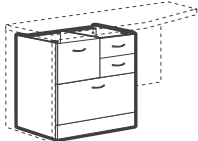

**Mixed Storage Shell - RIGHT**

Z36L2XSR	36 x 23.4 x 28.5	152	18.5	<b>\$1674</b>	N/A	N/A	N/A
Z30L2XSR	30 x 23.4 x 28.5	136	15.5	<b>\$1533</b>	N/A	N/A	N/A
Z36M2XSR	36 x 19.3 x 28.5	139	15.5	<b>\$1576</b>	N/A	N/A	N/A
Z30M2XSR	30 x 19.3 x 28.5	124	13.25	<b>\$1467</b>	N/A	N/A	N/A

For use **under 29.5/30"H** returns, extended corners, freestanding and connectable tables of the same depth. **No top or back.** Two box drawers on **right**, one file drawer on **left** accommodates letter filing side-to-side and one lateral file drawer on bottom (see filing orientation on page 120). Right lock secures two box and one file drawer, the left lock secures the lateral file. One pencil tray. Front-to-back and side-to-side letter/legal filing capability in lateral drawer, file bars included. Shipped assembled in 1 carton.

- Lateral file drawer construction is for accommodating hanging files NOT for stacking materials on the drawer bottom.
- Top file drawer supports hanging folders only, does NOT accept hanging folders with plastic tabs.

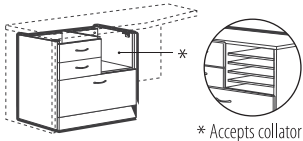

**Mixed Storage Shell with Open Shelf - LEFT\***

Z36L2XNSL	36 x 23.4 x 28.5	133	18.5	<b>\$1415</b>	N/A	N/A	N/A
Z30L2XNSL	30 x 23.4 x 28.5	121	15.5	<b>\$1286</b>	N/A	N/A	N/A
Z36M2XNSL	36 x 19.3 x 28.5	121	15.5	<b>\$1316</b>	N/A	N/A	N/A
Z30M2XNSL	30 x 19.3 x 28.5	109	13.25	<b>\$1223</b>	N/A	N/A	N/A

For use **under 29.5/30"H** returns, extended corners, freestanding and connectable tables of the same depth. **No top or back.** Two box drawers on **left**, one open shelf on **right** and one lateral file drawer on bottom. Lock secures all drawers. One pencil tray. Front-to-back and side-to-side letter/legal filing capability. Side-to-side file bars included. Shipped assembled in 1 carton.

- Lateral file drawer construction is for accommodating hanging files NOT for stacking materials on the drawer bottom.

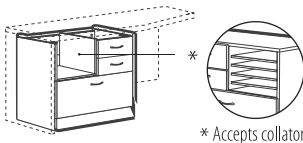

**Mixed Storage Shell with Open Shelf - RIGHT\***

Z36L2XNSR	36 x 23.4 x 28.5	133	18.5	<b>\$1415</b>	N/A	N/A	N/A
Z30L2XNSR	30 x 23.4 x 28.5	121	15.5	<b>\$1286</b>	N/A	N/A	N/A
Z36M2XNSR	36 x 19.3 x 28.5	121	15.5	<b>\$1316</b>	N/A	N/A	N/A
Z30M2XNSR	30 x 19.3 x 28.5	109	13.25	<b>\$1223</b>	N/A	N/A	N/A

For use **under 29.5/30"H** returns, extended corners, freestanding and connectable tables of the same depth. **No top or back.** Two box drawers on **right**, one open shelf on **left** and one lateral file drawer on bottom. Lock secures all drawers. One pencil tray. Front-to-back and side-to-side letter/legal filing capability. Side-to-side file bars included. Shipped assembled in 1 carton.

- Lateral file drawer construction is for accommodating hanging files NOT for stacking materials on the drawer bottom.

**Required specifications**

Base finish  
Handles

**Optional specifications**

Key #  
Box drawer - no upcharge  
Collator - position & finish\*

TOP AND BACK KITS FOR 28.5"H STORAGE SHELLS

MODEL #	DIMENSIONS	WT/LB.	CUBIC FT.	1" TOP	1.5" TOP	GLAZE ADD	HP ADD
W x D x H (1.5" TOP)							
Z2496TB	96 x 24 x 29.5	126	7.75	\$1048	\$1247	N/A	\$631
Z2490TB	90 x 24 x 29.5	118	7.25	\$989	\$1175	N/A	\$592
Z2484TB	84 x 24 x 29.5	111	6.75	\$930	\$1104	N/A	\$552
Z2478TB	78 x 24 x 29.5	104	6.25	\$866	\$1029	N/A	\$514
Z2472TB	72 x 24 x 29.5	159	6.25	\$822	\$996	N/A	\$388
Z2466TB	66 x 24 x 29.5	112	5.75	\$822	\$996	N/A	\$388
Z2460TB	60 x 24 x 29.5	381	5.25	\$720	\$836	N/A	\$383
Z2454TB	54 x 24 x 29.5	72	4.5	\$619	\$730	N/A	\$355
Z2448TB	48 x 24 x 29.5	66	4	\$565	\$664	N/A	\$316
Z2442TB	42 x 24 x 29.5	57	3.75	\$503	\$591	N/A	\$276
Z2436TB	36 x 24 x 29.5	49	3.25	\$426	\$502	N/A	\$237
Z2430TB	30 x 24 x 29.5	102	2.75	\$377	\$439	N/A	\$198
Z2096TB	96 x 20 x 29.5	116	7.75	\$988	\$1154	N/A	\$527
Z2090TB	90 x 20 x 29.5	109	7.25	\$933	\$1087	N/A	\$494
Z2084TB	84 x 20 x 29.5	102	6.75	\$875	\$1020	N/A	\$461
Z2078TB	78 x 20 x 29.5	95	6.25	\$817	\$952	N/A	\$428
Z2072TB	72 x 20 x 29.5	159	6.25	\$777	\$916	N/A	\$355
Z2066TB	66 x 20 x 29.5	81	5.5	\$777	\$916	N/A	\$355
Z2060TB	60 x 20 x 29.5	159	5.25	\$700	\$810	N/A	\$322
Z2054TB	54 x 20 x 29.5	66	4.5	\$584	\$676	N/A	\$296
Z2048TB	48 x 20 x 29.5	61	4	\$532	\$615	N/A	\$263
Z2042TB	42 x 20 x 29.5	52	3.75	\$474	\$546	N/A	\$231
Z2036TB	36 x 20 x 29.5	45	3.25	\$402	\$464	N/A	\$198
Z2030TB	30 x 20 x 29.5	38	2.75	\$355	\$407	N/A	\$166

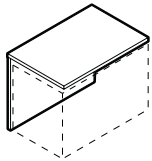

Credenza Top and Back Kits - for 28"H Storage Shells

For use with 28" high storage shells. Shipped easy to assemble in 1 carton.

**Required specifications**

Top finish  
Top thickness/edge detail  
Base finish

**Optional specifications**

HP laminate

STORAGE MODULES - 17.87"/18.37" HIGH

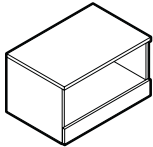

1H Open Storage

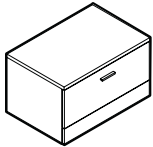

1H Lateral File\*

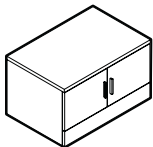

1H Storage Cabinet\*



Glazed door option

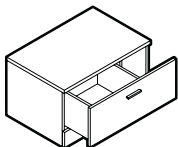

1H Split Drawer Storage - LEFT\*

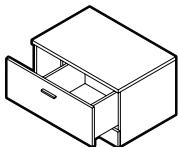

1H Split Drawer Storage - RIGHT\*

MODEL #	DIMENSIONS W x D x H (1.5" TOP)	WT/LB.	CUBIC FT.	1" TOP	1.5" TOP	GLAZE ADD	HP ADD
Z36L21SHN	36 x 24 x 18.37	82	11.75	<b>\$847</b>	<b>\$923</b>	N/A	<b>\$237</b>
Z30L21SHN	30 x 24 x 18.37	74	10	<b>\$777</b>	<b>\$840</b>	N/A	<b>\$198</b>
Z36M21SHN	36 x 20 x 18.37	71	10	<b>\$767</b>	<b>\$829</b>	N/A	<b>\$198</b>
Z30M21SHN	30 x 20 x 18.37	62	8.5	<b>\$691</b>	<b>\$743</b>	N/A	<b>\$166</b>

Open shelf. Shipped assembled in 1 carton.

Z36L21E	36 x 24 x 18.37	103	11.75	<b>\$1251</b>	<b>\$1327</b>	N/A	<b>\$237</b>
Z30L21E	30 x 24 x 18.37	97	10	<b>\$1069</b>	<b>\$1131</b>	N/A	<b>\$198</b>
Z36M21E	36 x 20 x 18.37	95	10	<b>\$1189</b>	<b>\$1251</b>	N/A	<b>\$198</b>
Z30M21E	30 x 20 x 18.37	88	8.5	<b>\$998</b>	<b>\$1049</b>	N/A	<b>\$166</b>

One file drawer. Lock secures drawer. 36" and 30" wide models have front-to-back and side-to-side letter/legal filing capability. Side-to-side file bars included. Shipped assembled in 1 carton.

- Lateral file drawer construction is for accommodating hanging files NOT for stacking materials on the drawer bottom.

Z36L21SH	36 x 24 x 18.37	90	11.75	<b>\$1085</b>	<b>\$1161</b>	<b>\$471</b>	<b>\$237</b>
Z30L21SH	30 x 24 x 18.37	81	10	<b>\$997</b>	<b>\$1059</b>	<b>\$420</b>	<b>\$198</b>
Z36M21SH	36 x 20 x 18.37	80	10	<b>\$1005</b>	<b>\$1067</b>	<b>\$471</b>	<b>\$198</b>
Z30M21SH	30 x 20 x 18.37	69	8.5	<b>\$911</b>	<b>\$962</b>	<b>\$420</b>	<b>\$166</b>

Laminate doors are standard. Standard with lock. Shipped assembled in 1 carton.

Z36L21XHL	36 x 24 x 18.37	102	11.75	<b>\$1176</b>	<b>\$1252</b>	N/A	<b>\$237</b>
Z30L21XHL	30 x 24 x 18.37	92	10	<b>\$1045</b>	<b>\$1108</b>	N/A	<b>\$198</b>
Z36M21XHL	36 x 20 x 18.37	95	10	<b>\$1113</b>	<b>\$1176</b>	N/A	<b>\$198</b>
Z30M21XHL	30 x 20 x 18.37	83	8.5	<b>\$974</b>	<b>\$1026</b>	N/A	<b>\$166</b>

Pull out drawer includes filing space on **left** and storage on **right**. Lock secures drawer. 36" and 30" wide models have front-to-back letter filing capability. Shipped assembled in 1 carton.

- File drawer construction is for accommodating hanging files NOT for stacking materials on the drawer bottom.

Z36L21XHR	36 x 24 x 18.37	102	11.75	<b>\$1176</b>	<b>\$1252</b>	N/A	<b>\$237</b>
Z30L21XHR	30 x 24 x 18.37	92	10	<b>\$1045</b>	<b>\$1108</b>	N/A	<b>\$198</b>
Z36M21XHR	36 x 20 x 18.37	95	10	<b>\$1113</b>	<b>\$1176</b>	N/A	<b>\$198</b>
Z30M21XHR	30 x 20 x 18.37	83	8.5	<b>\$974</b>	<b>\$1026</b>	N/A	<b>\$166</b>

Pull out drawer includes filing space on **right** and storage on **left**. Lock secures drawer. 36" and 30" wide models have front-to-back letter filing capability. Shipped assembled in 1 carton.

- File drawer construction is for accommodating hanging files NOT for stacking materials on the drawer bottom.

**Required specifications**

Top finish  
Top thickness/edge detail  
Base finish  
Handles\*

**Optional specifications**

HP laminate  
Key #\*  
Glazed doors (only Z3xx21SH)

STORAGE MODULES - 23.75" / 24.25" HIGH

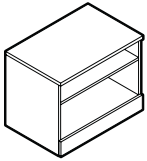

1.5H Open Storage

MODEL #	DIMENSIONS W x D x H (1.5" TOP)	WT/LB.	CUBIC FT.	1" TOP	1.5" TOP	GLAZE ADD	HP ADD
Z36L2HSHN	36 x 24 x 24.25	106	15	<b>\$1040</b>	<b>\$1116</b>	N/A	<b>\$237</b>
Z30L2HSHN	30 x 24 x 24.25	94	12.75	<b>\$944</b>	<b>\$1006</b>	N/A	<b>\$198</b>
Z36M2HSHN	36 x 20 x 24.25	92	12.75	<b>\$938</b>	<b>\$1000</b>	N/A	<b>\$198</b>
Z30M2HSHN	30 x 20 x 24.25	80	10.75	<b>\$843</b>	<b>\$894</b>	N/A	<b>\$166</b>

One adjustable shelf. Shipped assembled in 1 carton.

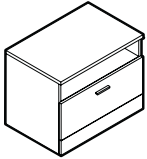

1.5H Open/Lateral File Storage\*

Z36L2HFN	36 x 24 x 24.25	127	15	<b>\$1444</b>	<b>\$1520</b>	N/A	<b>\$237</b>
Z30L2HFN	30 x 24 x 24.25	118	12.75	<b>\$1236</b>	<b>\$1299</b>	N/A	<b>\$198</b>
Z36M2HFN	36 x 20 x 24.25	116	12.75	<b>\$1360</b>	<b>\$1422</b>	N/A	<b>\$198</b>
Z30M2HFN	30 x 20 x 24.25	106	10.75	<b>\$1148</b>	<b>\$1199</b>	N/A	<b>\$166</b>

Open shelf on top. Lateral file below. Lock secures drawer. 36" and 30" wide models have front-to-back and side-to-side letter/legal filing capability. Side-to-side file bars included. Shipped assembled in 1 carton.

- Lateral file drawer construction is for accommodating hanging files NOT for stacking materials on the drawer bottom.

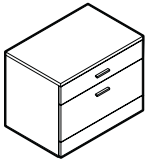

1.5H Box/Lateral File Storage\*

Z36L2HE	36 x 24 x 24.25	126	15	<b>\$1526</b>	<b>\$1603</b>	N/A	<b>\$237</b>
Z30L2HE	30 x 24 x 24.25	118	12.75	<b>\$1315</b>	<b>\$1378</b>	N/A	<b>\$198</b>
Z36M2HE	36 x 20 x 24.25	118	12.75	<b>\$1460</b>	<b>\$1523</b>	N/A	<b>\$198</b>
Z30M2HE	30 x 20 x 24.25	108	10.75	<b>\$1242</b>	<b>\$1293</b>	N/A	<b>\$166</b>

Box drawer on top. Lateral file below. Lock secures both drawers. 36" and 30" wide models have front-to-back and side-to-side letter/legal filing capability. Side-to-side file bars included. Shipped assembled in 1 carton.

- Lateral file drawer construction is for accommodating hanging files NOT for stacking materials on the drawer bottom.

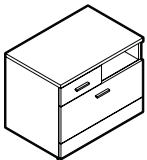

1.5H Mixed Storage - LEFT\*

Z36L2HXNL	36 x 24 x 24.25	132	15	<b>\$1580</b>	<b>\$1656</b>	N/A	<b>\$237</b>
Z30L2HXNL	30 x 24 x 24.25	123	12.75	<b>\$1370</b>	<b>\$1433</b>	N/A	<b>\$198</b>
Z36M2HXNL	36 x 20 x 24.25	121	12.75	<b>\$1497</b>	<b>\$1559</b>	N/A	<b>\$198</b>
Z30M2HXNL	30 x 20 x 24.25	111	10.75	<b>\$1286</b>	<b>\$1337</b>	N/A	<b>\$166</b>

Open shelf on **right**, box drawer on **left** and lateral file storage below. Lock secures both drawers. 36" and 30" wide models have front-to-back letter filing capability. Shipped assembled in 1 carton.

- Lateral file drawer construction is for accommodating hanging files NOT for stacking materials on the drawer bottom.

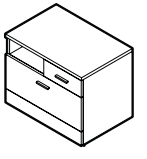

1.5H Mixed Storage - RIGHT\*

Z36L2HXNR	36 x 24 x 24.25	132	15	<b>\$1580</b>	<b>\$1656</b>	N/A	<b>\$237</b>
Z30L2HXNR	30 x 24 x 24.25	123	12.75	<b>\$1370</b>	<b>\$1433</b>	N/A	<b>\$198</b>
Z36M2HXNR	36 x 20 x 24.25	121	12.75	<b>\$1497</b>	<b>\$1559</b>	N/A	<b>\$198</b>
Z30M2HXNR	30 x 20 x 24.25	111	10.75	<b>\$1286</b>	<b>\$1337</b>	N/A	<b>\$166</b>

Open shelf on **left**, box drawer on **right** and lateral file storage below. Lock secures both drawers. 36" and 30" wide models have front-to-back letter filing capability. Shipped assembled in 1 carton.

- Lateral file drawer construction is for accommodating hanging files NOT for stacking materials on the drawer bottom.

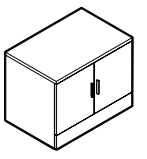

1.5H Closed Storage\*\*



Glazed door option

Z36L2HSH	36 x 24 x 24.25	119	15	<b>\$1327</b>	<b>\$1403</b>	N/A	<b>\$237</b>
Z30L2HSH	30 x 24 x 24.25	105	12.75	<b>\$1201</b>	<b>\$1264</b>	N/A	<b>\$198</b>
Z36M2HSH	36 x 20 x 24.25	105	12.75	<b>\$1223</b>	<b>\$1285</b>	N/A	<b>\$198</b>
Z30M2HSH	30 x 20 x 24.25	91	10.75	<b>\$1099</b>	<b>\$1150</b>	N/A	<b>\$166</b>

Closed storage with one adjustable shelf. Laminate doors are standard. Includes one adjustable shelf. Standard with lock. Shipped assembled in 1 carton.

**Required specifications**

Top finish  
Top thickness/edge detail  
Base finish  
Handles\*

**Optional specifications**

HP laminate  
Key #\*  
Glazed doors (only Z3xx2HSH)

**STORAGE MODULES - 23.75" / 24.25" HIGH**

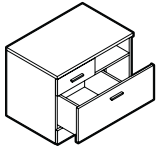

**1.5H Split Drawer Storage - LEFT**

MODEL #	DIMENSIONS W x D x H (1.5" TOP)	WT/LB.	CUBIC FT.	1" TOP	1.5" TOP	GLAZE ADD	HP ADD
Z36L2HXHL	36 x 24 x 24.25	132	15	<b>\$1516</b>	<b>\$1592</b>	N/A	<b>\$237</b>
Z30L2HXHL	30 x 24 x 24.25	118	12.75	<b>\$1362</b>	<b>\$1424</b>	N/A	<b>\$198</b>
Z36M2HXHL	36 x 20 x 24.25	121	12.75	<b>\$1432</b>	<b>\$1494</b>	N/A	<b>\$198</b>
Z30M2HXHL	30 x 20 x 24.25	107	10.75	<b>\$1275</b>	<b>\$1326</b>	N/A	<b>\$166</b>

Open shelf on **right**, box drawer on **left**. Pull out drawer includes filing space on **left** and storage on **right**.  
Shipped assembled in 1 carton.

- File drawer construction is for accommodating hanging files **NOT** for stacking materials on the drawer bottom.

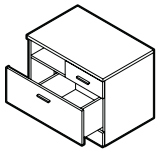

**1.5H Split Drawer Storage - RIGHT**

Z36L2HXHR	36 x 24 x 24.25	132	15	<b>\$1516</b>	<b>\$1592</b>	N/A	<b>\$237</b>
Z30L2HXHR	30 x 24 x 24.25	118	12.75	<b>\$1362</b>	<b>\$1424</b>	N/A	<b>\$198</b>
Z36M2HXHR	36 x 20 x 24.25	121	12.75	<b>\$1432</b>	<b>\$1494</b>	N/A	<b>\$198</b>
Z30M2HXHR	30 x 20 x 24.25	107	10.75	<b>\$1275</b>	<b>\$1326</b>	N/A	<b>\$166</b>

Open shelf on **left**, box drawer on **right**. Pull out drawer includes filing space on **right** and storage on **left**.  
Shipped assembled in 1 carton.

- File drawer construction is for accommodating hanging files **NOT** for stacking materials on the drawer bottom.

**STORAGE CABINET - 29.5" / 30" HIGH**

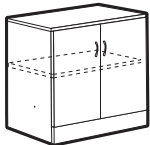

Glazed door option

**Storage Cabinet with Doors\***

Z36L2SH	36 x 24 x 30	143	18.5	<b>\$1232</b>	<b>\$1301</b>	<b>\$723</b>	<b>\$171</b>
Z30L2SH	30 x 24 x 30	124	15.5	<b>\$1110</b>	<b>\$1172</b>	<b>\$666</b>	<b>\$144</b>
Z36M2SH	36 x 20 x 30	126	15.5	<b>\$1130</b>	<b>\$1192</b>	<b>\$723</b>	<b>\$171</b>
Z30M2SH	30 x 20 x 30	109	13.25	<b>\$1024</b>	<b>\$1076</b>	<b>\$666</b>	<b>\$144</b>
Z36S2SH	36 x 16 x 30	110	12.5	<b>\$1046</b>	<b>\$1107</b>	<b>\$723</b>	<b>\$128</b>
Z30S2SH	30 x 16 x 30	93	10.5	<b>\$920</b>	<b>\$962</b>	<b>\$666</b>	<b>\$114</b>

Laminate doors are standard. **Includes one adjustable shelf.** Standard with lock. Shipped assembled in 1 carton.

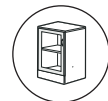
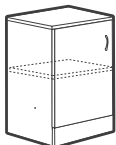

Glazed door option

**Storage Cabinet with Door - LEFT\***

Z21L2SHL	21 x 24 x 30	95	11	<b>\$902</b>	<b>\$952</b>	<b>\$408</b>	<b>\$114</b>
Z18L2SHL	18 x 24 x 30	85	9.75	<b>\$848</b>	<b>\$890</b>	<b>\$373</b>	<b>\$87</b>
Z16L2SHL	16 x 24 x 30	80	9	<b>\$815</b>	<b>\$857</b>	<b>\$365</b>	<b>\$65</b>
Z15L2SHL	15 x 24 x 30	77	8.25	<b>\$758</b>	<b>\$792</b>	<b>\$326</b>	<b>\$65</b>
Z12L2SHL	12 x 24 x 30	68	6.75	<b>\$714</b>	<b>\$744</b>	<b>\$295</b>	<b>\$57</b>
Z21M2SHL	21 x 20 x 30	84	9.5	<b>\$802</b>	<b>\$844</b>	<b>\$408</b>	<b>\$87</b>
Z18M2SHL	18 x 20 x 30	76	8.25	<b>\$759</b>	<b>\$794</b>	<b>\$373</b>	<b>\$87</b>
Z16M2SHL	16 x 20 x 30	69	7	<b>\$717</b>	<b>\$752</b>	<b>\$365</b>	<b>\$65</b>
Z15M2SHL	15 x 20 x 30	66	6.75	<b>\$682</b>	<b>\$712</b>	<b>\$326</b>	<b>\$57</b>
Z12M2SHL	12 x 20 x 30	60	5.75	<b>\$636</b>	<b>\$661</b>	<b>\$295</b>	<b>\$57</b>
Z21S2SHL	21 x 16 x 30	71	7.5	<b>\$732</b>	<b>\$765</b>	<b>\$408</b>	<b>\$57</b>
Z18S2SHL	18 x 16 x 30	64	6.75	<b>\$701</b>	<b>\$735</b>	<b>\$373</b>	<b>\$57</b>
Z16S2SHL	16 x 16 x 30	59	6	<b>\$671</b>	<b>\$705</b>	<b>\$365</b>	<b>\$57</b>
Z15S2SHL	15 x 16 x 30	57	5.75	<b>\$630</b>	<b>\$659</b>	<b>\$326</b>	<b>\$57</b>
Z12S2SHL	12 x 16 x 30	50	4.75	<b>\$590</b>	<b>\$615</b>	<b>\$295</b>	<b>\$57</b>

Laminate doors are standard. **Includes one adjustable shelf.** Standard with lock. Shipped assembled in 1 carton.

**Required specifications**

- Top finish
- Top thickness/edge detail
- Base finish
- Handles

**Optional specifications**

- HP laminate
- Key #
- Glazed doors\*

STORAGE CABINETS - 29.5" / 30" HIGH

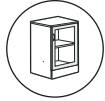
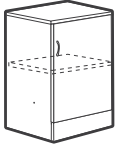

Glazed door option

Storage Cabinet with Door - RIGHT\*

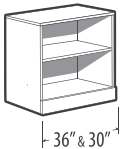

21", 18", 16", 15" & 12"

Open Storage Cabinet

MODEL #	DIMENSIONS	WT/LB.	CUBIC FT.	1" TOP	1.5" TOP	GLAZE ADD	HP ADD
W x D x H (1.5" TOP)							
Z21L2SHR	21 x 24 x 30	95	11	\$902	\$952	\$408	\$114
Z18L2SHR	18 x 24 x 30	85	9.75	\$848	\$890	\$373	\$87
Z16L2SHR	16 x 24 x 30	80	9	\$815	\$857	\$365	\$65
Z15L2SHR	15 x 24 x 30	77	8.25	\$758	\$792	\$326	\$65
Z12L2SHR	12 x 24 x 30	68	6.75	\$714	\$744	\$295	\$57
Z21M2SHR	21 x 20 x 30	84	9.5	\$802	\$844	\$408	\$87
Z18M2SHR	18 x 20 x 30	76	8.25	\$759	\$794	\$373	\$87
Z16M2SHR	16 x 20 x 30	69	7	\$717	\$752	\$365	\$65
Z15M2SHR	15 x 20 x 30	66	6.75	\$682	\$712	\$326	\$57
Z12M2SHR	12 x 20 x 30	60	5.75	\$636	\$661	\$295	\$57
Z21S2SHR	21 x 16 x 30	71	7.5	\$732	\$765	\$408	\$57
Z18S2SHR	18 x 16 x 30	64	6.75	\$701	\$735	\$373	\$57
Z16S2SHR	16 x 16 x 30	59	6	\$671	\$705	\$365	\$57
Z15S2SHR	15 x 16 x 30	57	5.75	\$630	\$659	\$326	\$57
Z12S2SHR	12 x 16 x 30	50	4.75	\$590	\$615	\$295	\$57

Laminate doors are standard. **Includes one adjustable shelf.** Standard with lock. Shipped assembled in 1 carton.

Z36L2SHN	36 x 24 x 30	127	18.5	\$971	\$1040	N/A	\$171
Z30L2SHN	30 x 24 x 30	111	15.5	\$871	\$933	N/A	\$144
Z21L2SHN	21 x 24 x 30	86	11	\$758	\$808	N/A	\$114
Z18L2SHN	18 x 24 x 30	78	9.75	\$715	\$757	N/A	\$87
Z16L2SHN	16 x 24 x 30	71	9	\$682	\$724	N/A	\$65
Z15L2SHN	15 x 24 x 30	63	8.25	\$633	\$667	N/A	\$57
Z12L2SHN	12 x 24 x 30	60	6.75	\$598	\$628	N/A	\$57
Z36M2SHN	36 x 20 x 30	112	15.5	\$868	\$930	N/A	\$128
Z30M2SHN	30 x 20 x 30	97	13.25	\$784	\$836	N/A	\$114
Z21M2SHN	21 x 20 x 30	74	9.5	\$655	\$697	N/A	\$87
Z18M2SHN	18 x 20 x 30	68	8.25	\$620	\$655	N/A	\$69
Z16M2SHN	16 x 20 x 30	63	7	\$586	\$621	N/A	\$57
Z15M2SHN	15 x 20 x 30	61	6.75	\$561	\$591	N/A	\$57
Z12M2SHN	12 x 20 x 30	55	5.75	\$518	\$543	N/A	\$57
Z36S2SHN	36 x 16 x 30	96	12.5	\$780	\$841	N/A	\$128
Z30S2SHN	30 x 16 x 30	83	10.5	\$679	\$721	N/A	\$114
Z21S2SHN	21 x 16 x 30	63	7.5	\$586	\$619	N/A	\$87
Z18S2SHN	18 x 16 x 30	56	6.75	\$564	\$598	N/A	\$69
Z16S2SHN	16 x 16 x 30	52	6	\$536	\$570	N/A	\$57
Z15S2SHN	15 x 16 x 30	50	5.75	\$507	\$536	N/A	\$57
Z12S2SHN	12 x 16 x 30	45	4.75	\$472	\$497	N/A	\$57

**One adjustable shelf.** Shipped assembled in 1 carton.

**Required specifications**

- Top finish
- Top thickness/edge detail
- Base finish
- Handles\*

**Optional specifications**

- HP laminate
- Key #\*
- Glazed door\*

**FILE MODULES - 29.5" / 30" HIGH**

MODEL #	DIMENSIONS W x D x H (1.5" TOP)	WT/LB.	CUBIC FT.	1" TOP	1.5" TOP	GLAZE ADD	HP ADD
Z36L2FN	36 x 24 x 30	153	18.5	<b>\$1390</b>	<b>\$1459</b>	N/A	<b>\$171</b>
Z30L2FN	30 x 24 x 30	134	15.5	<b>\$1254</b>	<b>\$1316</b>	N/A	<b>\$144</b>
Z16L2FN	16 x 24 x 30	87	9	<b>\$877</b>	<b>\$919</b>	N/A	<b>\$87</b>
Z15L2FN	15 x 24 x 30	83	8.25	<b>\$827</b>	<b>\$861</b>	N/A	<b>\$69</b>
Z36M2FN	36 x 20 x 30	135	15.5	<b>\$1286</b>	<b>\$1348</b>	N/A	<b>\$171</b>
Z30M2FN	30 x 20 x 30	119	13.25	<b>\$1179</b>	<b>\$1231</b>	N/A	<b>\$144</b>
Z16M2FN	16 x 20 x 30	76	7	<b>\$781</b>	<b>\$816</b>	N/A	<b>\$87</b>
Z15M2FN	15 x 20 x 30	72	6.75	<b>\$750</b>	<b>\$780</b>	N/A	<b>\$69</b>
Z36S2FN	36 x 16 x 30	114	12.5	<b>\$1162</b>	<b>\$1223</b>	N/A	<b>\$128</b>
Z30S2FN	30 x 16 x 30	98	10.5	<b>\$1030</b>	<b>\$1072</b>	N/A	<b>\$114</b>
Z16S2FN	16 x 16 x 30	63	6	<b>\$726</b>	<b>\$760</b>	N/A	<b>\$65</b>
Z15S2FN	15 x 16 x 30	61	5.75	<b>\$692</b>	<b>\$721</b>	N/A	<b>\$57</b>

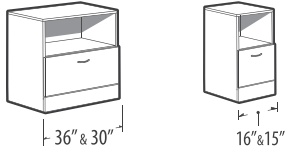

**File Module with Open Shelf\***

Open shelf and one file drawer on bottom. Lock secures file drawer. 36" and 30" wide models have front-to-back and side-to-side letter/legal filing capability. Side-to-side file bars included. Shipped assembled in 1 carton.

- 15" wide models have only side-to side filing capability.
- Lateral file drawer construction is for accommodating hanging files NOT for stacking materials on the drawer bottom.

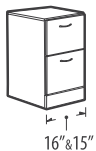

**Two File Module\***

Z36L2E	36 x 24 x 30	165	18.5	<b>\$1705</b>	<b>\$1774</b>	N/A	<b>\$171</b>
Z30L2E	30 x 24 x 30	146	15.5	<b>\$1560</b>	<b>\$1622</b>	N/A	<b>\$144</b>
Z16L2E	16 x 24 x 30	96	9	<b>\$1003</b>	<b>\$1045</b>	N/A	<b>\$87</b>
Z15L2E	15 x 24 x 30	91	8.25	<b>\$944</b>	<b>\$978</b>	N/A	<b>\$69</b>
Z36M2E	36 x 20 x 30	149	15.5	<b>\$1609</b>	<b>\$1671</b>	N/A	<b>\$171</b>
Z30M2E	30 x 20 x 30	133	13.25	<b>\$1493</b>	<b>\$1545</b>	N/A	<b>\$144</b>
Z16M2E	16 x 20 x 30	85	7	<b>\$912</b>	<b>\$947</b>	N/A	<b>\$87</b>
Z15M2E	15 x 20 x 30	82	6.75	<b>\$878</b>	<b>\$908</b>	N/A	<b>\$69</b>
Z36S2E	36 x 16 x 30	128	12.5	<b>\$1514</b>	<b>\$1575</b>	N/A	<b>\$128</b>
Z30S2E	30 x 16 x 30	110	10.5	<b>\$1375</b>	<b>\$1417</b>	N/A	<b>\$114</b>
Z16S2E	16 x 16 x 30	74	6	<b>\$902</b>	<b>\$936</b>	N/A	<b>\$65</b>
Z15S2E	15 x 16 x 30	71	5.75	<b>\$871</b>	<b>\$900</b>	N/A	<b>\$57</b>

Two file drawers. Lock secures all drawers. 36" and 30" wide models have front-to-back and side-to-side letter/legal filing capability. Side-to-side file bars included. Shipped assembled in 1 carton.

- 15" wide models have only side-to side filing capability.
- Lateral file drawer construction is for accommodating hanging files NOT for stacking materials on the drawer bottom.



**Two File Module**

Z36L2SE	36 x 24 x 30	180	18.5	<b>\$2004</b>	<b>\$2073</b>	N/A	<b>\$171</b>
Z36M2SE	36 x 20 x 30	164	15.5	<b>\$1927</b>	<b>\$1990</b>	N/A	<b>\$171</b>

Two lateral file drawers with **steel drawer interior**. Steel drawer construction includes metal sides and masonite bottoms. Lock secures all drawers. Front-to-back and side-to-side letter/legal filing capability. Side-to-side file bars included. Shipped assembled in 1 carton.

- Front-to-back filing bars available separately. Order **FBB** bars. See Metal Filing + Storage price list page 14.
- Lateral file drawer construction is for accommodating hanging files NOT for stacking materials on the drawer bottom.

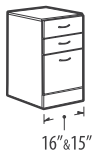

**Box/Box/File Module**

Z16L2BF	16 x 24 x 30	98	9	<b>\$1130</b>	<b>\$1172</b>	N/A	<b>\$87</b>
Z15L2BF	15 x 24 x 30	93	8.25	<b>\$1079</b>	<b>\$1113</b>	N/A	<b>\$87</b>
Z16M2BF	16 x 20 x 30	87	7	<b>\$1036</b>	<b>\$1071</b>	N/A	<b>\$87</b>
Z15M2BF	15 x 20 x 30	84	6.75	<b>\$1008</b>	<b>\$1038</b>	N/A	<b>\$87</b>
Z16S2BF	16 x 16 x 30	74	6	<b>\$965</b>	<b>\$999</b>	N/A	<b>\$65</b>
Z15S2BF	15 x 16 x 30	71	5.75	<b>\$922</b>	<b>\$951</b>	N/A	<b>\$65</b>

Two box and one file drawer. One pencil tray. Lock secures all drawers. Shipped assembled in 1 carton.

**Required specifications**

- Top finish
- Top thickness/edge detail
- Base finish
- Handles

**Optional specifications**

- HP laminate
- Key #
- Box drawer - no upcharge (not Z36x2SE)

MIXED STORAGE CABINETS - 29.5" / 30" HIGH



Mixed Storage Cabinet



Mixed Storage Cabinet

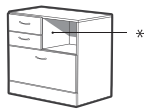

\* Accepts collator

Mixed Drawer Cabinet with Open Shelf\*

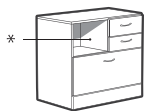

\* Accepts collator

Mixed Drawer Cabinet with Open Shelf\*

MODEL #	DIMENSIONS	WT/LB.	CUBIC FT.	1" TOP	1.5" TOP	GLAZE ADD	HP ADD
W x D x H (1.5" TOP)							
Z36L2XL	36 x 24 x 30	187	18.5	<b>\$1944</b>	<b>\$2009</b>	N/A	<b>\$171</b>
Z30L2XL	30 x 24 x 30	166	15.5	<b>\$1772</b>	<b>\$1833</b>	N/A	<b>\$144</b>
Z36M2XL	36 x 20 x 30	177	15.5	<b>\$1823</b>	<b>\$1885</b>	N/A	<b>\$171</b>
Z30M2XL	30 x 20 x 30	152	13.25	<b>\$1683</b>	<b>\$1735</b>	N/A	<b>\$144</b>
Z36S2XL	36 x 16 x 30	145	12.5	<b>\$1566</b>	<b>\$1622</b>	N/A	<b>\$128</b>
Z30S2XL	30 x 16 x 30	124	10.5	<b>\$1405</b>	<b>\$1451</b>	N/A	<b>\$114</b>

**Two box drawers on left, one file drawer on right** accommodates letter filing side-to-side and one lateral file drawer on bottom (see filing orientation on page 120). Right lock secures two box and one file drawer, the left lock secures the lateral file. One pencil tray. Front-to-back and side-to-side letter/legal filing capability in lateral drawer, file bars included. Shipped assembled in 1 carton.

- Lateral file drawer construction is for accommodating hanging files NOT for stacking materials on the drawer bottom.
- Top file drawer supports hanging folders only, does NOT accept hanging folders with plastic tabs.

Z36L2XR	36 x 24 x 30	187	18.5	<b>\$1944</b>	<b>\$2009</b>	N/A	<b>\$171</b>
Z30L2XR	30 x 24 x 30	166	15.5	<b>\$1772</b>	<b>\$1833</b>	N/A	<b>\$144</b>
Z36M2XR	36 x 20 x 30	177	15.5	<b>\$1823</b>	<b>\$1885</b>	N/A	<b>\$171</b>
Z30M2XR	30 x 20 x 30	152	13.25	<b>\$1683</b>	<b>\$1735</b>	N/A	<b>\$144</b>
Z36S2XR	36 x 16 x 30	145	12.5	<b>\$1566</b>	<b>\$1622</b>	N/A	<b>\$128</b>
Z30S2XR	30 x 16 x 30	124	10.5	<b>\$1405</b>	<b>\$1451</b>	N/A	<b>\$114</b>

**Two box drawers on right, one file drawer on left** accommodates letter filing side-to-side and one lateral file drawer on bottom (see filing orientation on page 120). Left lock secures two box and one file drawer, the right lock secures the lateral file. One pencil tray. Front-to-back and side-to-side letter/legal filing capability. Side-to-side file bars included. Shipped assembled in 1 carton.

- Lateral file drawer construction is for accommodating hanging files NOT for stacking materials on the drawer bottom.
- Top file drawer supports hanging folders only, does NOT accept hanging folders with plastic tabs.

Z36L2XNL	36 x 24 x 30	176	18.5	<b>\$1686</b>	<b>\$1755</b>	N/A	<b>\$171</b>
Z30L2XNL	30 x 24 x 30	155	15.5	<b>\$1546</b>	<b>\$1608</b>	N/A	<b>\$144</b>
Z36M2XNL	36 x 20 x 30	158	15.5	<b>\$1574</b>	<b>\$1636</b>	N/A	<b>\$171</b>
Z30M2XNL	30 x 20 x 30	139	13.25	<b>\$1456</b>	<b>\$1508</b>	N/A	<b>\$144</b>
Z36S2XNL	36 x 16 x 30	128	12.5	<b>\$1414</b>	<b>\$1466</b>	N/A	<b>\$128</b>
Z30S2XNL	30 x 16 x 30	114	10.5	<b>\$1280</b>	<b>\$1314</b>	N/A	<b>\$114</b>

**Two box drawers on left, open shelf on right** and one lateral file drawer on bottom. Lock secures all drawers. One pencil tray. Front-to-back and side-to-side letter/legal filing capability. Side-to-side file bars included. Shipped assembled in 1 carton.

- Lateral file drawer construction is for accommodating hanging files NOT for stacking materials on the drawer bottom.

Z36L2XNR	36 x 24 x 30	176	18.5	<b>\$1686</b>	<b>\$1755</b>	N/A	<b>\$171</b>
Z30L2XNR	30 x 24 x 30	155	15.5	<b>\$1546</b>	<b>\$1608</b>	N/A	<b>\$144</b>
Z36M2XNR	36 x 20 x 30	158	15.5	<b>\$1574</b>	<b>\$1636</b>	N/A	<b>\$171</b>
Z30M2XNR	30 x 20 x 30	139	13.25	<b>\$1456</b>	<b>\$1508</b>	N/A	<b>\$144</b>
Z36S2XNR	36 x 16 x 30	128	12.5	<b>\$1414</b>	<b>\$1466</b>	N/A	<b>\$128</b>
Z30S2XNR	30 x 16 x 30	114	10.5	<b>\$1280</b>	<b>\$1314</b>	N/A	<b>\$114</b>

**Two box drawers on right, open shelf on left** and one lateral file drawer on bottom. Lock secures all drawers. One pencil tray. Front-to-back and side-to-side letter/legal filing capability. Side-to-side file bars included. Shipped assembled in 1 carton.

- Lateral file drawer construction is for accommodating hanging files NOT for stacking materials on the drawer bottom.

**Required specifications**

Top finish  
Top thickness/edge detail  
Base finish  
Handles

**Optional specifications**

HP laminate  
Key #  
Box drawer - no upcharge  
Collator - position & finish\*



**STORAGE MODULES - 41.3" / 41.8" HIGH**

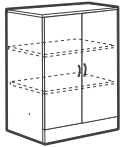

Glazed door option

**Storage Cabinet with Doors**

MODEL #	DIMENSIONS W x D x H (1.5" TOP)	WT/LB.	CUBIC FT.	1" TOP	1.5" TOP	GLAZE ADD	HP ADD
Z36L4SH	36 x 24 x 41.8	186	25	\$1505	\$1574	\$969	\$171
Z30L4SH	30 x 24 x 41.8	162	21.25	\$1376	\$1438	\$846	\$144
Z36M4SH	36 x 20 x 41.8	166	21.25	\$1405	\$1467	\$969	\$171
Z30M4SH	30 x 20 x 41.8	144	18	\$1271	\$1323	\$846	\$144
Z36S4SH	36 x 16 x 41.8	143	17.5	\$1272	\$1333	\$969	\$128
Z30S4SH	30 x 16 x 41.8	122	14.5	\$1140	\$1182	\$846	\$69

Laminate doors are standard. **Includes two 3-position fixed/height adjustable shelves.** Standard with lock. Shipped assembled in 1 carton.

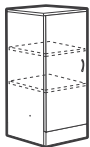

Glazed door option

**Storage Cabinet with Door - LEFT**

Z21L4SHL	21 x 24 x 41.8	124	15.25	\$1114	\$1164	\$529	\$114
Z18L4SHL	18 x 24 x 41.8	112	13.25	\$1049	\$1091	\$477	\$87
Z16L4SHL	16 x 24 x 41.8	105	12	\$987	\$1029	\$471	\$87
Z15L4SHL	15 x 24 x 41.8	101	11.25	\$943	\$977	\$417	\$87
Z12L4SHL	12 x 24 x 41.8	89	9.25	\$873	\$903	\$377	\$57
Z21M4SHL	21 x 20 x 41.8	117	13	\$1004	\$1046	\$529	\$114
Z18M4SHL	18 x 20 x 41.8	99	11.25	\$950	\$985	\$477	\$87
Z16M4SHL	16 x 20 x 41.8	91	10.25	\$891	\$926	\$471	\$69
Z15M4SHL	15 x 20 x 41.8	88	9.5	\$851	\$881	\$417	\$69
Z12M4SHL	12 x 20 x 41.8	79	8	\$793	\$818	\$377	\$57
Z21S4SHL	21 x 16 x 41.8	95	10.5	\$894	\$927	\$529	\$87
Z18S4SHL	18 x 16 x 41.8	84	9.5	\$860	\$894	\$477	\$69
Z16S4SHL	16 x 16 x 41.8	77	8.5	\$805	\$839	\$471	\$69
Z15S4SHL	15 x 16 x 41.8	74	8	\$763	\$792	\$417	\$69
Z12S4SHL	12 x 16 x 41.8	65	6.5	\$705	\$730	\$377	\$57

Laminate doors are standard. **Includes two 3-position fixed/height adjustable shelves.** Standard with lock. Ganging hardware included with all units 24" wide or less and 41"H or taller. Shipped assembled in 1 carton.

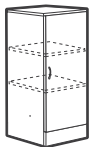

Glazed door option

**Storage Cabinet with Door - RIGHT**

Z21L4SHR	21 x 24 x 41.8	124	15.25	\$1114	\$1164	\$529	\$114
Z18L4SHR	18 x 24 x 41.8	112	13.25	\$1049	\$1091	\$477	\$87
Z16L4SHR	16 x 24 x 41.8	105	12	\$987	\$1029	\$471	\$87
Z15L4SHR	15 x 24 x 41.8	101	11.25	\$943	\$977	\$417	\$87
Z12L4SHR	12 x 24 x 41.8	89	9.25	\$873	\$903	\$377	\$57
Z21M4SHR	21 x 20 x 41.8	117	13	\$1004	\$1046	\$529	\$114
Z18M4SHR	18 x 20 x 41.8	99	11.25	\$950	\$985	\$477	\$87
Z16M4SHR	16 x 20 x 41.8	91	10.25	\$891	\$926	\$471	\$69
Z15M4SHR	15 x 20 x 41.8	88	9.5	\$851	\$881	\$417	\$69
Z12M4SHR	12 x 20 x 41.8	79	8	\$793	\$818	\$377	\$57
Z21S4SHR	21 x 16 x 41.8	95	10.5	\$894	\$927	\$529	\$87
Z18S4SHR	18 x 16 x 41.8	84	9.5	\$860	\$894	\$477	\$69
Z16S4SHR	16 x 16 x 41.8	77	8.5	\$805	\$839	\$471	\$69
Z15S4SHR	15 x 16 x 41.8	74	8	\$763	\$792	\$417	\$69
Z12S4SHR	12 x 16 x 41.8	65	6.5	\$705	\$730	\$377	\$57

Laminate doors are standard. **Includes two 3-position fixed/height adjustable shelves.** Standard with lock. Ganging hardware included with all units 24" wide or less and 41"H or taller. Shipped assembled in 1 carton.

**Required specifications**

- Top finish
- Top thickness/edge detail
- Base finish
- Handles

**Optional specifications**

- HP laminate
- Key #
- Glazed door

STORAGE MODULES - 41.3" / 41.8" HIGH

MODEL #	DIMENSIONS	WT/LB.	CUBIC FT.	1" TOP	1.5" TOP	GLAZE ADD	HP ADD
---------	------------	--------	-----------	--------	----------	-----------	--------

W x D x H (1.5" TOP)

Z36L4SHN	36 x 24 x 41.8	163	25	<b>\$1181</b>	<b>\$1250</b>	N/A	<b>\$171</b>
Z30L4SHN	30 x 24 x 41.8	142	21.25	<b>\$1090</b>	<b>\$1152</b>	N/A	<b>\$144</b>
Z21L4SHN	21 x 24 x 41.8	112	15.25	<b>\$934</b>	<b>\$984</b>	N/A	<b>\$114</b>
Z18L4SHN	18 x 24 x 41.8	101	13.25	<b>\$884</b>	<b>\$926</b>	N/A	<b>\$87</b>
Z16L4SHN	16 x 24 x 41.8	95	12	<b>\$822</b>	<b>\$864</b>	N/A	<b>\$87</b>
Z15L4SHN	15 x 24 x 41.8	92	11.25	<b>\$798</b>	<b>\$832</b>	N/A	<b>\$87</b>
Z12L4SHN	12 x 24 x 41.8	81	9.25	<b>\$737</b>	<b>\$767</b>	N/A	<b>\$57</b>
Z36M4SHN	36 x 20 x 41.8	142	21.25	<b>\$1082</b>	<b>\$1144</b>	N/A	<b>\$171</b>
Z30M4SHN	30 x 20 x 41.8	124	18	<b>\$983</b>	<b>\$1035</b>	N/A	<b>\$144</b>
Z21M4SHN	21 x 20 x 41.8	102	13	<b>\$827</b>	<b>\$869</b>	N/A	<b>\$114</b>
Z18M4SHN	18 x 20 x 41.8	87	11.25	<b>\$784</b>	<b>\$819</b>	N/A	<b>\$87</b>
Z16M4SHN	16 x 20 x 41.8	81	10.25	<b>\$727</b>	<b>\$762</b>	N/A	<b>\$87</b>
Z15M4SHN	15 x 20 x 41.8	78	9.5	<b>\$706</b>	<b>\$736</b>	N/A	<b>\$87</b>
Z12M4SHN	12 x 20 x 41.8	70	8	<b>\$656</b>	<b>\$681</b>	N/A	<b>\$57</b>
Z36S4SHN	36 x 16 x 41.8	120	17.5	<b>\$949</b>	<b>\$1010</b>	N/A	<b>\$128</b>
Z30S4SHN	30 x 16 x 41.8	112	14.5	<b>\$851</b>	<b>\$893</b>	N/A	<b>\$114</b>
Z21S4SHN	21 x 16 x 41.8	81	10.5	<b>\$716</b>	<b>\$749</b>	N/A	<b>\$87</b>
Z18S4SHN	18 x 16 x 41.8	73	9.5	<b>\$695</b>	<b>\$729</b>	N/A	<b>\$69</b>
Z16S4SHN	16 x 16 x 41.8	67	8.5	<b>\$642</b>	<b>\$676</b>	N/A	<b>\$69</b>
Z15S4SHN	15 x 16 x 41.8	65	8	<b>\$615</b>	<b>\$644</b>	N/A	<b>\$69</b>
Z12S4SHN	12 x 16 x 41.8	58	6.5	<b>\$569</b>	<b>\$594</b>	N/A	<b>\$57</b>



\* Accepts collator 11" high  
\*\* Accepts collator 11.3" high

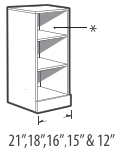
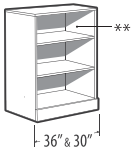

Open Storage Cabinet\*\*

Includes two 3-position fixed/height adjustable shelves. Ganging hardware included with all units 24" wide or less and 41"H or taller. Shipped assembled in 1 carton.



\* Accepts collator 11" high  
\*\* Accepts collator 11.3" high

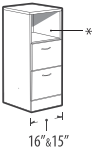
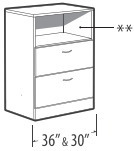

Two File Module with Open Shelf\*

Z36L4EN	36 x 24 x 41.8	200	25	<b>\$1916</b>	<b>\$1985</b>	N/A	<b>\$171</b>
Z30L4EN	30 x 24 x 41.8	179	21.25	<b>\$1824</b>	<b>\$1886</b>	N/A	<b>\$144</b>
Z16L4EN	16 x 24 x 41.8	117	12	<b>\$1148</b>	<b>\$1190</b>	N/A	<b>\$87</b>
Z15L4EN	15 x 24 x 41.8	112	11.25	<b>\$1114</b>	<b>\$1148</b>	N/A	<b>\$87</b>
Z36M4EN	36 x 20 x 41.8	182	21.25	<b>\$1822</b>	<b>\$1884</b>	N/A	<b>\$171</b>
Z30M4EN	30 x 20 x 41.8	163	18	<b>\$1730</b>	<b>\$1782</b>	N/A	<b>\$144</b>
Z16M4EN	16 x 20 x 41.8	105	10.25	<b>\$1055</b>	<b>\$1090</b>	N/A	<b>\$87</b>
Z15M4EN	15 x 20 x 41.8	101	9.5	<b>\$1025</b>	<b>\$1055</b>	N/A	<b>\$87</b>
Z36S4EN	36 x 16 x 41.8	153	17.5	<b>\$1674</b>	<b>\$1735</b>	N/A	<b>\$128</b>
Z30S4EN	30 x 16 x 41.8	131	14.5	<b>\$1520</b>	<b>\$1562</b>	N/A	<b>\$114</b>
Z16S4EN	16 x 16 x 41.8	85	8.5	<b>\$969</b>	<b>\$1003</b>	N/A	<b>\$69</b>
Z15S4EN	15 x 16 x 41.8	83	8	<b>\$942</b>	<b>\$971</b>	N/A	<b>\$69</b>

Open fixed shelf and two file drawers on bottom. Lock secures all drawers. 36" and 30" wide models have front-to-back and side-to-side letter/legal filing capability. Side-to-side file bars included. Ganging hardware included with all units 24" wide or less and 41"H or taller. Shipped assembled in 1 carton.

- Lateral file drawer construction is for accommodating hanging files NOT for stacking materials on the drawer bottom.

Required specifications

Top finish  
Top thickness/edge detail  
Base finish  
Handles\*

Optional specifications

HP laminate  
Glazed door\*  
Key #\*  
Box drawer - no upcharge\*  
Collator - position & finish\*\*

**STORAGE MODULES - 41.3" / 41.8" HIGH**      **MODEL #**      **DIMENSIONS**      **WT/LB.**      **CUBIC FT.**      **1" TOP**      **1.5" TOP**      **GLAZE ADD**      **HP ADD**

W x D x H (1.5" TOP)

Z36L43F	36 x 24 x 41.8	210	25	<b>\$2251</b>	<b>\$2320</b>	N/A	<b>\$171</b>
Z30L43F	30 x 24 x 41.8	190	21.25	<b>\$2137</b>	<b>\$2199</b>	N/A	<b>\$144</b>
Z16L43F	16 x 24 x 41.8	126	12	<b>\$1320</b>	<b>\$1362</b>	N/A	<b>\$69</b>
Z15L43F	15 x 24 x 41.8	121	11.25	<b>\$1286</b>	<b>\$1320</b>	N/A	<b>\$69</b>
Z36M43F	36 x 20 x 41.8	198	21.25	<b>\$2191</b>	<b>\$2253</b>	N/A	<b>\$171</b>
Z30M43F	30 x 20 x 41.8	177	18	<b>\$2048</b>	<b>\$2100</b>	N/A	<b>\$144</b>
Z16M43F	16 x 20 x 41.8	114	10.25	<b>\$1231</b>	<b>\$1266</b>	N/A	<b>\$69</b>
Z15M43F	15 x 20 x 41.8	110	9.5	<b>\$1201</b>	<b>\$1231</b>	N/A	<b>\$69</b>
Z36S43F	36 x 16 x 41.8	166	17.5	<b>\$1977</b>	<b>\$2038</b>	N/A	<b>\$128</b>
Z30S43F	30 x 16 x 41.8	148	14.5	<b>\$1821</b>	<b>\$1863</b>	N/A	<b>\$114</b>
Z16S43F	16 x 16 x 41.8	95	8.5	<b>\$1164</b>	<b>\$1198</b>	N/A	<b>\$69</b>
Z15S43F	15 x 16 x 41.8	91	8	<b>\$1125</b>	<b>\$1154</b>	N/A	<b>\$69</b>



**Three File Module**



**Three File Module**

Three file drawers. Lock secures all drawers. 36" and 30" wide models have front-to-back and side-to-side letter/legal filing capability. Side-to-side file bars included. Ganging hardware included with all units 24" wide or less and 41"H or taller. Shipped assembled in 1 carton.

- Lateral file drawer construction is for accommodating hanging files NOT for stacking materials on the drawer bottom.

Z36L4S3F	36 x 24 x 41.8	233	25	<b>\$2662</b>	<b>\$2731</b>	N/A	<b>\$171</b>
Z36M4S3F	36 x 20 x 41.8	221	21.25	<b>\$2574</b>	<b>\$2637</b>	N/A	<b>\$144</b>

**Three lateral file drawers with steel drawer interior.** Steel drawer construction includes metal sides and masonite bottoms. Lock secures all drawers. Front-to-back and side-to-side letter/legal filing capability. Side-to-side file bars included. Shipped assembled in 1 carton.

- Front-to-back filing bars available separately. Order **FBB** bars. See Metal Filing + Storage price list page 14.
- Lateral file drawer construction is for accommodating hanging files NOT for stacking materials on the drawer bottom.

**Required specifications**

Top finish  
Top thickness/edge detail  
Base finish  
Handles

**Optional specifications**

HP laminate  
Key #

STORAGE MODULES - 53" / 53.5" HIGH

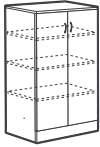

Glazed door option

Storage Cabinet with Doors\*\*

MODEL #	DIMENSIONS W x D x H (1.5" TOP)	WT/LB.	CUBIC FT.	1" TOP	1.5" TOP	GLAZE ADD	HP ADD
Z36L5SH	36 x 24 x 53.5	230	31.25	<b>\$1815</b>	<b>\$1884</b>	<b>\$1188</b>	<b>\$171</b>
Z30L5SH	30 x 24 x 53.5	200	27	<b>\$1649</b>	<b>\$1711</b>	<b>\$1034</b>	<b>\$144</b>
Z36M5SH	36 x 20 x 53.5	204	27	<b>\$1689</b>	<b>\$1751</b>	<b>\$1188</b>	<b>\$171</b>
Z30M5SH	30 x 20 x 53.5	185	22.75	<b>\$1482</b>	<b>\$1534</b>	<b>\$1034</b>	<b>\$144</b>
Z36S5SH	36 x 16 x 53.5	175	21.75	<b>\$1584</b>	<b>\$1645</b>	<b>\$1188</b>	<b>\$128</b>
Z30S5SH	30 x 16 x 53.5	152	18.5	<b>\$1384</b>	<b>\$1426</b>	<b>\$1034</b>	<b>\$114</b>

Laminate doors are standard. **Includes three 3-position fixed/height adjustable shelves.** Standard with lock. Shipped assembled in 1 carton.

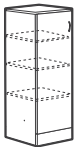

Glazed door option

Storage Cabinet with Door - LEFT\*\*

Z21L5SHL	21 x 24 x 53.5	154	19.5	<b>\$1304</b>	<b>\$1354</b>	<b>\$657</b>	<b>\$114</b>
Z18L5SHL	18 x 24 x 53.5	140	17	<b>\$1246</b>	<b>\$1288</b>	<b>\$589</b>	<b>\$87</b>
Z16L5SHL	16 x 24 x 53.5	130	15.5	<b>\$1175</b>	<b>\$1217</b>	<b>\$583</b>	<b>\$87</b>
Z15L5SHL	15 x 24 x 53.5	125	14.25	<b>\$1121</b>	<b>\$1155</b>	<b>\$512</b>	<b>\$87</b>
Z12L5SHL	12 x 24 x 53.5	110	11.75	<b>\$1046</b>	<b>\$1076</b>	<b>\$463</b>	<b>\$57</b>
Z21M5SHL	21 x 20 x 53.5	143	16.5	<b>\$1195</b>	<b>\$1237</b>	<b>\$657</b>	<b>\$114</b>
Z18M5SHL	18 x 20 x 53.5	123	14.25	<b>\$1130</b>	<b>\$1165</b>	<b>\$589</b>	<b>\$87</b>
Z16M5SHL	16 x 20 x 53.5	113	13	<b>\$1069</b>	<b>\$1104</b>	<b>\$583</b>	<b>\$87</b>
Z15M5SHL	15 x 20 x 53.5	109	12.25	<b>\$1015</b>	<b>\$1045</b>	<b>\$512</b>	<b>\$87</b>
Z12M5SHL	12 x 20 x 53.5	97	10	<b>\$942</b>	<b>\$967</b>	<b>\$463</b>	<b>\$57</b>
Z21S5SHL	21 x 16 x 53.5	117	13.25	<b>\$1110</b>	<b>\$1143</b>	<b>\$657</b>	<b>\$87</b>
Z18S5SHL	18 x 16 x 53.5	104	11.5	<b>\$1055</b>	<b>\$1089</b>	<b>\$589</b>	<b>\$69</b>
Z16S5SHL	16 x 16 x 53.5	97	10.5	<b>\$999</b>	<b>\$1033</b>	<b>\$583</b>	<b>\$69</b>
Z15S5SHL	15 x 16 x 53.5	91	9.75	<b>\$958</b>	<b>\$987</b>	<b>\$512</b>	<b>\$69</b>
Z12S5SHL	12 x 16 x 53.5	80	8.25	<b>\$884</b>	<b>\$909</b>	<b>\$463</b>	<b>\$57</b>

Laminate doors are standard. **Includes three 3-position fixed/height adjustable shelves.** Standard with lock. Ganging hardware included with all units 24" wide or less and 41"H or taller. Shipped assembled in 1 carton.

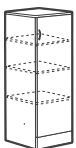

Glazed door option

Storage Cabinet with Door - RIGHT\*\*

Z21L5SHR	21 x 24 x 53.5	154	19.5	<b>\$1304</b>	<b>\$1354</b>	<b>\$657</b>	<b>\$114</b>
Z18L5SHR	18 x 24 x 53.5	140	17	<b>\$1246</b>	<b>\$1288</b>	<b>\$589</b>	<b>\$87</b>
Z16L5SHR	16 x 24 x 53.5	130	15.5	<b>\$1175</b>	<b>\$1217</b>	<b>\$583</b>	<b>\$87</b>
Z15L5SHR	15 x 24 x 53.5	125	14.25	<b>\$1121</b>	<b>\$1155</b>	<b>\$512</b>	<b>\$87</b>
Z12L5SHR	12 x 24 x 53.5	110	11.75	<b>\$1046</b>	<b>\$1076</b>	<b>\$463</b>	<b>\$57</b>
Z21M5SHR	21 x 20 x 53.5	143	16.5	<b>\$1195</b>	<b>\$1237</b>	<b>\$657</b>	<b>\$114</b>
Z18M5SHR	18 x 20 x 53.5	123	14.25	<b>\$1130</b>	<b>\$1165</b>	<b>\$589</b>	<b>\$87</b>
Z16M5SHR	16 x 20 x 53.5	113	13	<b>\$1069</b>	<b>\$1104</b>	<b>\$583</b>	<b>\$87</b>
Z15M5SHR	15 x 20 x 53.5	109	12.25	<b>\$1015</b>	<b>\$1045</b>	<b>\$512</b>	<b>\$87</b>
Z12M5SHR	12 x 20 x 53.5	97	10	<b>\$942</b>	<b>\$967</b>	<b>\$463</b>	<b>\$57</b>
Z21S5SHR	21 x 16 x 53.5	117	13.25	<b>\$1110</b>	<b>\$1143</b>	<b>\$657</b>	<b>\$87</b>
Z18S5SHR	18 x 16 x 53.5	104	11.5	<b>\$1055</b>	<b>\$1089</b>	<b>\$589</b>	<b>\$69</b>
Z16S5SHR	16 x 16 x 53.5	97	10.5	<b>\$999</b>	<b>\$1033</b>	<b>\$583</b>	<b>\$69</b>
Z15S5SHR	15 x 16 x 53.5	91	9.75	<b>\$958</b>	<b>\$987</b>	<b>\$512</b>	<b>\$69</b>
Z12S5SHR	12 x 16 x 53.5	80	8.25	<b>\$884</b>	<b>\$909</b>	<b>\$463</b>	<b>\$57</b>

Laminate doors are standard. **Includes three 3-position fixed/height adjustable shelves.** Standard with lock. Ganging hardware included with all units 24" wide or less and 41"H or taller. Shipped assembled in 1 carton.

Required specifications

Top finish  
Top thickness/edge detail  
Base finish  
Handles

Optional specifications

HP laminate  
Key #  
Glazed door

**STORAGE MODULES - 53" / 53.5" HIGH**

MODEL #	DIMENSIONS	WT/LB.	CUBIC FT.	1" TOP	1.5" TOP	GLAZE ADD	HP ADD
W x D x H (1.5" TOP)							
Z36L5SHN	36 x 24 x 53.5	198	31.25	<b>\$1412</b>	<b>\$1481</b>	N/A	<b>\$171</b>
Z30L5SHN	30 x 24 x 53.5	173	27	<b>\$1318</b>	<b>\$1380</b>	N/A	<b>\$144</b>
Z21L5SHN	21 x 24 x 53.5	136	19.5	<b>\$1082</b>	<b>\$1132</b>	N/A	<b>\$114</b>
Z18L5SHN	18 x 24 x 53.5	124	17	<b>\$1038</b>	<b>\$1080</b>	N/A	<b>\$87</b>
Z16L5SHN	16 x 24 x 53.5	116	15.5	<b>\$972</b>	<b>\$1014</b>	N/A	<b>\$87</b>
Z15L5SHN	15 x 24 x 53.5	112	14.25	<b>\$938</b>	<b>\$972</b>	N/A	<b>\$87</b>
Z12L5SHN	12 x 24 x 53.5	100	11.75	<b>\$877</b>	<b>\$907</b>	N/A	<b>\$57</b>
Z36M5SHN	36 x 20 x 53.5	172	27	<b>\$1285</b>	<b>\$1347</b>	N/A	<b>\$171</b>
Z30M5SHN	30 x 20 x 53.5	158	22.75	<b>\$1148</b>	<b>\$1200</b>	N/A	<b>\$144</b>
Z21M5SHN	21 x 20 x 53.5	124	16.5	<b>\$969</b>	<b>\$1011</b>	N/A	<b>\$114</b>
Z18M5SHN	18 x 20 x 53.5	107	14.25	<b>\$926</b>	<b>\$961</b>	N/A	<b>\$87</b>
Z16M5SHN	16 x 20 x 53.5	99	13	<b>\$866</b>	<b>\$901</b>	N/A	<b>\$87</b>
Z15M5SHN	15 x 20 x 53.5	96	12.25	<b>\$833</b>	<b>\$863</b>	N/A	<b>\$87</b>
Z12M5SHN	12 x 20 x 53.5	85	10	<b>\$773</b>	<b>\$798</b>	N/A	<b>\$57</b>
Z36S5SHN	36 x 16 x 53.5	145	21.75	<b>\$1118</b>	<b>\$1179</b>	N/A	<b>\$128</b>
Z30S5SHN	30 x 16 x 53.5	127	18.5	<b>\$1007</b>	<b>\$1049</b>	N/A	<b>\$114</b>
Z21S5SHN	21 x 16 x 53.5	98	13.25	<b>\$848</b>	<b>\$881</b>	N/A	<b>\$87</b>
Z18S5SHN	18 x 16 x 53.5	89	11.5	<b>\$815</b>	<b>\$849</b>	N/A	<b>\$69</b>
Z16S5SHN	16 x 16 x 53.5	83	10.5	<b>\$762</b>	<b>\$796</b>	N/A	<b>\$69</b>
Z15S5SHN	15 x 16 x 53.5	78	9.75	<b>\$750</b>	<b>\$779</b>	N/A	<b>\$69</b>
Z12S5SHN	12 x 16 x 53.5	70	8.25	<b>\$692</b>	<b>\$717</b>	N/A	<b>\$57</b>



\* Accepts collator 11" high  
\*\* Accepts collator 11.3" high

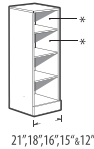
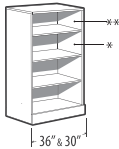

**Open Storage Cabinet\***

**Includes three 3-position fixed/height adjustable shelves.** Ganging hardware included with all units 24" wide or less and 41"H or taller. Shipped assembled in 1 carton.

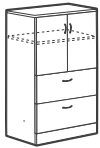

Glazed door option

**Two File Module with Doors\*\***

Z36L5E	36 x 24 x 53.5	251	31.25	<b>\$2464</b>	<b>\$2533</b>	<b>\$723</b>	<b>\$171</b>
Z30L5E	30 x 24 x 53.5	223	27	<b>\$2298</b>	<b>\$2360</b>	<b>\$636</b>	<b>\$144</b>
Z36M5E	36 x 20 x 53.5	230	27	<b>\$2351</b>	<b>\$2413</b>	<b>\$754</b>	<b>\$171</b>
Z30M5E	30 x 20 x 53.5	202	22.75	<b>\$2137</b>	<b>\$2189</b>	<b>\$666</b>	<b>\$144</b>
Z36S5E	36 x 16 x 53.5	193	21.75	<b>\$2074</b>	<b>\$2135</b>	<b>\$754</b>	<b>\$128</b>
Z30S5E	30 x 16 x 53.5	170	18.5	<b>\$1904</b>	<b>\$1946</b>	<b>\$666</b>	<b>\$114</b>

Two lateral file drawers on bottom. Laminate doors are standard. **Includes one 3-position fixed/height adjustable shelf.** Upper lock secures storage compartment. Lower lock secures two file drawers. Front-to-back and side-to-side letter/legal filing capability. Side-to-side file bars included. Shipped assembled in 1 carton.

- Lateral file drawer construction is for accommodating hanging files NOT for stacking materials on the drawer bottom.

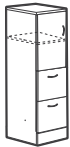

Glazed door option

**Two File Module with Door - LEFT\*\***

Z16L5EL	16 x 24 x 53.5	145	15.5	<b>\$1430</b>	<b>\$1472</b>	<b>\$366</b>	<b>\$87</b>
Z15L5EL	15 x 24 x 53.5	140	14.25	<b>\$1376</b>	<b>\$1410</b>	<b>\$326</b>	<b>\$87</b>
Z16M5EL	16 x 20 x 53.5	130	13	<b>\$1329</b>	<b>\$1364</b>	<b>\$365</b>	<b>\$87</b>
Z15M5EL	15 x 20 x 53.5	126	12.25	<b>\$1275</b>	<b>\$1305</b>	<b>\$326</b>	<b>\$87</b>
Z16S5EL	16 x 16 x 53.5	109	10.5	<b>\$1218</b>	<b>\$1252</b>	<b>\$365</b>	<b>\$69</b>
Z15S5EL	15 x 16 x 53.5	105	9.75	<b>\$1197</b>	<b>\$1226</b>	<b>\$326</b>	<b>\$69</b>

Two file drawers on bottom. Laminate door is standard. **Includes one 3-position fixed/height adjustable shelf.** Upper lock secures storage compartment. Lower lock secures two file drawers. Ganging hardware included with all units 24" wide or less and 41"H or taller. Shipped assembled in 1 carton.

**Required specifications**

- Top finish
- Top thickness/edge detail
- Base finish
- Handles\*\*

**Optional specifications**

- HP laminate
- Glazed door\*\*
- Key #\*\*
- Box drawer - no upcharge\*\*
- Collator - position & finish\*

STORAGE MODULES - 53" / 53.5" HIGH

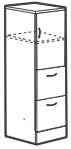

Glazed door option

Two File Module with Door - RIGHT\*\*

MODEL #	DIMENSIONS W x D x H (1.5" TOP)	WT/LB.	CUBIC FT.	1" TOP	1.5" TOP	GLAZE ADD	HP ADD
Z16L5ER	16 x 24 x 53.5	145	15.5	\$1430	\$1472	\$366	\$87
Z15L5ER	15 x 24 x 53.5	140	14.25	\$1376	\$1410	\$326	\$87
Z16M5ER	16 x 20 x 53.5	130	13	\$1329	\$1364	\$365	\$87
Z15M5ER	15 x 20 x 53.5	126	12.25	\$1275	\$1305	\$326	\$87
Z16S5ER	16 x 16 x 53.5	109	10.5	\$1218	\$1252	\$365	\$69
Z15S5ER	15 x 16 x 53.5	105	9.75	\$1197	\$1226	\$326	\$69

Two file drawers on bottom. Laminate door is standard. **Includes one 3-position fixed/height adjustable shelf.** Upper lock secures storage compartment. Lower lock secures two file drawers. Ganging hardware included with all units 24" wide or less and 41"H or taller. Shipped assembled in 1 carton.



\* Accepts collator 11" high  
\*\* Accepts collator 11.3" high

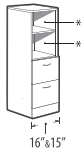
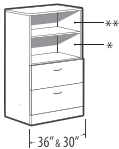

Two File Module with Open Shelves\*

Z36L5EN	36 x 24 x 53.5	235	31.25	\$2197	\$2266	N/A	\$171
Z30L5EN	30 x 24 x 53.5	210	27	\$2056	\$2118	N/A	\$144
Z16L5EN	16 x 24 x 53.5	138	15.5	\$1291	\$1333	N/A	\$87
Z15L5EN	15 x 24 x 53.5	134	14.25	\$1252	\$1286	N/A	\$87
Z36M5EN	36 x 20 x 53.5	213	27	\$2086	\$2148	N/A	\$171
Z30M5EN	30 x 20 x 53.5	188	22.75	\$1898	\$1950	N/A	\$144
Z16M5EN	16 x 20 x 53.5	123	13	\$1194	\$1229	N/A	\$87
Z15M5EN	15 x 20 x 53.5	119	12.25	\$1155	\$1185	N/A	\$87
Z36S5EN	36 x 16 x 53.5	179	21.75	\$1808	\$1869	N/A	\$128
Z30S5EN	30 x 16 x 53.5	158	18.5	\$1668	\$1710	N/A	\$114
Z16S5EN	16 x 16 x 53.5	102	10.5	\$1082	\$1116	N/A	\$69
Z15S5EN	15 x 16 x 53.5	98	9.75	\$1073	\$1102	N/A	\$69

Two open shelves and two file drawers on bottom. **Includes one 3-position fixed/height adjustable shelf.** Lock secures all drawers. 36" and 30" wide models have front-to-back and side-to-side letter/legal filing capability. Side-to-side file bars included. Ganging hardware included with all units 24" wide or less and 41"H or taller. Shipped assembled in 1 carton.

- Lateral file drawer construction is for accommodating hanging files NOT for stacking materials on the drawer bottoms.



Four File Module

Z36L54F	36 x 24 x 53.5	256	31.25	\$2776	\$2845	N/A	\$171
Z30L54F	30 x 24 x 53.5	234	27	\$2662	\$2724	N/A	\$144
Z16L54F	16 x 24 x 53.5	155	15.5	\$1594	\$1636	N/A	\$87
Z15L54F	15 x 24 x 53.5	148	14.25	\$1540	\$1574	N/A	\$87
Z36M54F	36 x 20 x 53.5	239	27	\$2694	\$2756	N/A	\$171
Z30M54F	30 x 20 x 53.5	218	22.75	\$2528	\$2580	N/A	\$144
Z16M54F	16 x 20 x 53.5	142	13	\$1502	\$1537	N/A	\$87
Z15M54F	15 x 20 x 53.5	137	12.25	\$1449	\$1479	N/A	\$87
Z36S54F	36 x 16 x 53.5	205	21.75	\$2408	\$2469	N/A	\$128
Z30S54F	30 x 16 x 53.5	180	18.5	\$2192	\$2234	N/A	\$114
Z16S54F	16 x 16 x 53.5	122	10.5	\$1477	\$1511	N/A	\$69
Z15S54F	15 x 16 x 53.5	116	9.75	\$1421	\$1450	N/A	\$69

Four file drawers. Lock secures all drawers. 36" and 30" wide models have front-to-back and side-to-side letter/legal filing capability. Side-to-side file bars included. Ganging hardware included with all units 24" wide or less and 41"H or taller. Shipped assembled in 1 carton.

- Lateral file drawer construction is for accommodating hanging files NOT for stacking materials on the drawer bottoms.



Four File Module

Z36L5S4F	36 x 24 x 53.5	286	31.25	\$3322	\$3391	N/A	\$171
Z36M5S4F	36 x 20 x 53.5	269	27	\$3223	\$3286	N/A	\$171

Four file drawers with **steel drawer interior.** Steel drawer construction includes metal sides and masonite bottoms. Lock secures all drawers. Front-to-back and side-to-side letter/legal filing capability. Side-to-side file bars included. Shipped assembled in 1 carton.

- Front-to-back filing bars available separately. Order **FBB** bars. See Metal Filing + Storage price list page 14.
- Lateral file drawer construction is for accommodating hanging files NOT for stacking materials on the drawer bottoms.

Required specifications

Top finish  
Top thickness/edge detail  
Base finish  
Handles

Optional specifications

HP laminate  
Key #  
Box drawer - no upcharge  
Collator - position & finish\*  
Glazed door\*\*

**STORAGE MODULES - 65.5" / 66" HIGH**      **MODEL #**      **DIMENSIONS**      **WT/LB.**      **CUBIC FT.**      **1" TOP**      **1.5" TOP**      **GLAZE ADD**      **HP ADD**

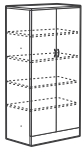

Glazed door option

**Storage Cabinet with Doors**

**W x D x H (1.5" TOP)**

Z36L6SH	36 x 24 x 66	273	39	<b>\$2149</b>	<b>\$2218</b>	<b>\$1409</b>	N/A
Z30L6SH	30 x 24 x 66	238	32.75	<b>\$1880</b>	<b>\$1942</b>	<b>\$1219</b>	N/A
Z36M6SH	36 x 20 x 66	247	33.25	<b>\$1992</b>	<b>\$2054</b>	<b>\$1409</b>	N/A
Z30M6SH	30 x 20 x 66	212	27.75	<b>\$1737</b>	<b>\$1789</b>	<b>\$1219</b>	N/A
Z36S6SH	36 x 16 x 66	210	26.5	<b>\$1805</b>	<b>\$1866</b>	<b>\$1409</b>	N/A
Z30S6SH	30 x 16 x 66	184	22.5	<b>\$1552</b>	<b>\$1594</b>	<b>\$1219</b>	N/A

Laminate doors are standard. **Includes four 3-position fixed/height adjustable shelves.** Standard with lock. Shipped assembled in 1 carton.



Glazed door option

**Storage Cabinet with Door - LEFT**

Z21L6SHL	21 x 24 x 66	186	23.5	<b>\$1540</b>	<b>\$1590</b>	<b>\$780</b>	N/A
Z18L6SHL	18 x 24 x 66	168	20.5	<b>\$1438</b>	<b>\$1480</b>	<b>\$699</b>	N/A
Z16L6SHL	16 x 24 x 66	156	18.75	<b>\$1352</b>	<b>\$1394</b>	<b>\$693</b>	N/A
Z15L6SHL	15 x 24 x 66	149	17.5	<b>\$1313</b>	<b>\$1347</b>	<b>\$603</b>	N/A
Z12L6SHL	12 x 24 x 66	133	14.5	<b>\$1194</b>	<b>\$1224</b>	<b>\$543</b>	N/A
Z21M6SHL	21 x 20 x 66	170	20	<b>\$1377</b>	<b>\$1419</b>	<b>\$780</b>	N/A
Z18M6SHL	18 x 20 x 66	148	17.25	<b>\$1313</b>	<b>\$1348</b>	<b>\$699</b>	N/A
Z16M6SHL	16 x 20 x 66	138	15.75	<b>\$1235</b>	<b>\$1270</b>	<b>\$693</b>	N/A
Z15M6SHL	15 x 20 x 66	133	14.75	<b>\$1176</b>	<b>\$1206</b>	<b>\$603</b>	N/A
Z12M6SHL	12 x 20 x 66	117	12.25	<b>\$1091</b>	<b>\$1116</b>	<b>\$543</b>	N/A
Z21S6SHL	21 x 16 x 66	141	16	<b>\$1271</b>	<b>\$1304</b>	<b>\$780</b>	N/A
Z18S6SHL	18 x 16 x 66	126	14	<b>\$1174</b>	<b>\$1208</b>	<b>\$699</b>	N/A
Z16S6SHL	16 x 16 x 66	117	13	<b>\$1103</b>	<b>\$1137</b>	<b>\$693</b>	N/A
Z15S6SHL	15 x 16 x 66	111	12	<b>\$1049</b>	<b>\$1078</b>	<b>\$603</b>	N/A
Z12S6SHL	12 x 16 x 66	97	10	<b>\$963</b>	<b>\$988</b>	<b>\$543</b>	N/A

Laminate doors are standard. **Includes four 3-position fixed/height adjustable shelves.** Standard with lock. Ganging hardware included with all units 24" wide or less and 41"H or taller. Shipped assembled in 1 carton.

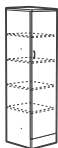

Glazed door option

**Storage Cabinet with Door - RIGHT**

Z21L6SHR	21 x 24 x 66	186	23.5	<b>\$1540</b>	<b>\$1590</b>	<b>\$780</b>	N/A
Z18L6SHR	18 x 24 x 66	168	20.5	<b>\$1438</b>	<b>\$1480</b>	<b>\$699</b>	N/A
Z16L6SHR	16 x 24 x 66	156	18.75	<b>\$1352</b>	<b>\$1394</b>	<b>\$693</b>	N/A
Z15L6SHR	15 x 24 x 66	149	17.5	<b>\$1313</b>	<b>\$1347</b>	<b>\$603</b>	N/A
Z12L6SHR	12 x 24 x 66	133	14.5	<b>\$1194</b>	<b>\$1224</b>	<b>\$543</b>	N/A
Z21M6SHR	21 x 20 x 66	170	20	<b>\$1377</b>	<b>\$1419</b>	<b>\$780</b>	N/A
Z18M6SHR	18 x 20 x 66	148	17.25	<b>\$1313</b>	<b>\$1348</b>	<b>\$699</b>	N/A
Z16M6SHR	16 x 20 x 66	138	15.75	<b>\$1235</b>	<b>\$1270</b>	<b>\$693</b>	N/A
Z15M6SHR	15 x 20 x 66	133	14.75	<b>\$1176</b>	<b>\$1206</b>	<b>\$603</b>	N/A
Z12M6SHR	12 x 20 x 66	117	12.25	<b>\$1091</b>	<b>\$1116</b>	<b>\$543</b>	N/A
Z21S6SHR	21 x 16 x 66	141	16	<b>\$1271</b>	<b>\$1304</b>	<b>\$780</b>	N/A
Z18S6SHR	18 x 16 x 66	126	14	<b>\$1174</b>	<b>\$1208</b>	<b>\$699</b>	N/A
Z16S6SHR	16 x 16 x 66	117	13	<b>\$1103</b>	<b>\$1137</b>	<b>\$693</b>	N/A
Z15S6SHR	15 x 16 x 66	111	12	<b>\$1049</b>	<b>\$1078</b>	<b>\$603</b>	N/A
Z12S6SHR	12 x 16 x 66	97	10	<b>\$963</b>	<b>\$988</b>	<b>\$543</b>	N/A

Laminate doors are standard. **Includes four 3-position fixed/height adjustable shelves.** Standard with lock. Ganging hardware included with all units 24" wide or less and 41"H or taller. Shipped assembled in 1 carton.

**Required specifications**

- Top finish
- Top thickness/edge detail
- Base finish
- Handles

**Optional specifications**

- HP laminate
- Key #

STORAGE MODULES - 53" / 53.5" HIGH

MODEL #	DIMENSIONS	WT/LB.	CUBIC FT.	1" TOP	1.5" TOP	GLAZE ADD	HP ADD
---------	------------	--------	-----------	--------	----------	-----------	--------

W x D x H (1.5" TOP)

Z36L6SHN	36 x 24 x 66	234	39	\$1665	\$1734	N/A	N/A
Z30L6SHN	30 x 24 x 66	205	32.75	\$1474	\$1536	N/A	N/A
Z21L6SHN	21 x 24 x 66	163	23.5	\$1280	\$1330	N/A	N/A
Z18L6SHN	18 x 24 x 66	149	20.5	\$1202	\$1244	N/A	N/A
Z16L6SHN	16 x 24 x 66	140	18.75	\$1118	\$1160	N/A	N/A
Z15L6SHN	15 x 24 x 66	134	17.5	\$1106	\$1140	N/A	N/A
Z12L6SHN	12 x 24 x 66	120	14.5	\$1003	\$1033	N/A	N/A
Z36M6SHN	36 x 20 x 66	206	33.25	\$1506	\$1568	N/A	N/A
Z30M6SHN	30 x 20 x 66	179	27.75	\$1333	\$1385	N/A	N/A
Z21M6SHN	21 x 20 x 66	146	20	\$1118	\$1160	N/A	N/A
Z18M6SHN	18 x 20 x 66	128	17.25	\$1080	\$1115	N/A	N/A
Z16M6SHN	16 x 20 x 66	120	15.75	\$1000	\$1035	N/A	N/A
Z15M6SHN	15 x 20 x 66	117	14.75	\$971	\$1001	N/A	N/A
Z12M6SHN	12 x 20 x 66	102	12.25	\$902	\$927	N/A	N/A
Z36S6SHN	36 x 16 x 66	173	26.5	\$1318	\$1379	N/A	N/A
Z30S6SHN	30 x 16 x 66	152	22.5	\$1146	\$1188	N/A	N/A
Z21S6SHN	21 x 16 x 66	118	16	\$1007	\$1040	N/A	N/A
Z18S6SHN	18 x 16 x 66	106	14	\$938	\$972	N/A	N/A
Z16S6SHN	16 x 16 x 66	99	13	\$872	\$906	N/A	N/A
Z15S6SHN	15 x 16 x 66	95	12	\$843	\$872	N/A	N/A
Z12S6SHN	12 x 16 x 66	84	10	\$773	\$798	N/A	N/A



\* Accepts collator 11" high  
\*\* Accepts collator 11.3" high

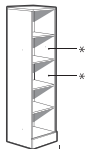
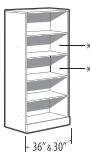

Open Storage Cabinet\*

Includes four 3-position fixed/height adjustable shelves. Ganging hardware included with all units 24" wide or less and 41"H or taller. Ganging hardware included with all units 24" wide or less and 41"H or taller. Shipped assembled in 1 carton.

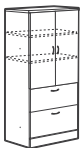

Glazed door option

Two File Module with Doors\*\*

Z36L6E	36 x 24 x 66	294	39	\$2713	\$2782	\$972	N/A
Z30L6E	30 x 24 x 66	260	32.75	\$2478	\$2540	\$851	N/A
Z36M6E	36 x 20 x 66	270	33.25	\$2598	\$2660	\$972	N/A
Z30M6E	30 x 20 x 66	236	27.75	\$2351	\$2403	\$851	N/A
Z36S6E	36 x 16 x 66	225	26.5	\$2221	\$2282	\$972	N/A
Z30S6E	30 x 16 x 66	197	22.5	\$2126	\$2168	\$851	N/A

Two lateral file drawers on bottom. Laminate doors are standard. Includes two 3-position fixed/height adjustable shelves. Upper lock secures storage compartment. Lower lock secures two file drawers. Front-to-back and side-to-side letter/legal filing capability. Side-to-side file bars included. Shipped assembled in 1 carton.

- Lateral file drawer construction is for accommodating hanging files NOT for stacking materials on the drawer bottom.

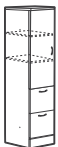

Glazed door option

Two File Module with Door - LEFT\*\*

Z16L6EL	16 x 24 x 66	171	18.75	\$1603	\$1645	\$473	N/A
Z15L6EL	15 x 24 x 66	164	17.5	\$1566	\$1600	\$420	N/A
Z16M6EL	16 x 20 x 66	153	15.75	\$1493	\$1528	\$473	N/A
Z15M6EL	15 x 20 x 66	148	14.75	\$1438	\$1468	\$420	N/A
Z16S6EL	16 x 16 x 66	129	13	\$1363	\$1397	\$473	N/A
Z15S6EL	15 x 16 x 66	124	12	\$1320	\$1349	\$420	N/A

Two file drawers on bottom. Laminate door is standard. Includes two 3-position fixed/height adjustable shelves. Upper lock secures storage compartment. Lower lock secures two file drawers. Ganging hardware included with all units 24" wide or less and 41"H or taller. Shipped assembled in 1 carton.

Required specifications

Top finish  
Top thickness/edge detail  
Base finish  
Handles

Optional specifications

HP laminate  
Key #  
Collator - position & finish\*  
Glazed door\*\*



**STORAGE MODULES - 65.5" / 66" HIGH**



Glazed door option

**Two File Module with Door - RIGHT\***

MODEL #	DIMENSIONS W x D x H (1.5" TOP)	WT/LB.	CUBIC FT.	1" TOP	1.5" TOP	GLAZE ADD	HP ADD
Z16L6ER	16 x 24 x 66	171	18.75	<b>\$1603</b>	<b>\$1645</b>	<b>\$473</b>	N/A
Z15L6ER	15 x 24 x 66	164	17.5	<b>\$1566</b>	<b>\$1600</b>	<b>\$420</b>	N/A
Z16M6ER	16 x 20 x 66	153	15.75	<b>\$1493</b>	<b>\$1528</b>	<b>\$473</b>	N/A
Z15M6ER	15 x 20 x 66	148	14.75	<b>\$1438</b>	<b>\$1468</b>	<b>\$420</b>	N/A
Z16S6ER	16 x 16 x 66	129	13	<b>\$1363</b>	<b>\$1397</b>	<b>\$473</b>	N/A
Z15S6ER	15 x 16 x 66	124	12	<b>\$1320</b>	<b>\$1349</b>	<b>\$420</b>	N/A

Two file drawers on bottom. Laminate door is standard. **Includes two 3-position fixed/height adjustable shelves.** Upper lock secures storage compartment. Lower lock secures two file drawers. Ganging hardware included with all units 24" wide or less and 41"H or taller. Shipped assembled in 1 carton.

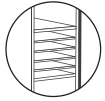

\* Accepts collator 11" high

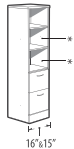
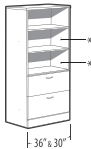

**Two File Module with Open Shelves\*\***

Z36L6EN	36 x 24 x 66	271	39	<b>\$2367</b>	<b>\$2436</b>	N/A	N/A
Z30L6EN	30 x 24 x 66	241	32.75	<b>\$2169</b>	<b>\$2231</b>	N/A	N/A
Z16L6EN	16 x 24 x 66	162	18.75	<b>\$1440</b>	<b>\$1482</b>	N/A	N/A
Z15L6EN	15 x 24 x 66	156	17.5	<b>\$1419</b>	<b>\$1453</b>	N/A	N/A
Z36M6EN	36 x 20 x 66	243	33.25	<b>\$2253</b>	<b>\$2315</b>	N/A	N/A
Z30M6EN	30 x 20 x 66	214	27.75	<b>\$2039</b>	<b>\$2091</b>	N/A	N/A
Z16M6EN	16 x 20 x 66	143	15.75	<b>\$1329</b>	<b>\$1364</b>	N/A	N/A
Z15M6EN	15 x 20 x 66	138	14.75	<b>\$1289</b>	<b>\$1319</b>	N/A	N/A
Z36S6EN	36 x 16 x 66	202	26.5	<b>\$1877</b>	<b>\$1938</b>	N/A	N/A
Z30S6EN	30 x 16 x 66	178	22.5	<b>\$1816</b>	<b>\$1858</b>	N/A	N/A
Z16S6EN	16 x 16 x 66	119	13	<b>\$1197</b>	<b>\$1231</b>	N/A	N/A
Z15S6EN	15 x 16 x 66	114	12	<b>\$1169</b>	<b>\$1198</b>	N/A	N/A

Three open shelves and two file drawers on bottom. **Includes two 3-position fixed/height adjustable shelves.** Lock secures all drawers. 36" and 30" wide models have front-to-back and side-to-side letter/legal filing capability. Side-to-side file bars included. Ganging hardware included with all units 24" wide or less and 41"H or taller. Shipped assembled in 1 carton.

- Lateral file drawer construction is for accommodating hanging files NOT for stacking materials on the drawer bottom.

**WARDROBE CABINETS - 65.6" / 66" HIGH**

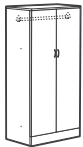

**Wardrobe Cabinet**

MODEL #	DIMENSIONS W x D x H (1.5" TOP)	WT/LB.	CUBIC FT.	1" TOP	1.5" TOP	GLAZE ADD	HP ADD
Z36L6WA	36 x 24 x 66	216	39	<b>\$1841</b>	<b>\$1910</b>	N/A	N/A
Z30L6WA	30 x 24 x 66	192	32.75	<b>\$1654</b>	<b>\$1716</b>	N/A	N/A
Z36M6WA	36 x 20 x 66	201	33.25	<b>\$1766</b>	<b>\$1828</b>	N/A	N/A
Z30M6WA	30 x 20 x 66	173	27.75	<b>\$1561</b>	<b>\$1613</b>	N/A	N/A

Laminate doors are standard. Full length hanging rod included. Standard with lock. Shipped assembled in 1 carton.

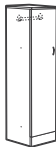

**Wardrobe Cabinet - LEFT**

Z24L6WAL	24 x 24 x 66	166	26.75	<b>\$1517</b>	<b>\$1568</b>	N/A	N/A
Z21L6WAL	21 x 24 x 66	152	23.5	<b>\$1394</b>	<b>\$1444</b>	N/A	N/A
Z18L6WAL	18 x 24 x 66	140	20.5	<b>\$1244</b>	<b>\$1286</b>	N/A	N/A
Z16L6WAL	16 x 24 x 66	132	18.75	<b>\$1212</b>	<b>\$1254</b>	N/A	N/A
Z15L6WAL	15 x 24 x 66	128	17.5	<b>\$1164</b>	<b>\$1198</b>	N/A	N/A
Z12L6WAL	12 x 24 x 66	116	14.5	<b>\$1073</b>	<b>\$1103</b>	N/A	N/A
Z24M6WAL	24 x 20 x 66	149	22.5	<b>\$1304</b>	<b>\$1346</b>	N/A	N/A
Z21M6WAL	21 x 20 x 66	144	20	<b>\$1263</b>	<b>\$1305</b>	N/A	N/A
Z18M6WAL	18 x 20 x 66	125	17.25	<b>\$1146</b>	<b>\$1181</b>	N/A	N/A
Z16M6WAL	16 x 20 x 66	117	15.75	<b>\$1118</b>	<b>\$1153</b>	N/A	N/A
Z15M6WAL	15 x 20 x 66	113	14.75	<b>\$1051</b>	<b>\$1081</b>	N/A	N/A
Z12M6WAL	12 x 20 x 66	103	12.25	<b>\$1000</b>	<b>\$1025</b>	N/A	N/A

Laminate doors are standard. Full length hanging rod included. Standard with lock. Ganging hardware included with all units 24" wide or less and 41"H or taller. Shipped assembled in 1 carton.

**Required specifications**

- Top finish
- Top thickness/edge detail
- Base finish
- Handles

**Optional specifications**

- Key #
- Box drawer - no upcharge
- Collator - position & finish\*\*
- Glazed door\*

WARDROBE CABINETS - 65.5" / 66" HIGH

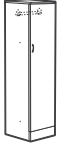

Wardrobe Cabinet - RIGHT

MODEL #	DIMENSIONS W x D x H (1.5" TOP)	WT/LB.	CUBIC FT.	1" TOP	1.5" TOP	GLAZE ADD	HP ADD
Z24L6WAR	24 x 24 x 66	166	26.75	\$1517	\$1568	N/A	N/A
Z21L6WAR	21 x 24 x 66	152	23.5	\$1394	\$1444	N/A	N/A
Z18L6WAR	18 x 24 x 66	140	20.5	\$1244	\$1286	N/A	N/A
Z16L6WAR	16 x 24 x 66	132	18.75	\$1212	\$1254	N/A	N/A
Z15L6WAR	15 x 24 x 66	128	17.5	\$1164	\$1198	N/A	N/A
Z12L6WAR	12 x 24 x 66	116	14.5	\$1073	\$1103	N/A	N/A
Z24M6WAR	24 x 20 x 66	149	22.5	\$1304	\$1346	N/A	N/A
Z21M6WAR	21 x 20 x 66	144	20	\$1263	\$1305	N/A	N/A
Z18M6WAR	18 x 20 x 66	125	17.25	\$1146	\$1181	N/A	N/A
Z16M6WAR	16 x 20 x 66	117	15.75	\$1118	\$1153	N/A	N/A
Z15M6WAR	15 x 20 x 66	113	14.75	\$1051	\$1081	N/A	N/A
Z12M6WAR	12 x 20 x 66	103	12.25	\$1000	\$1025	N/A	N/A

Laminate doors are standard. Full length hanging rod included. Standard with lock. Ganging hardware included with all units 24" wide or less and 41"H or taller. Shipped assembled in 1 carton.

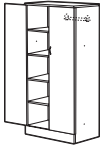

Glazed door option

Wardrobe Cabinet/Shelving Combo with Doors - LEFT\*

Z36L6DIL	36 x 24 x 66	270	39	\$2199	\$2268	\$1409	N/A
Z30L6DIL	30 x 24 x 66	240	32.75	\$1945	\$2007	\$1219	N/A
Z24L6DIL	24 x 24 x 66	209	26.75	\$1817	\$1868	\$1099	N/A
Z21L6DIL	21 x 24 x 66	193	23.5	\$1707	\$1757	\$1091	N/A
Z36M6DIL	36 x 20 x 66	244	33.25	\$2070	\$2132	\$1409	N/A
Z30M6DIL	30 x 20 x 66	227	27.75	\$1806	\$1858	\$1219	N/A
Z24M6DIL	24 x 20 x 66	185	22.5	\$1619	\$1661	\$1099	N/A
Z21M6DIL	21 x 20 x 66	171	20	\$1573	\$1615	\$1091	N/A

Laminate doors are standard. Storage compartment on **left** includes four 3-position fixed/height adjustable shelves. Wardrobe compartment on **right** includes hanging rod. Two locks secure storage and wardrobe compartments. Ganging hardware included with all units 24" wide or less and 41"H or taller. Shipped assembled in 1 carton.

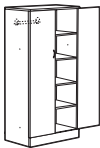

Glazed door option

Wardrobe Cabinet/Shelving Combo with Doors - RIGHT

Z36L6DIR	36 x 24 x 66	270	39	\$2199	\$2268	\$1409	N/A
Z30L6DIR	30 x 24 x 66	240	32.75	\$1945	\$2007	\$1219	N/A
Z24L6DIR	24 x 24 x 66	209	26.75	\$1817	\$1868	\$1099	N/A
Z21L6DIR	21 x 24 x 66	193	23.5	\$1707	\$1757	\$1091	N/A
Z36M6DIR	36 x 20 x 66	244	33.25	\$2070	\$2132	\$1409	N/A
Z30M6DIR	30 x 20 x 66	227	27.75	\$1806	\$1858	\$1219	N/A
Z24M6DIR	24 x 20 x 66	185	22.5	\$1619	\$1661	\$1099	N/A
Z21M6DIR	21 x 20 x 66	171	20	\$1573	\$1615	\$1091	N/A

Laminate doors are standard. Storage compartment on **right** includes four 3-position fixed/height adjustable shelves. Wardrobe compartment on **left** includes hanging rod. Two locks secure storage and wardrobe compartments. Ganging hardware included with all units 24" wide or less and 41"H or taller. Shipped assembled in 1 carton.

Required specifications

- Top finish
- Top thickness/edge detail
- Base finish
- Handles

Optional specifications

- Key #
- Glazed door\*

**WARDROBE CABINETS - 65.5" / 66" HIGH**      **MODEL #**      **DIMENSIONS**      **WT/LB.**      **CUBIC FT.**      **1" TOP**      **1.5" TOP**      **GLAZE ADD**      **HP ADD**

**W x D x H (1.5" TOP)**

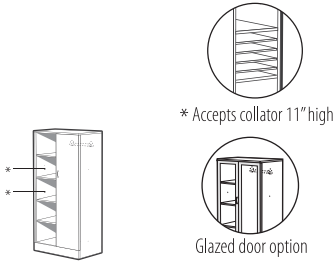

**Wardrobe Cabinet/Open Shelving Combo - LEFT**

Z36L6DINL	36 x 24 x 66	252	39	<b>\$1968</b>	<b>\$2037</b>	<b>\$700</b>	N/A
Z30L6DINL	30 x 24 x 66	224	32.75	<b>\$1756</b>	<b>\$1818</b>	<b>\$606</b>	N/A
Z24L6DINL	24 x 24 x 66	196	26.75	<b>\$1653</b>	<b>\$1704</b>	<b>\$546</b>	N/A
Z21L6DINL	21 x 24 x 66	183	23.5	<b>\$1542</b>	<b>\$1592</b>	<b>\$540</b>	N/A
Z36M6DINL	36 x 20 x 66	223	33.25	<b>\$1838</b>	<b>\$1900</b>	<b>\$700</b>	N/A
Z30M6DINL	30 x 20 x 66	198	27.75	<b>\$1610</b>	<b>\$1662</b>	<b>\$606</b>	N/A
Z24M6DINL	24 x 20 x 66	174	22.5	<b>\$1456</b>	<b>\$1498</b>	<b>\$546</b>	N/A
Z21M6DINL	21 x 20 x 66	159	20	<b>\$1410</b>	<b>\$1452</b>	<b>\$540</b>	N/A

Laminate door is standard. Storage compartment on **left includes four 3-position fixed/height adjustable shelves**. Wardrobe compartment on **right** includes hanging rod. Single lock secures wardrobe compartment. Ganging hardware included with all units 24" wide or less and 41"H or taller. Shipped assembled in 1 carton.

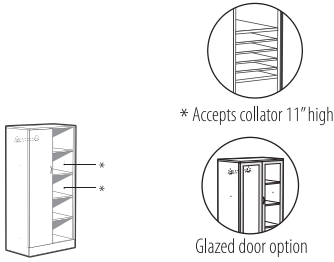

**Wardrobe Cabinet/Open Shelving Combo - RIGHT**

Z36L6DINR	36 x 24 x 66	252	39	<b>\$1968</b>	<b>\$2037</b>	<b>\$700</b>	N/A
Z30L6DINR	30 x 24 x 66	224	32.75	<b>\$1756</b>	<b>\$1818</b>	<b>\$606</b>	N/A
Z24L6DINR	24 x 24 x 66	196	26.75	<b>\$1653</b>	<b>\$1704</b>	<b>\$546</b>	N/A
Z21L6DINR	21 x 24 x 66	183	23.5	<b>\$1542</b>	<b>\$1592</b>	<b>\$540</b>	N/A
Z36M6DINR	36 x 20 x 66	223	33.25	<b>\$1838</b>	<b>\$1900</b>	<b>\$700</b>	N/A
Z30M6DINR	30 x 20 x 66	198	27.75	<b>\$1610</b>	<b>\$1662</b>	<b>\$606</b>	N/A
Z24M6DINR	24 x 20 x 66	174	22.5	<b>\$1456</b>	<b>\$1498</b>	<b>\$546</b>	N/A
Z21M6DINR	21 x 20 x 66	159	20	<b>\$1410</b>	<b>\$1452</b>	<b>\$540</b>	N/A

Laminate door is standard. Storage compartment on **right includes four 3-position fixed/height adjustable shelves**. Wardrobe compartment on **left** includes hanging rod. Single lock secures wardrobe compartment. Ganging hardware included with all units 24" wide or less and 41"H or taller. Shipped assembled in 1 carton.

**Required specifications**

- Top finish
- Top thickness/edge detail
- Base finish
- Handles

**Optional specifications**

- Key #
- Collator - position & finish
- Glazed door

PERSONAL TOWERS - 65.5" / 66" HIGH

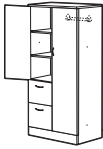

Glazed door option

Personal Tower with Doors - LEFT

MODEL #	DIMENSIONS W x D x H (1.5" TOP)	WT/LB.	CUBIC FT.	1" TOP	1.5" TOP	GLAZE ADD	HP ADD
Z36L6EL	36 x 24 x 66	291	39	\$2412	\$2481	\$1181	N/A
Z30L6EL	30 x 24 x 66	267	32.75	\$2235	\$2297	\$1076	N/A
Z24L6EL	24 x 24 x 66	243	26.75	\$2141	\$2192	\$942	N/A
Z36M6EL	36 x 20 x 66	256	33.25	\$2283	\$2345	\$1181	N/A
Z30M6EL	30 x 20 x 66	230	27.75	\$2086	\$2138	\$1076	N/A
Z24M6EL	24 x 20 x 66	217	22.5	\$1999	\$2041	\$942	N/A

**Two file drawers** on bottom. Laminate doors are standard. Storage compartment on **left includes two 3-position fixed/height adjustable shelves**. Wardrobe compartment on **right** includes hanging rod. Two upper locks (one per each hinged door) and one lower lock secures drawers, all keyed alike. Ganging hardware included with all units 24" wide or less and 41"H or taller. Shipped assembled in 1 carton.



Glazed door option

Personal Tower with Doors - RIGHT

Z36L6ER	36 x 24 x 66	291	39	\$2412	\$2481	\$1181	N/A
Z30L6ER	30 x 24 x 66	267	32.75	\$2235	\$2297	\$1076	N/A
Z24L6ER	24 x 24 x 66	243	26.75	\$2141	\$2192	\$942	N/A
Z36M6ER	36 x 20 x 66	256	33.25	\$2283	\$2345	\$1181	N/A
Z30M6ER	30 x 20 x 66	230	27.75	\$2086	\$2138	\$1076	N/A
Z24M6ER	24 x 20 x 66	217	22.5	\$1999	\$2041	\$942	N/A

**Two file drawers** on bottom. Laminate doors are standard. Storage compartment on **right includes two 3-position fixed/height adjustable shelves**. Wardrobe compartment on **left** includes hanging rod. Two upper locks (one per each hinged door) and one lower lock secures drawers, all keyed alike. Ganging hardware included with all units 24" wide or less and 41"H or taller. Shipped assembled in 1 carton.

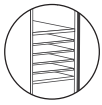
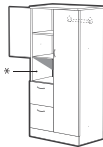

\* Accepts collator 11" high



Glazed door option

Personal Tower with Doors and Cavity - LEFT

Z36L6ECL	36 x 24 x 66	289	39	\$2383	\$2452	\$1128	N/A
Z30L6ECL	30 x 24 x 66	264	32.75	\$2202	\$2264	\$1022	N/A
Z24L6ECL	24 x 24 x 66	239	26.75	\$2110	\$2161	\$887	N/A
Z36M6ECL	36 x 20 x 66	252	33.25	\$2243	\$2305	\$1128	N/A
Z30M6ECL	30 x 20 x 66	227	27.75	\$2043	\$2095	\$1022	N/A
Z24M6ECL	24 x 20 x 66	213	22.5	\$1971	\$2013	\$887	N/A

**Two file drawers** on bottom. Laminate doors are standard. Storage compartment on **left includes one 3-position fixed/height adjustable shelf**. Wardrobe compartment on **right** includes hanging rod. Two upper locks (one per each hinged door) and one lower lock secures drawers, all keyed alike. Ganging hardware included with all units 24" wide or less and 41"H or taller. Shipped assembled in 1 carton.

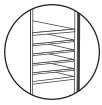
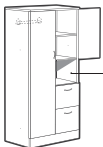

\* Accepts collator 11" high



Glazed door option

Personal Tower with Doors and cavity - RIGHT

Z36L6ECR	36 x 24 x 66	289	39	\$2383	\$2452	\$1128	N/A
Z30L6ECR	30 x 24 x 66	264	32.75	\$2202	\$2264	\$1022	N/A
Z24L6ECR	24 x 24 x 66	239	26.75	\$2110	\$2161	\$887	N/A
Z36M6ECR	36 x 20 x 66	252	33.25	\$2243	\$2305	\$1128	N/A
Z30M6ECR	30 x 20 x 66	227	27.75	\$2043	\$2095	\$1022	N/A
Z24M6ECR	24 x 20 x 66	213	22.5	\$1971	\$2013	\$887	N/A

**Two file drawers** on bottom. Laminate doors are standard. Storage compartment on **right includes one 3-position fixed/height adjustable shelf**. Wardrobe compartment on **left** includes hanging rod. Two upper locks (one per each hinged door) and one lower lock secures drawers, all keyed alike. Ganging hardware included with all units 24" wide or less and 41"H or taller. Shipped assembled in 1 carton.

Required specifications

Top finish  
Top thickness/edge detail  
Base finish  
Handles

Optional specifications

Key #  
Box drawer - no upcharge  
Collator - position & finish  
Glazed door

**PERSONAL TOWERS - 65.5" / 66" HIGH**      **MODEL #**      **DIMENSIONS**      **WT/LB.**      **CUBIC FT.**      **1" TOP**      **1.5" TOP**      **GLAZE ADD**      **HP ADD**

**W x D x H (1.5" TOP)**

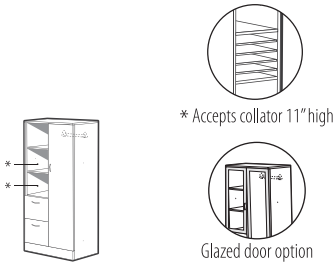

**Personal Tower with Open Shelves - LEFT**

Z36L6ENL	36 x 24 x 66	280	39	<b>\$2251</b>	<b>\$2320</b>	<b>\$705</b>	N/A
Z30L6ENL	30 x 24 x 66	257	32.75	<b>\$2070</b>	<b>\$2132</b>	<b>\$601</b>	N/A
Z24L6ENL	24 x 24 x 66	230	26.75	<b>\$1980</b>	<b>\$2031</b>	<b>\$468</b>	N/A
Z36M6ENL	36 x 20 x 66	244	33.25	<b>\$2109</b>	<b>\$2171</b>	<b>\$705</b>	N/A
Z30M6ENL	30 x 20 x 66	220	27.75	<b>\$1912</b>	<b>\$1964</b>	<b>\$601</b>	N/A
Z24M6ENL	24 x 20 x 66	204	22.5	<b>\$1812</b>	<b>\$1869</b>	<b>\$468</b>	N/A

**Two file drawers** on bottom. Laminate doors are standard on wardrobe section. Storage compartment on **left** includes **two 3-position fixed/height adjustable shelves**. Wardrobe compartment on **right** includes hanging rod. Upper lock secures wardrobe compartment. Lower lock secures all drawers. Ganging hardware included with all units 24" wide or less and 41"H or taller. Shipped assembled in 1 carton.

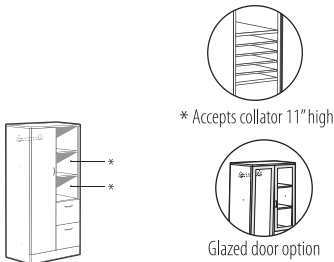

**Personal Tower with Open Shelves - RIGHT**

Z36L6ENR	36 x 24 x 66	280	39	<b>\$2251</b>	<b>\$2320</b>	<b>\$705</b>	N/A
Z30L6ENR	30 x 24 x 66	257	32.75	<b>\$2070</b>	<b>\$2132</b>	<b>\$601</b>	N/A
Z24L6ENR	24 x 24 x 66	230	26.75	<b>\$1980</b>	<b>\$2031</b>	<b>\$468</b>	N/A
Z36M6ENR	36 x 20 x 66	244	33.25	<b>\$2109</b>	<b>\$2171</b>	<b>\$705</b>	N/A
Z30M6ENR	30 x 20 x 66	220	27.75	<b>\$1912</b>	<b>\$1964</b>	<b>\$601</b>	N/A
Z24M6ENR	24 x 20 x 66	204	22.5	<b>\$1812</b>	<b>\$1869</b>	<b>\$468</b>	N/A

**Two file drawers** on bottom. Laminate doors is standard on wardrobe section. Storage compartment on **right** includes **two 3-position fixed/height adjustable shelves**. Wardrobe compartment on **left** includes hanging rod. Upper lock secures wardrobe compartment. Lower lock secures all drawers. Ganging hardware included with all units 24" wide or less and 41"H or taller. Shipped assembled in 1 carton.

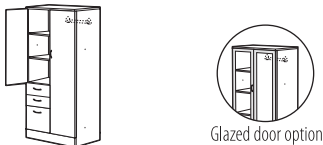

**Personal Tower with Doors - LEFT**

Z36L6BFL	36 x 24 x 66	294	39	<b>\$2538</b>	<b>\$2607</b>	<b>\$1181</b>	N/A
Z30L6BFL	30 x 24 x 66	269	32.75	<b>\$2360</b>	<b>\$2422</b>	<b>\$1076</b>	N/A
Z24L6BFL	24 x 24 x 66	244	26.75	<b>\$2242</b>	<b>\$2293</b>	<b>\$942</b>	N/A
Z36M6BFL	36 x 20 x 66	258	33.25	<b>\$2415</b>	<b>\$2477</b>	<b>\$1181</b>	N/A
Z30M6BFL	30 x 20 x 66	232	27.75	<b>\$2218</b>	<b>\$2270</b>	<b>\$1076</b>	N/A
Z24M6BFL	24 x 20 x 66	218	22.5	<b>\$2102</b>	<b>\$2144</b>	<b>\$942</b>	N/A

**Two box and one file drawer** on bottom. Laminate doors are standard. Storage compartment on **left** includes **two 3-position fixed/height adjustable shelves**. Wardrobe compartment on **right** includes hanging rod. Two upper locks (one per each hinged door) and one lower lock secures drawers, all keyed alike. Ganging hardware included with all units 24" wide or less and 41"H or taller. Shipped assembled in 1 carton.

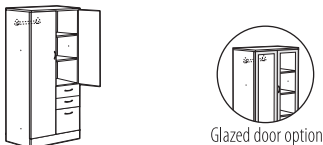

**Personal Tower with Doors - RIGHT**

Z36L6BFR	36 x 24 x 66	294	39	<b>\$2538</b>	<b>\$2607</b>	<b>\$1181</b>	N/A
Z30L6BFR	30 x 24 x 66	269	32.75	<b>\$2360</b>	<b>\$2422</b>	<b>\$1076</b>	N/A
Z24L6BFR	24 x 24 x 66	244	26.75	<b>\$2242</b>	<b>\$2293</b>	<b>\$942</b>	N/A
Z36M6BFR	36 x 20 x 66	258	33.25	<b>\$2415</b>	<b>\$2477</b>	<b>\$1181</b>	N/A
Z30M6BFR	30 x 20 x 66	232	27.75	<b>\$2218</b>	<b>\$2270</b>	<b>\$1076</b>	N/A
Z24M6BFR	24 x 20 x 66	218	22.5	<b>\$2102</b>	<b>\$2144</b>	<b>\$942</b>	N/A

**Two box and one file drawer** on bottom. Laminate doors are standard. Storage compartment on **right** includes **two 3-position fixed/height adjustable shelves**. Wardrobe compartment on **left** includes hanging rod. Two upper locks (one per each hinged door) and one lower lock secures drawers, all keyed alike. Ganging hardware included with all units 24" wide or less and 41"H or taller. Shipped assembled in 1 carton.

**Required specifications**

- Top finish
- Top thickness/edge detail
- Base finish
- Handles

**Optional specifications**

- Key #
- Box drawer - no upcharge
- Collator - position & finish\*
- Glazed door

PERSONAL TOWERS - 65.5" / 66" HIGH

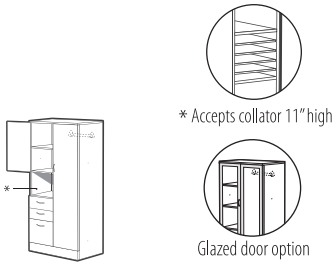

Personal Tower with Doors  
Cavity - LEFT\*

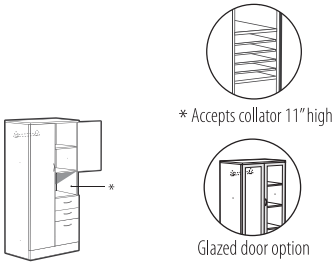

Personal Tower with Doors  
and Cavity - RIGHT\*

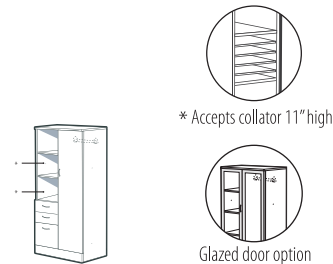

Personal Tower with Open Shelves  
- LEFT

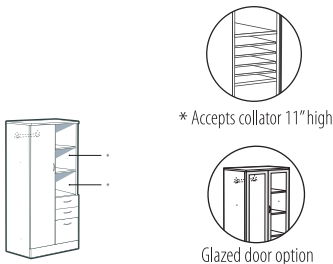

Personal Tower with Open Shelves  
- RIGHT

MODEL #	DIMENSIONS W x D x H (1.5" TOP)	WT/LB.	CUBIC FT.	1" TOP	1.5" TOP	GLAZE ADD	HP ADD
Z36L6BFCL	36 x 24 x 66	292	39	\$2509	\$2578	\$1128	N/A
Z30L6BFCL	30 x 24 x 66	266	32.75	\$2330	\$2392	\$1022	N/A
Z24L6BFCL	24 x 24 x 66	240	26.75	\$2213	\$2264	\$887	N/A
Z36M6BFCL	36 x 20 x 66	254	33.25	\$2366	\$2428	\$1128	N/A
Z30M6BFCL	30 x 20 x 66	229	27.75	\$2168	\$2220	\$1022	N/A
Z24M6BFCL	24 x 20 x 66	214	22.5	\$2074	\$2116	\$887	N/A

**Two box and one file drawer** on bottom. Laminate doors are standard. Storage compartment on **left includes one 3-position fixed/height adjustable shelf**. Wardrobe compartment on **right** includes hanging rod. Two upper locks (one per each hinged door) and one lower lock secures drawers, all keyed alike. Ganging hardware included with all units 24" wide or less and 41"H or taller. Shipped assembled in 1 carton.

Z36L6BFCL	36 x 24 x 66	292	39	\$2509	\$2578	\$1128	N/A
Z30L6BFCL	30 x 24 x 66	266	32.75	\$2330	\$2392	\$1022	N/A
Z24L6BFCL	24 x 24 x 66	240	26.75	\$2213	\$2264	\$887	N/A
Z36M6BFCL	36 x 20 x 66	254	33.25	\$2366	\$2428	\$1128	N/A
Z30M6BFCL	30 x 20 x 66	229	27.75	\$2168	\$2220	\$1022	N/A
Z24M6BFCL	24 x 20 x 66	214	22.5	\$2074	\$2116	\$887	N/A

**Two box and one file drawer** on bottom. Laminate doors are standard. Storage compartment on **right includes one 3-position fixed/height adjustable shelf**. Wardrobe compartment on **left** includes hanging rod. Two upper locks (one per each hinged door) and one lower lock secures drawers, all keyed alike. Ganging hardware included with all units 24" wide or less and 41"H or taller. Shipped assembled in 1 carton.

Z36L6BFNL	36 x 24 x 66	280	39	\$2376	\$2445	\$705	N/A
Z30L6BFNL	30 x 24 x 66	257	32.75	\$2196	\$2258	\$601	N/A
Z24L6BFNL	24 x 24 x 66	232	26.75	\$2081	\$2132	\$468	N/A
Z36M6BFNL	36 x 20 x 66	242	33.25	\$2254	\$2316	\$705	N/A
Z30M6BFNL	30 x 20 x 66	219	27.75	\$2054	\$2106	\$601	N/A
Z24M6BFNL	24 x 20 x 66	206	22.5	\$1960	\$2002	\$468	N/A

**Two box and one file drawer** on bottom. Laminate doors are standard. Storage compartment on **left includes two 3-position fixed/height adjustable shelves**. Wardrobe compartment on **right** includes hanging rod. Upper lock secures wardrobe compartment. Lower lock secures all drawers. Ganging hardware included with all units 24" wide or less and 41"H or taller. Shipped assembled in 1 carton.

Z36L6BFNR	36 x 24 x 66	280	39	\$2376	\$2445	\$705	N/A
Z30L6BFNR	30 x 24 x 66	257	32.75	\$2196	\$2258	\$601	N/A
Z24L6BFNR	24 x 24 x 66	232	26.75	\$2081	\$2132	\$468	N/A
Z36M6BFNR	36 x 20 x 66	242	33.25	\$2254	\$2316	\$705	N/A
Z30M6BFNR	30 x 20 x 66	219	27.75	\$2054	\$2106	\$601	N/A
Z24M6BFNR	24 x 20 x 66	206	22.5	\$1960	\$2002	\$468	N/A

**Two box and one file drawer** on bottom. Laminate doors are standard. Storage compartment on **right includes two 3-position fixed/height adjustable shelves**. Wardrobe compartment on **left** includes hanging rod. Upper lock secures wardrobe compartment. Lower lock secures all drawers. Ganging hardware included with all units 24" wide or less and 41"H or taller. Shipped assembled in 1 carton.

**Required specifications**

Top finish  
Top thickness/edge detail  
Base finish  
Handles

**Optional specifications**

Key #  
Box drawer - no upcharge  
Collator - position & finish  
Glazed door

**STORAGE MODULES - 72" / 72.5" HIGH**

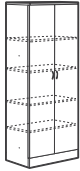

Glazed door option

**Storage Cabinet with Doors**

MODEL #	DIMENSIONS W x D x H (1.5" TOP)	WT/LB.	CUBIC FT.	1" TOP	1.5" TOP	GLAZE ADD	HP ADD
Z36L7SH	36 x 24 x 72.4	295	43.25	<b>\$2244</b>	<b>\$2313</b>	<b>\$1518</b>	N/A
Z30L7SH	30 x 24 x 72.4	253	36.25	<b>\$1961</b>	<b>\$2023</b>	<b>\$1311</b>	N/A
Z36M7SH	36 x 20 x 72.4	261	36.75	<b>\$2085</b>	<b>\$2147</b>	<b>\$1518</b>	N/A
Z30M7SH	30 x 20 x 72.4	226	30.5	<b>\$1806</b>	<b>\$1858</b>	<b>\$1311</b>	N/A
Z36S7SH	36 x 16 x 72.4	226	29.5	<b>\$1867</b>	<b>\$1928</b>	<b>\$1518</b>	N/A
Z30S7SH	30 x 16 x 72.4	195	25	<b>\$1642</b>	<b>\$1684</b>	<b>\$1311</b>	N/A

Laminate doors are standard. **Includes four 3-position fixed/height adjustable shelves.** Standard with lock. Ganging hardware included with all units 24" wide or less and 41"H or taller. Shipped assembled in 1 carton.



Glazed door option

**Storage Cabinet with Door - LEFT**

Z21L7SHL	21 x 24 x 72.4	196	26	<b>\$1624</b>	<b>\$1674</b>	<b>\$843</b>	N/A
Z18L7SHL	18 x 24 x 72.4	179	22.75	<b>\$1511</b>	<b>\$1553</b>	<b>\$754</b>	N/A
Z16L7SHL	16 x 24 x 72.4	167	20.75	<b>\$1421</b>	<b>\$1463</b>	<b>\$748</b>	N/A
Z15L7SHL	15 x 24 x 72.4	161	19.25	<b>\$1359</b>	<b>\$1393</b>	<b>\$651</b>	N/A
Z12L7SHL	12 x 24 x 72.4	137	16	<b>\$1250</b>	<b>\$1280</b>	<b>\$584</b>	N/A
Z21M7SHL	21 x 20 x 72.4	174	21.25	<b>\$1449</b>	<b>\$1491</b>	<b>\$843</b>	N/A
Z18M7SHL	18 x 20 x 72.4	156	19.25	<b>\$1383</b>	<b>\$1418</b>	<b>\$754</b>	N/A
Z16M7SHL	16 x 20 x 72.4	147	17.5	<b>\$1301</b>	<b>\$1336</b>	<b>\$748</b>	N/A
Z15M7SHL	15 x 20 x 72.4	140	16.25	<b>\$1240</b>	<b>\$1270</b>	<b>\$651</b>	N/A
Z12M7SHL	12 x 20 x 72.4	124	13.25	<b>\$1135</b>	<b>\$1160</b>	<b>\$584</b>	N/A
Z21S7SHL	21 x 16 x 72.4	150	18	<b>\$1337</b>	<b>\$1370</b>	<b>\$843</b>	N/A
Z18S7SHL	18 x 16 x 72.4	134	15.5	<b>\$1246</b>	<b>\$1280</b>	<b>\$754</b>	N/A
Z16S7SHL	16 x 16 x 72.4	125	14	<b>\$1191</b>	<b>\$1225</b>	<b>\$748</b>	N/A
Z15S7SHL	15 x 16 x 72.4	119	12.5	<b>\$1146</b>	<b>\$1175</b>	<b>\$651</b>	N/A
Z12S7SHL	12 x 16 x 72.4	104	11	<b>\$1005</b>	<b>\$1030</b>	<b>\$584</b>	N/A

Laminate doors are standard. **Includes four 3-position fixed/height adjustable shelves.** Standard with lock. Ganging hardware included with all units 24" wide or less and 41"H or taller. Shipped assembled in 1 carton.



Glazed door option

**Storage Cabinet with Door - RIGHT**

Z21L7SHR	21 x 24 x 72.4	196	26	<b>\$1624</b>	<b>\$1674</b>	<b>\$843</b>	N/A
Z18L7SHR	18 x 24 x 72.4	179	22.75	<b>\$1511</b>	<b>\$1553</b>	<b>\$754</b>	N/A
Z16L7SHR	16 x 24 x 72.4	167	20.75	<b>\$1421</b>	<b>\$1463</b>	<b>\$748</b>	N/A
Z15L7SHR	15 x 24 x 72.4	161	19.25	<b>\$1359</b>	<b>\$1393</b>	<b>\$651</b>	N/A
Z12L7SHR	12 x 24 x 72.4	137	16	<b>\$1250</b>	<b>\$1280</b>	<b>\$584</b>	N/A
Z21M7SHR	21 x 20 x 72.4	174	21.25	<b>\$1449</b>	<b>\$1491</b>	<b>\$843</b>	N/A
Z18M7SHR	18 x 20 x 72.4	156	19.25	<b>\$1383</b>	<b>\$1418</b>	<b>\$754</b>	N/A
Z16M7SHR	16 x 20 x 72.4	147	17.5	<b>\$1301</b>	<b>\$1336</b>	<b>\$748</b>	N/A
Z15M7SHR	15 x 20 x 72.4	140	16.25	<b>\$1240</b>	<b>\$1270</b>	<b>\$651</b>	N/A
Z12M7SHR	12 x 20 x 72.4	124	13.25	<b>\$1135</b>	<b>\$1160</b>	<b>\$584</b>	N/A
Z21S7SHR	21 x 16 x 72.4	150	18	<b>\$1337</b>	<b>\$1370</b>	<b>\$843</b>	N/A
Z18S7SHR	18 x 16 x 72.4	134	15.5	<b>\$1246</b>	<b>\$1280</b>	<b>\$754</b>	N/A
Z16S7SHR	16 x 16 x 72.4	125	14	<b>\$1191</b>	<b>\$1225</b>	<b>\$748</b>	N/A
Z15S7SHR	15 x 16 x 72.4	119	12.5	<b>\$1146</b>	<b>\$1175</b>	<b>\$651</b>	N/A
Z12S7SHR	12 x 16 x 72.4	104	11	<b>\$1005</b>	<b>\$1030</b>	<b>\$584</b>	N/A

Laminate doors are standard. **Includes four 3-position fixed/height adjustable shelves.** Standard with lock. Ganging hardware included with all units 24" wide or less and 41"H or taller. Shipped assembled in 1 carton.

**Required specifications**

- Top finish
- Top thickness/edge detail
- Base finish
- Handles

**Optional specifications**

- Key #
- Box drawer - no upcharge
- Collator - position & finish\*
- Glazed door

STORAGE MODULES - 72" / 72.5" HIGH

MODEL #	DIMENSIONS	WT/LB.	CUBIC FT.	1" TOP	1.5" TOP	GLAZE ADD	HP ADD
W x D x H (1.5" TOP)							
Z36L7SHN	36 x 24 x 72.4	250	43.25	\$1756	\$1825	N/A	N/A
Z30L7SHN	30 x 24 x 72.4	216	36.25	\$1554	\$1616	N/A	N/A
Z21L7SHN	21 x 24 x 72.4	172	26	\$1345	\$1395	N/A	N/A
Z18L7SHN	18 x 24 x 72.4	157	22.75	\$1261	\$1303	N/A	N/A
Z16L7SHN	16 x 24 x 72.4	147	20.75	\$1173	\$1215	N/A	N/A
Z15L7SHN	15 x 24 x 72.4	142	19.25	\$1140	\$1174	N/A	N/A
Z12L7SHN	12 x 24 x 72.4	121	16	\$1053	\$1162	N/A	N/A
Z36M7SHN	36 x 20 x 72.4	217	36.75	\$1594	\$1656	N/A	N/A
Z30M7SHN	30 x 20 x 72.4	188	30.5	\$1400	\$1452	N/A	N/A
Z21M7SHN	21 x 20 x 72.4	149	21.25	\$1062	\$1104	N/A	N/A
Z18M7SHN	18 x 20 x 72.4	135	19.25	\$1133	\$1168	N/A	N/A
Z16M7SHN	16 x 20 x 72.4	127	17.5	\$1051	\$1086	N/A	N/A
Z15M7SHN	15 x 20 x 72.4	122	16.25	\$1021	\$1051	N/A	N/A
Z12M7SHN	12 x 20 x 72.4	109	13.25	\$941	\$966	N/A	N/A
Z36S7SHN	36 x 16 x 72.4	181	29.5	\$1377	\$1438	N/A	N/A
Z30S7SHN	30 x 16 x 72.4	158	25	\$1235	\$1277	N/A	N/A
Z21S7SHN	21 x 16 x 72.4	124	18	\$1060	\$1093	N/A	N/A
Z18S7SHN	18 x 16 x 72.4	113	15.5	\$996	\$1030	N/A	N/A
Z16S7SHN	16 x 16 x 72.4	105	14	\$942	\$976	N/A	N/A
Z15S7SHN	15 x 16 x 72.4	100	12.5	\$928	\$957	N/A	N/A
Z12S7SHN	12 x 16 x 72.4	90	11	\$813	\$838	N/A	N/A

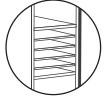

\* Accepts collator 11" high

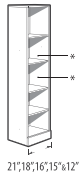
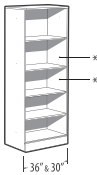

Open Storage Cabinet\*

**Four adjustable shelves.** Ganging hardware included with all units 24" wide or less and 41"H or taller. Shipped assembled in 1 carton.

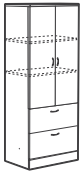

Glazed door option

Two File Module with Doors\*\*

Z36L7E	36 x 24 x 72.4	316	43.25	\$2864	\$2933	\$1194	N/A
Z30L7E	30 x 24 x 72.4	276	36.25	\$2615	\$2677	\$1038	N/A
Z36M7E	36 x 20 x 72.4	286	36.75	\$2709	\$2771	\$1194	N/A
Z30M7E	30 x 20 x 72.4	250	30.5	\$2471	\$2523	\$1038	N/A
Z36S7E	36 x 16 x 72.4	245	29.5	\$2478	\$2539	\$1194	N/A
Z30S7E	30 x 16 x 72.4	213	25	\$2235	\$2277	\$1038	N/A

Two lateral file drawers. Laminate doors are standard. **Includes two adjustable shelves.** Upper lock secures storage compartment. Lower lock secures two file drawers. Front-to-back and side-to-side letter/legal filing capability. Side-to-side file bars included. Shipped assembled in 1 carton.

- Lateral file drawer construction is for accommodating hanging files NOT for stacking materials on the drawer bottom.



Glazed door option

Two File Module with Door - LEFT\*\*

Z16L7EL	16 x 24 x 72.4	182	20.75	\$1689	\$1731	\$585	N/A
Z15L7EL	15 x 24 x 72.4	176	19.25	\$1624	\$1658	\$515	N/A
Z16M7EL	16 x 20 x 72.4	163	17.5	\$1566	\$1601	\$585	N/A
Z15M7EL	15 x 20 x 72.4	155	16.25	\$1506	\$1536	\$515	N/A
Z16S7EL	16 x 16 x 72.4	138	14	\$1458	\$1492	\$585	N/A
Z15S7EL	15 x 16 x 72.4	132	12.5	\$1426	\$1455	\$515	N/A

Two file drawers on bottom. Laminate door is standard. **Includes two 3-position fixed/height adjustable shelves.** Upper lock secures storage compartment. Lower lock secures two file drawers. Ganging hardware included with all units 24" wide or less and 41"H or taller. Shipped assembled in 1 carton.

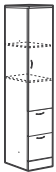

Glazed door option

Two File Module with Door - RIGHT\*\*

Z16L7ER	16 x 24 x 72.4	182	20.75	\$1689	\$1731	\$585	N/A
Z15L7ER	15 x 24 x 72.4	176	19.25	\$1624	\$1658	\$515	N/A
Z16M7ER	16 x 20 x 72.4	163	17.5	\$1566	\$1601	\$585	N/A
Z15M7ER	15 x 20 x 72.4	155	16.25	\$1506	\$1536	\$515	N/A
Z16S7ER	16 x 16 x 72.4	138	14	\$1458	\$1492	\$585	N/A
Z15S7ER	15 x 16 x 72.4	132	12.5	\$1426	\$1455	\$515	N/A

Two file drawers on bottom. Laminate door is standard. **Includes two 3-position fixed/height adjustable shelves.** Upper lock secures storage compartment. Lower lock secures two file drawers. Ganging hardware included with all units 24" wide or less and 41"H or taller. Shipped assembled in 1 carton.

**Required specifications**

- Top finish
- Top thickness/edge detail
- Base finish
- Handles

**Optional specifications**

- Key #
- Box drawer - no upcharge\*\*
- Collator - position & finish\*
- Glazed door



**STORAGE MODULES - 72" / 72.5" HIGH**

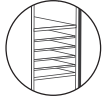

\* Accepts collator 11" high

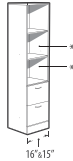
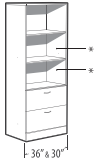

**Two File Module with Open Shelves\***

MODEL #	DIMENSIONS	WT/LB.	CUBIC FT.	1" TOP	1.5" TOP	GLAZE ADD	HP ADD
W x D x H (1.5" TOP)							
Z36L7EN	36 x 24 x 72.4	287	43.25	<b>\$2489</b>	<b>\$2558</b>	N/A	N/A
Z30L7EN	30 x 24 x 72.4	253	36.25	<b>\$2287</b>	<b>\$2349</b>	N/A	N/A
Z16L7EN	16 x 24 x 72.4	169	20.75	<b>\$1499</b>	<b>\$1541</b>	N/A	N/A
Z15L7EN	15 x 24 x 72.4	164	19.25	<b>\$1455</b>	<b>\$1489</b>	N/A	N/A
Z36M7EN	36 x 20 x 72.4	257	36.75	<b>\$2336</b>	<b>\$2398</b>	N/A	N/A
Z30M7EN	30 x 20 x 72.4	226	30.5	<b>\$2144</b>	<b>\$2196</b>	N/A	N/A
Z16M7EN	16 x 20 x 72.4	150	17.5	<b>\$1377</b>	<b>\$1412</b>	N/A	N/A
Z15M7EN	15 x 20 x 72.4	144	16.25	<b>\$1338</b>	<b>\$1368</b>	N/A	N/A
Z36S7EN	36 x 16 x 72.4	216	29.5	<b>\$2104</b>	<b>\$2165</b>	N/A	N/A
Z30S7EN	30 x 16 x 72.4	189	25	<b>\$1904</b>	<b>\$1946</b>	N/A	N/A
Z16S7EN	16 x 16 x 72.4	125	14	<b>\$1271</b>	<b>\$1305</b>	N/A	N/A
Z15S7EN	15 x 16 x 72.4	120	12.5	<b>\$1256</b>	<b>\$1285</b>	N/A	N/A

Three open shelves and two file drawers on bottom. **Includes two 3-position fixed/height adjustable shelves.** Lock secures all drawers. 36" and 30" wide models have front-to-back and side-to-side letter/legal filing capability. Side-to-side file bars included. Ganging hardware included with all units 24" wide or less and 41"H or taller. Shipped assembled in 1 carton.

- Lateral file drawer construction is for accommodating hanging files NOT for stacking materials on the drawer bottom.

**WARDROBE CABINETS - 72" / 72.5" HIGH**



**Wardrobe Cabinet**

W x D x H (1.5" TOP)							
Z36L7WA	36 x 24 x 72.4	252	43.25	<b>\$2039</b>	<b>\$2108</b>	N/A	N/A
Z30L7WA	30 x 24 x 72.4	218	36.25	<b>\$1904</b>	<b>\$1966</b>	N/A	N/A
Z36M7WA	36 x 20 x 72.4	227	36.75	<b>\$1921</b>	<b>\$1983</b>	N/A	N/A
Z30M7WA	30 x 20 x 72.4	196	30.5	<b>\$1703</b>	<b>\$1755</b>	N/A	N/A

Laminate doors are standard. Full length hanging rod included. **Includes one 3 fixed shelf** above hanging rod. Standard with lock. Shipped assembled in 1 carton.



**Wardrobe Cabinet - LEFT**

Z24L7WAL	24 x 24 x 72.4	191	29.75	<b>\$1544</b>	<b>\$1595</b>	N/A	N/A
Z21L7WAL	21 x 24 x 72.4	179	26	<b>\$1489</b>	<b>\$1539</b>	N/A	N/A
Z18L7WAL	18 x 24 x 72.4	159	22.75	<b>\$1372</b>	<b>\$1414</b>	N/A	N/A
Z16L7WAL	16 x 24 x 72.4	149	20.75	<b>\$1313</b>	<b>\$1355</b>	N/A	N/A
Z15L7WAL	15 x 24 x 72.4	145	19.25	<b>\$1251</b>	<b>\$1285</b>	N/A	N/A
Z12L7WAL	12 x 24 x 72.4	130	16	<b>\$1163</b>	<b>\$1193</b>	N/A	N/A
Z24M7WAL	24 x 20 x 72.4	171	25.25	<b>\$1430</b>	<b>\$1472</b>	N/A	N/A
Z21M7WAL	21 x 20 x 72.4	154	21.25	<b>\$1373</b>	<b>\$1415</b>	N/A	N/A
Z18M7WAL	18 x 20 x 72.4	140	19.25	<b>\$1261</b>	<b>\$1296</b>	N/A	N/A
Z16M7WAL	16 x 20 x 72.4	131	17.5	<b>\$1208</b>	<b>\$1243</b>	N/A	N/A
Z15M7WAL	15 x 20 x 72.4	126	16.25	<b>\$1147</b>	<b>\$1177</b>	N/A	N/A
Z12M7WAL	12 x 20 x 72.4	113	13.25	<b>\$1073</b>	<b>\$1098</b>	N/A	N/A

Laminate doors are standard. Full length hanging rod included. **Includes one 3 fixed shelf** above hanging rod. Standard with lock. Ganging hardware included with all units 24" wide or less and 41"H or taller. Shipped assembled in 1 carton.

**Required specifications**

- Top finish
- Top thickness/edge detail
- Base finish
- Handles

**Optional specifications**

- Key #
- Collator - position & finish\*

WARDROBE CABINETS - 72" / 72.5" HIGH



Wardrobe Cabinet - RIGHT

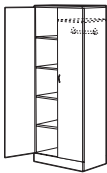

Glazed door option

Wardrobe Cabinet/Shelving Combo with Doors - LEFT\*

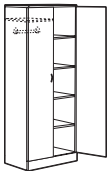

Glazed door option

Wardrobe Cabinet/Shelving Combo with Doors - RIGHT\*

MODEL #	DIMENSIONS W x D x H (1.5" TOP)	WT/LB.	CUBIC FT.	1" TOP	1.5" TOP	GLAZE ADD	HP ADD
Z24L7WAR	24 x 24 x 72.4	191	29.75	<b>\$1544</b>	<b>\$1595</b>	N/A	N/A
Z21L7WAR	21 x 24 x 72.4	179	26	<b>\$1489</b>	<b>\$1539</b>	N/A	N/A
Z18L7WAR	18 x 24 x 72.4	159	22.75	<b>\$1372</b>	<b>\$1414</b>	N/A	N/A
Z16L7WAR	16 x 24 x 72.4	149	20.75	<b>\$1313</b>	<b>\$1355</b>	N/A	N/A
Z15L7WAR	15 x 24 x 72.4	145	19.25	<b>\$1251</b>	<b>\$1285</b>	N/A	N/A
Z12L7WAR	12 x 24 x 72.4	130	16	<b>\$1163</b>	<b>\$1193</b>	N/A	N/A
Z24M7WAR	24 x 20 x 72.4	171	25.25	<b>\$1430</b>	<b>\$1472</b>	N/A	N/A
Z21M7WAR	21 x 20 x 72.4	154	21.25	<b>\$1373</b>	<b>\$1415</b>	N/A	N/A
Z18M7WAR	18 x 20 x 72.4	140	19.25	<b>\$1261</b>	<b>\$1296</b>	N/A	N/A
Z16M7WAR	16 x 20 x 72.4	131	17.5	<b>\$1208</b>	<b>\$1243</b>	N/A	N/A
Z15M7WAR	15 x 20 x 72.4	126	16.25	<b>\$1147</b>	<b>\$1177</b>	N/A	N/A
Z12M7WAR	12 x 20 x 72.4	113	13.25	<b>\$1073</b>	<b>\$1098</b>	N/A	N/A

Laminate doors are standard. Full length hanging rod included. **Includes one fixed shelf** above hanging rod. Standard with lock. Ganging hardware included with all units 24" wide or less and 41"H or taller. Shipped assembled in 1 carton.

Z36L7DIL	36 x 24 x 72.4	300	43.25	<b>\$2409</b>	<b>\$2478</b>	<b>\$1518</b>	N/A
Z30L7DIL	30 x 24 x 72.4	263	36.25	<b>\$2104</b>	<b>\$2166</b>	<b>\$1311</b>	N/A
Z24L7DIL	24 x 24 x 72.4	232	29.75	<b>\$1916</b>	<b>\$1967</b>	<b>\$1184</b>	N/A
Z21L7DIL	21 x 24 x 72.4	201	26	<b>\$1855</b>	<b>\$1905</b>	<b>\$1174</b>	N/A
Z36M7DIL	36 x 20 x 72.4	276	36.75	<b>\$2259</b>	<b>\$2321</b>	<b>\$1518</b>	N/A
Z30M7DIL	30 x 20 x 72.4	242	30.5	<b>\$1962</b>	<b>\$2014</b>	<b>\$1311</b>	N/A
Z24M7DIL	24 x 20 x 72.4	214	25.25	<b>\$1799</b>	<b>\$1841</b>	<b>\$1184</b>	N/A
Z21M7DIL	21 x 20 x 72.4	196	21.25	<b>\$1727</b>	<b>\$1769</b>	<b>\$1174</b>	N/A

Laminate doors are standard. Storage compartment on **left includes four 3-position fixed/height adjustable shelves**. Wardrobe compartment on **right** includes hanging rod and one adjustable shelf above rod. Two locks secure storage and wardrobe compartments. Ganging hardware included with all units 24" wide or less and 41"H or taller. Shipped assembled in 1 carton.

Z36L7DIR	36 x 24 x 72.4	300	43.25	<b>\$2409</b>	<b>\$2478</b>	<b>\$1518</b>	N/A
Z30L7DIR	30 x 24 x 72.4	263	36.25	<b>\$2104</b>	<b>\$2166</b>	<b>\$1311</b>	N/A
Z24L7DIR	24 x 24 x 72.4	232	29.75	<b>\$1916</b>	<b>\$1967</b>	<b>\$1184</b>	N/A
Z21L7DIR	21 x 24 x 72.4	201	26	<b>\$1855</b>	<b>\$1905</b>	<b>\$1174</b>	N/A
Z36M7DIR	36 x 20 x 72.4	276	36.75	<b>\$2259</b>	<b>\$2321</b>	<b>\$1518</b>	N/A
Z30M7DIR	30 x 20 x 72.4	242	30.5	<b>\$1962</b>	<b>\$2014</b>	<b>\$1311</b>	N/A
Z24M7DIR	24 x 20 x 72.4	214	25.25	<b>\$1799</b>	<b>\$1841</b>	<b>\$1184</b>	N/A
Z21M7DIR	21 x 20 x 72.4	196	21.25	<b>\$1727</b>	<b>\$1769</b>	<b>\$1174</b>	N/A

Laminate doors are standard. Storage compartment on **right includes four 3-position fixed/height adjustable shelves**. Wardrobe compartment on **left** includes hanging rod and one adjustable shelf above rod. Two locks secure storage and wardrobe compartments. Ganging hardware included with all units 24" wide or less and 41"H or taller. Shipped assembled in 1 carton.

**Required specifications**

- Top finish
- Top thickness/edge detail
- Base finish
- Handles

**Optional specifications**

- Key #
- Glazed door\*

**WARDROBE CABINETS - 72" / 72.5" HIGH**

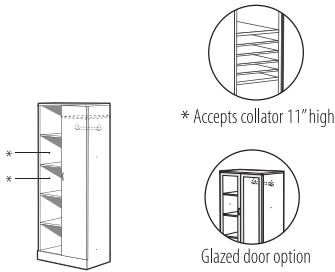

**Wardrobe Cabinet/Open Shelving Combo - LEFT\***

Shipped assembled in 1 carton.

MODEL #	DIMENSIONS	WT/LB.	CUBIC FT.	1" TOP				
				1.5" TOP	GLAZE ADD	HP ADD		
<b>W x D x H (1.5" TOP)</b>								
Z36L7DINL	36 x 24 x 72.4	277	43.25	<b>\$2171</b>	<b>\$2240</b>	<b>\$755</b>	N/A	
Z30L7DINL	30 x 24 x 72.4	245	36.25	<b>\$1912</b>	<b>\$1974</b>	<b>\$653</b>	N/A	
Z24L7DINL	24 x 24 x 72.4	218	29.75	<b>\$1737</b>	<b>\$1788</b>	<b>\$585</b>	N/A	
Z21L7DINL	21 x 24 x 72.4	189	26	<b>\$1682</b>	<b>\$1732</b>	<b>\$581</b>	N/A	
Z36M7DINL	36 x 20 x 72.4	254	36.75	<b>\$2023</b>	<b>\$2085</b>	<b>\$755</b>	N/A	
Z30M7DINL	30 x 20 x 72.4	223	30.5	<b>\$1768</b>	<b>\$1820</b>	<b>\$653</b>	N/A	
Z24M7DINL	24 x 20 x 72.4	202	25.25	<b>\$1624</b>	<b>\$1666</b>	<b>\$585</b>	N/A	
Z21M7DINL	21 x 20 x 72.4	184	21.25	<b>\$1553</b>	<b>\$1595</b>	<b>\$581</b>	N/A	

Laminate door is standard on wardrobe section. Storage compartment on **left includes four 3-position fixed/height adjustable shelves**. Wardrobe compartment on **right** includes hanging rod and one adjustable shelf above rod. Single lock secures wardrobe compartment. Ganging hardware included with all units 24" wide or less and 41"H or taller.

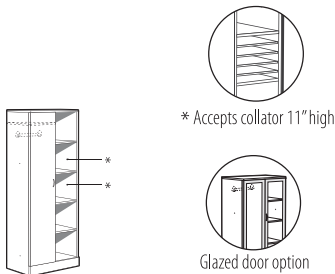

**Wardrobe Cabinet/Open Shelving Combo - RIGHT\***

Z36L7DINR	36 x 24 x 72.4	277	43.25	<b>\$2171</b>	<b>\$2240</b>	<b>\$755</b>	N/A	
Z30L7DINR	30 x 24 x 72.4	245	36.25	<b>\$1912</b>	<b>\$1974</b>	<b>\$653</b>	N/A	
Z24L7DINR	24 x 24 x 72.4	218	29.75	<b>\$1737</b>	<b>\$1788</b>	<b>\$585</b>	N/A	
Z21L7DINR	21 x 24 x 72.4	189	26	<b>\$1682</b>	<b>\$1732</b>	<b>\$581</b>	N/A	
Z36M7DINR	36 x 20 x 72.4	254	36.75	<b>\$2023</b>	<b>\$2085</b>	<b>\$755</b>	N/A	
Z30M7DINR	30 x 20 x 72.4	223	30.5	<b>\$1768</b>	<b>\$1820</b>	<b>\$653</b>	N/A	
Z24M7DINR	24 x 20 x 72.4	202	25.25	<b>\$1624</b>	<b>\$1666</b>	<b>\$585</b>	N/A	
Z21M7DINR	21 x 20 x 72.4	184	21.25	<b>\$1553</b>	<b>\$1595</b>	<b>\$581</b>	N/A	

Laminate door is standard on wardrobe section. Storage compartment on **right includes four 3-position fixed/height adjustable shelves**. Wardrobe compartment on **left** includes hanging rod and one adjustable shelf above rod. Single lock secures wardrobe compartment. Ganging hardware included with all units 24" wide or less and 41"H or taller. Shipped assembled in 1 carton.

**PERSONAL TOWERS - 72" / 72.5" HIGH**

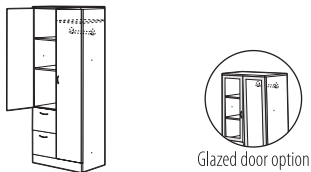

**Personal Tower with Doors - LEFT\*\***

MODEL #	DIMENSIONS	WT/LB.	CUBIC FT.	1" TOP				
				1.5" TOP	GLAZE ADD	HP ADD		
<b>W x D x H (1.5" TOP)</b>								
Z36L7EL	36 x 24 x 72.4	324	43.25	<b>\$2637</b>	<b>\$2706</b>	<b>\$1348</b>	N/A	
Z30L7EL	30 x 24 x 72.4	290	36.25	<b>\$2418</b>	<b>\$2480</b>	<b>\$1233</b>	N/A	
Z24L7EL	24 x 24 x 72.4	261	29.75	<b>\$2306</b>	<b>\$2357</b>	<b>\$1093</b>	N/A	
Z36M7EL	36 x 20 x 72.4	289	36.75	<b>\$2468</b>	<b>\$2530</b>	<b>\$1348</b>	N/A	
Z30M7EL	30 x 20 x 72.4	259	30.5	<b>\$2261</b>	<b>\$2313</b>	<b>\$1233</b>	N/A	
Z24M7EL	24 x 20 x 72.4	232	25.25	<b>\$2153</b>	<b>\$2195</b>	<b>\$1093</b>	N/A	

**Two file drawers** on bottom. Laminate doors are standard. Storage compartment on **left includes two 3-position fixed/height adjustable shelves**. Wardrobe compartment on **right** includes hanging rod and one adjustable shelf above rod. Two upper locks (one per each hinged door) and one lower lock secures drawers, all keyed alike. Ganging hardware included with all units 24" wide or less and 41"H or taller. Shipped assembled in 1 carton.

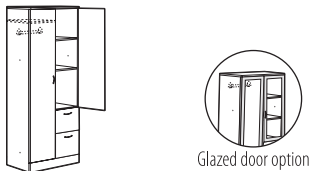

**Personal Tower with Doors - RIGHT\*\***

Z36L7ER	36 x 24 x 72.4	324	43.25	<b>\$2637</b>	<b>\$2706</b>	<b>\$1348</b>	N/A	
Z30L7ER	30 x 24 x 72.4	290	36.25	<b>\$2418</b>	<b>\$2480</b>	<b>\$1233</b>	N/A	
Z24L7ER	24 x 24 x 72.4	261	29.75	<b>\$2306</b>	<b>\$2357</b>	<b>\$1093</b>	N/A	
Z36M7ER	36 x 20 x 72.4	289	36.75	<b>\$2468</b>	<b>\$2530</b>	<b>\$1348</b>	N/A	
Z30M7ER	30 x 20 x 72.4	259	30.5	<b>\$2261</b>	<b>\$2313</b>	<b>\$1233</b>	N/A	
Z24M7ER	24 x 20 x 72.4	232	25.25	<b>\$2153</b>	<b>\$2195</b>	<b>\$1093</b>	N/A	

**Two file drawers** on bottom. Laminate doors are standard. Storage compartment on **right includes two 3-position fixed/height adjustable shelves**. Wardrobe compartment on **left** includes hanging rod and one adjustable shelf above rod. Two upper locks (one per each hinged door) and one lower lock secures drawers, all keyed alike. Ganging hardware included with all units 24" wide or less and 41"H or taller. Shipped assembled in 1 carton.

**Required specifications**

- Top finish
- Top thickness/edge detail
- Base finish
- Handles

**Optional specifications**

- Key #
- Box drawer - no upcharge\*\*
- Collator - position & finish\*
- Glazed door

PERSONAL TOWERS - 72" / 72.5" HIGH

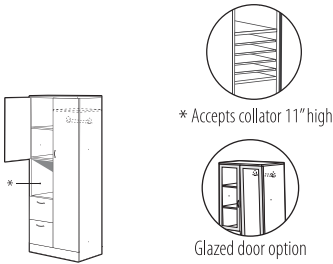

Personal Tower with Doors and Cavity - LEFT

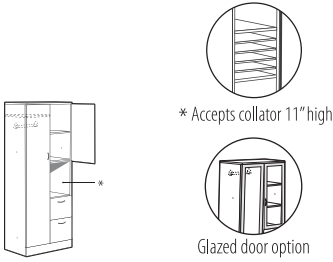

Personal Tower with Doors and Cavity - RIGHT

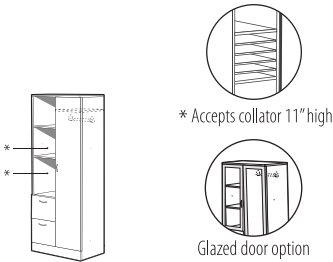

Personal Tower with Open Shelves - LEFT

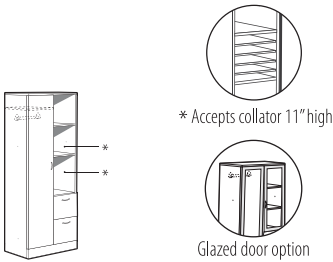

Personal Tower with Open Shelves - RIGHT

MODEL #	DIMENSIONS W x D x H (1.5" TOP)	WT/LB.	CUBIC FT.	1" TOP	1.5" TOP	GLAZE ADD	HP ADD
Z36L7ECL	36 x 24 x 72.4	320	43.25	<b>\$2621</b>	<b>\$2690</b>	<b>\$1222</b>	N/A
Z30L7ECL	30 x 24 x 72.4	287	36.25	<b>\$2407</b>	<b>\$2469</b>	<b>\$1109</b>	N/A
Z24L7ECL	24 x 24 x 72.4	257	29.75	<b>\$2278</b>	<b>\$2329</b>	<b>\$968</b>	N/A
Z36M7ECL	36 x 20 x 72.4	286	36.75	<b>\$2427</b>	<b>\$2489</b>	<b>\$1222</b>	N/A
Z30M7ECL	30 x 20 x 72.4	256	30.5	<b>\$2221</b>	<b>\$2273</b>	<b>\$1109</b>	N/A
Z24M7ECL	24 x 20 x 72.4	228	25.25	<b>\$2111</b>	<b>\$2153</b>	<b>\$968</b>	N/A

**Two file drawers** on bottom. Laminate doors are standard. Storage compartment on **left** includes **one 3-position fixed/height adjustable shelf**. Wardrobe compartment on **right** includes hanging rod and one adjustable shelf above rod. Two upper locks (one per each hinged door) and one lower lock secures drawers, all keyed alike. Ganging hardware included with all units 24" wide or less and 41"H or taller. Shipped assembled in 1 carton.

Z36L7ECR	36 x 24 x 72.4	320	43.25	<b>\$2621</b>	<b>\$2690</b>	<b>\$1222</b>	N/A
Z30L7ECR	30 x 24 x 72.4	287	36.25	<b>\$2407</b>	<b>\$2469</b>	<b>\$1109</b>	N/A
Z24L7ECR	24 x 24 x 72.4	257	29.75	<b>\$2278</b>	<b>\$2329</b>	<b>\$968</b>	N/A
Z36M7ECR	36 x 20 x 72.4	286	36.75	<b>\$2427</b>	<b>\$2489</b>	<b>\$1222</b>	N/A
Z30M7ECR	30 x 20 x 72.4	256	30.5	<b>\$2221</b>	<b>\$2273</b>	<b>\$1109</b>	N/A
Z24M7ECR	24 x 20 x 72.4	228	25.25	<b>\$2111</b>	<b>\$2153</b>	<b>\$968</b>	N/A

**Two file drawers** on bottom. Laminate doors are standard. Storage compartment on **right** includes **one 3-position fixed/height adjustable shelf**. Wardrobe compartment on **left** includes hanging rod and one adjustable shelf above rod. Two upper locks (one per each hinged door) and one lower lock secures drawers, all keyed alike. Ganging hardware included with all units 24" wide or less and 41"H or taller. Shipped assembled in 1 carton.

Z36L7ENL	36 x 24 x 72.4	310	43.25	<b>\$2493</b>	<b>\$2562</b>	<b>\$761</b>	N/A
Z30L7ENL	30 x 24 x 72.4	278	36.25	<b>\$2275</b>	<b>\$2337</b>	<b>\$648</b>	N/A
Z24L7ENL	24 x 24 x 72.4	248	29.75	<b>\$2160</b>	<b>\$2211</b>	<b>\$505</b>	N/A
Z36M7ENL	36 x 20 x 72.4	275	36.75	<b>\$2308</b>	<b>\$2370</b>	<b>\$761</b>	N/A
Z30M7ENL	30 x 20 x 72.4	247	30.5	<b>\$2105</b>	<b>\$2157</b>	<b>\$648</b>	N/A
Z24M7ENL	24 x 20 x 72.4	219	25.25	<b>\$2010</b>	<b>\$2052</b>	<b>\$505</b>	N/A

**Two file drawers** on bottom. Laminate door is standard on wardrobe section. Storage compartment on **left** includes **two 3-position fixed/height adjustable shelves**. Wardrobe compartment on **right** includes hanging rod and one adjustable shelf above rod. Upper lock secures wardrobe compartment. Lower lock secures all drawers. Ganging hardware included with all units 24" wide or less and 41"H or taller. Shipped assembled in 1 carton.

Z36L7ENR	36 x 24 x 72.4	310	43.25	<b>\$2493</b>	<b>\$2562</b>	<b>\$761</b>	N/A
Z30L7ENR	30 x 24 x 72.4	278	36.25	<b>\$2275</b>	<b>\$2337</b>	<b>\$648</b>	N/A
Z24L7ENR	24 x 24 x 72.4	248	29.75	<b>\$2160</b>	<b>\$2211</b>	<b>\$505</b>	N/A
Z36M7ENR	36 x 20 x 72.4	275	36.75	<b>\$2308</b>	<b>\$2370</b>	<b>\$761</b>	N/A
Z30M7ENR	30 x 20 x 72.4	247	30.5	<b>\$2105</b>	<b>\$2157</b>	<b>\$648</b>	N/A
Z24M7ENR	24 x 20 x 72.4	219	25.25	<b>\$2010</b>	<b>\$2052</b>	<b>\$505</b>	N/A

**Two file drawers** on bottom. Laminate door is standard on wardrobe section. Storage compartment on **right** includes **two 3-position fixed/height adjustable shelves**. Wardrobe compartment on **left** includes hanging rod and one adjustable shelf above rod. Upper lock secures wardrobe compartment. Lower lock secures all drawers. Ganging hardware included with all units 24" wide or less and 41"H or taller. Shipped assembled in 1 carton.

**Required specifications**

- Top finish
- Top thickness/edge detail
- Base finish
- Handles

**Optional specifications**

- Key #
- Box drawer - no upcharge
- Collator - position & finish
- Glazed door

**PERSONAL TOWERS - 72" / 72.5" HIGH**      **MODEL #**      **DIMENSIONS**      **WT/LB.**      **CUBIC FT.**      **1" TOP**      **1.5" TOP**      **GLAZE ADD**      **HP ADD**

**W x D x H (1.5" TOP)**

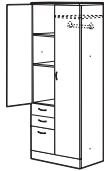

Glazed door option

**Personal Tower with Doors - LEFT**

Z36L7BFL	36 x 24 x 72.4	327	43.25	<b>\$2769</b>	<b>\$2838</b>	<b>\$1348</b>	N/A
Z30L7BFL	30 x 24 x 72.4	293	36.25	<b>\$2558</b>	<b>\$2620</b>	<b>\$1233</b>	N/A
Z24L7BFL	24 x 24 x 72.4	262	29.75	<b>\$2408</b>	<b>\$2459</b>	<b>\$1093</b>	N/A
Z36M7BFL	36 x 20 x 72.4	292	36.75	<b>\$2598</b>	<b>\$2660</b>	<b>\$1348</b>	N/A
Z30M7BFL	30 x 20 x 72.4	263	30.5	<b>\$2422</b>	<b>\$2474</b>	<b>\$1162</b>	N/A
Z24M7BFL	24 x 20 x 72.4	233	25.25	<b>\$2254</b>	<b>\$2296</b>	<b>\$1093</b>	N/A

**Two box and one file drawer** on bottom. Laminate doors are standard. Storage compartment on **left** includes **two 3-position fixed/height adjustable shelves**. Wardrobe compartment on **right** includes hanging rod and one adjustable shelf above rod. Two upper locks (one per each hinged door) and one lower lock secures drawers, all keyed alike. Ganging hardware included with all units 24" wide or less and 41"H or taller. Shipped assembled in 1 carton.



Glazed door option

**Personal Tower with Doors - RIGHT**

Z36L7BFR	36 x 24 x 72.4	327	43.25	<b>\$2769</b>	<b>\$2838</b>	<b>\$1348</b>	N/A
Z30L7BFR	30 x 24 x 72.4	293	36.25	<b>\$2558</b>	<b>\$2620</b>	<b>\$1233</b>	N/A
Z24L7BFR	24 x 24 x 72.4	262	29.75	<b>\$2408</b>	<b>\$2459</b>	<b>\$1093</b>	N/A
Z36M7BFR	36 x 20 x 72.4	292	36.75	<b>\$2598</b>	<b>\$2660</b>	<b>\$1348</b>	N/A
Z30M7BFR	30 x 20 x 72.4	263	30.5	<b>\$2422</b>	<b>\$2474</b>	<b>\$1162</b>	N/A
Z24M7BFR	24 x 20 x 72.4	233	25.25	<b>\$2254</b>	<b>\$2296</b>	<b>\$1093</b>	N/A

**Two box and one file drawer** on bottom. Laminate doors are standard. Storage compartment on **right** includes **two 3-position fixed/height adjustable shelves**. Wardrobe compartment on **left** includes hanging rod and one adjustable shelf above rod. Two upper locks (one per each hinged door) and one lower lock secures drawers, all keyed alike. Ganging hardware included with all units 24" wide or less and 41"H or taller. Shipped assembled in 1 carton.

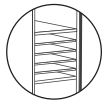
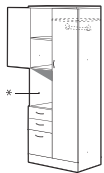

\* Accepts collator 11" high



Glazed door option

**Personal Tower with Doors Cavity - LEFT\***

Z36L7BFCL	36 x 24 x 72.4	318	43.25	<b>\$2741</b>	<b>\$2783</b>	<b>\$1222</b>	N/A
Z30L7BFCL	30 x 24 x 72.4	287	36.25	<b>\$2531</b>	<b>\$2565</b>	<b>\$1109</b>	N/A
Z24L7BFCL	24 x 24 x 72.4	259	29.75	<b>\$2366</b>	<b>\$2417</b>	<b>\$968</b>	N/A
Z36M7BFCL	36 x 20 x 72.4	289	36.75	<b>\$2550</b>	<b>\$2612</b>	<b>\$1222</b>	N/A
Z30M7BFCL	30 x 20 x 72.4	259	30.5	<b>\$2375</b>	<b>\$2427</b>	<b>\$1109</b>	N/A
Z24M7BFCL	24 x 20 x 72.4	229	25.25	<b>\$2214</b>	<b>\$2256</b>	<b>\$968</b>	N/A

**Two box and one file drawer** on bottom. Laminate doors are standard. Storage compartment on **left** includes **one fixed shelf and one 3-position fixed/height adjustable shelf**. Wardrobe compartment on **right** includes hanging rod and one adjustable shelf above rod. Two upper locks (one per each hinged door) and one lower lock secures drawers, all keyed alike. Ganging hardware included with all units 24" wide or less and 41"H or taller. Shipped assembled in 1 carton.

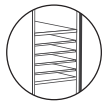
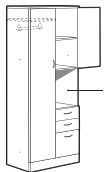

\* Accepts collator 11" high



Glazed door option

**Personal Tower with Doors Cavity - RIGHT\***

Z36L7BFCCR	36 x 24 x 72.4	318	43.25	<b>\$2741</b>	<b>\$2783</b>	<b>\$1222</b>	N/A
Z30L7BFCCR	30 x 24 x 72.4	287	36.25	<b>\$2531</b>	<b>\$2565</b>	<b>\$1109</b>	N/A
Z24L7BFCCR	24 x 24 x 72.4	259	29.75	<b>\$2366</b>	<b>\$2417</b>	<b>\$968</b>	N/A
Z36M7BFCCR	36 x 20 x 72.4	289	36.75	<b>\$2550</b>	<b>\$2612</b>	<b>\$1222</b>	N/A
Z30M7BFCCR	30 x 20 x 72.4	259	30.5	<b>\$2375</b>	<b>\$2427</b>	<b>\$1109</b>	N/A
Z24M7BFCCR	24 x 20 x 72.4	229	25.25	<b>\$2214</b>	<b>\$2256</b>	<b>\$968</b>	N/A

**Two box and one file drawer** on bottom. Laminate doors are standard. Storage compartment on **right** includes **one fixed shelf and 3-position fixed/height adjustable shelf**. Wardrobe compartment on **left** includes hanging rod and one adjustable shelf above rod. Two upper locks (one per each hinged door) and one lower lock secures drawers, all keyed alike. Ganging hardware included with all units 24" wide or less and 41"H or taller. Shipped assembled in 1 carton.

**Required specifications**

- Top finish
- Top thickness/edge detail
- Base finish
- Handles

**Optional specifications**

- Key #
- Box drawer - no upcharge
- Collator - position & finish\*
- Glazed door

PERSONAL TOWERS - 72" / 72.5" HIGH

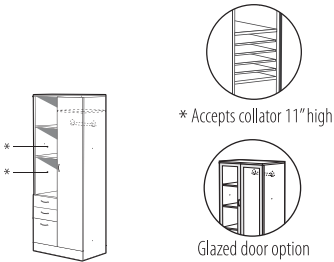

Personal Tower with Open Shelves - LEFT\*

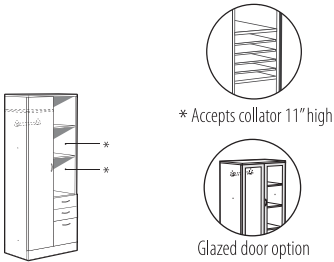

Personal Tower with Open Shelves - RIGHT\*

MODEL #	DIMENSIONS W x D x H (1.5" TOP)	WT/LB.	CUBIC FT.	1" TOP	1.5" TOP	GLAZE ADD	HP ADD
Z36L7BFNL	36 x 24 x 72.4	309	43.25	<b>\$2611</b>	<b>\$2659</b>	<b>\$761</b>	N/A
Z30L7BFNL	30 x 24 x 72.4	277	36.25	<b>\$2401</b>	<b>\$2436</b>	<b>\$648</b>	N/A
Z24L7BFNL	24 x 24 x 72.4	249	29.75	<b>\$2208</b>	<b>\$2259</b>	<b>\$505</b>	N/A
Z36M7BFNL	36 x 20 x 72.4	274	36.75	<b>\$2413</b>	<b>\$2475</b>	<b>\$761</b>	N/A
Z30M7BFNL	30 x 20 x 72.4	246	30.5	<b>\$2241</b>	<b>\$2293</b>	<b>\$648</b>	N/A
Z24M7BFNL	24 x 20 x 72.4	220	25.25	<b>\$2055</b>	<b>\$2097</b>	<b>\$505</b>	N/A

**Two box and one file drawer** on bottom. Laminate doors are standard. Storage compartment on **left** includes **two 3-position fixed/height adjustable shelves**. Wardrobe compartment on **right** includes hanging rod and **one adjustable shelf** above rod. Upper lock secures wardrobe compartment. Lower lock secures all drawers. Ganging hardware included with all units 24" wide or less and 41"H or taller. Shipped assembled in 1 carton.

Z36L7BFNR	36 x 24 x 72.4	309	43.25	<b>\$2611</b>	<b>\$2659</b>	<b>\$761</b>	N/A
Z30L7BFNR	30 x 24 x 72.4	277	36.25	<b>\$2401</b>	<b>\$2436</b>	<b>\$648</b>	N/A
Z24L7BFNR	24 x 24 x 72.4	249	29.75	<b>\$2208</b>	<b>\$2259</b>	<b>\$505</b>	N/A
Z36M7BFNR	36 x 20 x 72.4	274	36.75	<b>\$2413</b>	<b>\$2475</b>	<b>\$761</b>	N/A
Z30M7BFNR	30 x 20 x 72.4	246	30.5	<b>\$2241</b>	<b>\$2293</b>	<b>\$648</b>	N/A
Z24M7BFNR	24 x 20 x 72.4	220	25.25	<b>\$2055</b>	<b>\$2097</b>	<b>\$505</b>	N/A

**Two box and one file drawer** on bottom. Laminate doors are standard. Storage compartment on **right** includes **two 3-position fixed/height adjustable shelves**. Wardrobe compartment on **left** includes hanging rod and **one adjustable shelf** above rod. Upper lock secures wardrobe compartment. Lower lock secures all drawers. Ganging hardware included with all units 24" wide or less and 41"H or taller. Shipped assembled in 1 carton.

**Required specifications**

- Top finish
- Top thickness/edge detail
- Base finish
- Handles

**Optional specifications**

- Key #
- Box drawer - no upcharge
- Collator - position & finish\*
- Glazed door

**STORAGE MODULES - 84.5" / 85" HIGH**



Glazed door option

**Storage Cabinet with Doors**

MODEL #	DIMENSIONS W x D x H (1.5" TOP)	WT/LB.	CUBIC FT.	1" TOP	1.5" TOP	GLAZE ADD	HP ADD
Z36L8SH	36 x 24 x 84.9	333	50	<b>\$2571</b>	<b>\$2640</b>	<b>\$1845</b>	N/A
Z30L8SH	30 x 24 x 84.9	291	42	<b>\$2277</b>	<b>\$2339</b>	<b>\$1579</b>	N/A
Z36M8SH	36 x 20 x 84.9	299	42.25	<b>\$2367</b>	<b>\$2429</b>	<b>\$1845</b>	N/A
Z30M8SH	30 x 20 x 84.9	259	35.5	<b>\$2116</b>	<b>\$2168</b>	<b>\$1579</b>	N/A
Z36S8SH	36 x 16 x 84.9	259	34	<b>\$2134</b>	<b>\$2195</b>	<b>\$1845</b>	N/A
Z30S8SH	30 x 16 x 84.9	225	29	<b>\$1901</b>	<b>\$1943</b>	<b>\$1579</b>	N/A

Laminate doors are standard. **Includes four 3-position fixed/height adjustable shelves.** Standard with lock. Ganging hardware included with all units 24" wide or less and 41"H or taller. Shipped assembled in 1 carton.

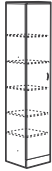

Glazed door option

**Storage Cabinet with Door - LEFT**

Z21L8SHL	21 x 24 x 84.9	227	30.25	<b>\$1859</b>	<b>\$1909</b>	<b>\$1030</b>	N/A
Z18L8SHL	18 x 24 x 84.9	206	26.25	<b>\$1748</b>	<b>\$1790</b>	<b>\$919</b>	N/A
Z16L8SHL	16 x 24 x 84.9	187	24	<b>\$1641</b>	<b>\$1683</b>	<b>\$911</b>	N/A
Z15L8SHL	15 x 24 x 84.9	182	22.5	<b>\$1618</b>	<b>\$1652</b>	<b>\$785</b>	N/A
Z12L8SHL	12 x 24 x 84.9	164	18.5	<b>\$1506</b>	<b>\$1536</b>	<b>\$700</b>	N/A
Z21M8SHL	21 x 20 x 84.9	202	25.5	<b>\$1679</b>	<b>\$1721</b>	<b>\$1030</b>	N/A
Z18M8SHL	18 x 20 x 84.9	181	22.25	<b>\$1603</b>	<b>\$1638</b>	<b>\$919</b>	N/A
Z16M8SHL	16 x 20 x 84.9	169	20.25	<b>\$1506</b>	<b>\$1541</b>	<b>\$911</b>	N/A
Z15M8SHL	15 x 20 x 84.9	163	19	<b>\$1440</b>	<b>\$1470</b>	<b>\$785</b>	N/A
Z12M8SHL	12 x 20 x 84.9	145	15.75	<b>\$1335</b>	<b>\$1360</b>	<b>\$700</b>	N/A
Z21S8SHL	21 x 16 x 84.9	172	21	<b>\$1535</b>	<b>\$1568</b>	<b>\$1030</b>	N/A
Z18S8SHL	18 x 16 x 84.9	154	18	<b>\$1432</b>	<b>\$1466</b>	<b>\$919</b>	N/A
Z16S8SHL	16 x 16 x 84.9	143	16.5	<b>\$1344</b>	<b>\$1378</b>	<b>\$911</b>	N/A
Z15S8SHL	15 x 16 x 84.9	138	15.5	<b>\$1282</b>	<b>\$1311</b>	<b>\$785</b>	N/A
Z12S8SHL	12 x 16 x 84.9	121	13	<b>\$1179</b>	<b>\$1204</b>	<b>\$700</b>	N/A

Laminate doors are standard. **Includes four 3-position fixed/height adjustable shelves.** Standard with lock. Ganging hardware included with all units 24" wide or less and 41"H or taller. Shipped assembled in 1 carton.

**Required specifications**

- Top finish
- Top thickness/edge detail
- Base finish
- Handles

**Optional specifications**

- Key #
- Collator - position & finish\*
- Glazed door

STORAGE MODULES - 84.5" / 85" HIGH



Glazed door option

Storage Cabinet with Door - RIGHT

MODEL #	DIMENSIONS W x D x H (1.5" TOP)	WT/LB.	CUBIC FT.	1" TOP	1.5" TOP	GLAZE ADD	HP ADD
Z21L8SHR	21 x 24 x 84.9	227	30.25	<b>\$1859</b>	<b>\$1909</b>	<b>\$1030</b>	N/A
Z18L8SHR	18 x 24 x 84.9	206	26.25	<b>\$1748</b>	<b>\$1790</b>	<b>\$919</b>	N/A
Z16L8SHR	16 x 24 x 84.9	187	24	<b>\$1641</b>	<b>\$1683</b>	<b>\$911</b>	N/A
Z15L8SHR	15 x 24 x 84.9	182	22.5	<b>\$1618</b>	<b>\$1652</b>	<b>\$785</b>	N/A
Z12L8SHR	12 x 24 x 84.9	164	18.5	<b>\$1506</b>	<b>\$1536</b>	<b>\$700</b>	N/A
Z21M8SHR	21 x 20 x 84.9	202	25.5	<b>\$1679</b>	<b>\$1721</b>	<b>\$1030</b>	N/A
Z18M8SHR	18 x 20 x 84.9	181	22.25	<b>\$1603</b>	<b>\$1638</b>	<b>\$919</b>	N/A
Z16M8SHR	16 x 20 x 84.9	169	20.25	<b>\$1506</b>	<b>\$1541</b>	<b>\$911</b>	N/A
Z15M8SHR	15 x 20 x 84.9	163	19	<b>\$1440</b>	<b>\$1470</b>	<b>\$785</b>	N/A
Z12M8SHR	12 x 20 x 84.9	145	15.75	<b>\$1335</b>	<b>\$1360</b>	<b>\$700</b>	N/A
Z21S8SHR	21 x 16 x 84.9	172	21	<b>\$1535</b>	<b>\$1568</b>	<b>\$1030</b>	N/A
Z18S8SHR	18 x 16 x 84.9	154	18	<b>\$1432</b>	<b>\$1466</b>	<b>\$919</b>	N/A
Z16S8SHR	16 x 16 x 84.9	143	16.5	<b>\$1344</b>	<b>\$1378</b>	<b>\$911</b>	N/A
Z15S8SHR	15 x 16 x 84.9	138	15.5	<b>\$1282</b>	<b>\$1311</b>	<b>\$785</b>	N/A
Z12S8SHR	12 x 16 x 84.9	121	13	<b>\$1179</b>	<b>\$1204</b>	<b>\$700</b>	N/A

Laminate doors are standard. **Includes four 3-position fixed/height adjustable shelves.** Standard with lock. Ganging hardware included with all units 24" wide or less and 41"H or taller. Shipped assembled in 1 carton.

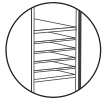

\* Accepts collator 11" high

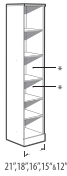
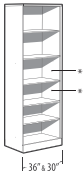

Open Storage Cabinet\*

Z36L8SHN	36 x 24 x 84.9	281	50	<b>\$1995</b>	<b>\$2064</b>	N/A	N/A
Z30L8SHN	30 x 24 x 84.9	247	42	<b>\$1773</b>	<b>\$1835</b>	N/A	N/A
Z21L8SHN	21 x 24 x 84.9	228	30.25	<b>\$1538</b>	<b>\$1588</b>	N/A	N/A
Z18L8SHN	18 x 24 x 84.9	207	26.25	<b>\$1456</b>	<b>\$1498</b>	N/A	N/A
Z16L8SHN	16 x 24 x 84.9	189	24	<b>\$1349</b>	<b>\$1391</b>	N/A	N/A
Z15L8SHN	15 x 24 x 84.9	183	22.5	<b>\$1329</b>	<b>\$1363</b>	N/A	N/A
Z12L8SHN	12 x 24 x 84.9	165	18.5	<b>\$1278</b>	<b>\$1308</b>	N/A	N/A
Z36M8SHN	36 x 20 x 84.9	246	42.25	<b>\$1796</b>	<b>\$1858</b>	N/A	N/A
Z30M8SHN	30 x 20 x 84.9	215	35.5	<b>\$1617</b>	<b>\$1669</b>	N/A	N/A
Z21M8SHN	21 x 20 x 84.9	170	25.5	<b>\$1357</b>	<b>\$1399</b>	N/A	N/A
Z18M8SHN	18 x 20 x 84.9	155	22.25	<b>\$1313</b>	<b>\$1348</b>	N/A	N/A
Z16M8SHN	16 x 20 x 84.9	146	20.25	<b>\$1218</b>	<b>\$1253</b>	N/A	N/A
Z15M8SHN	15 x 20 x 84.9	141	19	<b>\$1189</b>	<b>\$1219</b>	N/A	N/A
Z12M8SHN	12 x 20 x 84.9	126	15.75	<b>\$1106</b>	<b>\$1131</b>	N/A	N/A
Z36S8SHN	36 x 16 x 84.9	207	34	<b>\$1560</b>	<b>\$1621</b>	N/A	N/A
Z30S8SHN	30 x 16 x 84.9	181	29	<b>\$1400</b>	<b>\$1442</b>	N/A	N/A
Z21S8SHN	21 x 16 x 84.9	142	21	<b>\$1211</b>	<b>\$1244</b>	N/A	N/A
Z18S8SHN	18 x 16 x 84.9	128	18	<b>\$1142</b>	<b>\$1176</b>	N/A	N/A
Z16S8SHN	16 x 16 x 84.9	120	16.5	<b>\$1055</b>	<b>\$1089</b>	N/A	N/A
Z15S8SHN	15 x 16 x 84.9	116	15.5	<b>\$1029</b>	<b>\$1058</b>	N/A	N/A
Z12S8SHN	12 x 16 x 84.9	103	13	<b>\$952</b>	<b>\$977</b>	N/A	N/A

**Four adjustable shelves.** Ganging hardware included with all units 24" wide or less and 41"H or taller. Shipped assembled in 1 carton.



Glazed door option

Two File Module with Doors

Z36L8E	36 x 24 x 84.9	365	50	<b>\$3189</b>	<b>\$3258</b>	<b>\$1378</b>	N/A
Z30L8E	30 x 24 x 84.9	307	42	<b>\$2902</b>	<b>\$2964</b>	<b>\$1188</b>	N/A
Z36M8E	36 x 20 x 84.9	323	42.25	<b>\$2994</b>	<b>\$3056</b>	<b>\$1378</b>	N/A
Z30M8E	30 x 20 x 84.9	285	35.5	<b>\$2761</b>	<b>\$2813</b>	<b>\$1188</b>	N/A
Z36S8E	36 x 16 x 84.9	285	34	<b>\$2738</b>	<b>\$2799</b>	<b>\$1378</b>	N/A
Z30S8E	30 x 16 x 84.9	245	29	<b>\$2472</b>	<b>\$2514</b>	<b>\$1188</b>	N/A

Two lateral file drawers. Laminate doors are standard. **Includes two adjustable shelves.** Upper lock secures storage compartment. Lower lock secures two file drawers. Front-to-back and side-to-side letter/legal filing capability. Side-to-side file bars included. Shipped assembled in 1 carton.

- Lateral file drawer construction is for accommodating hanging files NOT for stacking materials on the drawer bottom.

Required specifications

Top finish  
Top thickness/edge detail  
Base finish  
Handles

Optional specifications

Key #  
Collator - position & finish\*  
Glazed door (not Zxxx8SHN)



**STORAGE MODULES - 84.5" / 85" HIGH**      **MODEL #**      **DIMENSIONS**      **WT/LB.**      **CUBIC FT.**      **1" TOP**      **1.5" TOP**      **GLAZE ADD**      **HP ADD**



Glazed door option

**Two File Module with Door - LEFT\***

	W x D x H (1.5" TOP)							
Z16L8EL	16 x 24	84.9	206	24	<b>\$1896</b>	<b>\$1938</b>	<b>\$679</b>	N/A
Z15L8EL	15 x 24	84.9	192	22.5	<b>\$1844</b>	<b>\$1878</b>	<b>\$589</b>	N/A
Z16M8EL	16 x 20	84.9	186	20.25	<b>\$1773</b>	<b>\$1808</b>	<b>\$679</b>	N/A
Z15M8EL	15 x 20	84.9	180	19	<b>\$1709</b>	<b>\$1739</b>	<b>\$589</b>	N/A
Z16S8EL	16 x 16	84.9	156	16.5	<b>\$1615</b>	<b>\$1649</b>	<b>\$679</b>	N/A
Z15S8EL	15 x 16	84.9	149	15.5	<b>\$1561</b>	<b>\$1590</b>	<b>\$589</b>	N/A

Two file drawers on bottom. Laminate door is standard. **Includes two 3-position fixed/height adjustable shelves.** Upper lock secures storage compartment. Lower lock secures two file drawers. Ganging hardware included with all units 24" wide or less and 41"H or taller. Shipped assembled in 1 carton.



Glazed door option

**Two File Module with Door - RIGHT\***

Z16L8ER	16 x 24	84.9	206	24	<b>\$1896</b>	<b>\$1938</b>	<b>\$679</b>	N/A
Z15L8ER	15 x 24	84.9	192	22.5	<b>\$1844</b>	<b>\$1878</b>	<b>\$589</b>	N/A
Z16M8ER	16 x 20	84.9	186	20.25	<b>\$1773</b>	<b>\$1808</b>	<b>\$679</b>	N/A
Z15M8ER	15 x 20	84.9	180	19	<b>\$1709</b>	<b>\$1739</b>	<b>\$589</b>	N/A
Z16S8ER	16 x 16	84.9	156	16.5	<b>\$1615</b>	<b>\$1649</b>	<b>\$679</b>	N/A
Z15S8ER	15 x 16	84.9	149	15.5	<b>\$1561</b>	<b>\$1590</b>	<b>\$589</b>	N/A

Two file drawers on bottom. Laminate door is standard. **Includes two 3-position fixed/height adjustable shelves.** Upper lock secures storage compartment. Lower lock secures two file drawers. Ganging hardware included with all units 24" wide or less and 41"H or taller. Shipped assembled in 1 carton.

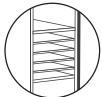

\* Accepts collator 11" high

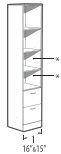
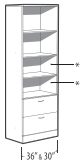

**Two File Module with Open Shelves\*\***

Z36L8EN	36 x 24	84.9	330	50	<b>\$2734</b>	<b>\$2803</b>	N/A	N/A
Z30L8EN	30 x 24	84.9	276	42	<b>\$2503</b>	<b>\$2565</b>	N/A	N/A
Z16L8EN	16 x 24	84.9	192	24	<b>\$1668</b>	<b>\$1710</b>	N/A	N/A
Z15L8EN	15 x 24	84.9	178	22.5	<b>\$1642</b>	<b>\$1676</b>	N/A	N/A
Z36M8EN	36 x 20	84.9	286	42.25	<b>\$2539</b>	<b>\$2601</b>	N/A	N/A
Z30M8EN	30 x 20	84.9	254	35.5	<b>\$2363</b>	<b>\$2415</b>	N/A	N/A
Z16M8EN	16 x 20	84.9	170	20.25	<b>\$1544</b>	<b>\$1579</b>	N/A	N/A
Z15M8EN	15 x 20	84.9	164	19	<b>\$1506</b>	<b>\$1536</b>	N/A	N/A
Z36S8EN	36 x 16	84.9	247	34	<b>\$2110</b>	<b>\$2171</b>	N/A	N/A
Z30S8EN	30 x 16	84.9	213	29	<b>\$1902</b>	<b>\$1944</b>	N/A	N/A
Z16S8EN	16 x 16	84.9	139	16.5	<b>\$1383</b>	<b>\$1417</b>	N/A	N/A
Z15S8EN	15 x 16	84.9	134	15.5	<b>\$1357</b>	<b>\$1386</b>	N/A	N/A

Four open shelves and two file drawers on bottom. **Includes one 3-position fixed/height adjustable shelf.** Lock secures all drawers. 36" and 30" wide models have front-to-back and side-to-side letter/legal filing capability. Side-to-side file bars included. Ganging hardware included with all units 24" wide or less and 41"H or taller. Shipped assembled in 1 carton.

- Lateral file drawer construction is for accommodating hanging files NOT for stacking materials on the drawer bottom.

**Required specifications**

- Top finish
- Top thickness/edge detail
- Base finish
- Handles (not Zxxx8SHN)

**Optional specifications**

- Key # (not Zxxx8SHN)
- Box drawer - no upcharge
- Collator - position & finish\*\*
- Glazed door\*

WARDROBE CABINETS - 84.5" / 85" HIGH



Wardrobe Cabinet

MODEL #	DIMENSIONS W x D x H (1.5" TOP)	WT/LB.	CUBIC FT.	1" TOP	1.5" TOP	GLAZE ADD	HP ADD
Z36L8WA	36 x 24 x 84.9	291	50	<b>\$2383</b>	<b>\$2452</b>	N/A	N/A
Z30L8WA	30 x 24 x 84.9	256	42	<b>\$2140</b>	<b>\$2202</b>	N/A	N/A
Z36M8WA	36 x 20 x 84.9	265	42.25	<b>\$2223</b>	<b>\$2285</b>	N/A	N/A
Z30M8WA	30 x 20 x 84.9	231	35.5	<b>\$2014</b>	<b>\$2066</b>	N/A	N/A

Laminate doors are standard. Full length hanging rod included. **One adjustable shelf** above hanging rod. Standard with lock. Shipped assembled in 1 carton.



Wardrobe Cabinet - LEFT

Z24L8WAL	24 x 24 x 84.9	221	34.25	<b>\$1784</b>	<b>\$1835</b>	N/A	N/A
Z21L8WAL	21 x 24 x 84.9	192	30.25	<b>\$1718</b>	<b>\$1768</b>	N/A	N/A
Z18L8WAL	18 x 24 x 84.9	185	26.25	<b>\$1601</b>	<b>\$1643</b>	N/A	N/A
Z16L8WAL	16 x 24 x 84.9	172	24	<b>\$1529</b>	<b>\$1571</b>	N/A	N/A
Z15L8WAL	15 x 24 x 84.9	162	22.5	<b>\$1485</b>	<b>\$1519</b>	N/A	N/A
Z12L8WAL	12 x 24 x 84.9	150	18.5	<b>\$1366</b>	<b>\$1396</b>	N/A	N/A
Z24M8WAL	24 x 20 x 84.9	197	28.5	<b>\$1660</b>	<b>\$1702</b>	N/A	N/A
Z21M8WAL	21 x 20 x 84.9	183	25.5	<b>\$1599</b>	<b>\$1641</b>	N/A	N/A
Z18M8WAL	18 x 20 x 84.9	165	22.25	<b>\$1483</b>	<b>\$1518</b>	N/A	N/A
Z16M8WAL	16 x 20 x 84.9	154	20.25	<b>\$1415</b>	<b>\$1450</b>	N/A	N/A
Z15M8WAL	15 x 20 x 84.9	149	19	<b>\$1357</b>	<b>\$1387</b>	N/A	N/A
Z12M8WAL	12 x 20 x 84.9	133	15.75	<b>\$1263</b>	<b>\$1288</b>	N/A	N/A

Laminate doors are standard. Full length hanging rod included. **One adjustable shelf** above hanging rod. Standard with lock. Ganging hardware included with all units 24" wide or less and 41"H or taller. Shipped assembled in 1 carton.



Wardrobe Cabinet - RIGHT

Z24L8WAR	24 x 24 x 84.9	221	34.25	<b>\$1784</b>	<b>\$1835</b>	N/A	N/A
Z21L8WAR	21 x 24 x 84.9	192	30.25	<b>\$1718</b>	<b>\$1768</b>	N/A	N/A
Z18L8WAR	18 x 24 x 84.9	185	26.25	<b>\$1601</b>	<b>\$1643</b>	N/A	N/A
Z16L8WAR	16 x 24 x 84.9	172	24	<b>\$1529</b>	<b>\$1571</b>	N/A	N/A
Z15L8WAR	15 x 24 x 84.9	162	22.5	<b>\$1485</b>	<b>\$1519</b>	N/A	N/A
Z12L8WAR	12 x 24 x 84.9	150	18.5	<b>\$1366</b>	<b>\$1396</b>	N/A	N/A
Z24M8WAR	24 x 20 x 84.9	197	28.5	<b>\$1660</b>	<b>\$1702</b>	N/A	N/A
Z21M8WAR	21 x 20 x 84.9	183	25.5	<b>\$1599</b>	<b>\$1641</b>	N/A	N/A
Z18M8WAR	18 x 20 x 84.9	165	22.25	<b>\$1483</b>	<b>\$1518</b>	N/A	N/A
Z16M8WAR	16 x 20 x 84.9	154	20.25	<b>\$1415</b>	<b>\$1450</b>	N/A	N/A
Z15M8WAR	15 x 20 x 84.9	149	19	<b>\$1357</b>	<b>\$1387</b>	N/A	N/A
Z12M8WAR	12 x 20 x 84.9	133	15.75	<b>\$1263</b>	<b>\$1288</b>	N/A	N/A

Laminate doors are standard. Full length hanging rod included. **One adjustable shelf** above hanging rod. Standard with lock. Ganging hardware included with all units 24" wide or less and 41"H or taller. Shipped assembled in 1 carton.



Glazed door option

Wardrobe Cabinet/Shelving Combo with Doors - LEFT\*

Z36L8DIL	36 x 24 x 84.9	339	50	<b>\$2759</b>	<b>\$2828</b>	<b>\$1845</b>	N/A
Z30L8DIL	30 x 24 x 84.9	301	42	<b>\$2417</b>	<b>\$2479</b>	<b>\$1579</b>	N/A
Z24L8DIL	24 x 24 x 84.9	269	34.25	<b>\$2189</b>	<b>\$2240</b>	<b>\$1449</b>	N/A
Z21L8DIL	21 x 24 x 84.9	252	30.25	<b>\$2115</b>	<b>\$2145</b>	<b>\$1438</b>	N/A
Z36M8DIL	36 x 20 x 84.9	306	42.25	<b>\$2594</b>	<b>\$2656</b>	<b>\$1845</b>	N/A
Z30M8DIL	30 x 20 x 84.9	266	35.5	<b>\$2285</b>	<b>\$2337</b>	<b>\$1579</b>	N/A
Z24M8DIL	24 x 20 x 84.9	233	28.5	<b>\$2061</b>	<b>\$2103</b>	<b>\$1449</b>	N/A
Z21M8DIL	21 x 20 x 84.9	215	25.5	<b>\$1961</b>	<b>\$2013</b>	<b>\$1438</b>	N/A

Laminate doors are standard. Storage compartment on **left includes five adjustable shelves**. Wardrobe compartment on **right** includes hanging rod and **one adjustable shelf** above rod. Storage and wardrobe compartments lock independently. Each door lock keyed alike. Ganging hardware included with all units 24" wide or less and 41"H or taller. Shipped assembled in 1 carton.

**Required specifications**

- Top finish
- Top thickness/edge detail
- Base finish
- Handles

**Optional specifications**

- Key #
- Glazed door\*

WARDROBE CABINETS - 84.5" / 85" HIGH	MODEL #	DIMENSIONS	WT/LB.	CUBIC FT.	1" TOP	1.5" TOP	GLAZE ADD	HP ADD
--------------------------------------	---------	------------	--------	-----------	--------	----------	-----------	--------



Glazed door option

**Wardrobe Cabinet/Shelving Combo with Doors - RIGHT**

	W x D x H (1.5" TOP)							
Z36L8DIR	36 x 24 x 84.9	339	50	\$2759	\$2828	\$1845	N/A	
Z30L8DIR	30 x 24 x 84.9	301	42	\$2417	\$2479	\$1579	N/A	
Z24L8DIR	24 x 24 x 84.9	269	34.25	\$2189	\$2240	\$1449	N/A	
Z21L8DIR	21 x 24 x 84.9	252	30.25	\$2115	\$2145	\$1438	N/A	
Z36M8DIR	36 x 20 x 84.9	306	42.25	\$2594	\$2656	\$1845	N/A	
Z30M8DIR	30 x 20 x 84.9	266	35.5	\$2285	\$2337	\$1579	N/A	
Z24M8DIR	24 x 20 x 84.9	233	28.5	\$2061	\$2103	\$1449	N/A	
Z21M8DIR	21 x 20 x 84.9	215	25.5	\$1961	\$2013	\$1438	N/A	

Laminate doors are standard. Storage compartment on **right includes five adjustable shelves**. Wardrobe compartment on **left** includes hanging rod and **one adjustable shelf** above rod. Storage and wardrobe compartments lock independently. Each door lock keyed alike. Ganging hardware included with all units 24" wide or less and 41"H or taller. Shipped assembled in 1 carton.

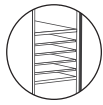
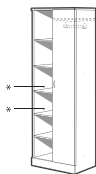

\* Accepts collator 11" high



Glazed door option

**Wardrobe Cabinet/Open Shelving Combo - LEFT\***

Z36L8DINL	36 x 24 x 84.9	312	50	\$2468	\$2537	\$919	N/A	
Z30L8DINL	30 x 24 x 84.9	278	42	\$2165	\$2227	\$785	N/A	
Z24L8DINL	24 x 24 x 84.9	245	34.25	\$1981	\$2032	\$700	N/A	
Z21L8DINL	21 x 24 x 84.9	236	30.25	\$1929	\$1951	\$695	N/A	
Z36M8DINL	36 x 20 x 84.9	275	42.25	\$2305	\$2367	\$919	N/A	
Z30M8DINL	30 x 20 x 84.9	243	35.5	\$2035	\$2087	\$785	N/A	
Z24M8DINL	24 x 20 x 84.9	215	28.5	\$1855	\$1897	\$700	N/A	
Z21M8DINL	21 x 20 x 84.9	199	25.5	\$1771	\$1813	\$695	N/A	

Laminate door is standard on wardrobe section. Storage compartment on **left includes five adjustable shelves**. Wardrobe compartment on **right** includes hanging rod and **one adjustable shelf** above rod. Single lock secures wardrobe compartment. Ganging hardware included with all units 24" wide or less and 41"H or taller. Shipped assembled in 1 carton.

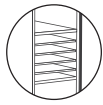

\* Accepts collator 11" high



Glazed door option

**Wardrobe Cabinet/Open Shelving Combo - RIGHT\***

Z36L8DINR	36 x 24 x 84.9	312	50	\$2468	\$2537	\$919	N/A	
Z30L8DINR	30 x 24 x 84.9	278	42	\$2165	\$2227	\$785	N/A	
Z24L8DINR	24 x 24 x 84.9	245	34.25	\$1981	\$2032	\$700	N/A	
Z21L8DINR	21 x 24 x 84.9	236	30.25	\$1929	\$1951	\$695	N/A	
Z36M8DINR	36 x 20 x 84.9	275	42.25	\$2305	\$2367	\$919	N/A	
Z30M8DINR	30 x 20 x 84.9	243	35.5	\$2035	\$2087	\$785	N/A	
Z24M8DINR	24 x 20 x 84.9	215	28.5	\$1855	\$1897	\$700	N/A	
Z21M8DINR	21 x 20 x 84.9	199	25.5	\$1771	\$1813	\$695	N/A	

Laminate door is standard on wardrobe section. Storage compartment on **right includes five adjustable shelves**. Wardrobe compartment on **left** includes hanging rod and **one adjustable shelf** above rod. Single lock secures wardrobe compartment. Ganging hardware included with all units 24" wide or less and 41"H or taller. Shipped assembled in 1 carton.

**Required specifications**

- Top finish
- Top thickness/edge detail
- Base finish
- Handles

**Optional specifications**

- Key #
- Collator - position & finish\*
- Glazed door

PERSONAL TOWERS - 84.5" / 85" HIGH

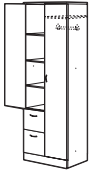

Glazed door option

Personal Tower with Doors - LEFT

MODEL #	DIMENSIONS W x D x H (1.5" TOP)	WT/LB.	CUBIC FT.	1" TOP	1.5" TOP	GLAZE ADD	HP ADD
Z36L8EL	36 x 24 x 84.9	369	50	\$2945	\$3014	\$1601	N/A
Z30L8EL	30 x 24 x 84.9	335	42	\$2692	\$2754	\$1459	N/A
Z24L8EL	24 x 24 x 84.9	299	34.25	\$2599	\$2650	\$1258	N/A
Z36M8EL	36 x 20 x 84.9	333	42.25	\$2784	\$2846	\$1601	N/A
Z30M8EL	30 x 20 x 84.9	298	35.5	\$2567	\$2619	\$1459	N/A
Z24M8EL	24 x 20 x 84.9	266	29	\$2446	\$2488	\$1258	N/A

**Two file drawers** on bottom. Laminate doors are standard. Storage compartment on **left** includes **three adjustable shelves**. Wardrobe compartment on **right** includes hanging rod and **one adjustable shelf** above rod. Two upper locks secure storage and wardrobe compartments. Lower lock secures all drawers. Shipped assembled in 1 carton.

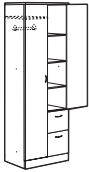

Glazed door option

Personal Tower with Doors - RIGHT

Z36L8ER	36 x 24 x 84.9	369	50	\$2945	\$3014	\$1601	N/A
Z30L8ER	30 x 24 x 84.9	335	42	\$2692	\$2754	\$1459	N/A
Z24L8ER	24 x 24 x 84.9	299	34.25	\$2599	\$2650	\$1258	N/A
Z36M8ER	36 x 20 x 84.9	333	42.25	\$2784	\$2846	\$1601	N/A
Z30M8ER	30 x 20 x 84.9	298	35.5	\$2567	\$2619	\$1459	N/A
Z24M8ER	24 x 20 x 84.9	266	29	\$2446	\$2488	\$1258	N/A

**Two file drawers** on bottom. Laminate doors are standard. Storage compartment on **right** includes **three adjustable shelves**. Wardrobe compartment on **left** includes hanging rod and **one adjustable shelf** above rod. Two upper locks secure storage and wardrobe compartments. Lower lock secures all drawers. Shipped assembled in 1 carton.

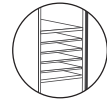
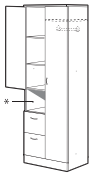

\* Accepts collator 11" high



Glazed door option

Personal Tower with Doors and Cavity - LEFT\*

Z36L8ECL	36 x 24 x 84.9	366	50	\$2918	\$2987	\$1510	N/A
Z30L8ECL	30 x 24 x 84.9	332	42	\$2660	\$2722	\$1367	N/A
Z24L8ECL	24 x 24 x 84.9	295	34.25	\$2558	\$2609	\$1170	N/A
Z36M8ECL	36 x 20 x 84.9	329	42.25	\$2741	\$2803	\$1510	N/A
Z30M8ECL	30 x 20 x 84.9	295	35.5	\$2526	\$2578	\$1367	N/A
Z24M8ECL	24 x 20 x 84.9	263	29	\$2409	\$2451	\$1170	N/A

**Two file drawers** on bottom. Laminate doors are standard. Storage compartment on **left** includes **two 3-position fixed/height adjustable shelves**. Wardrobe compartment on **right** includes hanging rod and **one adjustable shelf** above rod. Two upper locks secure storage and wardrobe compartments. Lower lock secures all drawers. Shipped assembled in 1 carton.

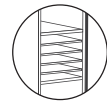
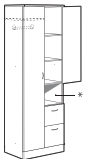

\* Accepts collator 11" high



Glazed door option

Personal Tower with Doors and Cavity - RIGHT\*

Z36L8ECR	36 x 24 x 84.9	366	50	\$2918	\$2987	\$1510	N/A
Z30L8ECR	30 x 24 x 84.9	332	42	\$2660	\$2722	\$1367	N/A
Z24L8ECR	24 x 24 x 84.9	295	34.25	\$2558	\$2609	\$1170	N/A
Z36M8ECR	36 x 20 x 84.9	329	42.25	\$2741	\$2803	\$1510	N/A
Z30M8ECR	30 x 20 x 84.9	295	35.5	\$2526	\$2578	\$1367	N/A
Z24M8ECR	24 x 20 x 84.9	263	29	\$2409	\$2451	\$1170	N/A

**Two file drawers** on bottom. Laminate doors are standard. Storage compartment on **right** includes **two 3-position fixed/height adjustable shelves**. Wardrobe compartment on **left** includes hanging rod and **one adjustable shelf** above rod. Two upper locks secure storage and wardrobe compartments. Lower lock secures all drawers. Shipped assembled in 1 carton.

Required specifications

Top finish  
Top thickness/edge detail  
Base finish  
Handles

Optional specifications

Key #  
Box drawer - no upcharge  
Collator - position & finish\*  
Glazed door

**PERSONAL TOWERS - 84.5" / 85" HIGH**

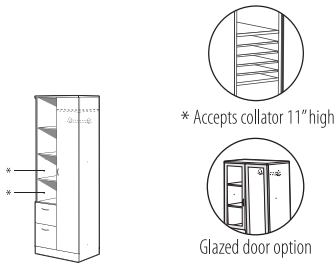

**Personal Tower with Open Shelves - LEFT\***

MODEL #	DIMENSIONS W x D x H (1.5" TOP)	WT/LB.	CUBIC FT.	1" TOP		GLAZE ADD	HP ADD
				1" TOP	1.5" TOP		
Z36L8ENL	36 x 24 x 84.9	352	50	\$2760	\$2829	\$924	N/A
Z30L8ENL	30 x 24 x 84.9	320	42	\$2501	\$2563	\$781	N/A
Z24L8ENL	24 x 24 x 84.9	283	34.25	\$2369	\$2420	\$583	N/A
Z36M8ENL	36 x 20 x 84.9	314	42.25	\$2582	\$2644	\$919	N/A
Z30M8ENL	30 x 20 x 84.9	283	35.5	\$2365	\$2417	\$785	N/A
Z24M8ENL	24 x 20 x 84.9	249	29	\$2220	\$2262	\$583	N/A

**Two file drawers** on bottom. Laminate door is standard on wardrobe section. Storage compartment on **left** includes **three 3-position fixed/height adjustable shelves**. Wardrobe compartment on **right** includes hanging rod and **one adjustable shelf** above rod. Upper lock secures wardrobe compartment. Lower lock secures all drawers. Shipped assembled in 1 carton.

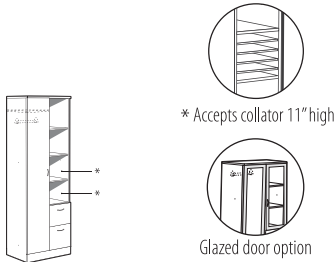

**Personal Tower with Open Shelves - RIGHT\***

Z36L8ENR	36 x 24 x 84.9	352	50	\$2760	\$2829	\$924	N/A
Z30L8ENR	30 x 24 x 84.9	320	42	\$2501	\$2563	\$781	N/A
Z24L8ENR	24 x 24 x 84.9	283	34.25	\$2369	\$2420	\$583	N/A
Z36M8ENR	36 x 20 x 84.9	314	42.25	\$2582	\$2644	\$919	N/A
Z30M8ENR	30 x 20 x 84.9	283	35.5	\$2365	\$2417	\$785	N/A
Z24M8ENR	24 x 20 x 84.9	249	29	\$2220	\$2262	\$583	N/A

**Two file drawers** on bottom. Laminate door is standard on wardrobe section. Storage compartment on **right** includes **three 3-position fixed/height adjustable shelves**. Wardrobe compartment on **left** includes hanging rod and **one adjustable shelf** above rod. Upper lock secures wardrobe compartment. Lower lock secures all drawers. Shipped assembled in 1 carton.

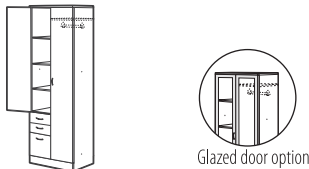

**Personal Tower with Doors - LEFT**

Z36L8BFL	36 x 24 x 84.9	372	50	\$3083	\$3152	\$1601	N/A
Z30L8BFL	30 x 24 x 84.9	337	42	\$2840	\$2902	\$1459	N/A
Z24L8BFL	24 x 24 x 84.9	301	34.25	\$2702	\$2753	\$1258	N/A
Z36M8BFL	36 x 20 x 84.9	335	42.25	\$2910	\$2972	\$1601	N/A
Z30M8BFL	30 x 20 x 84.9	300	35.5	\$2702	\$2754	\$1459	N/A
Z24M8BFL	24 x 20 x 84.9	268	29	\$2550	\$2592	\$1258	N/A

**Two box and one file drawer** on bottom. Laminate doors are standard. Storage compartment on **left** includes **three 3-position fixed/height adjustable shelves**. Wardrobe compartment on **right** includes hanging rod and **one adjustable shelf** above rod. Two upper locks secure storage and wardrobe compartments. Lower lock secures all drawers. Shipped assembled in 1 carton.

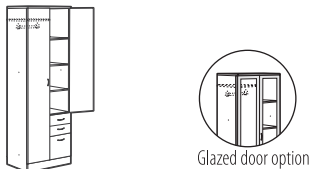

**Personal Tower with Doors - RIGHT**

Z36L8BFR	36 x 24 x 84.9	372	50	\$3083	\$3152	\$1601	N/A
Z30L8BFR	30 x 24 x 84.9	337	42	\$2840	\$2902	\$1459	N/A
Z24L8BFR	24 x 24 x 84.9	301	34.25	\$2702	\$2753	\$1258	N/A
Z36M8BFR	36 x 20 x 84.9	335	42.25	\$2910	\$2972	\$1601	N/A
Z30M8BFR	30 x 20 x 84.9	300	35.5	\$2702	\$2754	\$1459	N/A
Z24M8BFR	24 x 20 x 84.9	268	29	\$2550	\$2592	\$1258	N/A

**Two box and one file drawer** on bottom. Laminate doors are standard. Storage compartment on **right** includes **three 3-position fixed/height adjustable shelves**. Wardrobe compartment on **left** includes hanging rod and **one adjustable shelf** above rod. Two upper locks secure storage and wardrobe compartments. Lower lock secures all drawers. Shipped assembled in 1 carton.

**Required specifications**

- Top finish
- Top thickness/edge detail
- Base finish
- Handles

**Optional specifications**

- Key #
- Box drawer - no upcharge
- Collator - position & finish\*
- Glazed door

PERSONAL TOWERS - 84.5" / 85" HIGH

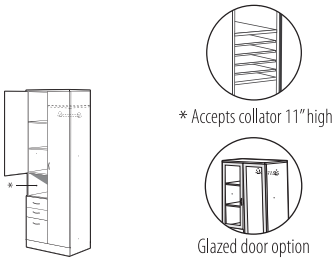

Personal Tower with Doors and Cavity - LEFT

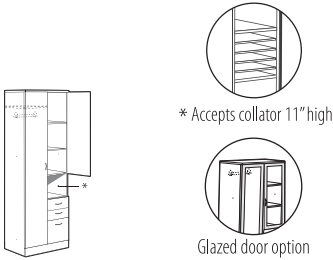

Personal Tower with Doors and Cavity - RIGHT

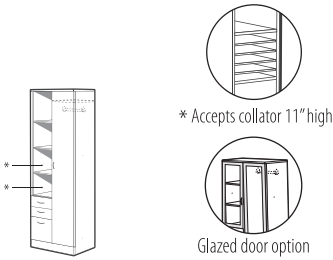

Personal Tower with Open Shelves - LEFT

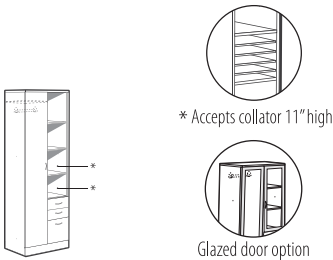

Personal Tower with Open Shelves - RIGHT

MODEL #	DIMENSIONS W x D x H (1.5" TOP)	WT/LB.	CUBIC FT.	1" TOP	1.5" TOP	GLAZE ADD	HP ADD
Z36L8BFCL	36 x 24 x 84.9	370	50	\$3042	\$3111	\$1510	N/A
Z30L8BFCL	30 x 24 x 84.9	335	42	\$2800	\$2862	\$1367	N/A
Z24L8BFCL	24 x 24 x 84.9	297	34.25	\$2660	\$2711	\$1170	N/A
Z36M8BFCL	36 x 20 x 84.9	331	42.25	\$2868	\$2930	\$1510	N/A
Z30M8BFCL	30 x 20 x 84.9	299	35.5	\$2660	\$2712	\$1367	N/A
Z24M8BFCL	24 x 20 x 84.9	265	29	\$2509	\$2551	\$1170	N/A

**Two box and one file drawer** on bottom. Laminate doors are standard. Storage compartment on **left** includes **one fixed shelf and one 3-position fixed/height adjustable shelf**. Wardrobe compartment on **right** includes hanging rod and **one adjustable shelf** above rod. Two upper locks secure storage and wardrobe compartments. Lower lock secures all drawers. Shipped assembled in 1 carton.

Z36L8BFCL	36 x 24 x 84.9	370	50	\$3042	\$3111	\$1510	N/A
Z30L8BFCL	30 x 24 x 84.9	335	42	\$2800	\$2862	\$1367	N/A
Z24L8BFCL	24 x 24 x 84.9	297	34.25	\$2660	\$2711	\$1170	N/A
Z36M8BFCL	36 x 20 x 84.9	331	42.25	\$2868	\$2930	\$1510	N/A
Z30M8BFCL	30 x 20 x 84.9	299	35.5	\$2660	\$2712	\$1367	N/A
Z24M8BFCL	24 x 20 x 84.9	265	29	\$2509	\$2551	\$1170	N/A

**Two box and one file drawer** on bottom. Laminate doors are standard. Storage compartment on **right** includes **one fixed shelf and one 3-position fixed/height adjustable shelf**. Wardrobe compartment on **left** includes hanging rod and one adjustable shelf above rod. Two upper locks secure storage and wardrobe compartments. Lower lock secures all drawers. Shipped assembled in 1 carton.

Z36L8BFNL	36 x 24 x 84.9	355	50	\$2882	\$2951	\$924	N/A
Z30L8BFNL	30 x 24 x 84.9	322	42	\$2639	\$2701	\$781	N/A
Z24L8BFNL	24 x 24 x 84.9	285	34.25	\$2473	\$2524	\$583	N/A
Z36M8BFNL	36 x 20 x 84.9	316	42.25	\$2707	\$2783	\$919	N/A
Z30M8BFNL	30 x 20 x 84.9	287	35.5	\$2501	\$2553	\$785	N/A
Z24M8BFNL	24 x 20 x 84.9	251	29	\$2322	\$2364	\$583	N/A

**Two box and one file drawer** on bottom. Laminate door is standard on wardrobe section. Storage compartment on **left** includes **three 3-position fixed/height adjustable shelves**. Wardrobe compartment on **right** includes hanging rod and **one adjustable shelf** above rod. Upper lock secures wardrobe compartment. Lower lock secures all drawers. Shipped assembled in 1 carton.

Z36L8BFNR	36 x 24 x 84.9	355	50	\$2882	\$2951	\$924	N/A
Z30L8BFNR	30 x 24 x 84.9	322	42	\$2639	\$2701	\$781	N/A
Z24L8BFNR	24 x 24 x 84.9	285	34.25	\$2473	\$2524	\$583	N/A
Z36M8BFNR	36 x 20 x 84.9	316	42.25	\$2707	\$2783	\$919	N/A
Z30M8BFNR	30 x 20 x 84.9	287	35.5	\$2501	\$2553	\$785	N/A
Z24M8BFNR	24 x 20 x 84.9	251	29	\$2322	\$2364	\$583	N/A

**Two box and one file drawer** on bottom. Laminate door is standard on wardrobe section. Storage compartment on **right** includes **three 3-position fixed/height adjustable shelves**. Wardrobe compartment on **left** includes hanging rod and **one adjustable shelf** above rod. Upper lock secures wardrobe compartment. Lower lock secures all drawers. Shipped assembled in 1 carton.

**Required specifications**

- Top finish
- Top thickness/edge detail
- Base finish
- Handles

**Optional specifications**

- Key #
- Box drawer - no upcharge
- Collator - position & finish
- Glazed door

**OVERHEAD STORAGE - 33"H**

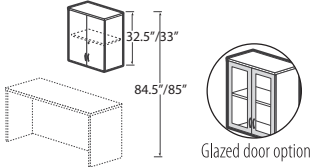

**Closed Front Overhead Storage with Doors - 33"/33.5" High\***

MODEL #	DIMENSIONS W x D x H (1.5" TOP)	WT/LB.	CUBIC FT.	1" TOP	1.5" TOP	GLAZE ADD	HP ADD
Z42S330S	42 x 16 x 33	136	16.25	<b>\$1078</b>	<b>\$1146</b>	<b>\$1055</b>	N/A
Z36S330S	36 x 16 x 33	120	14	<b>\$976</b>	<b>\$1037</b>	<b>\$952</b>	N/A
Z30S330S	30 x 16 x 33	104	11.75	<b>\$871</b>	<b>\$907</b>	<b>\$827</b>	N/A
Z24S330S	24 x 16 x 33	81	9.75	<b>\$780</b>	<b>\$822</b>	<b>\$722</b>	N/A

Includes steel hanging rail for wall mount applications. Includes one fixed shelf. Doors lock. Shipped easy to assemble in 1 carton.

• **NOTE:** Care should be taken to mount the units. Units should be mounted to wall studs using correct fasteners. Failure to do so may result in collapse of the unit and subsequent personal injury. **Fastening hardware not included.** Mounting hardware used should be based on wall material. Consult an installation professional for proper wall mounting.

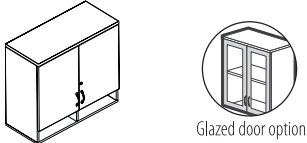

**Closed Front Overhead Storage with Pigeon Hole - 32.5"/33" H**

Z42S330P	42 x 16 x 33	140	16.25	<b>\$1639</b>	<b>\$1726</b>	<b>\$848</b>	N/A
Z36S330P	36 x 16 x 33	122	14	<b>\$1416</b>	<b>\$1495</b>	<b>\$773</b>	N/A
Z30S330P	30 x 16 x 33	105	12	<b>\$1267</b>	<b>\$1331</b>	<b>\$688</b>	N/A
Z24S330P	24 x 16 x 33	88	9.75	<b>\$1139</b>	<b>\$1198</b>	<b>\$624</b>	N/A

Includes steel hanging rail for wall mount applications. Includes one fixed shelf. Doors lock. Shipped easy to assemble in 1 carton.

• **NOTE:** Care should be taken to mount the units. Units should be mounted to wall studs using correct fasteners. Failure to do so may result in collapse of the unit and subsequent personal injury. **Fastening hardware not included.** Mounting hardware used should be based on wall material. Consult an installation professional for proper wall mounting.  
• **42"W** unit has four pigeon hole compartments.

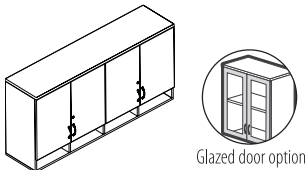

**Closed Front Overhead Storage with Pigeon Hole - 32.5"/33" H**

Z72S330S	72 x 16 x 33	230	26	<b>\$2659</b>	<b>\$2772</b>	<b>\$1552</b>	N/A
Z66S330S	66 x 16 x 33	215	24	<b>\$2553</b>	<b>\$2659</b>	<b>\$1522</b>	N/A
Z60S330S	60 x 16 x 33	199	22	<b>\$2355</b>	<b>\$2451</b>	<b>\$1379</b>	N/A
Z54S330S	54 x 16 x 33	184	21	<b>\$2237</b>	<b>\$2327</b>	<b>\$1351</b>	N/A

Includes steel hanging rail for wall mount applications. Includes one fixed shelf. Doors lock. Shipped easy to assemble in 1 carton.

• **NOTE:** Care should be taken to mount the units. Units should be mounted to wall studs using correct fasteners. Failure to do so may result in collapse of the unit and subsequent personal injury. **Fastening hardware not included.** Mounting hardware used should be based on wall material. Consult an installation professional for proper wall mounting.

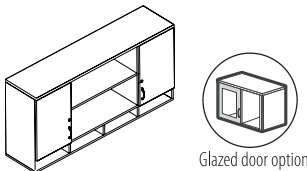

**Overhead Storage, 2 Outer Doors with Pigeon Hole - 32.5"/33" H**

Z72S33SOS	72 x 16 x 33	215	26	<b>\$2402</b>	<b>\$2515</b>	<b>\$778</b>	N/A
Z66S33SOS	66 x 16 x 33	201	24	<b>\$2294</b>	<b>\$2400</b>	<b>\$762</b>	N/A
Z60S33SOS	60 x 16 x 33	187	22	<b>\$2156</b>	<b>\$2252</b>	<b>\$748</b>	N/A
Z54S33SOS	54 x 16 x 33	173	21	<b>\$2005</b>	<b>\$2095</b>	<b>\$675</b>	N/A

**Doors on upper outer compartments only.** Includes steel hanging rail for wall mount applications. Includes one fixed shelf. Doors lock. Shipped easy to assemble in 1 carton.

• **NOTE:** Care should be taken to mount the units. Units should be mounted to wall studs using correct fasteners. Failure to do so may result in collapse of the unit and subsequent personal injury. **Fastening hardware not included.** Mounting hardware used should be based on wall material. Consult an installation professional for proper wall mounting.

**Required specifications**

- Top finish
- Top thickness/edge detail
- Base finish
- Handles

**Optional specifications**

- Key #
- Glazed doors

OVERHEAD STORAGE - 33"H

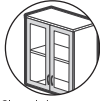
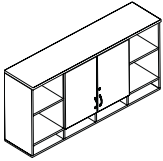

Glazed door option

**Overhead Storage, 2 Center Doors with Pigeon Hole - 32.5"/33"H**

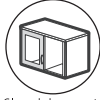
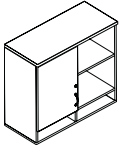

Glazed door option

**Overhead Storage, 1 Door - LEFT with Pigeon Hole - 32.5"/33"H**

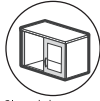
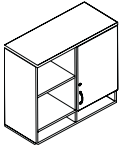

Glazed door option

**Overhead Storage, 1 Door - RIGHT with Pigeon Hole - 32.5"/33"H**

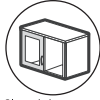
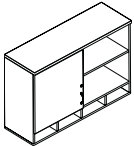

Glazed door option

**Overhead Storage, 1 Door - LEFT with Pigeon Hole - 32.5"/33"H**

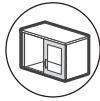
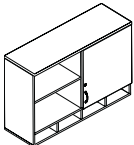

Glazed door option

**Overhead Storage, 1 Door - RIGHT with Pigeon Hole - 32.5"/33"H**

MODEL #	DIMENSIONS W x D x H (1.5" TOP)	WT/LB.	CUBIC FT.	1" TOP	1.5" TOP	GLAZE ADD	HP ADD
Z72S330SO	72 x 16 x 33	214	26	<b>\$2357</b>	<b>\$2470</b>	<b>\$777</b>	N/A
Z66S330SO	66 x 16 x 33	200	24	<b>\$2255</b>	<b>\$2361</b>	<b>\$762</b>	N/A
Z60S330SO	60 x 16 x 33	186	22	<b>\$2114</b>	<b>\$2211</b>	<b>\$691</b>	N/A
Z54S330SO	54 x 16 x 33	172	21	<b>\$2000</b>	<b>\$2090</b>	<b>\$675</b>	N/A

**Doors on upper inner compartments only.** Includes steel hanging rail for wall mount applications. Includes one fixed shelf. Doors lock. Shipped easy to assemble in 1 carton.

• **NOTE:** Care should be taken to mount the units. Units should be mounted to wall studs using correct fasteners. Failure to do so may result in collapse of the unit and subsequent personal injury. **Fastening hardware not included.** Mounting hardware used should be based on wall material. Consult an installation professional for proper wall mounting.

Z36S330SL	36 x 16 x 33	119	14	<b>\$1327</b>	<b>\$1406</b>	<b>\$386</b>	N/A
Z30S330SL	30 x 16 x 33	104	11.75	<b>\$1208</b>	<b>\$1271</b>	<b>\$344</b>	N/A
Z24S330SL	24 x 16 x 33	88	9.75	<b>\$1084</b>	<b>\$1143</b>	<b>\$300</b>	N/A

Includes steel hanging rail for wall mount applications. Includes one fixed shelf. Closed on **left**, open shelf on **right**. Door locks. Shipped easy to assemble in 1 carton.

• **NOTE:** Care should be taken to mount the units. Units should be mounted to wall studs using correct fasteners. Failure to do so may result in collapse of the unit and subsequent personal injury. **Fastening hardware not included.** Mounting hardware used should be based on wall material. Consult an installation professional for proper wall mounting.

Z36S330SR	36 x 16 x 33	119	14	<b>\$1327</b>	<b>\$1406</b>	<b>\$386</b>	N/A
Z30S330SR	30 x 16 x 33	104	11.75	<b>\$1208</b>	<b>\$1271</b>	<b>\$344</b>	N/A
Z24S330SR	24 x 16 x 33	88	9.75	<b>\$1084</b>	<b>\$1143</b>	<b>\$300</b>	N/A

Includes steel hanging rail for wall mount applications. Includes one fixed shelf. Closed on **right**, open shelf on **left**. Door locks. Shipped easy to assemble in 1 carton.

• **NOTE:** Care should be taken to mount the units. Units should be mounted to wall studs using correct fasteners. Failure to do so may result in collapse of the unit and subsequent personal injury. **Fastening hardware not included.** Mounting hardware used should be based on wall material. Consult an installation professional for proper wall mounting.

Z48S330SL	48 x 16 x 33	150	17.7	<b>\$1717</b>	<b>\$1807</b>	<b>\$436</b>	N/A
Z42S330SL	42 x 16 x 33	135	16.25	<b>\$1525</b>	<b>\$1612</b>	<b>\$425</b>	N/A

Includes steel hanging rail for wall mount applications. Includes one fixed shelf. Closed on **left**, open shelf on **right**. Door locks. Shipped easy to assemble in 1 carton.

• **NOTE:** Care should be taken to mount the units. Units should be mounted to wall studs using correct fasteners. Failure to do so may result in collapse of the unit and subsequent personal injury. **Fastening hardware not included.** Mounting hardware used should be based on wall material. Consult an installation professional for proper wall mounting.

Z48S330SR	48 x 16 x 33	150	17.7	<b>\$1717</b>	<b>\$1807</b>	<b>\$436</b>	N/A
Z42S330SR	42 x 16 x 33	135	16.25	<b>\$1525</b>	<b>\$1612</b>	<b>\$425</b>	N/A

Includes steel hanging rail for wall mount applications. Includes one fixed shelf. Closed on **right**, open shelf on **left**. Door locks. Shipped easy to assemble in 1 carton.

• **NOTE:** Care should be taken to mount the units. Units should be mounted to wall studs using correct fasteners. Failure to do so may result in collapse of the unit and subsequent personal injury. **Fastening hardware not included.** Mounting hardware used should be based on wall material. Consult an installation professional for proper wall mounting.

**Required specifications**

Top finish  
Top thickness/edge detail  
Base finish  
Handles

**Optional specifications**

Key #  
Glazed doors



**OVERHEAD STORAGE - 33"H**      **MODEL #**      **DIMENSIONS**      **WT/LB.**      **CUBIC FT.**      **1" TOP**      **1.5" TOP**      **GLAZE ADD**      **HP ADD**

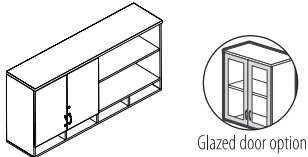

**Overhead Storage, 2 Doors - LEFT with Pigeon Hole - 32.5"/33"H\***

**W x D x H (1.5" TOP)**

Z72S330SL	72 x 16 x 33	207	26	<b>\$2308</b>	<b>\$2422</b>	<b>\$777</b>	N/A
Z66S330SL	66 x 16 x 33	193	24	<b>\$2202</b>	<b>\$2308</b>	<b>\$762</b>	N/A
Z60S330SL	60 x 16 x 33	179	22	<b>\$2041</b>	<b>\$2137</b>	<b>\$691</b>	N/A
Z54S330SL	54 x 16 x 33	166	21	<b>\$1928</b>	<b>\$2018</b>	<b>\$675</b>	N/A

Includes steel hanging rail for wall mount applications. Includes one fixed shelf. Closed on **left**, open shelves on **right**. Doors lock. Shipped easy to assemble in 1 carton.

• **NOTE:** Care should be taken to mount the units. Units should be mounted to wall studs using correct fasteners. Failure to do so may result in collapse of the unit and subsequent personal injury. **Fastening hardware not included.** Mounting hardware used should be based on wall material. Consult an installation professional for proper wall mounting.

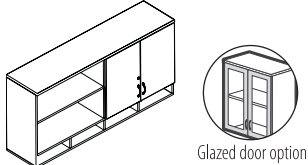

**Overhead Storage, 2 Doors - RIGHT with Pigeon Hole - 32.5"/33"H\***

Z72S330SR	72 x 16 x 33	207	26	<b>\$2308</b>	<b>\$2422</b>	<b>\$777</b>	N/A
Z66S330SR	66 x 16 x 33	193	24	<b>\$2202</b>	<b>\$2308</b>	<b>\$762</b>	N/A
Z60S330SR	60 x 16 x 33	179	22	<b>\$2041</b>	<b>\$2137</b>	<b>\$691</b>	N/A
Z54S330SR	54 x 16 x 33	166	21	<b>\$1928</b>	<b>\$2018</b>	<b>\$675</b>	N/A

Includes steel hanging rail for wall mount applications. Includes one fixed shelf. Closed on **right**, open shelves on **left**. Doors lock. Shipped easy to assemble in 1 carton.

• **NOTE:** Care should be taken to mount the units. Units should be mounted to wall studs using correct fasteners. Failure to do so may result in collapse of the unit and subsequent personal injury. **Fastening hardware not included.** Mounting hardware used should be based on wall material. Consult an installation professional for proper wall mounting.

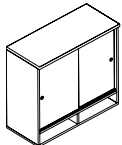

**Overhead Storage, Sliding Glass Doors with Pigeon Hole - 32.5"/33"H**

Z36S330SD	36 x 16 x 33	127	15.4	<b>\$2815</b>	<b>\$2894</b>	N/A	N/A
Z30S330SD	30 x 16 x 33	110	13.2	<b>\$2477</b>	<b>\$2540</b>	N/A	N/A
Z24S330SD	24 x 16 x 33	91	10.8	<b>\$2196</b>	<b>\$2255</b>	N/A	N/A

Includes steel hanging rail for wall mount applications. Includes one fixed shelf. Sliding glass doors do not lock. Shipped easy to assemble in 2 cartons (glass doors shipped separately).

• **NOTE:** Care should be taken to mount the units. Units should be mounted to wall studs using correct fasteners. Failure to do so may result in collapse of the unit and subsequent personal injury. **Fastening hardware not included.** Mounting hardware used should be based on wall material. Consult an installation professional for proper wall mounting.

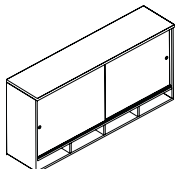

**Overhead Storage, Sliding Glass Doors with Pigeon Hole - 32.5"/33"H**

Z72S330SD	72 x 16 x 33	224	28.5	<b>\$4965</b>	<b>\$5079</b>	N/A	N/A
Z66S330SD	66 x 16 x 33	208	26.3	<b>\$4642</b>	<b>\$4749</b>	N/A	N/A
Z60S330SD	60 x 16 x 33	193	24.1	<b>\$4296</b>	<b>\$4393</b>	N/A	N/A
Z54S330SD	54 x 16 x 33	178	22.9	<b>\$4002</b>	<b>\$4092</b>	N/A	N/A
Z48S330SD	48 x 16 x 33	162	19.5	<b>\$3654</b>	<b>\$3744</b>	N/A	N/A
Z42S330SD	42 x 16 x 33	145	17.9	<b>\$3266</b>	<b>\$3353</b>	N/A	N/A

Includes steel hanging rail for wall mount applications. Includes one fixed shelf. Sliding glass doors do not lock. Shipped easy to assemble in 2 cartons (glass doors shipped separately).

• **NOTE:** Care should be taken to mount the units. Units should be mounted to wall studs using correct fasteners. Failure to do so may result in collapse of the unit and subsequent personal injury. **Fastening hardware not included.** Mounting hardware used should be based on wall material. Consult an installation professional for proper wall mounting.

**Required specifications**

- Top finish
- Top thickness/edge detail
- Base finish
- Handles\*

**Optional specifications**

- Key #\*
- Glazed doors\*

OVERHEAD STORAGE - 20" H

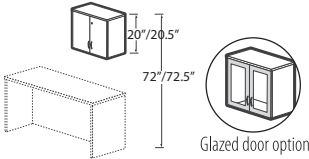

**Closed Front Overhead Storage with Doors - 20.5"/21" High\***

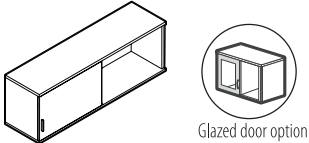

**Overhead Storage w/1 door - LEFT\* 20"/20.5"H**

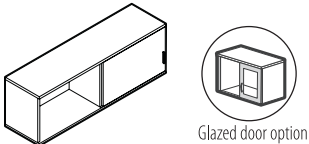

**Overhead Storage w/1 door - RIGHT\* 20"/20.5"H\***

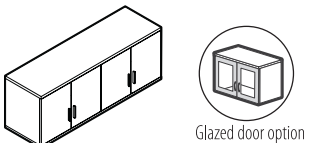

**Closed Front Overhead Storage w/Center Divider- 20"/20.5"H\***

MODEL #	DIMENSIONS	WT/LB.	CUBIC FT.	1" TOP	1.5" TOP	GLAZE ADD	HP ADD
---------	------------	--------	-----------	--------	----------	-----------	--------

	W x D x H (1.5" TOP)						
Z42S200S	42 x 16 x 20.5	94	10.5	<b>\$767</b>	<b>\$835</b>	<b>\$751</b>	N/A
Z36S200S	36 x 16 x 20.5	83	9	<b>\$702</b>	<b>\$763</b>	<b>\$686</b>	N/A
Z30S200S	30 x 16 x 20.5	72	7.5	<b>\$633</b>	<b>\$669</b>	<b>\$607</b>	N/A
Z24S200S	24 x 16 x 20.5	56	6.25	<b>\$595</b>	<b>\$637</b>	<b>\$545</b>	N/A

Includes steel hanging rail for wall mount applications. Doors lock. Shipped easy to assemble in 1 carton.

• **NOTE:** Care should be taken to mount the units. Units should be mounted to wall studs using correct fasteners. Failure to do so may result in collapse of the unit and subsequent personal injury. **Fastening hardware not included.** Mounting hardware used should be based on wall material. Consult an installation professional for proper wall mounting.

Z48S200SL	48 x 16 x 20.5	95	12.5	<b>\$1041</b>	<b>\$1132</b>	<b>\$373</b>	N/A
Z42S200SL	42 x 16 x 20.5	85	10.5	<b>\$923</b>	<b>\$1010</b>	<b>\$344</b>	N/A
Z36S200SL	36 x 16 x 20.5	76	9	<b>\$845</b>	<b>\$923</b>	<b>\$315</b>	N/A
Z30S200SL	30 x 16 x 20.5	67	7.6	<b>\$773</b>	<b>\$837</b>	<b>\$268</b>	N/A
Z24S200SL	24 x 16 x 20.5	58	6.5	<b>\$716</b>	<b>\$774</b>	<b>\$249</b>	N/A

Hinged door on **left**, open on **right**. Includes steel hanging rail for wall mount applications. Door locks. Shipped easy to assemble in 1 carton.

• **NOTE:** Care should be taken to mount the units. Units should be mounted to wall studs using correct fasteners. Failure to do so may result in collapse of the unit and subsequent personal injury. **Fastening hardware not included.** Mounting hardware used should be based on wall material. Consult an installation professional for proper wall mounting.

Z48S200SR	48 x 16 x 20.5	95	12.5	<b>\$1041</b>	<b>\$1132</b>	<b>\$373</b>	N/A
Z42S200SR	42 x 16 x 20.5	85	10.5	<b>\$923</b>	<b>\$1010</b>	<b>\$344</b>	N/A
Z36S200SR	36 x 16 x 20.5	76	9	<b>\$845</b>	<b>\$923</b>	<b>\$315</b>	N/A
Z30S200SR	30 x 16 x 20.5	67	7.6	<b>\$773</b>	<b>\$837</b>	<b>\$268</b>	N/A
Z24S200SR	24 x 16 x 20.5	58	6.5	<b>\$716</b>	<b>\$774</b>	<b>\$249</b>	N/A

Hinged door on **right**, open on **left**. Includes steel hanging rail for wall mount applications. Door locks. Shipped easy to assemble in 1 carton.

• **NOTE:** Care should be taken to mount the units. Units should be mounted to wall studs using correct fasteners. Failure to do so may result in collapse of the unit and subsequent personal injury. **Fastening hardware not included.** Mounting hardware used should be based on wall material. Consult an installation professional for proper wall mounting.

Z72S200S	72 x 16 x 20.5	149	18	<b>\$1758</b>	<b>\$1872</b>	<b>\$1254</b>	N/A
Z66S200S	66 x 16 x 20.5	139	16.5	<b>\$1676</b>	<b>\$1782</b>	<b>\$1225</b>	N/A
Z60S200S	60 x 16 x 20.5	129	15	<b>\$1547</b>	<b>\$1644</b>	<b>\$1123</b>	N/A
Z54S200S	54 x 16 x 20.5	119	13.75	<b>\$1472</b>	<b>\$1563</b>	<b>\$1095</b>	N/A

Includes steel hanging rail for wall mount applications. Doors lock. Shipped easy to assemble in 1 carton.

• **NOTE:** Care should be taken to mount the units. Units should be mounted to wall studs using correct fasteners. Failure to do so may result in collapse of the unit and subsequent personal injury. **Fastening hardware not included.** Mounting hardware used should be based on wall material. Consult an installation professional for proper wall mounting.

**Required specifications**

Top finish  
Top thickness/edge detail  
Base finish  
Handles

**Optional specifications**

Key #  
Glazed doors

OVERHEAD STORAGE - 20"H	MODEL #	DIMENSIONS	WT/LB.	CUBIC FT.	1" TOP	1.5" TOP	GLAZE ADD	HP ADD
-------------------------	---------	------------	--------	-----------	--------	----------	-----------	--------

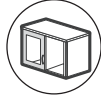
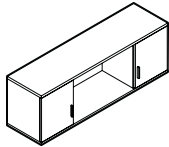

Glazed door option

**Overhead Storage w/2 Outer Doors  
20"/20.5"H\***

	W x D x H (1.5" TOP)							
Z72S20SOS	72 x 16 x 20.5	137	18	<b>\$1510</b>	<b>\$1623</b>	<b>\$631</b>	N/A	
Z66S20SOS	66 x 16 x 20.5	128	16.5	<b>\$1430</b>	<b>\$1537</b>	<b>\$616</b>	N/A	
Z60S20SOS	60 x 16 x 20.5	120	15	<b>\$1345</b>	<b>\$1441</b>	<b>\$603</b>	N/A	
Z54S20SOS	54 x 16 x 20.5	110	13.75	<b>\$1253</b>	<b>\$1343</b>	<b>\$550</b>	N/A	

**Doors on outer compartments only.** Includes steel hanging rail for wall mount applications. Doors lock. Shipped easy to assemble in 1 carton.

• **NOTE:** Care should be taken to mount the units. Units should be mounted to wall studs using correct fasteners. Failure to do so may result in collapse of the unit and subsequent personal injury. **Fastening hardware not included.** Mounting hardware used should be based on wall material. Consult an installation professional for proper wall mounting.

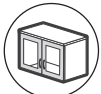
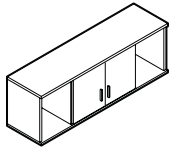

Glazed door option

**Overhead Storage w/2 Inner Doors  
20"/20.5"H\***

Z72S20OSO	72 x 16 x 20.5	137	18	<b>\$1529</b>	<b>\$1642</b>	<b>\$628</b>	N/A	
Z66S20OSO	66 x 16 x 20.5	128	16.5	<b>\$1449</b>	<b>\$1556</b>	<b>\$613</b>	N/A	
Z60S20OSO	60 x 16 x 20.5	120	15	<b>\$1364</b>	<b>\$1460</b>	<b>\$561</b>	N/A	
Z54S20OSO	54 x 16 x 20.5	110	13.75	<b>\$1272</b>	<b>\$1362</b>	<b>\$547</b>	N/A	

**Doors on inner compartments only.** Includes steel hanging rail for wall mount applications. Doors lock. Shipped easy to assemble in 1 carton.

• **NOTE:** Care should be taken to mount the units. Units should be mounted to wall studs using correct fasteners. Failure to do so may result in collapse of the unit and subsequent personal injury. **Fastening hardware not included.** Mounting hardware used should be based on wall material. Consult an installation professional for proper wall mounting.

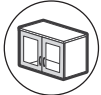
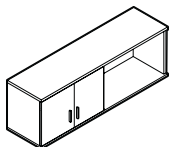

Glazed door option

**Overhead Storage w/2 Doors - LEFT  
20"/20.5"H\***

Z72S20OSL	72 x 16 x 20.5	132	18	<b>\$1463</b>	<b>\$1577</b>	<b>\$628</b>	N/A	
Z66S20OSL	66 x 16 x 20.5	123	16.5	<b>\$1385</b>	<b>\$1491</b>	<b>\$613</b>	N/A	
Z60S20OSL	60 x 16 x 20.5	114	15	<b>\$1282</b>	<b>\$1378</b>	<b>\$561</b>	N/A	
Z54S20OSL	54 x 16 x 20.5	105	13.75	<b>\$1208</b>	<b>\$1298</b>	<b>\$550</b>	N/A	

2 hinged doors on **left**, open shelf on **right**. Includes steel hanging rail for wall mount applications. Doors lock. Shipped easy to assemble in 1 carton.

• **NOTE:** Care should be taken to mount the units. Units should be mounted to wall studs using correct fasteners. Failure to do so may result in collapse of the unit and subsequent personal injury. **Fastening hardware not included.** Mounting hardware used should be based on wall material. Consult an installation professional for proper wall mounting.

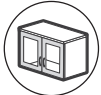
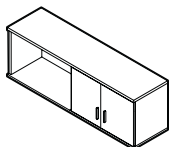

Glazed door option

**Overhead Storage w/2 Doors - RIGHT  
20"/20.5"H\***

Z72S20OSR	72 x 16 x 20.5	132	18	<b>\$1463</b>	<b>\$1577</b>	<b>\$628</b>	N/A	
Z66S20OSR	66 x 16 x 20.5	123	16.5	<b>\$1385</b>	<b>\$1491</b>	<b>\$613</b>	N/A	
Z60S20OSR	60 x 16 x 20.5	114	15	<b>\$1282</b>	<b>\$1378</b>	<b>\$561</b>	N/A	
Z54S20OSR	54 x 16 x 20.5	105	13.75	<b>\$1208</b>	<b>\$1298</b>	<b>\$550</b>	N/A	

2 hinged doors on **right**, open shelf on **left**. Includes steel hanging rail for wall mount applications. Doors lock. Shipped easy to assemble in 1 carton.

• **NOTE:** Care should be taken to mount the units. Units should be mounted to wall studs using correct fasteners. Failure to do so may result in collapse of the unit and subsequent personal injury. **Fastening hardware not included.** Mounting hardware used should be based on wall material. Consult an installation professional for proper wall mounting.

**Required specifications**

- Top finish
- Top thickness/edge detail
- Base finish
- Handles\*

**Optional specifications**

- Key #\*
- Glazed doors\*

OVERHEAD STORAGE - 20"H

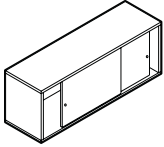

Overhead Storage, w/Sliding Glass Doors 20"/20.5"H

MODEL #	DIMENSIONS W x D x H (1.5" TOP)	WT/LB.	CUBIC FT.	1" TOP	1.5" TOP	GLAZE ADD	HP ADD
Z72S200SD	72 x 16 x 20.5	145	19.9	<b>\$3711</b>	<b>\$3824</b>	N/A	N/A
Z66S200SD	66 x 16 x 20.5	135	18.2	<b>\$3456</b>	<b>\$3563</b>	N/A	N/A
Z60S200SD	60 x 16 x 20.5	125	16.6	<b>\$3187</b>	<b>\$3283</b>	N/A	N/A
Z54S200SD	54 x 16 x 20.5	115	15.2	<b>\$3050</b>	<b>\$3141</b>	N/A	N/A
Z48S200SD	48 x 16 x 20.5	104	13.8	<b>\$2696</b>	<b>\$2786</b>	N/A	N/A
Z42S200SD	42 x 16 x 20.5	93	11.7	<b>\$2409</b>	<b>\$2496</b>	N/A	N/A
Z36S200SD	36 x 16 x 20.5	83	10	<b>\$2129</b>	<b>\$2207</b>	N/A	N/A
Z30S200SD	30 x 16 x 20.5	75	8.5	<b>\$1905</b>	<b>\$1969</b>	N/A	N/A
Z24S200SD	24 x 16 x 20.5	63	7.1	<b>\$1766</b>	<b>\$1824</b>	N/A	N/A

Includes steel hanging rail for wall mount applications. Sliding glass doors do not lock. Shipped easy to assemble in 2 cartons (glass doors shipped separately).

- **NOTE:** Care should be taken to mount the units. Units should be mounted to wall studs using correct fasteners. Failure to do so may result in collapse of the unit and subsequent personal injury. **Fastening hardware not included.** Mounting hardware used should be based on wall material. Consult an installation professional for proper wall mounting.

OVERHEAD STORAGE - 16"H

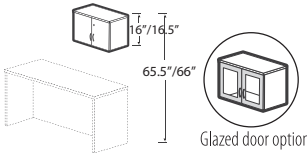

Closed Front Overhead Storage with Doors - 16"/16.5" High\*

Z48S160S	48 x 15 x 16.5	99	9.25	<b>\$766</b>	<b>\$829</b>	<b>\$722</b>	N/A
Z42S160S	42 x 15 x 16.5	87	7.75	<b>\$661</b>	<b>\$718</b>	<b>\$700</b>	N/A
Z36S160S	36 x 15 x 16.5	77	6.75	<b>\$603</b>	<b>\$653</b>	<b>\$633</b>	N/A
Z30S160S	30 x 15 x 16.5	64	5.75	<b>\$551</b>	<b>\$593</b>	<b>\$552</b>	N/A

Includes French cleat style wooden blocks for wall mounting applications. Doors lock. Shipped easy to assemble in 1 carton.

- **NOTE:** Care should be taken to mount the units. Units should be mounted to wall studs using correct fasteners. Failure to do so may result in collapse of the unit and subsequent personal injury. **Fastening hardware not included.** Mounting hardware used should be based on wall material. Consult an installation professional for proper wall mounting.

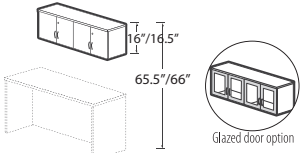

Closed Front Overhead Storage with Doors - 16"/16.5" High, 60" Wide\*

Z60S160S	60 x 15 x 16.5	118	11	<b>\$1005</b>	<b>\$1083</b>	<b>\$1103</b>	N/A
----------	----------------	-----	----	---------------	---------------	---------------	-----

Includes French cleat style wooden blocks for wall mounting applications. Doors lock. Shipped easy to assemble in 1 carton.

- **NOTE:** Care should be taken to mount the units. Units should be mounted to wall studs using correct fasteners. Failure to do so may result in collapse of the unit and subsequent personal injury. **Fastening hardware not included.** Mounting hardware used should be based on wall material. Consult an installation professional for proper wall mounting.

Required specifications

- Top finish
- Top thickness/edge detail
- Base finish
- Handles\*

Optional specifications

- Key #\*
- Glazed doors\*

**OVERHEAD STORAGE W/OPEN FRONTS - 33"H**      **MODEL #**      **DIMENSIONS**      **WT/LB.**      **CUBIC FT.**      **1" TOP**      **1.5" TOP**      **GLAZE ADD**      **HP ADD**

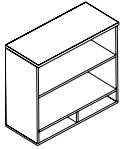

**Open Front Overhead Storage w/Pigeon Hole - 32.5"/33"H**

**W x D x H (1.5" TOP)**

Z42S330PN	42 x 16 x 33	116	16.25	<b>\$1257</b>	<b>\$1344</b>	N/A	N/A
Z36S330PN	36 x 16 x 33	101	14	<b>\$1070</b>	<b>\$1148</b>	N/A	N/A
Z30S330PN	30 x 16 x 33	88	12	<b>\$959</b>	<b>\$1023</b>	N/A	N/A
Z24S330PN	24 x 16 x 33	74	9.75	<b>\$858</b>	<b>\$917</b>	N/A	N/A

Includes steel hanging rail for wall mount applications. Includes one fixed shelf. Shipped easy to assemble in 1 carton.

- **NOTE:** Care should be taken to mount the units. Units should be mounted to wall studs using correct fasteners. Failure to do so may result in collapse of the unit and subsequent personal injury. **Fastening hardware not included.** Mounting hardware used should be based on wall material. Consult an installation professional for proper wall mounting.
- **42"W** unit has four pigeon hole compartments.

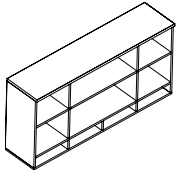

**Open Front Overhead Storage w/Pigeon Hole - 32.5"/33"H**

Z72S330N	72 x 16 x 33	194	26	<b>\$2081</b>	<b>\$2187</b>	N/A	N/A
Z66S330N	66 x 16 x 33	181	24	<b>\$1955</b>	<b>\$2051</b>	N/A	N/A
Z60S330N	60 x 16 x 33	169	22	<b>\$1812</b>	<b>\$1902</b>	N/A	N/A
Z54S330N	54 x 16 x 33	157	21	<b>\$1697</b>	<b>\$1787</b>	N/A	N/A

Six compartments and pigeon hole storage. Includes steel hanging rail for wall mount applications. Includes one fixed shelf. Shipped easy to assemble in 1 carton.

- **NOTE:** Care should be taken to mount the units. Units should be mounted to wall studs using correct fasteners. Failure to do so may result in collapse of the unit and subsequent personal injury. **Fastening hardware not included.** Mounting hardware used should be based on wall material. Consult an installation professional for proper wall mounting.

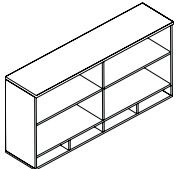

**Open Front Overhead Storage w/Pigeon Hole - 32.5"/33"H**

Z72S330SN	72 x 16 x 33	187	26	<b>\$1961</b>	<b>\$2068</b>	N/A	N/A
Z66S330SN	66 x 16 x 33	174	24	<b>\$1860</b>	<b>\$1957</b>	N/A	N/A
Z60S330SN	60 x 16 x 33	162	22	<b>\$1737</b>	<b>\$1827</b>	N/A	N/A
Z54S330SN	54 x 16 x 33	149	21	<b>\$1625</b>	<b>\$1715</b>	N/A	N/A

Four compartments and pigeon hole storage. Includes steel hanging rail for wall mount applications. Includes one fixed shelf. Shipped easy to assemble in 1 carton.

- **NOTE:** Care should be taken to mount the units. Units should be mounted to wall studs using correct fasteners. Failure to do so may result in collapse of the unit and subsequent personal injury. **Fastening hardware not included.** Mounting hardware used should be based on wall material. Consult an installation professional for proper wall mounting.

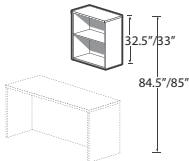

**Open Front Overhead Storage 33"/33.5" High**

Z42S330SN	42 x 16 x 33	109	16.25	<b>\$726</b>	<b>\$794</b>	N/A	N/A
Z36S330SN	36 x 16 x 33	97	14	<b>\$659</b>	<b>\$720</b>	N/A	N/A
Z30S330SN	30 x 16 x 33	84	11.75	<b>\$591</b>	<b>\$627</b>	N/A	N/A
Z24S330SN	24 x 16.2 x 33	67	9.75	<b>\$546</b>	<b>\$588</b>	N/A	N/A

Includes steel hanging rail for wall mount applications. Includes one fixed shelf. Shipped easy to assemble in 1 carton.

- **NOTE:** Care should be taken to mount the units. Units should be mounted to wall studs using correct fasteners. Failure to do so may result in collapse of the unit and subsequent personal injury. **Fastening hardware not included.** Mounting hardware used should be based on wall material. Consult an installation professional for proper wall mounting.

**Required specifications**

- Top finish
- Top thickness/edge detail
- Base finish

OVERHEAD STORAGE W/OPEN FRONTS - 20"H

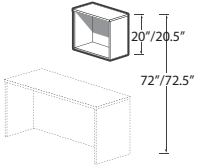

Open Front Overhead Storage  
20.5"/21" High

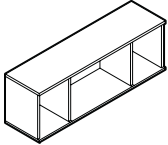

Open Front Overhead Storage  
20"/20.5"H

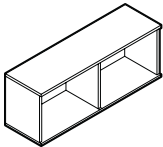

Open Front Overhead Storage  
w/Center Divider - 20"/20.5"H

MODEL # DIMENSIONS WT/LB. CUBIC FT. 1" TOP 1.5" TOP GLAZE ADD HP ADD

W x D x H (1.5" TOP)

Z42S200SN	42 x 16 x 20.5	78	10.5	\$507	\$575	N/A	N/A
Z36S200SN	36 x 16 x 20.5	70	9	\$458	\$519	N/A	N/A
Z30S200SN	30 x 16 x 20.5	60	7.5	\$410	\$446	N/A	N/A
Z24S200SN	24 x 16 x 20.5	48	6.25	\$374	\$416	N/A	N/A

Includes steel hanging rail for wall mount applications. Shipped easy to assemble in 1 carton.

• **NOTE:** Care should be taken to mount the units. Units should be mounted to wall studs using correct fasteners. Failure to do so may result in collapse of the unit and subsequent personal injury. **Fastening hardware not included.** Mounting hardware used should be based on wall material. Consult an installation professional for proper wall mounting.

Z72S200N	72 x 16 x 20.5	122	18	\$1220	\$1334	N/A	N/A
Z66S200N	66 x 16 x 20.5	114	16.5	\$1143	\$1249	N/A	N/A
Z60S200N	60 x 16 x 20.5	106	15	\$1064	\$1161	N/A	N/A
Z54S200N	54 x 16 x 20.5	99	13.75	\$992	\$1083	N/A	N/A

Four compartments. Includes steel hanging rail for wall mount applications. Shipped easy to assemble in 1 carton.

• **NOTE:** Care should be taken to mount the units. Units should be mounted to wall studs using correct fasteners. Failure to do so may result in collapse of the unit and subsequent personal injury. **Fastening hardware not included.** Mounting hardware used should be based on wall material. Consult an installation professional for proper wall mounting.

Z72S200SN	72 x 16 x 20.5	117	18	\$1177	\$1291	N/A	N/A
Z66S200SN	66 x 16 x 20.5	109	16.5	\$1098	\$1205	N/A	N/A
Z60S200SN	60 x 16 x 20.5	101	15	\$1020	\$1116	N/A	N/A
Z54S200SN	54 x 16 x 20.5	94	13.75	\$949	\$1039	N/A	N/A

Two compartments. Includes steel hanging rail for wall mount applications. Shipped easy to assemble in 1 carton.

• **NOTE:** Care should be taken to mount the units. Units should be mounted to wall studs using correct fasteners. Failure to do so may result in collapse of the unit and subsequent personal injury. **Fastening hardware not included.** Mounting hardware used should be based on wall material. Consult an installation professional for proper wall mounting.

OVERHEAD STORAGE W/OPEN FRONTS - 16"H

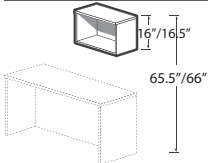

Open Front Overhead Storage  
16"/16.5" High

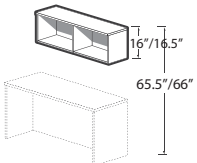

Open Front Overhead Storage  
16"/16.5" High, 60" Wide

Z48S160SN	48 x 15 x 16.5	80	9.25	\$507	\$570	N/A	N/A
Z42S160SN	42 x 15 x 16.5	70	7.75	\$442	\$499	N/A	N/A
Z36S160SN	36 x 15 x 16.5	63	6.75	\$404	\$454	N/A	N/A
Z30S160SN	30 x 15 x 16.5	54	5.75	\$372	\$414	N/A	N/A

Includes French cleat style wooden blocks for wall mounting applications. Shipped easy to assemble in 1 carton.

• **NOTE:** Care should be taken to mount the units. Units should be mounted to wall studs using correct fasteners. Failure to do so may result in collapse of the unit and subsequent personal injury. **Fastening hardware not included.** Mounting hardware used should be based on wall material. Consult an installation professional for proper wall mounting.

Z60S160SN	60 x 15 x 16.5	98	11	\$626	\$704	N/A	N/A
-----------	----------------	----	----	-------	-------	-----	-----

Includes French cleat style wooden blocks for wall mounting applications. Shipped easy to assemble in 1 carton.

• **NOTE:** Care should be taken to mount the units. Units should be mounted to wall studs using correct fasteners. Failure to do so may result in collapse of the unit and subsequent personal injury. **Fastening hardware not included.** Mounting hardware used should be based on wall material. Consult an installation professional for proper wall mounting.

Required specifications

Top finish  
Top thickness/edge detail  
Base finish

Optional specifications

HP laminate\*

Accessories

Tackboard (for hutches)

OPEN HUTCHES	MODEL #	DIMENSIONS	WT/LB.	CUBIC FT.	1" TOP	1.5" TOP	GLAZE ADD	HP ADD
		W x D x H (1.5 TOP)						
	Z84S23HN	84 x 15 x 23.5	129	23	<b>\$920</b>	<b>\$1028</b>	N/A	<b>\$344</b>
	Z72S23HN	72 x 15 x 23.5	114	19.75	<b>\$804</b>	<b>\$912</b>	N/A	<b>\$257</b>
	Z71S23HN	71.7 x 15 x 23.5	113	19.75	<b>\$804</b>	<b>\$895</b>	N/A	<b>\$257</b>
	Z66S23HN	66 x 15 x 23.5	106	18.25	<b>\$735</b>	<b>\$822</b>	N/A	<b>\$257</b>
	Z60S23HN	60 x 15 x 23.5	99	16.5	<b>\$651</b>	<b>\$729</b>	N/A	<b>\$215</b>
	Z48S23HN	48 x 15 x 23.5	84	13.5	<b>\$564</b>	<b>\$627</b>	N/A	<b>\$171</b>
	Z42S23HN	42 x 15 x 23.5	76	11.75	<b>\$523</b>	<b>\$580</b>	N/A	<b>\$171</b>
	Z36S23HN	36 x 15 x 23.5	68	10.25	<b>\$483</b>	<b>\$533</b>	N/A	<b>\$144</b>
	Z30S23HN	30 x 15 x 23.5	61	8.5	<b>\$449</b>	<b>\$497</b>	N/A	<b>\$114</b>

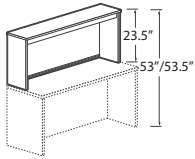

**Open Hutch with Closed Back  
23.5" High\***

Closed back features one grommet and flexible sweep for wire management. Shipped assembled in 1 carton.

- Hutch with 1" top clearance from work surface to valance is 20.5"; with 1.5" top clearance is 20".
- Woodgrain runs horizontal on both the upper and lower back panels.

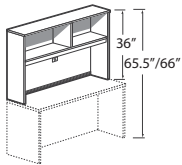

**Open Hutch with Closed Back  
36" High**

Z84S36HN	84 x 15 x 36	206	33	<b>\$1194</b>	<b>\$1302</b>	N/A	N/A
Z72S36HN	72 x 15 x 36	181	28.25	<b>\$1091</b>	<b>\$1182</b>	N/A	N/A
Z71S36HN	71.7 x 15 x 36	173	28.25	<b>\$1081</b>	<b>\$1172</b>	N/A	N/A
Z66S36HN	66 x 15 x 36	161	26	<b>\$1022</b>	<b>\$1109</b>	N/A	N/A
Z60S36HN	60 x 15 x 36	150	23.75	<b>\$955</b>	<b>\$1033</b>	N/A	N/A

One fixed shelf **and fixed shelf divider**. Closed back features one grommet and flexible sweep for wire management. Shipped assembled in 1 carton.

- Hutch with 1" top clearance from work surface to valance is 17.75"; with 1.5" top clearance is 17.25".
- Woodgrain runs horizontal on both the upper and lower back panels.

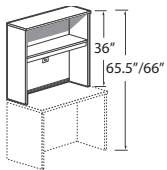

**Open Hutch with Closed Back  
36" High**

Z48S36HN	48 x 15 x 36	123	19	<b>\$788</b>	<b>\$851</b>	N/A	N/A
Z42S36HN	42 x 15 x 36	112	16.75	<b>\$727</b>	<b>\$784</b>	N/A	N/A
Z36S36HN	36 x 15 x 36	100	14.5	<b>\$669</b>	<b>\$719</b>	N/A	N/A
Z30S36HN	30 x 15 x 36	89	12.25	<b>\$606</b>	<b>\$648</b>	N/A	N/A

One fixed shelf. Closed back features one grommet and flexible sweep for wire management.

Shipped assembled in 1 carton.

- Hutch with 1" top clearance from work surface to valance is 17.75"; hutch with 1.5" top clearance is 17.25".
- Woodgrain runs horizontal on both the upper and lower back panels.

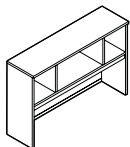

**Open Hutch with Closed Back  
36" High**

Z72S360HN	72 x 15 x 36	162	27.75	<b>\$1502</b>	<b>\$1622</b>	N/A	N/A
Z66S360HN	66 x 15 x 36	152	25.5	<b>\$1422</b>	<b>\$1532</b>	N/A	N/A
Z60S360HN	60 x 15 x 36	142	23.25	<b>\$1337</b>	<b>\$1436</b>	N/A	N/A
Z54S360HN	54 x 15 x 36	133	21	<b>\$1252</b>	<b>\$1343</b>	N/A	N/A

Four compartments. Closed back features one grommet and flexible sweep for wire management.

Shipped assembled in 1 carton.

- Hutch with 1" top clearance from work surface to valance is 17.75"; hutch with 1.5" top clearance is 17.25".
- Woodgrain runs horizontal on both the upper and lower back panels.

**Required specifications**

Top finish  
Top thickness/edge detail  
Base finish

**Optional specifications**

HP laminate\*

**Accessories**

Tackboard

OPEN HUTCHES

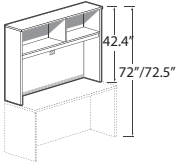

**Open Hutch with Closed Back  
42.4" High**

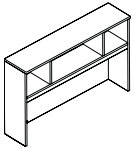

**Open Hutch w/Closed Back  
42.4" High**

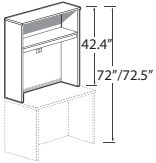

**Open Hutch with Closed Back  
42.4" High**

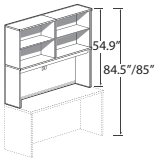

**Open Hutch with Closed Back  
54.9" High**

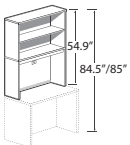

**Open Hutch with Closed Back  
54.9" High**

MODEL #	DIMENSIONS	WT/LB.	CUBIC FT.	1" TOP	1.5" TOP	GLAZE ADD	HP ADD
---------	------------	--------	-----------	--------	----------	-----------	--------

W x D x H (1.5 TOP)

Z84S42HN	84 x 15 x 42.4	223	38.5	<b>\$1273</b>	<b>\$1381</b>	N/A	N/A
Z72S42HN	72 x 15 x 42.4	196	33	<b>\$1175</b>	<b>\$1266</b>	N/A	N/A
Z71S42HN	71.7 x 15 x 42.4	188	33	<b>\$1166</b>	<b>\$1257</b>	N/A	N/A
Z66S42HN	66 x 15 x 42.4	175	30.75	<b>\$1100</b>	<b>\$1187</b>	N/A	N/A
Z60S42HN	60 x 15 x 42.4	164	27.75	<b>\$1030</b>	<b>\$1108</b>	N/A	N/A

One fixed shelf **and fixed shelf divider**. Closed back features one grommet and flexible sweep for wire management.

Shipped assembled in 1 carton.

- Hutch with 1" top clearance from work surface to valance is 24.25"; hutch with 1.5" top clearance is 23.75".
- Woodgrain runs horizontal on both the upper and lower back panels.

Z72S42OHN	72 x 15 x 42.4	177	32.5	<b>\$1676</b>	<b>\$1785</b>	N/A	N/A
Z66S42OHN	66 x 15 x 42.4	166	29.75	<b>\$1536</b>	<b>\$1635</b>	N/A	N/A
Z60S42OHN	60 x 15 x 42.4	155	27.25	<b>\$1444</b>	<b>\$1533</b>	N/A	N/A
Z54S42OHN	54 x 15 x 42.4	145	24.5	<b>\$1352</b>	<b>\$1433</b>	N/A	N/A

Four compartments. Closed back features one grommet and flexible sweep for wire management.

Shipped assembled in 1 carton.

- Hutch with 1" top clearance from work surface to valance is 24.25"; hutch with 1.5" top clearance is 23.75".
- Woodgrain runs horizontal on both the upper and lower back panels.

Z48S42HN	48 x 15 x 42.4	134	22.25	<b>\$851</b>	<b>\$914</b>	N/A	N/A
Z42S42HN	42 x 15 x 42.4	123	19.5	<b>\$788</b>	<b>\$845</b>	N/A	N/A
Z36S42HN	36 x 15 x 42.4	110	17	<b>\$721</b>	<b>\$771</b>	N/A	N/A
Z30S42HN	30 x 15 x 42.4	105	14.25	<b>\$653</b>	<b>\$695</b>	N/A	N/A

One fixed shelf. Closed back features one grommet and flexible sweep for wire management.

Shipped assembled in 1 carton.

- Hutch with 1" top clearance from work surface to valance is 24.25"; hutch with 1.5" top clearance is 23.75".
- Woodgrain runs horizontal on both the upper and lower back panels.

Z84S55HN	84 x 15 x 54.9	306	62.5	<b>\$2088</b>	<b>\$2200</b>	N/A	N/A
Z72S55HN	72 x 15 x 54.9	272	53.75	<b>\$1945</b>	<b>\$2042</b>	N/A	N/A
Z71S55HN	71.7 x 15 x 54.9	271	53.75	<b>\$1937</b>	<b>\$2034</b>	N/A	N/A
Z66S55HN	66 x 15 x 54.9	254	49.5	<b>\$1873</b>	<b>\$1967</b>	N/A	N/A
Z60S55HN	60 x 15 x 54.9	238	45.25	<b>\$1675</b>	<b>\$1759</b>	N/A	N/A

One fixed shelf and one adjustable shelf (per compartment). Closed back features one grommet and flexible sweep for wire management. Shipped easy to assemble in 3 cartons.

- Hutch with 1" top clearance from work surface to valance is 24.25"; with 1.5" top clearance is 23.75".
- Woodgrain runs horizontal on both the upper and lower back panels.

Z48S55HN	48 x 15 x 54.9	183	36	<b>\$1258</b>	<b>\$1321</b>	N/A	N/A
Z42S55HN	42 x 15 x 54.9	168	31.5	<b>\$1164</b>	<b>\$1221</b>	N/A	N/A
Z36S55HN	36 x 15 x 54.9	149	27.25	<b>\$1059</b>	<b>\$1109</b>	N/A	N/A
Z30S55HN	30 x 15 x 54.9	132	23	<b>\$963</b>	<b>\$1005</b>	N/A	N/A

One fixed shelf and one adjustable shelf. Closed back features one grommet and flexible sweep for wire management.

Shipped easy to assemble in 2 cartons.

- Hutch with 1" top clearance from work surface to valance is 24.25"; hutch with 1.5" top clearance is 23.75".
- Woodgrain runs horizontal on both the upper and lower back panels.

**Required specifications**

Top finish  
Top thickness/edge detail  
Base finish  
Handles\*

**Optional specifications**

Key #\*  
Glazed doors\*

**Accessories**

Tackboard  
Pigeon-hole storage



**OPEN HUTCHES**      **MODEL #**      **DIMENSIONS**      **WT/LB.**      **CUBIC FT.**      **1" TOP**      **1.5" TOP**      **GLAZE ADD**      **HP ADD**

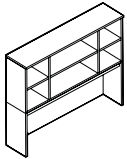

**Open Hutch w/Closed Back**  
**54.9"/55.4"H**

**W x D x H (1.5 TOP)**

Z72S550HN	72 x 15 x 54.9	242	26	<b>\$2471</b>	<b>\$2585</b>	N/A	N/A
Z66S550HN	66 x 15 x 54.9	228	24	<b>\$2328</b>	<b>\$2435</b>	N/A	N/A
Z60S550HN	60 x 15 x 54.9	214	22	<b>\$2190</b>	<b>\$2286</b>	N/A	N/A
Z54S550HN	54 x 15 x 54.9	199	19.75	<b>\$2055</b>	<b>\$2142</b>	N/A	N/A

Four compartments. Closed back features one grommet and flexible sweep for wire management. -

Shipped easy to assemble in 2 cartons

- Hutch with 1" top clearance from work surface to valance is 24.25"; hutch with 1.5" top clearance is 23.75".
- Woodgrain runs horizontal on both the upper and lower back panels.

**CLOSED HUTCHES**

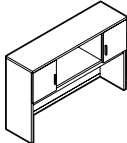

Glazed door option

**Hutch with 2 Outer Doors 36" High\***

Z72S36HOH	72 x 15 x 36	172	27.75	<b>\$1760</b>	<b>\$1880</b>	<b>\$548</b>	N/A
Z66S36HOH	66 x 15 x 36	161	25.5	<b>\$1680</b>	<b>\$1791</b>	<b>\$532</b>	N/A
Z60S36HOH	60 x 15 x 36	151	23.25	<b>\$1576</b>	<b>\$1676</b>	<b>\$491</b>	N/A
Z54S36HOH	54 x 15 x 36	140	21	<b>\$1488</b>	<b>\$1579</b>	<b>\$476</b>	N/A

Four compartments. **Doors on outer compartments only.** Closed back features one grommet and flexible sweep for wire management. Doors lock. Shipped assembled in 1 carton.

- Hutch with 1" top clearance from work surface to valance is 17.75"; hutch with 1.5" top clearance is 17.25".
- Woodgrain runs horizontal on both the upper and lower back panels.

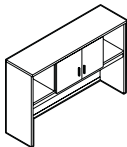

Glazed door option

**Hutch with 2 Inner Doors 36" High\***

Z72S36OHO	72 x 15 x 36	173	27.75	<b>\$1757</b>	<b>\$1884</b>	<b>\$553</b>	N/A
Z66S36OHO	66 x 15 x 36	162	25.5	<b>\$1683</b>	<b>\$1793</b>	<b>\$537</b>	N/A
Z60S36OHO	60 x 15 x 36	151	23.25	<b>\$1596</b>	<b>\$1695</b>	<b>\$518</b>	N/A
Z54S36OHO	54 x 15 x 36	141	21	<b>\$1492</b>	<b>\$1582</b>	<b>\$483</b>	N/A

Four compartments. **Doors on inner compartments only.** Closed back features one grommet and flexible sweep for wire management. Doors lock. Shipped assembled in 1 carton.

- Hutch with 1" top clearance from work surface to valance is 17.75"; hutch with 1.5" top clearance is 17.25".
- Woodgrain runs horizontal on both the upper and lower back panels.

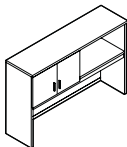

Glazed door option

**Hutch with 2 Doors 36" High - LEFT\***

Z72S36HSL	72 x 15 x 36	169	27.75	<b>\$1722</b>	<b>\$1842</b>	<b>\$547</b>	N/A
Z66S36HSL	66 x 15 x 36	157	25.5	<b>\$1641</b>	<b>\$1751</b>	<b>\$529</b>	N/A
Z60S36HSL	60 x 15 x 36	146	23.25	<b>\$1536</b>	<b>\$1636</b>	<b>\$492</b>	N/A
Z54S36HSL	54 x 15 x 36	135	21	<b>\$1449</b>	<b>\$1540</b>	<b>\$483</b>	N/A

Hinged doors on **left** side, open storage on **right**. Closed back features one grommet and flexible sweep for wire management. Doors lock. Shipped assembled in 1 carton.

- Hutch with 1" top clearance from work surface to valance is 17.75"; hutch with 1.5" top clearance is 17.25".
- Woodgrain runs horizontal on both the upper and lower back panels.

**Required specifications**

- Top finish
- Top thickness/edge detail
- Base finish
- Handles\*

**Optional specifications**

- Key #\*
- Glazed doors\*

**Accessories**

- Tackboard
- Pigeon-hole storage

CLOSED HUTCHES

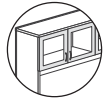
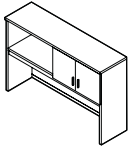

Glazed door option

Hutch with 2 Doors 36" High - RIGHT\*

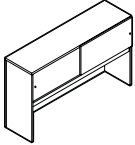

Hutch w/Sliding Glass Doors 36" High

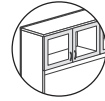
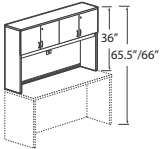

Glazed door option

Closed Hutch with Doors 36" High\*

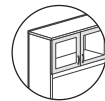
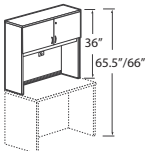

Glazed door option

Closed Hutch with Doors 36" High\*

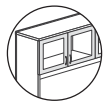
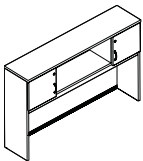

Glazed door option

Hutch with 2 Outer Doors 42.4" High\*

MODEL #	DIMENSIONS	WT/LB.	CUBIC FT.	1" TOP	1.5" TOP	GLAZE ADD	HP ADD
---------	------------	--------	-----------	--------	----------	-----------	--------

W x D x H (1.5" TOP)

Z72S36HSR	72 x 15 x 36	169	27.75	<b>\$1722</b>	<b>\$1842</b>	<b>\$547</b>	N/A
Z66S36HSR	66 x 15 x 36	157	25.5	<b>\$1641</b>	<b>\$1751</b>	<b>\$529</b>	N/A
Z60S36HSR	60 x 15 x 36	146	23.25	<b>\$1536</b>	<b>\$1636</b>	<b>\$492</b>	N/A
Z54S36HSR	54 x 15 x 36	135	21	<b>\$1449</b>	<b>\$1540</b>	<b>\$483</b>	N/A

Hinged doors on **right** side, open storage on **left**. Closed back features one grommet and flexible sweep for wire management. Doors lock. Shipped assembled in 1 carton.

- Hutch with 1" top clearance from work surface to valance is 17.75"; hutch with 1.5" top clearance is 17.25".
- Woodgrain runs horizontal on both the upper and lower back panels.

Z72S36HSD	72 x 15 x 36	178	29.3	<b>\$3759</b>	<b>\$3880</b>	N/A	N/A
Z66S36HSD	66 x 15 x 36	166	26.9	<b>\$3510</b>	<b>\$3620</b>	N/A	N/A
Z60S36HSD	60 x 15 x 36	154	24.5	<b>\$3256</b>	<b>\$3356</b>	N/A	N/A
Z54S36HSD	54 x 15 x 36	143	22.1	<b>\$3011</b>	<b>\$3111</b>	N/A	N/A

Sliding glass doors do not lock. Closed back features one grommet and flexible sweep for wire management. Shipped assembled in 2 cartons (glass doors shipped separately).

- Hutch with 1" top clearance from work surface to valance is 17.75"; hutch with 1.5" top clearance is 17.25".
- Woodgrain runs horizontal on both the upper and lower back panels.

Z84S36H	84 x 15 x 36	231	33	<b>\$1639</b>	<b>\$1747</b>	<b>\$1322</b>	N/A
Z72S36H	72 x 15 x 36	201	28.25	<b>\$1522</b>	<b>\$1613</b>	<b>\$1207</b>	N/A
Z71S36H	71.7 x 15 x 36	193	28.25	<b>\$1511</b>	<b>\$1602</b>	<b>\$1205</b>	N/A
Z66S36H	66 x 15 x 36	179	26	<b>\$1436</b>	<b>\$1523</b>	<b>\$1146</b>	N/A
Z60S36H	60 x 15 x 36	167	23.75	<b>\$1337</b>	<b>\$1415</b>	<b>\$1077</b>	N/A

One fixed shelf **and fixed shelf divider**. Closed back features one grommet and flexible sweep for wire management. Doors lock. Shipped assembled in 1 carton.

- Hutch with 1" top clearance from work surface to valance is 17.75"; with 1.5" top clearance is 17.25".
- Woodgrain runs horizontal on both the upper and lower back panels.

Z48S36H	48 x 15 x 36	136	19	<b>\$1048</b>	<b>\$1111</b>	<b>\$686</b>	N/A
Z42S36H	42 x 15 x 36	124	16.75	<b>\$952</b>	<b>\$1009</b>	<b>\$661</b>	N/A
Z36S36H	36 x 15 x 36	110	14.5	<b>\$870</b>	<b>\$920</b>	<b>\$605</b>	N/A
Z30S36H	30 x 15 x 36	98	12.25	<b>\$793</b>	<b>\$835</b>	<b>\$542</b>	N/A

One fixed shelf. Closed back features one grommet and flexible sweep for wire management. Doors lock. Shipped assembled in 1 carton.

- Hutch with 1" top clearance from work surface to valance is 17.75"; with 1.5" top clearance is 17.25".
- Woodgrain runs horizontal on both the upper and lower back panels.

Z72S42HOH	72 x 15 x 42.4	187	32.5	<b>\$1937</b>	<b>\$2046</b>	<b>\$548</b>	N/A
Z66S42HOH	66 x 15 x 42.4	176	29.75	<b>\$1792</b>	<b>\$1892</b>	<b>\$532</b>	N/A
Z60S42HOH	60 x 15 x 42.4	164	27.25	<b>\$1681</b>	<b>\$1772</b>	<b>\$491</b>	N/A
Z54S42HOH	54 x 15 x 42.4	153	24.5	<b>\$1588</b>	<b>\$1669</b>	<b>\$476</b>	N/A

Four compartments. **Doors on outer compartments only**. Closed back features one grommet and flexible sweep for wire management. Doors lock. Shipped assembled in 1 carton.

- Hutch with 1" top clearance from work surface to valance is 24.25"; hutch with 1.5" top clearance is 23.75".
- Woodgrain runs horizontal on both the upper and lower back panels.

Required specifications

Top finish  
Top thickness/edge detail  
Base finish  
Handles\*

Optional specifications

Key #\*  
Glazed doors\*

Accessories

Tackboard  
Pigeon-hole storage

CLOSED HUTCHES

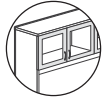
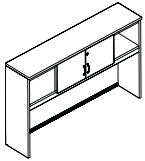

Glazed door option

Hutch with 2 Inner Doors 42.4" High\*

MODEL #	DIMENSIONS W x D x H (1.5" TOP)	WT/LB.	CUBIC FT.	1" TOP	1.5" TOP	GLAZE ADD	HP ADD
Z72S42OHO	72 x 15 x 42.4	188	32.5	<b>\$1939</b>	<b>\$2049</b>	<b>\$553</b>	N/A
Z66S42OHO	66 x 15 x 42.4	176	29.75	<b>\$1796</b>	<b>\$1895</b>	<b>\$537</b>	N/A
Z60S42OHO	60 x 15 x 42.4	165	27.25	<b>\$1704</b>	<b>\$1793</b>	<b>\$518</b>	N/A
Z54S42OHO	54 x 15 x 42.4	153	24.5	<b>\$1592</b>	<b>\$1673</b>	<b>\$483</b>	N/A

Four compartments. **Doors on inner compartments only.** Closed back features one grommet and flexible sweep for wire management. Doors lock. Shipped assembled in 1 carton.

- Hutch with 1" top clearance from work surface to valance is 24.25"; hutch with 1.5" top clearance is 23.75".
- Woodgrain runs horizontal on both the upper and lower back panels.

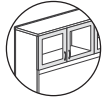
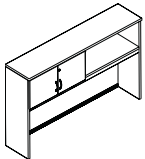

Glazed door option

Hutch with 2 Doors 42.4" High - LEFT\*

Z72S42HSL	72 x 15 x 42.4	184	32.5	<b>\$1896</b>	<b>\$2005</b>	<b>\$547</b>	N/A
Z66S42HSL	66 x 15 x 42.4	171	29.75	<b>\$1750</b>	<b>\$1850</b>	<b>\$529</b>	N/A
Z60S42HSL	60 x 15 x 42.4	159	27.25	<b>\$1642</b>	<b>\$1731</b>	<b>\$492</b>	N/A
Z54S42HSL	54 x 15 x 42.4	148	24.5	<b>\$1549</b>	<b>\$1630</b>	<b>\$483</b>	N/A

Hinged doors on **left** side, open storage on **right**. Closed back features one grommet and flexible sweep for wire management. Doors lock. Shipped assembled in 1 carton.

- Hutch with 1" top clearance from work surface to valance is 24.25"; hutch with 1.5" top clearance is 23.75".
- Woodgrain runs horizontal on both the upper and lower back panels.

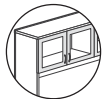
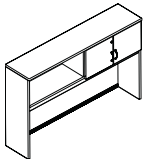

Glazed door option

Hutch with 2 Doors 42.4" High - RIGHT\*

Z72S42HSR	72 x 15 x 42.4	184	32.5	<b>\$1896</b>	<b>\$2005</b>	<b>\$547</b>	N/A
Z66S42HSR	66 x 15 x 42.4	171	29.75	<b>\$1750</b>	<b>\$1850</b>	<b>\$529</b>	N/A
Z60S42HSR	60 x 15 x 42.4	159	27.25	<b>\$1642</b>	<b>\$1731</b>	<b>\$492</b>	N/A
Z54S42HSR	54 x 15 x 42.4	148	24.5	<b>\$1549</b>	<b>\$1630</b>	<b>\$483</b>	N/A

Hinged doors on **right** side, open storage on **left**. Closed back features one grommet and flexible sweep for wire management. Doors lock. Shipped assembled in 1 carton.

- Hutch with 1" top clearance from work surface to valance is 24.25"; hutch with 1.5" top clearance is 23.75".
- Woodgrain runs horizontal on both the upper and lower back panels.

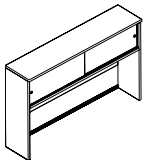

Hutch w/Sliding Glass Doors 42.4" High

Z72S42HSD	72 x 15 x 42.4	193	34	<b>\$3926</b>	<b>\$4036</b>	N/A	N/A
Z66S42HSD	66 x 15 x 42.4	180	31.2	<b>\$3620</b>	<b>\$3719</b>	N/A	N/A
Z60S42HSD	60 x 15 x 42.4	168	24.5	<b>\$3359</b>	<b>\$3449</b>	N/A	N/A
Z54S42HSD	54 x 15 x 42.4	156	25.6	<b>\$3111</b>	<b>\$3192</b>	N/A	N/A

Sliding glass doors do not lock. Closed back features one grommet and flexible sweep for wire management. Shipped assembled in 2 cartons (glass doors shipped separately).

- Hutch with 1" top clearance from work surface to valance is 24.25"; hutch with 1.5" top clearance is 23.75".
- Woodgrain runs horizontal on both the upper and lower back panels.

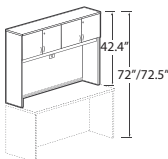

Glazed door option

Closed Hutch with Doors 42.4" High

Z84S42H	84 x 15 x 42.4	247	38.5	<b>\$1818</b>	<b>\$1926</b>	<b>\$1322</b>	N/A
Z72S42H	72 x 15 x 42.4	217	33	<b>\$1609</b>	<b>\$1700</b>	<b>\$1207</b>	N/A
Z71S42H	71.7 x 15 x 42.4	207	33	<b>\$1599</b>	<b>\$1690</b>	<b>\$1205</b>	N/A
Z66S42H	66 x 15 x 42.4	194	30.75	<b>\$1514</b>	<b>\$1601</b>	<b>\$1146</b>	N/A
Z60S42H	60 x 15 x 42.4	180	27.75	<b>\$1412</b>	<b>\$1490</b>	<b>\$1077</b>	N/A

One fixed shelf **and fixed shelf divider**. Closed back features one grommet and flexible sweep for wire management. Doors lock. Shipped assembled in 1 carton.

- Hutch with 1" top clearance from work surface to valance is 24.25"; with 1.5" top clearance is 23.75".
- Woodgrain runs horizontal on both the upper and lower back panels.

**Required specifications**

Top finish  
Top thickness/edge detail  
Base finish  
Handles\*

**Optional specifications**

Key #\*  
Glazed doors\*

**Accessories**

Tackboard  
Pigeon-hole storage

CLOSED HUTCHES

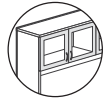
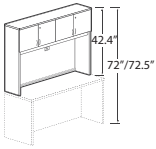

Glazed door option

**Closed Hutch with Doors 42.4" High**

MODEL #	DIMENSIONS W x D x H (1.5" TOP)	WT/LB.	CUBIC FT.	1" TOP	1.5" TOP	GLAZE ADD	HP ADD
Z48S42H	48 x 15 x 42.4	148	22.25	<b>\$1113</b>	<b>\$1176</b>	<b>\$686</b>	N/A
Z42S42H	42 x 15 x 42.4	134	19.5	<b>\$1008</b>	<b>\$1065</b>	<b>\$661</b>	N/A
Z36S42H	36 x 15 x 42.4	120	17	<b>\$923</b>	<b>\$973</b>	<b>\$605</b>	N/A
Z30S42H	30 x 15 x 42.4	106	14.25	<b>\$845</b>	<b>\$887</b>	<b>\$542</b>	N/A

One fixed shelf. Closed back features one grommet and flexible sweep for wire management. Doors lock. Shipped assembled in 1 carton.

- Hutch with 1" top clearance from work surface to valance is 24.25"; with 1.5" top clearance is 23.75".
- Woodgrain runs horizontal on both the upper and lower back panels.

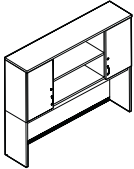

Glazed door option

**Hutch with 2 Outer Doors 55" High**

Z72S55HOH	72 x 15 x 54.9	262	26	<b>\$2822</b>	<b>\$2935</b>	<b>\$785</b>	N/A
Z66S55HOH	66 x 15 x 54.9	246	24	<b>\$2675</b>	<b>\$2781</b>	<b>\$768</b>	N/A
Z60S55HOH	60 x 15 x 54.9	229	22	<b>\$2499</b>	<b>\$2673</b>	<b>\$699</b>	N/A
Z54S55HOH	54 x 15 x 54.9	213	19.75	<b>\$2363</b>	<b>\$2527</b>	<b>\$683</b>	N/A

**Hinged doors on outer compartments only.** Closed back features one grommet and flexible sweep for wire management. Doors lock. Shipped easy to assemble in 2 cartons.

- Hutch with 1" top clearance from work surface to valance is 24.25"; with 1.5" top clearance is 23.75".
- Woodgrain runs horizontal on both the upper and lower back panels.

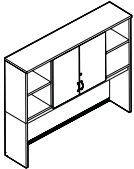

Glazed door option

**Hutch with 2 Inner Doors 55" High**

Z72S55OHO	72 x 15 x 54.9	263	26	<b>\$2824</b>	<b>\$2938</b>	<b>\$788</b>	N/A
Z66S55OHO	66 x 15 x 54.9	247	24	<b>\$2677</b>	<b>\$2784</b>	<b>\$774</b>	N/A
Z60S55OHO	60 x 15 x 54.9	230	22	<b>\$2538</b>	<b>\$2634</b>	<b>\$703</b>	N/A
Z54S55OHO	54 x 15 x 54.9	214	19.75	<b>\$2365</b>	<b>\$2452</b>	<b>\$689</b>	N/A

**Hinged doors on inner compartments only.** Closed back features one grommet and flexible sweep for wire management. Doors lock. Shipped easy to assemble in 2 cartons.

- Hutch with 1" top clearance from work surface to valance is 24.25"; with 1.5" top clearance is 23.75".
- Woodgrain runs horizontal on both the upper and lower back panels.

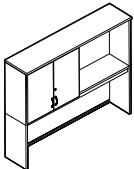

Glazed door option

**Hutch with 2 Doors 55" High - LEFT**

Z72S55HSL	72 x 15 x 54.9	258	26	<b>\$2726</b>	<b>\$2839</b>	<b>\$757</b>	N/A
Z66S55HSL	66 x 15 x 54.9	237	24	<b>\$2602</b>	<b>\$2708</b>	<b>\$743</b>	N/A
Z60S55HSL	60 x 15 x 54.9	221	22	<b>\$2413</b>	<b>\$2509</b>	<b>\$699</b>	N/A
Z54S55HSL	54 x 15 x 54.9	204	19.75	<b>\$2290</b>	<b>\$2377</b>	<b>\$689</b>	N/A

**Hinged doors on left side, open storage on right.** Closed back features one grommet and flexible sweep for wire management. Doors lock. Shipped easy to assemble in 2 cartons.

- Hutch with 1" top clearance from work surface to valance is 24.25"; with 1.5" top clearance is 23.75".
- Woodgrain runs horizontal on both the upper and lower back panels.

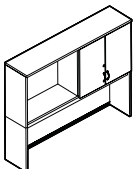

Glazed door option

**Hutch with 2 Doors 55" High - RIGHT\***

Z72S55HSR	72 x 15 x 54.9	258	26	<b>\$2726</b>	<b>\$2839</b>	<b>\$757</b>	N/A
Z66S55HSR	66 x 15 x 54.9	237	24	<b>\$2602</b>	<b>\$2708</b>	<b>\$743</b>	N/A
Z60S55HSR	60 x 15 x 54.9	221	22	<b>\$2413</b>	<b>\$2509</b>	<b>\$699</b>	N/A
Z54S55HSR	54 x 15 x 54.9	204	19.75	<b>\$2290</b>	<b>\$2377</b>	<b>\$689</b>	N/A

**Hinged doors on right side, open storage on left.** Closed back features one grommet and flexible sweep for wire management. Doors lock. Shipped easy to assemble in 2 cartons.

- Hutch with 1" top clearance from work surface to valance is 24.25"; with 1.5" top clearance is 23.75".
- Woodgrain runs horizontal on both the upper and lower back panels.

**Required specifications**

Top finish  
Top thickness/edge detail  
Base finish  
Handles\*

**Optional specifications**

Key #\*  
Glazed doors\*

**Accessories**

Tackboard  
Pigeon-hole storage

**CLOSED HUTCHES**

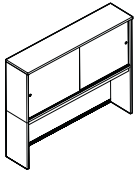

**Hutch w/Sliding Glass Doors 55" High\***

MODEL #	DIMENSIONS W x D x H	WT/LB.	CUBIC FT.	1" TOP	1.5" TOP	GLAZE ADD	HP ADD
Z72S55HSD	72 x 15 x 54.9	271	28.6	<b>\$5336</b>	<b>\$5449</b>	N/A	N/A
Z66S55HSD	66 x 15 x 54.9	253	26.4	<b>\$4989</b>	<b>\$5095</b>	N/A	N/A
Z60S55HSD	60 x 15 x 54.9	235	24.2	<b>\$4617</b>	<b>\$4713</b>	N/A	N/A
Z54S55HSD	54 x 15 x 54.9	217	21.8	<b>\$4276</b>	<b>\$4363</b>	N/A	N/A

Sliding glass doors do not lock. Closed back features one grommet and flexible sweep for wire management. Shipped easy to assemble in 3 cartons (glass doors shipped separately).

- Hutch with 1" top clearance from work surface to valance is 24.25"; with 1.5" top clearance is 23.75".
- Woodgrain runs horizontal on both the upper and lower back panels.

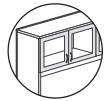
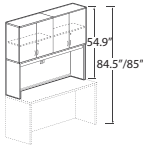

Glazed door option

**Closed Hutch w/Doors 54.9" High\***

Z84S55H	84 x 15 x 54.9	349	62.5	<b>\$2761</b>	<b>\$2873</b>	<b>\$1924</b>	N/A
Z72S55H	72 x 15 x 54.9	308	53.75	<b>\$2487</b>	<b>\$2598</b>	<b>\$1737</b>	N/A
Z71S55H	71.7 x 15 x 54.9	307	53.75	<b>\$2477</b>	<b>\$2574</b>	<b>\$1720</b>	N/A
Z66S55H	66 x 15 x 54.9	287	49.5	<b>\$2346</b>	<b>\$2440</b>	<b>\$1637</b>	N/A
Z60S55H	60 x 15 x 54.9	269	45.25	<b>\$2156</b>	<b>\$2240</b>	<b>\$1521</b>	N/A

One fixed shelf and one adjustable shelf (per compartment). Closed back features one grommet and flexible sweep for wire management. Doors lock. Shipped easy to assemble in 3 cartons.

- Hutch with 1" top clearance from work surface to valance is 24.25"; with 1.5" top clearance is 23.75".
- Woodgrain runs horizontal on both the upper and lower back panels.

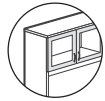
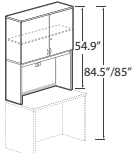

Glazed door option

**Closed Hutch w/Doors 54.9" High\***

Z48S55H	48 x 15 x 54.9	207	36	<b>\$1601</b>	<b>\$1652</b>	<b>\$1062</b>	N/A
Z42S55H	42 x 15 x 54.9	188	31.5	<b>\$1459</b>	<b>\$1516</b>	<b>\$961</b>	N/A
Z36S55H	36 x 15 x 54.9	167	27.25	<b>\$1330</b>	<b>\$1380</b>	<b>\$870</b>	N/A
Z30S55H	30 x 15 x 54.9	148	23	<b>\$1202</b>	<b>\$1244</b>	<b>\$761</b>	N/A

One fixed shelf and one adjustable shelf. Closed back features one grommet and flexible sweep for wire management. Doors lock. Shipped easy to assemble in 2 cartons.

- Hutch with 1" top clearance from work surface to valance is 24.25"; with 1.5" top clearance is 23.75".
- Woodgrain runs horizontal on both the upper and lower back panels.

**PIGEON-HOLE STORAGE**

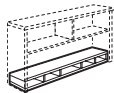
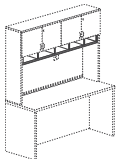

**Horizontal Pigeon-Hole Storage\*\***

ZHS84	82 x 12 x 5.7	49	3.34	<b>\$803</b>	N/A	N/A	N/A
ZHS72	70 x 12 x 5.7	49	3	<b>\$699</b>	N/A	N/A	N/A
ZHS71	69.6 x 12 x 5.7	49	3	<b>\$699</b>	N/A	N/A	N/A
ZHS66	63.9 x 12 x 5.7	46	2.8	<b>\$658</b>	N/A	N/A	N/A
ZHS60	58 x 12 x 5.7	42	2.5	<b>\$630</b>	N/A	N/A	N/A
ZHS48	45.9 x 12 x 5.7	33	2	<b>\$470</b>	N/A	N/A	N/A
ZHS42	40 x 12 x 5.7	29	2	<b>\$439</b>	N/A	N/A	N/A
ZHS36	33.9 x 12 x 5.7	26	2	<b>\$414</b>	N/A	N/A	N/A

For additional storage. Can be **top** or **bottom** mounted. For use with hutches (as shown only). Shipped easy to assemble in 1 carton.

- Available in all standard laminate finishes, see page 111.

**Required specifications**

Top finish\* Shell finish\*\*  
 Top thickness/edge detail\*  
 Base finish\*  
 Handles\*

**Optional specifications**

Key #\*  
 Glazed doors (only ZxxS55H)

**Accessories**

Tackboard\*  
 Pigeon-hole storage\*

PIGEON-HOLE STORAGE

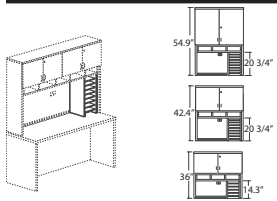

Vertical Pigeon-Hole Storage\*\*

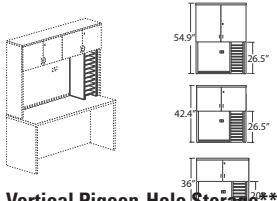

Vertical Pigeon-Hole Storage\*\*

MODEL #	DIMENSIONS	WT/LB.	CUBIC FT.	1" TOP	1.5" TOP	GLAZE ADD	HP ADD
---------	------------	--------	-----------	--------	----------	-----------	--------

W x D x H

ZVS21	13.42 x 11.81 x 20.24	30	1.8	<b>\$352</b>	N/A	N/A	N/A
ZVS14	13.42 x 11.81 x 13.83	24	1.8	<b>\$287</b>	N/A	N/A	N/A

For use in conjunction with horizontal pigeon-hole storage. Can be used **under** or **over** horizontal unit. **Not freestanding.** Shipped easy to assemble in 1 carton.

- Vertical pigeon-hole shell - available in all standard laminate finishes, see page 111.
- Collator shelves - available in Black (BK) or Brushed Cobalt (BC) finish, please specify.  
*Use Brushed Cobalt to match Silver finish handles.*
- When used together with tackboard and hutch, reduce tackboard width by 12.5".

ZVS26	13.42 x 11.81 x 25.91	36	1.8	<b>\$425</b>	N/A	N/A	N/A
ZVS20	13.42 x 11.81 x 19.5	29	1.8	<b>\$340</b>	N/A	N/A	N/A

**Not freestanding.** Shipped easy to assemble in 1 carton.

- Vertical pigeon-hole shell - available in all standard laminate finishes, see page 111.
- Collator shelves - available in Black (BK) or Brushed Cobalt (BC) finish, please specify.  
*Use Brushed Cobalt to match Silver finish handles.*
- Removal of valence required.
- When used together with tackboard and hutch, reduce tackboard width by 12.5".

TRANSITIONAL PIGEON-HOLE STORAGE

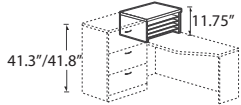

Transitional Pigeon-Hole Storage 11.75" High\*

W x D x H (1.5" TOP)

Z24L12PH	24 x 24 x 11.75	63	2.7	<b>\$702</b>	<b>\$770</b>	N/A	N/A
Z20L12PH	20 x 24 x 11.75	56	2.7	<b>\$619</b>	<b>\$676</b>	N/A	N/A
Z16L12PH	16 x 24 x 11.75	46	1.6	<b>\$567</b>	<b>\$618</b>	N/A	N/A
Z24M12PH	24 x 20 x 11.75	55	2.7	<b>\$619</b>	<b>\$676</b>	N/A	N/A
Z20M12PH	20 x 20 x 11.75	48	2.7	<b>\$549</b>	<b>\$597</b>	N/A	N/A
Z16M12PH	16 x 20 x 11.75	40	1.6	<b>\$499</b>	<b>\$538</b>	N/A	N/A
Z24S12PH	24 x 16 x 11.75	43	1.6	<b>\$570</b>	<b>\$620</b>	N/A	N/A
Z20S12PH	20 x 16 x 11.75	38	1.6	<b>\$503</b>	<b>\$540</b>	N/A	N/A
Z16S12PH	16 x 16 x 11.75	33	1.6	<b>\$471</b>	<b>\$505</b>	N/A	N/A

Designed to fit on top of returns and transition worksurface to match 41.3"/41.8" high storage modules. Pigeon-hole shell and four collator shelves. Shipped easy to assemble in 1 carton.

- Pigeon-hole shell - available in all standard laminate finishes, see page 111.
- Collator shelves - available in Black (BK) or Brushed Cobalt (BC) finish, please specify.  
*Use Brushed Cobalt to match Silver finish handles.*

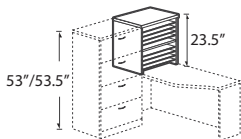

Transitional Pigeon-Hole Storage 23.5" High\*

Z24L23PH	24 x 24 x 23.5	101	2.7	<b>\$1271</b>	<b>\$1337</b>	N/A	N/A
Z20L23PH	20 x 24 x 23.5	88	2.7	<b>\$1111</b>	<b>\$1168</b>	N/A	N/A
Z16L23PH	16 x 24 x 23.5	76	2.7	<b>\$1038</b>	<b>\$1089</b>	N/A	N/A
Z24M23PH	24 x 20 x 23.5	87	2.7	<b>\$1113</b>	<b>\$1170</b>	N/A	N/A
Z20M23PH	20 x 20 x 23.5	76	2.7	<b>\$972</b>	<b>\$1020</b>	N/A	N/A
Z16M23PH	16 x 20 x 23.5	64	1.6	<b>\$891</b>	<b>\$930</b>	N/A	N/A
Z24S23PH	24 x 16 x 23.5	74	2.7	<b>\$1052</b>	<b>\$1102</b>	N/A	N/A
Z20S23PH	20 x 16 x 23.5	65	2.7	<b>\$920</b>	<b>\$959</b>	N/A	N/A
Z16S23PH	16 x 16 x 23.5	54	1.6	<b>\$842</b>	<b>\$876</b>	N/A	N/A

Designed to fit on top of returns and transition worksurface to match 53"/53.5" high storage modules. Pigeon-hole shell and eight collator shelves. Shipped easy to assemble in 1 carton.

- Pigeon-hole shell - available in all standard laminate finishes, see page 111.
- Collator shelves - available in Black (BK) or Brushed Cobalt (BC) finish, please specify.  
*Use Brushed Cobalt to match Silver finish handles.*

Required specifications

- Top finish\*
- Top thickness/edge detail\*
- Base finish\*
- Shell finish\*\*

**FLOATING SHELVES**

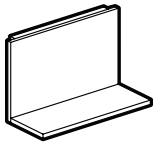

**Floating Shelf 20" High**

MODEL #	DIMENSIONS W x D x H (1.5" TOP)	WT/LB.	CUBIC FT.	1" TOP	1.5" TOP	GLAZE ADD	HP ADD
ZFS4220	42 x 14.25 x 20	55	2.75	<b>\$684</b>	<b>\$726</b>	N/A	N/A
ZFS3620	36 x 14.25 x 20	47	2.4	<b>\$615</b>	<b>\$651</b>	N/A	N/A
ZFS3020	30 x 14.25 x 20	39	2	<b>\$523</b>	<b>\$553</b>	N/A	N/A
ZFS2420	24 x 14.25 x 20	33	1.9	<b>\$463</b>	<b>\$492</b>	N/A	N/A

To match 71.9"/72.4"H units. Standard with pre-mounted "J" bracket for wall mount applications. End cap required at the end of a run of floating shelves. End cap sold separately, see page 236. Shipped easy to assemble in 1 carton.

• **NOTE:** Care should be taken to mount the units. Units should be mounted to wall studs using correct fasteners. Failure to do so may result in collapse of the unit and subsequent personal injury. **Fastening hardware not included.** Mounting hardware used should be based on wall material. Consult an installation professional for proper wall mounting.

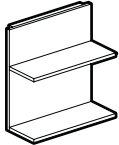

**Double Floating Shelf 32.5" High**

ZF2S4232	42 x 14.25 x 32.5	85	3.3	<b>\$980</b>	<b>\$1022</b>	N/A	N/A
ZF2S3632	36 x 14.25 x 32.5	73	2.9	<b>\$877</b>	<b>\$913</b>	N/A	N/A
ZF2S3032	30 x 14.25 x 32.5	60	2.5	<b>\$746</b>	<b>\$776</b>	N/A	N/A
ZF2S2432	24 x 14.25 x 32.5	50	2.4	<b>\$659</b>	<b>\$689</b>	N/A	N/A

To match 84.4"/84.9"H units. Standard with pre-mounted "J" bracket for wall mount applications. End cap required at the end of a run of floating shelves. End cap sold separately, see page 236. Shipped easy to assemble in 1 carton.

• **NOTE:** Care should be taken to mount the units. Units should be mounted to wall studs using correct fasteners. Failure to do so may result in collapse of the unit and subsequent personal injury. **Fastening hardware not included.** Mounting hardware used should be based on wall material. Consult an installation professional for proper wall mounting.

**WALLS W/OVERHEADS**

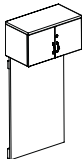

Glazed door option

**Wall w/Closed Storage 66" High\***

Z4266WS	42 x 16 x 66	122	8.25	<b>\$1650</b>	<b>\$1717</b>	<b>\$600</b>	N/A
Z3666WS	36 x 16 x 66	113	8.8	<b>\$1525</b>	<b>\$1567</b>	<b>\$550</b>	N/A
Z3066WS	30 x 16 x 66	97	7.5	<b>\$1390</b>	<b>\$1429</b>	<b>\$491</b>	N/A
Z2466WS	24 x 16 x 66	79	6.6	<b>\$1227</b>	<b>\$1269</b>	<b>\$443</b>	N/A

Standard with pre-mounted "J" bracket for wall mount applications. Doors lock. End cap required at the end of a run of wall units. End cap sold separately, see page 236. Shipped easy to assemble in 2 cartons.

• **NOTE:** Care should be taken to mount the units. Units should be mounted to wall studs using correct fasteners. Failure to do so may result in collapse of the unit and subsequent personal injury. **Mounting hardware not included.** Mounting hardware used should be based on wall material. Consult an installation professional for proper wall mounting.

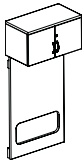

Glazed door option

**Wall w/Closed Storage and Access Cut-Out 66" High\***

Z4266WSO	42 x 16 x 66	112	9.3	<b>\$1760</b>	<b>\$1828</b>	<b>\$600</b>	N/A
Z3666WSO	36 x 16 x 66	100	8.1	<b>\$1602</b>	<b>\$1663</b>	<b>\$550</b>	N/A
Z3066WSO	30 x 16 x 66	85	6.75	<b>\$1395</b>	<b>\$1452</b>	<b>\$491</b>	N/A
Z2466WSO	24 x 16 x 66	70	6.2	<b>\$1238</b>	<b>\$1279</b>	<b>\$443</b>	N/A

Standard with pre-mounted "J" bracket for wall mount applications. Doors lock. Large cutout provides direct access to wall for access to electrical. End cap required at the end of a run of wall units. End cap sold separately, see page 236. Shipped easy to assemble in 2 cartons.

• **NOTE:** Care should be taken to mount the units. Units should be mounted to wall studs using correct fasteners. Failure to do so may result in collapse of the unit and subsequent personal injury. **Mounting hardware not included.** Mounting hardware used should be based on wall material. Consult an installation professional for proper wall mounting.

**Required specifications**

Top finish  
 Top thickness/edge detail  
 Wall finish  
 Shelf or door finish if laminate doors  
 Handles\*

**Optional specifications**

Key #\*  
 Glazed doors\*  
 Grommet position\*  
 End filler cap

WALLS W/OVERHEADS      MODEL #      DIMENSIONS      WT/LB.      CUBIC FT.      1" TOP      1.5" TOP      GLAZE ADD      HP ADD

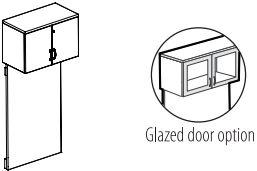

Wall w/Closed Storage 72" High\*

	W x D x H (1.5" TOP)							
Z4272WS	42 x 16 x 72.4	134	10.2	\$1760	\$1848	\$689	N/A	
Z3672WS	36 x 16 x 72.4	119	9.45	\$1695	\$1772	\$628	N/A	
Z3072WS	30 x 16 x 72.4	102	8.1	\$1491	\$1555	\$561	N/A	
Z2472WS	24 x 16 x 72.4	84	6.6	\$1307	\$1358	\$510	N/A	

Standard with pre-mounted "J" bracket for wall mount applications. Doors lock. End cap required at the end of a run of wall units. End cap sold separately, see page 236. Shipped easy to assemble in 2 cartons.

• **NOTE:** Care should be taken to mount the units. Units should be mounted to wall studs using correct fasteners. Failure to do so may result in collapse of the unit and subsequent personal injury. **Mounting hardware not included.** Mounting hardware used should be based on wall material. Consult an installation professional for proper wall mounting.

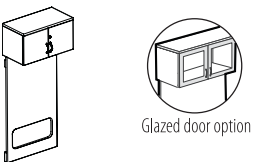

Wall w/Closed Storage and Access Cut-Out 72" High\*

Z4272WSO	42 x 16 x 72.4	120	9.3	\$1777	\$1864	\$689	N/A	
Z3672WSO	36 x 16 x 72.4	105	8.65	\$1711	\$1788	\$628	N/A	
Z3072WSO	30 x 16 x 72.4	91	7.5	\$1503	\$1590	\$561	N/A	
Z2472WSO	24 x 16 x 72.4	74	6.2	\$1317	\$1369	\$510	N/A	

Standard with pre-mounted "J" bracket for wall mount applications. Doors lock. Large cutout provides direct access to wall for access to electrical. End cap required at the end of a run of wall units. End cap sold separately, see page 236. Shipped easy to assemble in 2 cartons.

• **NOTE:** Care should be taken to mount the units. Units should be mounted to wall studs using correct fasteners. Failure to do so may result in collapse of the unit and subsequent personal injury. **Mounting hardware not included.** Mounting hardware used should be based on wall material. Consult an installation professional for proper wall mounting.

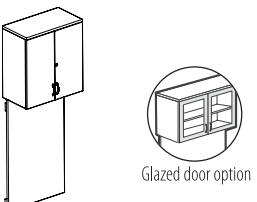

Wall w/Closed Storage 84" High\*

Z4284WS	42 x 16 x 84.9	134	10.2	\$2178	\$2265	\$956	N/A	
Z3684WS	36 x 16 x 84.9	119	9.45	\$2068	\$2159	\$871	N/A	
Z3084WS	30 x 16 x 84.9	102	8.1	\$1817	\$1881	\$773	N/A	
Z2484WS	24 x 16 x 84.9	84	6.6	\$1601	\$1653	\$703	N/A	

Standard with pre-mounted "J" bracket for wall mount applications. Fixed interior shelf. Doors lock. End cap required at the end of a run of wall units. End cap sold separately, see page 236. Shipped easy to assemble in 2 cartons.

• **NOTE:** Care should be taken to mount the units. Units should be mounted to wall studs using correct fasteners. Failure to do so may result in collapse of the unit and subsequent personal injury. **Mounting hardware not included.** Mounting hardware used should be based on wall material. Consult an installation professional for proper wall mounting.

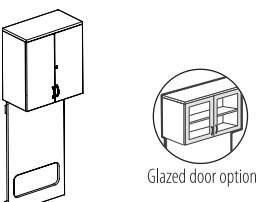

Wall w/Closed Storage and Access Cut-Out 84" High\*

Z4284WSO	42 x 16 x 84.9	120	9.3	\$2195	\$2282	\$956	N/A	
Z3684WSO	36 x 16 x 84.9	105	8.65	\$2085	\$2175	\$871	N/A	
Z3084WSO	30 x 16 x 84.9	91	7.5	\$1832	\$1895	\$773	N/A	
Z2484WSO	24 x 16 x 84.9	74	6.2	\$1610	\$1661	\$703	N/A	

Standard with pre-mounted "J" bracket for wall mount applications. Fixed interior shelf. Doors lock. Large cutout provides direct access to wall for access to electrical. End cap required at the end of a run of wall units. End cap sold separately, see page 236. Shipped easy to assemble in 2 cartons.

• **NOTE:** Care should be taken to mount the units. Units should be mounted to wall studs using correct fasteners. Failure to do so may result in collapse of the unit and subsequent personal injury. **Mounting hardware not included.** Mounting hardware used should be based on wall material. Consult an installation professional for proper wall mounting.

**Required specifications**

- Top finish
- Handles
- Top thickness/edge detail
- Wall finish
- Door front finish if laminate doors

**Optional specifications**

- Key #
- Glazed doors
- Grommet position
- End filler cap



WALLS W/FLOATING SHELVES	MODEL #	DIMENSIONS	WT/LB.	CUBIC FT.	1" TOP	1.5" TOP	GLAZE ADD	HP ADD
--------------------------	---------	------------	--------	-----------	--------	----------	-----------	--------

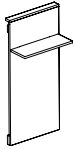

Wall w/Floating Shelf 66" High

	W x D x H (1.5" TOP)							
ZF1S4266	42 x 14.25 x 66	119	7.5	<b>\$1288</b>	<b>\$1331</b>	N/A	N/A	
ZF1S3666	36 x 14.25 x 66	105	6.6	<b>\$1121</b>	<b>\$1158</b>	N/A	N/A	
ZF1S3066	30 x 14.25 x 66	88	5.7	<b>\$969</b>	<b>\$1005</b>	N/A	N/A	
ZF1S2466	24 x 14.25 x 66	70	4.7	<b>\$831</b>	<b>\$857</b>	N/A	N/A	

Fixed position shelf, 10.75"D. Standard with pre-mounted "J" bracket for wall mount applications. End cap required at the end of a run of floating shelves. End cap sold separately, see page 236. Shipped easy to assemble in 1 carton.

- **NOTE:** Care should be taken to mount the units. Units should be mounted to wall studs using correct fasteners. Failure to do so may result in collapse of the unit and subsequent personal injury. **Fastening hardware not included.** Mounting hardware used should be based on wall material. Consult an installation professional for proper wall mounting.

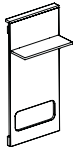

Wall w/Floating Shelf and Access Cut-Out 66" High

ZF1S42660	42 x 14.25 x 66	112	7.5	<b>\$1300</b>	<b>\$1342</b>	N/A	N/A	
ZF1S36660	36 x 14.25 x 66	99	6.6	<b>\$1135</b>	<b>\$1168</b>	N/A	N/A	
ZF1S30660	30 x 14.25 x 66	83	5.7	<b>\$974</b>	<b>\$1010</b>	N/A	N/A	
ZF1S24660	24 x 14.25 x 66	67	4.7	<b>\$836</b>	<b>\$862</b>	N/A	N/A	

Fixed position shelf, 10.75"D. Standard with pre-mounted "J" bracket for wall mount applications. Large cutout provides direct access to wall for access to electrical. End cap required at the end of a run of floating shelves. End cap sold separately, see page 236. Shipped easy to assemble in 1 carton.

- **NOTE:** Care should be taken to mount the units. Units should be mounted to wall studs using correct fasteners. Failure to do so may result in collapse of the unit and subsequent personal injury. **Fastening hardware not included.** Mounting hardware used should be based on wall material. Consult an installation professional for proper wall mounting.

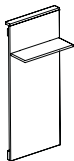

Wall w/Floating Shelf 72" High

ZF1S4272	42 x 14.25 x 72.4	129	8	<b>\$1357</b>	<b>\$1400</b>	N/A	N/A	
ZF1S3672	36 x 14.25 x 72.4	112	7.1	<b>\$1185</b>	<b>\$1216</b>	N/A	N/A	
ZF1S3072	30 x 14.25 x 72.4	94	6.1	<b>\$1041</b>	<b>\$1077</b>	N/A	N/A	
ZF1S2472	24 x 14.25 x 72.4	75	5	<b>\$884</b>	<b>\$910</b>	N/A	N/A	

Fixed position shelf, 10.75"D. Standard with pre-mounted "J" bracket for wall mount applications. End cap required at the end of a run of floating shelves. End cap sold separately, see page 236. Shipped easy to assemble in 1 carton.

- **NOTE:** Care should be taken to mount the units. Units should be mounted to wall studs using correct fasteners. Failure to do so may result in collapse of the unit and subsequent personal injury. **Fastening hardware not included.** Mounting hardware used should be based on wall material. Consult an installation professional for proper wall mounting.

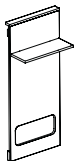

Wall w/Floating Shelf and Access Cut-Out 72" High\*

ZF1S42720	42 x 14.25 x 72.4	122	8	<b>\$1374</b>	<b>\$1410</b>	N/A	N/A	
ZF1S36720	36 x 14.25 x 72.4	106	7.1	<b>\$1200</b>	<b>\$1233</b>	N/A	N/A	
ZF1S30720	30 x 14.25 x 72.4	89	6.1	<b>\$1058</b>	<b>\$1095</b>	N/A	N/A	
ZF1S24720	24 x 14.25 x 72.4	72	5	<b>\$890</b>	<b>\$921</b>	N/A	N/A	

Fixed position shelf, 10.75"D. Standard with pre-mounted "J" bracket for wall mount applications. Large cutout provides direct access to wall for access to electrical. End cap required at the end of a run of floating shelves. End cap sold separately, see page 236. Shipped easy to assemble in 1 carton.

- **NOTE:** Care should be taken to mount the units. Units should be mounted to wall studs using correct fasteners. Failure to do so may result in collapse of the unit and subsequent personal injury. **Fastening hardware not included.** Mounting hardware used should be based on wall material. Consult an installation professional for proper wall mounting.

**Required specifications**

- Top finish
- Top thickness/edge detail
- Wall finish
- Shelf finish

**Optional specifications**

- Grommet position
- End filler cap

WALLS W/FLOATING SHELVES

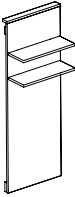

Wall w/Floating Shelves 84" High

MODEL #	DIMENSIONS W x D x H (1.5" TOP)	WT/LB.	CUBIC FT.	1" TOP	1.5" TOP	GLAZE ADD	HP ADD
ZF2S4284	42 x 14.25 x 84.9	160	9.5	<b>\$1595</b>	<b>\$1637</b>	N/A	N/A
ZF2S3684	36 x 14.25 x 84.9	138	8.4	<b>\$1374</b>	<b>\$1421</b>	N/A	N/A
ZF2S3084	30 x 14.25 x 84.9	115	7.1	<b>\$1209</b>	<b>\$1237</b>	N/A	N/A
ZF2S2484	24 x 14.25 x 84.9	92	6.25	<b>\$1052</b>	<b>\$1078</b>	N/A	N/A

Fixed position shelves, 10.75"D. Standard with pre-mounted "J" bracket for wall mount applications. End cap required at the end of a run of floating shelves. End cap sold separately, see page 236. Shipped easy to assemble in 1 carton.

- **NOTE:** Care should be taken to mount the units. Units should be mounted to wall studs using correct fasteners. Failure to do so may result in collapse of the unit and subsequent personal injury. **Fastening hardware not included.** Mounting hardware used should be based on wall material. Consult an installation professional for proper wall mounting.

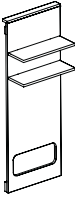

Wall w/Floating Shelves and Access Cut-Out 84" High

ZF2S42840	42 x 14.25 x 84.9	140	9.5	<b>\$1604</b>	<b>\$1646</b>	N/A	N/A
ZF2S36840	36 x 14.25 x 84.9	130	8.4	<b>\$1389</b>	<b>\$1431</b>	N/A	N/A
ZF2S30840	30 x 14.25 x 84.9	108	7.1	<b>\$1316</b>	<b>\$1342</b>	N/A	N/A
ZF2S24840	24 x 14.25 x 84.9	87	6.25	<b>\$1058</b>	<b>\$1084</b>	N/A	N/A

Fixed position shelves, 10.75"D. Standard with pre-mounted "J" bracket for wall mount applications. Large cutout provides direct access to wall for access to electrical. End cap required at the end of a run of floating shelves. End cap sold separately, see page 236. Shipped easy to assemble in 1 carton.

- **NOTE:** Care should be taken to mount the units. Units should be mounted to wall studs using correct fasteners. Failure to do so may result in collapse of the unit and subsequent personal injury. **Fastening hardware not included.** Mounting hardware used should be based on wall material. Consult an installation professional for proper wall mounting.

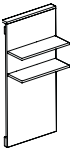

Wall w/Floating Shelves 66" High

ZF2S4266	42 x 14.25 x 66	132	7.5	<b>\$1327</b>	<b>\$1369</b>	N/A	N/A
ZF2S3666	36 x 14.25 x 66	115	6.6	<b>\$1148</b>	<b>\$1184</b>	N/A	N/A
ZF2S3066	30 x 14.25 x 66	96	5.7	<b>\$998</b>	<b>\$1028</b>	N/A	N/A
ZF2S2466	24 x 14.25 x 66	77	4.7	<b>\$851</b>	<b>\$881</b>	N/A	N/A

Fixed position shelves, 10.75"D. Standard with pre-mounted "J" bracket for wall mount applications. End cap required at the end of a run of floating shelves. End cap sold separately, see page 236. Shipped easy to assemble in 1 carton.

- **NOTE:** Care should be taken to mount the units. Units should be mounted to wall studs using correct fasteners. Failure to do so may result in collapse of the unit and subsequent personal injury. **Fastening hardware not included.** Mounting hardware used should be based on wall material. Consult an installation professional for proper wall mounting.

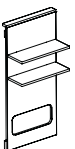

Wall w/Floating Shelves and Access Cut-Out 66" High

ZF2S42660	42 x 14.25 x 66	125	7.5	<b>\$1342</b>	<b>\$1385</b>	N/A	N/A
ZF2S36660	36 x 14.25 x 66	109	6.6	<b>\$1163</b>	<b>\$1199</b>	N/A	N/A
ZF2S30660	30 x 14.25 x 66	91	5.7	<b>\$1009</b>	<b>\$1040</b>	N/A	N/A
ZF2S24660	24 x 14.25 x 66	74	4.7	<b>\$862</b>	<b>\$891</b>	N/A	N/A

Fixed position shelves, 10.75"D. Standard with pre-mounted "J" bracket for wall mount applications. Large cutout provides direct access to wall for access to electrical. End cap required at the end of a run of floating shelves. End cap sold separately, see page 236. Shipped easy to assemble in 1 carton.

- **NOTE:** Care should be taken to mount the units. Units should be mounted to wall studs using correct fasteners. Failure to do so may result in collapse of the unit and subsequent personal injury. **Fastening hardware not included.** Mounting hardware used should be based on wall material. Consult an installation professional for proper wall mounting.

**Required specifications**

Top finish  
Top thickness/edge detail  
Wall finish  
Shelf finish

**Optional specifications**

Grommet position  
End filler cap

WALLS W/FLOATING SHELVES	MODEL #	DIMENSIONS	WT/LB.	CUBIC FT.	1" TOP	1.5" TOP	GLAZE ADD	HP ADD
--------------------------	---------	------------	--------	-----------	--------	----------	-----------	--------

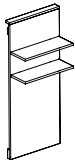

Wall w/Floating Shelves 72" High

	W x D x H (1.5" TOP)							
ZF2S4272	42 x 14.25 x 72.4	142	8	<b>\$1395</b>	<b>\$1437</b>	N/A	N/A	
ZF2S3672	36 x 14.25 x 72.4	122	7.1	<b>\$1212</b>	<b>\$1247</b>	N/A	N/A	
ZF2S3072	30 x 14.25 x 72.4	102	6.1	<b>\$1076</b>	<b>\$1106</b>	N/A	N/A	
ZF2S2472	24 x 14.25 x 72.4	82	5	<b>\$908</b>	<b>\$938</b>	N/A	N/A	

Fixed position shelves, 10.75"D. Standard with pre-mounted "J" bracket for wall mount applications. End cap required at the end of a run of floating shelves. End cap sold separately, see page 236. Shipped easy to assemble in 1 carton.

• **NOTE:** Care should be taken to mount the units. Units should be mounted to wall studs using correct fasteners. Failure to do so may result in collapse of the unit and subsequent personal injury. **Fastening hardware not included.** Mounting hardware used should be based on wall material. Consult an installation professional for proper wall mounting.

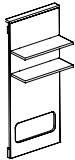

Wall w/Floating Shelves and Access Cut-Out 72" High

ZF2S42720	42 x 14.25 x 72.4	135	8	<b>\$1412</b>	<b>\$1454</b>	N/A	N/A	
ZF2S36720	36 x 14.25 x 72.4	116	7.1	<b>\$1228</b>	<b>\$1263</b>	N/A	N/A	
ZF2S30720	30 x 14.25 x 72.4	97	6.1	<b>\$1086</b>	<b>\$1116</b>	N/A	N/A	
ZF2S24720	24 x 14.25 x 72.4	79	5	<b>\$919</b>	<b>\$949</b>	N/A	N/A	

Fixed position shelves, 10.75"D. Standard with pre-mounted "J" bracket for wall mount applications. Large cutout provides direct access to wall for access to electrical. End cap required at the end of a run of floating shelves. End cap sold separately, see page 236. Shipped easy to assemble in 1 carton.

• **NOTE:** Care should be taken to mount the units. Units should be mounted to wall studs using correct fasteners. Failure to do so may result in collapse of the unit and subsequent personal injury. **Fastening hardware not included.** Mounting hardware used should be based on wall material. Consult an installation professional for proper wall mounting.

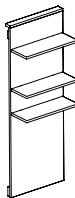

Wall w/Floating Shelves 84" High

ZF3S4284	42 x 14.25 x 84.9	173	9.5	<b>\$1631</b>	<b>\$1673</b>	N/A	N/A	
ZF3S3684	36 x 14.25 x 84.9	148	8.4	<b>\$1412</b>	<b>\$1448</b>	N/A	N/A	
ZF3S3084	30 x 14.25 x 84.9	123	7.1	<b>\$1241</b>	<b>\$1271</b>	N/A	N/A	
ZF3S2484	24 x 14.25 x 84.9	99	6.25	<b>\$1077</b>	<b>\$1106</b>	N/A	N/A	

Fixed position shelves, 10.75"D. Standard with pre-mounted "J" bracket for wall mount applications. End cap required at the end of a run of floating shelves. End cap sold separately, see page 236. Shipped easy to assemble in 1 carton.

• **NOTE:** Care should be taken to mount the units. Units should be mounted to wall studs using correct fasteners. Failure to do so may result in collapse of the unit and subsequent personal injury. **Fastening hardware not included.** Mounting hardware used should be based on wall material. Consult an installation professional for proper wall mounting.

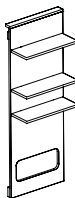

Wall w/Floating Shelves and Access Cut-Out 84" High

ZF3S42840	42 x 14.25 x 84.9	163	9.5	<b>\$1647</b>	<b>\$1689</b>	N/A	N/A	
ZF3S36840	36 x 14.25 x 84.9	140	8.4	<b>\$1427</b>	<b>\$1463</b>	N/A	N/A	
ZF3S30840	30 x 14.25 x 84.9	116	7.1	<b>\$1346</b>	<b>\$1377</b>	N/A	N/A	
ZF3S24840	24 x 14.25 x 84.9	94	6.25	<b>\$1081</b>	<b>\$1111</b>	N/A	N/A	

Fixed position shelves, 10.75"D. Standard with pre-mounted "J" bracket for wall mount applications. Large cutout provides direct access to wall for access to electrical. End cap required at the end of a run of floating shelves. End cap sold separately, see page 236. Shipped easy to assemble in 1 carton.

• **NOTE:** Care should be taken to mount the units. Units should be mounted to wall studs using correct fasteners. Failure to do so may result in collapse of the unit and subsequent personal injury. **Fastening hardware not included.** Mounting hardware used should be based on wall material. Consult an installation professional for proper wall mounting.

**Required specifications**

- Top finish
- Top thickness/edge detail
- Wall finish
- Shelf finish

**Optional specifications**

- Grommet position
- End filler cap

WALL PANELS      MODEL #      DIMENSIONS      WT/LB.      CUBIC FT.      1" TOP      1.5" TOP      GLAZE ADD      HP ADD



Wall Panel 66" High

	W x D x H (1.5" TOP)							
ZWHP4266	42 x 3.5 x 66	99	7.5	<b>\$1139</b>	<b>\$1181</b>	N/A	N/A	
ZWHP3666	36 x 3.5 x 66	90	6.6	<b>\$904</b>	<b>\$940</b>	N/A	N/A	
ZWHP3066	30 x 3.5 x 66	75	5.7	<b>\$783</b>	<b>\$813</b>	N/A	N/A	
ZWHP2466	24 x 3.5 x 66	61	4.7	<b>\$670</b>	<b>\$700</b>	N/A	N/A	

Standard with pre-mounted "J" bracket for wall mount applications. End cap required at the end of a run of floating shelves. End cap sold separately, see page 236. Shipped easy to assemble in 1 carton.

• **NOTE:** Care should be taken to mount the units. Units should be mounted to wall studs using correct fasteners. Failure to do so may result in collapse of the unit and subsequent personal injury. **Fastening hardware not included.** Mounting hardware used should be based on wall material. Consult an installation professional for proper wall mounting.

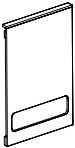

Wall Panel w/Access Cut-Out 66" High

ZWHP4266O	42 x 3.5 x 66	90	7.5	<b>\$1156</b>	<b>\$1198</b>	N/A	N/A	
ZWHP3666O	36 x 3.5 x 66	82	6.6	<b>\$919</b>	<b>\$955</b>	N/A	N/A	
ZWHP3066O	30 x 3.5 x 66	69	5.7	<b>\$795</b>	<b>\$826</b>	N/A	N/A	
ZWHP2466O	24 x 3.5 x 66	56	4.7	<b>\$679</b>	<b>\$709</b>	N/A	N/A	

Standard with pre-mounted "J" bracket for wall mount applications. Large cutout provides direct access to wall for access to electrical. End cap required at the end of a run of floating shelves. End cap sold separately, see page 236.

Shipped easy to assemble in 1 carton.

• **NOTE:** Care should be taken to mount the units. Units should be mounted to wall studs using correct fasteners. Failure to do so may result in collapse of the unit and subsequent personal injury. **Fastening hardware not included.** Mounting hardware used should be based on wall material. Consult an installation professional for proper wall mounting.



Wall Panel 72" High

ZWHP4272	42 x 3.5 x 72.4	113	8	<b>\$1112</b>	<b>\$1154</b>	N/A	N/A	
ZWHP3672	36 x 3.5 x 72.4	97	7.1	<b>\$969</b>	<b>\$1004</b>	N/A	N/A	
ZWHP3072	30 x 3.5 x 72.4	81	6.1	<b>\$861</b>	<b>\$891</b>	N/A	N/A	
ZWHP2472	24 x 3.5 x 72.4	67	5	<b>\$724</b>	<b>\$754</b>	N/A	N/A	

Standard with pre-mounted "J" bracket for wall mount applications. End cap required at the end of a run of floating shelves. End cap sold separately, see page 236. Shipped easy to assemble in 1 carton.

• **NOTE:** Care should be taken to mount the units. Units should be mounted to wall studs using correct fasteners. Failure to do so may result in collapse of the unit and subsequent personal injury. **Fastening hardware not included.** Mounting hardware used should be based on wall material. Consult an installation professional for proper wall mounting.



Wall Panel w/Access Cut-Out 72" High

ZWHP4272O	42 x 3.5 x 72.4	104	8	<b>\$1128</b>	<b>\$1170</b>	N/A	N/A	
ZWHP3672O	36 x 3.5 x 72.4	89	7.1	<b>\$983</b>	<b>\$1018</b>	N/A	N/A	
ZWHP3072O	30 x 3.5 x 72.4	75	6.1	<b>\$872</b>	<b>\$902</b>	N/A	N/A	
ZWHP2472O	24 x 3.5 x 72.4	62	5	<b>\$735</b>	<b>\$765</b>	N/A	N/A	

Standard with pre-mounted "J" bracket for wall mount applications. Large cutout provides direct access to wall for access to electrical. End cap required at the end of a run of floating shelves. End cap sold separately, see page 236.

Shipped easy to assemble in 1 carton.

• **NOTE:** Care should be taken to mount the units. Units should be mounted to wall studs using correct fasteners. Failure to do so may result in collapse of the unit and subsequent personal injury. **Fastening hardware not included.** Mounting hardware used should be based on wall material. Consult an installation professional for proper wall mounting.

**Required specifications**

Top finish  
Top thickness/edge detail  
Wall finish

**Optional specifications**

Grommet position  
End filler cap

WALL PANELS	MODEL #	DIMENSIONS	WT/LB.	CUBIC FT.	1" TOP	1.5" TOP	GLAZE ADD	HP ADD
-------------	---------	------------	--------	-----------	--------	----------	-----------	--------

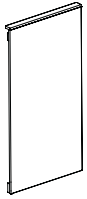

Wall Panel 84" High

	W x D x H (1.5" TOP)							
ZWHP4284	42 x 3.5 x 84.9	128	9.5	<b>\$1187</b>	<b>\$1229</b>	N/A	N/A	
ZWHP3684	36 x 3.5 x 84.9	111	8.4	<b>\$1045</b>	<b>\$1081</b>	N/A	N/A	
ZWHP3084	30 x 3.5 x 84.9	92	7.1	<b>\$930</b>	<b>\$960</b>	N/A	N/A	
ZWHP2484	24 x 3.5 x 84.9	75	6.25	<b>\$802</b>	<b>\$831</b>	N/A	N/A	

Standard with pre-mounted "J" bracket for wall mount applications. End cap required at the end of a run of floating shelves. End cap sold separately, see page 236. Shipped easy to assemble in 1 carton.

- **NOTE:** Care should be taken to mount the units. Units should be mounted to wall studs using correct fasteners. Failure to do so may result in collapse of the unit and subsequent personal injury. **Fastening hardware not included.** Mounting hardware used should be based on wall material. Consult an installation professional for proper wall mounting.

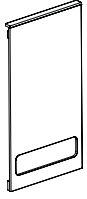

Wall Panel w/Access Cut-Out 84" High

ZWHP42840	42 x 3.5 x 84.9	119	9.5	<b>\$1203</b>	<b>\$1245</b>	N/A	N/A
ZWHP36840	36 x 3.5 x 84.9	103	8.4	<b>\$1059</b>	<b>\$1095</b>	N/A	N/A
ZWHP30840	30 x 3.5 x 84.9	86	7.1	<b>\$942</b>	<b>\$972</b>	N/A	N/A
ZWHP24840	24 x 3.5 x 84.9	70	6.25	<b>\$811</b>	<b>\$841</b>	N/A	N/A

Standard with pre-mounted "J" bracket for wall mount applications. Large cutout provides direct access to wall for access to electrical. End cap required at the end of a run of floating shelves. End cap sold separately, see page 236. Shipped easy to assemble in 1 carton.





- **NOTE:** Care should be taken to mount the units. Units should be mounted to wall studs using correct fasteners. Failure to do so may result in collapse of the unit and subsequent personal injury. **Fastening hardware not included.** Mounting hardware used should be based on wall material. Consult an installation professional for proper wall mounting.

**Required specifications**

- Top finish
- Top thickness/edge detail
- Wall finish

**Optional specifications**

- Grommet position
- End filler cap

END FILLER CAPS	MODEL #	DIMENSIONS	WT/LB.	CUBIC FT.	LIST PRICE
 End Cap	ZEFC19	W x D x H 2.5 x 0.75 x 17	1.5	0.25	\$189
	For 20"H floating shelf: ZFSxxxx.				
 End Cap	ZEFC32	2.5 x 0.75 x 30	2	2	\$304
	For 32.5"H floating shelf: ZF2Sxxxx.				
 End Cap	ZEFC49	2.5 x 0.75 x 47	3	1.2	\$405
	For 65.5"/66"H walls with overhead: Zxx66WS or Zxx66WSO.				
 End Cap	ZEFC52	2.5 x 0.75 x 50	4	1.3	\$431
	For 71.9"/72.4"H or 84.4"/84.9"H walls with overhead: Zxx72WS, Zxx72WSO, Zxx84WS or Zxx84WSO				
 End Cap	ZEFC66	2.5 x 0.75 x 64	4	4	\$527
	For 65.5"/66"H wall panels, with or without shelves: ZF1Sxx66, ZF1Sxx66O, ZF2Sxx66, ZF2Sxx66O, ZWHPxx66 or ZWHPxx66O.				
 End Cap	ZEFC72	2.5 x 0.75 x 70.5	4	4	\$568
	For 71.9"/72.4"H wall panels, with or without shelves: ZF1Sxx72, ZF1Sxx72O, ZF2Sxx72, ZF2Sxx72O, ZWHPxx72 or ZWHPxx72O.				
 End Cap	ZEFC84	2.5 x 0.75 x 83	5	4.5	\$670
	For 84.4"/84.9"H wall panels, with or without shelves: ZF1Sxx84, ZF1Sxx84O, ZF2Sxx84, ZF2Sxx84O, ZWHPxx84 or ZWHPxx84O.				

**Required specifications**  
Base finish

TACKBOARDS FOR HUTCHES

**NOTES:** Tackboards can be upholstered in all of the following fabrics:

- Anchorage
- Global seating fabrics\*
- Lola
- Merge

For a custom size tackboard that is less than 82"W x 21"H, price = next size up plus 5%.  
ie: ZTB4921: next size up - ZTB5821 plus 5%.

\* Contact Customer Service for pricing.

TACKBOARDS FOR HUTCHES - 23.5" HIGH

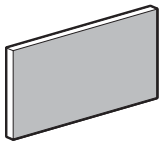

Tackboard

MODEL #	DIMENSIONS W x D x H	WT/LB.	CUBIC FT.	LIST PRICE
ZTB8217	82 x 0.62 x 17	8.2	2	\$502

For use on **Z84S23HN** hutch. Includes mounting screws.

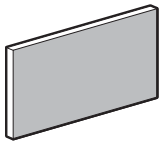

Tackboard

ZTB7017	70 x 0.62 x 17	7	1.3	\$356
---------	----------------	---	-----	-------

For use on **Z72S23HN** hutch. Includes mounting screws.

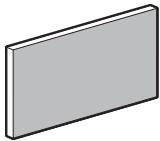

Tackboard

ZTB6917	69 x 0.62 x 17	7	1.3	\$353
---------	----------------	---	-----	-------

For use on **Z71S23HN** hutch. Includes mounting screws.

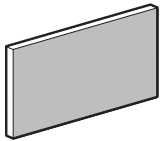

Tackboard

ZTB6417	64 x 0.62 x 17	6.4	1.3	\$345
---------	----------------	-----	-----	-------

For use on **Z66S23HN** hutch. Includes mounting screws.

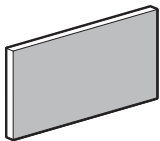

Tackboard

ZTB5817	58 x 0.62 x 17	5.8	1.08	\$339
---------	----------------	-----	------	-------

For use on **Z60S23HN** hutch. Includes mounting screws.

**Required specifications**

Fabric

TACKBOARDS FOR HUTCHES - 23.5" HIGH

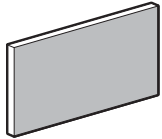

Tackboard

MODEL #	DIMENSIONS W x D x H	WT/LB.	CUBIC FT.	LIST PRICE
ZTB4617	46 x 0.62 x 17	4.6	0.85	<b>\$327</b>

For use on **Z48S23HN** hutch. Includes mounting screws.

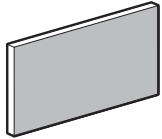

Tackboard

ZTB4017	40 x 0.62 x 17	4	0.85	<b>\$313</b>
---------	----------------	---	------	--------------

For use on **Z42S23HN** hutch. Includes mounting screws.

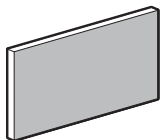

Tackboard

ZTB3417	34 x 0.62 x 17	3.4	0.85	<b>\$206</b>
---------	----------------	-----	------	--------------

For use on **Z36S23HN** hutch. Includes mounting screws.

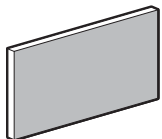

Tackboard

ZTB2817	28 x 0.62 x 17	2.8	0.85	<b>\$196</b>
---------	----------------	-----	------	--------------

For use on **Z30S23HN** hutch. Includes mounting screws.

TACKBOARDS FOR HUTCHES - 36" HIGH

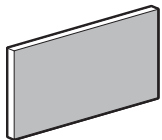

Tackboard

ZTB8216	82 x 0.62 x 15.5	8.2	2	<b>\$485</b>
---------	------------------	-----	---	--------------

For use on **Z84S36H** and **Z84S36HN** hutches. Includes mounting screws.

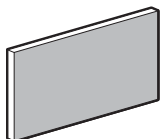

Tackboard

ZTB7016	70 x 0.62 x 15.5	7	1.3	<b>\$356</b>
---------	------------------	---	-----	--------------

For use on **Z72S36H** and **Z72S36HN** hutches. Includes mounting screws.

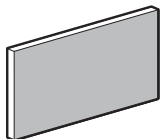

Tackboard

ZTB6916	69.5 x 0.62 x 15.5	7	1.3	<b>\$353</b>
---------	--------------------	---	-----	--------------

For use on **Z71S36H** and **Z71S36HN** hutches. Includes mounting screws.

Required specifications

Fabric



TACKBOARDS FOR HUTCHES - 36" HIGH		MODEL #	DIMENSIONS	WT/LB.	CUBIC FT.	LIST PRICE
		W x D x H				
	<b>Tackboard</b>	ZTB6416	64 x 0.62 x 15.5	6.4	1.3	<b>\$345</b>
For use on <b>Z66S36H</b> and <b>Z66S36HN</b> hutches. Includes mounting screws.						
	<b>Tackboard</b>	ZTB5816	58 x 0.62 x 15.5	5.8	1.08	<b>\$339</b>
For use on <b>Z60S36H</b> and <b>Z60S36HN</b> hutches. Includes mounting screws.						
	<b>Tackboard</b>	ZTB4616	46 x 0.62 x 15.5	4.6	0.85	<b>\$327</b>
For use on <b>Z48S36H</b> and <b>Z48S36HN</b> hutches. Includes mounting screws.						
	<b>Tackboard</b>	ZTB4016	40 x 0.62 x 15.5	4	0.85	<b>\$313</b>
For use on <b>Z42S36H</b> and <b>H42S36HN</b> hutch. Includes mounting screws.						
	<b>Tackboard</b>	ZTB3416	34 x 0.62 x 15.5	3.4	0.85	<b>\$206</b>
For use on <b>Z36S36H</b> and <b>H36S36HN</b> hutch. Includes mounting screws.						
	<b>Tackboard</b>	ZTB2816	28 x 0.62 x 15.5	2.8	0.85	<b>\$196</b>
For use on <b>Z30S36H</b> and <b>H30S36HN</b> hutch. Includes mounting screws.						

**Required specifications**  
Fabric

TACKBOARDS - 42.4" & 54.9" HIGH

MODEL # DIMENSIONS WT/LB. CUBIC FT. LIST PRICE

W x D x H

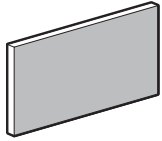

Tackboard

ZTB8221 82 x 0.62 x 21 12.8 2.3 \$594

For use on **Z84S42H, Z84S42HN, Z84S55H** and **Z84S55HN** hutches. Includes mounting screws.

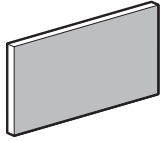

Tackboard

ZTB7021 70 x 0.62 x 21 11 1.5 \$422

For use on **Z72S42H, Z72S42HN, Z72S55H** and **Z72S55HN** hutches. Includes mounting screws.

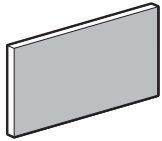

Tackboard

ZTB6921 69 x 0.62 x 21 10.7 1.5 \$418

For use on **Z71S42H, Z71S42HN, Z71S55H** and **Z71S55HN** hutches. Includes mounting screws.

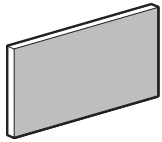

Tackboard

ZTB6421 64 x 0.62 x 21 10 1.5 \$409

For use on **Z66S42H, Z66S42HN, Z66S55H** and **Z66S55HN** hutches. Includes mounting screws.

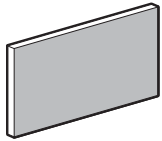

Tackboard

ZTB5821 58 x 0.62 x 21 9 1.5 \$399

For use on **Z60S42H, Z60S42HN, Z60S55H** and **Z60S55HN** hutches. Includes mounting screws.

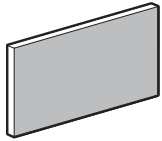

Tackboard

ZTB4621 46 x 0.62 x 21 7.2 1 \$387

For use on **Z48S42H, Z48S42HN, Z48S55H** and **Z48S55HN** hutches. Includes mounting screws.

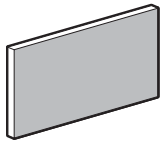

Tackboard

ZTB4021 40 x 0.62 x 21 6.2 1 \$372

For use on **Z42S42H, Z42S42HN, Z42S55H** and **Z42S55HN** hutches. Includes mounting screws.

Required specifications

Fabric

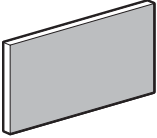
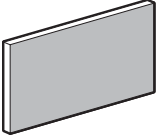
TACKBOARDS - 42.4" & 54.9" HIGH		MODEL #	DIMENSIONS	WT/LB.	CUBIC FT.	LIST PRICE
			W x D x H			
	<b>Tackboard</b>	ZTB3421	34 x 0.62 x 21	5.3	1	\$251
		For use on <b>Z36S42H, Z36S42HN, Z36S55H</b> and <b>Z36S55HN</b> hutches. Includes mounting screws.				
	<b>Tackboard</b>	ZTB2821	28 x 0.62 x 21	4.5	1	\$230
		For use on <b>Z30S42H, Z30S42HN, Z30S55H</b> and <b>Z30S55HN</b> hutches. Includes mounting screws.				

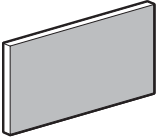
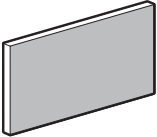
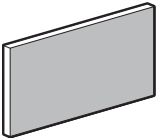
14" WALL MOUNTED TACKBOARDS						
	<b>Wall Mounted Tackboard</b>	ZWHT2414	24 x 1.25 x 14	3.7	1	\$226
		For use under <b>Z24S200S/OSN</b> for a finished height of <b>65.5"/66"</b> . Standard with pre-mounted "J" bracket for wall mount applications. <ul style="list-style-type: none"> <li><b>NOTE:</b> Care should be taken to mount the units. Units should be mounted to wall studs using correct fasteners. Mounting hardware not included. Mounting hardware used should be based on wall material. Consult an installation professional for proper wall mounting.</li> </ul>				
	<b>Wall Mounted Tackboard</b>	ZWHT3014	30 x 1.25 x 14	4.7	1	\$228
		For use under <b>Z30S200S/OSN</b> for a finished height of <b>65.5"/66"</b> . Standard with pre-mounted "J" bracket for wall mount applications. <ul style="list-style-type: none"> <li><b>NOTE:</b> Care should be taken to mount the units. Units should be mounted to wall studs using correct fasteners. Mounting hardware not included. Mounting hardware used should be based on wall material. Consult an installation professional for proper wall mounting.</li> </ul>				
	<b>Wall Mounted Tackboard</b>	ZWHT3614	36 x 1.25 x 14	5.6	1	\$261
		For use under <b>Z36S200S/OSN</b> for a finished height of <b>65.5"/66"</b> . Standard with pre-mounted "J" bracket for wall mount applications. <ul style="list-style-type: none"> <li><b>NOTE:</b> Care should be taken to mount the units. Units should be mounted to wall studs using correct fasteners. Mounting hardware not included. Mounting hardware used should be based on wall material. Consult an installation professional for proper wall mounting.</li> </ul>				

**Required specifications**  
Fabric

14" WALL MOUNTED TACKBOARDS

MODEL # DIMENSIONS WT/LB. CUBIC FT. LIST PRICE

W x D x H

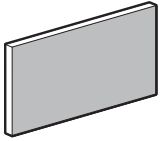

Wall Mounted Tackboard

ZWHT4214	42 x 1.25 x 14	6.5	1	<b>\$386</b>
----------	----------------	-----	---	--------------

For use under **Z42S200S/OSN** for a finished height of **65.5"/66"**. Standard with pre-mounted "J" bracket for wall mount applications.

- **NOTE:** Care should be taken to mount the units. Units should be mounted to wall studs using correct fasteners. Mounting hardware not included. Mounting hardware used should be based on wall material. Consult an installation professional for proper wall mounting.

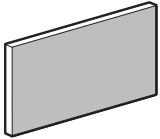

Wall Mounted Tackboard

ZWHT4814	48 x 1.25 x 14	7.5	1	<b>\$399</b>
----------	----------------	-----	---	--------------

For use under **Z48S200S/OSN** for a finished height of **65.5"/66"**. Standard with pre-mounted "J" bracket for wall mount applications.

- **NOTE:** Care should be taken to mount the units. Units should be mounted to wall studs using correct fasteners. Mounting hardware not included. Mounting hardware used should be based on wall material. Consult an installation professional for proper wall mounting.

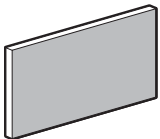

Wall Mounted Tackboard

ZWHT6014	60 x 1.25 x 14	9.3	1.8	<b>\$416</b>
----------	----------------	-----	-----	--------------

For use under **Z60S200S/OSN** for a finished height of **65.5"/66"**. Standard with pre-mounted "J" bracket for wall mount applications.

- **NOTE:** Care should be taken to mount the units. Units should be mounted to wall studs using correct fasteners. Mounting hardware not included. Mounting hardware used should be based on wall material. Consult an installation professional for proper wall mounting.

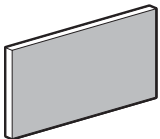

Wall Mounted Tackboard

ZWHT6614	66 x 1.25 x 14	10.3	1.8	<b>\$423</b>
----------	----------------	------	-----	--------------

For use under **ZxxS200S/OSN** for a finished height of **65.5"/66"**. Standard with pre-mounted "J" bracket for wall mount applications.

- **NOTE:** Care should be taken to mount the units. Units should be mounted to wall studs using correct fasteners. Mounting hardware not included. Mounting hardware used should be based on wall material. Consult an installation professional for proper wall mounting.

**Required specifications**

Fabric

**14" WALL MOUNTED TACKBOARDS**

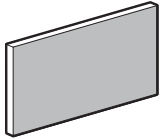

**Wall Mounted Tackboard**

MODEL #	DIMENSIONS W x D x H	WT/LB.	CUBIC FT.	LIST PRICE
ZWHT7214	72 x 1.25 x 14	11.2	1.8	<b>\$437</b>

For use under **ZxxS200S/OSN** for a finished height of **65.5"/66"**. Standard with pre-mounted "J" bracket for wall mount applications.

- **NOTE:** Care should be taken to mount the units. Units should be mounted to wall studs using correct fasteners. Mounting hardware not included. Mounting hardware used should be based on wall material. Consult an installation professional for proper wall mounting.

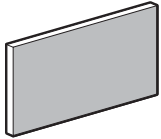

**Wall Mounted Tackboard**

ZWHT7814	78 x 1.25 x 14	12.1	1.8	<b>\$524</b>
----------	----------------	------	-----	--------------

For use under **ZxxS200S/OSN** for a finished height of **65.5"/66"**. Standard with pre-mounted "J" bracket for wall mount applications.

- **NOTE:** Care should be taken to mount the units. Units should be mounted to wall studs using correct fasteners. Mounting hardware not included. Mounting hardware used should be based on wall material. Consult an installation professional for proper wall mounting.

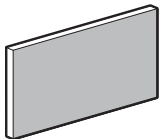

**Wall Mounted Tackboard**

ZWHT8414	84 x 1.25 x 14	13.1	1.8	<b>\$615</b>
----------	----------------	------	-----	--------------

For use under **ZxxS200S/OSN** for a finished height of **65.5"/66"**. Standard with pre-mounted "J" bracket for wall mount applications.

- **NOTE:** Care should be taken to mount the units. Units should be mounted to wall studs using correct fasteners. Mounting hardware not included. Mounting hardware used should be based on wall material. Consult an installation professional for proper wall mounting.

**18" WALL MOUNTED TACKBOARDS**

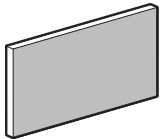

**Wall Mounted Tackboard**

ZWHT3018	30 x 1.25 x 18	6	1	<b>\$237</b>
----------	----------------	---	---	--------------

For use under **Z30S160S/OSN** for a finished height of **65.5"/66"**. Standard with pre-mounted "J" bracket for wall mount applications.

- **NOTE:** Care should be taken to mount the units. Units should be mounted to wall studs using correct fasteners. Failure to do so may result in collapse of the unit and subsequent personal injury. Mounting hardware not included. Mounting hardware used should be based on wall material. Consult an installation professional for proper wall mounting.

**Required specifications**  
Fabric

18" WALL MOUNTED TACKBOARDS

MODEL # DIMENSIONS WT/LB. CUBIC FT. LIST PRICE

W x D x H

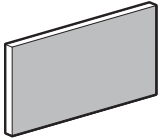

Wall Mounted Tackboard

ZWHT3618	36 x 1.25 x 18	7.2	1	<b>\$270</b>
----------	----------------	-----	---	--------------

For use under **Z36S160S/OSN** for a finished height of **65.5"/66"**. Standard with pre-mounted "J" bracket for wall mount applications.

- **NOTE:** Care should be taken to mount the units. Units should be mounted to wall studs using correct fasteners. Failure to do so may result in collapse of the unit and subsequent personal injury. Mounting hardware not included. Mounting hardware used should be based on wall material. Consult an installation professional for proper wall mounting.

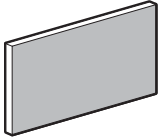

Wall Mounted Tackboard

ZWHT4218	42 x 1.25 x 18	8.4	1	<b>\$402</b>
----------	----------------	-----	---	--------------

For use under **Z42S160S/OSN** for a finished height of **65.5"/66"**. Standard with pre-mounted "J" bracket for wall mount applications.

- **NOTE:** Care should be taken to mount the units. Units should be mounted to wall studs using correct fasteners. Failure to do so may result in collapse of the unit and subsequent personal injury. Mounting hardware not included. Mounting hardware used should be based on wall material. Consult an installation professional for proper wall mounting.

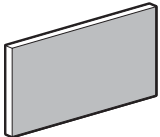

Wall Mounted Tackboard

ZWHT4818	48 x 1.25 x 18	9.6	1	<b>\$418</b>
----------	----------------	-----	---	--------------

For use under **Z48S160S/OSN** for a finished height of **65.5"/66"**. Standard with pre-mounted "J" bracket for wall mount applications.

- **NOTE:** Care should be taken to mount the units. Units should be mounted to wall studs using correct fasteners. Failure to do so may result in collapse of the unit and subsequent personal injury. Mounting hardware not included. Mounting hardware used should be based on wall material. Consult an installation professional for proper wall mounting.

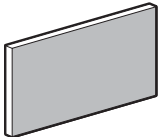

Wall Mounted Tackboard

ZWHT6018	60 x 1.25 x 18	12	1.8	<b>\$431</b>
----------	----------------	----	-----	--------------

For use under **Z60S160S/OSN** for a finished height of **65.5"/66"**. Standard with pre-mounted "J" bracket for wall mount applications.

- **NOTE:** Care should be taken to mount the units. Units should be mounted to wall studs using correct fasteners. Failure to do so may result in collapse of the unit and subsequent personal injury. Mounting hardware not included. Mounting hardware used should be based on wall material. Consult an installation professional for proper wall mounting.

Required specifications

Fabric

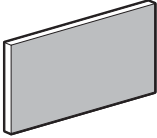
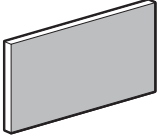
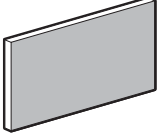
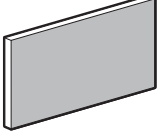
18" WALL MOUNTED TACKBOARDS	MODEL #	DIMENSIONS W x D x H	WT/LB.	CUBIC FT.	LIST PRICE
	ZWHT6618	66 x 1.25 x 18	13.2	1.8	\$441
<b>Wall Mounted Tackboard</b>	<p>For use under <b>ZxxS160S/OSN</b> for a finished height of <b>65.5"/66"</b>. Standard with pre-mounted "J" bracket for wall mount applications.</p> <ul style="list-style-type: none"> <li><b>NOTE:</b> Care should be taken to mount the units. Units should be mounted to wall studs using correct fasteners. Failure to do so may result in collapse of the unit and subsequent personal injury. Mounting hardware not included. Mounting hardware used should be based on wall material. Consult an installation professional for proper wall mounting.</li> </ul>				
	ZWHT7218	72 x 1.25 x 18	14.4	1.8	\$457
<b>Wall Mounted Tackboard</b>	<p>For use under <b>ZxxS160S/OSN</b> for a finished height of <b>65.5"/66"</b>. Standard with pre-mounted "J" bracket for wall mount applications.</p> <ul style="list-style-type: none"> <li><b>NOTE:</b> Care should be taken to mount the units. Units should be mounted to wall studs using correct fasteners. Failure to do so may result in collapse of the unit and subsequent personal injury. Mounting hardware not included. Mounting hardware used should be based on wall material. Consult an installation professional for proper wall mounting.</li> </ul>				
	ZWHT7818	78 x 1.25 x 18	15.6	1.8	\$546
<b>Wall Mounted Tackboard</b>	<p>For use under <b>ZxxS160S/OSN</b> for a finished height of <b>65.5"/66"</b>. Standard with pre-mounted "J" bracket for wall mount applications.</p> <ul style="list-style-type: none"> <li><b>NOTE:</b> Care should be taken to mount the units. Units should be mounted to wall studs using correct fasteners. Failure to do so may result in collapse of the unit and subsequent personal injury. Mounting hardware not included. Mounting hardware used should be based on wall material. Consult an installation professional for proper wall mounting.</li> </ul>				
	ZWHT8418	84 x 1.25 x 18	16.8	1.8	\$640
<b>Wall Mounted Tackboard</b>	<p>For use under <b>ZxxS160S/OSN</b> for a finished height of <b>65.5"/66"</b>. Standard with pre-mounted "J" bracket for wall mount applications.</p> <ul style="list-style-type: none"> <li><b>NOTE:</b> Care should be taken to mount the units. Units should be mounted to wall studs using correct fasteners. Failure to do so may result in collapse of the unit and subsequent personal injury. Mounting hardware not included. Mounting hardware used should be based on wall material. Consult an installation professional for proper wall mounting.</li> </ul>				

**Required specifications**  
Fabric

21" WALL MOUNTED TACKBOARDS      MODEL #      DIMENSIONS      WT/LB.      CUBIC FT.      LIST PRICE

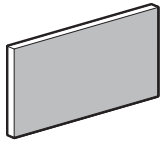

Wall Mounted Tackboard

W x D x H					
ZWHT2421	24 x 1.25 x 21	5.6	1		<b>\$232</b>

For use under **Z24S200S/OSN** or **Z24S330S/OSN** for a finished height of **72"/72.5"**. For use under **ZxxS330S/OSN** for a finished height of **84.5"/85"**. Standard with pre-mounted "J" bracket for wall mount applications.  
 • **NOTE:** Care should be taken to mount the units. Units should be mounted to wall studs using correct fasteners. Mounting hardware not included. Mounting hardware used should be based on wall material. Consult an installation professional for proper wall mounting.

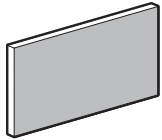

Wall Mounted Tackboard

ZWHT3021	30 x 1.25 x 21	7	1		<b>\$242</b>
----------	----------------	---	---	--	--------------

For use under **Z30S200S/OSN** or **Z30S330S/OSN** for a finished height of **72"/72.5"**. For use under **Z30S330S/OSN** for a finished height of **84.5"/85"**. Standard with pre-mounted "J" bracket for wall mount applications.  
 • **NOTE:** Care should be taken to mount the units. Units should be mounted to wall studs using correct fasteners. Mounting hardware not included. Mounting hardware used should be based on wall material. Consult an installation professional for proper wall mounting.

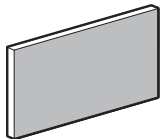

Wall Mounted Tackboard

ZWHT3621	36 x 1.25 x 21	8.4	1		<b>\$275</b>
----------	----------------	-----	---	--	--------------

For use under **Z36S200S/OSN** or **Z36S330S/OSN** for a finished height of **72"/72.5"**. For use under **Z30S330S/OSN** for a finished height of **84.5"/85"**. Standard with pre-mounted "J" bracket for wall mount applications.  
 • **NOTE:** Care should be taken to mount the units. Units should be mounted to wall studs using correct fasteners. Mounting hardware not included. Mounting hardware used should be based on wall material. Consult an installation professional for proper wall mounting.

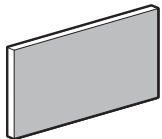

Wall Mounted Tackboard

ZWHT4221	42 x 1.25 x 21	9.8	1		<b>\$407</b>
----------	----------------	-----	---	--	--------------

For use under **Z42S200S/OSN** or **Z42S330S/OSN** for a finished height of **72"/72.5"**. For use under **Z30S330S/OSN** for a finished height of **84.5"/85"**. Standard with pre-mounted "J" bracket for wall mount applications.  
 • **NOTE:** Care should be taken to mount the units. Units should be mounted to wall studs using correct fasteners. Mounting hardware not included. Mounting hardware used should be based on wall material. Consult an installation professional for proper wall mounting.

**Required specifications**  
 Fabric

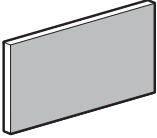
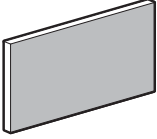
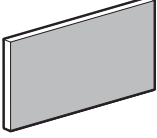
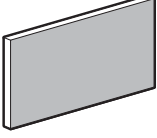

21" WALL MOUNTED TACKBOARDS	MODEL #	DIMENSIONS W x D x H	WT/LB.	CUBIC FT.	LIST PRICE
	ZWHT4821	48 x 1.25 x 21	11.2	1	\$425
<b>Wall Mounted Tackboard</b>	<p>For use under <b>Z48S160S/OSN</b> or <b>Z48S330S/OSN</b> for a finished height of <b>72"/72.5"</b>. For use under <b>Z30S330S/OSN</b> for a finished height of <b>84.5"/85"</b>. Standard with pre-mounted "J" bracket for wall mount applications.</p> <ul style="list-style-type: none"> <li>• <b>NOTE:</b> Care should be taken to mount the units. Units should be mounted to wall studs using correct fasteners. Mounting hardware not included. Mounting hardware used should be based on wall material. Consult an installation professional for proper wall mounting.</li> </ul>				
	ZWHT6021	60 x 1.25 x 21	14	1.8	\$441
<b>Wall Mounted Tackboard</b>	<p>For use under <b>Z60S200S/OSN</b> or <b>Z60S330S/OSN</b> for a finished height of <b>72"/72.5"</b>. For use under <b>Z30S330S/OSN</b> for a finished height of <b>84.5"/85"</b>. Standard with pre-mounted "J" bracket for wall mount applications.</p> <ul style="list-style-type: none"> <li>• <b>NOTE:</b> Care should be taken to mount the units. Units should be mounted to wall studs using correct fasteners. Mounting hardware not included. Mounting hardware used should be based on wall material. Consult an installation professional for proper wall mounting.</li> </ul>				
	ZWHT6621	66 x 1.25 x 21	15.4	1.8	\$449
<b>Wall Mounted Tackboard</b>	<p>For use under <b>ZxxS210S/OSN</b> or <b>ZxxS330S/OSN</b> for a finished height of <b>72"/72.5"</b>. For use under <b>Z30S330S/OSN</b> for a finished height of <b>84.5"/85"</b>. Standard with pre-mounted "J" bracket for wall mount applications.</p> <ul style="list-style-type: none"> <li>• <b>NOTE:</b> Care should be taken to mount the units. Units should be mounted to wall studs using correct fasteners. Mounting hardware not included. Mounting hardware used should be based on wall material. Consult an installation professional for proper wall mounting.</li> </ul>				
	ZWHT7221	72 x 1.25 x 21	16.8	1.8	\$465
<b>Wall Mounted Tackboard</b>	<p>For use under <b>ZxxS210S/OSN</b> or <b>ZxxS330S/OSN</b> for a finished height of <b>72"/72.5"</b>. For use under <b>Z30S330S/OSN</b> for a finished height of <b>84.5"/85"</b>. Standard with pre-mounted "J" bracket for wall mount applications.</p> <ul style="list-style-type: none"> <li>• <b>NOTE:</b> Care should be taken to mount the units. Units should be mounted to wall studs using correct fasteners. Mounting hardware not included. Mounting hardware used should be based on wall material. Consult an installation professional for proper wall mounting.</li> </ul>				

**Required specifications**  
Fabric

**21" WALL MOUNTED TACKBOARDS**

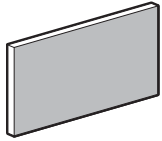

**Wall Mounted Tackboard**

MODEL #	DIMENSIONS W x D x H	WT/LB.	CUBIC FT.	LIST PRICE
ZWHT7821	78 x 1.25 x 21	18.2	1.8	<b>\$559</b>

For use under **ZxxS210S/OSN** or **ZxxS330S/OSN** for a finished height of **72"/72.5"**. For use under **Z30S330S/OSN** for a finished height of **84.5"/85"**. Standard with pre-mounted "J" bracket for wall mount applications.

- **NOTE:** Care should be taken to mount the units. Units should be mounted to wall studs using correct fasteners. Mounting hardware not included. Mounting hardware used should be based on wall material. Consult an installation professional for proper wall mounting.

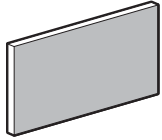

**Wall Mounted Tackboard**

ZWHT8421	84 x 1.25 x 21	19.6	1.8	<b>\$654</b>
----------	----------------	------	-----	--------------

For use under **ZxxS210S/OSN** or **ZxxS330S/OSN** for a finished height of **72"/72.5"**. For use under **Z30S330S/OSN** for a finished height of **84.5"/85"**. Standard with pre-mounted "J" bracket for wall mount applications.

- **NOTE:** Care should be taken to mount the units. Units should be mounted to wall studs using correct fasteners. Mounting hardware not included. Mounting hardware used should be based on wall material. Consult an installation professional for proper wall mounting.

**25" WALL MOUNTED TACKBOARDS**

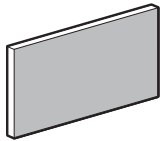

**Wall Mounted Tackboard**

ZWHT3025	30 x 1.25 x 25.5	8.3	1	<b>\$251</b>
----------	------------------	-----	---	--------------

For use under **Z30S160S/OSN** for a finished height of **72"/72.5"**. Standard with pre-mounted "J" bracket for wall mount applications.

- **NOTE:** Care should be taken to mount the units. Units should be mounted to wall studs using correct fasteners. Mounting hardware not included. Mounting hardware used should be based on wall material. Consult an installation professional for proper wall mounting.

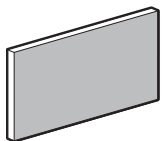

**Wall Mounted Tackboard**

ZWHT3625	36 x 1.25 x 25	10	1	<b>\$285</b>
----------	----------------	----	---	--------------

For use under **Z36S160S/OSN** for a finished height of **72"/72.5"**. Standard with pre-mounted "J" bracket for wall mount applications.

- **NOTE:** Care should be taken to mount the units. Units should be mounted to wall studs using correct fasteners. Mounting hardware not included. Mounting hardware used should be based on wall material. Consult an installation professional for proper wall mounting.

**Required specifications**  
Fabric

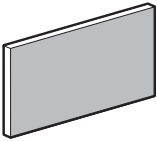
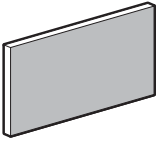
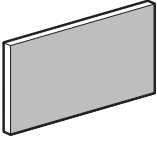
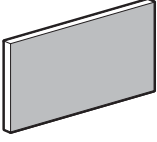
25" WALL MOUNTED TACKBOARDS	MODEL #	DIMENSIONS	WT/LB.	CUBIC FT.	LIST PRICE
 <p><b>Wall Mounted Tackboard</b></p>	ZWHT4225	42 x 1.25 x 25	11.7	1	<b>\$422</b>
	<p>For use under <b>Z42S160S/OSN</b> for a finished height of <b>72"/72.5"</b>. Standard with pre-mounted "J" bracket for wall mount applications.</p> <ul style="list-style-type: none"> <li><b>NOTE:</b> Care should be taken to mount the units. Units should be mounted to wall studs using correct fasteners. Mounting hardware not included. Mounting hardware used should be based on wall material. Consult an installation professional for proper wall mounting.</li> </ul>				
 <p><b>Wall Mounted Tackboard</b></p>	ZWHT4825	48 x 1.25 x 25	13.3	1	<b>\$439</b>
	<p>For use under <b>Z48S160S/OSN</b> for a finished height of <b>72"/72.5"</b>. Standard with pre-mounted "J" bracket for wall mount applications.</p> <ul style="list-style-type: none"> <li><b>NOTE:</b> Care should be taken to mount the units. Units should be mounted to wall studs using correct fasteners. Mounting hardware not included. Mounting hardware used should be based on wall material. Consult an installation professional for proper wall mounting.</li> </ul>				
 <p><b>Wall Mounted Tackboard</b></p>	ZWHT6025	60 x 1.25 x 25	16.7	1.8	<b>\$455</b>
	<p>For use under <b>Z60S160S/OSN</b> for a finished height of <b>72"/72.5"</b>. Standard with pre-mounted "J" bracket for wall mount applications.</p> <ul style="list-style-type: none"> <li><b>NOTE:</b> Care should be taken to mount the units. Units should be mounted to wall studs using correct fasteners. Mounting hardware not included. Mounting hardware used should be based on wall material. Consult an installation professional for proper wall mounting.</li> </ul>				
 <p><b>Wall Mounted Tackboard</b></p>	ZWHT6625	66 x 1.25 x 25	18.3	1.8	<b>\$464</b>
	<p>For use under <b>ZxxS160S/OSN</b> for a finished height of <b>72"/72.5"</b>. Standard with pre-mounted "J" bracket for wall mount applications.</p> <ul style="list-style-type: none"> <li><b>NOTE:</b> Care should be taken to mount the units. Units should be mounted to wall studs using correct fasteners. Mounting hardware not included. Mounting hardware used should be based on wall material. Consult an installation professional for proper wall mounting.</li> </ul>				

**Required specifications**  
Fabric

**25" WALL MOUNTED TACKBOARDS**      **MODEL #**      **DIMENSIONS**      **WT/LB.**      **CUBIC FT.**      **LIST PRICE**

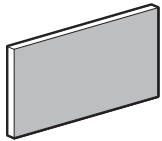

**Wall Mounted Tackboard**

	W x D x H			
ZWHT7225	72 x 1.25 x 25	20	1.8	<b>\$476</b>

For use under **ZxxS160S/OSN** for a finished height of **72"/72.5"**. Standard with pre-mounted "J" bracket for wall mount applications.  
 • **NOTE:** Care should be taken to mount the units. Units should be mounted to wall studs using correct fasteners. Mounting hardware not included. Mounting hardware used should be based on wall material. Consult an installation professional for proper wall mounting.

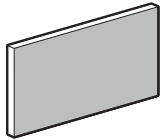

**Wall Mounted Tackboard**

ZWHT7825	78 x 1.25 x 25	21.7	1.8	<b>\$574</b>
----------	----------------	------	-----	--------------

For use under **ZxxS160S/OSN** for a finished height of **72"/72.5"**. Standard with pre-mounted "J" bracket for wall mount applications.  
 • **NOTE:** Care should be taken to mount the units. Units should be mounted to wall studs using correct fasteners. Mounting hardware not included. Mounting hardware used should be based on wall material. Consult an installation professional for proper wall mounting.

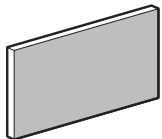

**Wall Mounted Tackboard**

ZWHT8425	84 x 1.25 x 25	23.3	1.8	<b>\$672</b>
----------	----------------	------	-----	--------------

For use under **ZxxS160S/OSN** for a finished height of **72"/72.5"**. Standard with pre-mounted "J" bracket for wall mount applications.  
 • **NOTE:** Care should be taken to mount the units. Units should be mounted to wall studs using correct fasteners. Mounting hardware not included. Mounting hardware used should be based on wall material. Consult an installation professional for proper wall mounting.

**BOOKCASES**      **MODEL #**      **DIMENSIONS**      **WT/LB.**      **CUBIC FT.**      **1" TOP**      **1.5" TOP**

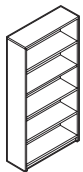

**Bookcase - 72"/72.5" High**

	W x D x H (1.5" TOP)				
ZHBC72	36 x 12 x 72.4	170	23	<b>\$1126</b>	<b>\$1187</b>

One fixed shelf and three adjustable shelves. Shipped assembled in 1 carton.

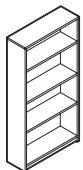

**Bookcase - 65.5"/66" High**

ZHBC65	36 x 12 x 66	150	21	<b>\$988</b>	<b>\$1049</b>
--------	--------------	-----	----	--------------	---------------

One fixed shelf and two adjustable shelves. Shipped assembled in 1 carton.

**Required specifications**  
 Fabric (only tackboards)  
 Finish  
 Top/edge detail (bookcases only)  
 Base finish

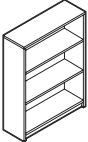
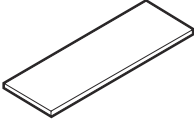
BOOKCASES	MODEL #	DIMENSIONS	WT/LB.	CUBIC FT.	1" TOP	1.5" TOP	GLAZE ADD	HP ADD
		<b>W x D x H (1.5" TOP)</b>						
	ZHBC48	36 x 12 x 49	116	15.75	<b>\$926</b>	<b>\$983</b>	N/A	N/A
<b>Bookcase - 48.5" / 49" High</b>	Two adjustable shelves. Shipped assembled in 1 carton.							
	ZHSHELF	34 x 11 x 1	13.41	1.5	<b>\$216</b>	N/A	N/A	N/A
<b>Bookcase Shelf</b>	Extra shelf for bookcases. 1" thick.							

**TABLE TOP BOOKCASES** **NOTE: UNITS UNDER 30"W MUST BE SECURELY FASTENED TO THE WALL OR GANGED TO AN ADJACENT UNIT 30"W OR WIDER**

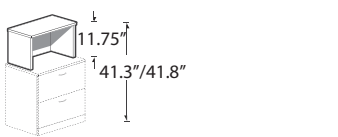

**Table Top Bookcase 11.75" High\***

Z36S12TN	36 x 16 x 11.75	45	5.25	<b>\$314</b>	<b>\$375</b>	N/A	<b>\$128</b>
Z30S12TN	30 x 16 x 11.75	39	4.3	<b>\$287</b>	<b>\$338</b>	N/A	<b>\$114</b>

To be placed **on top of 29.5"/30" high units to achieve 41.3"/41.8" final height** or placed on top of **41.3"/41.8" high units to achieve 53"/53.5" final height**. Shipped assembled in 1 carton.

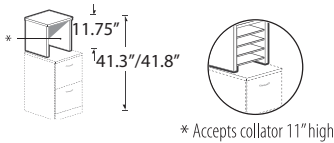

\* Accepts collator 11" high

**Table Top Bookcase 11.75" High\***

Z21S12TN	21 x 16 x 11.75	29	3.1	<b>\$239</b>	<b>\$278</b>	N/A	<b>\$87</b>
Z18S12TN	18 x 16 x 11.75	27	2.7	<b>\$227</b>	<b>\$261</b>	N/A	<b>\$69</b>
Z16S12TN	16 x 16 x 11.75	25	2.4	<b>\$218</b>	<b>\$252</b>	N/A	<b>\$69</b>
Z15S12TN	15 x 16 x 11.75	24	2.3	<b>\$209</b>	<b>\$238</b>	N/A	<b>\$69</b>
Z12S12TN	12 x 16 x 11.75	22	1.9	<b>\$197</b>	<b>\$221</b>	N/A	<b>\$57</b>

To be placed **on top of 29.5"/30" high units to achieve 41.3"/41.8" final height** or placed on top of **41.3"/41.8" high units to achieve 53"/53.5" final height**. Shipped assembled in 1 carton.

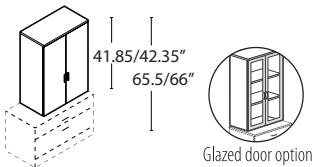

Glazed door option

**Closed Table Top Bookcase 41" High\*\***

Z36S41T	36 x 16 x 41.85	128	17.75	<b>\$1469</b>	<b>\$1544</b>	<b>\$1007</b>	N/A
Z30S41T	30 x 16 x 41.85	111	15	<b>\$1330</b>	<b>\$1373</b>	<b>\$898</b>	N/A

Designed to be placed **on top of 23.75"/24.25" high units to achieve 65.5"/66" final height**. Laminate doors are standard. **Includes one adjustable shelf**. Standard with lock. Shipped assembled in 1 carton.

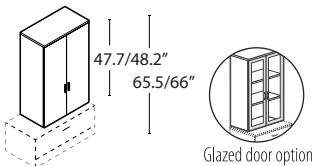

Glazed door option

**Closed Table Top Bookcase 47.7" High\*\***

Z36S48T	36 x 16 x 47.7	149	20.25	<b>\$1709</b>	<b>\$1784</b>	<b>\$1103</b>	N/A
Z30S48T	30 x 16 x 47.7	130	17	<b>\$1529</b>	<b>\$1591</b>	<b>\$986</b>	N/A

Designed to be placed **on top of 17.87"/18.37" high units to achieve 65.5"/66" final height**. Laminate doors are standard. **Includes one adjustable shelf**. Standard with lock. Shipped assembled in 1 carton.

**Required specifications**

Top finish	Handles**
Top thickness/edge detail	
Base finish	
Finish (only ZHSHELF)	

**Optional specifications**

HP laminate*
Key #**
Collator - position & finish (only ZxxS12TN)
Glazed doors**

TABLE TOP BOOKCASES

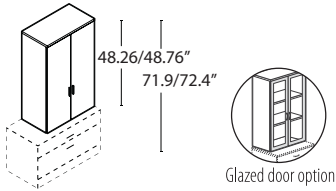

**Closed Table Top Bookcase 48" High**

MODEL #	DIMENSIONS W x D x H (1.5" TOP)	WT/LB.	CUBIC FT.	1" TOP	1.5" TOP	GLAZE ADD	HP ADD
Z36S49T	36 x 16 x 48.26	141	20.25	<b>\$1619</b>	<b>\$1694</b>	<b>\$1110</b>	N/A
Z30S49T	30 x 16 x 48.26	123	17.25	<b>\$1452</b>	<b>\$1514</b>	<b>\$990</b>	N/A

Designed to be placed **on top of 23.75"/24.25" high units to achieve 71.9"/72.4" final height.**  
Laminate doors are standard. **Includes one adjustable shelf.** Standard with lock. Shipped assembled in 1 carton.

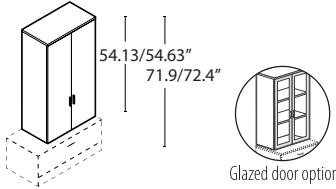

**Closed Table Top Bookcase 54" High**

Z36S54T	36 x 16 x 54.13	163	22.75	<b>\$1822</b>	<b>\$1897</b>	<b>\$1211</b>	N/A
Z30S54T	30 x 16 x 54.13	142	19	<b>\$1629</b>	<b>\$1691</b>	<b>\$1080</b>	N/A

Designed to be placed **on top of 17.87"/18.37" high units to achieve 71.9"/72.4" final height.**  
Laminate doors are standard. **Includes one adjustable shelf.** Standard with lock. Shipped assembled in 1 carton.

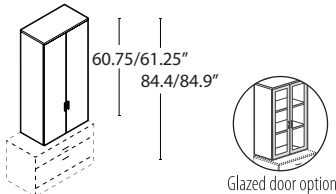

**Closed Table Top Bookcase 61" High**

Z36S61T	36 x 16 x 60.75	176	25.25	<b>\$1913</b>	<b>\$1988</b>	<b>\$1321</b>	N/A
Z30S61T	30 x 16 x 60.75	153	21.25	<b>\$1709</b>	<b>\$1771</b>	<b>\$1179</b>	N/A

Designed to be placed **on top of 23.75"/24.25" high units to achieve 84.4"/84.9" final height.**  
Laminate doors are standard. **Includes one adjustable shelf.** Standard with lock. Shipped assembled in 1 carton.

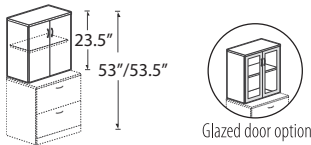

**Table Top Bookcase with Doors 23.5" High\***

Z36S23T	36 x 16 x 23.5	87	9.5	<b>\$758</b>	<b>\$819</b>	<b>\$754</b>	<b>\$128</b>
Z30S23T	30 x 16 x 23.5	76	8	<b>\$686</b>	<b>\$737</b>	<b>\$666</b>	<b>\$114</b>

Designed to be placed **on top of 29.5"/30" high units to achieve 53"/53.5" final height.** DO NOT USE ON TOP OF 41.3"/41.8" HIGH UNITS. Laminate doors are standard. **Includes one adjustable shelf.** Standard with lock. Shipped assembled in 1 carton.

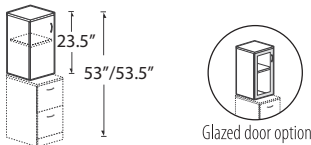

**Table Top Bookcase with Door 23.5" High - LEFT\***

Z21S23TL	21 x 16 x 23.5	59	5.75	<b>\$536</b>	<b>\$575</b>	<b>\$408</b>	<b>\$87</b>
Z18S23TL	18 x 16 x 23.5	55	5	<b>\$518</b>	<b>\$552</b>	<b>\$373</b>	<b>\$69</b>
Z16S23TL	16 x 16 x 23.5	47	4.5	<b>\$458</b>	<b>\$492</b>	<b>\$365</b>	<b>\$69</b>
Z15S23TL	15 x 16 x 23.5	46	4.2	<b>\$436</b>	<b>\$465</b>	<b>\$326</b>	<b>\$69</b>
Z12S23TL	12 x 16 x 23.5	41	3.5	<b>\$405</b>	<b>\$429</b>	<b>\$295</b>	<b>\$57</b>

Designed to be placed **on top of 29.5"/30" high units to achieve 53"/53.5" final height.** DO NOT USE ON TOP OF 41.3"/41.8" HIGH UNITS. Laminate door is standard. **Includes one adjustable shelf.** Standard with lock. Shipped assembled in 1 carton.

**Required specifications**

Top finish  
Top thickness/edge detail  
Base finish  
Handles

**Optional specifications**

HP laminate\*  
Key #  
Glazed doors

TABLE TOP BOOKCASES	MODEL #	DIMENSIONS	WT/LB.	CUBIC FT.	1" TOP	1.5" TOP	GLAZE ADD	HP ADD
---------------------	---------	------------	--------	-----------	--------	----------	-----------	--------

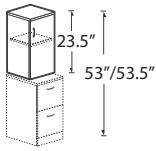

**Table Top Bookcase with Door 23.5" High - RIGHT\***

	W x D x H (1.5" TOP)							
Z21S23TR	21 x 16 x 23.5	59	5.75	<b>\$536</b>	<b>\$575</b>	<b>\$408</b>	<b>\$87</b>	
Z18S23TR	18 x 16 x 23.5	55	5	<b>\$518</b>	<b>\$552</b>	<b>\$373</b>	<b>\$69</b>	
Z16S23TR	16 x 16 x 23.5	47	4.5	<b>\$458</b>	<b>\$492</b>	<b>\$365</b>	<b>\$69</b>	
Z15S23TR	15 x 16 x 23.5	46	4.2	<b>\$436</b>	<b>\$465</b>	<b>\$326</b>	<b>\$69</b>	
Z12S23TR	12 x 16 x 23.5	41	3.5	<b>\$405</b>	<b>\$429</b>	<b>\$295</b>	<b>\$57</b>	

Designed to be placed **on top of 29.5"/30" high units to achieve 53"/53.5" final height.** DO NOT USE ON TOP OF 41.3"/41.8" HIGH UNITS. Laminate door is standard. **Includes one adjustable shelf.** Standard with lock. Shipped assembled in 1 carton.

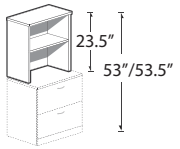

**Table Top Bookcase 23.5" High**

Z36S23TN	36 x 16 x 23.5	69	9.5	<b>\$491</b>	<b>\$552</b>	N/A	<b>\$128</b>
Z30S23TN	30 x 16 x 23.5	60	8	<b>\$452</b>	<b>\$503</b>	N/A	<b>\$114</b>

Designed to be placed **on top of 29.5"/30" high units to achieve 53"/53.5" final height.** DO NOT USE ON TOP OF 41.3"/41.8" HIGH UNITS. **Includes one adjustable shelf.** Shipped assembled in 1 carton.

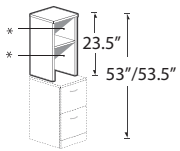

**Table Top Bookcase 23.5" High\*\***

Z21S23TN	21 x 16 x 23.5	48	5.75	<b>\$386</b>	<b>\$425</b>	N/A	<b>\$87</b>
Z18S23TN	18 x 16 x 23.5	45	5	<b>\$378</b>	<b>\$412</b>	N/A	<b>\$69</b>
Z16S23TN	16 x 16 x 23.5	38	4.5	<b>\$319</b>	<b>\$353</b>	N/A	<b>\$69</b>
Z15S23TN	15 x 16 x 23.5	37	4.2	<b>\$309</b>	<b>\$338</b>	N/A	<b>\$69</b>
Z12S23TN	12 x 16 x 23.5	34	3.5	<b>\$287</b>	<b>\$311</b>	N/A	<b>\$57</b>

Designed to be placed **on top of 29.5"/30" high units to achieve 53"/53.5" final height.** DO NOT USE ON TOP OF 41.3"/41.8" HIGH UNITS. **Includes one adjustable shelf.** Shipped assembled in 1 carton.

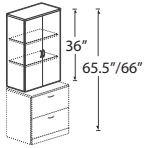

**Table Top Bookcase with Doors 36" High\***

Z36S36T	36 x 16 x 36	124	14.25	<b>\$974</b>	<b>\$1035</b>	<b>\$972</b>	N/A
Z30S36T	30 x 16 x 36	107	12	<b>\$844</b>	<b>\$895</b>	<b>\$851</b>	N/A

Designed to be placed **on top of 29.5"/30" high units to achieve 65.5"/66" final height.** Laminate doors are standard. **Includes two adjustable shelves.** Standard with lock. Shipped assembled in 1 carton.

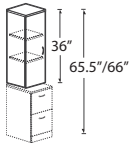

**Table Top Bookcase with Doors 36" High - LEFT\***

Z21S36TL	21 x 16 x 36	83	8.75	<b>\$686</b>	<b>\$725</b>	<b>\$530</b>	N/A
Z18S36TL	18 x 16 x 36	75	7.5	<b>\$659</b>	<b>\$693</b>	<b>\$480</b>	N/A
Z16S36TL	16 x 16 x 36	68	6.75	<b>\$601</b>	<b>\$635</b>	<b>\$473</b>	N/A
Z15S36TL	15 x 16 x 36	66	6.5	<b>\$571</b>	<b>\$600</b>	<b>\$420</b>	N/A
Z12S36TL	12 x 16 x 36	59	5.25	<b>\$532</b>	<b>\$556</b>	<b>\$380</b>	N/A

Designed to be placed **on top of 29.5"/30" high units to achieve 65.5"/66" final height.** Laminate door is standard. **Includes two adjustable shelves.** Standard with lock. Shipped assembled in 1 carton.

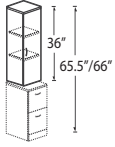

**Table Top Bookcase with Doors 36" High - RIGHT\***

Z21S36TR	21 x 16 x 36	83	8.75	<b>\$686</b>	<b>\$725</b>	<b>\$530</b>	N/A
Z18S36TR	18 x 16 x 36	75	7.5	<b>\$659</b>	<b>\$693</b>	<b>\$480</b>	N/A
Z16S36TR	16 x 16 x 36	68	6.75	<b>\$601</b>	<b>\$635</b>	<b>\$473</b>	N/A
Z15S36TR	15 x 16 x 36	66	6.5	<b>\$571</b>	<b>\$600</b>	<b>\$420</b>	N/A
Z12S36TR	12 x 16 x 36	59	5.25	<b>\$532</b>	<b>\$556</b>	<b>\$380</b>	N/A

Designed to be placed **on top of 29.5"/30" high units to achieve 65.5"/66" final height.** Laminate door is standard. **Includes two adjustable shelves.** Standard with lock. Shipped assembled in 1 carton.

**Required specifications**  
 Top finish  
 Top thickness/edge detail  
 Base finish  
 Handles\*

**Optional specifications**  
 HP laminate (only ZxxS23TR and ZxxS23TN)  
 Key #\*  
 Collator - position & finish\*\*  
 Glazed door\*

**TABLE TOP BOOKCASES**      **MODEL #**      **DIMENSIONS**      **WT/LB.**      **CUBIC FT.**      **1" TOP**      **1.5" TOP**      **GLAZE ADD**      **HP ADD**

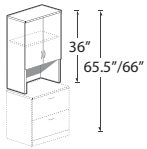

Glazed door option

**Table Top Bookcase with Doors and Cavity - 36" High\***

Designed to be placed **on top of 29.5"/30" high units to achieve 65.5"/66" final height.** Laminate doors are standard. **Includes one adjustable shelf.** Standard with lock. Shipped assembled in 1 carton.

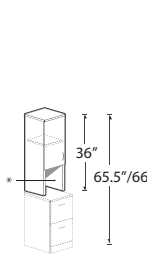

\* Accepts collator 11"high



Glazed door option

**Table Top Bookcase with Doors and Cavity - 36" High - LEFT\***

Designed to be placed **on top of 29.5"/30" high units to achieve 65.5"/66" final height.** Laminate door is standard. **Includes one adjustable shelf.** Standard with lock. Shipped assembled in 1 carton.

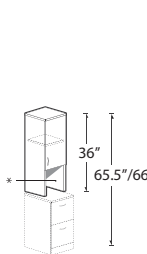

\* Accepts collator 11"high



Glazed door option

**Table Top Bookcase with Doors and Cavity - 36" High - RIGHT\***

Designed to be placed **on top of 29.5"/30" high units to achieve 65.5"/66" final height.** Laminate door is standard. **Includes one adjustable shelf.** Standard with lock. Shipped assembled in 1 carton.

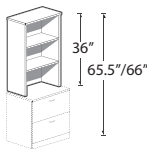

**Table Top Bookcase 36" High**

Designed to be placed **on top of 29.5"/30" high units to achieve 65.5"/66" final height.** **Includes two adjustable shelves.** Shipped assembled in 1 carton.

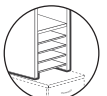
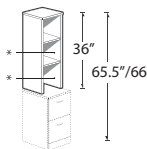

\* Accepts collator 11"high

**Table Top Bookcase 36" High**

Designed to be placed **on top of 29.5"/30" high units to achieve 65.5"/66" final height.** **Includes two adjustable shelves.** Shipped assembled in 1 carton.

MODEL #	DIMENSIONS	WT/LB.	CUBIC FT.	1" TOP	1.5" TOP	GLAZE ADD	HP ADD
<b>W x D x H (1.5" TOP)</b>							
Z36S36TC	36 x 16 x 36	117	14.25	<b>\$920</b>	<b>\$981</b>	<b>\$860</b>	N/A
Z30S36TC	30 x 16 x 36	101	12	<b>\$798</b>	<b>\$849</b>	<b>\$747</b>	N/A

Z21S36TCL	21 x 16 x 36	79	8.75	<b>\$656</b>	<b>\$695</b>	<b>\$473</b>	N/A
Z18S36TCL	18 x 16 x 36	71	7.5	<b>\$631</b>	<b>\$665</b>	<b>\$428</b>	N/A
Z16S36TCL	16 x 16 x 36	65	6.75	<b>\$573</b>	<b>\$607</b>	<b>\$420</b>	N/A
Z15S36TCL	15 x 16 x 36	63	6.5	<b>\$549</b>	<b>\$578</b>	<b>\$373</b>	N/A
Z12S36TCL	12 x 16 x 36	57	5.25	<b>\$512</b>	<b>\$536</b>	<b>\$332</b>	N/A

Z21S36TCR	21 x 16 x 36	79	8.75	<b>\$656</b>	<b>\$695</b>	<b>\$473</b>	N/A
Z18S36TCR	18 x 16 x 36	71	7.5	<b>\$631</b>	<b>\$665</b>	<b>\$428</b>	N/A
Z16S36TCR	16 x 16 x 36	65	6.75	<b>\$573</b>	<b>\$607</b>	<b>\$420</b>	N/A
Z15S36TCR	15 x 16 x 36	63	6.5	<b>\$549</b>	<b>\$578</b>	<b>\$373</b>	N/A
Z12S36TCR	12 x 16 x 36	57	5.25	<b>\$512</b>	<b>\$536</b>	<b>\$332</b>	N/A

Z36S36TN	36 x 16 x 36	95	14.25	<b>\$653</b>	<b>\$714</b>	N/A	N/A
Z30S36TN	30 x 16 x 36	82	12	<b>\$558</b>	<b>\$609</b>	N/A	N/A

Z21S36TN	21 x 16 x 36	66	8.75	<b>\$505</b>	<b>\$544</b>	N/A	N/A
Z18S36TN	18 x 16 x 36	60	7.5	<b>\$488</b>	<b>\$522</b>	N/A	N/A
Z16S36TN	16 x 16 x 36	56	6.75	<b>\$435</b>	<b>\$469</b>	N/A	N/A
Z15S36TN	15 x 16 x 36	54	6.5	<b>\$421</b>	<b>\$450</b>	N/A	N/A
Z12S36TN	12 x 16 x 36	49	6.25	<b>\$389</b>	<b>\$413</b>	N/A	N/A

**Required specifications**

- Top finish
- Top thickness/edge detail
- Base finish
- Handles\*

**Optional specifications**

- Key #\*
- Glazed door\*
- Collator - position & finish (not Z3xS36TC or Z3xS36TN)



**TABLE TOP BOOKCASES**      **MODEL #**      **DIMENSIONS**      **WT/LB.**      **CUBIC FT.**      **1" TOP**      **1.5" TOP**      **GLAZE ADD**      **HP ADD**

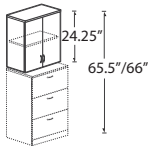

**Table Top Bookcase with Doors**  
**24.25"/24.75" High\***

Designed to be placed **on top of 41.3"/41.8" high units to achieve 65.5"/66" final height.** DO NOT USE ON TOP OF 29.5"/30" HIGH UNITS. Laminate doors are standard. **Includes one adjustable shelf.** Standard with lock. Shipped assembled in 1 carton.

	W x D x H (1.5" TOP)							
Z36S24T	36 x 16 x 24.25	89	10	<b>\$759</b>	<b>\$820</b>	<b>\$860</b>	N/A	
Z30S24T	30 x 16 x 24.25	77	8.25	<b>\$692</b>	<b>\$743</b>	<b>\$747</b>	N/A	

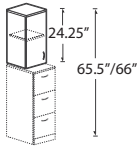

**Table Top Bookcase with Door**  
**24.25"/24.75" High - LEFT\***

Designed to be placed **on top of 41.3"/41.8" high units to achieve 65.5"/66" final height.** DO NOT USE ON TOP OF 29.5"/30" HIGH UNITS. Laminate door is standard. **Includes one adjustable shelf.** Standard with lock. Shipped assembled in 1 carton.

Z21S24TL	21 x 16 x 24.25	59	6	<b>\$539</b>	<b>\$578</b>	<b>\$473</b>	N/A	
Z18S24TL	18 x 16 x 24.25	56	5.25	<b>\$519</b>	<b>\$553</b>	<b>\$428</b>	N/A	
Z16S24TL	16 x 16 x 24.25	48	4.6	<b>\$459</b>	<b>\$493</b>	<b>\$420</b>	N/A	
Z15S24TL	15 x 16 x 24.25	46	4.3	<b>\$437</b>	<b>\$466</b>	<b>\$373</b>	N/A	
Z12S24TL	12 x 16 x 24.25	44	3.6	<b>\$406</b>	<b>\$430</b>	<b>\$332</b>	N/A	

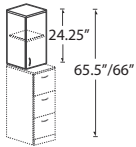

**Table Top Bookcase with Door**  
**24.25"/24.75" High - RIGHT\***

Designed to be placed **on top of 41.3"/41.8" high units to achieve 65.5"/66" final height.** DO NOT USE ON TOP OF 29.5"/30" HIGH UNITS. Laminate door is standard. **Includes one adjustable shelf.** Standard with lock. Shipped assembled in 1 carton.

Z21S24TR	21 x 16 x 24.25	59	6	<b>\$539</b>	<b>\$578</b>	<b>\$473</b>	N/A	
Z18S24TR	18 x 16 x 24.25	56	5.25	<b>\$519</b>	<b>\$553</b>	<b>\$428</b>	N/A	
Z16S24TR	16 x 16 x 24.25	48	4.6	<b>\$459</b>	<b>\$493</b>	<b>\$420</b>	N/A	
Z15S24TR	15 x 16 x 24.25	46	4.3	<b>\$437</b>	<b>\$466</b>	<b>\$373</b>	N/A	
Z12S24TR	12 x 16 x 24.25	44	3.6	<b>\$406</b>	<b>\$430</b>	<b>\$332</b>	N/A	

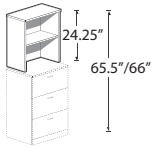

**Table Top Bookcase**  
**24.25"/24.75" High**

Designed to be placed **on top of 41.3"/41.8" high units to achieve 65.5"/66" final height.** DO NOT USE ON TOP OF 29.5"/30" HIGH UNITS. **Includes one adjustable shelf.** Shipped assembled in 1 carton.

Z36S24TN	36 x 16 x 24.25	70	10	<b>\$492</b>	<b>\$553</b>	N/A	N/A	
Z30S24TN	30 x 16 x 24.25	61	8.25	<b>\$452</b>	<b>\$503</b>	N/A	N/A	

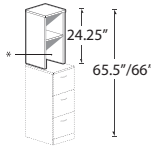

\* Accepts collator 11" high

**Table Top Bookcase**  
**24.25"/24.75" High\*\***

Designed to be placed **on top of 41.3"/41.8" high units to achieve 65.5"/66" final height.** DO NOT USE ON TOP OF 29.5"/30" HIGH UNITS. **Includes one adjustable shelf.** Shipped assembled in 1 carton.

**Required specifications**

- Top finish
- Top thickness/edge detail
- Base finish
- Handles\*

**Optional specifications**

- Key #\*
- Collator - position & finish\*\*
- Glazed door\*

TABLE TOP BOOKCASES

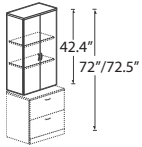

Glazed door option

Table Top Bookcase with Doors  
42.4" High

MODEL #	DIMENSIONS W x D x H (1.5" TOP)	WT/LB.	CUBIC FT.	1" TOP	1.5" TOP	GLAZE ADD	HP ADD
Z36S42T	36 x 16 x 42.4	137	16.75	<b>\$1062</b>	<b>\$1123</b>	<b>\$1194</b>	N/A
Z30S42T	30 x 16 x 42.4	119	14	<b>\$928</b>	<b>\$979</b>	<b>\$1038</b>	N/A

Designed to be placed **on top of 29.5"/30" high units to achieve 72"/72.5" final height.** DO NOT USE ON TOP OF 41.3"/41.8" HIGH UNITS. Laminate doors are standard. **Includes two adjustable shelves.** Standard with lock. Shipped assembled in 1 carton.

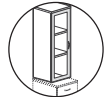
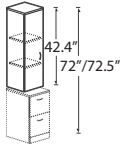

Glazed door option

Table Top Bookcase with Door  
42.4" High - LEFT

Z21S42TL	21 x 16 x 42.4	119	10	<b>\$752</b>	<b>\$791</b>	<b>\$659</b>	N/A
Z18S42TL	18 x 16 x 42.4	117	8.75	<b>\$721</b>	<b>\$755</b>	<b>\$593</b>	N/A
Z16S42TL	16 x 16 x 42.4	112	8	<b>\$648</b>	<b>\$682</b>	<b>\$585</b>	N/A
Z15S42TL	15 x 16 x 42.4	109	7.5	<b>\$616</b>	<b>\$645</b>	<b>\$515</b>	N/A
Z12S42TL	12 x 16 x 42.4	105	6	<b>\$571</b>	<b>\$595</b>	<b>\$464</b>	N/A

Designed to be placed **on top of 29.5"/30" high units to achieve 72"/72.5" final height.** DO NOT USE ON TOP OF 41.3"/41.8" HIGH UNITS. Laminate door is standard. **Includes two adjustable shelves.** Standard with lock. Shipped assembled in 1 carton.

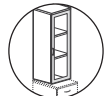
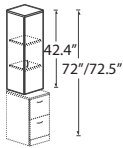

Glazed door option

Table Top Bookcase with Door  
42.4" High - RIGHT

Z21S42TR	21 x 16 x 42.4	119	10	<b>\$752</b>	<b>\$791</b>	<b>\$659</b>	N/A
Z18S42TR	18 x 16 x 42.4	117	8.75	<b>\$721</b>	<b>\$755</b>	<b>\$593</b>	N/A
Z16S42TR	16 x 16 x 42.4	112	8	<b>\$648</b>	<b>\$682</b>	<b>\$585</b>	N/A
Z15S42TR	15 x 16 x 42.4	109	7.5	<b>\$616</b>	<b>\$645</b>	<b>\$515</b>	N/A
Z12S42TR	12 x 16 x 42.4	105	6	<b>\$571</b>	<b>\$595</b>	<b>\$464</b>	N/A

Designed to be placed **on top of 29.5"/30" high units to achieve 72"/72.5" final height.** DO NOT USE ON TOP OF 41.3"/41.8" HIGH UNITS. Laminate door is standard. **Includes two adjustable shelves.** Standard with lock. Shipped assembled in 1 carton.

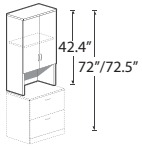

Glazed door option

Table Top Bookcase with Doors and  
Cavity 42.4" High

Z36S42TC	36 x 16 x 42.4	130	16.75	<b>\$1030</b>	<b>\$1091</b>	<b>\$938</b>	N/A
Z30S42TC	30 x 16 x 42.4	113	14	<b>\$898</b>	<b>\$949</b>	<b>\$817</b>	N/A

Designed to be placed **on top of 29.5"/30" high units to achieve 72"/72.5" final height.** DO NOT USE ON TOP OF 41.3"/41.8" HIGH UNITS. Laminate doors are standard. **Includes one adjustable shelf.** Standard with lock. Shipped assembled in 1 carton.



\* Accepts collator 11" high

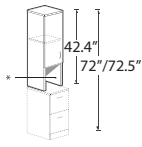

Glazed door option

Table Top Bookcase with Door and  
Cavity 42.4" High - LEFT\*

Z21S42TCL	21 x 16 x 42.4	88	10	<b>\$733</b>	<b>\$772</b>	<b>\$520</b>	N/A
Z18S42TCL	18 x 16 x 42.4	80	8.75	<b>\$705</b>	<b>\$739</b>	<b>\$468</b>	N/A
Z16S42TCL	16 x 16 x 42.4	74	8	<b>\$631</b>	<b>\$665</b>	<b>\$463</b>	N/A
Z15S42TCL	15 x 16 x 42.4	71	7.5	<b>\$601</b>	<b>\$630</b>	<b>\$406</b>	N/A
Z12S42TCL	12 x 16 x 42.4	63	6	<b>\$560</b>	<b>\$584</b>	<b>\$365</b>	N/A

Designed to be placed **on top of 29.5"/30" high units to achieve 72"/72.5" final height.** DO NOT USE ON TOP OF 41.3"/41.8" HIGH UNITS. Laminate door is standard. **Includes one adjustable shelf.** Standard with lock. Shipped assembled in 1 carton.

Required specifications

Top finish  
Top thickness/edge detail  
Base finish  
Handles

Optional specifications

Key #  
Glazed door  
Collator - position & finish\*

TABLE TOP BOOKCASES	MODEL #	DIMENSIONS	WT/LB.	CUBIC FT.	1" TOP	1.5" TOP	GLAZE ADD	HP ADD
---------------------	---------	------------	--------	-----------	--------	----------	-----------	--------

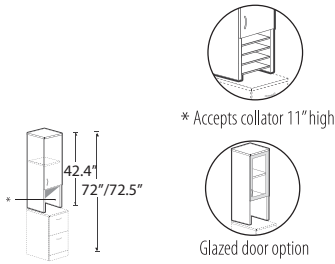

**Table Top Bookcase with Door and Cavity 42.4" High - RIGHT\***

	W x D x H (1.5" TOP)							
Z21S42TCR	21 x 16 x 42.4		88	10	<b>\$733</b>	<b>\$772</b>	<b>\$520</b>	N/A
Z18S42TCR	18 x 16 x 42.4		80	8.75	<b>\$705</b>	<b>\$739</b>	<b>\$468</b>	N/A
Z16S42TCR	16 x 16 x 42.4		74	8	<b>\$631</b>	<b>\$665</b>	<b>\$463</b>	N/A
Z15S42TCR	15 x 16 x 42.4		71	7.5	<b>\$601</b>	<b>\$630</b>	<b>\$406</b>	N/A
Z12S42TCR	12 x 16 x 42.4		63	6	<b>\$560</b>	<b>\$584</b>	<b>\$365</b>	N/A

Designed to be placed **on top of 29.5"/30" high units to achieve 72"/72.5" final height.** DO NOT USE ON TOP OF 41.3"/41.8" HIGH UNITS. Laminate door is standard. **Includes one adjustable shelf.** Standard with lock. Shipped assembled in 1 carton.

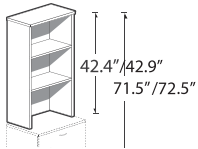

**Table Top Bookcase 42.4" High**

Z36S42TN	36 x 16 x 42.4		104	16.75	<b>\$712</b>	<b>\$773</b>	N/A	N/A
Z30S42TN	30 x 16 x 42.4		91	14	<b>\$616</b>	<b>\$667</b>	N/A	N/A

Designed to be placed **on top of 29.5"/30" high units to achieve 72"/72.5" final height.** DO NOT USE ON TOP OF 41.3"/41.8" HIGH UNITS. **Includes two adjustable shelves.** Standard with lock. Shipped assembled in 1 carton.

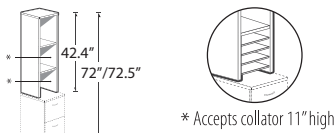

**Table Top Bookcase 42.4" High**

Z21S42TN	21 x 16 x 42.4		72	10	<b>\$550</b>	<b>\$589</b>	N/A	N/A
Z18S42TN	18 x 16 x 42.4		66	8.75	<b>\$536</b>	<b>\$570</b>	N/A	N/A
Z16S42TN	16 x 16 x 42.4		61	8	<b>\$464</b>	<b>\$498</b>	N/A	N/A
Z15S42TN	15 x 16 x 42.4		59	7.5	<b>\$454</b>	<b>\$483</b>	N/A	N/A
Z12S42TN	12 x 16 x 42.4		53	6	<b>\$422</b>	<b>\$446</b>	N/A	N/A

Designed to be placed **on top of 29.5"/30" high units to achieve 72"/72.5" final height.** DO NOT USE ON TOP OF 41.3"/41.8" HIGH UNITS. **Includes two adjustable shelves.** Standard with lock. Shipped assembled in 1 carton.

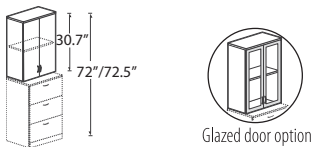

**Table Top Bookcase with Doors 30.7" High\***

Z36S31T	36 x 16 x 30.7		104	12.25	<b>\$835</b>	<b>\$896</b>	<b>\$938</b>	N/A
Z30S31T	30 x 16 x 30.7		89	10.5	<b>\$750</b>	<b>\$801</b>	<b>\$817</b>	N/A

Designed to be placed **on top of 41.3"/41.8" high units to achieve 72"/72.5" final height.** Laminate doors are standard. **Includes one adjustable shelf.** Standard with lock. Shipped assembled in 1 carton.



**Table Top Bookcase with Door 30.7" High - LEFT\***

Z21S31TL	21 x 16 x 30.7		70	7.5	<b>\$596</b>	<b>\$635</b>	<b>\$520</b>	N/A
Z18S31TL	18 x 16 x 30.7		65	6.5	<b>\$547</b>	<b>\$581</b>	<b>\$468</b>	N/A
Z16S31TL	16 x 16 x 30.7		59	5.75	<b>\$519</b>	<b>\$553</b>	<b>\$463</b>	N/A
Z15S31TL	15 x 16 x 30.7		56	5.5	<b>\$492</b>	<b>\$521</b>	<b>\$406</b>	N/A
Z12S31TL	12 x 16 x 30.7		50	4.4	<b>\$461</b>	<b>\$485</b>	<b>\$365</b>	N/A

Designed to be placed **on top of 41.3"/41.8" high units to achieve 72"/72.5" final height.** Laminate door is standard. **Includes one adjustable shelf.** Standard with lock. Shipped assembled in 1 carton.

**Required specifications**

- Top finish
- Top thickness/edge detail
- Base finish
- Handles\*

**Optional specifications**

- Key #\*
- Glazed door\*
- Collator - position & finish (only ZxxS42TCR and ZxxS42TN)

TABLE TOP BOOKCASES

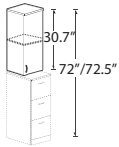

Table Top Bookcase with Door  
30.7" High - RIGHT\*

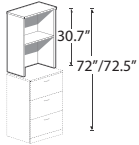

Table Top Bookcase  
30.7" High

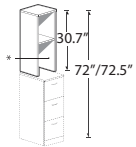

Table Top Bookcase  
30.7" High

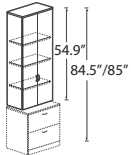

Table Top Bookcase with Doors  
54.9" High\*

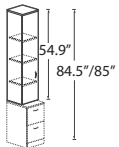

Table Top Bookcase with Door  
54.9" High - LEFT\*

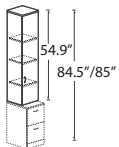

Table Top Bookcase with Door  
54.9" High - RIGHT\*

MODEL #	DIMENSIONS W x D x H (1.5" TOP)	WT/LB.	CUBIC FT.	1" TOP	1.5" TOP	GLAZE ADD	HP ADD
Z21S31TR	21 x 16 x 30.7	70	7.5	\$596	\$635	\$520	N/A
Z18S31TR	18 x 16 x 30.7	65	6.5	\$547	\$581	\$468	N/A
Z16S31TR	16 x 16 x 30.7	59	5.75	\$519	\$553	\$463	N/A
Z15S31TR	15 x 16 x 30.7	56	5.5	\$492	\$521	\$406	N/A
Z12S31TR	12 x 16 x 30.7	50	4.4	\$461	\$485	\$365	N/A

Designed to be placed on top of 41.3"/41.8" high units to achieve 72"/72.5" final height. Laminate door is standard. Includes one adjustable shelf. Standard with lock. Shipped assembled in 1 carton.

Z36S31TN	36 x 16 x 30.7	80	12.25	\$542	\$603	N/A	N/A
Z30S31TN	30 x 16 x 30.7	69	10.5	\$486	\$537	N/A	N/A

Designed to be placed on top of 41.3"/41.8" high units to achieve 72"/72.5" final height. Includes one adjustable shelf. Shipped assembled in 1 carton.

Z21S31TN	21 x 16 x 30.7	55	7.5	\$427	\$466	N/A	N/A
Z18S31TN	18 x 16 x 30.7	52	6.5	\$388	\$422	N/A	N/A
Z16S31TN	16 x 16 x 30.7	48	5.75	\$369	\$403	N/A	N/A
Z15S31TN	15 x 16 x 30.7	45	5.5	\$352	\$381	N/A	N/A
Z12S31TN	12 x 16 x 30.7	42	4.4	\$332	\$356	N/A	N/A

Designed to be placed on top of 41.3"/41.8" high units to achieve 72"/72.5" final height. Includes one adjustable shelf. Shipped assembled in 1 carton.

Z36S55T	36 x 16 x 54.9	174	21.5	\$1291	\$1352	\$1378	N/A
Z30S55T	30 x 16 x 54.9	152	18	\$1179	\$1230	\$1188	N/A

Designed to be placed on top of 29.5"/30" high units to achieve 84.5"/85" final height. Laminate doors are standard. Includes three adjustable shelves. Standard with lock. Shipped assembled in 1 carton.

Z21S55TL	21 x 16 x 54.9	116	13	\$919	\$958	\$762	N/A
Z18S55TL	18 x 16 x 54.9	105	11.25	\$861	\$895	\$683	N/A
Z16S55TL	16 x 16 x 54.9	98	10	\$818	\$852	\$679	N/A
Z15S55TL	15 x 16 x 54.9	94	9.5	\$780	\$809	\$589	N/A
Z12S55TL	12 x 16 x 54.9	84	7.75	\$724	\$748	\$527	N/A

Designed to be placed on top of 29.5"/30" high units to achieve 84.5"/85" final height. Laminate door is standard. Includes three adjustable shelves. Standard with lock. Shipped assembled in 1 carton.

Z21S55TR	21 x 16 x 54.9	116	13	\$919	\$958	\$762	N/A
Z18S55TR	18 x 16 x 54.9	105	11.25	\$861	\$895	\$683	N/A
Z16S55TR	16 x 16 x 54.9	98	10	\$818	\$852	\$679	N/A
Z15S55TR	15 x 16 x 54.9	94	9.5	\$780	\$809	\$589	N/A
Z12S55TR	12 x 16 x 54.9	84	7.75	\$724	\$748	\$527	N/A

Designed to be placed on top of 29.5"/30" high units to achieve 84.5"/85" final height. Laminate door is standard. Includes three adjustable shelves. Standard with lock. Shipped assembled in 1 carton.

Required specifications

- Top finish
- Top thickness/edge detail
- Base finish
- Handles\*

Optional specifications

- Key #\*
- Glazed door\*
- Collator - position & finish (only ZxxS31TN)

**TABLE TOP BOOKCASES**      **MODEL #**      **DIMENSIONS**      **WT/LB.**      **CUBIC FT.**      **1" TOP**      **1.5" TOP**      **GLAZE ADD**      **HP ADD**

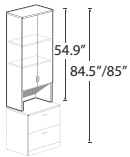

Glazed door option

**Table Top Bookcase with Doors and Cavity 54.9" High\***

Designed to be placed **on top of 29.5"/30" high units to achieve 84.5"/85" final height.** Laminate doors are standard. **Includes two adjustable shelves.** Standard with lock. Shipped assembled in 1 carton.

	W x D x H (1.5" TOP)							
Z36S55TC	36 x 16 x 54.9	167	21.5	<b>\$1258</b>	<b>\$1319</b>	<b>\$1200</b>		N/A
Z30S55TC	30 x 16 x 54.9	146	18	<b>\$1151</b>	<b>\$1202</b>	<b>\$1041</b>		N/A



\* Accepts collator 11" high

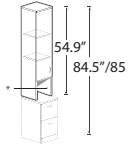

Glazed door option

**Table Top Bookcase with Door and Cavity 54.9" High - LEFT\***

Designed to be placed **on top of 29.5"/30" high units to achieve 84.5"/85" final height.** Laminate door is standard. **Includes two adjustable shelves.** Standard with lock. Shipped assembled in 1 carton.

Z21S55TCL	21 x 16 x 54.9	112	13	<b>\$887</b>	<b>\$926</b>	<b>\$660</b>		N/A
Z18S55TCL	18 x 16 x 54.9	101	11.25	<b>\$833</b>	<b>\$867</b>	<b>\$594</b>		N/A
Z16S55TCL	16 x 16 x 54.9	94	10	<b>\$789</b>	<b>\$823</b>	<b>\$589</b>		N/A
Z15S55TCL	15 x 16 x 54.9	91	9.5	<b>\$757</b>	<b>\$786</b>	<b>\$516</b>		N/A
Z12S55TCL	12 x 16 x 54.9	81	7.75	<b>\$701</b>	<b>\$725</b>	<b>\$466</b>		N/A



\* Accepts collator 11" high

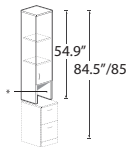

Glazed door option

**Table Top Bookcase with Door and Cavity - 54.9" High - RIGHT\***

Designed to be placed **on top of 29.5"/30" high units to achieve 84.5"/85" final height.** Laminate door is standard. **Includes two adjustable shelves.** Standard with lock. Shipped assembled in 1 carton.

Z21S55TCR	21 x 16 x 54.9	112	13	<b>\$887</b>	<b>\$926</b>	<b>\$660</b>		N/A
Z18S55TCR	18 x 16 x 54.9	101	11.25	<b>\$833</b>	<b>\$867</b>	<b>\$594</b>		N/A
Z16S55TCR	16 x 16 x 54.9	94	10	<b>\$789</b>	<b>\$823</b>	<b>\$589</b>		N/A
Z15S55TCR	15 x 16 x 54.9	91	9.5	<b>\$757</b>	<b>\$786</b>	<b>\$516</b>		N/A
Z12S55TCR	12 x 16 x 54.9	81	7.75	<b>\$701</b>	<b>\$725</b>	<b>\$466</b>		N/A

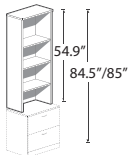

**Table Top Bookcase 54.9" High**

Designed to be placed **on top of 29.5"/30" high units to achieve 84.5"/85" final height.** **Includes three adjustable shelves.** Shipped assembled in 1 carton.

Z36S55TN	36 x 16 x 54.9	130	21.5	<b>\$860</b>	<b>\$921</b>	N/A		N/A
Z30S55TN	30 x 16 x 54.9	115	18	<b>\$799</b>	<b>\$850</b>	N/A		N/A

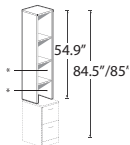

**Table Top Bookcase 54.9" High**

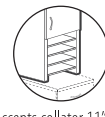

\* Accepts collator 11" high

Designed to be placed **on top of 29.5"/30" high units to achieve 84.5"/85" final height.** **Includes three adjustable shelves.** Shipped assembled in 1 carton.

Z21S55TN	21 x 16 x 54.9	90	13	<b>\$671</b>	<b>\$710</b>	N/A		N/A
Z18S55TN	18 x 16 x 54.9	82	11.25	<b>\$638</b>	<b>\$672</b>	N/A		N/A
Z16S55TN	16 x 16 x 54.9	77	10	<b>\$595</b>	<b>\$629</b>	N/A		N/A
Z15S55TN	15 x 16 x 54.9	75	9.5	<b>\$579</b>	<b>\$608</b>	N/A		N/A
Z12S55TN	12 x 16 x 54.9	68	7.75	<b>\$542</b>	<b>\$566</b>	N/A		N/A

**Required specifications**

- Top finish
- Top thickness/edge detail
- Base finish
- Handles\*

**Optional specifications**

- Key #\*
- Glazed door\*
- Collator - position & finish (only ZxxS55CL ZxxS55TCR and ZxxS55TN)

TABLE TOP BOOKCASES

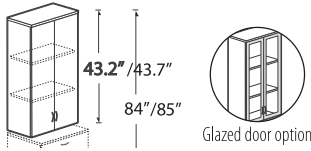

Table Top Bookcase with Doors  
43.2" High

MODEL #	DIMENSIONS W x D x H (1.5" TOP)	WT/LB.	CUBIC FT.	1" TOP	1.5" TOP	GLAZE ADD	HP ADD
Z36S43T	36 x 16 x 43.2	139	17	\$1085	\$1146	\$1200	N/A
Z30S43T	30 x 16 x 43.2	121	14.5	\$928	\$979	\$1041	N/A

Designed to be placed on top of 41.3"/41.8" high units to achieve 84.5"/85" final height. Laminate doors are standard. DO NOT USE ON TOP OF 29.5"/30" HIGH UNITS. Includes two adjustable shelves. Standard with lock. Shipped assembled in 1 carton.

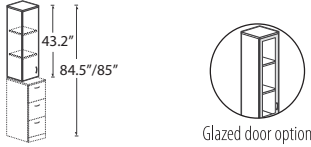

Table Top Bookcase with Door  
43.2" High

Z21S43TL	21 x 16 x 43.2	94	10.25	\$767	\$806	\$660	N/A
Z18S43TL	18 x 16 x 43.2	85	9	\$734	\$768	\$594	N/A
Z16S43TL	16 x 16 x 43.2	78	8	\$658	\$692	\$589	N/A
Z15S43TL	15 x 16 x 43.2	75	7.5	\$617	\$646	\$516	N/A
Z12S43TL	12 x 16 x 43.2	66	6.25	\$573	\$597	\$466	N/A

Designed to be placed on top of 41.3"/41.8" high units to achieve 84.5"/85" final height. Laminate door is standard. DO NOT USE ON TOP OF 29.5"/30" HIGH UNITS. Includes two adjustable shelves. Standard with lock. Shipped assembled in 1 carton.

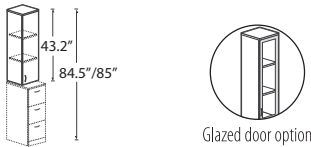

Table Top Bookcase with Door  
43.2" High

Z21S43TR	21 x 16 x 43.2	94	10.25	\$767	\$806	\$660	N/A
Z18S43TR	18 x 16 x 43.2	85	9	\$734	\$768	\$594	N/A
Z16S43TR	16 x 16 x 43.2	78	8	\$658	\$692	\$589	N/A
Z15S43TR	15 x 16 x 43.2	75	7.5	\$617	\$646	\$516	N/A
Z12S43TR	12 x 16 x 43.2	66	6.25	\$573	\$597	\$466	N/A

Designed to be placed on top of 41.3"/41.8" high units to achieve 84.5"/85" final height. Laminate door is standard. DO NOT USE ON TOP OF 29.5"/30" HIGH UNITS. Includes two adjustable shelves. Standard with lock. Shipped assembled in 1 carton.

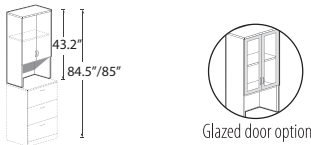

Table Top Bookcase with Doors  
and Cavity - 43.2" High

Z36S43TC	36 x 16 x 43.2	132	17	\$1051	\$1112	\$943	N/A
Z30S43TC	30 x 16 x 43.2	115	14.5	\$919	\$970	\$803	N/A

Designed to be placed on top of 41.3"/41.8" high units to achieve 84.5"/85" final height. Laminate doors are standard. DO NOT USE ON TOP OF 29.5"/30" HIGH UNITS. Includes one adjustable shelf. Standard with lock. Shipped assembled in 1 carton.

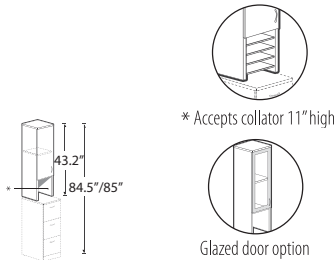

Table Top Bookcase with Door  
and Cavity - 43.2" High - LEFT\*

Z21S43TCL	21 x 16 x 43.2	89	10.25	\$748	\$787	\$520	N/A
Z18S43TCL	18 x 16 x 43.2	81	9	\$716	\$750	\$466	N/A
Z16S43TCL	16 x 16 x 43.2	75	8	\$641	\$675	\$463	N/A
Z15S43TCL	15 x 16 x 43.2	72	7.5	\$603	\$632	\$406	N/A
Z12S43TCL	12 x 16 x 43.2	64	6.25	\$561	\$585	\$365	N/A

Designed to be placed on top of 41.3"/41.8" high units to achieve 84.5"/85" final height. Laminate door is standard. DO NOT USE ON TOP OF 29.5"/30" HIGH UNITS. Includes one adjustable shelf. Standard with lock. Shipped assembled in 1 carton.

Required specifications

- Top finish
- Top thickness/edge detail
- Base finish
- Handles

Optional specifications

- Key #
- Collator - position & finish\*
- Glazed door

**TABLE TOP BOOKCASES**

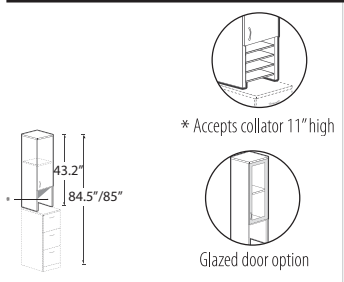

**Table Top Bookcase with Door and Cavity - 43.2" High - RIGHT\***

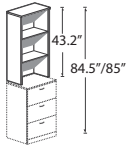

**Table Top Bookcase 43.2" High**



**Table Top Bookcase 43.2" High\***

MODEL #	DIMENSIONS W x D x H (1.5" TOP)	WT/LB.	CUBIC FT.	1" TOP	1.5" TOP	GLAZE ADD	HP ADD
Z21S43TCR	21 x 16 x 43.2	89	10.25	<b>\$748</b>	<b>\$787</b>	<b>\$520</b>	N/A
Z18S43TCR	18 x 16 x 43.2	81	9	<b>\$716</b>	<b>\$750</b>	<b>\$466</b>	N/A
Z16S43TCR	16 x 16 x 43.2	75	8	<b>\$641</b>	<b>\$675</b>	<b>\$463</b>	N/A
Z15S43TCR	15 x 16 x 43.2	72	7.5	<b>\$603</b>	<b>\$632</b>	<b>\$406</b>	N/A
Z12S43TCR	12 x 16 x 43.2	64	6.25	<b>\$561</b>	<b>\$585</b>	<b>\$365</b>	N/A

Designed to be placed **on top of 41.3"/41.8" high units to achieve 84.5"/85" final height.** Laminate door is standard. **DO NOT USE ON TOP OF 29.5"/30" HIGH UNITS. Includes one adjustable shelf.** Standard with lock. Shipped assembled in 1 carton.

Z36S43TN	36 x 16 x 43.2	105	17	<b>\$733</b>	<b>\$794</b>	N/A	N/A
Z30S43TN	30 x 16 x 43.2	92	14.5	<b>\$636</b>	<b>\$687</b>	N/A	N/A

Designed to be placed **on top of 41.3"/41.8" high units to achieve 84.5"/85" final height.** **DO NOT USE ON TOP OF 29.5"/30" HIGH UNITS. Includes two adjustable shelves.** Shipped assembled in 1 carton.

Z21S43TN	21 x 16 x 43.2	73	10.25	<b>\$565</b>	<b>\$604</b>	N/A	N/A
Z18S43TN	18 x 16 x 43.2	67	9	<b>\$549</b>	<b>\$583</b>	N/A	N/A
Z16S43TN	16 x 16 x 43.2	62	8	<b>\$476</b>	<b>\$510</b>	N/A	N/A
Z15S43TN	15 x 16 x 43.2	60	7.5	<b>\$454</b>	<b>\$483</b>	N/A	N/A
Z12S43TN	12 x 16 x 43.2	54	6.25	<b>\$422</b>	<b>\$446</b>	N/A	N/A

Designed to be placed **on top of 41.3"/41.8" high units to achieve 84.5"/85" final height.** **DO NOT USE ON TOP OF 29.5"/30" HIGH UNITS. Includes two adjustable shelves.** Shipped assembled in 1 carton.

**END SHELVES**

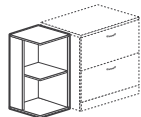

**End Shelf 29.5"/30" High - LEFT**

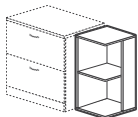

**End Shelf 29.5"/30" High - RIGHT**

Z24L2ESHL	24 x 24 x 30	100	4.75	<b>\$628</b>	<b>\$679</b>	N/A	<b>\$114</b>
Z20M2ESHL	20 x 20 x 30	77	3.75	<b>\$519</b>	<b>\$555</b>	N/A	<b>\$69</b>
Z16S2ESHL	16 x 16 x 30	54	2.25	<b>\$439</b>	<b>\$473</b>	N/A	<b>\$69</b>

For use at **left** end of **29.5"/30"H units. One adjustable shelf.** Shipped easy to assemble in 1 carton.

Z24L2ESHR	24 x 24 x 30	100	4.75	<b>\$628</b>	<b>\$679</b>	N/A	<b>\$114</b>
Z20M2ESHR	20 x 20 x 30	77	3.75	<b>\$519</b>	<b>\$555</b>	N/A	<b>\$69</b>
Z16S2ESHR	16 x 16 x 30	54	2.25	<b>\$439</b>	<b>\$473</b>	N/A	<b>\$69</b>

For use at **right** end of **29.5"/30"H units. One adjustable shelf.** Shipped easy to assemble in 1 carton.

**Required specifications**

- Top finish
- Top thickness/edge detail
- Base finish
- Handles\*

**Optional specifications**

- HP laminate (only end shelves)
- Key #\*
- Glazed door\*
- Collator - position & finish\*

END SHELVES	MODEL #	DIMENSIONS	WT/LB.	CUBIC FT.	1" TOP	1.5" TOP	GLAZE ADD	HP ADD
-------------	---------	------------	--------	-----------	--------	----------	-----------	--------

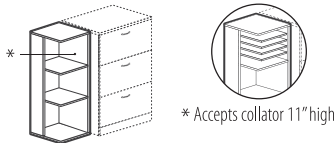

**End Shelf 41.3"/41.8" High - LEFT\***

	W x D x H (1.5" TOP)							
Z24L4ESHL	24 x 24 x 41.8	130	4.75	<b>\$807</b>	<b>\$858</b>	N/A	<b>\$114</b>	
Z20M4ESHL	20 x 20 x 41.8	101	3.25	<b>\$677</b>	<b>\$713</b>	N/A	<b>\$69</b>	
Z16S4ESHL	16 x 16 x 41.8	74	2.5	<b>\$573</b>	<b>\$607</b>	N/A	<b>\$69</b>	

For use at **left** end of **41.3"/41.8" H units**. **Two adjustable shelves**. Shipped easy to assemble in 1 carton.  
 • Collator only available on **Z16S4ESHL**.

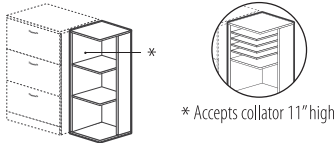

**End Shelf 41.3"/41.8" High - RIGHT\***

Z24L4ESHR	24 x 24 x 41.8	130	4.75	<b>\$807</b>	<b>\$858</b>	N/A	<b>\$114</b>	
Z20M4ESHR	20 x 20 x 41.8	101	3.25	<b>\$677</b>	<b>\$713</b>	N/A	<b>\$69</b>	
Z16S4ESHR	16 x 16 x 41.8	74	2.5	<b>\$573</b>	<b>\$607</b>	N/A	<b>\$69</b>	

For use at **right** end of **41.3"/41.8" H units**. **Two adjustable shelves**. Shipped easy to assemble in 1 carton.  
 • Collator only available on **Z16S4ESHR**.

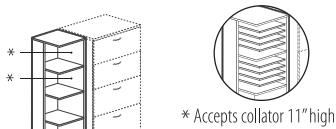

**End Shelf 53"/53.5" High - LEFT\***

Z24L5ESHL	24 x 24 x 53.5	163	4.75	<b>\$1000</b>	<b>\$1051</b>	N/A	<b>\$114</b>	
Z20M5ESHL	20 x 20 x 53.5	126	4	<b>\$824</b>	<b>\$860</b>	N/A	<b>\$69</b>	
Z16S5ESHL	16 x 16 x 53.5	91	3.25	<b>\$695</b>	<b>\$729</b>	N/A	<b>\$69</b>	

For use at **left** end of **53"/53.5" H units**. **Three adjustable shelves**. Shipped easy to assemble in 1 carton.  
 • Collator only available on **Z16S5ESHL**.

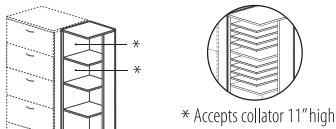

**End Shelf 53"/53.5" High - RIGHT\***

Z24L5ESHR	24 x 24 x 53.5	163	4.75	<b>\$1000</b>	<b>\$1051</b>	N/A	<b>\$114</b>	
Z20M5ESHR	20 x 20 x 53.5	126	4	<b>\$824</b>	<b>\$860</b>	N/A	<b>\$69</b>	
Z16S5ESHR	16 x 16 x 53.5	91	3.25	<b>\$695</b>	<b>\$729</b>	N/A	<b>\$69</b>	

For use at **right** end of **53"/53.5" H units**. **Three adjustable shelves**. Shipped easy to assemble in 1 carton.  
 • Collator only available on **Z16S5ESHR**.

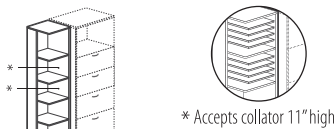

**End Shelf 65.5"/66" High - LEFT**

Z24L6ESHL	24 x 24 x 66	196	6	<b>\$1169</b>	<b>\$1220</b>	N/A	N/A	
Z20M6ESHL	20 x 20 x 66	152	5	<b>\$972</b>	<b>\$1008</b>	N/A	N/A	
Z16S6ESHL	16 x 16 x 66	111	4.25	<b>\$829</b>	<b>\$863</b>	N/A	N/A	

For use at **left** end of **65.5"/66" H units**. **Four adjustable shelves**. Shipped easy to assemble in 1 carton.  
 • Collator only available on **Z16S6ESHL**.

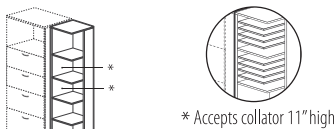

**End Shelf 65.5"/66" High - RIGHT**

Z24L6ESHR	24 x 24 x 66	196	6	<b>\$1169</b>	<b>\$1220</b>	N/A	N/A	
Z20M6ESHR	20 x 20 x 66	152	5	<b>\$972</b>	<b>\$1008</b>	N/A	N/A	
Z16S6ESHR	16 x 16 x 66	111	4.25	<b>\$829</b>	<b>\$863</b>	N/A	N/A	

For use at **right** end of **65.5"/66" H units**. **Four adjustable shelves**. Shipped easy to assemble in 1 carton.  
 • Collator only available on **Z16S6ESHR**.



**Required specifications**

Top finish  
 Top thickness/edge detail  
 Base finish

**Optional specifications**

HP laminate\*  
 Collator - position & finish

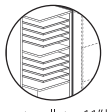
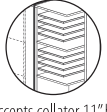
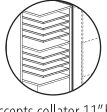
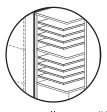
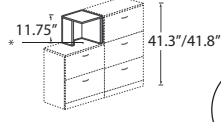
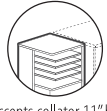
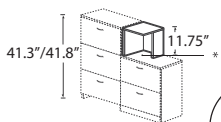

END SHELVES	MODEL #	DIMENSIONS	WT/LB.	CUBIC FT.	1" TOP	1.5" TOP	GLAZE ADD	HP ADD
		<b>W x D x H (1.5" TOP)</b>						
, 72.5" High - LEFT" data-bbox="85 75 155 155"/>  * Accepts collator 11" high	Z24L7ESHL	24 x 24 x 72.4	207	6.5	<b>\$1228</b>	<b>\$1279</b>	N/A	N/A
	Z20M7ESHL	20 x 20 x 72.4	161	5.75	<b>\$1025</b>	<b>\$1061</b>	N/A	N/A
	Z16S7ESHL	16 x 16 x 72.4	118	4.75	<b>\$870</b>	<b>\$904</b>	N/A	N/A
<b>End Shelf 72"/72.5" High - LEFT</b>		For use at <b>left</b> end of <b>72"/72.5"H units</b> . <b>Four adjustable shelves</b> . Shipped easy to assemble in 1 carton. <ul style="list-style-type: none"> <li>• Collator only available on <b>Z16S7ESHL</b>.</li> </ul>						
, 72.5" High - RIGHT" data-bbox="85 205 155 285"/>  * Accepts collator 11" high	Z24L7ESHR	24 x 24 x 72.4	207	6.5	<b>\$1228</b>	<b>\$1279</b>	N/A	N/A
	Z20M7ESHR	20 x 20 x 72.4	161	5.75	<b>\$1025</b>	<b>\$1061</b>	N/A	N/A
	Z16S7ESHR	16 x 16 x 72.4	118	4.75	<b>\$870</b>	<b>\$904</b>	N/A	N/A
<b>End Shelf 72"/72.5" High - RIGHT</b>		For use at <b>right</b> end of <b>72"/72.5"H units</b> . <b>Four adjustable shelves</b> . Shipped easy to assemble in 1 carton. <ul style="list-style-type: none"> <li>• Collator only available on <b>Z16S7ESHR</b>.</li> </ul>						
, 85" High - LEFT" data-bbox="85 325 155 405"/>  * Accepts collator 11" high	Z24L8ESHL	24 x 24 x 84.9	242	7.75	<b>\$1412</b>	<b>\$1463</b>	N/A	N/A
	Z20M8ESHL	20 x 20 x 84.9	186	6.5	<b>\$1175</b>	<b>\$1211</b>	N/A	N/A
	Z16S8ESHL	16 x 16 x 84.9	137	5.5	<b>\$998</b>	<b>\$1032</b>	N/A	N/A
<b>End Shelf 84.5"/85" High - LEFT</b>		For use at <b>left</b> end of <b>84.5"/85"H units</b> . <b>Five adjustable shelves</b> . Shipped easy to assemble in 1 carton. <ul style="list-style-type: none"> <li>• Collator only available on <b>Z16S8ESHL</b>.</li> </ul>						
, 85" High - RIGHT" data-bbox="85 455 155 535"/>  * Accepts collator 11" high	Z24L8ESHR	24 x 24 x 84.9	242	7.75	<b>\$1412</b>	<b>\$1463</b>	N/A	N/A
	Z20M8ESHR	20 x 20 x 84.9	186	6.5	<b>\$1175</b>	<b>\$1211</b>	N/A	N/A
	Z16S8ESHR	16 x 16 x 84.9	137	5.5	<b>\$998</b>	<b>\$1032</b>	N/A	N/A
<b>End Shelf 84.5"/85" High - RIGHT</b>		For use at <b>RIGHT</b> end of <b>84.5"/85"H units</b> . <b>Five adjustable shelves</b> . Shipped easy to assemble in 1 carton. <ul style="list-style-type: none"> <li>• Collator only available on <b>Z16S8ESHR</b>.</li> </ul>						
  * Accepts collator 11" high	Z16S12DL	16 x 16 x 11.75	26	1.6	<b>\$222</b>	<b>\$256</b>	N/A	<b>\$69</b>
	<b>Table Top End Shelf 11.75" High - LEFT*</b>		To be placed <b>on top of 29.5"/30"H units</b> . For use at <b>left</b> end of <b>41.3"/41.8"H units</b> . Shipped easy to assemble in 1 carton.					
  * Accepts collator 11" high	Z16S12DR	16 x 16 x 11.75	26	1.6	<b>\$222</b>	<b>\$256</b>	N/A	<b>\$69</b>
	<b>Table Top End Shelf 11.75" High - RIGHT*</b>		To be placed <b>on top of 29.5"/30"H units</b> . For use at <b>right</b> end of <b>41.3"/41.8"H units</b> . Shipped easy to assemble in 1 carton.					

**Required specifications**

Top finish  
 Top thickness/edge detail  
 Base finish

**Optional specifications**

HP laminate\*  
 Collator - position & finish

TABLE TOP END SHELVES	MODEL #	DIMENSIONS	WT/LB.	CUBIC FT.	1" TOP	1.5" TOP	GLAZE ADD	HP ADD
-----------------------	---------	------------	--------	-----------	--------	----------	-----------	--------

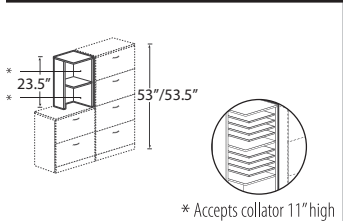

**Table Top End Shelf 23.5\"/>**

W x D x H (1.5\"/>								
Z16S23DL	16 x 16 x 23.5	42	1.6	\$343	\$377	N/A	\$69	

To be placed **on top of 29.5\"/>**

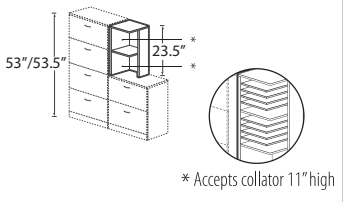

**Table Top End Shelf 23.5\"/>**

Z16S23DR	16 x 16 x 23.5	42	1.6	\$343	\$377	N/A	\$69	
----------	----------------	----	-----	-------	-------	-----	------	--

To be placed **on top of 29.5\"/>**

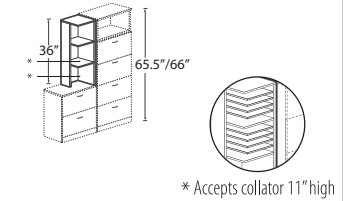

**Table Top End Shelf 36\"/>**

Z16S36DL	16 x 16 x 36	63	2.8	\$480	\$514	N/A	N/A	
----------	--------------	----	-----	-------	-------	-----	-----	--

To be placed **on top of 29.5\"/>**

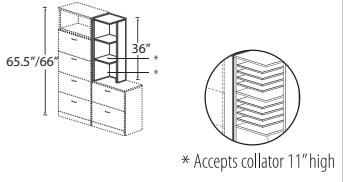

**Table Top End Shelf 36\"/>**

Z16S36DR	16 x 16 x 36	63	2.8	\$480	\$514	N/A	N/A	
----------	--------------	----	-----	-------	-------	-----	-----	--

To be placed **on top of 29.5\"/>**

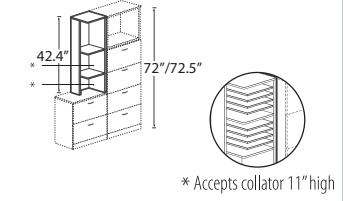

**Table Top End Shelf 42.4\"/>**

Z16S42DL	16 x 16 x 42.4	70	2.8	\$518	\$552	N/A	N/A	
----------	----------------	----	-----	-------	-------	-----	-----	--

To be placed **on top of 29.5\"/>**

**Required specifications**

- Top finish
- Top thickness/edge detail
- Base finish

**Optional specifications**

- HP laminate\*
- Collator - position & finish

TABLE TOP END SHELVES	MODEL #	DIMENSIONS	WT/LB.	CUBIC FT.	1" TOP	1.5" TOP	GLAZE ADD	HP ADD
		<b>W x D x H (1.5" TOP)</b>						
" data-bbox="88 75 270 160"/> <p>72"/72.5" 42.4" * Accepts collator 11" high</p> <p><b>Table Top End Shelf 42.4" High - RIGHT</b></p>	Z16S42DR	16 x 16 x 42.4	70	2.8	<b>\$518</b>	<b>\$552</b>	N/A	N/A
To be placed <b>on top of 29.5"/30"H units</b> . For use at <b>right</b> end of <b>72"/72.5"H units</b> . Two adjustable shelves. Shipped easy to assemble in 1 carton.								
" data-bbox="88 225 270 310"/> <p>54.9" 84.5"/85" * Accepts collator 11" high</p> <p><b>Table Top End Shelf 54.9" High - LEFT</b></p>	Z16S55DL	16 x 16 x 54.9	89	2.8	<b>\$642</b>	<b>\$676</b>	N/A	N/A
To be placed <b>on top of 29.5"/30"H units</b> . For use at <b>left</b> end of <b>84.5"/85"H units</b> . Three adjustable shelves. Shipped easy to assemble in 1 carton.								
" data-bbox="88 385 270 470"/> <p>84.5"/85" 54.9" * Accepts collator 11" high</p> <p><b>Table Top End Shelf 54.9" High - RIGHT</b></p>	Z16S55DR	16 x 16 x 54.9	89	2.8	<b>\$642</b>	<b>\$676</b>	N/A	N/A
To be placed <b>on top of 29.5"/30"H units</b> . For use at <b>right</b> end of <b>84.5"/85"H units</b> . Three adjustable shelves. Shipped easy to assemble in 1 carton.								

ACCESSORIES	LIST PRICE							
-------------	------------	--	--	--	--	--	--	--

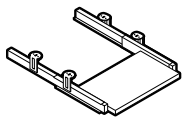

**Pull-Out Keyboard\***

APOKL28	28 x 17 x 3.5	13	0.9	<b>\$296</b>
APOKL22	22 x 17 x 3.5	12	0.9	<b>\$270</b>

**APOKL28** will accommodate keyboard and mouse pad.  
**APOKL28** will only fit on a single pedestal desk, freestanding table, or **Z42205C**.

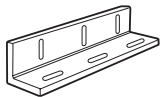

**L Bracket\***

MLB90	4 x 1 x 1	0.10	0.10	<b>\$12</b>
-------	-----------	------	------	-------------

Used to attach worksurfaces to end panels. Black only.

**Required specifications**

Top finish  
 Top thickness/edge detail  
 Base finish  
 Finish\*

**Optional specifications**

Collator - position & finish

ACCESSORIES	MODEL #	DIMENSIONS W x D x H	WT/LB.	CUBIC FT.	LIST PRICE	HP ADD
<p><b>Skateboard - LEFT*</b></p>	Z1425SKL	25 x 13.9 x 3.7	13	1.5	<b>\$124</b>	<b>\$128</b>
	Mobile CPU holder designed to fit inside 'faux' pedestals of a single pedestal desk.					
<p><b>Skateboard - RIGHT*</b></p>	Z1425SKR	25 x 13.9 x 3.7	13	1.5	<b>\$124</b>	<b>\$128</b>
	Mobile CPU holder designed to fit inside 'faux' pedestals of a single pedestal desk.					

CENTER DRAWERS	MODEL #	DIMENSIONS W x D x H	WT/LB.	CUBIC FT.	LIST PRICE	HP ADD
<p><b>Center Drawer</b></p>	CD28	28 x 18 x 3	5	1	<b>\$248</b>	N/A
	Laminate drawer front is attached to a four-sided frame. Recommended for use on 36" and 72" desks.					

HANDLES	MODEL #	DIMENSIONS W x D x H	WT/LB.	CUBIC FT.	LIST PRICE	HP ADD
<p><b>Silver Handle (HV)</b></p>	HANDLE HV	5 x - x -	0.25	0.1	<b>\$18</b>	N/A
	<p>Silver finish, square edge handle style. <b>For use on pedestals and all lateral files.</b></p> <ul style="list-style-type: none"> <li>This handle has a measurement of 96mm center to center.</li> <li>Drawer handles on this page are for purchase. Installation is done by the customer. To purchase as a factory installed option on desks, credenzas and returns, see series notes (page 111) for option codes and upcharge.</li> </ul>					
<p><b>Matte Black Handle (HU)</b></p>	HANDLE HU	5 x - x -	0.25	0.1	<b>\$18</b>	N/A
	<p>Black matte finish, square edge handle style. <b>For use on pedestals and all lateral files.</b></p> <ul style="list-style-type: none"> <li>This handle has a measurement of 96mm center to center.</li> <li>Drawer handles on this page are for purchase. Installation is done by the customer. To purchase as a factory installed option on desks, credenzas and returns, see series notes (page 111) for option codes and upcharge.</li> </ul>					
<p><b>Flared Black Handle (HX)</b></p>	HANDLE HX	5.25 x - x -	0.25	0.1	<b>\$18</b>	N/A
	<p>Black matte finish, flared handle style. <b>For use on pedestals and all lateral files.</b></p> <ul style="list-style-type: none"> <li>This handle has a measurement of 96mm center to center.</li> <li>Drawer handles on this page are for purchase. Installation is done by the customer. To purchase as a factory installed option on desks, credenzas and returns, see series notes (page 111) for option codes and upcharge.</li> </ul>					
<p><b>Flared Silver Handle (HS)</b></p>	HANDLE HS	4.5 x - x -	0.25	0.1	<b>\$18</b>	N/A
	<p>Silver matte finish, flared handle style. <b>For use on pedestals and all lateral files.</b></p> <ul style="list-style-type: none"> <li>This handle has a measurement of 96mm center to center.</li> <li>Drawer handles on this page are for purchase. Installation is done by the customer. To purchase as a factory installed option on desks, credenzas and returns, see series notes (page 111) for option codes and upcharge.</li> </ul>					

**Required specifications**  
Finish (not handles)

**Optional specifications**  
HP laminate\*

HANDLES	MODEL #	DIMENSIONS	WT/LB.	CUBIC FT.	LIST PRICE
<p><b>Dimpled Nickel Handle (HZ)</b></p>		<b>W x D x H</b>			
	HANDLE HZ	4.9 x - x -	0.25	0.1	<b>\$18</b>
<p>Nickel matte finish, dimpled handle style. <b>For use on pedestals and all lateral files.</b></p> <ul style="list-style-type: none"> <li>• This handle has a measurement of 96mm center to center.</li> <li>• Drawer handles on this page are for purchase. Installation is done by the customer. To purchase as a factory installed option on desks, credenzas and returns, see series notes (page 111) for option codes and upcharge.</li> </ul>					
<p><b>Crescent Black Handle (HO)</b></p>		<b>W x D x H</b>			
	HANDLE HO	4.75 x - x -	0.25	0.1	<b>\$18</b>
<p>Black matte finish, crescent handle style. <b>For use on pedestals and all lateral files.</b></p> <ul style="list-style-type: none"> <li>• This handle has a measurement of 96mm center to center.</li> <li>• Drawer handles on this page are for purchase. Installation is done by the customer. To purchase as a factory installed option on <b>desks, credenzas and returns only</b>, see series notes (page 111) for option codes and upcharge.</li> </ul>					
<p><b>Bar Silver Handle (HQ)</b></p>		<b>W x D x H</b>			
	HANDLE HQ	4.6 x - x -	0.25	0.1	<b>\$18</b>
<p>Silver finish, bar handle style. <b>For use on pedestals and all lateral files.</b></p> <ul style="list-style-type: none"> <li>• This handle has a measurement of 96mm center to center.</li> <li>• Drawer handles on this page are for purchase. Installation is done by the customer. To purchase as a factory installed option on <b>desks, credenzas and returns only</b>, see series notes (page 111) for option codes and upcharge.</li> </ul>					
<p><b>Bar Black Handle (HR)</b></p>		<b>W x D x H</b>			
	HANDLE HR	4.6 x - x -	0.25	0.1	<b>\$18</b>
<p>Black finish, bar handle style. <b>For use on pedestals and all lateral files.</b></p> <ul style="list-style-type: none"> <li>• This handle has a measurement of 96mm center to center.</li> <li>• Drawer handles on this page are for purchase. Installation is done by the customer. To purchase as a factory installed option on <b>desks, credenzas and returns only</b>, see series notes (page 111) for option codes and upcharge.</li> </ul>					

## TOP AND BASE FINISHES

<b>ACJ</b> Absolute Acajou	<b>FCL</b> First Class
<b>ASN</b> Asian Night	<b>NBL</b> Noce Biondo
<b>AWC</b> Avant Cherry	<b>NGL</b> Noce Grigio
<b>AWH</b> Avant Honey	<b>NEL</b> Noce Leggero
<b>BLK</b> Black	<b>NML</b> Noce Medio
<b>BZD</b> Blizzard	<b>QTM</b> Quartered Mahogany
<b>BRC</b> Brushed Cobalt	<b>SBY</b> Sheer Beauty
<b>CMB</b> Clear Maple	<b>SDT</b> Stonedust
<b>CGY</b> Custom Grey	<b>SOG</b> Storm Grey
<b>DES</b> Dark Espresso	<b>WHE</b> Walnut Heights
<b>DWT</b> Designer White	<b>WHC</b> White Chocolate
<b>FAS</b> Fashionista	<b>WCR</b> Winter Cherry

## BASE TRIM FINISHES

<b>BRC</b> Brushed Cobalt
<b>BLK</b> Black

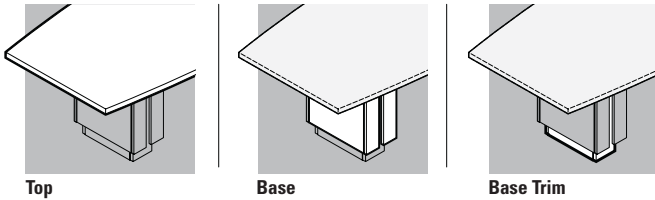

## TOP THICKNESS/EDGE DETAIL



**C3** 1.5" top, standard flat edge      **CR** 1.5" top, bicut edge      **CF** 1.5" top, fluted edge

## BASES

- 2 doors on base for wire management access from both sides.
- Because of base sizes, custom width less than 96" cannot be accommodated.

## TOPS

- 96" tops are standard in one piece. All tops 120", 144" and 168" tops are standard in two equal size pieces. Woodgrain laminate finishes may NOT align where the two tops join. Tops 192" and larger are standard in 3 equal pieces.
- 96" tops are standard with **two bases**.
- Tops 120", 144" and 168" are standard with **three bases**.
- Tops 169" to 288" and larger are standard with **four bases**.
- **Five** top shapes: **boat shaped, bow end, rectangular, racetrack** and **wedge**.

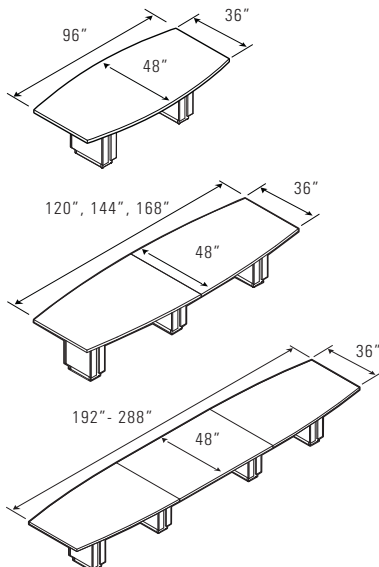

## POWER BLOCK OPTIONS AND CUT-OUT LOCATIONS

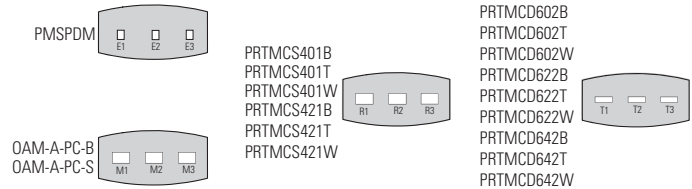

- For **Square, Media** and **Collaborative Tables**, please refer to the electronic Zira Design Guide found on the Global website under Brochures.

## CUT-OUTS

- **Boardroom** and **collaborative tables** offer optional cut-outs for in-surface mounted power modules in three standard locations - left, center or right (E1, E2 or E3, etc as per above grid) for all table shapes excluding square boardroom tables. **Add \$91** for each cut-out.
- Cut-out options for **square boardroom tables** in centered position only - E2, M2, R2 or T2. **Add \$91**.
- Cut-out options for **media tables** in position 1 only - E1, M1, R1 or T1. **Add \$91**.
- Cut-outs may be placed at non-standard locations. Please submit a NON-STANDARD CUT-OUT request form with your order. Forms can be found on the Global Dealer Center under "Specials".
- Available power modules are listed on pages 467-469.
- Be sure to specify matching power module with corresponding cut-out codes (as per above grid). Cut-out size(s) and orientation(s) are specific to the power module(s).
- Refer to **Zira Boardroom Design Guide** online for more information.

## AUDIOVISUAL

Three components: multimedia cart, lectern and visual board.

### Multimedia Cart

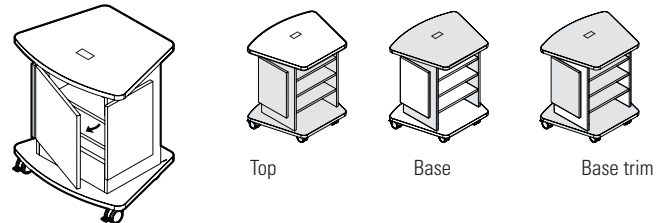

### Lectern

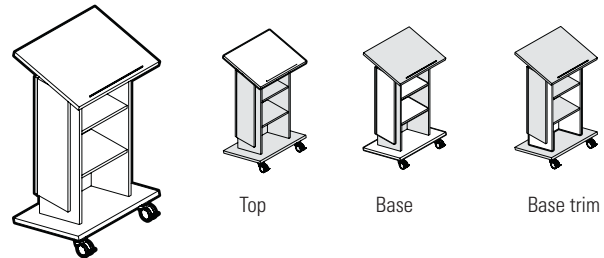

**Multimedia Cart and Lectern:**

- Available in all laminates listed on previous page.
- Color of casters will match base trim.
- Offered in the following **top thickness and edge details:**



**A3** 1" top, standard flat edge



**AR** 1" top, bicut edge



**C3** 1.5" top, standard flat edge



**CR** 1.5" top, bicut edge



**CF** 1.5" top, fluted edge

**Visual Board:**

- Available in all laminates listed on previous page.
- Push bar available in Black (**BLK**) or Tungsten (**TUN**).
- Color of casters and aluminum trim will match push bar.
- Visual board comes standard in White color.

**BUFFET**

Three components - buffet carts, buffets and serving carts:

- Top and/or base available in all laminates.
- Push bar on buffet and serving carts, and aluminum trim on open and mixed buffets available in Black (**BLK**) or Tungsten (**TUN**).
- Optional glazing available on serving carts and buffets with hinged doors.

**Buffet Carts**



Top



Base

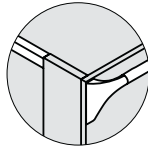

**Serving Cart with Doors**

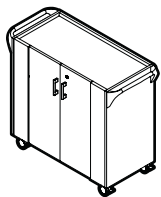

Top



Base

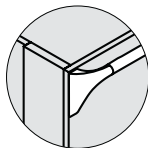

**Serving Cart - Open**

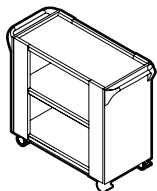

Top



Base

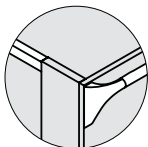

**SPECIFICATIONS**

- Specifications marked with an \* are applicable to only those products which have the \* symbol beside the product name.

**Buffet - Open**

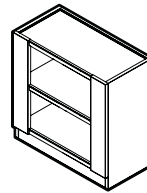

Top



Base

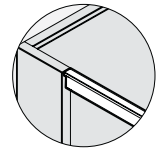

**Buffet with Doors**

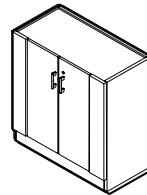

Top



Base

**Buffet - Mixed**

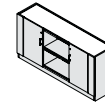
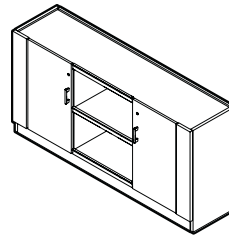

Top

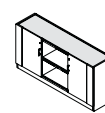

Base

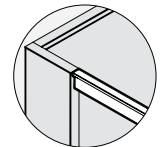

**Glazing (Doors - Serving Cart and Buffets)**



**Z1** frosted glazing, Tungsten (TUN) frame



**Z2** frosted glazing, Black (BLK) frame



**Z3** ribbed glazing, Tungsten (TUN) frame



**Z4** ribbed glazing, Black (BLK) frame

**HANDLES**

- Handles are standard on models with doors. Each handle is identified by the letters **HS, HV, HO, HW, HU, HZ, HX, HQ** and **HR**. To specify a handle, please specify the code after the model number. Lock finish will complement handle lock finish.



**HS** flared Silver



**HV** square edge Silver



**HO** crescent Black



**HW** flared Brass



**HU** square edge Black



**HZ** dimpled Nickel



**HX** flared Black



**HQ** bar Silver



**HR** bar Black

## TABLE NOTES - ESTIMATED CAPACITY

- Use the following to determine the size of a round table and the number of chairs needed for a conference area. All estimates are based on an average chair width of 23" with a 4" clearance between chairs. Adjust accordingly for a different chair size.

Top Size	Rectangular	Bow End	Boat	Racetrack
48 x 96	6-8	6-8	6-8	6-8
48 x 120	8-10	8-10	8-10	8-10
48 x 144	10-12	10-12	10-12	10-12
48 x 168	12-14	12-14	12-14	12-14
48 x 192	14-16	14-16	14-16	14-16
48 x 216	16-18	16-18	16-18	16-18
48 x 240	18-20	18-20	18-20	18-20
48 x 264	20-22	20-22	20-22	20-22
48 x 288	22-24	22-24	22-24	22-24

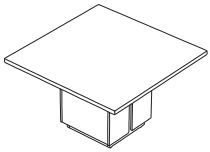
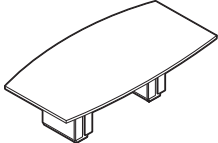
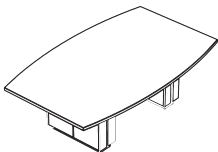
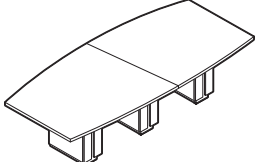
BOARDROOM TABLES	MODEL #	DIMENSIONS	WT/LB.	CUBIC FT.	1" TOP	1.5" TOP	GLAZE ADD	HP ADD	
 <p><b>Boardroom Table - Square</b></p>	<b>W x D x H (1.5" TOP)</b>								
	Z3636SQ	36 x 36 x 30	129	10	N/A	<b>\$2716</b>	N/A	<b>\$309</b>	
	Z4242SQ	42 x 42 x 30	165.5	13.5	N/A	<b>\$3097</b>	N/A	<b>\$421</b>	
	Z4848SQ	48 x 48 x 30	190	14.25	N/A	<b>\$3357</b>	N/A	<b>\$548</b>	
	Z5454SQ	54 x 54 x 30	262	21.25	N/A	<b>\$3753</b>	N/A	<b>\$695</b>	
	Z6060SQ	60 x 60 x 30	300	22.75	N/A	<b>\$4014</b>	N/A	<b>\$857</b>	
Square table includes one base with wire access doors on each side of base. Shipped easy to assemble in 2 cartons.									
 <p><b>Boardroom Table - Boat Shaped</b></p>	Z4896BE	96 x 48 x 30	342	22	N/A	<b>\$3578</b>	N/A	<b>\$935</b>	
	Boat shaped table includes <b>two bases</b> with wire access doors on each side of base and wire concealment runners between bases. Shipped easy to assemble in 3 cartons.								
 <p><b>Boardroom Table - Boat Shaped</b></p>	Z6096BE	96 x 60 x 30	432	35.5	N/A	<b>\$7197</b>	N/A	<b>\$1368</b>	
	Boat shaped table includes two bases with wire access doors on each side of base and wire concealment runners between bases. Shipped easy to assemble in 3 cartons.								
 <p><b>Boardroom Table - Boat Shaped</b></p>	Z48120BE	120 x 48 x 30	452	28.3	N/A	<b>\$5146</b>	N/A	<b>\$1170</b>	
	Z48144BE	144 x 48 x 30	502	30.5	N/A	<b>\$5196</b>	N/A	<b>\$1405</b>	
	Z48168BE	168 x 48 x 30	557	37.25	N/A	<b>\$6768</b>	N/A	<b>\$1597</b>	
Boat shaped table includes three bases with wire access doors on each side of base and wire concealment runners between bases. Z48144BE and Z48120BE shipped easy to assemble in 4 cartons. Z48168BE shipped easy to assemble in 5 cartons.									

### Required specifications

Top finish  
Top thickness/edge detail  
Base finish  
Base trim finish

### Optional specifications

HP laminate  
Cut-out for power block

### Accessories

Power block



BOARDROOM TABLES	MODEL #	DIMENSIONS	WT/LB.	CUBIC FT.	1" TOP	1.5" TOP	GLAZE ADD	HP ADD
------------------	---------	------------	--------	-----------	--------	----------	-----------	--------

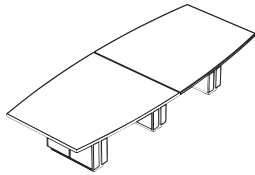

**Boardroom Table - Boat Shaped**

	W x D x H (1.5" TOP)							
Z60120BE	120 x 60 x 30	599	48.5	N/A	<b>\$10918</b>	N/A	<b>\$1711</b>	
Z60144BE	144 x 60 x 30	664.65	53.25	N/A	<b>\$11684</b>	N/A	<b>\$2054</b>	
Z60168BE	168 x 60 x 30	741.3	58	N/A	<b>\$12598</b>	N/A	<b>\$2396</b>	

Boat shaped table includes three bases with wire access doors on each side of base and wire concealment runners between bases. Shipped easy to assemble in 5 cartons.

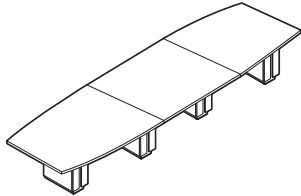

**Boardroom Table - Boat Shaped**

Z48192BE	192 x 48 x 30	688	45.75	N/A	<b>\$8455</b>	N/A	<b>\$1824</b>	
Z48216BE	216 x 48 x 30	746	48.75	N/A	<b>\$8850</b>	N/A	<b>\$2054</b>	
Z48240BE	240 x 48 x 30	803	51.75	N/A	<b>\$9411</b>	N/A	<b>\$2281</b>	
Z48264BE	264 x 48 x 30	855	54.75	N/A	<b>\$9967</b>	N/A	<b>\$2509</b>	
Z48288BE	288 x 48 x 30	906	57.75	N/A	<b>\$9967</b>	N/A	<b>\$2739</b>	

Boat shaped table includes four bases with wire access doors on each side of base and wire concealment runners between bases. Shipped easy to assemble in 7 cartons.

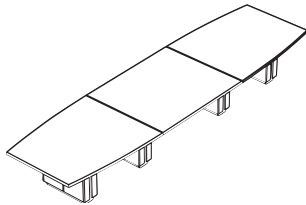

**Boardroom Table - Boat Shaped**

Z60192BE	192 x 60 x 30	912.45	71.25	N/A	<b>\$15850</b>	N/A	<b>\$2739</b>	
Z60216BE	216 x 60 x 30	980.7	76	N/A	<b>\$16734</b>	N/A	<b>\$3081</b>	
Z60240BE	240 x 60 x 30	1062.6	81	N/A	<b>\$17456</b>	N/A	<b>\$3422</b>	
Z60264BE	264 x 60 x 30	1129.8	85.75	N/A	<b>\$18148</b>	N/A	<b>\$3763</b>	
Z60288BE	288 x 60 x 30	1198.05	90.5	N/A	<b>\$19260</b>	N/A	<b>\$4106</b>	

Boat shaped table includes four bases with wire access doors on each side of base and wire concealment runners between bases. Shipped easy to assemble in 7 cartons.

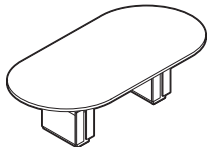

**Boardroom Table - Racetrack**

Z4896RTE	96 x 48 x 30	336	22	N/A	<b>\$3478</b>	N/A	<b>\$935</b>	
----------	--------------	-----	----	-----	---------------	-----	--------------	--

Racetrack shaped table includes two bases with wire access doors on each side of base and wire concealment runners between bases. Shipped easy to assemble in 3 cartons.

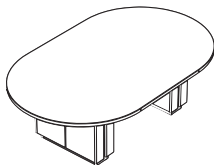

**Boardroom Table - Racetrack**

Z6096RTE	96 x 60 x 30	417	35.5	N/A	<b>\$7197</b>	N/A	<b>\$1368</b>	
----------	--------------	-----	------	-----	---------------	-----	---------------	--

Racetrack shaped table includes two bases with wire access doors on each side of base and wire concealment runners between bases. Shipped easy to assemble in 3 cartons.

**Required specifications**

- Top finish
- Top thickness/edge detail
- Base finish
- Base trim finish

**Optional specifications**

- HP laminate
- Cut-out for power block

**Accessories**

- Power block

# Z ZIRA™ BOARDROOM

## BOARDROOM TABLES

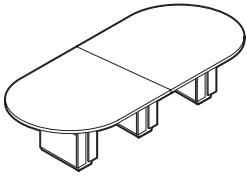

**Boardroom Table - Racetrack**

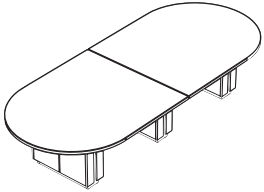

**Boardroom Table - Racetrack**

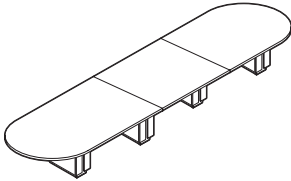

**Boardroom Table - Racetrack**

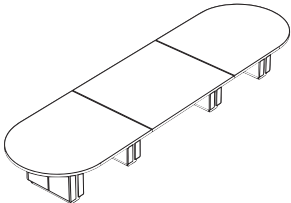

**Boardroom Table - Racetrack**

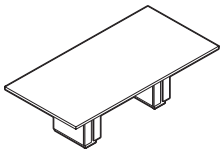

**Boardroom Table - Rectangular**

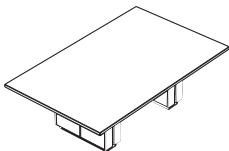

**Boardroom Table - Rectangular**

MODEL #	DIMENSIONS W x D x H (1.5" TOP)	WT/LB.	CUBIC FT.	1" TOP	1.5" TOP	GLAZE ADD	HP ADD
Z4812ORTE	120 x 48 x 30	453	28.3	N/A	<b>\$4839</b>	N/A	<b>\$1170</b>
Z48144RTE	144 x 48 x 30	506	30.5	N/A	<b>\$5158</b>	N/A	<b>\$1405</b>
Z48168RTE	168 x 48 x 30	563	37.25	N/A	<b>\$6809</b>	N/A	<b>\$1597</b>

Racetrack shaped table includes three bases with wire access doors on each side of base and wire concealment runners between bases. Z48144RTE and Z4812ORTE shipped easy to assemble in 4 cartons. Z48168RTE shipped easy to assemble in 5 cartons.

Z6012ORTE	120 x 60 x 30	585.9	48.5	N/A	<b>\$10918</b>	N/A	<b>\$1711</b>
Z60144RTE	144 x 60 x 30	656.25	53.25	N/A	<b>\$11684</b>	N/A	<b>\$2054</b>
Z60168RTE	168 x 60 x 30	737.1	58	N/A	<b>\$12598</b>	N/A	<b>\$2396</b>

Racetrack shaped table includes three bases with wire access doors on each side of base and wire concealment runners between bases. Shipped easy to assemble in 5 cartons.

Z48192RTE	192 x 48 x 30	689	45.75	N/A	<b>\$8494</b>	N/A	<b>\$1824</b>
Z48216RTE	216 x 48 x 30	749	48.75	N/A	<b>\$8891</b>	N/A	<b>\$2054</b>
Z48240RTE	240 x 48 x 30	809	51.75	N/A	<b>\$9451</b>	N/A	<b>\$2281</b>
Z48264RTE	264 x 48 x 30	862	54.75	N/A	<b>\$10009</b>	N/A	<b>\$2509</b>
Z48288RTE	288 x 48 x 30	917	57.75	N/A	<b>\$10009</b>	N/A	<b>\$2739</b>

Racetrack shaped table includes four bases with wire access doors on each side of base and wire concealment runners between bases. Shipped easy to assemble in 7 cartons.

Z60192RTE	192 x 60 x 30	901.95	71.25	N/A	<b>\$15850</b>	N/A	<b>\$2739</b>
Z60216RTE	216 x 60 x 30	972.3	76	N/A	<b>\$16734</b>	N/A	<b>\$3081</b>
Z60240RTE	240 x 60 x 30	1057.35	81	N/A	<b>\$17456</b>	N/A	<b>\$3422</b>
Z60264RTE	264 x 60 x 30	1127.7	85.75	N/A	<b>\$18148</b>	N/A	<b>\$3763</b>
Z60288RTE	288 x 60 x 30	1198.05	90.5	N/A	<b>\$19260</b>	N/A	<b>\$4106</b>

Racetrack shaped table includes four bases with wire access doors on each side of base and wire concealment runners between bases. Shipped easy to assemble in 7 cartons.

Z4896REE	96 x 48 x 30	356	22	N/A	<b>\$3562</b>	N/A	<b>\$935</b>
----------	--------------	-----	----	-----	---------------	-----	--------------

Rectangular shaped table includes two bases with wire access doors on each side of base and wire concealment runners between bases. Shipped easy to assemble in 3 cartons.

Z6096REE	96 x 60 x 30	448	35.5	N/A	<b>\$6598</b>	N/A	<b>\$1368</b>
----------	--------------	-----	------	-----	---------------	-----	---------------

Rectangular shaped table includes two bases with wire access doors on each side of base and wire concealment runners between bases. Shipped easy to assemble in 3 cartons.

### Required specifications

Top finish  
Top thickness/edge detail  
Base finish  
Base trim finish

### Optional specifications

HP laminate  
Cut-out for power block

### Accessories

Power block

BOARDROOM TABLES	MODEL #	DIMENSIONS	WT/LB.	CUBIC FT.	1" TOP	1.5" TOP	GLAZE ADD	HP ADD
------------------	---------	------------	--------	-----------	--------	----------	-----------	--------

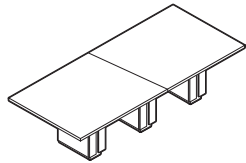

**Boardroom Table - Rectangular**

	W x D x H (1.5" TOP)							
Z48120REE	120 x 48 x 30	472	28.3	N/A	<b>\$4824</b>	N/A	<b>\$1170</b>	
Z48144REE	144 x 48 x 30	525	30.5	N/A	<b>\$5166</b>	N/A	<b>\$1405</b>	
Z48168REE	168 x 48 x 30	583	37.25	N/A	<b>\$6708</b>	N/A	<b>\$1597</b>	

Rectangular shaped table includes three bases with wire access doors on each side of base and wire concealment runners between bases. Z48144REE and Z48120REE shipped easy to assemble in 4 cartons. Z48168REE shipped easy to assemble in 5 cartons.

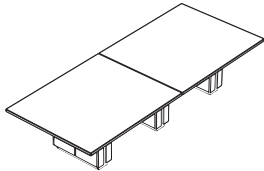

**Boardroom Table - Rectangular**

Z60120REE	120 x 60 x 30	618	48.5	N/A	<b>\$10001</b>	N/A	<b>\$1711</b>	
Z60144REE	144 x 60 x 30	688	53.25	N/A	<b>\$10705</b>	N/A	<b>\$2054</b>	
Z60168REE	168 x 60 x 30	769	58	N/A	<b>\$11532</b>	N/A	<b>\$2396</b>	

Rectangular shaped table includes three bases with wire access doors on each side of base and wire concealment runners between bases. Shipped easy to assemble in 5 cartons.

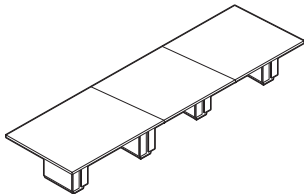

**Boardroom Table - Rectangular**

Z48192REE	192 x 48 x 30	708	45.75	N/A	<b>\$8397</b>	N/A	<b>\$1824</b>	
Z48216REE	216 x 48 x 30	768	48.75	N/A	<b>\$8791</b>	N/A	<b>\$2054</b>	
Z48240REE	240 x 48 x 30	828	51.75	N/A	<b>\$9351</b>	N/A	<b>\$2281</b>	
Z48264REE	264 x 48 x 30	882	54.75	N/A	<b>\$9909</b>	N/A	<b>\$2509</b>	
Z48288REE	288 x 48 x 30	936	57.75	N/A	<b>\$9909</b>	N/A	<b>\$2739</b>	

Rectangular shaped table includes four bases with wire access doors on each side of base and wire concealment runners between bases. Shipped easy to assemble in 7 cartons.

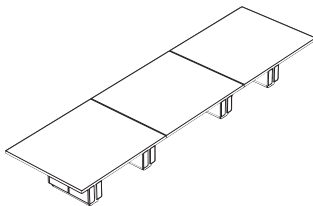

**Boardroom Table - Rectangular**

Z60192REE	192 x 60 x 30	941.85	71.25	N/A	<b>\$14523</b>	N/A	<b>\$2739</b>	
Z60216REE	216 x 60 x 30	1003.8	76	N/A	<b>\$15334</b>	N/A	<b>\$3081</b>	
Z60240REE	240 x 60 x 30	1088.85	81	N/A	<b>\$15992</b>	N/A	<b>\$3422</b>	
Z60264REE	264 x 60 x 30	1159.2	85.75	N/A	<b>\$16619</b>	N/A	<b>\$3763</b>	
Z60288REE	288 x 60 x 30	1229.55	90.5	N/A	<b>\$17624</b>	N/A	<b>\$4106</b>	

Rectangular shaped table includes four bases with wire access doors on each side of base and wire concealment runners between bases. Shipped easy to assemble in 7 cartons.

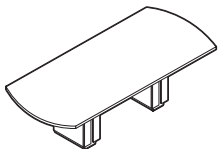

**Boardroom Table - Bow End**

Z4896BW	96 x 48 x 30	329	22	N/A	<b>\$3688</b>	N/A	<b>\$935</b>	
---------	--------------	-----	----	-----	---------------	-----	--------------	--

Bow end table includes two bases with wire access doors on each side of base and wire concealment runners between bases. Shipped easy to assemble in 3 cartons.

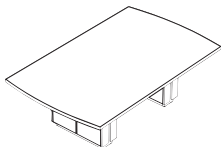

**Boardroom Table - Bow End**

Z6096BW	96 x 60 x 30	436	35.5	N/A	<b>\$7197</b>	N/A	<b>\$1368</b>	
---------	--------------	-----	------	-----	---------------	-----	---------------	--

Bow end table includes two bases with wire access doors on each side of base and wire concealment runners between bases. Shipped easy to assemble in 3 cartons.

**Required specifications**

- Top finish
- Top thickness/edge detail
- Base finish
- Base trim finish

**Optional specifications**

- HP laminate
- Cut-out for power block

**Accessories**

- Power block

# Z ZIRA™ BOARDROOM

## BOARDROOM TABLES

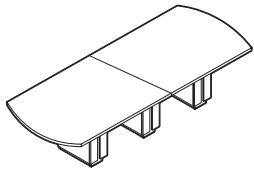

**Boardroom Table - Bow End**

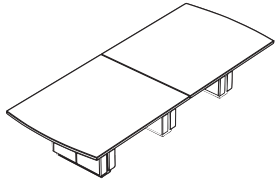

**Boardroom Table - Bow End**

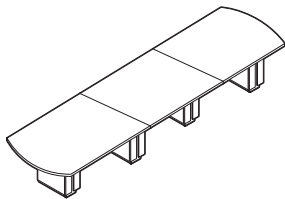

**Boardroom Table - Bow End**

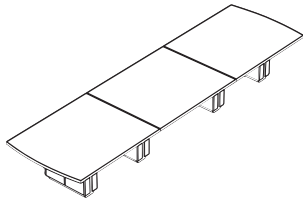

**Boardroom Table - Bow End**

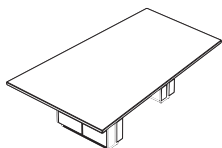

**Boardroom Table - Wedge**

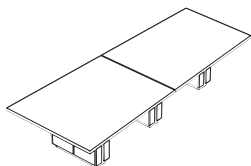

**Boardroom Table - Wedge**

MODEL #	DIMENSIONS W x D x H (1.5" TOP)	WT/LB.	CUBIC FT.	1" TOP	1.5" TOP	GLAZE ADD	HP ADD
Z48120BW	120 x 48 x 30	476	28.3	N/A	<b>\$4914</b>	N/A	<b>\$1170</b>
Z48144BW	144 x 48 x 30	513	30.5	N/A	<b>\$5259</b>	N/A	<b>\$1405</b>
Z48168BW	168 x 48 x 30	573	37.25	N/A	<b>\$6739</b>	N/A	<b>\$1597</b>

Bow end table includes three bases with wire access doors on each side of base and wire concealment runners between bases. Z48144BW and Z48120BW shipped easy to assemble in 4 cartons. Z48168BW shipped easy to assemble in 5 cartons.

Z60120BW	120 x 60 x 30	602	48.5	N/A	<b>\$10918</b>	N/A	<b>\$1711</b>
Z60144BW	144 x 60 x 30	673	53.25	N/A	<b>\$11684</b>	N/A	<b>\$2054</b>
Z60168BW	168 x 60 x 30	753	58	N/A	<b>\$12598</b>	N/A	<b>\$2396</b>

Bow end table includes three bases with wire access doors on each side of base and wire concealment runners between bases. Shipped easy to assemble in 5 cartons.

Z48192BW	192 x 48 x 30	698	45.75	N/A	<b>\$8426</b>	N/A	<b>\$1824</b>
Z48216BW	216 x 48 x 30	758	48.75	N/A	<b>\$8821</b>	N/A	<b>\$2054</b>
Z48240BW	240 x 48 x 30	818	51.75	N/A	<b>\$9381</b>	N/A	<b>\$2281</b>
Z48264BW	264 x 48 x 30	872	54.75	N/A	<b>\$9939</b>	N/A	<b>\$2509</b>
Z48288BW	288 x 48 x 30	926	57.75	N/A	<b>\$9939</b>	N/A	<b>\$2739</b>

Bow end table includes four bases with wire access doors on each side of base and wire concealment runners between bases. Shipped easy to assemble in 7 cartons.

Z60192BW	192 x 60 x 30	917.7	71.25	N/A	<b>\$15850</b>	N/A	<b>\$2739</b>
Z60216BW	216 x 60 x 30	988.05	76	N/A	<b>\$16734</b>	N/A	<b>\$3081</b>
Z60240BW	240 x 60 x 30	1073.1	81	N/A	<b>\$17456</b>	N/A	<b>\$3422</b>
Z60264BW	264 x 60 x 30	1143.45	85.75	N/A	<b>\$18148</b>	N/A	<b>\$3763</b>
Z60288BW	288 x 60 x 30	1213.8	90.5	N/A	<b>\$19260</b>	N/A	<b>\$4106</b>

Bow end table includes four bases with wire access doors on each side of base and wire concealment runners between bases. Shipped easy to assemble in 7 cartons.

Z6096WE	96 x 60 x 30	398	26.25	N/A	<b>\$7197</b>	N/A	<b>\$1368</b>
---------	--------------	-----	-------	-----	---------------	-----	---------------

Wedge table includes two bases with wire access doors on each side of base and wire concealment runners between bases. Wedge tapers from 60"W to 48"W. Shipped easy to assemble in 3 cartons.

Z60120WE	120 x 60 x 30	544.95	36.5	N/A	<b>\$10918</b>	N/A	<b>\$1711</b>
Z60144WE	144 x 60 x 30	603.75	39.5	N/A	<b>\$11684</b>	N/A	<b>\$2054</b>
Z60168WE	168 x 60 x 30	673.05	42.5	N/A	<b>\$12598</b>	N/A	<b>\$2396</b>

Wedge table includes three bases with wire access doors on each side of base and wire concealment runners between bases. Wedge tapers from 60"W to 48"W. Shipped easy to assemble in 5 cartons.

### Required specifications

Top finish  
Top thickness/edge detail  
Base finish  
Base trim finish

### Optional specifications

HP laminate  
Cut-out for power block

### Accessories

Power block

**BOARDROOM TABLES**      **MODEL #**      **DIMENSIONS**      **WT/LB.**      **CUBIC FT.**      **1" TOP**      **1.5" TOP**      **GLAZE ADD**      **HP ADD**

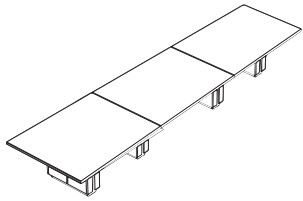

**Boardroom Table - Wedge**

**W x D x H (1.5" TOP)**

Z60192WE	192 x 60 x 30	824.25	63.75	N/A	<b>\$15850</b>	N/A	<b>\$2739</b>
Z60216WE	216 x 60 x 30	884.1	68.25	N/A	<b>\$16734</b>	N/A	<b>\$3081</b>
Z60240WE	240 x 60 x 30	948.15	73	N/A	<b>\$17456</b>	N/A	<b>\$3422</b>
Z60264WE	264 x 60 x 30	1006.95	77.5	N/A	<b>\$18148</b>	N/A	<b>\$3763</b>
Z60288WE	288 x 60 x 30	1065.75	82	N/A	<b>\$19260</b>	N/A	<b>\$4106</b>

Wedge table includes four bases with wire access doors on each side of base and wire concealment runners between bases. Wedge tapers from 60"W to 48"W. Shipped easy to assemble in 7 cartons.

**MEDIA TABLES**

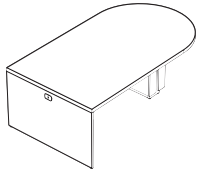

**Media Table - D Island**

Z4860DMIL	60 x 48 x 30	267	17.75	N/A	<b>\$4492</b>	N/A	<b>\$686</b>
Z4872DMIL	72 x 48 x 30	298.2	19.75	N/A	<b>\$4813</b>	N/A	<b>\$821</b>
Z4884DMIL	84 x 48 x 30	326.55	21.5	N/A	<b>\$5122</b>	N/A	<b>\$958</b>
Z4896DMIL	96 x 48 x 30	347.55	23.5	N/A	<b>\$5427</b>	N/A	<b>\$1096</b>

D media island table includes one base with wire access doors on each side of base and wire concealment runners between the base and the end panel. Grommet centered at the top of the end panel for wire pass through. Shipped easy to assemble in 3 cartons.

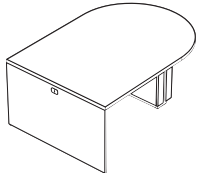

**Media Table - D Island**

Z6060DMIL	60 x 60 x 30	323.92	23.25	N/A	<b>\$5383</b>	N/A	<b>\$857</b>
Z6072DMIL	72 x 60 x 30	359.1	25.75	N/A	<b>\$5760</b>	N/A	<b>\$1027</b>
Z6084DMIL	84 x 60 x 30	397.95	28	N/A	<b>\$6151</b>	N/A	<b>\$1200</b>
Z6096DMIL	96 x 60 x 30	433.65	30.5	N/A	<b>\$6512</b>	N/A	<b>\$1368</b>

D media island table includes one base with wire access doors on each side of base and wire concealment runners between the base and the end panel. Grommet centered at the top of the end panel for wire pass through. Shipped easy to assemble in 3 cartons.

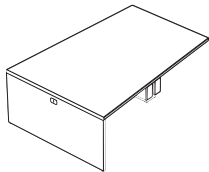

**Media Table - Wedge**

Z6060WMIL	60 x 60 x 30	306.6	20.75	N/A	<b>\$5383</b>	N/A	<b>\$857</b>
Z6072WMIL	72 x 60 x 30	338.1	23	N/A	<b>\$5760</b>	N/A	<b>\$1027</b>
Z6084WMIL	84 x 60 x 30	374.85	25.5	N/A	<b>\$6151</b>	N/A	<b>\$1200</b>
Z6096WMIL	96 x 60 x 30	407.4	28	N/A	<b>\$6512</b>	N/A	<b>\$1368</b>

Wedge media island table includes one base with wire access doors on each side of base and wire concealment runners between the base and the end panel. Grommet centered at the top of the end panel for wire pass through. Wedge tapers from 60"W to 48"W. Shipped easy to assemble in 3 cartons.

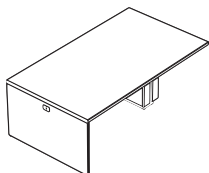

**Media Table - Rectangular Island**

Z4860RMIL	60 x 48 x 30	279.3	17.75	N/A	<b>\$4132</b>	N/A	<b>\$686</b>
Z4872RMIL	72 x 48 x 30	307.65	19.75	N/A	<b>\$4429</b>	N/A	<b>\$821</b>
Z4884RMIL	84 x 48 x 30	337.05	21.5	N/A	<b>\$4706</b>	N/A	<b>\$958</b>
Z4896RMIL	96 x 48 x 30	357	23.5	N/A	<b>\$4986</b>	N/A	<b>\$1096</b>

Rectangular media island table includes one base with wire access doors on each side of base and wire concealment runners between the base and the end panel. Grommet centered at the top of the end panel for wire pass through. Shipped easy to assemble in 3 cartons.

**Required specifications**

- Top finish
- Top thickness/edge detail
- Base finish
- Base trim finish

**Optional specifications**

- HP laminate
- Cut-out for power block

**Accessories**

- Power block

# Z ZIRA™ BOARDROOM

## MEDIA TABLES

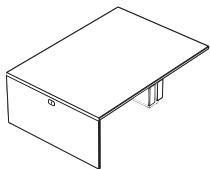

**Media Table - Rectangular Island**

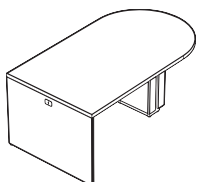

**Media Table - D Island, 36.5" H**

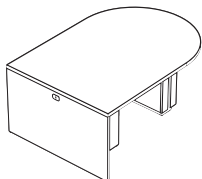

**Media Table - D Island, 36.5" H**

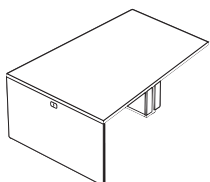

**Media Table - Wedge, 36.5" H**

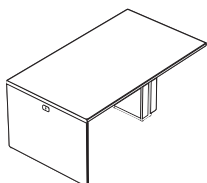

**Media Table - Rectangular Island, 36.5" H**

MODEL #	DIMENSIONS W x D x H (1.5" TOP)	WT/LB.	CUBIC FT.	1" TOP	1.5" TOP	GLAZE ADD	HP ADD
Z6060RMIL	60 x 60 x 30	339.15	23.25	N/A	<b>\$4946</b>	N/A	<b>\$857</b>
Z6072RMIL	72 x 60 x 30	373.8	25.75	N/A	<b>\$5290</b>	N/A	<b>\$1027</b>
Z6084RMIL	84 x 60 x 30	414.75	28	N/A	<b>\$5643</b>	N/A	<b>\$1200</b>
Z6096RMIL	96 x 60 x 30	449.4	30.5	N/A	<b>\$5971</b>	N/A	<b>\$1368</b>

Rectangular media island table includes one base with wire access doors on each side of base and wire concealment runners between the base and the end panel. Grommet centered at the top of the end panel for wire pass through. Shipped easy to assemble in 3 cartons.

Z4860DMIM	60 x 48 x 36.5	291.9	19.25	N/A	<b>\$4904</b>	N/A	<b>\$686</b>
Z4872DMIM	72 x 48 x 36.5	321.3	21.25	N/A	<b>\$5232</b>	N/A	<b>\$821</b>
Z4884DMIM	84 x 48 x 36.5	349.65	23	N/A	<b>\$5541</b>	N/A	<b>\$958</b>
Z4896DMIM	96 x 48 x 36.5	370.65	25	N/A	<b>\$5843</b>	N/A	<b>\$1096</b>

D media island table includes one base with wire access doors on each side of base and wire concealment runners between the base and the end panel. Grommet centered at the top of the end panel for wire pass through. Shipped easy to assemble in 3 cartons.

Z6060DMIM	60 x 60 x 36.5	352.27	25.5	N/A	<b>\$5797</b>	N/A	<b>\$857</b>
Z6072DMIM	72 x 60 x 36.5	386.4	27.75	N/A	<b>\$6174</b>	N/A	<b>\$1027</b>
Z6084DMIM	84 x 60 x 36.5	426.3	30.25	N/A	<b>\$6565</b>	N/A	<b>\$1200</b>
Z6096DMIM	96 x 60 x 36.5	462	32.75	N/A	<b>\$6923</b>	N/A	<b>\$1368</b>

D media island table includes one base with wire access doors on each side of base and wire concealment runners between the base and the end panel. Grommet centered at the top of the end panel for wire pass through. Shipped easy to assemble in 3 cartons.

Z6060WMIM	60 x 60 x 36.5	331.8	22.25	N/A	<b>\$5797</b>	N/A	<b>\$857</b>
Z6072WMIM	72 x 60 x 36.5	364.35	24.75	N/A	<b>\$6174</b>	N/A	<b>\$1027</b>
Z6084WMIM	84 x 60 x 36.5	424.2	27	N/A	<b>\$6565</b>	N/A	<b>\$1200</b>
Z6096WMIM	96 x 60 x 36.5	432.6	29.5	N/A	<b>\$6923</b>	N/A	<b>\$1368</b>

Wedge media island table includes one base with wire access doors on each side of base and wire concealment runners between the base and the end panel. Grommet centered at the top of the end panel for wire pass through. Wedge tapers from 60" W to 48" W. Shipped easy to assemble in 3 cartons.

Z4860RMIM	60 x 48 x 36.5	301.35	19.25	N/A	<b>\$4509</b>	N/A	<b>\$686</b>
Z4872RMIM	72 x 48 x 36.5	330.75	21.25	N/A	<b>\$4807</b>	N/A	<b>\$821</b>
Z4884RMIM	84 x 48 x 36.5	360.15	23	N/A	<b>\$5086</b>	N/A	<b>\$958</b>
Z4896RMIM	96 x 48 x 36.5	380.1	25	N/A	<b>\$5364</b>	N/A	<b>\$1096</b>

Rectangular media island table includes one base with wire access doors on each side of base and wire concealment runners between the base and the end panel. Grommet centered at the top of the end panel for wire pass through. Shipped easy to assemble in 3 cartons.

### Required specifications

Top finish  
Top thickness/edge detail  
Base finish  
Base trim finish

### Optional specifications

HP laminate  
Cut-out for power block

### Accessories

Power block

MEDIA TABLES	MODEL #	DIMENSIONS	WT/LB.	CUBIC FT.	1" TOP	1.5" TOP	GLAZE ADD	HP ADD
--------------	---------	------------	--------	-----------	--------	----------	-----------	--------

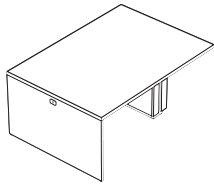

**Media Table - Rectangular Island, 36.5"H**

	W x D x H (1.5" TOP)							
Z6060RMIM	60 x 60 x 36.5	367.5	25.5	N/A	<b>\$5320</b>	N/A	<b>\$857</b>	
Z6072RMIM	72 x 60 x 36.5	402.15	27.75	N/A	<b>\$5662</b>	N/A	<b>\$1027</b>	
Z6084RMIM	84 x 60 x 36.5	442.05	30.25	N/A	<b>\$6016</b>	N/A	<b>\$1200</b>	
Z6096RMIM	96 x 60 x 36.5	477.75	32.75	N/A	<b>\$6343</b>	N/A	<b>\$1368</b>	

Rectangular media island table includes one base with wire access doors on each side of base and wire concealment runners between the base and the end panel. Grommet centered at the top of the end panel for wire pass through. Shipped easy to assemble in 3 cartons.

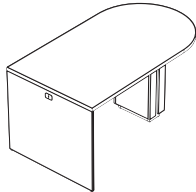

**Media Table - D Island, 42.5"H**

Z4860DMIH	60 x 48 x 42.5	312.9	20.75	N/A	<b>\$5218</b>	N/A	<b>\$686</b>	
Z4872DMIH	72 x 48 x 42.5	342.3	22.75	N/A	<b>\$5546</b>	N/A	<b>\$821</b>	
Z4884DMIH	84 x 48 x 42.5	371.7	24.5	N/A	<b>\$5854</b>	N/A	<b>\$958</b>	
Z4896DMIH	96 x 48 x 42.5	391.65	26.5	N/A	<b>\$6156</b>	N/A	<b>\$1096</b>	

D media island table includes one base with wire access doors on each side of base and wire concealment runners between the base and the end panel. Grommet centered at the top of the end panel for wire pass through. Shipped easy to assemble in 3 cartons.

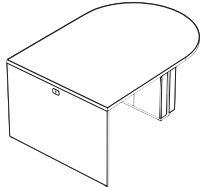

**Media Table - D Island, 42.5"H**

Z6060DMIH	60 x 60 x 42.5	378	27.5	N/A	<b>\$6111</b>	N/A	<b>\$857</b>	
Z6072DMIH	72 x 60 x 42.5	413.7	30	N/A	<b>\$6487</b>	N/A	<b>\$1027</b>	
Z6084DMIH	84 x 60 x 42.5	453.6	32.5	N/A	<b>\$6878</b>	N/A	<b>\$1200</b>	
Z6096DMIH	96 x 60 x 42.5	488.25	35	N/A	<b>\$7238</b>	N/A	<b>\$1368</b>	

D media island table includes one base with wire access doors on each side of base and wire concealment runners between the base and the end panel. Grommet centered at the top of the end panel for wire pass through. Shipped easy to assemble in 3 cartons.

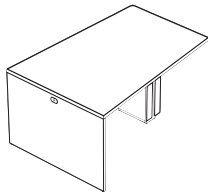

**Media Table - Wedge, 42.5"H**

Z6060WMIH	60 x 60 x 42.5	355	24	N/A	<b>\$6111</b>	N/A	<b>\$857</b>	
Z6072WMIH	72 x 60 x 42.5	387	26.25	N/A	<b>\$6487</b>	N/A	<b>\$1027</b>	
Z6084WMIH	84 x 60 x 42.5	424	28.75	N/A	<b>\$6878</b>	N/A	<b>\$1200</b>	
Z6096WMIH	96 x 60 x 42.5	457	31.25	N/A	<b>\$7238</b>	N/A	<b>\$1368</b>	

Wedge media island table includes one base with wire access doors on each side of base and wire concealment runners between the base and the end panel. Grommet centered at the top of the end panel for wire pass through. Wedge tapers from 60"W to 48"W. Shipped easy to assemble in 3 cartons.

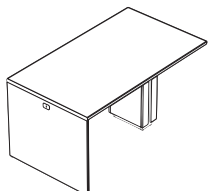

**Media Table - Rectangular Island, 42.5"H**

Z4860RMIH	60 x 48 x 42.5	324	20.75	N/A	<b>\$4794</b>	N/A	<b>\$686</b>	
Z4872RMIH	72 x 48 x 42.5	353	22.75	N/A	<b>\$5091</b>	N/A	<b>\$821</b>	
Z4884RMIH	84 x 48 x 42.5	382	24.5	N/A	<b>\$5371</b>	N/A	<b>\$958</b>	
Z4896RMIH	96 x 48 x 42.5	402	26.5	N/A	<b>\$5651</b>	N/A	<b>\$1096</b>	

Rectangular media island table includes one base with wire access doors on each side of base and wire concealment runners between the base and the end panel. Grommet centered at the top of the end panel for wire pass through. Shipped easy to assemble in 3 cartons.

**Required specifications**

- Top finish
- Top thickness/edge detail
- Base finish
- Base trim finish

**Optional specifications**

- HP laminate
- Cut-out for power block

**Accessories**

- Power block

# Z ZIRA™ BOARDROOM

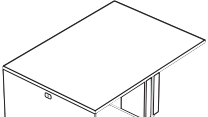
MEDIA TABLES	MODEL #	DIMENSIONS	WT/LB.	CUBIC FT.	1" TOP	1.5" TOP	GLAZE ADD	HP ADD
	<b>W x D x H (1.5" TOP)</b>							
	Z6060RMIH	60 x 60 x 42.5	394	27.5	N/A	<b>\$5605</b>	N/A	<b>\$857</b>
	Z6072RMIH	72 x 60 x 42.5	429	30	N/A	<b>\$5947</b>	N/A	<b>\$1027</b>
	Z6084RMIH	84 x 60 x 42.5	469	32.5	N/A	<b>\$6301</b>	N/A	<b>\$1200</b>
	Z6096RMIH	96 x 60 x 42.5	504	35	N/A	<b>\$6629</b>	N/A	<b>\$1368</b>

**Media Table - Rectangular Island, 42.5"H**

Rectangular media island table includes one base with wire access doors on each side of base and wire concealment runners between the base and the end panel. Grommet centered at the top of the end panel for wire pass through. Shipped easy to assemble in 3 cartons.

METAL BASE COVERS FOR MEDIA TABLES	LIST PRICE							
------------------------------------	------------	--	--	--	--	--	--	--

	Z48BEC	22.5 x 12.2 x 4.3	5	1.5	<b>\$513</b>			
	Z60BEC	34.5 x 12.2 x 4.3	6	2	<b>\$561</b>			

**Metal Base Cover for Media Tables**

For use on Zira media tables. Can also be used on any Zira boardroom table of corresponding width. Acts as a cap at the upper part of a base to hide any wire or power block that may be visible to users. Available in Black or Silver finish. Shipped easy to assemble in 1 carton.

COLLABORATIVE TABLES	LIST PRICE							
----------------------	------------	--	--	--	--	--	--	--

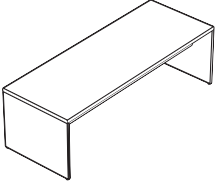
	<b>W x D x H (1.5" TOP)</b>							
	Z367229BT	72 x 36 x 30	237	13	N/A	<b>\$2219</b>	N/A	<b>\$615</b>
	Z368429BT	84 x 36 x 30	263	14.75	N/A	<b>\$2583</b>	N/A	<b>\$719</b>
	Z369629BT	96 x 36 x 30	289	16.5	N/A	<b>\$2792</b>	N/A	<b>\$821</b>

**Collaborative Table, 30"H**

Collaborative table with full end panels. Wire management runners span the length of the table between end panels. Shipped easy to assemble in 3 cartons.

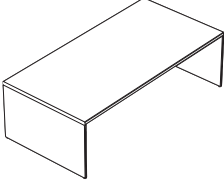
	Z487229BT	72 x 48 x 30	302	14	N/A	<b>\$2783</b>	N/A	<b>\$821</b>
	Z488429BT	84 x 48 x 30	335	15.75	N/A	<b>\$2996</b>	N/A	<b>\$958</b>
	Z489629BT	96 x 48 x 30	360	17.5	N/A	<b>\$3246</b>	N/A	<b>\$1096</b>

**Collaborative Table, 30"H**

Collaborative table with full end panels. Wire management runners span the length of the table between end panels. Shipped easy to assemble in 3 cartons.

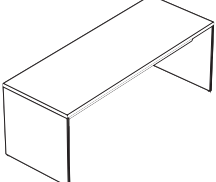
	Z367236BT	72 x 36 x 36.5	249	13.25	N/A	<b>\$2299</b>	N/A	<b>\$615</b>
	Z368436BT	84 x 36 x 36.5	275	15	N/A	<b>\$2664</b>	N/A	<b>\$719</b>
	Z369636BT	96 x 36 x 36.5	301	16.75	N/A	<b>\$2881</b>	N/A	<b>\$821</b>

**Collaborative Table, 36.5"H**

Collaborative table with full end panels. Wire management runners span the length of the table between end panels. Shipped easy to assemble in 3 cartons.

**Required specifications**

Top finish  
Top thickness/edge detail  
Base finish  
Base trim finish

**Optional specifications**

HP laminate  
Cut-out for power block

**Accessories**

Power block



**COLLABORATIVE TABLES**

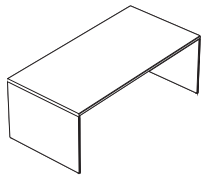

**Collaborative Table, 36.5”H**

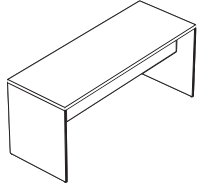

**Collaborative Table, 42.5”H**

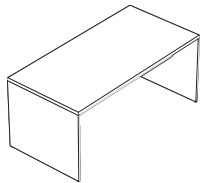

**Collaborative Table, 42.5”H**

MODEL #	DIMENSIONS W x D x H (1.5" TOP)	WT/LB.	CUBIC FT.	1"TOP	1.5" TOP	GLAZE ADD	HP ADD
Z487236BT	72 x 48 x 36.5	319	14.5	N/A	<b>\$2893</b>	N/A	<b>\$821</b>
Z488436BT	84 x 48 x 36.5	351	16.25	N/A	<b>\$3106</b>	N/A	<b>\$958</b>
Z489636BT	96 x 48 x 36.5	376	18	N/A	<b>\$3357</b>	N/A	<b>\$1096</b>

Collaborative table with full end panels. Wire management runners span the length of the table between end panels. Shipped easy to assemble in 3 cartons.

Z367242BT	72 x 36 x 42.5	283	14.25	N/A	<b>\$2572</b>	N/A	<b>\$615</b>
Z368442BT	84 x 36 x 42.5	312	16	N/A	<b>\$2967</b>	N/A	<b>\$719</b>
Z369642BT	96 x 36 x 42.5	342	18	N/A	<b>\$3213</b>	N/A	<b>\$821</b>

Collaborative table with full end panels. Wire management runners span the length of the table between end panels. Shipped easy to assemble in 3 cartons.

Z487242BT	72 x 48 x 42.5	356	15.5	N/A	<b>\$3189</b>	N/A	<b>\$821</b>
Z488442BT	84 x 48 x 42.5	392	17.5	N/A	<b>\$3434</b>	N/A	<b>\$958</b>
Z489642BT	96 x 48 x 42.5	421	19.25	N/A	<b>\$3711</b>	N/A	<b>\$1096</b>

Collaborative table with full end panels. Wire management runners span the length of the table between end panels. Shipped easy to assemble in 3 cartons.

**AUDIOVISUAL**

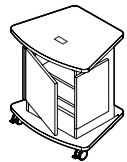

**Multimedia Cart\***

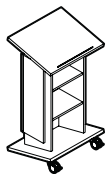

**Lectern\***

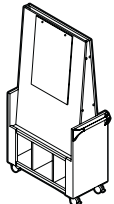

**Visual Board\*\***

Z2822MCE	28 x 22.25 x 29.5	86	13.5	<b>\$845</b>	<b>\$908</b>	N/A	<b>\$174</b>
----------	-------------------	----	------	--------------	--------------	-----	--------------

Multimedia cart features one non-locking hinged door on the back. Includes three fixed shelves, one grommet on top and one grommet in bottom panel for wire pass-through. Four locking casters included. Shipped assembled in 1 carton.

Z2444LEC	24 x 18 x 44.3	100	17	<b>\$820</b>	<b>\$868</b>	N/A	<b>\$174</b>
----------	----------------	-----	----	--------------	--------------	-----	--------------

Features angled stand and storage with two fixed shelves. Two locking casters included. Shipped assembled in 1 carton.

Z361872VB	36 x 18 x 72.4	187	26.5	<b>\$2698</b>	N/A	N/A	N/A
-----------	----------------	-----	------	---------------	-----	-----	-----

Angled visual board with paper pad on one side and dry erase board on the opposite side. Unique push handles are standard. Locking casters included. Decorative aluminum trim is standard on the lip of each shelf. Height aligns with 36" buffets. Shipped easy to assemble in 2 cartons.

- Wall mounted visual boards are available on page 47.

**Required specifications**

Top finish (not Z361872VB)  
Top thickness/edge detail\*  
Base finish  
Base trim finish

**Optional specifications**

HP laminate  
Cut-out for power block (collaborative tables only)

**Accessories**

Power block (collaborative tables only)

Push bar finish\*\*

# Z ZIRA™ BOARDROOM

ACCESSORIES	MODEL #	DIMENSIONS	WT/LB.	CUBIC FT.	1" TOP	1.5" TOP	GLAZE ADD	HP ADD
		W x D x H						
<p><b>Serving Cart with Doors*</b></p>	Z361836KD	36 x 18 x 36	150	20	<b>\$1718</b>	N/A	<b>\$438</b>	N/A
	Z361829KD	36 x 18 x 29	113	16	<b>\$1455</b>	N/A	<b>\$366</b>	N/A
<p>Cart features two doors with lock and one fixed height adjustable shelf. Top is recessed within side and end panels to act as a tray. Unique push handles are standard on both sides of the cart. Four locking casters included. Please specify handles. Shipped assembled in 1 carton.</p>								
<p><b>Serving Cart</b></p>	Z361836KO	36 x 18 x 36	121	20	<b>\$1865</b>	N/A	N/A	N/A
	Z361829KO	36 x 18 x 29	108	16	<b>\$1561</b>	N/A	N/A	N/A
<p>Cart features one fixed height adjustable shelf. Top is recessed within side and end panels to act as a tray. Decorative aluminum trim is standard on the lip of each shelf. Unique push handles are standard on both sides of the cart. Four locking casters included. Shipped assembled in 1 carton.</p>								
<p><b>Buffet Cart</b></p>	Z261836BK	26 x 18 x 36	79	14.9	<b>\$1771</b>	N/A	N/A	<b>\$174</b>
<p>Cart features one fixed shelf. Top is recessed within side and end panels to act as a tray. Unique push handles are standard. Decorative aluminum trim is standard on the lip of each shelf. Locking casters included. Height aligns with 36" buffets. Shipped assembled in 1 carton.</p>								
<p><b>Buffet</b></p>	Z481836BO	48 x 18 x 36	152.5	22.5	<b>\$1641</b>	N/A	N/A	<b>\$234</b>
	Z481829BO	48 x 18 x 29	135	18	<b>\$1514</b>	N/A	N/A	<b>\$234</b>
	Z361836BO	36 x 18 x 36	126	18	<b>\$1352</b>	N/A	N/A	<b>\$174</b>
	Z361829BO	36 x 18 x 29	112	14	<b>\$1244</b>	N/A	N/A	<b>\$174</b>
<p>Buffet features one fixed height adjustable shelf. Top is recessed within side and end panels to act as a tray. Decorative aluminum trim is standard on the lip of each shelf. Shipped assembled in 1 carton.</p>								
<p><b>Buffet with Doors*</b></p>	Z481836BD	48 x 18 x 36	171	22.5	<b>\$1709</b>	N/A	<b>\$382</b>	<b>\$234</b>
	Z481829BD	48 x 18 x 29	148	18	<b>\$1524</b>	N/A	<b>\$439</b>	<b>\$234</b>
	Z361836BD	36 x 18 x 36	138.5	18	<b>\$1517</b>	N/A	<b>\$438</b>	<b>\$174</b>
	Z361829BD	36 x 18 x 29	119	14	<b>\$1278</b>	N/A	<b>\$366</b>	<b>\$174</b>
<p>Buffet features two doors with lock and one fixed height adjustable shelf. Top is recessed within side and end panels to act as a tray. Shipped assembled in 1 carton.</p>								
<p><b>Buffet with Doors*</b></p>	Z482036BD	48 x 20 x 36	199	24.7	<b>\$2494</b>	<b>\$2636</b>	<b>\$1098</b>	<b>\$477</b>
<p>Buffet features two drawers and two doors with lock. One fixed height adjustable shelf. Shipped assembled in 1 carton.</p>								

**Required specifications**

Top finish  
 Top/edge detail (only Z482036BD)  
 Push bar finish (only ZxxxxxKD/KO/BK)  
 Aluminum trim finish (only ZxxxxxBO/BU)

Base finish  
 Handles\*

**Optional specifications**

HP laminate  
 Glazed door\*  
 Key #\*

**ACCESSORIES**      **MODEL #**      **DIMENSIONS**      **WT/LB.**      **CUBIC FT.**      **1" TOP**      **1.5" TOP**      **GLAZE ADD**      **HP ADD**

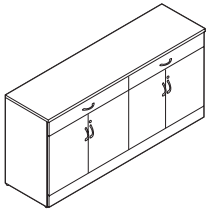

**Buffet with Doors\***

	W x D x H							
Z602036BD	60 x 20 x 36	228	30.75	<b>\$3159</b>	<b>\$3354</b>	<b>\$2193</b>	<b>\$759</b>	
Z722036BD	72 x 20 x 36	265	36.5	<b>\$3632</b>	<b>\$3827</b>	<b>\$2193</b>	<b>\$759</b>	

Buffet features two drawers and four doors with lock. Two fixed height adjustable shelves. Shipped assembled in 1 carton.

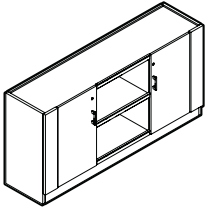

**Buffet with Doors**

Z721836BU	72 x 18 x 36	242	33.5	<b>\$2527</b>	N/A	<b>\$529</b>	<b>\$351</b>	
Z721829BU	72 x 18 x 29	211	27	<b>\$2283</b>	N/A	<b>\$438</b>	<b>\$351</b>	
Z601836BU	60 x 18 x 36	188	28	<b>\$2272</b>	N/A	<b>\$438</b>	<b>\$293</b>	
Z601829BU	60 x 18 x 29	163	22.5	<b>\$2079</b>	N/A	<b>\$366</b>	<b>\$293</b>	

Buffet features three separate compartments. The two outer compartments come standard with locking doors and each features one fixed height adjustable shelf. The center compartment is open with one fixed height adjustable shelf. Decorative aluminum trim is standard on the lip of the open shelf. Top is recessed within side and end panels to act as a tray. Shipped assembled in 1 carton.

**Required specifications**

- Top finish
- Top/edge detail\*
- Base finish
- Handles

**Optional specifications**

- HP laminate
- Glazed door
- Key #

## RECEPTION DESKS AND RETURNS

- Offered with **straight** and **bow** front transaction tops.
- **Transaction tops** available in 1" or 1.5" thick top with a variety of edge details.
- **Worksurface** available in 1" thickness with A3 edge only.
- Widths and depths listed are outside dimensions including transaction top overhang front and sides or outside surrounds modesty panels and gables. Model numbers reflect primary worksurface dimensions.

## TOP AND BASE FINISHES

<b>ACJ</b> Absolute Acajou	<b>FCL</b> First Class
<b>ASN</b> Asian Night	<b>NBL</b> Noce Biondo
<b>AWC</b> Avant Cherry	<b>NGL</b> Noce Grigio
<b>AWH</b> Avant Honey	<b>NEL</b> Noce Leggero
<b>BLK</b> Black	<b>NML</b> Noce Medio
<b>BZD</b> Blizzard	<b>QTM</b> Quartered Mahogany
<b>BRC</b> Brushed Cobalt	<b>SBY</b> Sheer Beauty
<b>CMB</b> Clear Maple	<b>SDT</b> Stonedust
<b>CGY</b> Custom Grey	<b>SOG</b> Storm Grey
<b>DES</b> Dark Espresso	<b>WHE</b> Walnut Heights
<b>DWT</b> Designer White	<b>WHC</b> White Chocolate
<b>FAS</b> Fashionista	<b>WCR</b> Winter Cherry

## RECEPTION DESKS

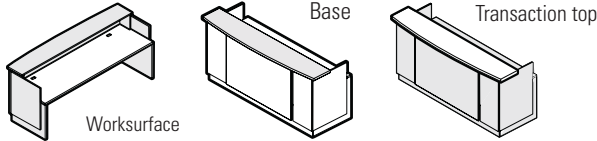

## RECEPTION RETURNS

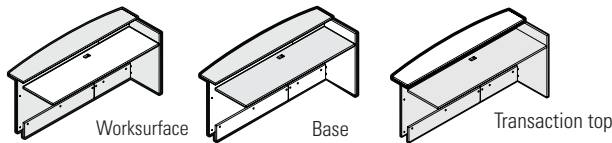

## TRANSACTION TOP THICKNESS/EDGE DETAIL



**A3** 1" top, standard flat edge



**AR** 1" top, bicut edge



**C3** 1.5" top, standard flat edge



**CR** 1.5" top, bicut edge



**CF** 1.5" top, fluted edge

## GLAZING (Center Panels)



**Z1** frosted glazing, Tungsten (TUN) frame



**Z2** frosted glazing, Black (BLK) frame



**Z3** ribbed glazing, Tungsten (TUN) frame



**Z4** ribbed glazing, Black (BLK) frame

## GROMMETS

- Two grommets are standard in position **FOG1** and **FOG3**.
- Standard grommets can be removed at an upcharge.
- Optional grommets available in **FOG2**.

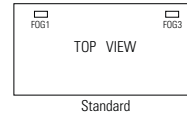
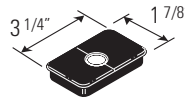

Standard

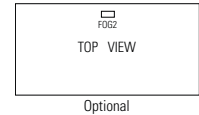

Optional

- Grommet hole dimensions are 3.25"W x 1.875"D.

## POWER BLOCK

- A power block (model **PMSPDM**) may be ordered on transaction tops.
- A power block is a rectangular worksurface power/data module with one electrical duplex receptacle and two data (RJ45) receptacles. 9 foot Black cord included. Power block dimensions are 6.5"W x 3.5"D x 2.75"H.
- To purchase a power block, you must specify both the power block cut-out location and the power block model #. Order power block as **PMSPDM**. Add \$268. Power blocks are available in standard worksurface locations (left, center or right). Order as **E1, E2** or **E3**. Add \$91.



Power block **PMSPDM**. Add \$268.

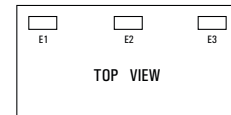

Specify location **E1, E2** or **E3**. Add \$91.

## TASK LIGHT

- Illuminates worksurface and optional glazed center panel.
- Specify LED task light separately. Use PLED50 for 60", 66" and 72" wide reception units. Use PLED50 or PLED100 for 84" and 96" wide units. See page 466 for details.

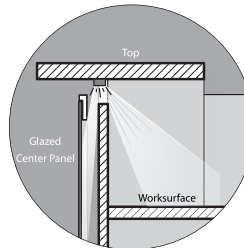

## RECEPTION RETURNS - PIGEON

- Available in all laminates.
- Worksurface available in 1" thickness with A3 edge only.
- Collator shelves offered in Black (**BLK**) or Brushed Cobalt (**BRC**).
- One grommet is standard in position **FOG3**.
- Standard grommet can be removed at an upcharge.
- Optional grommet available in position **FOG2**, see upcharges above.
- Power blocks are available in positions **E2** and **E3**.



Worksurface

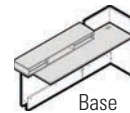

Base

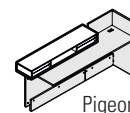

Pigeon

## RECEPTION RETURNS - BOOKCASE

- Available in all laminates listed above.
- Worksurface available in 1" thickness with A3 edge only.
- One grommet is standard in position **FOG2**.
- Standard grommet can be removed at an upcharge.
- Optional grommet available in position **FOG3** for **54", 60" and 72" wide units only**.
- Power blocks are available in positions **E2** and **E3** for **54", 60" and 72" wide units only**.

RECEPTION DESKS	MODEL #	DIMENSIONS	WT/LB.	CUBIC FT.	1" TOP	1.5" TOP	GLAZE ADD	HP ADD
		W x D x H (1.5" TOP)						
	Z3096RDS	96 x 35.5 x 43.3	415	23.25	\$3270	\$3445	\$668	\$818
	Z3084RDS	89.4 x 35.5 x 43.3	368	20.5	\$2907	\$3063	\$575	\$717
	Z3072RDS	77.4 x 35.5 x 43.3	331	18	\$2680	\$2815	\$483	\$613
	Z3066RDS	71.4 x 35.5 x 43.3	313	17	\$2541	\$2672	\$436	\$564
	Z3060RDS	65.4 x 35.5 x 43.3	295	16	\$2390	\$2545	\$387	\$513
	Z2496RDS	96 x 30 x 43.3	380	22	\$3083	\$3258	\$668	\$702
	Z2484RDS	89.4 x 30 x 43.3	338	19.5	\$2747	\$2903	\$575	\$613
	Z2472RDS	77.4 x 30 x 43.3	303	17	\$2528	\$2669	\$483	\$526
	Z2466RDS	71.4 x 30 x 43.3	287	16	\$2396	\$2527	\$436	\$484
	Z2460RDS	65.4 x 30 x 43.3	269	15	\$2283	\$2403	\$387	\$439

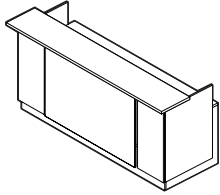

Reception Desk\*\*

**Z24xxRDS not freestanding, must be connected to a return. Z30xxRDS can be used as freestanding.** Standard with two grommets. Accommodates shells of all depths. Shipped easy to assemble in 3 cartons.

	Z3096RDB	96 x 35.5 x 43.3	412	23.25	\$3270	\$3445	\$668	\$818
	Z3084RDB	89.4 x 35.5 x 43.3	365	20.5	\$2907	\$3063	\$575	\$717
	Z3072RDB	77.4 x 35.5 x 43.3	328	18	\$2680	\$2815	\$483	\$613
	Z3066RDB	71.4 x 35.5 x 43.3	310	17	\$2541	\$2672	\$436	\$564
	Z3060RDB	65.4 x 35.5 x 43.3	292	16	\$2390	\$2545	\$387	\$513
	Z2496RDB	96 x 30 x 43.3	377	22	\$3083	\$3258	\$668	\$702
	Z2484RDB	89.4 x 30 x 43.3	335	19.5	\$2747	\$2903	\$575	\$613
	Z2472RDB	77.4 x 30 x 43.3	300	17	\$2528	\$2669	\$483	\$526
	Z2466RDB	71.4 x 30 x 43.3	284	16	\$2396	\$2527	\$436	\$484
	Z2460RDB	65.4 x 30 x 43.3	266	15	\$2283	\$2403	\$387	\$439

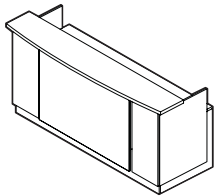

Reception Desk - Bow Front Trans. Top\*\*

**Z24xxRDB not freestanding, must be connected to a return. Z30xxRDB can be used as freestanding.** Standard with two grommets. Accommodates shells of all depths. Shipped easy to assemble in 3 cartons.

HIGH RECEPTION RETURNS	MODEL #	DIMENSIONS	WT/LB.	CUBIC FT.	1" TOP	1.5" TOP	GLAZE ADD	HP ADD
		W x D x H						
	Z2472HRRRL	75.7 x 25 x 40.3	151	8.2	\$1220	N/A	N/A	\$351
	Z2460HRRRL	63.7 x 25 x 40.3	131.2	7	\$1065	N/A	N/A	\$293
	Z2454HRRRL	57.7 x 25 x 40.3	120.9	5.75	\$969	N/A	N/A	\$263
	Z2448HRRRL	51.7 x 25 x 40.3	110.9	5.25	\$899	N/A	N/A	\$234
	Z2442HRRRL	45.7 x 25 x 40.3	100.8	4.8	\$828	N/A	N/A	\$205
	Z2436HRRRL	39.7 x 25 x 40.3	90.7	4.3	\$757	N/A	N/A	\$174

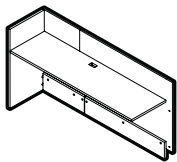

High Reception Return - LEFT

**Not freestanding, must be connected to a reception desk.** Grommet in worksurface. Accommodates shells of all depths. Connecting hardware included. Shipped easy to assemble in 1 carton.

	Z2072HRRRL	75.7 x 20.9 x 40.3	139	8.2	\$1078	N/A	N/A	\$293
	Z2060HRRRL	63.7 x 20.9 x 40.3	121	7	\$938	N/A	N/A	\$244
	Z2054HRRRL	57.7 x 20.9 x 40.3	111	5.75	\$846	N/A	N/A	\$220
	Z2048HRRRL	51.7 x 20.9 x 40.3	102	5.25	\$785	N/A	N/A	\$195
	Z2042HRRRL	45.7 x 20.9 x 40.3	92	4.8	\$721	N/A	N/A	\$171
	Z2036HRRRL	39.7 x 20.9 x 40.3	83	4.3	\$657	N/A	N/A	\$145

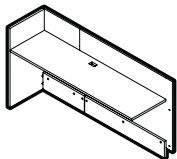

High Reception Return - LEFT

**Not freestanding, must be connected to a reception desk.** Grommet in worksurface. Accommodates shells of 20" depths. Connecting hardware included. Shipped easy to assemble in 1 carton.

**Required specifications**

Top finish  
Transaction top thickness/edge detail\*\*  
Base finish  
Transaction top finish\*\*

**Optional specifications**

HP laminate  
Additional grommet  
Glazed center panel\*\*

**Accessories**

Power block

# Z ZIRA™ RECEPTION

## HIGH RECEPTION RETURNS

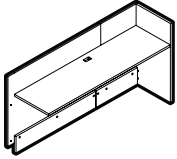

High Reception Return - RIGHT

MODEL #	DIMENSIONS W x D x H	WT/LB.	CUBIC FT.	1" TOP	1.5" TOP	GLAZE ADD	HP ADD
Z2472HRRR	75.7 x 25 x 40.3	151	8.2	<b>\$1220</b>	N/A	N/A	<b>\$351</b>
Z2460HRRR	63.7 x 25 x 40.3	131.2	7	<b>\$1065</b>	N/A	N/A	<b>\$293</b>
Z2454HRRR	57.7 x 25 x 40.3	120.9	5.75	<b>\$969</b>	N/A	N/A	<b>\$263</b>
Z2448HRRR	51.7 x 25 x 40.3	110.9	5.25	<b>\$899</b>	N/A	N/A	<b>\$234</b>
Z2442HRRR	45.7 x 25 x 40.3	100.8	4.8	<b>\$828</b>	N/A	N/A	<b>\$205</b>
Z2436HRRR	39.7 x 25 x 40.3	90.7	4.3	<b>\$757</b>	N/A	N/A	<b>\$174</b>

**Not freestanding, must be connected to a reception desk.** Grommet in worksurface. Accommodates shells of all depths. Connecting hardware included. Shipped easy to assemble in 1 carton.

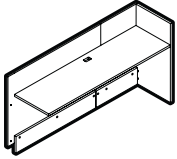

High Reception Return - RIGHT

Z2072HRRR	75.7 x 20.9 x 40.3	139	8.2	<b>\$1078</b>	N/A	N/A	<b>\$293</b>
Z2060HRRR	63.7 x 20.9 x 40.3	121	7	<b>\$938</b>	N/A	N/A	<b>\$244</b>
Z2054HRRR	57.7 x 20.9 x 40.3	111	5.75	<b>\$846</b>	N/A	N/A	<b>\$220</b>
Z2048HRRR	51.7 x 20.9 x 40.3	102	5.25	<b>\$785</b>	N/A	N/A	<b>\$195</b>
Z2042HRRR	45.7 x 20.9 x 40.3	92	4.8	<b>\$721</b>	N/A	N/A	<b>\$171</b>
Z2036HRRR	39.7 x 20.9 x 40.3	83	4.3	<b>\$657</b>	N/A	N/A	<b>\$145</b>

**Not freestanding, must be connected to a reception desk.** Grommet in worksurface. Accommodates shells of 20" depths. Connecting hardware included. Shipped easy to assemble in 1 carton.

## LOW RECEPTION RETURNS

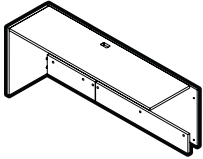

Low Reception Return - LEFT

Z2472LRRL	75.7 x 25 x 29.6	141	6.75	<b>\$1187</b>	N/A	N/A	<b>\$351</b>
Z2460LRRL	63.7 x 25 x 29.6	122	5.75	<b>\$1022</b>	N/A	N/A	<b>\$293</b>
Z2454LRRL	57.7 x 25 x 29.6	112.9	5.5	<b>\$937</b>	N/A	N/A	<b>\$263</b>
Z2448LRRL	51.7 x 25 x 29.6	103.4	5	<b>\$870</b>	N/A	N/A	<b>\$234</b>
Z2442LRRL	45.7 x 25 x 29.6	94	4.5	<b>\$799</b>	N/A	N/A	<b>\$205</b>
Z2436LRRL	39.7 x 25 x 29.6	84.3	4	<b>\$726</b>	N/A	N/A	<b>\$174</b>

**Not freestanding, must be connected to a reception desk.** Grommet in worksurface. Accommodates shells of all depths. Connecting hardware included. Shipped easy to assemble in 1 carton.

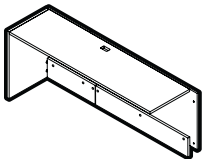

Low Reception Return - LEFT

Z2072LRRL	75.7 x 20.9 x 29.6	128.8	6.75	<b>\$1045</b>	N/A	N/A	<b>\$293</b>
Z2060LRRL	63.7 x 20.9 x 29.6	111.3	5.75	<b>\$894</b>	N/A	N/A	<b>\$244</b>
Z2054LRRL	57.7 x 20.9 x 29.6	102.8	5.5	<b>\$817</b>	N/A	N/A	<b>\$220</b>
Z2048LRRL	51.7 x 20.9 x 29.6	94.1	5	<b>\$758</b>	N/A	N/A	<b>\$195</b>
Z2042LRRL	45.7 x 20.9 x 29.6	85.3	4.5	<b>\$693</b>	N/A	N/A	<b>\$171</b>
Z2036LRRL	39.7 x 20.9 x 29.6	76.3	4	<b>\$630</b>	N/A	N/A	<b>\$145</b>

**Not freestanding, must be connected to a reception desk.** Grommet in worksurface. Accommodates shells of 20" depths. Connecting hardware included. Shipped easy to assemble in 1 carton.

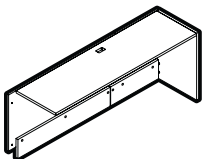

Low Reception Return - RIGHT

Z2472LRRR	75.7 x 25 x 29.6	141	6.75	<b>\$1187</b>	N/A	N/A	<b>\$351</b>
Z2460LRRR	63.7 x 25 x 29.6	122	5.75	<b>\$1022</b>	N/A	N/A	<b>\$293</b>
Z2454LRRR	57.7 x 25 x 29.6	112.9	5.5	<b>\$937</b>	N/A	N/A	<b>\$263</b>
Z2448LRRR	51.7 x 25 x 29.6	103.4	5	<b>\$870</b>	N/A	N/A	<b>\$234</b>
Z2442LRRR	45.7 x 25 x 29.6	94	4.5	<b>\$799</b>	N/A	N/A	<b>\$205</b>
Z2436LRRR	39.7 x 25 x 29.6	84.3	4	<b>\$726</b>	N/A	N/A	<b>\$174</b>

**Not freestanding, must be connected to a reception desk.** Grommet in worksurface. Accommodates shells of all depths. Connecting hardware included. Shipped easy to assemble in 1 carton.

### Required specifications

Top finish  
Base finish

### Optional specifications

HP laminate  
Additional grommet

### Accessories

Power block

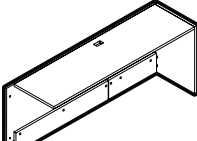
LOW RECEPTION RETURNS	MODEL #	DIMENSIONS	WT/LB.	CUBIC FT.	1" TOP	1.5" TOP	GLAZE ADD	HP ADD
		<b>W x D x H</b>						
	Z2072LRRR	75.7 x 20.9 x 29.6	128.8	6.75	<b>\$1045</b>	N/A	N/A	<b>\$293</b>
	Z2060LRRR	63.7 x 20.9 x 29.6	111.3	5.75	<b>\$894</b>	N/A	N/A	<b>\$244</b>
	Z2054LRRR	57.7 x 20.9 x 29.6	102.8	5.5	<b>\$817</b>	N/A	N/A	<b>\$220</b>
	Z2048LRRR	51.7 x 20.9 x 29.6	94.1	5	<b>\$758</b>	N/A	N/A	<b>\$195</b>
	Z2042LRRR	45.7 x 20.9 x 29.6	85.3	4.5	<b>\$693</b>	N/A	N/A	<b>\$171</b>
Z2036LRRR	39.7 x 20.9 x 29.6	76.3	4	<b>\$630</b>	N/A	N/A	<b>\$145</b>	

Low Reception Return - RIGHT

**Not freestanding, must be connected to a reception desk.** Grommet in worksurface. Accommodates shells of 20" depths. Connecting hardware included. Shipped easy to assemble in 1 carton.

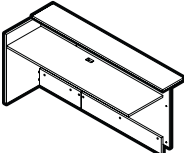
TRANSACTIONAL RETURNS	MODEL #	DIMENSIONS	WT/LB.	CUBIC FT.	1" TOP	1.5" TOP	GLAZE ADD	HP ADD
		<b>W x D x H (1.5" TOP)</b>						
	Z2472TSRL	75.7 x 29.7 x 37.5	176	9.75	<b>\$1455</b>	<b>\$1565</b>	N/A	<b>\$351</b>
	Z2460TSRL	63.7 x 29.7 x 37.5	152	8.75	<b>\$1253</b>	<b>\$1344</b>	N/A	<b>\$293</b>
	Z2454TSRL	57.7 x 29.7 x 37.5	140	7.5	<b>\$1139</b>	<b>\$1224</b>	N/A	<b>\$263</b>
	Z2448TSRL	51.7 x 29.7 x 37.5	127	7	<b>\$1047</b>	<b>\$1125</b>	N/A	<b>\$234</b>
	Z2442TSRL	45.7 x 29.7 x 37.5	116	6.25	<b>\$958</b>	<b>\$1024</b>	N/A	<b>\$205</b>
Z2436TSRL	39.7 x 29.7 x 37.5	103	5.5	<b>\$871</b>	<b>\$930</b>	N/A	<b>\$174</b>	

Transactional Return - LEFT\*

**Not freestanding, must be connected to a reception desk.** Grommet in worksurface. Accommodates shells of all depths. Connecting hardware included. Shipped easy to assemble in 1 carton.

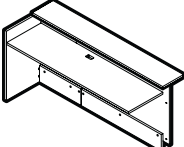
	Z2072TSRL	75.7 x 25.6 x 37.5	163	8.25	<b>\$1305</b>	<b>\$1415</b>	N/A	<b>\$293</b>
	Z2060TSRL	63.7 x 25.6 x 37.5	141	7.25	<b>\$1121</b>	<b>\$1213</b>	N/A	<b>\$244</b>
	Z2054TSRL	57.7 x 25.6 x 37.5	129	6.25	<b>\$1015</b>	<b>\$1100</b>	N/A	<b>\$220</b>
	Z2048TSRL	51.7 x 25.6 x 37.5	118	5.5	<b>\$931</b>	<b>\$1009</b>	N/A	<b>\$195</b>
	Z2042TSRL	45.7 x 25.6 x 37.5	106	5	<b>\$848</b>	<b>\$914</b>	N/A	<b>\$171</b>
	Z2036TSRL	39.7 x 25.6 x 37.5	95	4.4	<b>\$769</b>	<b>\$828</b>	N/A	<b>\$145</b>

Transactional Return - LEFT\*

**Not freestanding, must be connected to a reception desk.** Grommet in worksurface. Accommodates shells of 20" depths. Connecting hardware included. Shipped easy to assemble in 1 carton.

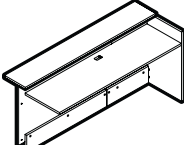
	Z2472TSRR	75.7 x 29.7 x 37.5	176	9.75	<b>\$1455</b>	<b>\$1565</b>	N/A	<b>\$351</b>
	Z2460TSRR	63.7 x 29.7 x 37.5	152	8.75	<b>\$1253</b>	<b>\$1344</b>	N/A	<b>\$293</b>
	Z2454TSRR	57.7 x 29.7 x 37.5	140	7.5	<b>\$1139</b>	<b>\$1224</b>	N/A	<b>\$263</b>
	Z2448TSRR	51.7 x 29.7 x 37.5	127	7	<b>\$1047</b>	<b>\$1125</b>	N/A	<b>\$234</b>
	Z2442TSRR	45.7 x 29.7 x 37.5	116	6.25	<b>\$958</b>	<b>\$1024</b>	N/A	<b>\$205</b>
	Z2436TSRR	39.7 x 29.7 x 37.5	103	5.5	<b>\$871</b>	<b>\$930</b>	N/A	<b>\$174</b>

Transactional Return - RIGHT\*

**Not freestanding, must be connected to a reception desk.** Grommet in worksurface. Accommodates shells of all depths. Connecting hardware included. Shipped easy to assemble in 1 carton.

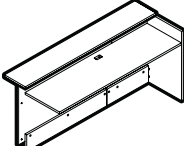
	Z2072TSRR	75.7 x 25.6 x 37.5	163	8.25	<b>\$1305</b>	<b>\$1415</b>	N/A	<b>\$293</b>
	Z2060TSRR	63.7 x 25.6 x 37.5	141	7.25	<b>\$1121</b>	<b>\$1213</b>	N/A	<b>\$244</b>
	Z2054TSRR	57.7 x 25.6 x 37.5	129	6.25	<b>\$1015</b>	<b>\$1100</b>	N/A	<b>\$220</b>
	Z2048TSRR	51.7 x 25.6 x 37.5	118	5.5	<b>\$931</b>	<b>\$1009</b>	N/A	<b>\$195</b>
	Z2042TSRR	45.7 x 25.6 x 37.5	106	5	<b>\$848</b>	<b>\$914</b>	N/A	<b>\$171</b>
	Z2036TSRR	39.7 x 25.6 x 37.5	95	4.4	<b>\$769</b>	<b>\$828</b>	N/A	<b>\$145</b>

Transactional Return - RIGHT\*

**Not freestanding, must be connected to a reception desk.** Grommet in worksurface. Accommodates shells of 20" depths. Connecting hardware included. Shipped easy to assemble in 1 carton.

**Required specifications**

- Top finish
- Transaction top thickness/edge detail\*
- Base finish
- Transaction top finish\*

**Optional specifications**

- HP laminate
- Additional grommet

**Accessories**

- Power block

# Z ZIRA™ RECEPTION

## TRANSACTIONAL RETURNS

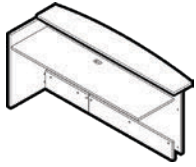

Transactional Return, Bow Front - LEFT\*\*

MODEL #	DIMENSIONS W x D x H (1.5" TOP)	WT/LB.	CUBIC FT.	1" TOP	1.5" TOP	GLAZE ADD	HP ADD
Z2472TBRL	75.7 x 32.7 x 37.5	180.6	9.75	<b>\$1455</b>	<b>\$1565</b>	N/A	<b>\$351</b>
Z2460TBRL	63.7 x 32.7 x 37.5	155.7	8.5	<b>\$1253</b>	<b>\$1344</b>	N/A	<b>\$293</b>
Z2454TBRL	57.7 x 32.7 x 37.5	143.9	7.5	<b>\$1139</b>	<b>\$1224</b>	N/A	<b>\$263</b>
Z2448TBRL	51.7 x 32.7 x 37.5	130.7	7	<b>\$1047</b>	<b>\$1125</b>	N/A	<b>\$234</b>
Z2442TBRL	45.7 x 32.7 x 37.5	118.3	6.25	<b>\$958</b>	<b>\$1024</b>	N/A	<b>\$205</b>
Z2436TBRL	39.7 x 32.7 x 37.5	104.9	5.5	<b>\$871</b>	<b>\$930</b>	N/A	<b>\$174</b>

**Not freestanding, must be connected to a reception desk.** Grommet in worksurface. Accommodates shells of all depths. Connecting hardware included. Shipped easy to assemble in 1 carton.

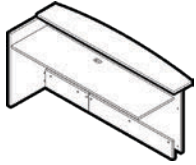

Transactional Return, Bow Front - LEFT\*\*

Z2072TBRL	75.7 x 28.6 x 37.5	168	8.25	<b>\$1305</b>	<b>\$1415</b>	N/A	<b>\$293</b>
Z2060TBRL	63.7 x 28.6 x 37.5	144.6	7.5	<b>\$1121</b>	<b>\$1213</b>	N/A	<b>\$244</b>
Z2054TBRL	57.7 x 28.6 x 37.5	133.5	6.5	<b>\$1015</b>	<b>\$1100</b>	N/A	<b>\$220</b>
Z2048TBRL	51.7 x 28.6 x 37.5	121	6	<b>\$931</b>	<b>\$1009</b>	N/A	<b>\$195</b>
Z2042TBRL	45.7 x 28.6 x 37.5	109.3	5.25	<b>\$848</b>	<b>\$914</b>	N/A	<b>\$171</b>
Z2036TBRL	39.7 x 28.6 x 37.5	96.6	4.7	<b>\$769</b>	<b>\$828</b>	N/A	<b>\$145</b>

**Not freestanding, must be connected to a reception desk.** Grommet in worksurface. Accommodates shells of 20" depths. Connecting hardware included. Shipped easy to assemble in 1 carton.

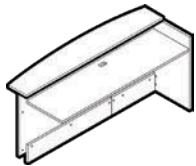

Transactional Return, Bow Front - RIGHT\*\*

Z2472TBRR	75.7 x 32.7 x 37.5	180.6	9.75	<b>\$1455</b>	<b>\$1565</b>	N/A	<b>\$351</b>
Z2460TBRR	63.7 x 32.7 x 37.5	155.7	8.5	<b>\$1253</b>	<b>\$1344</b>	N/A	<b>\$293</b>
Z2454TBRR	57.7 x 32.7 x 37.5	143.9	7.5	<b>\$1139</b>	<b>\$1224</b>	N/A	<b>\$263</b>
Z2448TBRR	51.7 x 32.7 x 37.5	130.7	7	<b>\$1047</b>	<b>\$1125</b>	N/A	<b>\$234</b>
Z2442TBRR	45.7 x 32.7 x 37.5	118.3	6.25	<b>\$958</b>	<b>\$1024</b>	N/A	<b>\$205</b>
Z2436TBRR	39.7 x 32.7 x 37.5	104.9	5.5	<b>\$871</b>	<b>\$930</b>	N/A	<b>\$174</b>

**Not freestanding, must be connected to a reception desk.** Grommet in worksurface. Accommodates shells of all depths. Connecting hardware included. Shipped easy to assemble in 1 carton.

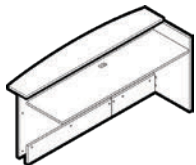

Transactional Return, Bow Front - RIGHT\*\*

Z2072TBRR	75.7 x 28.6 x 37.5	168	8.25	<b>\$1305</b>	<b>\$1415</b>	N/A	<b>\$293</b>
Z2060TBRR	63.7 x 28.6 x 37.5	144.6	7.5	<b>\$1121</b>	<b>\$1213</b>	N/A	<b>\$244</b>
Z2054TBRR	57.7 x 28.6 x 37.5	133.5	6.5	<b>\$1015</b>	<b>\$1100</b>	N/A	<b>\$220</b>
Z2048TBRR	51.7 x 28.6 x 37.5	121	6	<b>\$931</b>	<b>\$1009</b>	N/A	<b>\$195</b>
Z2042TBRR	45.7 x 28.6 x 37.5	109.3	5.25	<b>\$848</b>	<b>\$914</b>	N/A	<b>\$171</b>
Z2036TBRR	39.7 x 28.6 x 37.5	96.6	4.7	<b>\$769</b>	<b>\$828</b>	N/A	<b>\$145</b>

**Not freestanding, must be connected to a reception desk.** Grommet in worksurface. Accommodates shells of 20" depths. Connecting hardware included. Shipped easy to assemble in 1 carton.

## PIGEON RECEPTION RETURNS

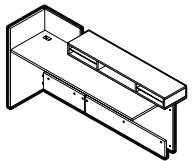

Pigeon Reception Return - LEFT\*\*

MODEL #	DIMENSIONS W x D x H	WT/LB.	CUBIC FT.	1" TOP	1.5" TOP	GLAZE ADD	HP ADD
Z2472PRRL	75.7 x 31 x 40.3	171.3	9.75	<b>\$1646</b>	N/A	N/A	<b>\$351</b>
Z2460PRRL	63.7 x 31 x 40.3	149	8.25	<b>\$1447</b>	N/A	N/A	<b>\$293</b>
Z2454PRRL	57.7 x 31 x 40.3	136.4	7.5	<b>\$1344</b>	N/A	N/A	<b>\$263</b>

**Not freestanding, must be connected to a reception desk.** Grommet in worksurface. Accommodates shells of all depths. Connecting hardware included. Shipped easy to assemble in 1 carton.

### Required specifications

Top finish  
Trans. top thickness/edge\*\*  
Base finish  
Trans. top\*\* or pigeon hole finish\*

### Optional specifications

HP laminate  
Additional grommet

### Accessories

Power block



**PIGEON RECEPTION RETURNS**      **MODEL #**      **DIMENSIONS**      **WT/LB.**      **CUBIC FT.**      **1" TOP**      **1.5" TOP**      **GLAZE ADD**      **HP ADD**

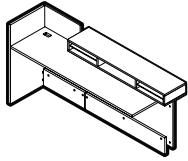

**Pigeon Reception Return - LEFT\*\***

	W x D x H							
Z2072PRRL	75.7 x 26.9 x 40.3	159	9.75	<b>\$1503</b>	N/A	N/A		<b>\$293</b>
Z2060PRRL	63.7 x 26.9 x 40.3	138.2	8.25	<b>\$1317</b>	N/A	N/A		<b>\$244</b>
Z2054PRRL	57.7 x 26.9 x 40.3	126.2	7.5	<b>\$1222</b>	N/A	N/A		<b>\$220</b>

**Not freestanding, must be connected to a reception desk.** Grommet in worksurface. Accommodates shells of 20" depths. Connecting hardware included. Shipped easy to assemble in 1 carton.

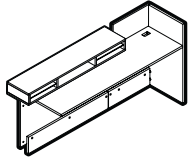

**Pigeon Reception Return - RIGHT\*\***

Z2472PRRR	75.7 x 31 x 40.3	171.3	9.75	<b>\$1646</b>	N/A	N/A		<b>\$351</b>
Z2460PRRR	63.7 x 31 x 40.3	149	8.25	<b>\$1447</b>	N/A	N/A		<b>\$293</b>
Z2454PRRR	57.7 x 31 x 40.3	136.4	7.5	<b>\$1344</b>	N/A	N/A		<b>\$263</b>

**Not freestanding, must be connected to a reception desk.** Grommet in worksurface. Accommodates shells of all depths. Connecting hardware included. Shipped easy to assemble in 1 carton.

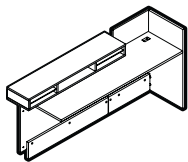

**Pigeon Reception Return - RIGHT\*\***

Z2072PRRR	75.7 x 26.9 x 40.3	159	9.75	<b>\$1503</b>	N/A	N/A		<b>\$293</b>
Z2060PRRR	63.7 x 26.9 x 40.3	138.2	8.25	<b>\$1317</b>	N/A	N/A		<b>\$244</b>
Z2054PRRR	57.7 x 26.9 x 40.3	126.2	7.5	<b>\$1222</b>	N/A	N/A		<b>\$220</b>

**Not freestanding, must be connected to a reception desk.** Grommet in worksurface. Accommodates shells of 20" depths. Connecting hardware included. Shipped easy to assemble in 1 carton.

**BOOKCASE RECEPTION RETURNS**

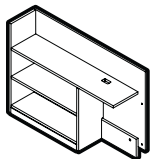

**Bookcase Reception Return - LEFT**

Z1272BRRL	75.7 x 13.7 x 40.3	158	7.5	<b>\$1316</b>	N/A	N/A		<b>\$174</b>
Z1260BRRL	63.7 x 13.7 x 40.3	139	6.25	<b>\$1163</b>	N/A	N/A		<b>\$145</b>

**Not freestanding, must be connected to a reception desk.** Grommet in worksurface. Accommodates shells of all depths. Connecting hardware included. Shipped easy to assemble in 1 carton.

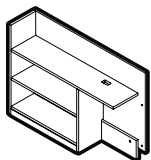

**Bookcase Reception Return - LEFT**

Z1254BRRL	57.7 x 13.7 x 40.3	131	5.75	<b>\$1078</b>	N/A	N/A		<b>\$132</b>
Z1248BRRL	51.7 x 13.7 x 40.3	114	5.25	<b>\$956</b>	N/A	N/A		<b>\$117</b>
Z1242BRRL	45.7 x 13.7 x 40.3	106	4.6	<b>\$900</b>	N/A	N/A		<b>\$105</b>
Z1236BRRL	39.7 x 13.7 x 40.3	98	4.1	<b>\$844</b>	N/A	N/A		<b>\$88</b>

**Not freestanding, must be connected to a reception desk.** Grommet in worksurface. Accommodates shells of all depths. Connecting hardware included. Shipped easy to assemble in 1 carton.

**Required specifications**

- Top finish
- Base finish
- Pigeon hole finish\*\*
- Collator finish\*\*

**Optional specifications**

- HP laminate
- Additional grommet

**Accessories**

- Power block

# Z ZIRA™ RECEPTION

## BOOKCASE RECEPTION RETURNS

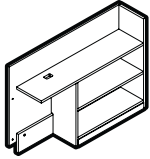

**Bookcase Reception Return - RIGHT\***

MODEL #	DIMENSIONS W x D x H	WT/LB.	CUBIC FT.	1" TOP	1.5" TOP	GLAZE ADD	HP ADD
Z1272BRRR	75.7 x 13.7 x 40.3	158	7.5	<b>\$1316</b>	N/A	N/A	<b>\$174</b>
Z1260BRRR	63.7 x 13.7 x 40.3	139	6.25	<b>\$1163</b>	N/A	N/A	<b>\$145</b>

**Not freestanding, must be connected to a reception desk.** Grommet in worksurface. Accommodates shells of all depths. Connecting hardware included. Shipped easy to assemble in 1 carton.

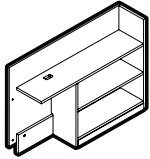

**Bookcase Reception Return - RIGHT\***

Z1254BRRR	57.7 x 13.7 x 40.3	131	5.75	<b>\$1078</b>	N/A	N/A	<b>\$132</b>
Z1248BRRR	51.7 x 13.7 x 40.3	114	5.25	<b>\$956</b>	N/A	N/A	<b>\$117</b>
Z1242BRRR	45.7 x 13.7 x 40.3	106	4.6	<b>\$900</b>	N/A	N/A	<b>\$105</b>
Z1236BRRR	39.7 x 13.7 x 40.3	98	4.1	<b>\$844</b>	N/A	N/A	<b>\$88</b>

**Not freestanding, must be connected to a reception desk.** Grommet in worksurface. Accommodates shells of all depths. Connecting hardware included. Shipped easy to assemble in 1 carton.

## RECEPTION DESK VERTICAL STORAGE

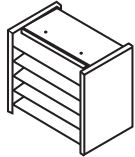

**Reception Desk - Vertical Storage\*\***

ZRDVS13	13.4 x 8.6 x 12.2	12.5	0.8	<b>\$212</b>	N/A	N/A	N/A
---------	-------------------	------	-----	--------------	-----	-----	-----

Collator shelves. Shipped assembled in 1 carton.

### Required specifications

Top finish\*  
Base finish\*  
Collator finish\*\*

### Optional specifications

HP laminate\*  
Additional grommet\*

### Accessories

Power block\*