

FOLI MECHANISM
WITH ECS+

FOLI USER
manual





CONTENTS

| | |
|------------------------------------------------------------------------|----|
| 1 Important Information. SAFETY FIRST! | 3 |
| 1.1 Important safety instructions, please save these instruction | 3 |
| 1.2 User Information..... | 5 |
| 1.3 Before you start: | 6 |
| 1.4 Electrical rating..... | 6 |
| 2 Assembly & Adjustment | 6 |
| 2.1 Assembly Instruction..... | 6 |
| 2.2 Setup procedure..... | 6 |
| 2.3 Optional mounting guidelines | 7 |
| 2.4 System configuration (example)..... | 7 |
| 2.5 Adjustments | 7 |
| 3 Operation Instructions | 8 |
| 3.1 Basic functions | 8 |
| 4 Maintenance & Repairs | 12 |
| 4.1 Cleaning, Inspection and Storage..... | 12 |
| 4.2 User Maintenance..... | 12 |
| 4.3 Repairs..... | 12 |
| 4.4 Servicing of double-insulated products | 13 |





1 Important Information. SAFETY FIRST!

Your safety and the safety of others are very important. Please familiarize yourself with all instructions and safety warnings before operating the table. Please keep this manual for future reference.

To help you make informed decisions about safety, we have provided operating procedures and other information on labels and in this user's manual. This information alerts you to potential hazards that could hurt you or others. It is not practical or possible to warn you about all the hazards associated with operating or maintaining a table. Please use your own good judgment.

You will find important safety information in a variety of forms. Safety Messages are preceded by a safety alert symbol  and one of three signal words: **DANGER**, **WARNING**, or **CAUTION**. These safety messages are listed in order of severity, identify the general risks and what actions you are to take to avoid the risks. These signal words mean:

 **DANGER** - Indicates an imminent hazardous with a high risk of serious injury or death.

 **WARNING** - Indicates a potential hazardous may result in serious injury.

 **CAUTION** - Indicates a potential hazardous, which may result in minor or moderate injury. It may also be used to alert against unsafe practices.

 **NOTICE** - Indicates an alert to call attention to proper assembly instructions or particular operation procedures to assure correct equipment function and to avoid equipment damage or wear.

The information and specifications included in this manual were in effect at the time of approval for printing. ROL reserves the right to discontinue or change specifications or design at anytime without notice and without incurring any obligation whatever.

1.1 Important safety instructions please save these instruction.

When using an electrical table, basic precautions should always be followed, including the following:

Read all instructions before using table.

 **DANGER** - To reduce the risk of electric shock:

1. Always unplug this furnishing from the electrical outlet before cleaning.

 **WARNING** - To reduce the risk of burns, fire, electric shock, or injury to persons:

1. Unplug from outlet before putting on or taking off parts.
2. This table is not intended for use by children or individuals with a physical or other impairment that may affect the ability to safely operate equipment. ,
3. Use this table only for its intended use as described in these instructions. Do not use attachments not recommended by the manufacturer.
4. Never operate this table if it has a damaged cord or plug, if it is not working properly, if it has been dropped or damaged, or exposed to water. In the event of any such event please return the table to a service center for examination and repair.
5. Keep the cord away from heated surfaces.
6. Never operate the table with the air openings blocked. Keep the air openings free of lint, hair, and the like.
7. Never drop or insert any object into any opening.
8. Do not use outdoors.
9. Do not operate the table in a potentially explosive atmosphere.

10. To disconnect, turn all controls to the off position, then remove plug from outlet.

WARNING - Risk of Electric Shock:

1. Connect this table to a proper outlet only. For loading always put heavier items at the bottom and not at the top in order to help prevent the possibility of the furnishing tipping over.

WARNING - Risk of Injury to Persons:

1. Do not use this table to lift people and do not use the table to lift heavy parts or use this table as a platform for storage.
2. Maximum intended load is 265 pounds uniformly distributed (120 kilograms) including the table top.

DANGER - Risk of electric shock, injury, or death:

1. Improper usage, abuse, or misuse of the power supply, handset, motors and other electrical components may result in an electrical shock injury or possible death.
2. Do not open the power supply unit or handset under any circumstances. The power supply and handset contain no serviceable parts.
3. Do not modify or make any changes to the power supply, handset or other electrical devices.
4. During installation, repair, cleaning, or maintenance work, the power cable must be disconnected from the outlet.
5. The engines/motors control unit is not designed for continuous operation. Changing the desktop position without interruption must not exceed the duty cycle indicated on the power supply. The unit is thermally protected and will temporarily shut down if use exceeds the duty cycle. Allow a 9-minute cooling period for the control unit to reset.
6. The power supply unit may only be operated with voltage as specified on the power supply label.
7. Only use the power cord supplied with the power supply. Check that it is not damaged. Do not operate the power supply unit if the power cord is damaged.
8. Connect the power supply to a proper outlet only. To disconnect turn all controls to the off position, then remove plug from outlet.
9. In the event of a malfunction (e.g. if the control unit keeps adjusting the desk because a movement button has jammed), please unplug the unit immediately.
10. Do not expose the power supply, control unit/ECS+, handset or other electrical device to water or other liquids including moisture, drips, splashes or spills. Only clean electrical device with a dry cloth.
11. Do not operate the power supply, control unit/ECS+, handset or other electrical device in a potentially explosive atmosphere. Do not operate where aerosol spray products are being used or where oxygen is being administered.
12. Do not use the desk with if it has been dropped or damaged. Contact the manufacturer for examination or repair
13. It is not allowed to connect self-constructed products to the power supply, control unit/ECS+, handset or other electrical device. To prevent damage, use only approved OEM components

WARNING - Risk of injury, or death:

1. During the raising or lowering of the table there exists a risk of squeezing or pinching between the moving desktop and fixed objects.
2. The necessary safety margins depend on the greatest type of injury risk that can be predicted. Where possible small pinch points exist (i.e. fingers) use at least a one inches (2,5 cm) safety margin and for body or head (especially where children may be present) use a minimum of 16 inches (41 cm) count from the floor or from their top of the table feet if that is relevant
3. During the lowering or rising of the desktop, the operator must ensure that no person or object risk being harmed by the operation.

4. This tag (at right) should be located on the table during the initial installation.
5. Keep children away from moving parts and underneath the table.
6. The intended use of the table is adjusting a work surface between sitting and a standing position. The table is not designed for other uses.
7. The table must only be operated while in an upright position and must under no circumstances be operated while upside down.
8. The table must not be overloaded. The maximum allowable load is shown on the power supply label.
9. The table must be operated in a dry, enclosed space, such as an office or similar, Do not operate outdoors.
10. As option the table can be equipped with Anti Collision (AC) function. In the event of a faulty the desktop may move slightly before the safety feature is engaged. Stay clear of pinch points when the desktop is moving.
11. This table is not intended for use by individuals (including children) with limited physical, sensory or mental abilities or with a lack of experience and/or lack of expertise, unless they are supervised by a person responsible for their safety or have received instructions from that person on how to use the control unit.
12. Children must be supervised at all times to ensure that they do not play with the control unit.
13. The table may not be used to lift people. Do not sit or stand on a table while it is be raised or lowered.
14. The table must not be structurally or technically altered or modified in any way.



1.2 User Information

This column system is rated for commercial use only and is rated for a maximum load of 265 pounds, uniformly distributed (120kg) including the tabletop

The motors may only be used continuously for 1 minute after which the table will automatically shut-off 9 minutes.

Typical Product Label with Date of Manufacture

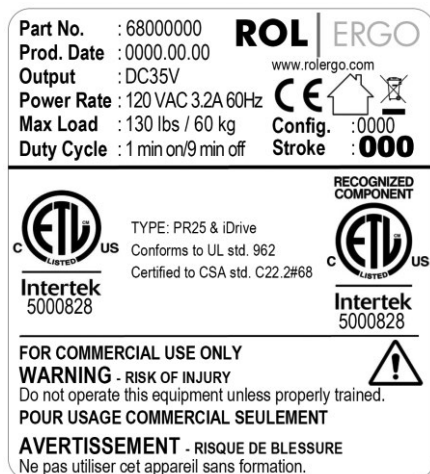

Typical Power Supply Label for 1.25"/sec speed



1.3 Before you start

Check for and remove obstacles in path of the table top.

If divergence between the columns will be discovered, please do a manual reset as listed in **section 3.2**.

1.4 Electrical rating

Electrical rating, input: 120VAC, 50-60Hz, 3,2A. Output 29V or 35V.

2 Assembly & Adjustment

2.1 Assembly Instruction

The official assembly instruction will be found with the base components.

Base is for use with an approved surface, provided by the Global Furniture Group.

2.2 Setup procedure

CAUTION - Risk of electrical shock:

The power cord must be unplugged while the control unit is being commissioned.

This table is equipped with the ECS+ system, to setup the controlling device proceed as follows.

1. Connect the motor cables to the control unit 8-pin motor cables
2. Connect the handset to the relevant socket at the control unit / ECS+
3. Connect the Power Supply to the control unit / ECS+
4. Plug in the power supply to a standard outlet.

At first use, the control unit must register the lowest point of elevation. To reset, press “down” icon and go to lowest level.

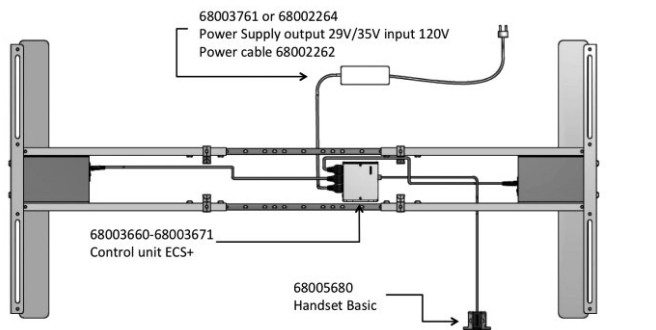
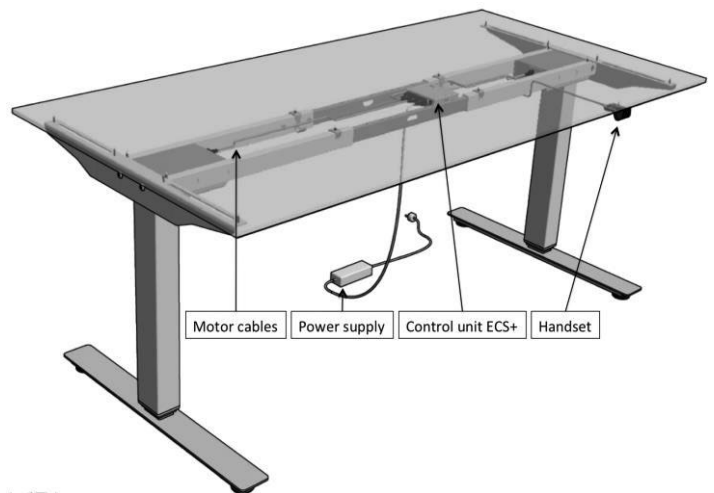

Reset together with installation



- 1-Drive the columns down to lowest level
- 2-Ready for use

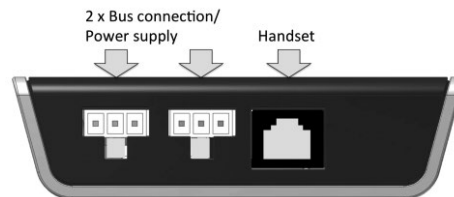
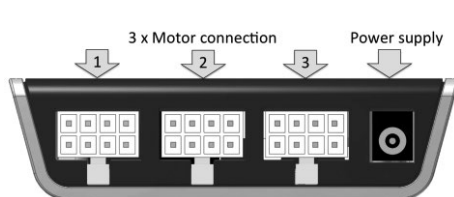

2.3 Optional mounting guidelines

i NOTICE - When components like power supply, control unit / ECS+ or motor cables shall be disconnected, be sure to unlock the 8pin connector on the cable properly! There is a fixing hook on this connector that must be pressed.

⚠ DANGER - Grounding Instruction

This product does NOT require grounding to earth. This product is double insulated and equipped with a nonpolarized 120V plug and 2-conductor cord. The plug must be plugged into an appropriate building outlet that is properly installed in accordance with all local codes and ordinances.



⚠ DANGER - RISK OF ELECTRICAL SHOCK

Improper connection of the equipment can result in a risk of electric shock. Check with a qualified electrician for any concerns. Do not modify the plug provided with the product - if it will not fit the outlet have a proper outlet installed by a qualified electrician.

This product is designed for the voltage indicated on the power supply label. No adapters should be used with this product.

⚠ CAUTION - Risk of electrical shock

Before you plug in the power cord, check the following again:

- The voltage must be as specified on the power supply label.
- When the power cord is plugged in, the electrical control devices are operational.

i NOTICE - in case of a main power breakdown, or if the power cord is unplugged during the movement of the drives, a manual reset may be necessary! Please see **section 3.2** manual reset.

2.4 System configuration (example)

The figure below shows the motor driving assignment for a configuration example. This configuration consists of:

- 1 Power Supply
- 2 Motor cables
- 3 Handset
- 4 Control unit

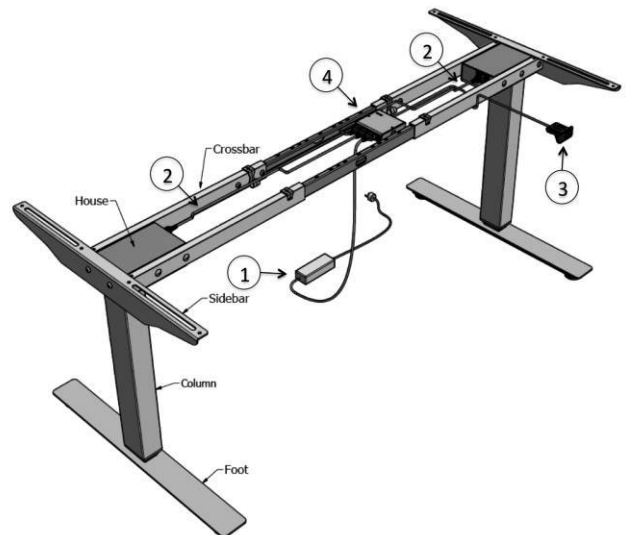

2.5 Adjustments

The table control, handset and motors are sealed units and have no parts that can be serviced or adjusted by the user. In case of failure or unexpected operation that cannot be corrected using the instructions in this manual, please contact Global Furniture Group Customer Care.

3 Operation Instructions

To ensure safe operation of the ECS+ control unit, please observe the following safety instructions:

⚠ CAUTION - Risk of injury and electric shock.

Keep children away from electric height-adjustable desks, control units and handset.

⚠ CAUTION - Risk of Pinching

When you change the desktop position (especially without using pinch protection), you must ensure that no people or objects are located in the hazardous area nor may reach into it.

i NOTICE - in case of a main power breakdown, or if the power cord is unplugged during the movement of the drives, a manual reset may be necessary! Please see **section 3.2**.

i NOTICE - The control unit might be damaged by power surges. Unplug the power cord during a thunderstorm or if you do not intend to use the desk for a longer period.

3.1 Basic functions

i NOTICE - You must read the user manual carefully before installing or operating the control unit.

Overload protection! If the total load on the equipment is too high you will only be able to drive for 2 seconds. The system will then stop and you need to release the table from load before new drive. After load release, press button again.

Overheat protection! If heavily loaded and driven continuously for a long period of time the motor might get overheated. The software observes this and if overheated system will shut down and you will have to wait about 9 minutes before being able to run again.

Anti Collision “AC” (optional)! The ECS+ can be equipped with intelligent software for pinch protection. If a collision is detected system will stop and back off about 1 inch.

IMPORTANT! Make sure to remove the blocking item causing the pinch before trying to operate the table again. Failure to do so may cause injury to user or equipment.

During low ratiion the currents to each connected motor is continuously measured and any variation of current is evaluated about 50 times each second.



PH3T6601 HANDSET DISPLAY INSTRUCTIONS



This manual is a quick guide of the functionality for the PH3T6601 Handset Display. This handset is intended to be used with ECS+ control box only, included with the PH3T6601.

Settings

By pressing ▲ Up and ▼ Down buttons simultaneously you enter the Settings menu.

You are now able to step between the Settings menu with the ▲ Up and ▼ Down button.

To exit the menu, just step all the way down by pressing the ▼ Down button a number of steps.

The Settings menu have the following steps in this order:

- Err
- ECS
- SOF
- rES
- SL
- SU
- CAL
- Un - Settings menu entry level

Exit
To enter a menu, press ▲ Up and ▼ Down button simultaneously.

To adjust value, press ▲ Up or ▼ Down button.

To save and/or exit setting, press ▲ Up and ▼ Down buttons simultaneously.

Error Codes

1. Hard stop
2. Back off
3. Soft stop
4. Waiting for button
5. Waiting for button release
6. Motor lost
7. Overcurrent
8. Overheating. Thermometer flashing, wait 10 minutes for motor cooling
9. Low voltage (under 16vdc)
10. High Voltage (over 40vdc)
11. Motors far apart /sync error
12. Destination above upper limit
13. Destination below lower limit
14. Internal error
15. Collision detected by sensor

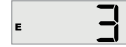

Default error code example

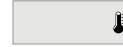

Error code 8, flashing thermometer

Mount the Handset

Use the 2 attached screws for fixing to the table top. If the thickness of the table top is less than 3/4 inch (18mm) please use shorter screws.



Start Up

Initial display communication "view." Under normal condition the display automatically shows the layout as below in 2 to 5 sec.



If the system is in reset mode the reset icon will be visible.



In that case, press the Down button until the symbol goes away.

Connect the handset

Connect the cable to the ECS+ box.

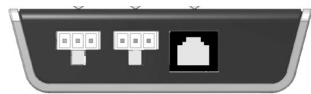

↑
Handset

ECS

ECS for ECS Software, will show the software version of the ECS box. Version is shown as Year and Week. Y.W.

Press ▲ Up and ▼ Down buttons simultaneously to enter the Settings menu. Press Up button until you reach ECS.



To enter, press ▲ Up and ▼ Down buttons simultaneously. The version of the software is now shown on the display.



To exit setting, press ▲ Up and ▼ Down buttons simultaneously.



PH3T6601 HANDSET DISPLAY INSTRUCTIONS



This manual is a quick guide of the functionality for the PH3T6601 Handset Display. This handset is intended to be used with ECS+ control box only, included with the PH3T6601.

Handset layout

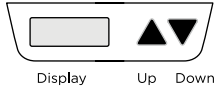

Display layout

Explanation of the symbols.

- Menu Mode
- Memory
- Error Codes
- Reset
- Imperial, Inch
- Thermometer
- Metric, Centimeter



10 sec - sleep mode

The display will go to sleep mode after 10 sec of inactivity.

Er - Error Logs

Err for Error, will open error statistics menu, where you are able to see the number of error situations encountered.

Press Up and Down buttons simultaneously to enter the Settings menu. Press Up button until you reach Err.



To enter, press Up and Down button simultaneously.



Browse through the codes with the Up and Down buttons.

- LOH Leg Over Heat - a motor have been over- heated this number of times
- COH Card Over Heat - the ECS box have been overheated this number of times
- COL Collition detection - executed this number of times
- tot Total adjusted distance

The error counter is stored in the ECS box, so it is not important if this Display Handset have recently been attached to the system or not.

SOF - Software

SOF for Software, will show the software version installed in the handset. Version is shown as Year and Week. Y.W.

Press Up and Down buttons simultaneously to enter the Settings menu. Press Up button until you reach SOF.



To enter, press Up and Down button simultaneously. The version of the software is now shown on the display.



To exit setting, press Up and Down buttons simultaneously.

rES - Reset

rES for Reset, will force the sytem into Reset mode.

Press Up and Down buttons simultaneously to enter the Settings Menu. Press Up button until you reach rES.



To enter, press Up and Down buttons simultaneously.



Press the Down button and hold until the columns have reached the lowest position.

CAL - Calibration

CAL for Calibration, you are able to adjust the height value in the display to correspond to actual height of table top on this particular setup.

Press Up and Down buttons simultaneously to enter the Settings menu. Press Up button until you reach CAL.



To enter, press Up and Down buttons simultaneously.

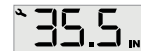

When you are in calibration mode the height numbers flashes and you are able to drive the value Up or Down until shown height correspond to the actual height of the desk at that time.

To save and/or exit setting, press Up and Down buttons simultaneously.



PH3T6601 HANDSET DISPLAY INSTRUCTIONS



This manual is a quick guide of the functionality for the PH3T6601 Handset Display. This handset is intended to be used with ECS+ control box only, included with the PH3T6601.

SL - Simple Memory Lower

SL for Simple Memory Lower. You are able to set a stored Simple Memory for the ▼ Down button. The desk will stop at this set height when driving downwards.

Press ▲ Up and ▼ Down buttons simultaneously to enter the Settings menu. Press Up button until you reach SL.



To enter, press ▲ Up and ▼ Down buttons simultaneously.



When you are in SL mode the height numbers flashes and your current Lower limit is shown on the display.

If you want to adjust the height, use the ▲ Up and ▼ Down buttons to change the value.

To save and/or exit setting, press ▲ Up and ▼ Down buttons simultaneously.

Un - Units

Un for Units, this is where you change preferred unit, cm or Inch.

Press ▲ Up and ▼ Down buttons simultaneously to enter the Settings menu.



To enter, press ▲ Up and ▼ Down buttons simultaneously.

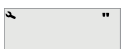

Choose between the units with the ▲ Up and ▼ Down buttons.

To save and/or exit setting, press ▲ Up and ▼ Down buttons simultaneously.

SU - Simple Memory Upper

SU for Simple Memory Upper. You are able to set a stored Simple Memory for the ▲ Up button. The desk will stop at this set height when driving upwards.

Press ▲ Up and ▼ Down buttons simultaneously to enter the Settings menu. Press Up button until you reach SU.



To enter, press ▲ Up and ▼ Down buttons simultaneously.



When you are in SU mode the height numbers flashes and your current Upper limit is shown on the display.

If you want to adjust the height, use the ▲ Up and ▼ Down buttons to change the value.

To save and/or exit setting, press ▲ Up and ▼ Down buttons simultaneously.

Shortcut Functionality

The system also have a shortcut functionality for setting memory position and to enter reset mode.

Upper and Lower Limit

To store the current height as a Simple Memory, press ▲ Up and ▼ Down buttons simultaneously 3 times in fast sequence. This will show a S in the display.



You are now able to store this position as a Lower or Upper limit by pressing one of the buttons.

Press ▲ Up button to store Upper limit or

Press ▼ Down button to store Lower limit.

Reset Mode

Press and hold ▲ Up and ▼ Down buttons simultaneously for 8 seconds, this will initiate the Reset mode.



4 Maintenance & Repairs

4.1 Cleaning, Inspection and Storage

Clean the table frame by wiping it down with a microfiber cloth. Never use solvent or abrasive or corrosive compounds.

Products must be cleaned at regular intervals to remove dust and dirt and inspected for mechanical damage and normal wear and tear. Worn-out parts must be replaced.

Unplug the power cord if you do not intend to use the desk for a longer period.

4.2 User Maintenance

Products are closed units and require no internal maintenance.

Columns must be inspected at attachment points, wires, piston rod, cabinet, and plugs, check that columns function correctly.

- Inspect columns for loose connections and damaged plugs/wires.
- Inspect power supply for loose connections and damaged plugs/wires.
- The power supply and the handset is sealed and maintenance free.

4.3 Repairs

Check all screws and bolts after the first week of use and tighten screws and bolts where necessary to ensure safe operation of the table.

If the table cannot be raised or lowered, check the cable connection between:

- the power supply and the outlet.
- the power supply and the control unit / ECS+.
- the handset and the control unit / ECS+.
- the columns/motors and the control unit /ECS+.

If the table still doesn't operational, the control system may have triggered the overheating or duty cycle protection. Unplug the power cable and

wait for at least 9 minutes and try again fore proceeding.

If a control unit is replaced, a manual reset is required. Follow these steps as section 3.2.

If the table is still not operational, please contact your vendor for further assistance.

The control system is equipped with safety features; the intermittency function and the overheating protection and memory function

Overheat protection - The table will become inoperable if the overheating protection is triggered and will return to operation automatically once the heat has dissipated sufficiently. If heavy loaded and driven continuously for a long period of time the motor might get very hot. The software observes this and if overheated system will shut down and you will have to wait about 9 minutes before being able to run again.

Memory function - The control system / ECS+ (each column) will retain information regarding the elevation of the table at all times. This information will remain stored even in case of power failure or if the power cable is disconnected from the power outlet.

Overload protection -If the total load on the equipment is to high you will only be able to drive for a short moment. The system will then stop and you need to release the table from load. Press button again.

Anti collision (optional) The ECS+ can be equipped with an intelligent software pinch protection. During low ration the currents to each connected motor is continuously measured and any variation of current is evaluated about 50 times each second. If a collision is detected the system will stop and back off about 1 inch (25 mm).

IMPORTANT! Make sure to remove the blocking item causing the pinch before trying to operate the table again. Failure to do so may cause injury to user or equipment.



Soft start – Progressive acceleration allows for soft starts and stops.

Speed – the speed of the table varies with load.

4.4 Servicing of double-insulated products

In a double-insulated product, two systems of insulation are provided instead of grounding. No grounding means is provided on a double-insulated product, nor is a means for grounding to be added to the product.

Servicing a double-insulated product requires extreme care and knowledge of the system, and is to be done only by qualified service personnel.

Replacement parts for a double-insulated product must be identical to the parts they replace. A double insulated product is marked with the words

“DOUBLE INSULATION” or “DOUBLE INSULATED”. The symbol (square within a square) is also able to be marked on the product.