



DESIGN GUIDE

Seaside Round

Revised November 2024



Tops

1. Square Corner

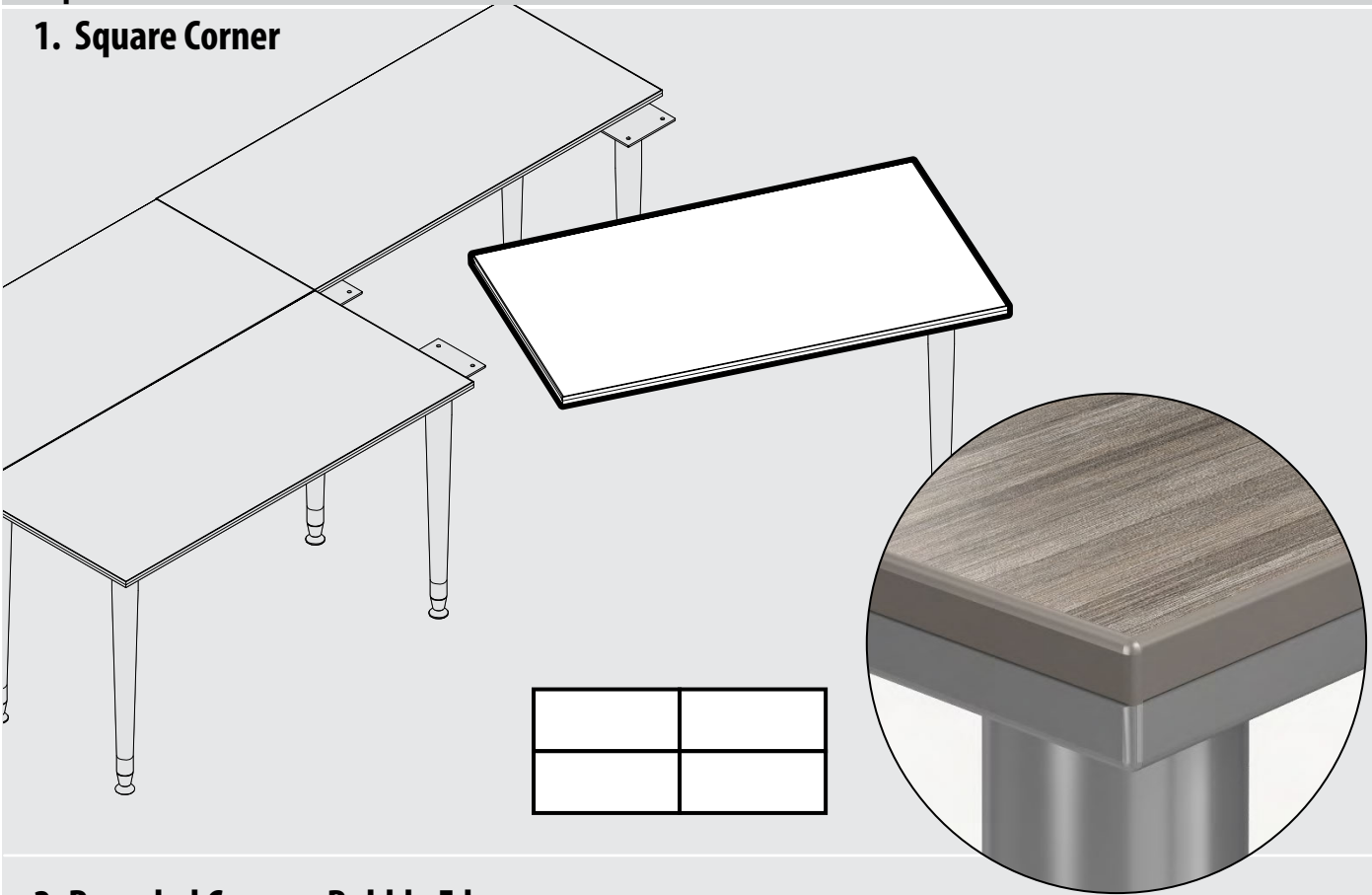

2. Rounded Corner - Bubble Edge

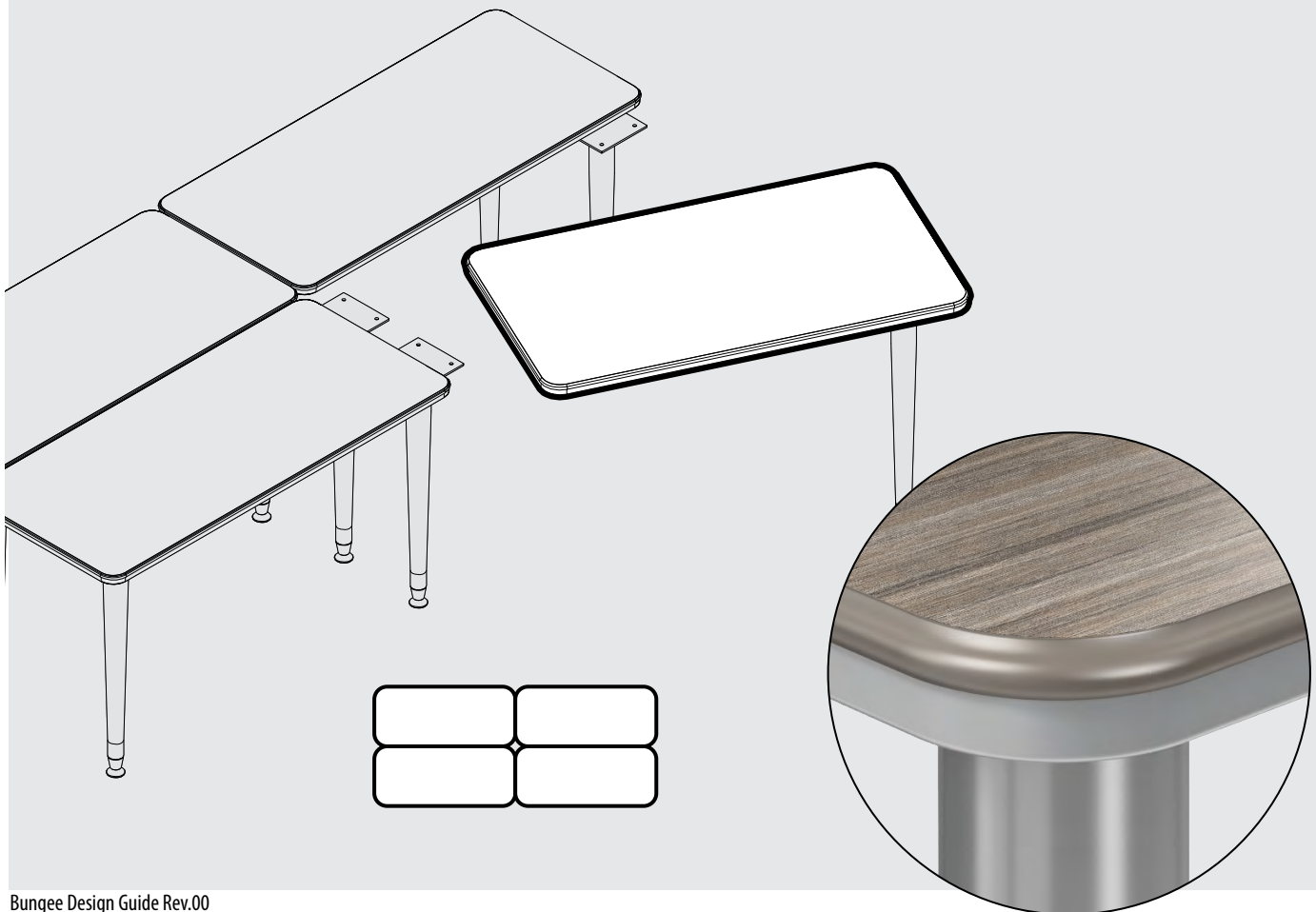

Top and Leg Orientation

Top orientation

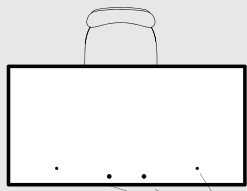

Pre-drilled holes
(for optional modesty panel and power trough)

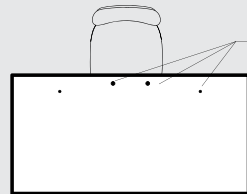

Pre-drilled holes
(for optional modesty panel and power trough)

Spider leg orientation

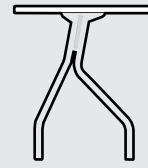
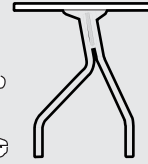

Legs

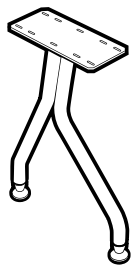

Spider Legs

20" deep

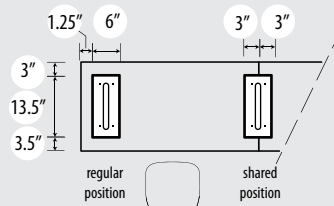

- For 20" and 24" deep tops use **B2xSPLEG**.
- Legs are available with adjustable levelers only. Casters are not an option for Bungee SL.

24" deep

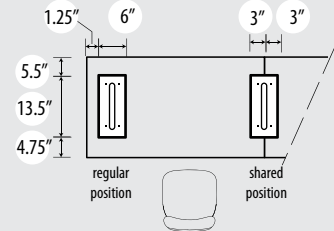

30" deep

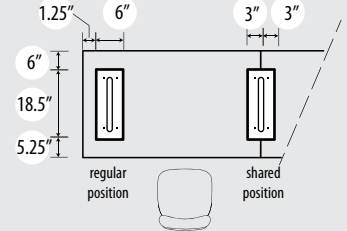

- For 30" deep tops use **B30SPLEG**.

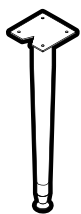

Tapered Legs

20", 24", 30" deep

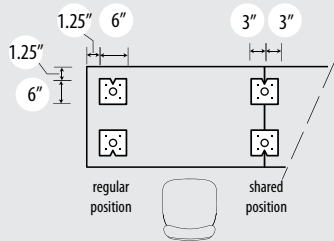

- Legs are available with adjustable levelers only. Casters are not an option for Bungee SL.

Filler Panel

Straight configuration

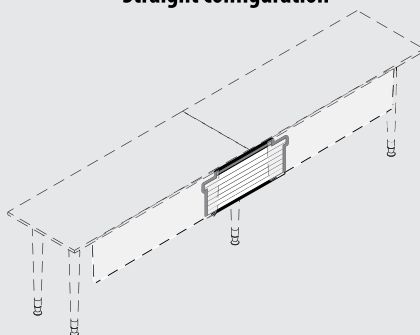

90° configuration

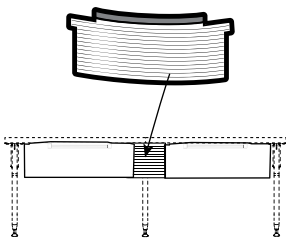
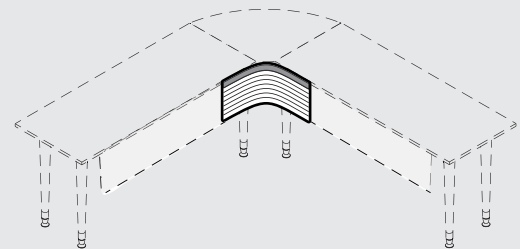

Modesty

Square Modesty Panel

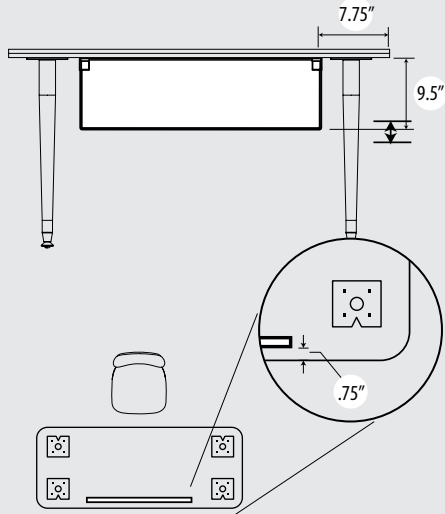

Square Modesty Panel

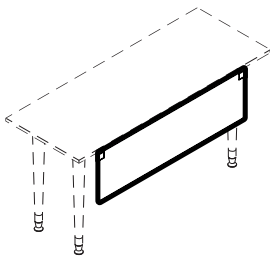

Rectangular

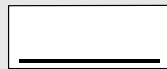

Trapezoid

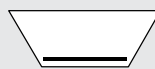

Wedge



Transformer Tables

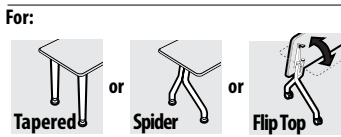
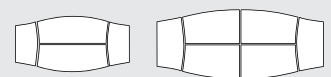

Width		Depth			Wedge	Transformer Tables		
		30"	24"	20"		11'	13'	15'
72"	BX72QMP	BXL72QMP	BXM72QMP	-				
66"	BX66QMP	BXL66QMP	BXM66QMP	-				
60"	BX60QMP	BXL60QMP	BXM60QMP	-				
48"	BX48QMP	-	-	-	BXWQMP	BXK132QMP	BXK156QMP	BXK180QMP
42"	BX42QMP	-	-	-				
36"	BX36QMP	-	-	-				

Grommets & Power Block

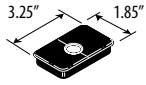

Grommet

- Grommet available in position AG1, AG2 and AG3.

Rectangular Tops

For 36" and 42" width units:

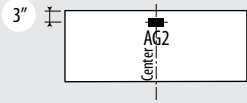

For 48", 60" and 72" width units:

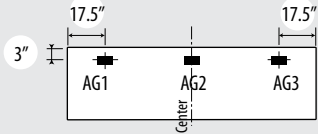

Keystone Tops

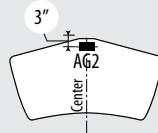

Half Moon Tops

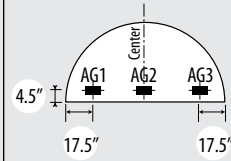

90° Wedge Tops

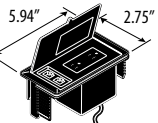
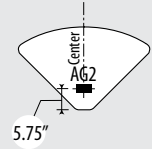

Power Block

- Grommet available in position E1, E2 and E3.

For 36", 42" and 48" width units:

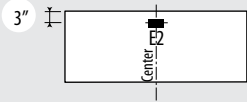

For 60" and 72" width units:

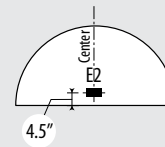
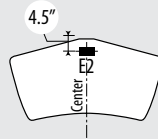
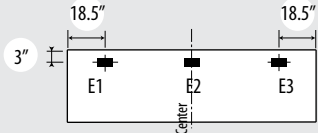

- Not available.

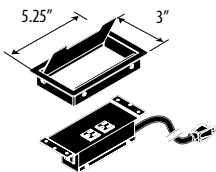

Villa 2

- Available in position V1, V2 and V3.

For 36", 42" and 48" width units:

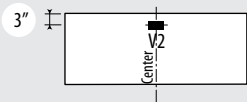

For 60" and 72" width units:

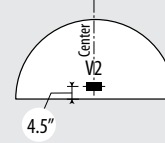
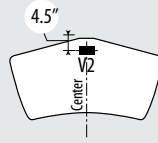
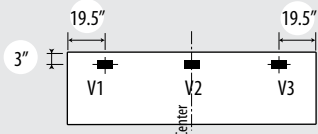

- Not available.

Tops with Legs and Plates Condition

Rectangular Tops

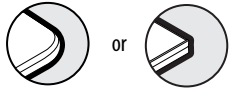
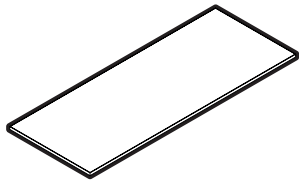

- Legs not included
- Support Bar included for units with 60" and 72" width.

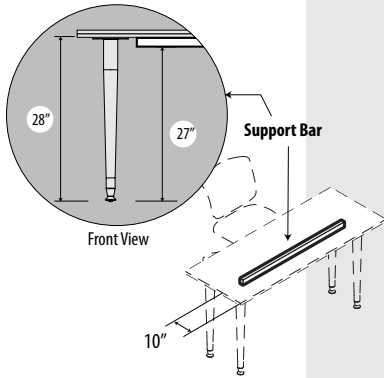

Tapered Legs

Single Straight Running Applications

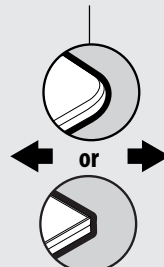
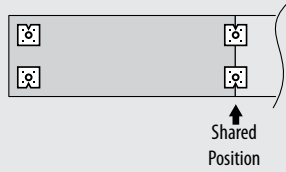

Square or Rounded Corner

Back-to-Back Applications

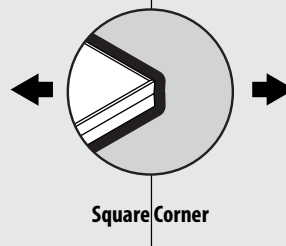
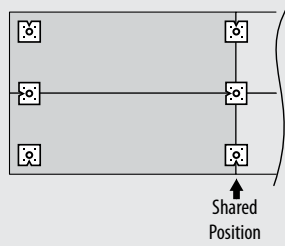

Square Corner

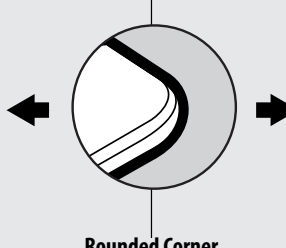
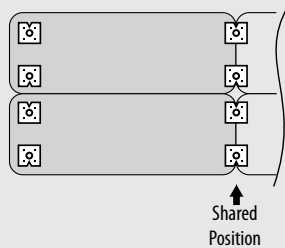

Rounded Corner

Spider Legs

Single Straight Running Applications

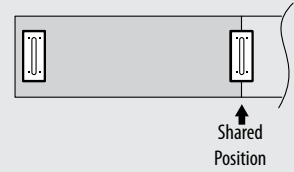

Back-to-Back Applications

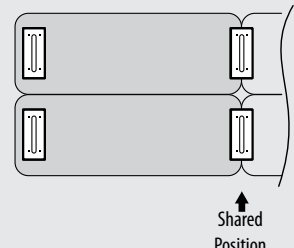
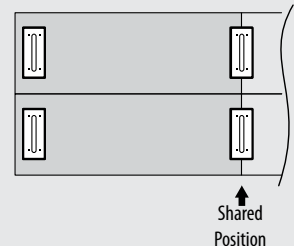

Rectangular Return Tops

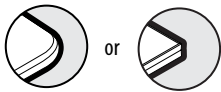
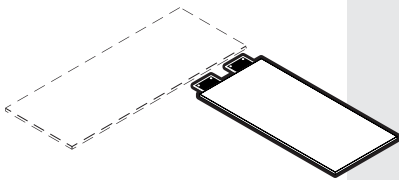

- 2 Flush Plates included
- Legs not included
- Maximum Width: 54"

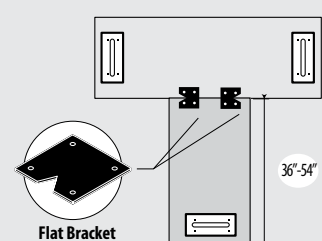
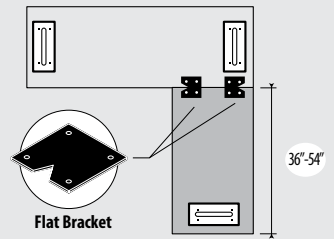
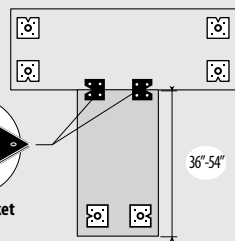
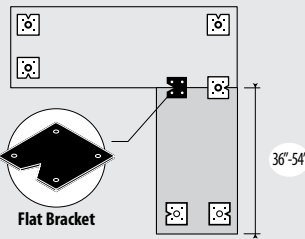

Legend:

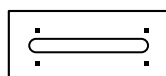

Spider Leg



Tapered Leg



Flat Bracket

Tops with Legs and Plates Condition

Half Moon Tops

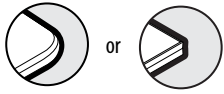
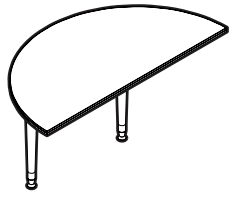

- 2 Tapered legs with levellers included
- 1 Joining Plate included
- **Not** available with Spider Legs
- **Does not** connect with Spider Legs Tables.

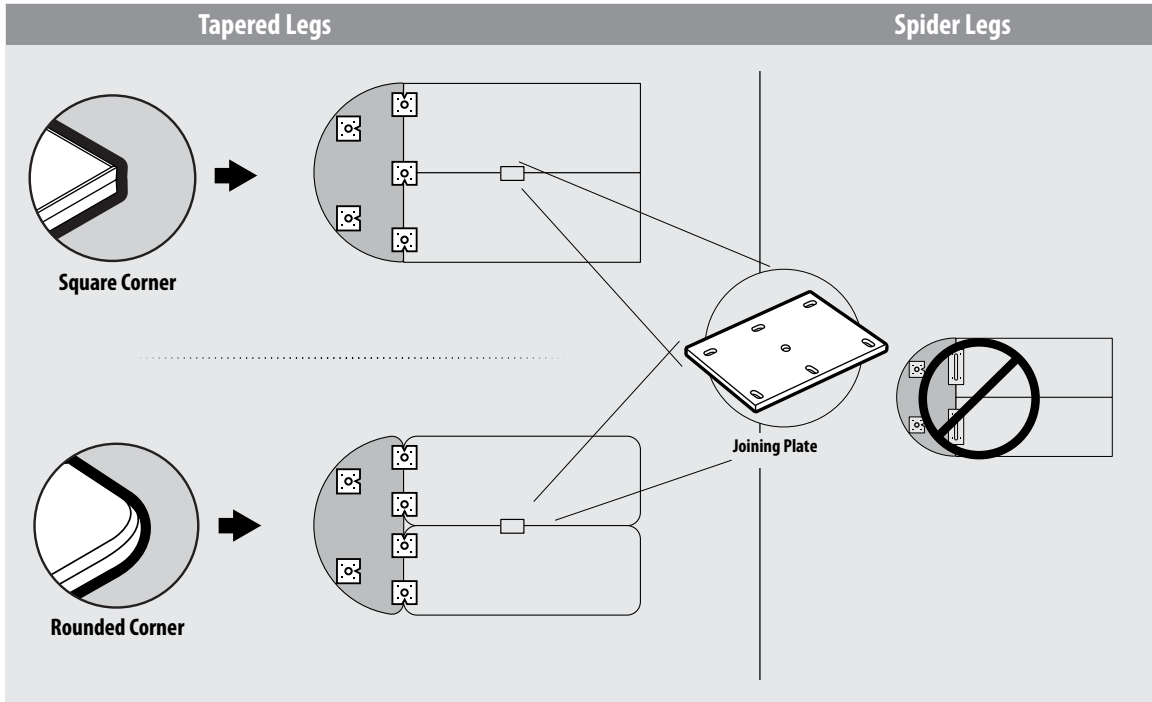

Keystone Tops

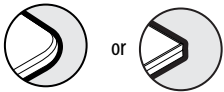
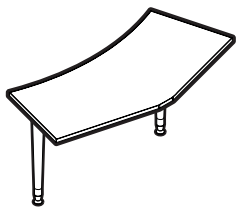

- 2 Tapered legs with levellers included
- **Not** available with Spider Legs
- **Does not** connect with Spider Legs Tables.

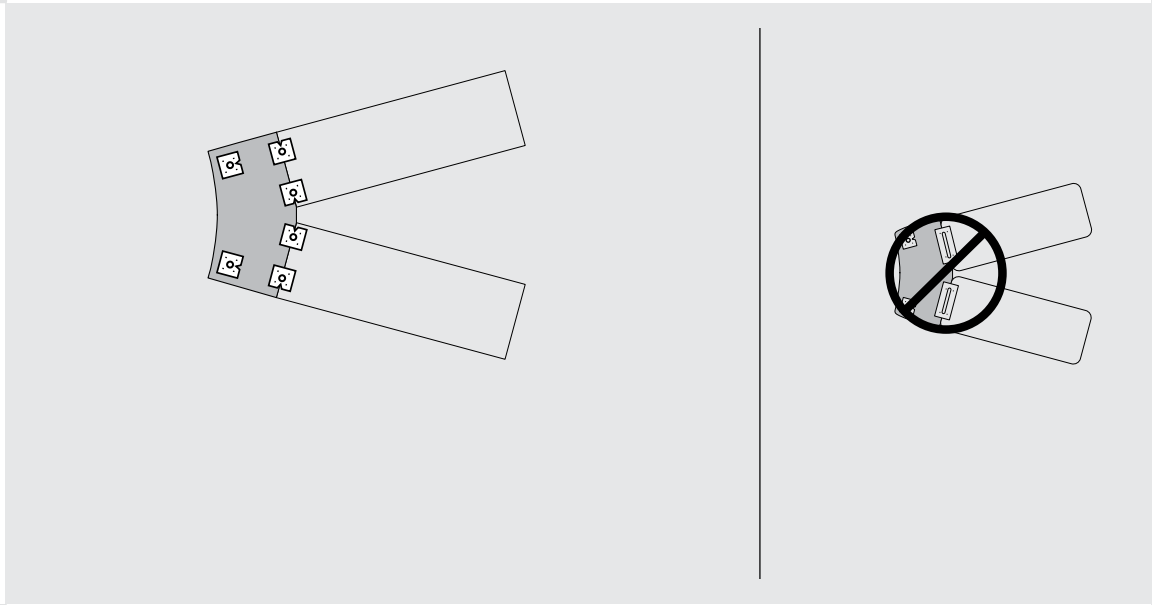

90° Wedge Tops / 90° Square Corners

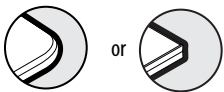

- Legs **not** included with wedge top
- Square Corner **not** available with Spider Legs
- Connect to 20" or 24" deep Rectangular Table.

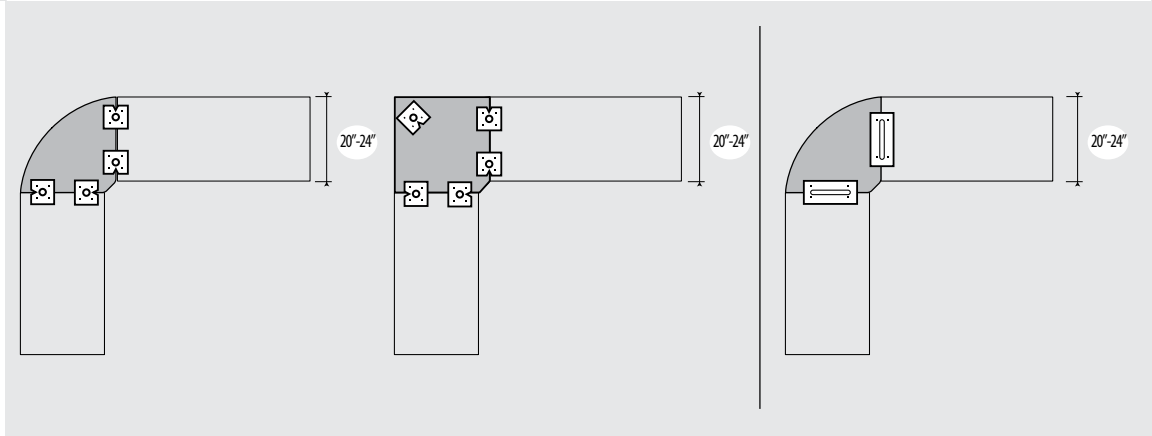

Legend:

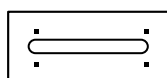

Spider Leg



Tapered Leg



Flat Bracket

Suggested Layouts

BDG Layout 1

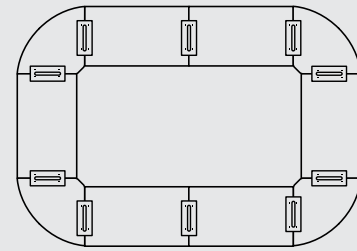
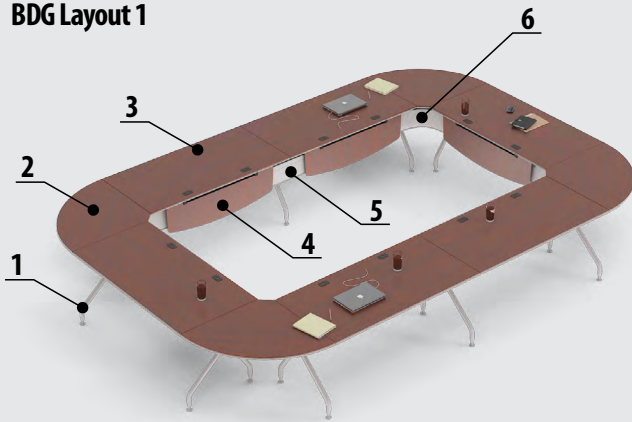

- | | | |
|---|-----------|-----------------|
| 1 | B2xSPLEG | Spider Leg |
| 2 | BS24WE | 90° Wedge Top |
| 3 | BS2448REC | Rectangular Top |
| 4 | B48MP13 | Modesty Panel |
| 5 | BSFMS | Filler Panel |
| 6 | B29IFMS | Filler Panel |

BDG Layout 2

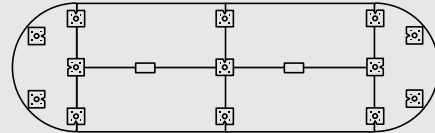

- | | | |
|---|-----------|-----------------|
| 1 | B29TPLEG | Tapered Leg |
| 2 | BS2448HMF | Half Moon Top |
| 3 | BS2448REC | Rectangular Top |

BDG Layout 3

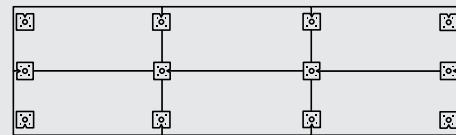
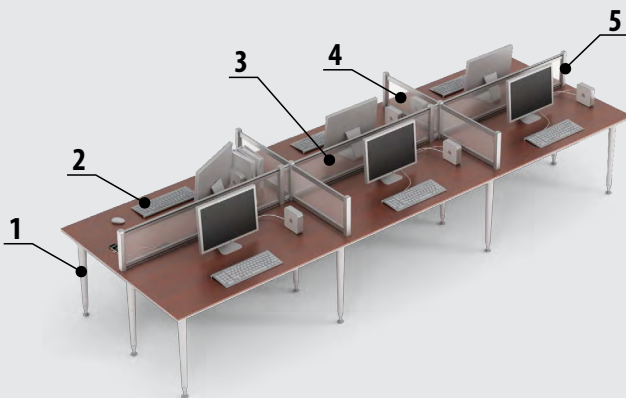

- | | | |
|---|-----------|--------------------------|
| 1 | B29TPLEG | Tapered Leg |
| 2 | BS2448REC | Rectangular Top |
| 3 | DGP1248 | Divide Glaze Panel 12" H |
| 4 | DGP1224 | Divide Glaze Panel 12" H |
| 5 | DPOST12 | Divide Post 12" H |

Legend:

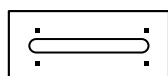

Spider Leg



Tapered Leg



Flat Bracket

Suggested Layouts

BDG Layout 4

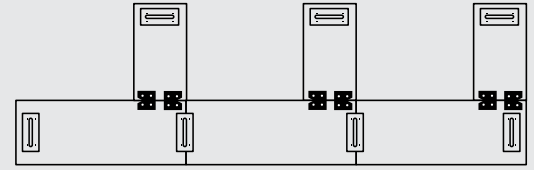
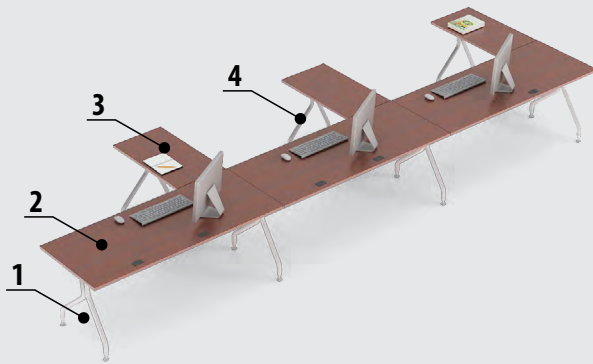

- | | | |
|---|-----------|------------------------|
| 1 | B30SPLEG | Spider Leg |
| 2 | BS3072REC | Rectangular Top |
| 3 | BS2436RRE | Rectangular Return Top |
| 4 | B2xSPLEG | Spider Leg |

BDG Layout 5

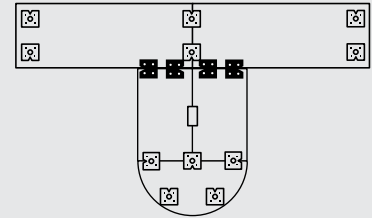
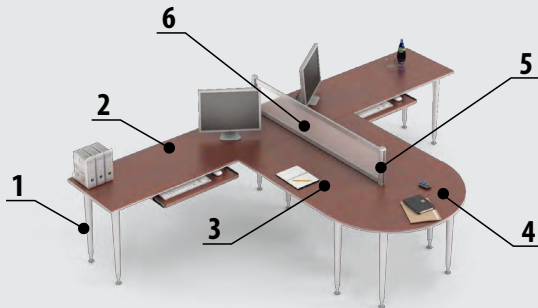

- | | | |
|---|-----------|--------------------------|
| 1 | B29TPLEG | Tapered Leg |
| 2 | BS2472REC | Rectangular Top |
| 3 | BS2448RRE | Rectangular Return Top |
| 4 | BS2448HMF | Half Moon Top |
| 5 | DPOST12 | Divide Post 12" H |
| 6 | DGP1272 | Divide Glaze Panel 12" H |

Legend:

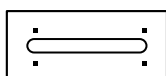

Spider Leg



Tapered Leg



Flat Bracket

Laminate Face Panel



Center Spine

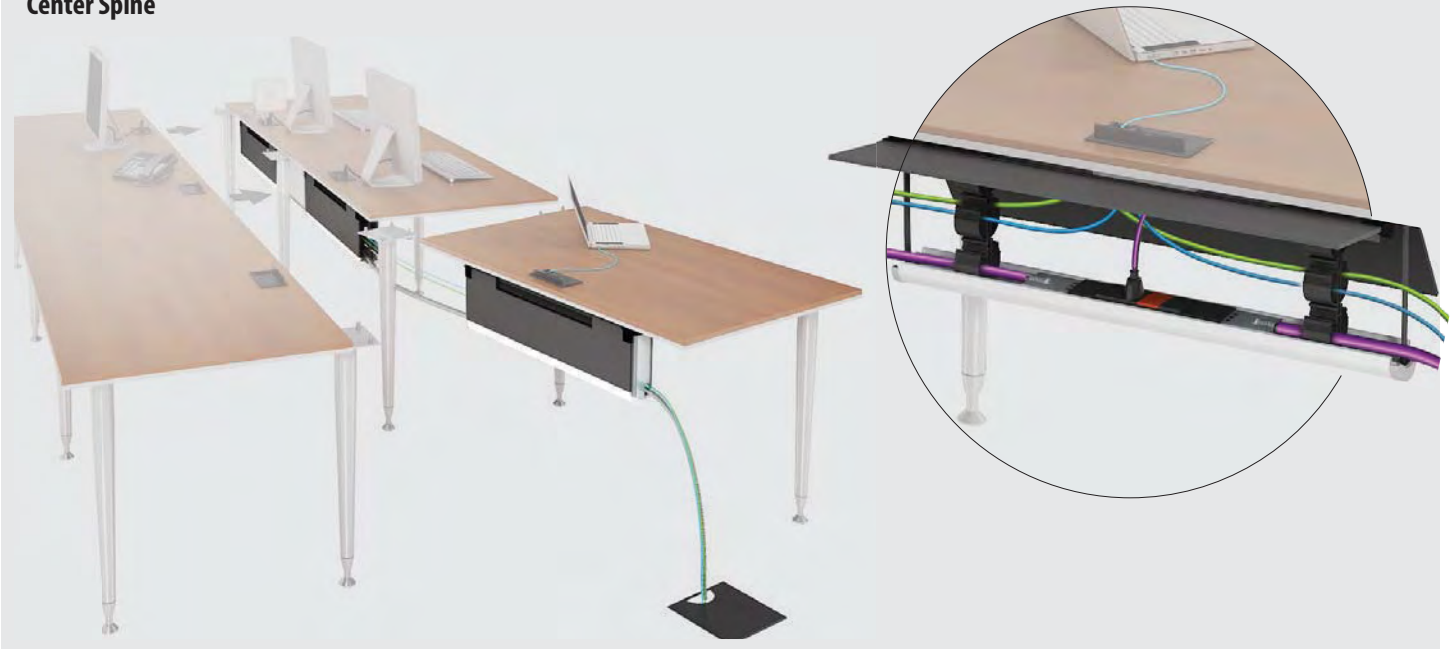

Laminate Face Panel



	w	d	h
JB72L	55.75"	4.25"	10"
JB60L	43.75"	4.25"	10"
JB48L	31.75"	4.25"	10"
JB42L	25.75"	4.25"	10"
JB36L	19.75"	4.25"	10"

- Face panel available in all Standard Bungee Laminate Finishes.

- Back panel available Black (BLK) or Brushed Cobalt (BRC).

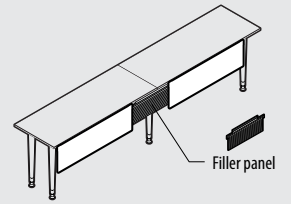
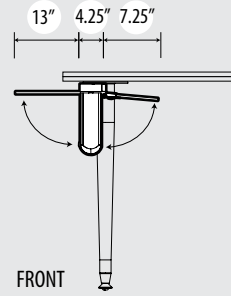

- Optional Filler Panel available.

Center Spine



	w	d	h
JB72C	55.75"	4.25"	10"
JB60C	43.75"	4.25"	10"
JB48C	31.75"	4.25"	10"
JB42C	25.75"	4.25"	10"
JB36C	19.75"	4.25"	10"

- Face panel and back panel available in Black (BLK) or Brushed Cobalt (BRC).

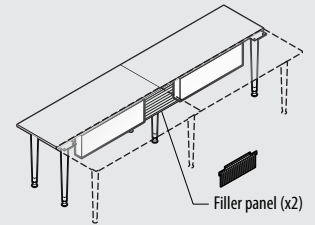
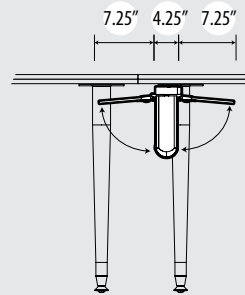

- Optional Filler Panel available.

Filler Panel

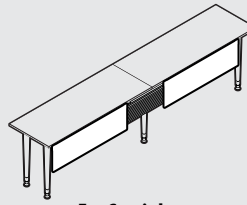
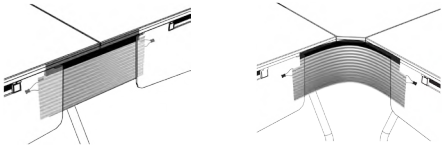

For Straight runs

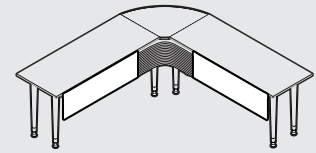

For 90° Application

Clamp / Power Snake / Cable Terminator Mount / End Cap

Clamp

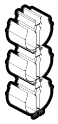

• Extra clamps are sold separately.

Power Snake

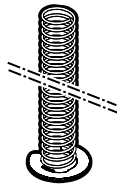

• Attaches to underside of work surface. Used to organize and channel wires from the trough to the floor-in-feed.
• Black finish only.

End Cap



• Additional End Cap for power trough
Required for beginning and end of runs.

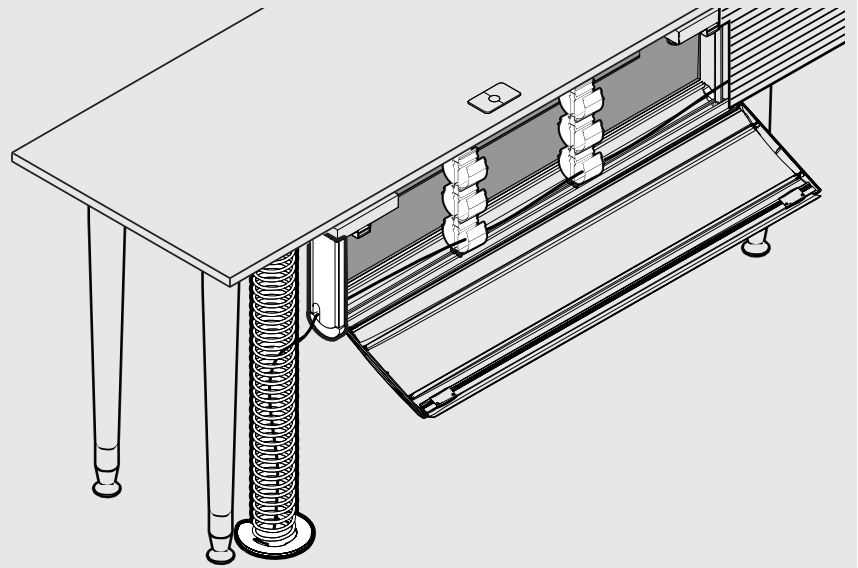

Grommets/Power Blocks



Grommet



Power Block

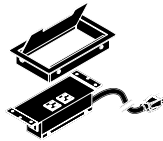

Villa Corded

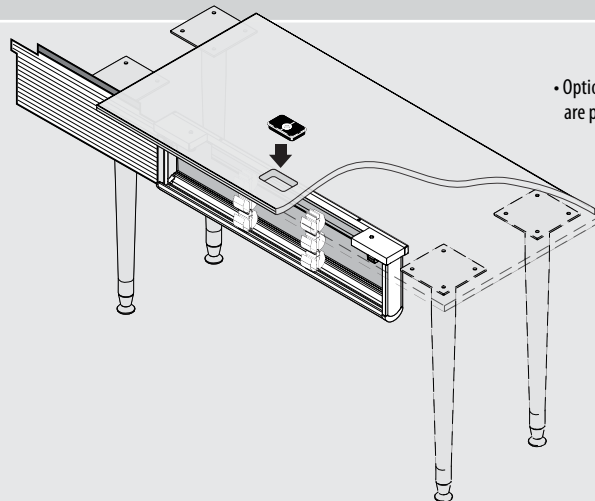

• Optional Grommets and Power Blocks are positioned directly above JuiceBox.