



power options



table of contents

02 in-surface power

03 on-surface power

04 undersurface power

05 corded vs. daisy-chain

06 symbol guide

07 understanding our guide

08 in-surface: meeting + boardroom

11 productivity solutions telecom plates

13 in-surface: meeting + boardroom

15 oasis mini telecom plates

17 in-surface - desking + training tables

19 in-surface - training tables

table of contents

23 in-surface - freefit tables

24 in-surface - collaborative spaces only

32 on-surface - anywhere

39 undersurface - telecom plates

41 undersurface - anywhere

48 application grid

50 daisy-chain electrical guide

53 conference tables - oasis mini daisy-chain

62 training tables - villa daisy-chain

66 training tables - modpower daisy-chain



global power options

overview

In-Surface Power

In-surface power modules are options that require a separate cut-out on the table or desk in order to accommodate it. In the following guide, we've split in-surface power into several categories for ease of use and specification – meeting + boardroom and desking + tables. The key difference between the two categories is where they are most appropriately utilized and where the products are available as a standard option.

In-surface power modules do not include any data or other technology ports, data and tech options can be accommodated using telecom plates. Telecom plates are sold separately.

Telecom Plates -

Telecom plates are the way to bring various types of data, A/V and audio capabilities into your power module, always purchased as an add-on to the power module itself.

Telecom plates are separated into two offerings – one offering for our Productivity Solutions power modules (all modules starting with PRTM) and another offering to go with our Oasis Mini power modules. The telecom plates themselves are nearly identical, but ship with their respective modules. We do not recommend mixing them, but it is possible to do so.

On-Surface Power

On-surface power modules are options that can be affixed to the surface itself without the need for a special cutout to accommodate it. Depending on the on-surface module, it can be affixed by screw mount, clamp mount or through a grommet.

These modules can be applied onto any product type, so long as there is room to accommodate their method of attachment

Telecom plates are not compatible with any on-surface power.

Undersurface Power

Undersurface power modules are options that can be affixed to the underside of the surface itself without the need for a special cutout to accommodate it. These are affixed with screws directly into the underside of the table.

These modules can be applied onto any product type, so long as there is room to accommodate their method of attachment.

Telecom plates are not compatible with any undersurface power.

Corded vs. Daisy-Chain

Corded -

Corded means that the power module has a standard 15-amp, 3-prong plug. In other words, this is a simple plug-n-play solution. Each corded power module requires its own power outlet.

Daisy-Chain -

Daisy-chain solutions are power modules that can be connected, one to another, before being connected to a single power source. Daisy-chaining is the means of connection between the two modules – the connection to a single power source can be either a corded solution or a hardwire solution.

Symbol Guide

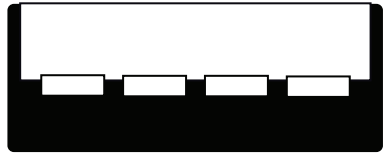

USB-A Charging Port
(Does not transfer data)

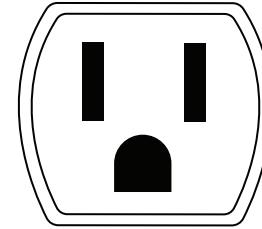

3-Prong
15A AC Outlet



USB-C Charging Port
(Does not transfer data)



RJ45 Port

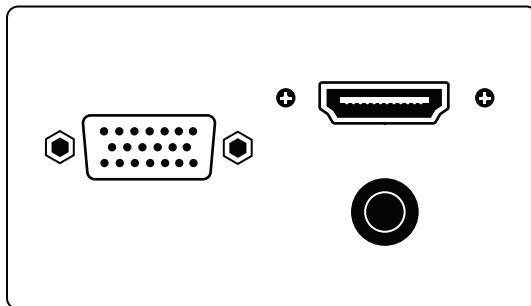

Telecom Plate Cutout
(Telecom plate must be specified separately)

Understanding Our Guide



PRTMCD642 ←

Model #

\$\$\$

- Mid-market meeting + conference table solution ←
- Recessed lid
- Simple corded solution, not approved for daisy-chaining ←
- Available in Black and Tungsten and Designer White
- Duplex outlet is always grey
- Cut-out option T1, T2, or T3 to be specified when ordering ←

Market position and suggested use

Indicates how the power module can connect to other modules

Indicates the cutout code required on the worksurface to accommodate the power module

Power / Tech Accessible at Surface

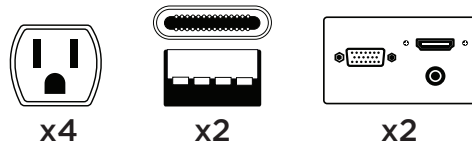

← Symbols provide a quick overview of the power available at the surface

Below Surface



← If there are power outlets below the worksurface, it's indicated here

In-Surface - Meeting + Boardroom



PRTMCS401

\$\$\$

- Mid-market meeting + conference table solution
- Recessed lid
- Simple corded solution, not approved for daisy-chaining
- Available in Black, Tungsten and Designer White
- Duplex outlet is always grey
- Cut-out option R1, R2 or R3 to be specified when ordering

Power / Tech Accessible at Surface

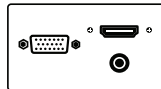

x1



x2

Below Surface



x1



PRTMCS421

\$\$\$

- Mid-market meeting + conference table solution
- Recessed lid
- Simple corded solution, not approved for daisy-chaining
- Available in Black, Tungsten and Designer White
- Duplex outlet is always grey
- Cut-out option R1, R2 or R3 to be specified when ordering

Power / Tech Accessible at Surface

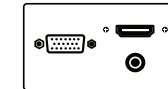

x1



x2



x1

Below Surface

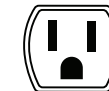

x1

In-Surface - Meeting + Boardroom



PRTMCD602

\$\$\$

- Mid-market meeting + conference table solution
- Recessed lid
- Simple corded solution, not approved for daisy-chaining
- Available in Black, Tungsten and Designer White
- Duplex outlet is always grey
- Cut-out option T1, T2 or T3 to be specified when ordering

Power / Tech Accessible at Surface

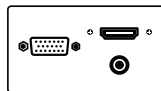

x2

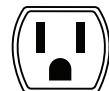

x4

Below Surface



x1



PRTMCD622

\$\$\$

- Mid-market meeting + conference table solution
- Recessed lid
- Simple corded solution, not approved for daisy-chaining
- Available in Black, Tungsten and Designer White
- Duplex outlet is always grey
- Cut-out option T1, T2 or T3 to be specified when ordering

Power / Tech Accessible at Surface

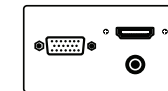

x2

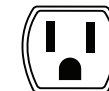

x4

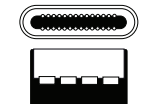

x1

Below Surface

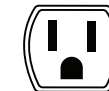

x1

In-Surface - Meeting + Boardroom



PRTMCD42

\$\$\$

- Mid-market meeting + conference table solution
- Recessed lid
- Simple corded solution, not approved for daisy-chaining
- Available in Black, Tungsten and Designer White
- Duplex outlet is always grey
- Cut-out option T1, T2 or T3 to be specified when ordering

Power / Tech Accessible at Surface

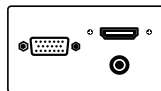

x2



x4

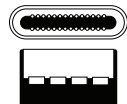

x2

Below Surface



x1

Productivity Solutions Telecom Plates

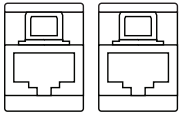

Telecom Plate - 2 x 6

PTELO1
Black Finish
(2) RJ45 cat 6 data ports
To be hardwired by data contractor

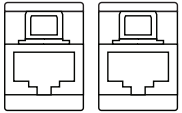

Telecom Plate - 2 x 6

PTEL12
Grey Finish
(2) RJ45 cat 6 data ports
To be hardwired by data contractor

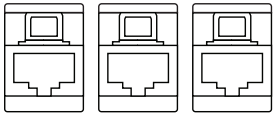

Telecom Plate - 3 x 6

PTELO2
Black Finish
(2) RJ45 cat 6 data ports, (1) RJ11
To be hardwired by data contractor

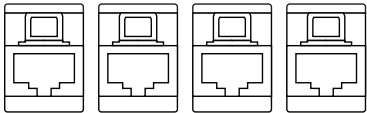

Telecom Plate - 4 x 6

PTELO3
Black Finish
(4) RJ45 cat 6 data ports
To be hardwired by data contractor

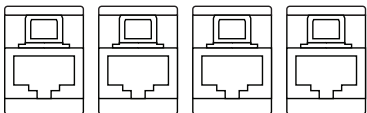

Telecom Plate - 4 x 6

PTEL13
Grey Finish
(4) RJ45 cat 6 data ports
To be hardwired by data contractor

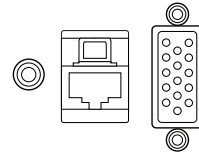

Telecom Plate - 3TSV

PTELO4
Black Finish
(1) RJ45 cat 6 port, mini stereo, 15-pin VGA
To be hardwired by data contractor

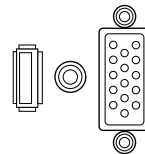

Telecom Plate - 3AVH

PTELO5
Black Finish
Mini stereo, 15-pin VGA, HDMI

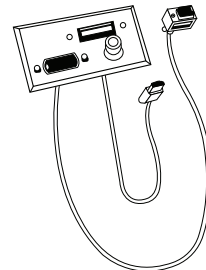

Telecom Plate - SVH

PTEL14
Grey Finish
Mini stereo, 15-pin VGA, HDMI

Productivity Solutions Telecom Plates

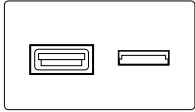

Telecom Plate - 1 USB-C, 1 USB-A

PTEL08

Grey Finish

(1) USB-C port, (1) USB-A port

Requires PUSBTRSF to power for charging application

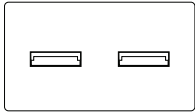

Telecom Plate - 2 USB-A

PTEL09

Grey Finish

(2) USB-A ports

USB transfers data

Requires PUSBTRSF to power for charging application

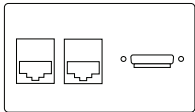

Telecom Plate - 2 RJ45, 1HDMI

PTEL10

Grey Finish

(2) RJ45 cat 6 ports, HDMI

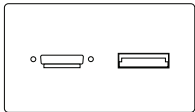

Telecom Plate - 1HDMI, 1 USB-A

PTEL11

Grey Finish

(1) HDMI, (1) USB-A

USB transfers data

Requires PUSBTRSF to power for charging application

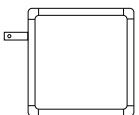

Powered USB Transformer

PUSBTRSF

Transformer with (1) USB-C and (2) USB-A ports to provide power

In-Surface - Meeting + Boardroom



OASIS MINI A

\$\$\$

- Premium meeting + conference table solution
- Recessed lid
- Simple corded solution or daisy-chain solutions available
- Available in Black and Tungsten
- Cut-out option M1, M2, or M3 to be specified when ordering

Power / Tech Accessible at Surface

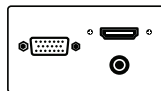

x2



x6

No Power Access Below Worksurface



OASIS MINI B

\$\$\$

- Premium meeting + conference table solution
- Recessed lid
- Simple corded solution or daisy-chain solutions available
- Available in Black and Tungsten
- Cut-out option M1, M2 or M3 to be specified when ordering

Power / Tech Accessible at Surface

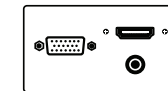

x3

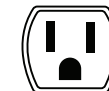

x4

No Power Access Below Worksurface

In-Surface - Meeting + Boardroom



OASIS MINI USB

\$\$\$

- Premium meeting + conference table solution
- Recessed lid
- Simple corded solution or daisy-chain solutions available
- Available in Black and Tungsten
- Cut-out option M1, M2, or M3 to be specified when ordering

Power / Tech Accessible at Surface

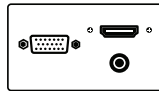

x1



x6



x2

No Power Access Below Worksurface

Oasis Mini Telecom Plates

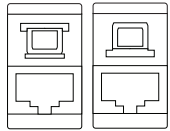

A-__-A-B

A-__-A-B
Telecom plate with RJ11
Cat 3 Phone and RJ45
Cat 6 Data

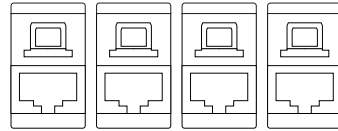

A-__-B-B-B-B

A-__-B-B-B-B
(4) RJ45 Cat 6
Connectors

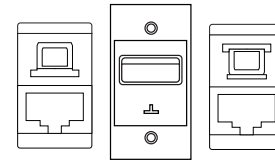

A-__-A-B-102

A-__-A-B-102
RJ11 Cat 3 phone, RJ45
Cat 6 Data and USB with
72" patch cord attached

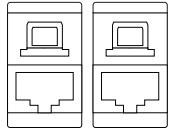

A-__-B-B

A-__-B-B
(2) RJ45 Cat 6
Connectors

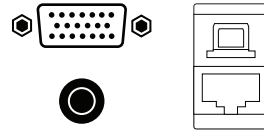

A-__-B-C51-L

A-__-B-C51-L
RJ45 Cat 6 Data, Mini
Stereo Inline and 15 pin
HD VGA Female/Female
with 72" patch cord
attached

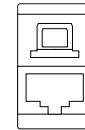

A-__-B

A-__-B
RJ45 Cat 6 Data

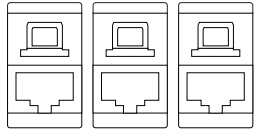

A-__-B-B-B

A-__-B-B-B
(3) RJ45 Cat 6
Connectors

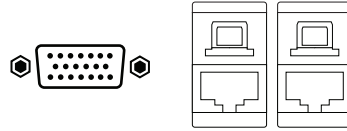

A-__-B-B-C51

A-__-B-B-C51
(2) RJ45 Cat 6 Data and
(1) 15 pin HD VGA
Female/Female with 72"
patch cord attached

Oasis Mini Telecom Plates



A-__-C51-L

A-__-C51L
Mini Stereo Inline and 15 pin HD VGA Female/Female with 72" patch cord attached



A-__-C45

A-__-C45
HDMI Female/Female with 36" patch cord attached

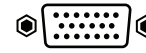

A-__-C51

A-__-C51
15 pin HD VGA Female/Female with 72" patch cord attached

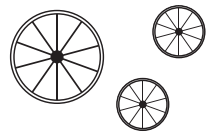

A-__-CRDMINDER

A-__-CRDMINDER
Cordminder Plate - 2 5/8" holes and 1 7/8" holes



A-__

A-__
Blank telecom plate

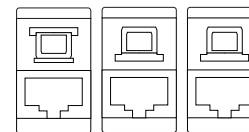

A-__A-B-B

A-__A-B-B
(1) RJ11 Cat 3 Phone and (2) RJ45 Cat 6 data



A-__-C45-C51-L

A-__-C45-C51-L
HDMI Female/Female with 36" patch cord attached. Mini stereo Inline and 15 pin HD VGA Female/Female with 72" patch cord attached

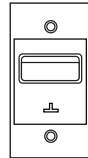

A-__-102

A-__-102
USB with 72" patch cord attached

In-Surface - Desking + Training Tables



PMSPDM

\$\$\$

- Value based meeting, conference table + desking solution
- Recessed lid
- Simple corded solution, not approved for daisy-chaining
- Available in Black only
- Cut-out option E1, E2, or E3 to be specified when ordering

Power / Tech Accessible at Surface



x2



x2

No Power Access Below Worksurface



COV-SM-U-x-108, COVE MINI -Charging USB

\$\$\$

- Mid-market meeting, conference table + desking solution
- Flush surface mount, no lid.
- Simple corded solution, not approved for daisy-chaining
- Available in Black or Tungsten
- Cut-out option AG1, AG2, or AG3 to be specified when ordering. When ordering Princeton, can be used with POG1, POG2, POG3.

Power / Tech Accessible at Surface



x2

No Power Access Below Worksurface

In-Surface - Desking + Training Tables



COV-SM-1U-x-108, COVE MINI - POWER + CHARGING USB

\$\$\$

- Mid-market meeting, conference table + desking solution
- Flush surface mount, no lid
- Simple corded solution, not approved for daisy-chaining
- Available in Black or Tungsten
- Cut-out option AG1, AG2 or AG3 to be specified when ordering. When ordering Princeton, can be used with POG1, POG2, POG3.

Power / Tech Accessible at Surface



x1

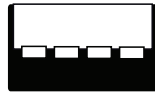

x2

No Power Access Below Worksurface



COV-SM-2-x-108, COVE MINI - POWER

\$\$\$

- Mid-market meeting, conference table + desking solution
- Flush surface mount, no lid.
- Simple corded solution, not approved for daisy-chaining
- Available in Black or Tungsten
- Cut-out option AG1, AG2, or AG3 to be specified when ordering. When ordering Princeton, can be used with POG1, POG2, POG3.

Power / Tech Accessible at Surface

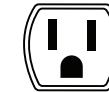

x2

No Power Access Below Worksurface

In-Surface - Training Tables



VILLA I, NO DATA PORTS

\$\$\$

- Premium training table solution
- Flip lid
- Simple corded solution or daisy-chain solutions available
- Available in Black or Tungsten
- Cut-out option V1, V2 or V3 to be specified when ordering



VILLA II, NO DATA PORTS

\$\$\$

- Premium training table solution
- Flip lid
- Simple corded solution or daisy-chain solutions available
- Available in Black or Tungsten
- Cut-out option V1, V2, V3 to be specified when ordering

Power / Tech Accessible at Surface



x2

No Power Access Below Worksurface



x1

Power / Tech Accessible at Surface

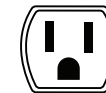

x2

Below Surface

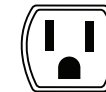

x2

In-Surface - Training Tables



VILLA I, DATA PORTS

\$\$\$

- Premium training table solution
- Flip lid
- Simple corded solution or daisy-chain solutions available
- Available in Black or Tungsten
- Cut-out option V1, V2 or V3 to be specified when ordering



VILLA III, NO DATA PORTS

\$\$\$

- Premium training table solution
- Flip lid
- Simple corded solution or daisy-chain solutions available
- Available in Black or Tungsten
- Cut-out option V1, V2, V3 to be specified when ordering

Power / Tech Accessible at Surface

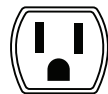

x2



x2

No Power Access Below Worksurface

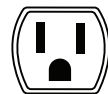

x1

Power / Tech Accessible at Surface

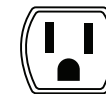

x2



x2

Below Surface

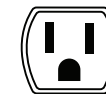

x2

In-Surface - Training Tables



VILLA USB, NO DATA PORTS

\$\$\$

- Premium training table solution
- Flip lid
- Daisy-chain solution
- Available in Black or Tungsten
- Cut-out option V1, V2 or V3 to be specified when ordering



VILLA USB, DATA PORTS

\$\$\$

- Premium training table solution
- Flip lid
- Daisy-chain solution
- Available in Black or Tungsten
- Cut-out option V1, V2, V3 to be specified when ordering

Power / Tech Accessible at Surface

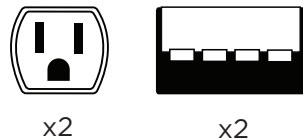

No Power Access Below Worksurface

Power / Tech Accessible at Surface

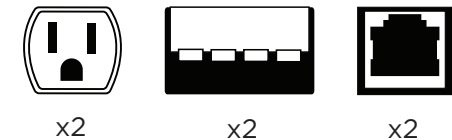

No Power Access Below Worksurface

In-Surface - Training Tables



MODPOWER

\$\$\$

- Mid-market training table solution
- Flush surface mount, no lid
- Daisy-chain solution
- Available in Magnesium and White
- Cut-out option MPS for single, centered cut-out
- Cut-out option MPD for two cut-outs in the left and right positions

Power / Tech Accessible at Surface



x3

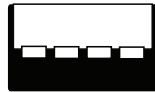

x1

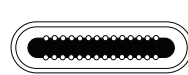

x1

No Power Access Below Worksurface

In-Surface - FreeFit, FreeFit Benching + Softpod Only



FREEFIT POWER GROMMET + MODULE

\$\$\$

- Exclusive grommet with optional power bar for FreeFit + FreeFit benching + Softpod
- Flip lid. Optional device holder (shown)
- Simple corded solution
- Available in Black, Designer White, or Tungsten. Phone holder is White only
- Cut-out option GL/GR for cutout left or right center

Power / Tech Accessible at Surface



x3

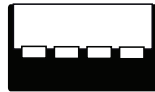

x2

No Power Access Below Worksurface

In-Surface - Collaborative Spaces Only



SCTAPSC

\$\$\$

- Exclusive “pill” shaped power module for use in Collaborative Spaces tables only
- Simple corded solution, not approved for daisy-chaining
- Available in Black only
- Cut-out option C1, C2 or C3 to be specified when ordering

Power / Tech Accessible at Surface



x2



x2

No Power Access Below Worksurface



SCTAPSD

\$\$\$

- Exclusive “pill” shaped power module for use in Collaborative Spaces tables only
- Simple corded solution, not approved for daisy-chaining
- Available in Black only
- Cut-out option C1, C2 or C3 to be specified when ordering

Power / Tech Accessible at Surface

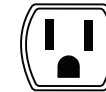

x1



x2

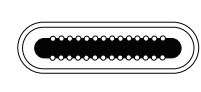

x1

No Power Access Below Worksurface

In-Surface - Collaborative Spaces Only



SCTAPSE

\$\$\$

- Exclusive “pill” shaped power module for use in Collaborative Spaces tables only
- Simple corded solution, not approved for daisy-chaining
- Available in Black only
- Cut-out option C1, C2 or C3 to be specified when ordering

Power / Tech Accessible at Surface



x3

No Power Access Below Worksurface

In-Surface - Collaborative Spaces Only



SCTAOTC

\$\$\$

- Exclusive “pill” shaped power module for use in Collaborative Spaces tables only
- Includes accessory tray
- Simple corded solution, not approved for daisy-chaining
- Available in Black only. Removable accessory trays in Grey only
- Cut-out option C1, C2 or C3 to be specified when ordering

Power / Tech Accessible at Surface



x2



x2

No Power Access Below Worksurface



SCTAOTD

\$\$\$

- Exclusive “pill” shaped power module for use in Collaborative Spaces tables only
- Includes accessory tray
- Simple corded solution, not approved for daisy-chaining
- Available in Black only. Removable accessory trays in Grey only
- Cut-out option C1, C2 or C3 to be specified when ordering

Power / Tech Accessible at Surface

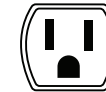

x1



x2

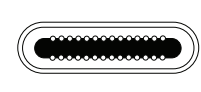

x1

No Power Access Below Worksurface

In-Surface - Collaborative Spaces Only



SCTAOTE

\$\$\$

- Exclusive “pill” shaped power module for use in Collaborative Spaces tables only
- Includes accessory tray
- Simple corded solution, not approved for daisy-chaining
- Available in Black only. Removable accessory trays in Grey only
- Cut-out option C1, C2 or C3 to be specified when ordering

Power / Tech Accessible at Surface



x3

No Power Access Below Worksurface

In-Surface - Collaborative Spaces Only

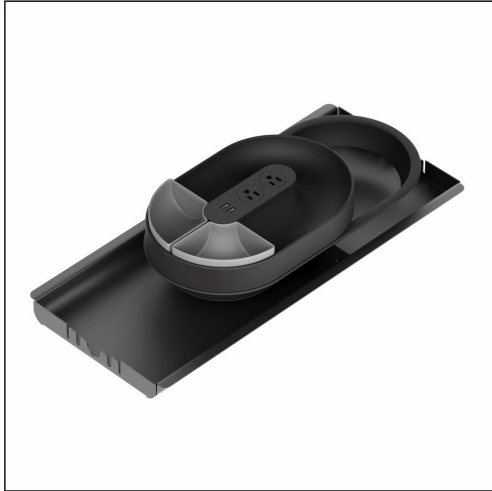

SCTAPTC

\$\$\$

- Exclusive “pill” shaped power module for use in Collaborative Spaces tables only
- Includes accessory tray + recessed cable tray
- Simple corded solution, not approved for daisy-chaining
- Available in Black only. Removable accessory trays in Grey only
- Cut-out option O1, O2 or O3 to be specified when ordering

Power / Tech Accessible at Surface

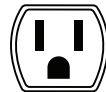

x2



x2

No Power Access Below Worksurface



SCTAPTD

\$\$\$

- Exclusive “pill” shaped power module for use in Collaborative Spaces tables only
- Includes accessory tray + recessed cable tray
- Simple corded solution, not approved for daisy-chaining
- Available in Black only. Removable accessory trays in Grey only
- Cut-out option O1, O2 or O3 to be specified when ordering

Power / Tech Accessible at Surface

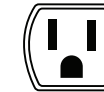

x1



x2

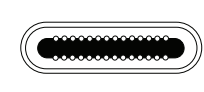

x1

No Power Access Below Worksurface

In-Surface - Collaborative Spaces Only

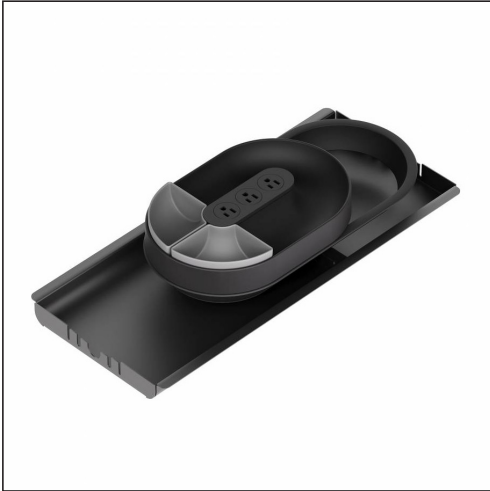

SCTAPTE

\$\$\$

- Exclusive “pill” shaped power module for use in Collaborative Spaces tables only
- Includes accessory tray + recessed cable tray
- Simple corded solution, not approved for daisy-chaining
- Available in Black only. Removable accessory trays in Grey only
- Cut-out option O1, O2 or O3 to be specified when ordering

Power / Tech Accessible at Surface



x3

No Power Access Below Worksurface

In-Surface - Collaborative Spaces Only

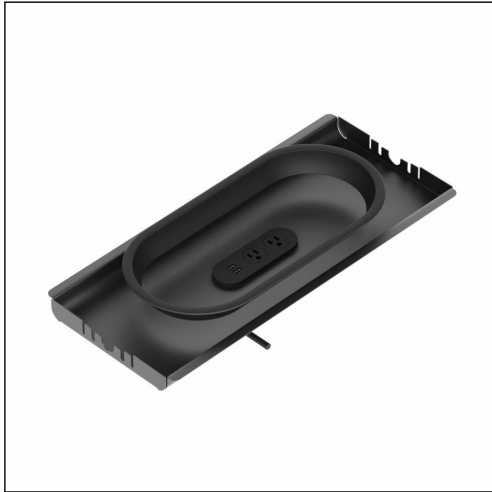

SCTAPRC

\$\$\$

- Exclusive “pill” shaped power module for use in Collaborative Spaces tables only
- Includes recessed cable tray
- Simple corded solution, not approved for daisy-chaining
- Available in Black only
- Cut-out option O1, O2 or O3 to be specified when ordering

Power / Tech Accessible at Surface



x2



x2

No Power Access Below Worksurface



SCTAPRD

\$\$\$

- Exclusive “pill” shaped power module for use in Collaborative Spaces tables only
- Includes recessed cable tray
- Simple corded solution, not approved for daisy-chaining
- Available in Black only
- Cut-out option O1, O2 or O3 to be specified when ordering

Power / Tech Accessible at Surface

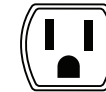

x1



x2

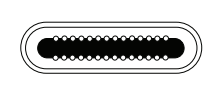

x1

No Power Access Below Worksurface

In-Surface - Collaborative Spaces Only



SCTAPRE

\$\$\$

- Exclusive “pill” shaped power module for use in Collaborative Spaces tables only
- Includes recessed cable tray
- Simple corded solution, not approved for daisy-chaining
- Available in Black only
- Cut-out option O1, O2 or O3 to be specified when ordering

Power / Tech Accessible at Surface



x3

No Power Access Below Worksurface

On-Surface - Anywhere

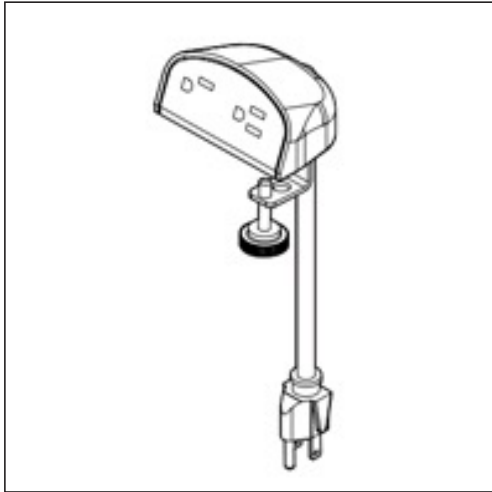

PEUTEM

\$\$\$

- Value based solution - clamps at edge or through a grommet
- Simple corded solution, not approved for daisy-chaining
- Available in Black only

Power / Tech Accessible at Surface



x2

No Power Access Below Worksurface



ASHLEY DUO - 2 POWER / 2 USB-A

\$\$\$

- Mid-market solution - clamps at edge or through a grommet
- Simple corded solution, not approved for daisy-chaining
- Available in Black or White

Power / Tech Accessible at Surface

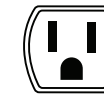

x2



x2

No Power Access Below Worksurface

On-Surface - Anywhere



ASHLEY DUO - 2 POWER / USB A-C \$\$\$

- Mid-market solution - clamps at edge or through a grommet
- Simple corded solution, not approved for daisy-chaining
- Available in Black and White

Power / Tech Accessible at Surface



x2



x1

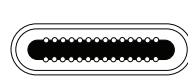

x1

No Power Access Below Worksurface



ASHLEY TRIO - 3 POWER / 2 USB A \$\$\$

- Mid-market solution - clamps at edge or through a grommet
- Simple corded solution, not approved for daisy-chaining
- Available in Black or White

Power / Tech Accessible at Surface

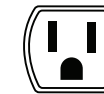

x3



x2

No Power Access Below Worksurface

On-Surface - Anywhere

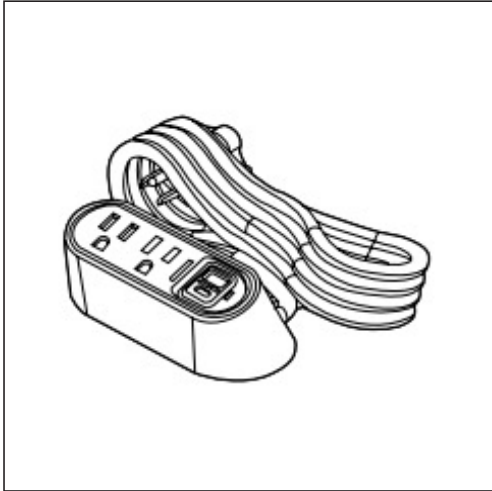

DPC SLIM - 2 POWER / USB A-C

\$\$\$

- Mid-market solution - screw-in mounting plate for forward facing outlets; under surface mount bracket; or a clamp mounting kit
- Simple corded solution, not approved for daisy-chaining
- Available in White only

Power / Tech Accessible at Surface

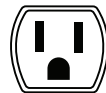

x2



x1

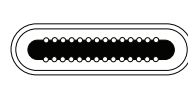

x1

No Power Access Below Worksurface

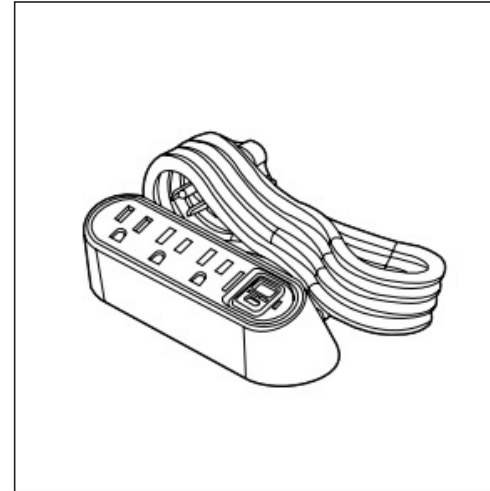

DPC SLIM - 3 POWER / USB A-C

\$\$\$

- Mid-market solution - screw-in mounting plate for forward facing outlets; under surface mount bracket; or clamp mounting kit
- Simple corded solution, not approved for daisy-chaining
- Available in White only

Power / Tech Accessible at Surface

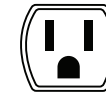

x3



x1

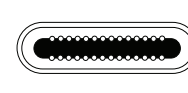

x1

No Power Access Below Worksurface

On-Surface - Anywhere



MODPOWER

\$\$\$

- Mid-market solution. Ideal application on training tables. Screw-in mounting plate for forward facing outlets; under surface mount bracket; or a clamp mounting kit
- Daisy-chain solution
- Available in Magnesium and White

Power / Tech Accessible at Surface



x3



x1



x1

No Power Access Below Worksurface

On-Surface - Anywhere



SCTAPEA

\$\$\$

- Premium clamp mount solution. Clamps at the edge of any surface
- Simple corded solution, not approved for daisy-chaining
- Available in Black only

Power / Tech Accessible at Surface



x1



x2

No Power Access Below Worksurface



SCTAPEB

\$\$\$

- Premium clamp mount solution. Clamps at the edge of any surface
- Simple corded solution, not approved for daisy-chaining
- Available in Black only

Power / Tech Accessible at Surface

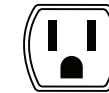

x2

No Power Access Below Worksurface

On-Surface - Anywhere



SCTAPEC

\$\$\$

- Premium clamp mount solution. Clamps at the edge of any surface
- Simple corded solution, not approved for daisy-chaining
- Available in Black only

Power / Tech Accessible at Surface

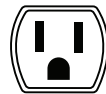

x2



x2

No Power Access Below Worksurface



SCTAPED

\$\$\$

- Premium clamp mount solution. Clamps at the edge of any surface
- Simple corded solution, not approved for daisy-chaining
- Available in Black only

Power / Tech Accessible at Surface

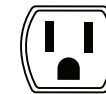

x1



x2

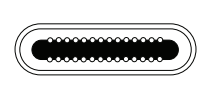

x1

No Power Access Below Worksurface

On-Surface - Anywhere



SCTAPEE

\$\$\$

- Premium clamp mount solution. Clamps at the edge of any surface
- Simple corded solution, not approved for daisy-chaining
- Available in Black only

Power / Tech Accessible at Surface



x3

No Power Access Below Worksurface

Undersurface - Use with Productivity Solutions Telecom Plates



PGDPS41

\$\$\$

- Value solution for use on most products. Screw-in mounting plate for undersurface or side mounting
- Simple corded solution, not approved for daisy-chaining
- Available in Tungsten

Power / Tech Accessible at Surface

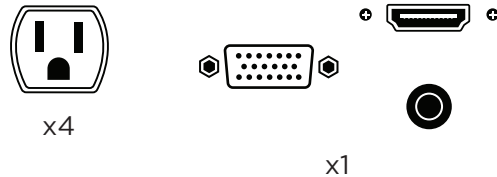

No Power Access Below Worksurface



PGDPS20

\$\$\$

- Value solution for use on most products. Screw-in mounting plate for undersurface or side mounting
- Simple corded solution, not approved for daisy-chaining
- Available in Tungsten

Power / Tech Accessible at Surface



No Power Access Below Worksurface

Undersurface - Use with Productivity Solutions Telecom Plates



PGDPS21

\$\$\$

- Value solution for use on most products.
Screw-in mounting plate for undersurface or side mounting
- Simple corded solution, not approved for daisy-chaining
- Available in Tungsten

Power / Tech Accessible at Surface

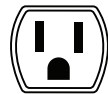

x2

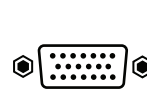

x1

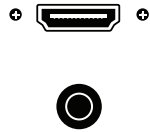

No Power Access Below Worksurface

Undersurface - Anywhere



ASHLEY DUO UNDERMOUNT - 2 POWER / 2 USB-A

\$\$\$

- Mid-market solution - undermounts at surface edge
- Simple corded solution, not approved for daisy-chaining
- Available in Black or White

Power / Tech Accessible at Surface



x2



x2

No Power Access Below Worksurface



ASHLEY DUO UNDERMOUNT - 2 POWER / USB A-C

\$\$\$

- Mid-market solution - undermounts at surface edge
- Simple corded solution, not approved for daisy-chaining
- Available in Black and white

Power / Tech Accessible at Surface

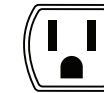

x2



x1

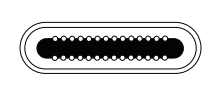

x1

No Power Access Below Worksurface

Undersurface - Anywhere



ASHLEY TRIO Undermount - 3 POWER / 2 USB-A

\$\$\$

- Mid-market solution - undermount at surface edge
- Simple corded solution, not approved for daisy-chaining
- Available in White only

Power / Tech Accessible at Surface



x3



x2

No Power Access Below Worksurface

Undersurface - Anywhere



SCTAPBA

\$\$\$

- Premium undersurface mount solution. Screw-in mounting.
- Simple corded solution, not approved for daisy-chaining
- Available in Black only

Power / Tech Accessible at Surface



x1



x2

No Power Access Below Worksurface



SCTAPBB

\$\$\$

- Premium undersurface mount solution. Screw-in mounting.
- Simple corded solution, not approved for daisy-chaining
- Available in Black only

Power / Tech Accessible at Surface

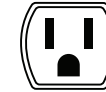

x2

No Power Access Below Worksurface

Undersurface - Anywhere



SCTAPBC

\$\$\$

- Premium undersurface mount solution. Screw-in mounting.
- Simple corded solution, not approved for daisy-chaining
- Available in Black only

Power / Tech Accessible at Surface



x2



x2

No Power Access Below Worksurface



SCTAPBD

\$\$\$

- Premium undersurface mount solution. Screw-in mounting.
- Simple corded solution, not approved for daisy-chaining
- Available in Black only

Power / Tech Accessible at Surface

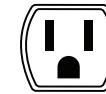

x1



x2



x1

No Power Access Below Worksurface

Undersurface - Anywhere



SCTAPBE

\$\$\$

- Premium undersurface mount solution.
Screw-in mounting.
- Simple corded solution, not approved for daisy-chaining
- Available in Black only

Power / Tech Accessible at Surface



x3

No Power Access Below Worksurface

Undersurface - Anywhere

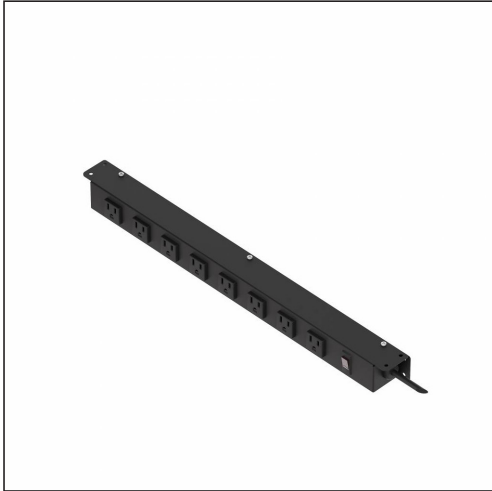

SCTAPPBS

\$\$\$

- Premium undersurface power bar. Screw-in mounting.
- Simple corded solution, not approved for daisy-chaining
- All outlets on one side of bar
- Available in Black only

Power / Tech Accessible at Surface



x8

No Power Access Below Worksurface



SCTAPPD

\$\$\$

- Premium undersurface mount solution. Screw-in mounting.
- Simple corded solution, not approved for daisy-chaining
- Outlets on both sides of bar
- Available in Black only

Power / Tech Accessible at Surface

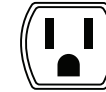

x8

No Power Access Below Worksurface

Undersurface - Anywhere



HXEUWC

\$\$\$

- Mid-market undersurface mount solution.
Screw-in mounting
- Simple corded solution, not approved for daisy-chaining
- Available in white only

Power / Tech Accessible at Surface



x1



x1

No Power Access Below Worksurface

Power Solutions - Application Grid

NAME	TYPE	MODEL #	FINISHES AVAILABLE	Everywhere	Adaptabilities Tables	Boardroom Tables	Bungee	Bungee SL	Collaborative Spaces	Connectables	Edventure
Power Solutions	In-surface	PRTMCS401	Black, Tungsten or Designer White								
Power Solutions	In-surface	PRTMCS421	Black, Tungsten or Designer White								
Power Solutions	In-surface	PRTMCD6**	Black, Tungsten or Designer White								
Power Solutions	In-surface	PRTMCD6**	Black, Tungsten or Designer White								
Power Solutions	In-surface	PRTMCD6**	Black, Tungsten or Designer White								
Oasis Mini	In-surface	Various	Black or Silver Pearl								
Villa	In-surface	Various	Black or Tungsten				○	○		○	
ModPower	In-surface	Various	Magnesium or White				○	○		○	
Power Solutions	In-surface	PMSPDM	Black Only		○	○	○	○		○	○
Cove Mini	In-surface	COV-SM-U-x-108	Black or Tungsten		○	○	○	○		○	○
Cove Mini	In-surface	COV-SM-1U-x-108	Black or Tungsten		○	○	○	○		○	○
Collaborative Spaces	In-surface	Various	Black Only						○		
Collaborative Spaces Recessed	In-surface	Various	Black Only						○		
Collaborative Spaces w/Tray	In-surface	Various	Black Only						○		
Collaborative Spaces Recessed w/Tray	In-surface	Various	Black Only						○		
Power Grommet + Module	In-surface	Various	White Only								
Cove Mini	In-surface	COV-SM-2-x-108	Black or Tungsten		○	○	○	○		○	○
DPC Slim	On-surface	PSDPC22W	White Only	○							
DPC Slim	On-surface	PSDPC32W	White Only	○							
Collaborative Spaces Clamp Module	On-surface	Various	Black Only	○							
Ashley Duo USB-A	On-surface	PS3050xx	Black or White	○							
Ashley Duo USB-C	On-surface	PS35250xx	Black or White	○							
Power Solutions	On-surface	PEUTEM	Black Only	○							
ModPower	On-surface	Various	Magnesium or White	○*							
Ashley Duo USB-A	Undersurface	PS3051xx	Black or White	○							
Ashley Duo USB-C	Undersurface	PS35260xx	Black or White	○							
Collaborative Spaces Undermount	Undersurface	Various	Black Only	○							
Softpod USB Undermount	Undersurface	HXEUWC	White Only	○							

Power Solutions - Application Grid

NAME	TYPE	MODEL #	FINISHES AVAILABLE	FreeFit Tables	Junction	Kadin	Princeton Tables	Softpod	Swap	Terina	Zira Boardroom	Zook*
Power Solutions	In-surface	PRTMCS401	Black, Tungsten or Designer White			○			○		○	○
Power Solutions	In-surface	PRTMCS421	Black, Tungsten or Designer White			○			○		○	○
Power Solutions	In-surface	PRTMCD6**	Black, Tungsten or Designer White			○			○		○	○
Power Solutions	In-surface	PRTMCD6**	Black, Tungsten or Designer White			○			○		○	○
Power Solutions	In-surface	PRTMCD6**	Black, Tungsten or Designer White			○			○		○	○
Oasis Mini	In-surface	Various	Black or Silver Pearl			○			○		○	○
Villa	In-surface	Various	Black or Tungsten		○					○		○
ModPower	In-surface	Various	Magnesium or White		○					○		○
Power Solutions	In-surface	PMSPDM	Black Only	○	○	○	○		○	○	○	○
Cove Mini	In-surface	COV-SM-U-x-108	Black or Tungsten	○	○	○	○		○	○	○	○
Cove Mini	In-surface	COV-SM-1U-x-108	Black or Tungsten	○	○	○	○		○	○	○	○
Collaborative Spaces	In-surface	Various	Black Only									
Collaborative Spaces Recessed	In-surface	Various	Black Only									
Collaborative Spaces w/Tray	In-surface	Various	Black Only									
Collaborative Spaces Recessed w/Tray	In-surface	Various	Black Only									
Power Grommet + Module	In-surface	Various	White Only	○				○				
Cove Mini	In-surface	COV-SM-2-x-108	Black or Tungsten	○	○	○	○		○	○	○	○
DPC Slim	On-surface	PSDPC22W	White Only									
DPC Slim	On-surface	PSDPC32W	White Only									
Collaborative Spaces Clamp Module	On-surface	Various	Black Only									
Ashley Duo USB-A	On-surface	PS3050xx	Black or White									
Ashley Duo USB-C	On-surface	PS35250xx	Black or White									
Power Solutions	On-surface	PEUTEM	Black Only									
ModPower	On-surface	Various	Magnesium or White									
Ashley Duo USB-A	Undersurface	PS3051xx	Black or White									
Ashley Duo USB-C	Undersurface	PS35260xx	Black or White									
Collaborative Spaces Undermount	Undersurface	Various	Black Only									
Softpod USB Undermount	Undersurface	HXEUWC	White Only									



global daisy-chain
electrical guide

Daisy Chain Electrical Guide

Oasis Mini + Villa -

When to use a 3-prong plug infeed and when to use a hardwire infeed

The same electrical system is utilized for the conference table power blocks (OASIS MINI A, B + USB) as well as the training table power blocks (VILLA I, VILLA II, VILLA USB). The section below describes infeeds for daisy-chain compatible unit there are also standalone corded units that include their own 3-prong plug.

90% of the time, you will only need a single circuit to handle the amount of power being daisy-chained. In these instances, you can use either the 42AP1-72 or the 42SB2-XX infeed, depending on preference of a 3-prong plug or a hardwire connection. All model #'s printed in the price book are specified to Circuit 1, so you won't need to change anything on most specifications.

EXAMPLES:

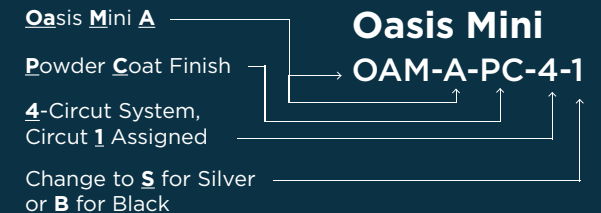
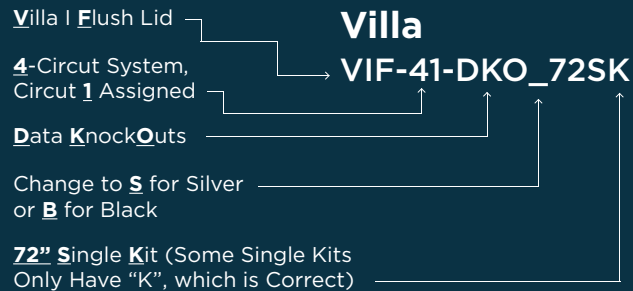

Daisy Chain Electrical Guide

Oasis Mini + Villa -

When to use a 3-prong plug infeed and when to use a hardwire infeed

Guidelines for how many units can be daisy-chained on a SINGLE CIRCUIT are as follows

- Oasis Mini A - 3 units per circuit
- Oasis Mini B - 3 units per circuit
- Villa + Villa I USB - 8 units per circuit
- Villa II - 4 units per circuit

NOTE: Villa Double Block Kits contain two units.

- The other 10% of the time, where you are daisy-chaining a larger amount of units together, you may require two circuits.
- You MUST specify a 42SB2-XX hardwire infeed when using a two-circuit solution
- In order to specify items on circuit two, simply change the "1" in the model # to a "2"

Villa

VIF-42-DKO_72SK

Oasis Mini

OAM-A-PC-4-2-_-

- On the following pages, all examples shown are utilizing a single circuit configuration.



conference tables

oasis mini daisy-chain electrical guide

Conference Tables - Oasis Mini Daisy-Chain

Example of cutout positions on a Conference Table for Oasis Mini Power Troughs. Table with M1, M2 and M3 position cutouts for daisy-chain Oasis Mini power troughs. Cutouts must be specified on the table when using Oasis Mini power troughs.

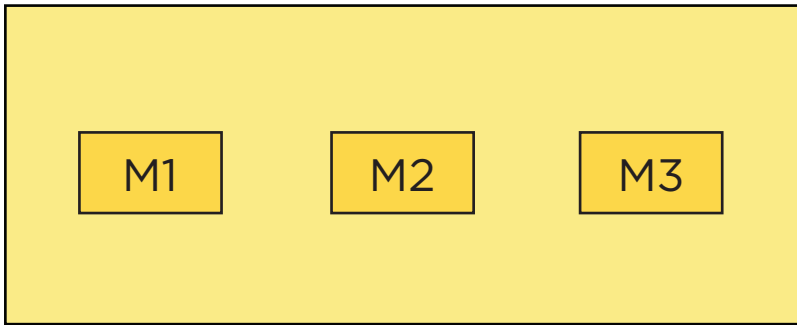

Oasis Mini A / Oasis Mini USB
(OAM-A-PC-4-1-_)
Includes 12" connecting cable to wire both sides of unit (shown as F/F cable on left).



Oasis Mini B
(OAM-B-PC-4-1-_)

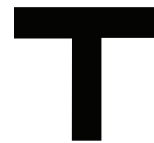

Daisy-T: Two Way Power Splitter
(Daisy-T)

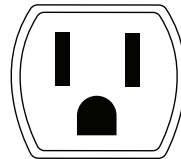

Power Source

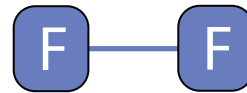

Female/Female
Interconnecting Cable
(42FF-XX)



Power Infeed Cable (42AP1-72 [3-prong
plug} or 42SB2-XX [multi-circuit hardwire])



Female/Male
Interconnecting Cable
(42FM-XX)

Conference Tables - Oasis Mini Daisy-Chain

Drawing 1A

(2) Oasis Mini A / Oasis Mini USB Power Troughs - one in M1, One in M3.

Power Infeed coming from either far left or far right of table.

NOTE: Larger sized tables may require two interconnecting cables (one F/F, One F/M). Please see cable chart for details.

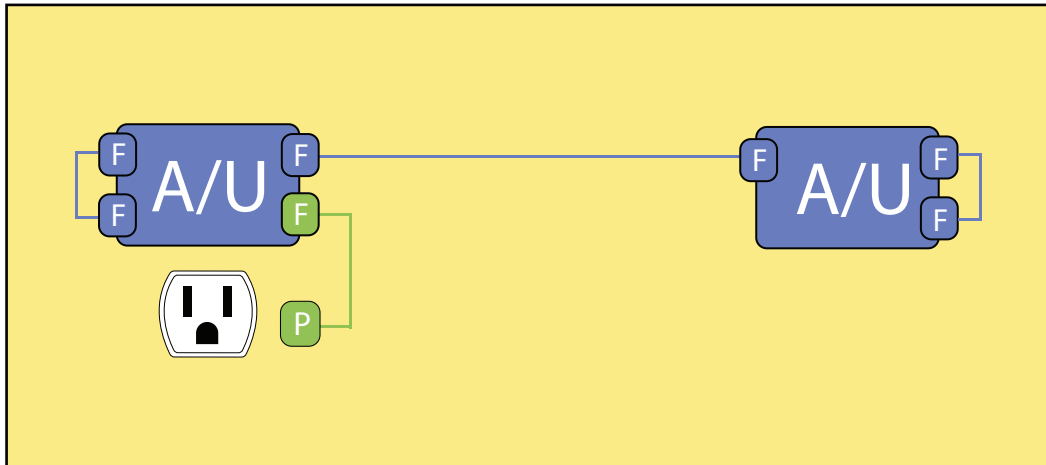

Power from Left

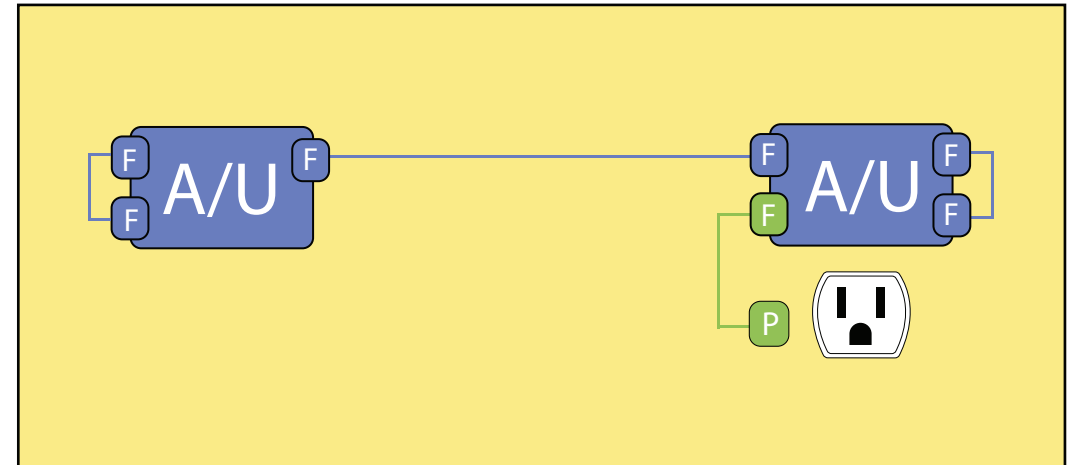

Power from Right

Conference Tables - Oasis Mini Daisy-Chain

DRAWING 1B

(2) Oasis Mini B Power Troughs - one in M1, One in M3.

Power Infeed coming from either far left or far right of table.

NOTE: Larger sized tables may require two interconnecting cables (one F/F, One F/M). Please see cable chart for details.

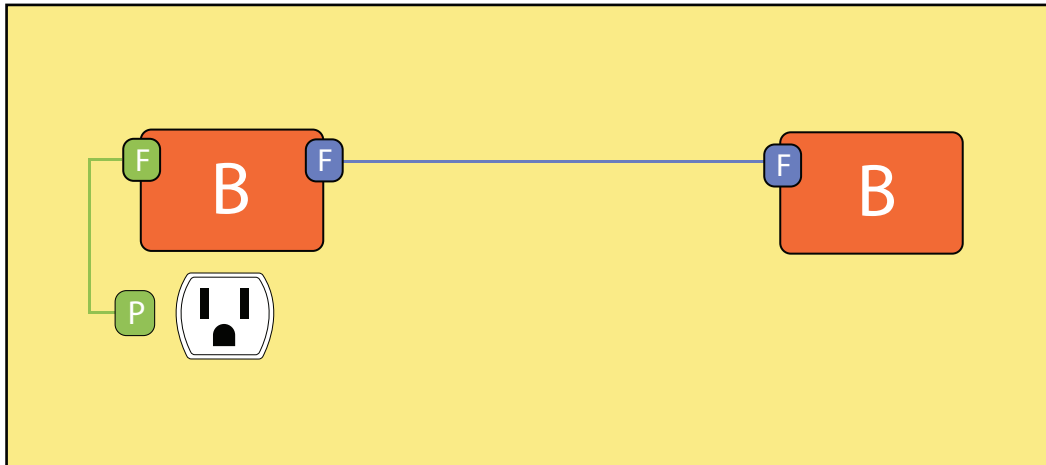

Power from Left

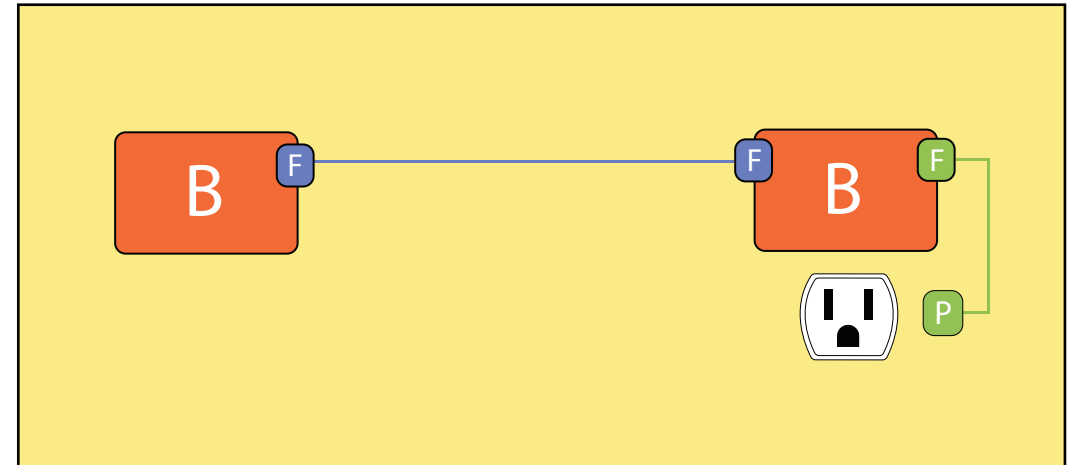

Power from Right

Conference Tables - Oasis Mini Daisy-Chain

DRAWING 2A

(2) Oasis Mini A / Oasis Mini USB Power Troughs - one in M1, One in M3.
Power Infeed coming from center position.

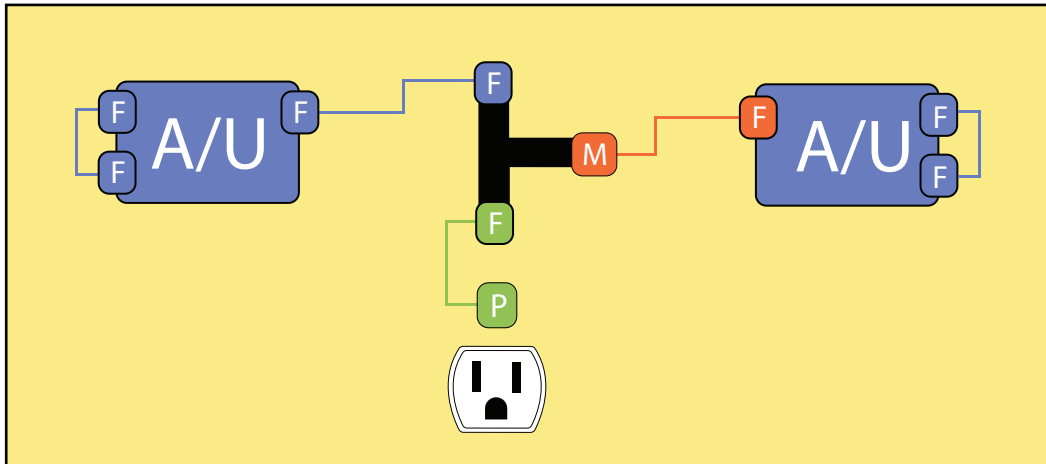

DRAWING 2B

(2) Oasis Mini B Power Troughs - one in M1, One in M3.
Power Infeed coming from center position.

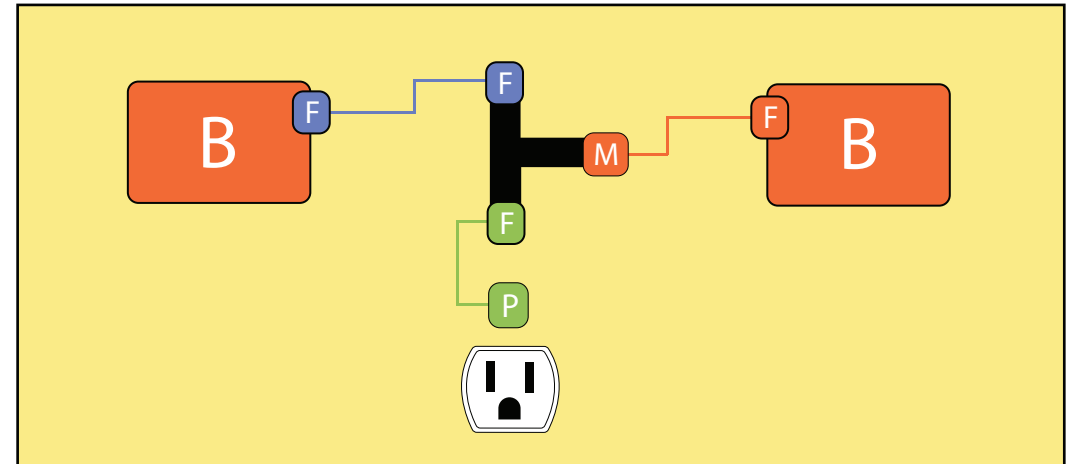

Conference Tables - Oasis Mini Daisy-Chain

DRAWING 3

(3) Oasis Mini A P / Oasis Mini USB Power Troughs - one each in M1, M2 and M3.

Power Infeed coming from either far left or far right of table.

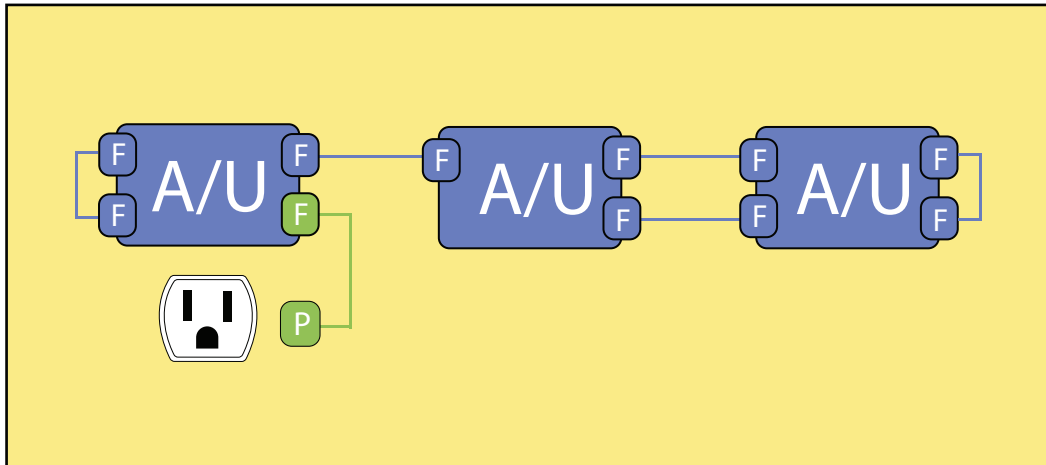

Power from Left

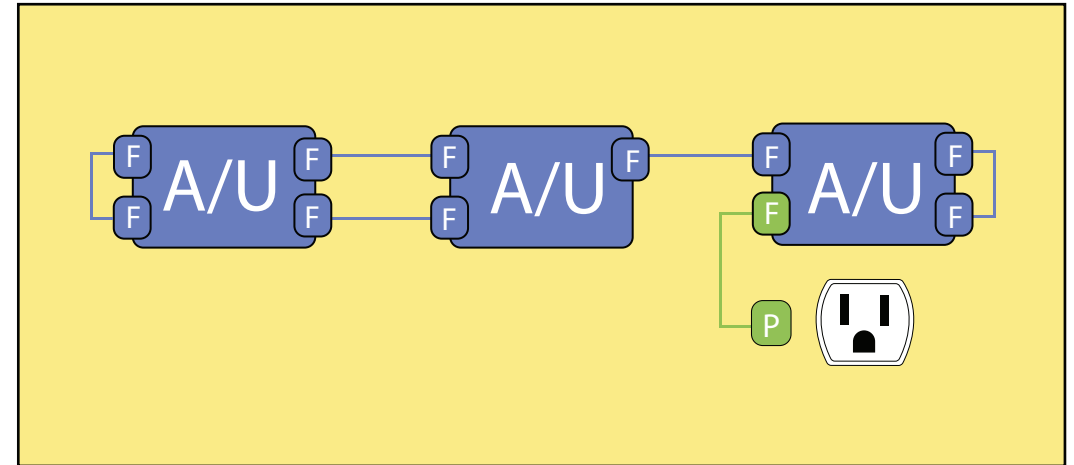

Power from Right

Conference Tables - Oasis Mini Daisy-Chain

DRAWING 4

(3) Oasis Mini A / Oasis Mini USB Power Troughs - one each in M1, M2 and M3.

Power Infeed coming from center position.

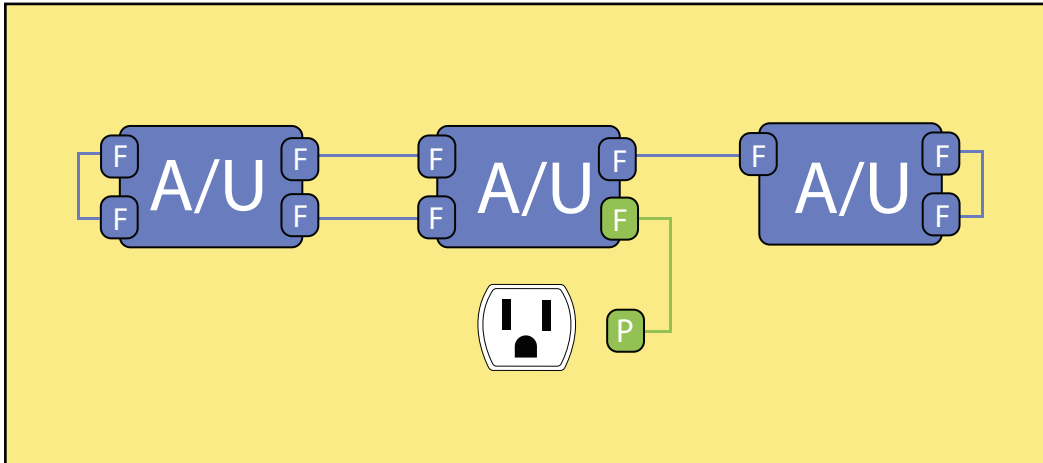

Conference Tables - Oasis Mini Daisy-Chain

DRAWING 5

(3) Oasis Mini B Power Troughs - one each in M1, M2 and M3.

Power Infeed coming from either far left or far right of table.

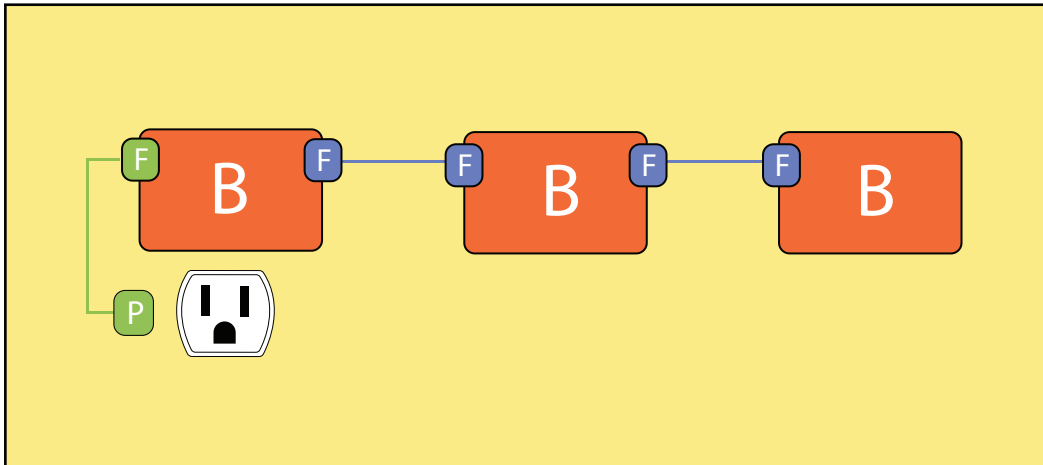

Power from Left

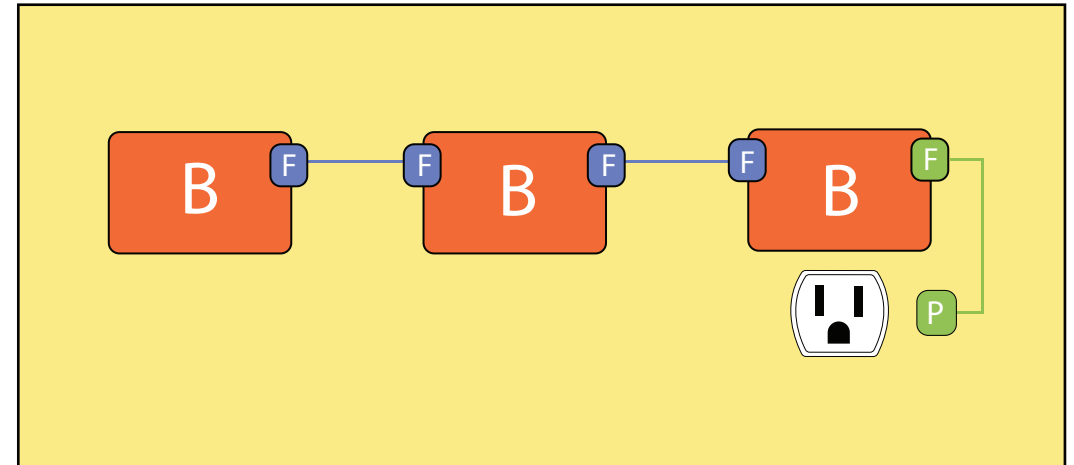

Power from Right

Conference Tables - Oasis Mini Daisy-Chain

DRAWING 6

(3) Oasis Mini A Power Troughs - one each in M1, M2 and M3.

Power Infeed coming from center position.

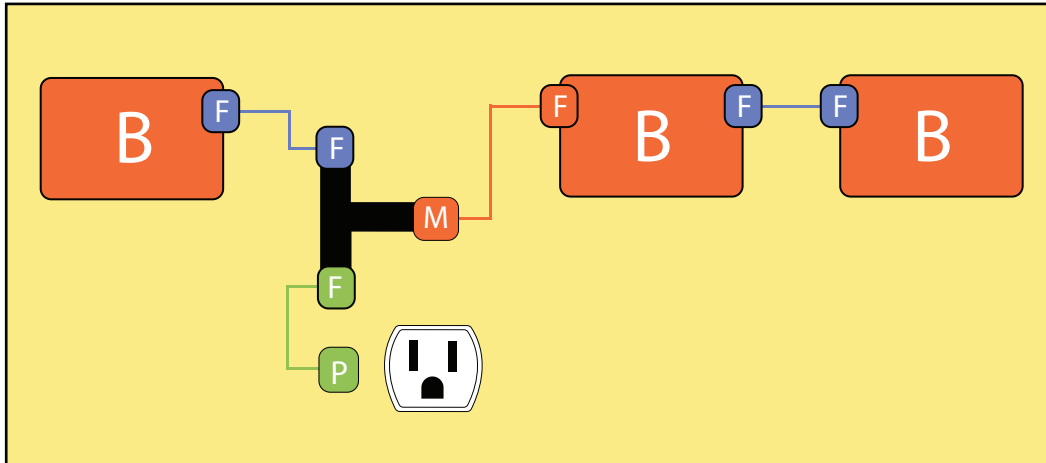



training tables

villa daisy-chain electrical guide

Training Tables - Villa Daisy-Chain

Example of cutout positions on a row of training tables. NOTE: Daisy-chain KITS for any other cutout or cutout combination must be quoted.

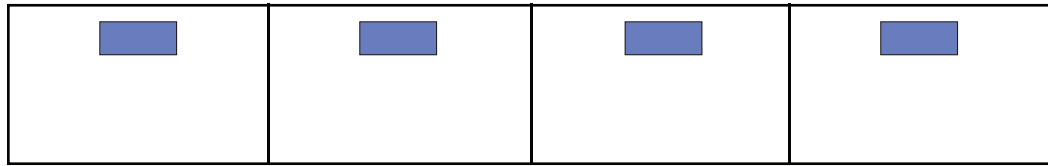

Tables with V2 position cutouts for VILLA SINGLE BLOCK power kits.
Cutouts must be specified on the table when using daisy-chain power kits.

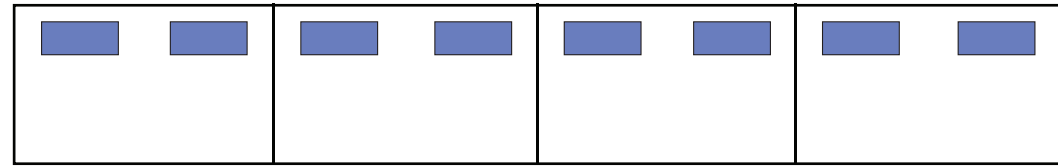

Tables with V1 & V3 position cutouts for VILLA DOUBLE BLOCK power kits.
Cutouts must be specified on the table when using daisy-chain power kits.



Villa Power Block
(Included as part of the daisy-chain kits.)



Power Source



Female/Female Interconnecting Cable
(Included as part of daisy-chain kit)

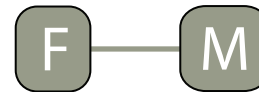

Female/Male Interconnecting Cable
(Included as part of daisy-chain kit)



Power Infeed Cable (42AP1-72 or 42SB2-XX)

Training Tables - Villa Daisy-Chain

Each Daisy-Chain VILLA DOUBLE BLOCK Power Kit comes with:

- 2 - Power Blocks (as illustrated)
- 2 - Grommet Covers (covers power block in worksurface - fits V1 & V3 cutout)
- 2 - Female/Female Interconnecting Cable (as illustrated)
- 1 - Female/Male Interconnecting Cable (as illustrated)
- 6 - Cable Clamps (not shown - keep interconnecting cables flush to the underside of the worksurface).

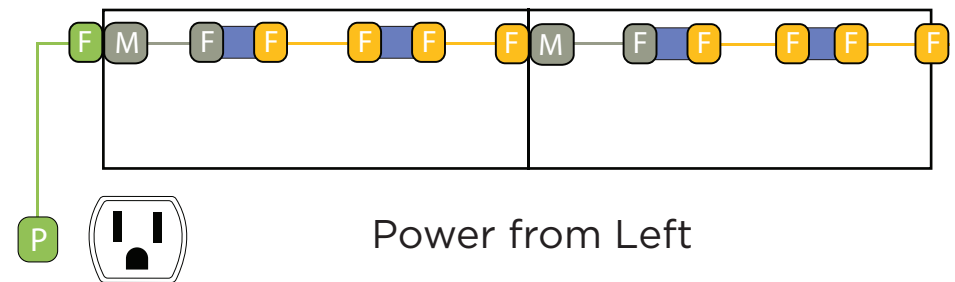
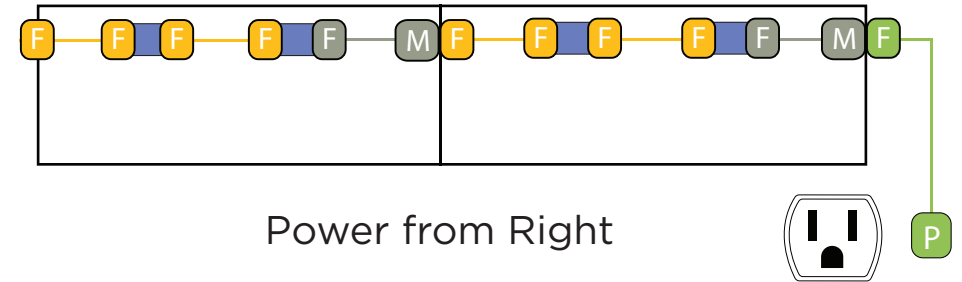
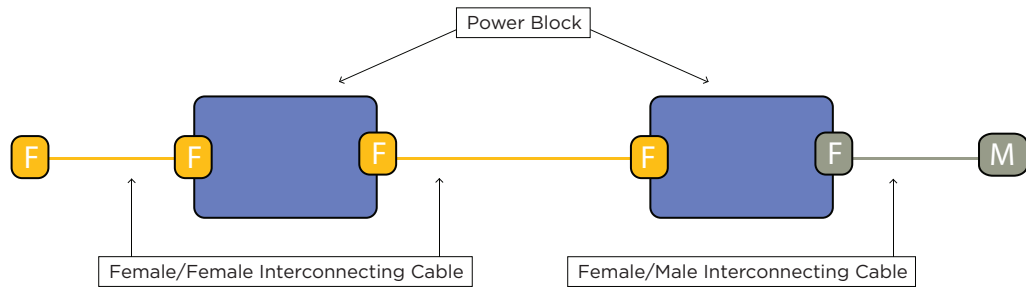



training tables

modpower daisy-chain electrical guide

Training Tables - Modpower Daisy-Chain

Example of cutout positions on a row of training tables.

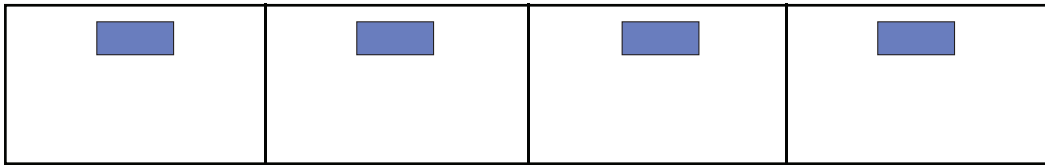

Tables with MPS position cutouts for MODPOWER IN-SURFACE daisy-chain kits. Cutouts must be specified on the table when MODPOWER IN-SURFACE daisy-chain kits.

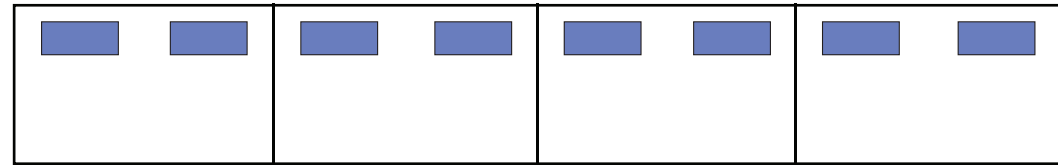

Tables with MPD position cutouts for MODPOWER IN-SURFACE daisy-chain kits. Cutouts must be specified on the table when MODPOWER IN-SURFACE daisy-chain kits.



ModPower Starter Unit - Includes a 10' cord with 3-prong plug on one side, 3' cord with universal connector on the other.



Power Source



ModPower Middle Unit - Includes a 3' cord with universal connector on each side.

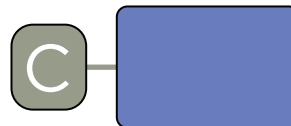

ModPower End Kit - Includes a 3' cord with universal connector on one side.

Training Tables - Modpower Daisy-Chain

Each MODPOWER Daisy-Chain Kit comes with:

1 - Power Block

- Starter units include (1) 10' Cord with 3-prong plug + (1) 3' cord with universal connector.
- Middle units include 3' cords with universal connectors on each side.
- End units include (1) 3' cord with universal connector on one side.

4 - Cable Clamps (not shown - keep interconnecting cables flush to the underside of the worksurface).

KITS ARE UNIVERSAL, INTENDED FOR ALL STANDARD TRAINING TABLE SIZES. EXCESS CABLES TO BE COILED UNDER THE SURFACE AS NECESSARY.

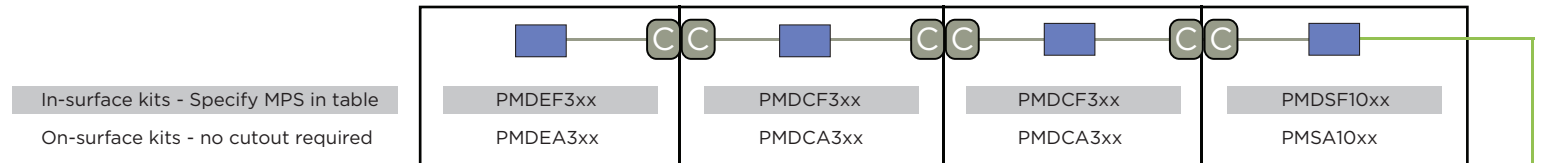

Power from Right

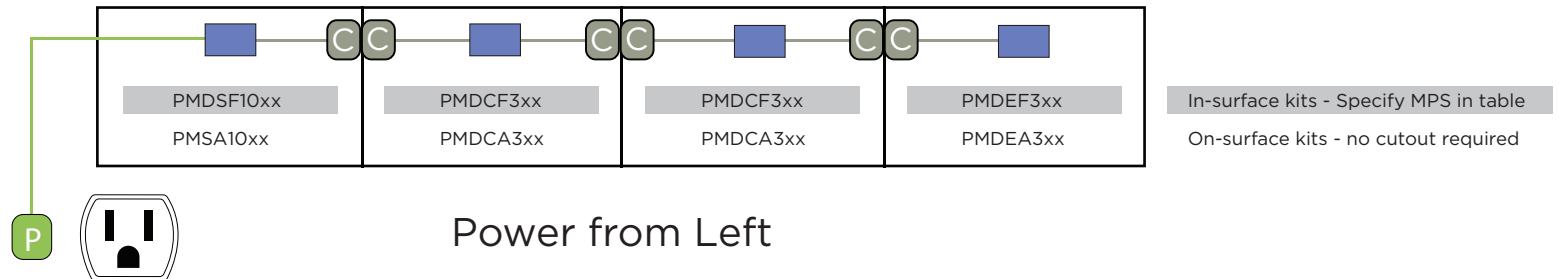

Power from Left

Training Tables - Modpower Daisy-Chain

Each MODPOWER Daisy-Chain Kit comes with:

- 1 - Power Block
 - Starter units include (1) 10' Cord with 3-prong plug + (1) 3' cord with universal connector.
 - Middle units include 3' cords with universal connectors on each side.
 - End units include (1) 3' cord with universal connector on one side.
- 4 - Cable Clamps (not shown - keep interconnecting cables flush to the underside of the worksurface).

KITS ARE UNIVERSAL, INTENDED FOR ALL STANDARD TRAINING TABLE SIZES. EXCESS CABLES TO BE COILED UNDER THE SURFACE AS NECESSARY.

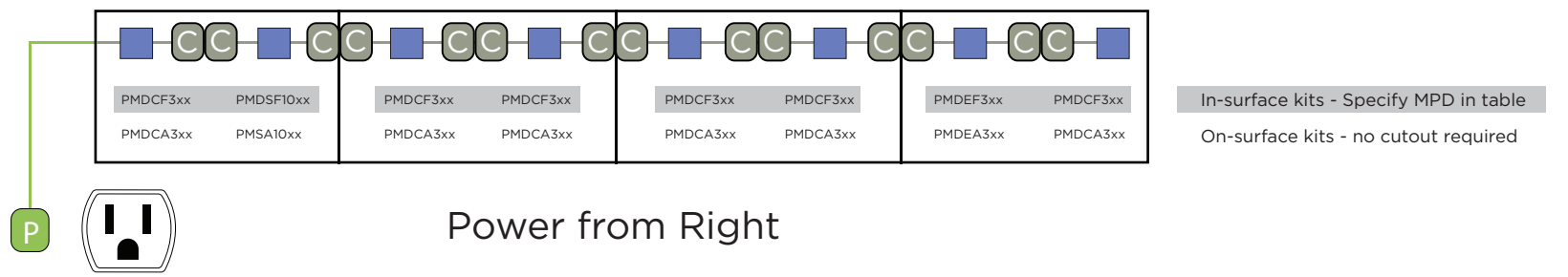
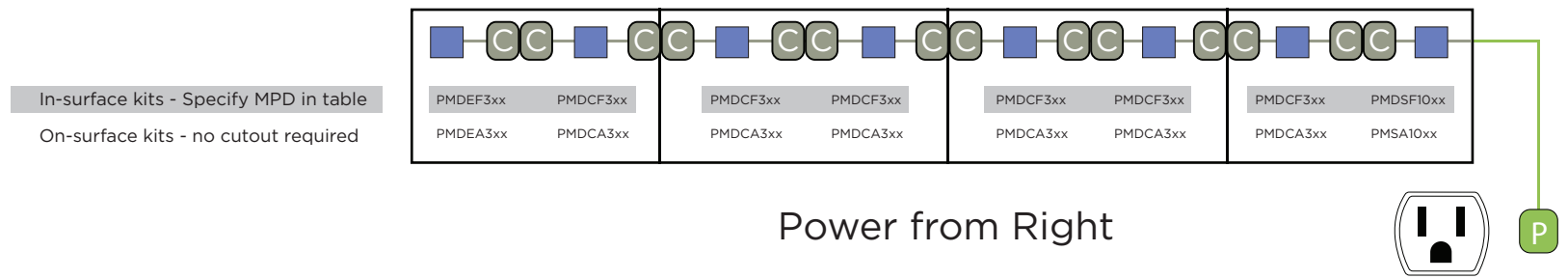

global
furniture
group

workplace
education
healthcare