



G7 monitor arms

Optimize your workspace



Small workspaces do not need to feel small, they just need to be more efficient. G7 monitor arms maximize workspace space while increasing productivity. Double jointed arms easily tilt, swivel and pan to reduce neck and eye strain to create the ultimate ergonomic workstation. Integrated wire management keeps cords out of the way, while freeing up valuable desk space.

Single and double monitor arms shown in Tungsten. Sora seating, Foli height adjustable tables and G series mobile pedestals shown.

A closer look

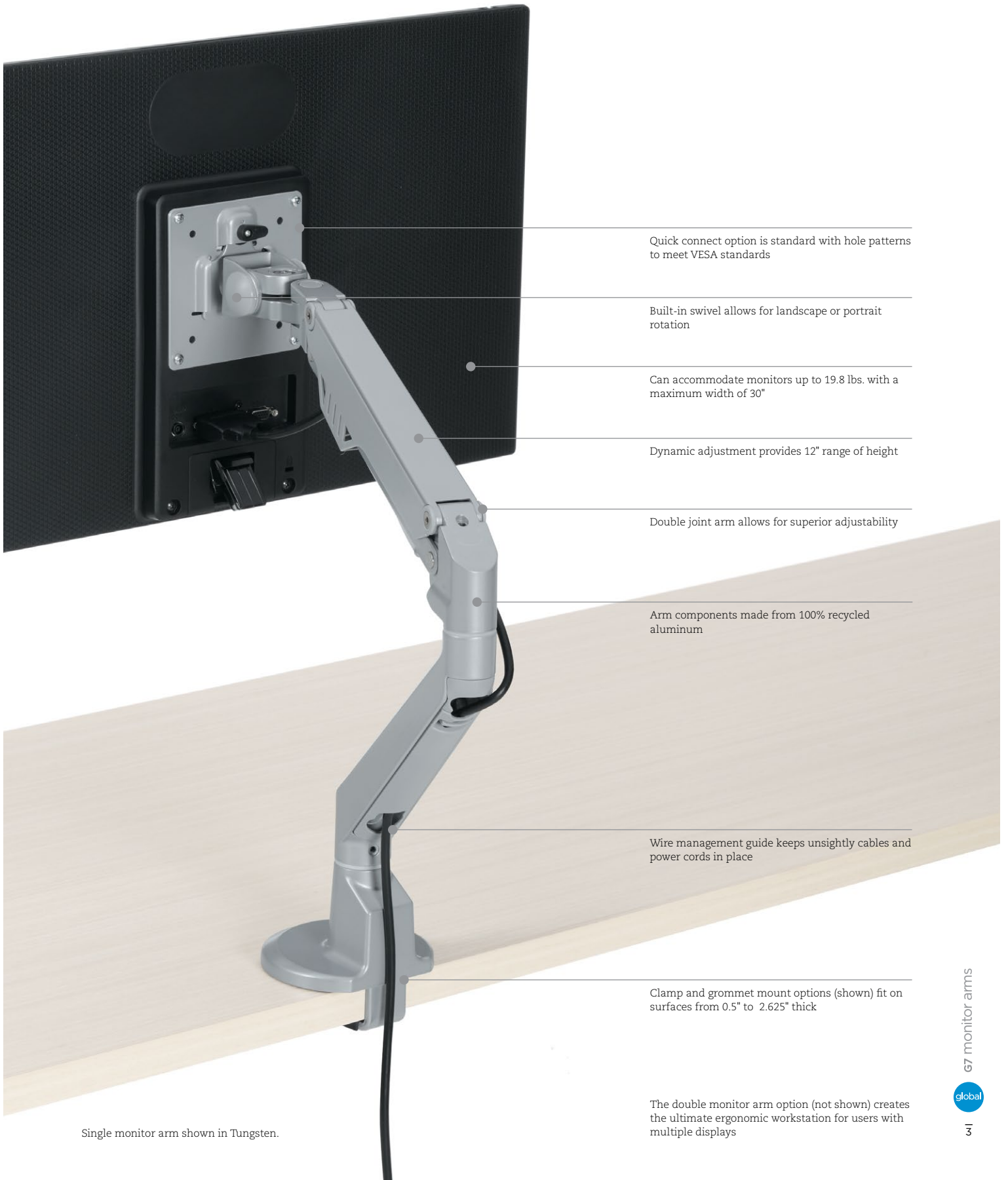

Quick connect option is standard with hole patterns to meet VESA standards

Built-in swivel allows for landscape or portrait rotation

Can accommodate monitors up to 19.8 lbs. with a maximum width of 30"

Dynamic adjustment provides 12" range of height

Double joint arm allows for superior adjustability

Arm components made from 100% recycled aluminum

Wire management guide keeps unsightly cables and power cords in place

Clamp and grommet mount options (shown) fit on surfaces from 0.5" to 2.625" thick

The double monitor arm option (not shown) creates the ultimate ergonomic workstation for users with multiple displays

Single monitor arm shown in Tungsten.

A range of motion

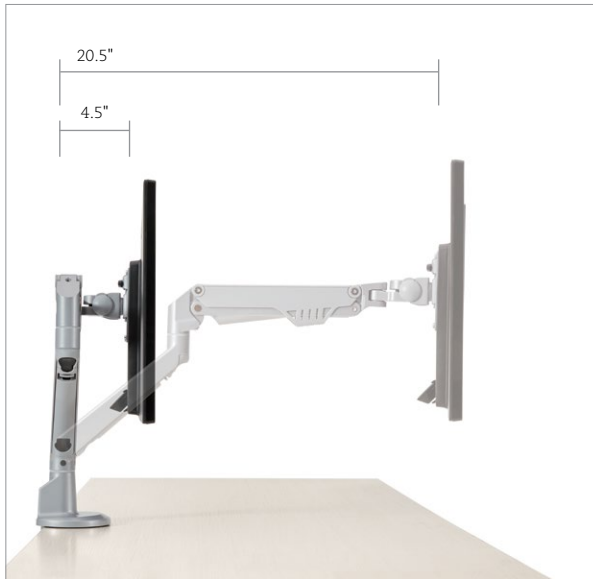

Monitor arm collapses to 4.5" and extends to 20.5" to the rear of monitor



Adjust the monitor height to suit your workstyle



Monitor tilts +90° to -45°



180-degree lockout feature

Additional information can be found on the Global [website](#).

It's in the details

Features



Single monitor arm (PSMA1)



Double monitor arm (PSMA2)



Quick disconnect plate



Wire management



Optional mini-slide (PSMS - sold separately) provides 9" of lateral adjustment when used in corners or tight spaces

Finishes



Tungsten

Mounts



Clamp mount



Grommet mount



Double monitor clamp mount



Double monitor grommet mount

Please visit globalfurnituregroup.com for additional product information including industry and environmental certifications.

Cover: Single monitor arm shown in Tungsten.



U.S.A.
Global Furniture Group
17 West Stow Road P.O. Box 562
Marlton New Jersey U.S.A. 08053
Tel (856) 596-2390 (800) 220-1900

Canada
Global Furniture Group
1350 Flint Rd., Toronto Ontario Canada M3J 2J7
Sales & Marketing: Tel (1-877) 446-2251

International
Global Furniture Group
560 Supertest Road, Toronto
Ontario Canada M3J 2M6
Tel (416) 661-3660 (800) 668-5870

Offices throughout Canada, United States, United Kingdom and Brazil. Distribution around the world. A member of Global Furniture Group. © 2023 ©™ Trademarks of Global Furniture Group. These products may be covered by one or more issued patents or pending patent applications in Canada, the U.S. and elsewhere. All intellectual property rights in applicable trademarks, patents and industrial designs are strictly reserved. Made in Canada. Specifications are correct at time of printing. Printed in Canada. Creative / Global Design Center 040423 22.0089